



**HAL**  
open science

# Limite hydrodynamique pour un dynamique sur réseau de particules actives

Clément Erignoux

► **To cite this version:**

Clément Erignoux. Limite hydrodynamique pour un dynamique sur réseau de particules actives. Physique mathématique [math-ph]. Université Paris Saclay (COmUE), 2016. Français. NNT : 2016SACLX011 . tel-01425633

**HAL Id: tel-01425633**

**<https://pastel.hal.science/tel-01425633>**

Submitted on 3 Jan 2017

**HAL** is a multi-disciplinary open access archive for the deposit and dissemination of scientific research documents, whether they are published or not. The documents may come from teaching and research institutions in France or abroad, or from public or private research centers.

L'archive ouverte pluridisciplinaire **HAL**, est destinée au dépôt et à la diffusion de documents scientifiques de niveau recherche, publiés ou non, émanant des établissements d'enseignement et de recherche français ou étrangers, des laboratoires publics ou privés.

NNT : 2016SACLX011



**THESE DE DOCTORAT  
DE L'UNIVERSITE PARIS-SACLAY**

préparée à

**L'ÉCOLE POLYTECHNIQUE**

ÉCOLE DOCTORALE N°574

Mathématiques Hadamard (EDMH)

Spécialité de doctorat : Mathématiques

par

**Mr. Clément ERIGNOUX**

**Limite Hydrodynamique pour un Gaz Sur Réseau de  
Particules Actives**

**Thèse présentée et soutenue à Palaiseau, le 04 Mai 2016**

**Composition du jury :**

ELLEN SAADA	(CNRS - MAP5, Université Paris Descartes)	Présidente du jury
CLAUDIO LANDIM	(IMPA - CNRS - Université de Rouen)	Rapporteur
STEFANO OLLA	(CEREMADE, Université Paris Dauphine)	Rapporteur
THIERRY BODINEAU	(CNRS - CMAP, École Polytechnique)	Directeur de thèse
GIAMBATTISTA GIACOMIN	(LPMA, Université Paris Diderot)	Examineur
SYLVIE MÉLÉARD	(CMAP, École Polytechnique)	Examinatrice
JULIEN TAILLEUR	(CNRS - MSC, Université Paris Diderot)	Examineur





---

*“It takes considerable knowledge just to realize the extent of your own ignorance.”*

**Thomas Sowell**, *A childish Letter*, 1998

---



# Remerciements

---

La première personne que je veux remercier est naturellement Thierry. Cette thèse vous doit énormément, et ces années de travail avec vous m'ont beaucoup appris que ce soit en probas ou en physique statistique. Je veux également vous remercier pour votre disponibilité, même dans vos périodes chargées, et pour le temps considérable que vous m'avez consacré, que ce soit pour travailler ensemble ou pour relire les nombreuses versions successives de cette difficile preuve non-gradient. Au-delà de ces aspects académiques, ce fut un grand plaisir de travailler avec vous, et j'ai beaucoup apprécié votre bonne humeur et votre optimisme, même dans les moments délicats qui n'ont pas manqué de rythmer cette thèse. J'espère que nous aurons à l'avenir de nombreuses occasions de collaborer et de parler de maths.

Je voudrais ensuite remercier Claudio Landim et Stefano Olla pour m'avoir fait l'honneur de rapporter mon manuscrit, dont leur lecture attentive, je le devine, n'a pas toujours été une partie de plaisir. Je souhaite en particulier remercier Claudio d'avoir écrit *Scaling limits*, qui a été mon livre de chevet pendant ces années de thèse. Sans ce support, dont j'ai au cours de ma thèse fini par étudier la majorité des chapitres, mon travail aurait été infiniment plus difficile.

Merci également à tous les membres du jury, en particulier Ellen Saada pour son organisation ininterrompue de séminaires et conférences, auxquels ma culture scientifique actuelle, bien qu'encore lacunaire, doit beaucoup, et à Julien pour les séances de travail qui nous ont permis de mieux comprendre le riche univers de la matière active.

Je veux aussi remercier les héroïnes méconnues de toute thèse réussie, Bénédicte et Zaina au DMA et Nasséra, Alex et Mano au CMAP, pour m'avoir guidé, et, soyons honnête, par moments porté à bout de bras, dans les méandres administratifs de la vie de labo et du doctorat.

Au cours de mon passage au DMA et au CMAP, j'ai eu le plaisir de rencontrer un grand nombre de doctorant-e-s. Je voudrais donc également remercier tout-e-s ceux et celles que j'ai pu rencontrer au cours de ces années de thèse : I.K, l'organisateur infatigable de bodégas, C.A. ma camarade de découragement passager, ainsi que mes autres amis du DMA, I.G, B.M, L.D, J.D, M.G, pour les soirées partagées, et pour leur tolérances vis à vis de mes exigences thermales<sup>1</sup>. Je voudrais également remercier ma grande sœur académique, O.B. pour n'avoir pas rigolé la 75ème fois que je lui ai dit, dépité, "on a un problème avec la preuve...", ainsi qu'É.A. et tous mes autres camarades du CMAP et du séminaire 2.0. Puisse cette nouvelle tradition connaître de nombreuses années de succès.

Merci également à tout-e-s les chercheur-e-s avec qui j'ai pu échanger dans ces dernières années, en particulier à M.S. pour m'avoir permis de mieux comprendre la méthode non-gradient, et pour m'avoir aidé à chaque occasion qu'elle a eu, et P.I. pour notre longue discussion à l'interface maths-physique.

J'ai eu la chance de faire mon monitorat dans un cadre exceptionnel, et je voudrais donc remercier F.B. pour avoir fait en sorte que mes enseignements me demandent le moins de temps possible, et se passent dans les meilleures conditions, malgré le chaos (relatif tout de même) de la jeune formation de PSL\*.

---

<sup>1</sup>On ne m'ôtera pas de l'idée qu'il est parfaitement naturel de travailler avec la fenêtre grand ouverte fin janvier.

Ces années de thèse n'ont évidemment pas été déterminées que par la vie de labo<sup>2</sup> et mes enseignements. Je veux remercier mes collocs successifs, R.R-A d'abord, avec qui nous avons initié la vie à Saint-Marcel, E.S. ensuite, pour avoir réussi à me supporter pendant la majeure partie de ces trois dernières années, et L.O. enfin, pour s'être aimablement assurée que je prenne 45 kilos dans les deux mois précédant ma soutenance. Je me dois également de remercier mon DRAEA<sup>3</sup> M.B, pour tous les moments partagés, que ce soit sur LOL, WH, Vaux, Ibiza, ainsi que M.B. pour avoir été remarquablement tolérante vis-à-vis mon intrusion récurrente à Montrouge. Merci également à tous les membres de la Triade qui m'ont accompagné pendant ces années, A.R. pour avoir contribué à me rendre un peu moins nul en physique<sup>4</sup>, ainsi que L.R, M.G, et A.P., et enfin C.M-L. pour l'infatigable organisation de vacances, de séances oeno et de soirées. Merci de m'avoir soutenu dans les moments difficiles, et d'avoir partagé avec moi tant des bons moments de ces six dernières années.

J'ai également beaucoup apprécié durant ces années la compagnie de la promo Bio11, en particulier V.M-P, M.M, A.G, X.A. et leur enthousiasme dans l'interprétation de mon sujet de thèse, qui m'a beaucoup donné à réfléchir<sup>5</sup>, O.P.L.F, J.A. et ses *blafes*, ainsi que tout le groupe du B6 et tous les amis rencontrés pendant ma scolarité à l'ENS. Merci également à tout mon groupe d'amis de MPSII, pour les retrouvailles régulières, que ce soit au Moulin, à Porspoder, ou tout simplement autour d'un verre à Paris. Bien que le groupe se soit éclaté un peu partout à travers le monde, il n'est finalement jamais vraiment très loin. Merci également à tous mes compères de la *JoPo<sup>TM</sup>*, et M.I. pour les heures nombreuses et intenses passées ensemble<sup>6</sup>.

Je voudrais aussi remercier toute la famille Berthet-Pons, et en particulier B. et E-M, C. et V. pour m'avoir chaleureusement accueilli en de multiples occasions à Vaux, pour m'avoir intégré au Cochon, et fait découvrir les nombreux plaisirs du pays Beaujolais<sup>7</sup>. J'ai passé en votre compagnie nombre d'excellents moments, et j'ose espérer qu'il y en aura encore beaucoup d'autres.

Enfin, je voudrais me saisir de cette occasion pour remercier toute ma famille, en particulier mon frère Laurent et son énergie inépuisable<sup>8</sup>, et surtout mes parents. Merci de tout ce que vous avez fait, et faites encore, pour moi. Merci de m'avoir soutenu, inconditionnellement, toutes ces années, et d'avoir fait tous les efforts et sacrifices nécessaires pour que j'aie la vie et fasse les études qui me plaisent. Si aujourd'hui je poursuis cette voie qui me passionne, c'est en grande partie grâce à vous.

---

<sup>2</sup>“Polytechnique, c'est loin.” *Proverbe parisien*.

<sup>3</sup>*Directeur Régional des Activités Extra-Académiques*

<sup>4</sup>Soyons sérieux toutefois, le Hamiltonien est une énergie !

<sup>5</sup>Cf. Avant-Propos.

<sup>6</sup>IRL et IVL, évidemment.

<sup>7</sup>Contre toute attente, parmi ces plaisirs, je mettrais aussi le VTT dans les cailloux ! Rester en vie, c'est très surfait.

<sup>8</sup>Littéralement inépuisable...

# Avant-propos

---

En dépit de la liberté considérable que confère le statut de doctorant en mathématiques, je n'ai jusqu'ici pas eu le temps d'accorder le temps mérité aux nombreuses pistes de recherche ichtyologiques<sup>9</sup> que m'ont proposé mes proches ces dernières années. Je veux donc, dans ces quelques lignes, partager mes réflexions sur certaines de ces fascinantes perspectives de recherche<sup>10</sup>. Dans ce qui suit, nous utiliserons l'abréviation usuelle *PP* pour *Poissons Ponctuels*.

La principale question ouverte, le lecteur habitué de physique statistique l'aura probablement devinée, est la suivante : quelle est l'influence du RedBull sur les poissons ponctuels ? Afin de bien mettre en perspective les enjeux de ce singulier problème, je me permets donc un bref rappel historique.

En 1938, S. Hady & F. Raud publient un article pionnier, paru dans le renommé *IJAN*<sup>11</sup> dans lequel ils montrent de manière concluante que RedBull donne des ailes [HR38]. Bien que leur protocole expérimental ait été marginalement<sup>12</sup> critiqué par une partie de la communauté scientifique (leur hypothèse était testée exclusivement sur des oiseaux, parmi lesquels les ailes pouvaient être considérées comme des affections préexistantes), cet article a engendré un véritable ras-de-marée scientifique. Il n'était que naturel que dans ce ras-de-marée, on trouve quelques poissons, et la question de l'influence du RedBull sur les poissons s'est ainsi naturellement imposée<sup>13</sup>.

Cette avancée spectaculaire est restée inégalée, jusqu'en 2011, F. Ishy et al. réussirent à reproduire avec succès les résultats de S. Hady & F. Raud pour le poisson *Exocoetidae*, [ISYN11] (*Exocet*, de son appellation courante). La société RedBull n'a dès lors pas caché son enthousiasme, et partagé les conclusions de ces fascinantes études dans une longue campagne journalistico-publicitaire, qui a contribué à offrir à ce sujet à la fois polémique et fondamental une place privilégiée dans l'imaginaire scientifique du grand public.

D'un point de vue plus théorique, toutefois, l'influence du RedBull sur les poissons reste un mystère complet, qui a éludé la communauté de modélisation depuis une dizaine d'années, et c'est donc une question que se pose naturellement pour les PP. En particulier, soumettre les PP étudiés dans cette thèse à un régime de RedBull fait apparaître dans notre modèle un facteur 2 dans le coefficient de diffusion  $\delta$ , parce que les poissons vont plus vite. En dépit de ce début de piste prometteur, la preuve d'une excroissance alaire comme conséquence de la consommation régulière de RedBull reste à ce jour, dans le cas général, tristement hors de portée de l'état actuel de la recherche en biologie et en physique mathématique.

La seconde question m'ayant été soumise et qui mérite d'être abordée est la suivante : que font les PP une fois arrivés au bout du RER ? En fait, ce problème est mal posé, pour la raison suivante. En étant d'une nature extrêmement optimiste, on peut considérer le RER B est un phénomène périodique en temps. Toutefois, il n'est absolument pas périodique en espace ! Prouvons cette dernière assertion par l'absurde : dans le cas contraire, Saint-Rémi-Lès-Chevreuses se trouverait

---

<sup>9</sup>L'ichtyologie, est-il besoin de le rappeler, est l'étude des poissons.

<sup>10</sup>Je n'ai absolument pas inventé ces questions, elles m'ont bel et bien été posées par des personnes qui se reconnaîtront.

<sup>11</sup>*International Journal of Applied Nonsense*

<sup>12</sup>A.R., C.M-L, ça c'est cadeau.

<sup>13</sup>Note de l'auteur : j'hésitais entre mathématicien ou scénariste. Je suspecte que j'ai fait le bon choix.



en plein milieu de l'aéroport Charles-De-Gaulle, ses résidents ne pourraient ainsi ramener chez eux du shampoing et du jus de pomme que par bouteilles scellées de 100mL, et ne pourraient posséder de ciseaux. Les enfants ne pourraient donc ni organiser de goûters, ni faire de découpage, seraient dramatiquement malheureux, et seraient partis en temps fini. Saint-Rémi-Lès-Chevreuses, par manque d'habitants, aurait donc disparu en temps  $\varepsilon$ . CQFD<sup>14</sup>. Il faut là encore souligner, toutefois, que ce résultat n'est vrai que sous la grossière approximation selon laquelle le RER serait périodique en temps, hypothèse mise en défaut au moindre colis piégé/accident de personne/grève/quelqu'un a volé tous les rails entre gare du Nord et Robinson<sup>15</sup>. Quoi qu'il en soit, aucun couplage n'est donc possible, entre PP et RER, puisque les premiers évoluent périodiquement en espace et pas en temps, et le second en temps et pas en espace.

On m'a également proposé de prendre en compte l'influence de forces de frictions sur les PP, mais ce n'est évidemment pas une piste de recherche sérieuse : les poissons étant ponctuels, on ne peut raisonnablement pas attendre qu'une force de friction les affecte. Je suis à ce jour convaincu que cette dernière piste m'avait été proposée comme une blague.

Je n'ai finalement pas jugé utile d'aborder ici des questions plus terre-à-terre, qui pourtant m'ont été régulièrement posées : comment nourrir ses poissons ponctuels ? Comment se reproduisent les poissons ponctuels ? Le présent manuscrit se veut être une œuvre scientifiques, et des questions d'une nature aussi triviales ne sauraient y trouver leur place.

---

<sup>14</sup>On préférera cette démonstration astucieuse à la preuve historique, qui fait 160 pages.

<sup>15</sup>Celui-là, je ne l'ai encore jamais rencontré, mais ça ne saurait tarder.





# Résumé

L'étude des dynamiques collectives, observables chez de nombreuses espèces animales, a motivé dans les dernières décennies un champ de recherche actif et transdisciplinaire. De tels comportements sont souvent modélisés par de la matière active, c'est-à-dire par des modèles dans lesquels chaque individu est caractérisé par une vitesse propre qui tend à s'aligner avec celle de ses voisins.

Dans un modèle fondateur proposé par Vicsek & al., ainsi que dans de nombreux modèles de matière active liés à ce dernier, une transition de phase entre un comportement chaotique à forte température, et un comportement global et cohérent à faible température, a été observée. De nombreuses preuves numériques de telles transitions de phase ont été obtenues dans le cadre des dynamiques collectives. D'un point de vue mathématique, toutefois, ces systèmes actifs sont encore mal compris. Plusieurs résultats ont été obtenus récemment sous une approximation de champ moyen, mais il n'y a encore à ce jour que peu d'études mathématiques de modèles actifs faisant intervenir des interactions purement microscopiques.

Dans ce manuscrit, nous décrivons un système de particules actives sur réseau interagissant localement pour aligner leurs vitesses. L'objet de cette thèse est l'obtention rigoureuse, à l'aide du formalisme des limites hydrodynamiques pour les gaz sur réseau, de la limite macroscopique de ce système hors-équilibre, qui pose de nombreuses difficultés techniques et théoriques.

# Abstract

Collective dynamics can be observed among many animal species, and have given rise in the last decades to an active and interdisciplinary field of study. Such behaviors are usually modeled by active matter, in which each individual is self-driven and tends to align its velocity with that of its neighbors.

In a classical model introduced by Vicsek & al., as well as in numerous related active matter models, a phase transition between chaotic behavior at high temperature and global order at low temperature can be observed. Even though ample evidence of these phase transitions has been obtained for collective dynamics, from a mathematical standpoint, such active systems are not fully understood yet. Some progress has been achieved in the recent years under an assumption of mean-field interactions, however to this day, few rigorous results have been obtained for models involving purely local interactions.

In this manuscript, we describe a lattice active particle system interacting locally to align their velocities. This thesis aims at rigorously obtaining, using the formalism developed for hydrodynamic limits of lattice gases, the scaling limit of this out-of-equilibrium system, for which numerous technical and theoretical difficulties arise.



# Sommaire

---

<b>INTRODUCTION</b>	<b>14</b>
i. Comportements collectifs en Biologie . . . . .	14
ii. Modélisation microscopique de l'auto-organisation : modèles de matière active . . . . .	15
iii. Limites hydrodynamiques des systèmes non-gradients . . . . .	18
iv. Gaz sur réseau multi-types et contribution du manuscrit . . . . .	21
v. Résumé de la thèse . . . . .	23
vi. Perspectives de recherche . . . . .	28
vii. Structure de la preuve . . . . .	30
<b>THE ACTIVE EXCLUSION PROCESS</b>	<b>32</b>
<b>1 Notations and Main theorem</b>	<b>32</b>
1.1 Main notations and introduction of the Markov generator . . . . .	32
1.2 Measures associated to a smooth profile and definition of the Markov process . . . . .	34
1.3 Hydrodynamic limit . . . . .	36
1.4 Instantaneous currents and outline of the proof . . . . .	38
<b>2 Canonical measures, entropy and irreducibility</b>	<b>42</b>
2.1 Definition of the canonical measures . . . . .	42
2.2 Entropy production and local equilibrium . . . . .	44
2.3 Irreducibility and control on full clusters . . . . .	49
<b>3 Law of large number for the spin process</b>	<b>61</b>
3.1 Replacement Lemma . . . . .	61
3.2 Proof of the replacement Lemma . . . . .	62
3.3 Proof of Lemma 3.3 : The one-block estimate . . . . .	65
3.4 Proof of Lemma 3.4 : The two-block estimate . . . . .	70
<b>4 Preliminaries to the non-gradient method</b>	<b>73</b>
4.1 An integration by parts formula in the context of particle systems . . . . .	73
4.2 Spectral gap for the symmetric exclusion spin process . . . . .	76
4.3 Comparison with an equilibrium measure . . . . .	82
4.4 Relative compactness of the sequence $(Q_N)_{N \in \mathbb{N}}$ . . . . .	85
4.5 Regularity of the density and energy estimate . . . . .	91
<b>5 Non-gradient estimates</b>	<b>99</b>
5.1 Replacement of the symmetric current by a macroscopic gradient . . . . .	99
5.2 Replacement of the currents and $\mathcal{L}f$ by their local average . . . . .	102
5.3 Estimation of the gradients on full clusters . . . . .	103
5.4 Replacement of the macroscopic gradients by their local counterparts . . . . .	109
5.5 Projection on non-full sets and reduction to a variance problem . . . . .	115

5.6	Discrete differential forms in the context of particles systems	120
5.7	Space-time covariance limit	141
5.8	Diffusion and drift coefficients	147
5.9	Drift part of the hydrodynamic limit	166
<b>6</b>	<b>Proof of the hydrodynamic limit</b>	<b>172</b>
	<b>APPENDIX</b>	<b>181</b>
<b>A</b>	<b>General tools</b>	<b>181</b>
A.1	Topological setup	181
A.2	Self-diffusion coefficient	182
A.3	Entropy	183
A.4	Bound on the largest eigenvalue of a perturbed Markov generator	184
A.5	Configurations with one empty site	184
<b>B</b>	<b>Space of parameters <math>\mathcal{M}_1(\mathbb{S})</math></b>	<b>186</b>
B.1	Equivalence of ensembles	186
B.2	Dependency of the grand canonical measures $\mu_{\hat{\alpha}}$ in $\hat{\alpha}$	187
B.3	Compactness $(\mathcal{M}_1(\mathbb{S}), \ \cdot\ )$	188
<b>C</b>	<b>Proof of Theorem 5.25 : Limiting space-time covariance</b>	<b>190</b>
	<b>Notations glossary</b>	<b>199</b>
	<b>References</b>	<b>201</b>

---

---

# INTRODUCTION

---

---

## i. Comportements collectifs en Biologie

Cette thèse a pour objet l'étude de la limite d'échelle d'un système microscopique inspiré des nombreux modèles de dynamiques collectives issus de la Biologie.

Les comportements cohérents sont très répandus dans la nature, et ont motivé depuis quelques décennies un champs de recherche très actif et transdisciplinaire [PE99]. Ce type de comportement de groupe se retrouve à de nombreuses échelles du vivant et dans tous les milieux (e.g. poissons [Sha78], criquets [Uva66], colonies de bactéries [GKPCA07]). Les regroupements animaliers doivent de manière générale trouver un équilibre entre les bénéfices du comportement collectif (défense contre la prédation, protection des jeunes individus, augmentation de la vigilance), et les inconvénients des groupes larges (difficultés à trouver de la nourriture, multiplication des prédateurs, etc.).

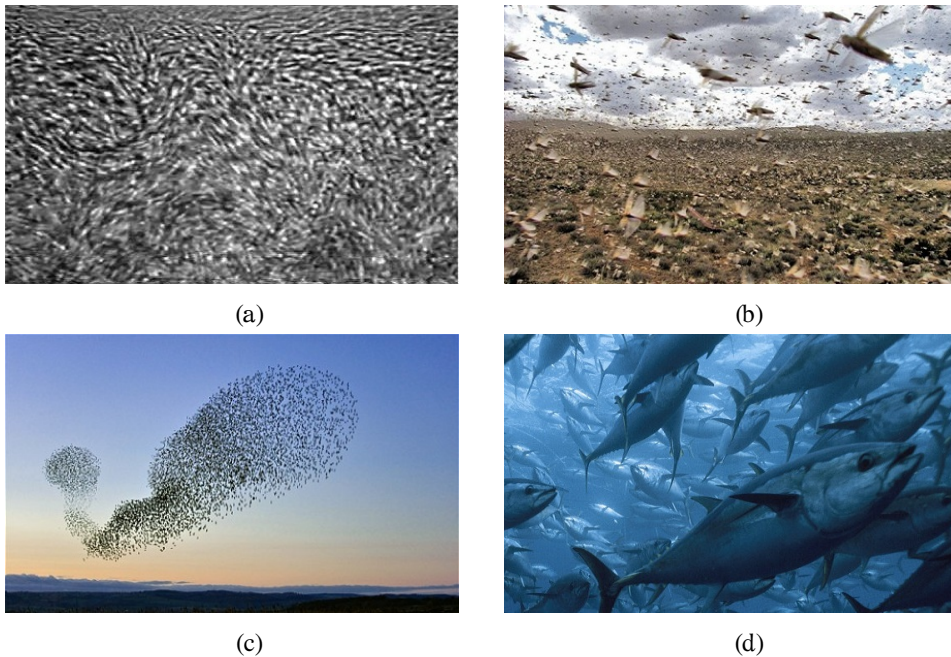

Figure 1: Comportement collectif observé pour des bactéries (a), criquets (b), étourneaux (c) et thons (d).

Malgré des modes d'interaction très variés entre les individus, tous ces phénomènes d'auto-organisation exhibent des variations de densité pouvant conduire à des transitions de phases. Cette similarité suggère une certaine universalité des modèles de dynamiques collectives [GC04]. Si les raisons du comportement cohérent sont pour la plupart bien connues des biologistes, les mécanismes macroscopiques et microscopiques en jeu sont toutefois encore mal compris, et ont



motivé de nombreux modèles d'aggrégation.

Ces modèles peuvent être construits suivant deux approches : la première spécifie l'équation différentielle vérifiée par la densité moyenne locale d'individus, ce qui permet une étude analytique du comportement grâce aux nombreux outils développés pour les équations aux dérivées partielles (de nombreux exemples en sont donnés notamment dans le livre de Okubo et Levin, [OL01]). Étant donné qu'elle représente un comportement moyen des individus, cette approche des dynamiques collectives est toutefois principalement adaptée aux systèmes comprenant un grand nombre d'individus, car elle ne prend pas en compte les fluctuations autour de la moyenne que subissent les systèmes de taille relativement faible.

La seconde approche, des *modèles individu-centrés* (IBM) décrit les équations du mouvement de chaque organisme. Toutefois, une description biologiquement réaliste du comportement de chaque individu rend l'étude théorique de tels modèles extrêmement difficile. Il est donc généralement choisi de simplifier le mouvement de chaque individu ainsi que son interaction avec le groupe. Une approximation classique est par exemple de faire se déplacer les individus sur un réseau, et de représenter leur mouvement par une marche aléatoire. La relative simplicité de tels modèles permet souvent d'obtenir des résultats exacts, au détriment toutefois de leur pertinence biologique.

Nous construisons dans cette thèse un lien entre ces deux approches, en partant d'une dynamique microscopique d'individus sur un réseau, puis en en déduisant les équations macroscopiques qui régissent les densités du système.

## ii. Modélisation microscopique de l'auto-organisation : modèles de matière active

Afin de représenter la direction du mouvement des individus ainsi que les contraintes spatiales (e.g. volume des individus) qui leur sont imposées, les dynamiques collectives sont très souvent modélisées par des modèles individu-centrés de *matière active*. L'expression *matière active* désigne des modèles maintenus hors équilibre par un flux d'énergie au niveau de chaque particule. Contrairement au cas d'un champ extérieur, dans les modèles à matière active, l'énergie apportée aux individus se traduit essentiellement comme un nouveau degré de liberté pour chaque particule. Les modèles à matière active présentent une grande variété de comportements, mais dans le contexte des modèles d'auto-organisation, deux phénomènes prennent une importance particulière.

- Pour des systèmes pour lesquels l'énergie apportée aux particules leur permet de s'aligner les unes aux autres, on observe une transition entre ordre et désordre en fonction de la force de l'alignement. Cette transition a d'abord été observée dans un modèle fondateur de dynamique collective, le *modèle de Vicsek*.
- Lorsque l'énergie apportée aux particules dépend de la densité locale, on observe des effets de congestion : les particules passent plus de temps dans les domaines où elles vont moins vite et ont donc tendance à s'y accumuler.

### Modèle de Vicsek et transition de phase dans les dynamiques d'alignement

Les phénomènes d'auto-organisation ont connu un essor considérable en physique statistique, où la richesse de tels comportements offre de nombreuses perspectives de modélisation, et pose de nouvelles questions sur les systèmes hors équilibre. Un grand nombre de modèles stochastiques ont été spécifiquement proposés afin de représenter certains comportements biologiques en utilisant des méthodes de physique statistique, (e.g. modèle d'Aoki-Couzin pour les bancs de poissons [Aok82], modèle de Hughes pour les piétons [Hug02]) et ont révélé une transition entre un comportement collectif à haute densité et un comportement très local à basse densité.

Le modèle considéré dans cette thèse est inspiré d'un modèle classique d'alignement introduit en 1995 par Vicsek et al. Ils proposent dans [VCB+95] un IBM (cf. paragraphe précédent) très général pour modéliser les dynamiques collectives. Ce modèle comprend un grand nombre de particules qui évoluent en temps discret, et à chaque pas de temps, adoptent comme direction de leur mouvement la moyenne des directions des particules dans un petit voisinage. La direction subit également un bruit qui rend la dynamique stochastique.

Malgré sa relative simplicité, le modèle original proposé dans [VCB+95] est extrêmement riche, et a généré une vaste littérature (cf. la review de Vicsek et Zafeiris, [VZ12]). Les premiers travaux sur ce modèle ont révélé une transition de phase du système lorsque le niveau de bruit passe un seuil critique dépendant de la densité de particules (cf. Figure 2). En dessous de ce seuil, on peut effectivement observer un mouvement cohérent de "paquets" de particules. De nombreuses extensions en ont été proposées, notamment à travers une dynamique à temps continue plus pertinente dans le cadre de mouvement d'organismes biologiques. Ces travaux font intervenir des interactions microscopiques diverses, mais quelques principes classiques se retrouvent régulièrement : une attraction entre particules à longue distance (pour les modèles sur domaine non périodiques) afin de favoriser l'agrégation, un alignement de vitesse avec les voisins à distance finie, et enfin une répulsion à courte portée, qui peut prendre des formes variées selon les modèles, et qui permet d'éviter une concentration irréaliste des individus du groupe.

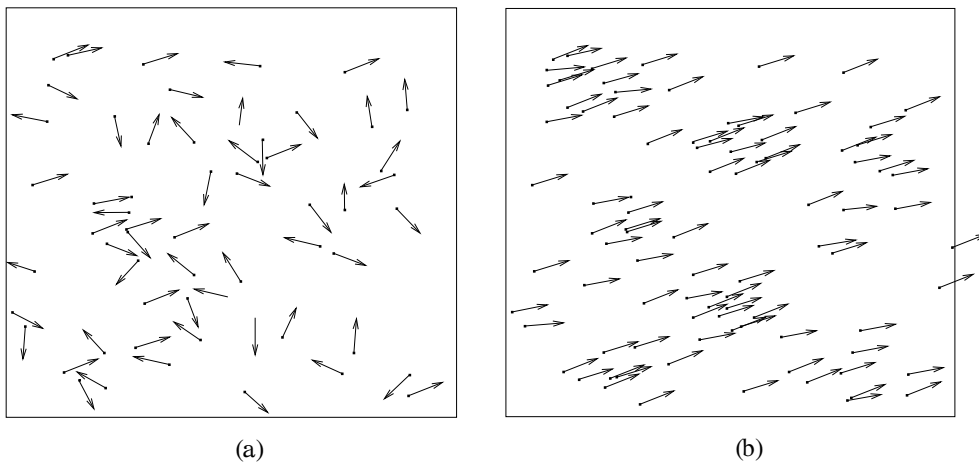

Figure 2: Transition de phase du modèle de Vicsek. (a) : faible densité et haute température, (b) : haute densité/faible température.

La question des transitions de phase est centrale pour ces modèles de dynamiques collectives,

où les comportements cohérents se développent lorsque l'alignement devient assez fort. Cette notion de transition de phase pour des modèles d'alignement n'est pas sans rappeler le modèle d'Ising et le modèle XY, deux modèles classiques de physique statistique. La résolution exacte du modèle d'Ising en dimension  $d = 2$  a été obtenue par Onsager en 1944, et a en particulier montré que le modèle d'Ising présente une aimantation spontanée. Contrairement au modèle d'Ising, le modèle XY, qui en est une version continue (les "spins" ne prennent plus les valeurs  $\pm 1$  mais une valeur angulaire  $\theta$  dans  $[0, 2\pi[$ ) ne présente pas en dimension 2 d'aimantation spontanée, en vertu du théorème de Mermin-Wagner [MW66]. C'est une des raisons de la popularité du modèle de Vicsek [VCB<sup>+</sup>95], qui bien que proche du modèle XY en terme d'alignement, retrouve une transition de phase de l'aimantation grâce à la mobilité des particules. Les modèles d'Ising et XY sont à ce jour bien compris. Ce sont des modèles à l'équilibre, et leur étude analytique est possible à l'aide du formalisme des mesures de Gibbs et de l'énergie libre, qui donne accès aux paramètres thermodynamiques du système.

Pour les modèles de matière active comme celui de Vicsek, la transition de phase est dynamique, et donc hors-équilibre. Les concepts développés pour les modèles à l'équilibre, en particulier l'énergie libre ou les mesures de Gibbs, ne peuvent donc plus être employées, et malgré les nombreux résultats numériques d'aimantation (cf. [SCB<sup>+</sup>15]) il devient délicat de montrer rigoureusement une transition de phase. Malgré ces difficultés, un certain nombre de résultats exacts ont été obtenus sur des modèles proches de celui de Vicsek et al. En 2007, Degond et Motsch ont proposé une version en temps continu du modèle de Vicsek, et ont déterminé la limite d'échelle macroscopique du système [DM08] ainsi que ses corrections microscopiques [DY10].

Leur modèle, directement inspiré de celui de Vicsek, est un modèle en *champ moyen*, où les particules interagissent avec toutes les autres particules présentes dans un voisinage macroscopique : cela permet d'éviter d'un certain nombre des difficultés des systèmes hors équilibre. Dans leur article original [DM08], Degond et Motsch supposent une loi des grands nombres sur le système microscopique, depuis obtenue rigoureusement [BCC11]. La transition de phase en fonction du niveau de bruit, entre système désordonné et alignement global, a été montrée [DFL14] pour ce modèle. Des résultats similaires ont depuis été étendus à des formes d'interactions plus générales, (e.g. [BCC10], [CDW13], [DLMP13]) ainsi qu'à des paramètres dépendant de la densité [Fro12]. L'évolution de la densité macroscopique a également pu être obtenue dans un cas particulier où l'interaction entre individus suit un potentiel de Morse [CHM14], là où précédemment la forme des nuées et des bancs de poissons n'était connue que empiriquement.

Le modèle d'Ising actif étudié dans [ST15] est un autre modèle d'alignement considéré pour expliquer les dynamiques collectives. Ce modèle s'affranchit de l'approximation de champs moyen employée dans le modèle de Vicsek. Les particules (qui ont soit un spin "+" soit un spin "-") se déplacent indépendamment sur un domaine d'espace discret, selon une marche aléatoire asymétrique dont la direction dépend de leur spin. En plus de cette dynamique de déplacement, les particules s'alignent avec les autres particules présentes sur le même site. Il a été montré numériquement que le modèle d'Ising actif possédait comme celui de Vicsek une transition de phase, en fonction de la température et la densité. A faible température et densité, on observe un gaz magnétiquement neutre, alors qu'à forte température et densité, on obtient un liquide très polarisé. Il existe également un domaine intermédiaire où ces deux phases coexistent. Le modèle d'Ising actif étant lui aussi un modèle hors équilibre, son étude théorique est délicate, principalement parce qu'il perd l'approximation du *champ moyen* du modèle de Vicsek. Il n'existe à notre connaissance aucune preuve mathématique de sa transition de phase.

### Séparation des phases due à la mobilité : MIPS

Lorsque la motilité des particules, dans un modèle de matière active, dépend de la densité, on peut observer une séparation entre une phase gazeuse peu dense et une phase condensée. Cette séparation est une conséquence directe du ralentissement des particules dans les zones plus denses : elles y passent plus de temps, et s'y accumulent donc, créant ce phénomène de congestion, appelé *Motility Induced Phase Transition*, ou MIPS [CT15]. En d'autres termes, l'énergie apportée à chaque particule éloigne le système de son équilibre, et crée des variations macroscopiques de densité.

Ce phénomène de congestion se retrouve pour plusieurs types de dynamiques. Une des plus étudiées est la dynamique de *run-and-tumble* [CY13], que l'on peut observer dans certains milieux bactériens : les individus avancent en ligne droite pendant un temps aléatoire, avant de se réorienter dans une autre direction aléatoire. En réalité, dès lors que la vélocité des particules dépend de la densité, le comportement macroscopique dépend peu des spécificités du mouvement microscopique. Par exemple, le comportement macroscopique de modèles run-and-tumble est le même que celui de modèles pour lesquels la direction du mouvement des particules diffuse aléatoirement (dits Active Brownian Particles, ABP) : il est montré numériquement dans [CT13], [SCT15] que ces deux modèles présentent des comportements macroscopiques remarquablement similaires de types MIPS.

On peut donc espérer, en introduisant dans le mouvement de nos particules une dépendance en densité, faire apparaître une MIPS.

### iii. Limites hydrodynamiques des systèmes non-gradients

Contrairement aux modèles de dynamiques collectives inspirés du modèle de Vicsek, notre objectif dans ce manuscrit est de proposer un modèle où les particules interagissent microscopiquement plutôt qu'en champ moyen. L'étude mathématique d'un modèle semblable à celui de Vicsek avec un mécanisme local d'alignement serait toutefois très difficile.

Une approche courante pour l'étude des systèmes de particules est de simplifier le modèle en considérant une dynamique où les particules se déplacent sur un réseau. L'idée de décrire des systèmes combinant mélange et alignement par un gaz sur réseau n'est pas nouvelle : dans [DMFL86], De Masi et al. étudient un système à deux types de particules où deux particules voisines peuvent échanger leurs positions, et changent de type afin de s'aligner avec les particules voisines. Ils obtiennent la limite d'échelle et les fluctuations du modèle lorsque la dynamique de mélange est accélérée à une échelle diffusive relativement à la dynamique d'alignement. Depuis cet article initial, de nombreux travaux ont traité de dynamiques combinant mélange (dynamique de Kawasaki) et alignement (dynamique de Glauber) pour des gaz sur réseau, avec des difficultés diverses selon les modèles microscopiques. Un principe de grande déviations pour une telle dynamique a notamment été prouvé dans [JLV93].

Nous considérons dans cette thèse un gaz de particules en dimension 2 évoluant sur un réseau périodique de taille  $N$ , noté  $\mathbb{T}_N^2$ . Les particules de notre système sont chacune caractérisées par un angle dans le plan,  $\theta \in [0, 2\pi[$ , et opèrent une marche aléatoire faiblement asymétrique dont l'asymétrie est dirigée dans la direction de leur angle. Nous combinons dans notre modèle tous les effets présentés précédemment. Afin de représenter une interactions à coeur dur, les particules ne peuvent pas se chevaucher (c'est la *règle d'exclusion*), ce qui crée les effets de congestion responsables de la séparation de phases due à la mobilité (MIPS). Cette approche distingue fondamentalement

notre modèle du modèle d'Ising actif, pour lequel les particules peuvent cohabiter sur un même site (cf. fin du paragraphe "Modèle de Vicsek et transition de phase dans les dynamiques d'alignement"). Par ailleurs, les angles des particules interagissent localement pour s'aligner en fonction des angles voisins, ce qui devrait également provoquer la transition de phase sur l'aimantation présente dans les modèles de Vicsek et d'Ising actif. Dans notre modèle, on peut espérer observer conjointement ces deux effets grâce à la séparation d'échelle entre la dynamique d'alignement et la dynamique faiblement asymétrique.

Nous obtenons dans ce manuscrit la limite hydrodynamique de ce système. D'une manière générale, la stratégie pour obtenir une limite hydrodynamique dépend largement des spécificités du modèle et doit donc être adaptée au cas par cas à la dynamique considérée. Nous verrons par exemple que la règle d'exclusion rend le système *non-gradient*, et pose par conséquent des difficultés importantes. La fin de cette introduction est consacrée à décrire quelques aspects des limites hydrodynamiques qui sont importants pour le modèle décrit ci-dessus.

### Systèmes non-gradients

Notre modèle fait partie d'une large classe de modèles microscopiques sur réseau dans lesquels le courant instantané de particules le long d'une arête ne prend pas la forme d'un gradient discret. Cette difficulté apparaît naturellement dans les systèmes d'exclusion, dans le cas notamment des systèmes comprenant plusieurs types de particules, ou encore pour les processus d'exclusion généralisée où  $\kappa$  particules par sites sont autorisées. De tels systèmes sont appelés *non-gradients*. Une grande partie de cette thèse est consacrée à la résolution des difficultés dues au caractère non-gradient du modèle.

La limite hydrodynamique dans le cas non-gradient a été obtenue pour la première fois par Varadhan [Var94a], puis par Quastel [Qua92]. Pour comprendre la difficulté, imaginons par exemple, en dimension 1, un système diffusif de taille  $N$ , suivant un générateur de Markov  $\mathcal{L}_N$ . En notant  $\eta_x$  l'état du système au site  $x$ ,  $\mathcal{L}_N \eta_x$  est un gradient microscopique,

$$\mathcal{L}_N \eta_x = N^2(j_{x-1,x} - j_{x,x+1}),$$

où  $j_{x,x+1}$  est le courant instantané le long de l'arête  $(x, x+1)$ . Ce gradient microscopique permet d'absorber un premier facteur  $N$  et se traduit par une dérivée spatiale au niveau macroscopique. Afin d'obtenir une équation diffusives semblable à l'équation de la chaleur, il faut absorber le second facteur  $N$  dans une seconde dérivée spatiale. C'est la difficulté des systèmes non-gradients, car le courant instantané  $j_{x,x+1}$  ne prend pas la forme d'un gradient discret, et l'objectif de la méthode non-gradient de Varadhan est donc d'obtenir une relation de *fluctuation-dissipation microscopique*

$$j_{x,x+1} \simeq -D(\eta_{x+1} - \eta_x) + \mathcal{L}g_x,$$

où  $\mathcal{L}g_x$  est une petite fluctuation disparaissant à la limite macroscopique, en accord avec la loi de Fick pour les systèmes diffusifs. Dans la plupart des cas, le coefficient de diffusion  $D$  est une fonction locale de la densité, mais n'est pas connu explicitement. Toutefois, dans le cas de l'exclusion simple pour plusieurs types de particules, Quastel a obtenu dans [Qua92] une expression semi-explicite de ce dernier en fonction des différentes densités de particules et du coefficient d'auto-diffusion décrit ci-dessous.

### Diffusion d'une particule marquée et coefficient d'auto-diffusion

La limite hydrodynamique de notre modèle fait intervenir le coefficient de diffusion d'une particule marquée pour l'exclusion simple symétrique. Le problème de la diffusion d'une particule marquée est un problème classique de physique statistique.

Le coefficient d'auto-diffusion pour l'exclusion simple symétrique peut être introduit de la manière suivante : on considère sur le réseau  $\mathbb{Z}^d$ , un système infini à l'équilibre, de densité  $\rho \in [0, 1]$ . On place une particule marquée à l'origine. Partant de cette configuration initiale, chaque particule suit une marche aléatoire symétrique avec même fonction de transition  $p(\cdot)$ , suivant la règle d'exclusion : deux particules ne peuvent pas se trouver sur le même site. Étant donnée  $\mathbf{X}_t = (X_t^1, \dots, X_t^d)$  la position de la particule marquée au temps  $t$ , on définit alors la *matrice d'auto-diffusion*  $D_s = D_s(\rho)$ , de dimension  $d$ , par

$$y D_s y^\dagger = \lim_{t \rightarrow \infty} \frac{\mathbb{E}((y \cdot \mathbf{X}_t)^2)}{t}, \quad \forall y \in \mathbb{R}^d, \quad (0.1)$$

où  $y^\dagger$  désigne le vecteur transposé de  $y$  et  $(\cdot)$  est le produit scalaire usuel dans  $\mathbb{R}^d$ .

Du point de vue mathématique, ce résultat découle de [KV86]. Il est montré dans [MFGW89] que dans les systèmes pour lesquels la fonction de transition  $p$  est invariante par changement de coordonnées, la matrice  $D_s$  est un multiple de l'identité et peut donc s'écrire  $D_s(\rho) = d_s(\rho)I_d$ , où  $I_d$  est la matrice identité de dimension  $d$ . Des simulations effectuées dans [NK80] sembleraient par ailleurs indiquer que dans notre cas 2-dimensionnel sur réseau carré, sous une dynamique d'exclusion simple vers les plus proches voisins, le coefficient d'auto-diffusion s'approche par

$$d_s(\rho) \simeq (1 - \rho)(1 - \rho/2).$$

Une formule variationnelle pour  $D_s$  a été obtenue un peu plus tard par Spohn [Spo90]. La régularité du coefficient d'auto-diffusion a d'abord été abordée dans [Var94b], où Varadhan montre que la matrice d'auto-diffusion est Lipschitz-continue en dimension  $d \geq 3$ . Landim, Olla et Varadhan ont depuis montré dans [LOV01] que le coefficient d'auto-diffusion est en réalité  $C^\infty$  en toute dimension. La question de l'auto-diffusion étant traitée en détail dans la Section 6, p199-240 de [KLO12], nous ne la développons pas plus ici.

### Dynamiques faiblement asymétriques

Dans une perspective de dynamique collective, chaque particule active de notre système est munie d'une vitesse, considérée de module constant, caractérisée par son angle dans le plan. Cette vitesse détermine l'orientation de l'asymétrie faible à laquelle est soumis le mouvement des particules, et a un certain nombre de conséquences pour la limite hydrodynamique. Tout d'abord, elle contribue à éloigner la dynamique d'un état d'équilibre, comme décrit précédemment dans le cadre de la matière active, et il faut donc s'assurer que des phénomènes du type MIPS (cf. paragraphe sur les séparations de phases) n'entravent pas le mélange local.

La limite hydrodynamique dans le cas de l'exclusion simple faiblement asymétrique à un seul type de particules a été obtenue en 1987 dans [DPS87]. Toutefois, l'asymétrie joue également un rôle particulier dans le cas de notre système non-gradient, car la perturbation de la mesure du processus engendre une contribution supplémentaire de l'asymétrie (cf. [QRV99], [GLM00], [BFG13]). En



particulier, la contribution des fluctuations  $\mathcal{L}g_x$  décrites précédemment n'est plus négligeable : en plus de la partie diffusive de la limite hydrodynamique, les courants instantanés symétriques engendrent donc une correction dans la limite hydrodynamique du terme dû à l'asymétrie faible, en accord avec la relation d'Einstein.

### Relation d'Einstein

La relation d'Einstein, parfois également appelée théorème de fluctuation-dissipation, est une relation qui lie la réponse d'un système physique à une petite fluctuation autour de son équilibre à la réponse du même système à une force extérieure. Elle a été initialement identifiée notamment par Einstein en 1905 pour le mouvement brownien, sous la forme

$$D = \mu k_B T,$$

où  $D$  désigne le coefficient de diffusion,  $\mu$  est le rapport entre la vitesse des particules et la force appliqué,  $k_B$  est la constante de Boltzmann, et  $T$  est la température du système.

En réalité, des relations analogues existent dans de nombreux systèmes physiques. Sous une forme très générale, ces relations peuvent s'écrire

$$\mathfrak{D}\mathcal{X} = \mathfrak{S},$$

où  $\mathfrak{D}$  est le *coefficient de diffusion du système*, qui caractérise son retour à l'équilibre, et  $\mathfrak{S}$  est la *conductivité du système*, réponse linéaire du système à une force extérieure. Le coefficient de proportionnalité  $\mathcal{X}$  peut avoir des expressions diverses selon le système. Toutefois, en physique des particules, il est souvent appelé *compressibilité du système*, c'est donc de cette manière que nous nous y référerons ici. Nous renvoyons le lecteur à la section 8.8, p140-141 de [Spo91] pour plus de détails à propos de la relation d'Einstein.

Dans de nombreux modèles de physique statistique, il est difficile de montrer rigoureusement cette relation. Toutefois, dans le cas des gaz sur réseau et de leurs limites hydrodynamiques, et particulièrement dans le cas non-gradient, cette relation apparaît naturellement au niveau microscopique, et se déduit de la méthode non-gradient relativement facilement (cf. Remark 5.36).

## iv. Gaz sur réseau multi-types et contributions du manuscrit

De nombreux travaux de physique statistique traitent des systèmes à plusieurs types de particules. Leur complexité dépend toutefois grandement des spécificités du modèle étudié. Un exemple naturel de système multi-types est celui de particules actives, où chaque vitesse possible peut s'interpréter comme un type de particule. Dans le cas des travaux dans un domaine d'espace continu, (e.g. [DFL13], [DFL14]) et sans collision de type cœur dur, la densité de chaque type de particule peut essentiellement être considérée indépendamment en ce qui concerne le déplacement, et la limite d'échelle fait donc intervenir une variable de vitesse en plus de la variable d'espace.

Lorsque les particules évoluent sur réseau, par contre, il est nécessaire de spécifier la manière dont les particules interagissent sur un même site. En termes de dynamique, les modèles multi-types permettent souvent

- soit l'interversion entre particules de types différents comme dans [Sas10a] pour un système totalement asymétrique avec retournement des vitesses.
- soit la cohabitation sur un même site de particules de types différents comme dans [DMF15] ou [Sim10] pour un modèle proche du nôtre où l'asymétrie faible est dirigée par la vitesse des particules.

Ces simplifications permettent de contourner les difficultés particulières posées par les systèmes diffusifs avec exclusion entre tous les types de particules : pour ces derniers, la limite d'échelle pour chaque type de particule requiert les outils non-gradients mentionnés précédemment. Ces outils ont été utilisés par Quastel [Qua92] pour l'obtention la limite hydrodynamique de l'exclusion symétrique à plusieurs types de particules. Ce résultat a ensuite été étendu au cas faiblement asymétrique (dans [QRV99] pour l'obtention d'un principe de grandes déviations pour la mesure empirique de l'exclusion simple symétrique, où l'asymétrie ne dépend pas de la configuration, et dans [GLM00] pour une asymétrie dépendant de la configuration via une interaction en champ moyen), ainsi qu'à une dynamique plus élaborée avec création/annihilation [Sas10b].

Dans ce manuscrit, nous revenons sur la preuve de l'exclusion à plusieurs types de particules introduite par Quastel. L'objectif principal de cette thèse est d'en apporter une version complétée et généralisée. D'une part, certains arguments spécifiques de Quastel ne sont valides que dans le cas symétrique. En particulier, dans le cas de l'exclusion à plusieurs types de particules, il est important de s'assurer que la densité locale de particules n'atteint jamais 1, car dans le cas contraire le système perd ses propriétés de mélange. Dans le cas de l'exclusion simple symétrique, la densité macroscopique évolue selon l'équation de la chaleur, et le contrôle de la densité à l'instant initial suffit. Dans notre cas, l'équation limite n'est pas une équation de diffusion, et il a fallu trouver une autre méthode pour contrôler la densité totale de particules.

Au delà de ce point délicat, quelques imprécisions ont depuis été trouvées dans la preuve de Quastel. Enfin, cette preuve est un des premiers exemples de limite hydrodynamique pour les systèmes non-gradients, et afin d'en faciliter la lecture, nous avons trouvé utile de l'adapter au formalisme moderne des limites hydrodynamiques [KL99].

Le second objectif est de généraliser la preuve de la limite hydrodynamique au cas faiblement asymétrique pour un continuum de types de particules. La limite hydrodynamique d'un gaz sur réseau à  $K$  types de particules prend la forme d'un système de  $K$  équations aux dérivées partielles couplées. Passer de  $K$  types de particules à un continuum de types de particules pose par conséquent des problèmes de définition du système différentiel limite. Une façon de contourner cette difficulté est de ne considérer la limite d'échelle que pour un nombre fini de paramètres macroscopiques caractérisant l'équilibre local du système (densité, énergie locale [OS13], moment [FSV10], asymétrie locale), se ramenant ainsi à un système fini d'équations aux dérivées partielles couplées.

Ce n'est pas la solution choisie dans notre modèle, car les équations obtenues pour un nombre fini de types de vitesses trouvaient une extension naturelle dans le cadre continu et laissaient penser que la limite d'échelle du cas continu était bien définie. Nous avons donc préféré conserver à la limite d'échelle chaque type de particule sous la forme d'une variable d'angle. Ce choix pose un certain nombre de difficultés, pour la plupart purement techniques. En particulier, contrairement aux exemples précédents, l'équilibre local de notre système n'est pas caractérisé par un nombre fini de paramètres, ce qui a nécessité un certain nombre d'adaptations de la preuve de la limite hydrodynamique.



## v. Résumé de la thèse

Le reste de cette Section est consacré à la formulation du résultat qui a constitué la majeure partie de mon travail de thèse. Afin de ne pas trop rentrer dans le détail des notations, ce résultat ne sera pas immédiatement présenté dans sa forme complète. La formulation détaillée de la limite hydrodynamique et les objets manipulés seront proprement introduit dans le corps de la thèse, en Section 1.3.

### Description du modèle à deux types de particules

Afin de rendre la formulation du résultat principal de cette thèse aussi clair que possible, nous présentons d'abord un modèle avec seulement deux types de particules, le premier type "0" préférant se déplacer vers la droite, et le second type " $\pi$ " préférant se déplacer vers la gauche. Les types sont donc à interpréter comme l'angle dans le plan de la vitesse des particules. Ces particules évoluent dans un domaine discret périodique de taille  $N$  tendant vers l'infini. Ce modèle a été celui sur lequel j'ai travaillé en premier, avant de passer au cadre continu, et a permis de dévoiler un certain nombre de difficultés dans la preuve de la limite hydrodynamique.

Pour la simplicité des notations, nous décrivons notre modèle en dimension 2. Chaque site  $x$  d'un domaine discret périodique de taille  $N$ , noté  $\mathbb{T}_N^2$ , est soit occupé par une particule de type 0 ( $\eta_x^0 = 1, \eta_x^\pi = 0$ ), soit par une particule de type  $\pi$  ( $\eta_x^0 = 0, \eta_x^\pi = 1$ ), soit vide ( $\eta_x^0 = \eta_x^\pi = 0$ ). Le système est initialement dans une configuration aléatoire de loi  $\mu^N$  suivant un profil lisse macroscopique  $\zeta = (\zeta^0, \zeta^\pi)$ . En d'autres termes, chaque site  $x$  est initialement occupé par une particule 0 avec probabilité  $\zeta^0(x/N)$ , par une particule  $\pi$  avec probabilité  $\zeta^\pi(x/N)$ , et est laissé vide sinon. Partant de cet équilibre local, le processus considéré dans cette thèse suit le générateur de Markov

$$L_N = N^2 \left[ \mathcal{L} + \frac{1}{N} \mathcal{L}^{\text{wa}} \right] + \mathcal{L}^{\text{G}},$$

où  $\mathcal{L}$  est le générateur d'exclusion simple symétrique vers les plus proches voisins,

$$\mathcal{L}f(\widehat{\eta}) = \sum_{x \in \mathbb{T}_N^2} \sum_{|z|=1} \eta_x (1 - \eta_{x+z}) (f(\widehat{\eta}^{x, x+z}) - f(\widehat{\eta})),$$

$\mathcal{L}^{\text{wa}}$  est la contribution de l'asymétrie au générateur d'exclusion complet,

$$\mathcal{L}^{\text{wa}} f(\widehat{\eta}) = \lambda \sum_{x \in \mathbb{T}_N^2} \sum_{\delta=\pm 1} \delta (\eta_x^0 - \eta_x^\pi) (1 - \eta_{x+\delta e_1}) (f(\widehat{\eta}^{x, x+\delta e_1}) - f(\widehat{\eta})).$$

Cet opérateur seul n'est pas un générateur de Markov, en raison des "taux de saut" négatifs, mais une fois ajouté à la partie symétrique, ce problème disparaît, et on obtient bien un générateur de Markov. Enfin,  $\mathcal{L}^{\text{G}}$  est le générateur qui régit l'alignement local des particules avec les particules voisines.

$$\mathcal{L}^{\text{G}} f(\widehat{\eta}) = \sum_{x \in \mathbb{T}_N^2} \eta_x c_{x,\beta}(\widehat{\eta}) (f(\widehat{\eta}^x) - f(\widehat{\eta})) d\theta. \quad (0.2)$$

Dans les identités ci dessus,  $f$  est une fonction locale,  $\eta_x = \eta_x^0 + \eta_x^\pi$  détermine si un site est occupé ( $\eta_x = 1$ ) ou non ( $\eta_x = 0$ ),  $\widehat{\eta}$  désigne la configuration complète  $(\eta_x^0, \eta_x^\pi)_{x \in \mathbb{T}_N^2}$ ,  $\widehat{\eta}^{x, x+z}$  désigne la

configuration où les valeurs en  $x$  et  $x+z$  ont été échangées, et enfin  $\widehat{\eta}^x$  désigne la configuration où le type de la particule en  $x$  a été changé. Le terme  $\delta(\eta_x^0 - \eta_x^\pi)$  dans la définition du générateur asymétrique  $\mathcal{L}^{\text{wa}}$  exprime que les particules de type 0 (resp.  $\pi$ ) se dirigent plutôt dans la direction  $e_1$  (resp.  $-e_1$ ). L'intensité  $\lambda$  et la température inverse  $\beta$  représentent la force de l'asymétrie et de l'alignement, et on prendra par exemple des taux de retournement inspirés du modèle d'Ising

$$c_{x,\beta}(\widehat{\eta}) = \exp\left(-\beta \sum_{y \sim x} (\eta_x^0 - \eta_x^\pi)(\eta_y^0 - \eta_y^\pi)\right),$$

qui est minimal lorsque tous les sites  $y$  voisins de  $x$  (noté  $y \sim x$ ) sont occupés par des particules du même type que la particule en  $x$ .

La construction de l'état initial et le générateur complet  $L_N$  nous permettent donc de construire à  $N$  fixé un processus de Markov  $(\widehat{\eta}(t))_{0 \leq t \leq T}$ , dont nous allons formuler maintenant la limite hydrodynamique  $N \rightarrow \infty$ .

### Limite hydrodynamique

Avant de donner la formulation précise de la limite hydrodynamique sous une forme faible, nous en donnons une version heuristique. Notons  $\rho_t$  (resp.  $\rho_t^0, \rho_t^\pi$ ) la densité macroscopique de particules totale (resp. de type 0, de type  $\pi$ ) sur le tore continu au temps  $t$ . Alors, en notant  $\partial_{u_1}$  la dérivée partielle selon la première coordonnée spatiale,  $\rho^0$  et  $\rho^\pi$  sont solutions au sens faible des équations aux dérivées partielles couplées

$$\begin{cases} \partial_t \rho_t^0 = \nabla \cdot [\mathfrak{d}(\rho_t^0, \rho_t) \nabla \rho_t + d_s(\rho_t) \nabla \rho_t^0] + 2\lambda \partial_{u_1} [\mathfrak{s}(\rho_t^0, \rho_t)(\rho^0 - \rho^\pi) + d_s(\rho_t) \rho_t^0] + \Gamma(\rho_t^0, \rho_t^\pi) \\ \partial_t \rho_t^\pi = \nabla \cdot [\mathfrak{d}(\rho_t^\pi, \rho_t) \nabla \rho_t + d_s(\rho_t) \nabla \rho_t^\pi] - 2\lambda \partial_{u_1} [\mathfrak{s}(\rho_t^\pi, \rho_t)(\rho^0 - \rho^\pi) + d_s(\rho_t) \rho_t^\pi] - \Gamma(\rho_t^0, \rho_t^\pi) \\ (\rho_0^0, \rho_0^\pi) = (\zeta^0, \zeta^\pi). \end{cases} \quad (0.3)$$

Dans les équations ci dessus,  $d_s$  est le coefficient d'auto-diffusion en dimension 2 mentionné dans l'introduction, les coefficients  $\mathfrak{d}$  et  $\mathfrak{s}$  sont donnés par

$$\mathfrak{d}(\rho^*, \rho) = \frac{\rho^*}{\rho} (1 - d_s(\rho)) \quad \text{et} \quad \mathfrak{s}(\rho^*, \rho) = \frac{\rho^*}{\rho} (1 - \rho - d_s(\rho)),$$

et  $\Gamma(\rho_t^0, \rho_t^\pi)$  est le taux de création relatif de particules de type 0 dû à la dynamique d'alignement. Ce dernier peut s'écrire comme l'espérance sous la mesure d'équilibre local de paramètres  $(\rho_t^0, \rho_t^\pi)$  du taux microscopique de création. Bien que ce ne soit pas apparent, les coefficients  $\mathfrak{d}$  et  $\mathfrak{s}$  vérifient bien la relation de Stokes-Einstein sous forme matricielle en écrivant le système différentiel vérifié par le vecteur  $\begin{pmatrix} \rho_t^0 \\ \rho_t^\pi \end{pmatrix}$ .

Il est très délicat d'obtenir un résultat d'unicité pour les solutions du système (0.3), principalement en raison des coefficients de diffusion non-constants. Par conséquent, il est nécessaire de se restreindre à une formulation faible de la limite hydrodynamique. À cette fin, définissons  $\pi_t^{0,N}$  et  $\pi_t^{\pi,N}$  les mesures empiriques sur le tore continu, au temps  $t$ , relatives à  $\eta^0(t)$  et  $\eta^\pi(t)$

$$\pi_t^{0,N} = \frac{1}{N^2} \sum_{x \in \mathbb{T}_N^2} \eta_x^0(t) \delta_x \quad \text{et} \quad \pi_t^{\pi,N} = \frac{1}{N^2} \sum_{x \in \mathbb{T}_N^2} \eta_x^\pi(t) \delta_x$$

Soit alors  $Q^N$  la loi du couple  $(\pi_t^{0,N}, \pi_t^{\pi,N})$ , nous pouvons énoncer notre résultat principal dans le cas à 2 types de particules :

**Théorème.** *La suite  $(Q^N)_{N \in \mathbb{N}}$  est relativement compacte pour la topologie faible, et chacun de ses points limites  $Q^*$  est concentré sur des trajectoires  $(\pi^0, \pi^\pi)$  telles que*

- $\pi^0$  et  $\pi^\pi$  sont absolument continues à tout temps  $t$  par rapport à la mesure de Lebesgue sur le tore continu, on note leurs densités respectives  $\rho^0$  et  $\rho^\pi$ .
- $\nabla \rho$ ,  $d_s(\rho)\nabla \rho^0$  et  $d_s(\rho)\nabla \rho^\pi$  sont bien définis, c'est-à-dire que  $\rho^0$  et  $\rho^\pi$  sont dans  $H^1$  sur le domaine où la densité totale de particules  $\rho$  soit différente de 1.
- Les densités  $\rho^0$  et  $\rho^\pi$  sont solutions au sens faible du système (0.3).

Définir proprement  $d_s(\rho)\nabla \rho^0$  et  $d_s(\rho)\nabla \rho^\pi$  est un problème à part entière, que nous aborderons plus tard en Section 4.5.

La preuve de ce résultat pose un certain nombre de problèmes, dont certains ont d'ores et déjà été soulevés dans l'introduction. La principale difficulté est le caractère non-gradient du modèle : les courants symétriques instantanés de chaque type de particules entre deux sites  $x$  et  $x + e_i$ , notés  $j_{x,x+e_i}^0$  et  $j_{x,x+e_i}^\pi$ , qui peuvent s'écrire

$$j_{x,x+e_i}^0 = \eta_x^0(1 - \eta_{x+e_i}) - \eta_{x+e_i}^0(1 - \eta_x), \quad \text{et} \quad j_{x,x+e_i}^\pi = \eta_x^\pi(1 - \eta_{x+e_i}) - \eta_{x+e_i}^\pi(1 - \eta_x)$$

ne sont pas des gradients discrets.

La seconde difficulté est très spécifique au modèle : l'exclusion entre particules de type différent fait que le système ne converge plus vers son équilibre local lorsque la densité s'approche de 1. À titre d'exemple, considérons une configuration dont la moitié gauche est entièrement occupée par des particules de type 0, et dont la moitié droite est entièrement occupée par des particules de type  $\pi$ . Une telle configuration localement pleine ne pourra pas bouger du tout, et à fortiori ne pourra pas atteindre son équilibre, qui serait donné par des proportions de particules de type 0 et  $\pi$  localement homogènes. En d'autres termes, le système n'est pas irréductible sur l'ensemble des configurations locales à nombre fixé de particules de type 0 et  $\pi$  lorsque tous les sites sont remplis. Pour contourner cette difficulté, Quastel utilise dans [Qua92] la connaissance de l'équation limite pour la densité totale, qui est l'équation de la chaleur puisque ses particules suivent une dynamique d'exclusion simple symétrique. Cela assure, dans son cas, que la densité locale n'atteint jamais 1 sous réserve qu'elle soit initialement inférieure à 1 partout. Ce n'est pas une option pour notre modèle car les particules sont soumises à une asymétrie faible, et l'équation suivie par la densité totale devrait être

$$\partial_t \rho_t = \Delta \rho_t + \partial_{u_i} (\rho_t (\rho_t^0 - \rho_t^\pi)).$$

Dans l'équation ci dessus,  $\rho_t^0 - \rho_t^\pi$  a priori une quantité aléatoire susceptible de créer des chocs. Il nous a donc fallu trouver une méthode alternative pour montrer microscopiquement que la densité locale atteint suffisamment rarement 1 pour ne pas poser de problèmes.

La dernière difficulté est posée par la forme de l'équation différentielle limite elle même, et en particulier par sa partie diffusive. En effet, la forme différentielle

$$d(\rho^*, \rho) d\rho + d_s(\rho) d\rho^*$$

n'étant en général pas fermée, la partie diffusive du système d'équations aux dérivées partielles ne peut pas se mettre sous la forme  $\Delta \widetilde{D}(\rho_t^0, \rho_t^\pi)$ , ce qui pose un certain nombre de problèmes pour l'unicité des solutions d'une part, ainsi que pour opérer la seconde intégration par parties nécessaire dans les limites hydrodynamiques des systèmes diffusifs.

### Passage à des angles continus

La linéarité du système (0.3) en chaque densité élémentaire  $\rho^0$  et  $\rho^\pi$ , présage qu'il est possible d'augmenter le nombre de types de particules du modèle. Le passage à un nombre fini, même élevé, de particules, pose un petit problème technique, car il ne suffit plus d'avoir un seul site vide dans une configuration pour rendre le processus irréductible sur les ensembles des configurations locales à nombre de particules de chaque type fixé.

Cette remarque est une conséquence du problème dit du *15-puzzle* [JS79] : dans un voisinage carré de  $n$  sites, si on a  $n - 1$  particules toutes de types différents (ce qui est généralement le cas si chaque particule est caractérisé par un angle continu), en autorisant les particules à sauter uniquement sur le site vide, et étant donné une configuration initiale sur ce voisinage, la moitié des configurations possibles ne seront pas atteignables. Il faut donc au moins deux sites vides et non un seul pour assurer l'irréductibilité. À cette difficulté technique près, la preuve est exactement la même pour un nombre fini de types de particules.

Nous souhaitons maintenant construire un modèle dans lequel le type de la particule présente à un site donné  $x$  du tore discret  $\mathbb{T}_N^2$  dépend d'un paramètre *continu*  $\theta_x$ , l'angle de sa vélocité dans le plan, et non comme précédemment d'un paramètre discret  $\theta_x \in \{0, \pi\}$ .

La configuration initiale est choisie selon un profil lisse  $\widehat{\zeta} : \mathbb{T}^2 \times [0, 2\pi[ \rightarrow \mathbb{R}_+$ , où en chaque site  $x$ , une particule d'angle  $\theta_x \in [\theta, \theta + d\theta[$  est placée avec probabilité  $\widehat{\zeta}(x/N, \theta)d\theta$ , et le site est laissé vide avec probabilité  $1 - \int_{[0, 2\pi[} \widehat{\zeta}(x/N, \theta)d\theta$ .

L'asymétrie subie par une particule d'angle  $\theta$  dans la direction  $i$  est maintenant  $\lambda_i(\theta)$ , où les fonctions  $\lambda_i$  sont donnée par

$$\lambda_1(\theta) = \lambda \cos(\theta) \quad \text{et} \quad \lambda_2(\theta) = \lambda \sin(\theta).$$

On remplace donc la partie asymétrique du générateur du processus d'exclusion par

$$\mathcal{L}^{\text{va}} f(\widehat{\eta}) = \sum_{x \in \mathbb{T}_N^2} \sum_{i=1,2, \delta=\pm 1} \delta \lambda_i(\theta_x) \eta_x (1 - \eta_{x+\delta e_i}) (f(\widehat{\eta}^{x, x+\delta e_i}) - f(\widehat{\eta})),$$

et le générateur de l'alignement par sa version continue en angle

$$\mathcal{L}^G f(\widehat{\eta}) = \sum_{x \in \mathbb{T}_N^2} \eta_x \int_{\mathbb{S}} c_{x,\beta}(\theta, \widehat{\eta}) (f(\widehat{\eta}^{x,\theta}) - f(\widehat{\eta})) d\theta,$$

où  $\widehat{\eta}^{x,\theta}$  est la configuration dans laquelle l'angle  $\theta_x$  de la particule au site  $x$  est fixé à  $\theta$ , et où l'on peut par exemple choisir

$$c_{x,\beta}(\theta, \widehat{\eta}) = \exp \left( \beta \sum_{y \sim x} \eta_y \cos(\theta_y - \theta) \right).$$

Étant donnée la forme de l'équation différentielle limite dans le cas à deux types de particules, on peut s'attendre à ce que l'équation macroscopique du mouvement soit donnée par

$$\partial_t \rho_t^\theta = \nabla \cdot \left[ \mathfrak{d}(\rho_t^\theta, \rho_t) \nabla \rho_t + d_s(\rho_t) \nabla \rho_t^\theta \right] + 2 \nabla \cdot \left[ \mathfrak{s}(\rho_t^\theta, \rho_t) \lambda \vec{\Omega}_t + d_s(\rho_t) \rho_t^\theta \begin{pmatrix} \lambda_1(\theta) \\ \lambda_2(\theta) \end{pmatrix} \right] + \Gamma_t, \quad (0.4)$$

où les coefficients  $\mathfrak{d}$  et  $\mathfrak{s}$  sont les mêmes que dans le paragraphe précédent,  $\rho^\theta$  est la densité de particules d'angle  $\theta$ , et  $\rho = \int \rho^\theta d\theta$  est la densité totale. Dans l'équation ci dessus,  $\vec{\Omega}_t$  désigne la direction moyenne de l'asymétrie locale

$$\vec{\Omega}_t(u) = \int_{[0, 2\pi[} \rho_t^\theta(u) \begin{pmatrix} \cos(\theta) \\ \sin(\theta) \end{pmatrix} d\theta,$$

et  $\Gamma_t$  est le taux relatif de création de particules d'angle  $\theta$ , qui s'exprime là encore comme l'espérance sous une mesure produit du taux microscopique de création. On peut alors formuler la limite hydrodynamique de manière similaire au cas à deux types de particules. Toutefois, la formulation rigoureuse est plus délicate, notamment parce qu'il n'est pas toujours vrai que la mesure empirique reste à densité par rapport à la mesure de Lebesgue en  $\theta$ . Par conséquent, la limite des mesures empiriques est une mesure à densité en espace mais pas nécessairement en angle. Les mesures limites sont donc solutions de (0.4) au sens faible *en espace et en angle*, et cette équation est à prendre au sens des mesures en  $\theta$ . La formulation et la preuve de la limite hydrodynamique du modèle à angle continu est l'objet de cette thèse, et sa formulation rigoureuse est donc reportée à la Section 1.3. Le passage au cadre continu pose plusieurs difficultés techniques, dues notamment à la nature de l'équilibre local. En effet, dans le cas à deux types, l'équilibre local est caractérisé par les densités  $\rho^0$  et  $\rho^\pi$ . Ce n'est évidemment plus le cas dans le cas où  $\theta$  évolue dans  $[0, 2\pi[$ , et où cette fois le paramètre de l'équilibre local est une mesure sur  $[0, 2\pi[$  dont la masse totale, inférieure à 1, représente la densité locale de particules.

Pour cette raison, le formalisme utilisé dans ce manuscrit est relativement proche des mesures de Young (cf. [KL99], Chapitre 8 p.200). Toutefois, les raisons pour lesquelles ce formalisme est utilisé sont extrêmement différentes. Les mesures de Young sont utilisées pour des processus asymétriques non diffusifs, et par conséquent pour lesquels l'estimée à deux blocs n'est pas prouvée (cf. Lemma 3.4) : les processus en question présentent des variations de densité au niveau mésoscopique, et l'obtention de la densité sur un petit bloc macroscopique ne relève donc pas d'une loi des grands nombres. Par conséquent, la densité mésoscopique prend la forme d'une mesure pondérant les densités microscopiques présentes dans le bloc, et on obtient à la limite une densité moyenne qui est l'espérance de cette mesure. Ici, notre scaling est bien diffusif, et il est donc possible d'obtenir une loi des grands nombres pour notre système de particules ; la nécessité de conserver une mesure comme paramètre de l'équilibre local découle directement de notre volonté d'obtenir une équation différentielle "à  $\theta$  fixé".

### Extensions du modèle

Les différents paramètres et les aspects dynamiques de notre modèle ont été choisis dans une optique de dynamique collective, en essayant de conserver des notations aussi lisibles que possible. Toutefois, la limite hydrodynamique énoncée ci-dessus reste vraie plus généralement. Nous

décrivons ici quelques modifications du modèle pour lesquelles la preuve que nous présentons de la limite hydrodynamique s'adapte facilement.

L'extension la plus naturelle est celle de la dimension. Notre résultat reste vrai pour des dimensions  $d > 2$ , car les quelques arguments géométriques utilisés au cours de la preuve sont encore vrais en dimension supérieure. La dimension 1 pose toutefois problème, ce qui peut s'expliquer de la manière suivante : deux particules souhaitant aller dans des directions opposées bloquent complètement la dynamique macroscopique, et le mélange microscopique n'est donc pas suffisant pour obtenir la limite d'échelle.

Au niveau des sauts possibles pour chaque particule, nous avons choisi ici des sauts exclusivement vers les plus proches voisins. En réalité, de la même manière que dans [Qua92], il est possible de choisir pour le générateur de déplacement  $\mathcal{L}^D$  une fonction de transition quelconque  $p(\cdot)$ , à condition qu'elle soit symétrique ( $\sum_z p(z)z = 0$ ) et de portée finie ( $p(z) \neq 0$  pour un nombre fini de sites seulement). Afin d'obtenir la formulation de la limite hydrodynamique dans ce cas, il faut changer, dans les expressions des coefficients de diffusion  $\mathfrak{d}$  et de drift  $\mathfrak{s}$ , le coefficient de diffusion  $d_s$  par la matrice d'auto-diffusion  $D_s$  (cf. équation (0.1)), correspondant à la fonction de transition  $p(\cdot)$ , et les coefficients  $f(\rho, \widehat{\rho})$  par  $f(\rho, \widehat{\rho})D$ , où  $D$  est la matrice définie par  $D_{ij} = \sum_z p(z)z_i z_j$ .

En termes de drift, là encore, un large choix est également possible. Plus précisément, les fonctions  $\lambda_i(\theta)$  peuvent être remplacées par n'importe quelle fonction

$$\begin{aligned} \lambda_i & : \mathbb{T}^2 \times \mathbb{S} \longrightarrow \mathbb{R} \\ (u, \theta) & \longmapsto \lambda_i(u, \theta) \end{aligned} \quad ,$$

à condition que  $\lambda_i$  soit  $C^1$  en la variable d'espace  $u$  et que  $\lambda_i$  et les  $\partial_{u_j} \lambda_i$  restent globalement bornées par un réel positif  $\lambda$ .

La dynamique d'alignement offre encore de nombreuses possibilités. Nous avons choisi une dynamique de saut inspirée du modèle d'Ising, mais la limite hydrodynamique resterait vraie, avec une contribution  $\Gamma$  différente, pour de nombreuses dynamiques d'alignement. Une alternative plus pertinente dans le cadre des dynamiques collectives serait par exemple de remplacer le générateur d'alignement par le générateur diffusif

$$\mathcal{L}^G f(\widehat{\eta}) = \sum_{x \in \mathbb{T}_N^2} \frac{\partial}{\partial \theta_x} \left[ V(\theta_x - \bar{\theta}_x) \frac{\partial f}{\partial \theta_x} \right],$$

où  $V$  est un potentiel d'alignement (e.g.  $V(\theta) = 1 - e^{-\theta^2}$ ) et  $\bar{\theta}_x$  est la moyenne angulaire dans un voisinage microscopique de  $x$ . Dans ce cas, le terme d'alignement dans (0.3) serait à remplacer par un autre terme de diffusion angulaire. En réalité, on peut choisir pour dynamique d'alignement n'importe quelle fonction locale et bornée de la configuration sans difficultés vis-à-vis de la preuve de la limite hydrodynamique.

## vi. Perspectives de recherche

Les questions suivantes découlent de mon travail de thèse, et sont donc des pistes naturelles pour poursuivre mon travail sur les modèles microscopiques d'alignement.



**Interactions topologiques :** Dans le domaine des dynamiques collectives, les données réelles sont une ressource rare, les récents progrès techniques ont toutefois permis d'obtenir sur ces comportements cohérents des données d'une précision jusqu'ici inaccessible. À l'aide d'une capture stéréo, une équipe de chercheurs italiens a par exemple pu numériser les données de vol d'une nuée d'étourneaux [BCC<sup>+</sup>08], et montrer que l'interaction entre voisins n'était pas métrique, mais topologique, i.e. que les étourneaux interagissaient avec leurs  $k$  plus proches voisins plutôt qu'avec tous les oiseaux à une distance donnée. Des techniques similaires de suivi vidéo ont été utilisées dans d'autres milieux, par exemple pour suivre chaque individu dans un banc de poissons [BVDP06]. En termes de limite hydrodynamique, il serait donc intéressant de considérer des interactions topologiques pour notre système de particules. Ce type d'interactions pourrait poser des problèmes dans le régime de faible densité, car les interactions entre particules ne sont plus locales, mais on peut s'attendre à ce que notre limite hydrodynamique soit encore valide.

**Grandes déviations :** La limite hydrodynamique de notre système décrit le comportement moyen de notre système lorsque sa longueur caractéristique tend vers 0, mais donne peu d'informations sur les fluctuations autour de ce comportement moyen. Une question naturelle qui suit donc l'obtention de la limite hydrodynamique est celle des grandes déviations du système. Les principes de grandes déviations ont été largement utilisés en physique statistique comme moyen de comprendre les propriétés des systèmes de particules hors équilibre. Un principe de grandes déviations pour la mesure empirique de l'exclusion simple symétrique a été obtenue par Quastel et al. dans [QRV99]. La preuve repose en grande partie sur les estimations non-gradientes également obtenues par Quastel dans [Qua92]. Depuis, de multiples principes de grandes déviations ont été obtenus pour d'autres systèmes non gradients, et les techniques utilisées pour les obtenir devraient nous permettre d'obtenir un principe joint de grandes déviations pour la densité et le courant de notre modèle. Ce principe de grandes déviations pourrait être une première étape pour comprendre les propriétés de notre système hors équilibre.

**Transition de phase hors équilibre :** Comme nous l'avons expliqué dans l'introduction, les phénomènes de transition de phase occupent une place importante en modélisation des dynamiques collectives. La présence dans notre processus de dynamiques d'alignement (générateur de Glauber) et d'exclusion à des échelles différentes nous permettent de supposer que notre système de particule exhibe à la fois une transition de phase du même type que dans le modèle de Vicsek, ainsi que de propriétés de séparations de phase dues à la mobilité (MIPS). On peut donc en particulier attendre de notre modèle une transition de phase entre un désordre local et un mouvement globalement cohérent quand la densité totale de particules passe un seuil critique  $\rho_c$ . Les travaux réalisés autour du modèle de Vicsek laissent par ailleurs penser que ce seuil critique dépend des paramètres de notre système : la force de l'asymétrie  $\lambda$  et la température inverse de l'alignement  $\beta$ .

Toutefois, si les transitions de phase à l'équilibre (modèle d'Ising, modèle XY) sont maintenant bien comprises, les transitions de phases hors équilibre comme celle du modèle de Vicsek et du modèle d'Ising actif ne permettent pas l'utilisation de l'énergie libre et du formalisme des mesures de Gibbs, et sont donc beaucoup plus difficiles à appréhender. Pour des modèles qui, comme le notre, combinent une dynamique de Glauber et une dynamique de déplacement des particules, les mesures stationnaires ne sont plus de type Gibbs, et il est très difficile de montrer une transition de phase. L'unicité à haute température a été obtenue par exemple pour le processus Glauber+Kawasaki dans [BPSV00]. Il devrait être possible de s'inspirer de la méthode employée pour montrer l'unicité à

haute température pour notre modèle, en se restreignant éventuellement à une dynamique spécifique d'alignement. Il sera par contre beaucoup plus difficile de montrer la coexistence de phases à basse température, ce qui n'a pour l'instant jamais été fait pour un modèle comprenant à la fois une dynamique d'alignement et une dynamique de déplacement des particules.

## vii. Structure de la preuve

Le manuscrit est organisé de la manière suivante : La Section 1 est consacrée à la description du modèle à angles continus, l'introduction de la plupart des notations importantes, et à la formulation rigoureuse de la limite hydrodynamique.

La Section 2 est divisée en trois parties. Dans la Section 2.1 nous caractérisons l'équilibre local de notre processus, en introduisant l'ensemble  $\mathcal{M}_1(\mathbb{S})$  des paramètres des mesures grand-canoniques relatives au processus à angle continu. Nous définissons notamment la topologie dont nous munissons  $\mathcal{M}_1(\mathbb{S})$ , dont quelques propriétés sont énoncées dans l'appendice B. Dans la Section 2.2 nous montrons, à l'aide d'outils classiques, qu'à tout temps, l'entropie de la mesure de notre processus par rapport à une mesure d'équilibre de référence est d'ordre  $N^2$ . La troisième partie 2.3 répond au problème de l'irréductibilité, qui est spécifique à notre modèle. Il s'agit d'une difficultés majeures de cette thèse. Le résultat principal de cette partie est qu'au niveau microscopique, les configurations sont très rarement localement pleines, ce qui est nécessaire pour assurer l'irréductibilité de notre processus au niveau microscopique.

Dans la Section 3 nous montrons la loi des grands nombres pour notre processus. Le Lemme de Remplacement énoncé en Section 3.1 repose sur les estimations usuelles à un (Section 3.3) et deux blocs (Section 3.4). Bien que nous suivions la stratégie classique pour montrer le Lemme de Remplacement, quelques adaptations techniques dues aux spécificités de notre modèle sont nécessaires.

La Section 4 fait figure de préliminaire à la méthode non-gradient. Les deux résultats importants de cette Section sont le trou spectral sur un sous ensemble de fonctions (Section 4.2), dont la stratégie de preuve est due à Quastel [Qua92], et la comparaison de la mesure du processus avec asymétrie à la mesure du processus à l'équilibre (Section 4.3). Nous y prouvons également, en adaptant les méthodes classiques, la compacité de la suite  $(Q^N)_{N \in \mathbb{N}}$  (Section 4.4) ainsi qu'une estimation d'énergie (Section 4.5) nécessaire pour la méthode non-gradient.

La méthode non-gradient à proprement parler est développée dans la Section 5. Elle est composée d'un grand nombre de résultats intermédiaires que nous n'énonçons pas ici. L'application de la méthode non-gradient à notre système génère toutefois un certain nombre de difficultés propres à notre modèle : le problème principal est traité en Section 5.3, où nous contrôlons la contribution des domaines microscopiques pleins. Dans les Sections 5.8 et 5.9, nous déterminons la matrice de conductivité du système ainsi que forme du terme dû à l'asymétrie. Cela nous permet grâce à la relation de Stokes-Einstein, de retrouver la forme du coefficient de diffusion obtenue par Quastel.

Tous ces résultats sont exploités dans la Section 6, où nous concluons la limite hydrodynamique de notre processus. Un travail spécifique y est nécessaire afin d'opérer la seconde intégration par partie. Ceci est dû à la forme spécifique de la partie diffusive de la limite hydrodynamique de notre modèle.





---



---

# THE ACTIVE EXCLUSION PROCESS

---



---

## 1 Notations and Main theorem

We describe an interacting particle system, where a particle follows an exclusion dynamics with a weak bias depending on an angle associated to this particle. At the same time, each particle updates its angle according to the angles of the neighboring particle. We study the macroscopic behavior of the corresponding 2-dimensional system with a periodic boundary condition.

### 1.1 Main notations and introduction of the Markov generator

A *configuration of the system* is made of two parts. The first one is the set of occupied sites, and the second the preferred direction of the particles. More precisely, on the two dimensional discrete set

$$\mathbb{T}_N^2 = \{1, \dots, N\}^2$$

with *periodic boundary conditions*, we define the occupation configuration  $\eta = (\eta_x)_{x \in \mathbb{T}_N^2} \in \{0, 1\}^{\mathbb{T}_N^2}$  which determines the occupied sites of the domain. We allow at most one particle per site, and  $\eta_x$  represents whether the site  $x \in \mathbb{T}_N^2$  is occupied ( $\eta_x = 1$ ) or empty ( $\eta_x = 0$ ). For any *occupied* site  $x \in \mathbb{T}_N^2$ , we also introduce  $\theta_x \in [0, 2\pi[$  the angle of the particle at  $x$ , which represents the mean direction of its velocity in the plane. We will denote by

$$\mathbb{S} = [0, 2\pi[,$$

the *periodic* set of possible angles. When the site  $x$  is unoccupied, the angle of the site is set to  $\theta_x = 0$  by default.

**Definition 1.1** (Configuration of the particle system, angle-blind and cylinder functions). *For any site  $x \in \mathbb{T}_N^2$ , we denote by  $\widehat{\eta}_x$  the pair  $(\eta_x, \theta_x)$ , and by  $\widehat{\eta} = (\widehat{\eta}_x)_{x \in \mathbb{T}_N^2}$  the complete configuration. The set of all configurations will be denoted by*

$$\Sigma_N = \left\{ (\eta_x, \theta_x)_{x \in \mathbb{T}_N^2} \in (\{0, 1\} \times \mathbb{S})^{\mathbb{T}_N^2} \mid \theta_x = 0 \text{ if } \eta_x = 0 \right\}.$$

We will call *cylinder function* any function  $f$  depending on a finite set of vertices  $B_f \subset \mathbb{T}_N^2$ , and  $C^1$  w.r.t. each  $\theta_x$ , for any  $x \in B_f$ . The set of cylinder functions on the torus will be denoted  $C$ . Note that a cylinder function is always bounded.

We will call *angle-blind function* any function depending on  $\widehat{\eta}$  only through the occupation variables  $\eta = (\eta_x)_{x \in \mathbb{T}_N^2}$ . In other words, an angle-blind function depends on the position of particles, but not on their angles. We denote by  $\mathcal{S} \subset C$  the set of cylinder angle-blind functions.

We will use on the discrete torus the notations  $|\cdot|$  for the norm  $|x| = \sum_i |x_i|$ .

Let  $T$  be a fixed time, we now introduce the process  $(\widehat{\eta}(t))_{t \in [0, T]}$  on  $\Sigma_N$  which is central to our work. Our goal is to combine the two dynamics present in Viscek's model [VCB<sup>+</sup>95] : The first part of the process is the *displacement dynamic*, which rules the *motion of each particle*. The moves occur at rates biased by the angle of the particle, and follows the exclusion rule. Thus, for  $\delta = \pm 1$  the rate  $p_x(\delta e_i, \widehat{\eta})$  at which the particle at site  $x$  moves to an *empty site*  $x + \delta e_i$ , letting  $e_1 = (1, 0)$ ,  $e_2 = (0, 1)$  be the canonical basis in  $Z^2$ , is given by

$$p_x(\delta e_i, \widehat{\eta}) = \begin{cases} 1 + \lambda \delta \cos(\theta_x)/N & \text{if } i = 1 \\ 1 + \lambda \delta \sin(\theta_x)/N & \text{if } i = 2 \end{cases},$$

where  $\lambda \in \mathbb{R}$  is a positive parameter which characterizes the strength of the asymmetry. For convenience, we will denote throughout the proof

$$\lambda_1(\theta) = \lambda \cos(\theta) \quad \text{and} \quad \lambda_2(\theta) = \lambda \sin(\theta). \quad (1.1)$$

The previous rates indicate that each particle has a bias in a direction given by its angle. If the target site is already occupied, the jump is canceled. Note that in order to see the symmetric and asymmetric contributions in the diffusive scaling limit, we must indeed choose an asymmetry scaling as  $1/N$ . Furthermore, in order for the system to exhibit a macroscopic behavior in the limit  $N \rightarrow \infty$ , we need to accelerate the whole exclusion process by  $N^2$ , as discussed further later on.

The second part of the dynamic is the spin update process, which will be from now on referred to as the *Glauber part of the dynamic*. A wide variety of choices is available among discontinuous angle dynamics (jump process) and continuous angle dynamics (diffusion). We choose here a Glauber jump process with inverse temperature  $\beta \geq 0$  described more precisely below. The generator of the complete Markov process is given by

$$L_N = N^2 \mathcal{L}^D + \mathcal{L}^G, \quad (1.2)$$

where

$$\mathcal{L}^D = \mathcal{L} + \frac{1}{N} \mathcal{L}^{\text{wa}} \quad (1.3)$$

is the generator for the displacement process (which two parts are defined below) and  $\mathcal{L}^G$  is the generator of the Glauber dynamics. The process can therefore be decomposed into three distinct parts, with different scalings in  $N$ , namely the symmetric part of the motion, with generator  $N^2 \mathcal{L}$ , the asymmetric contribution to the displacement generator  $N \mathcal{L}^{\text{wa}}$  with parameter  $\lambda \geq 0$ , and finally the spin-alignment with generator  $\mathcal{L}^G$  and inverse temperature  $\beta \geq 0$ , which are defined for any function  $f : \Sigma_N \rightarrow \mathbb{R}$ , by

$$\mathcal{L}f(\widehat{\eta}) = \sum_{x \in \mathbb{T}_N^2} \sum_{|z|=1} \eta_x (1 - \eta_{x+z}) (f(\widehat{\eta}^{x, x+z}) - f(\widehat{\eta})), \quad (1.4)$$

$$\mathcal{L}^{\text{wa}} f(\widehat{\eta}) = \sum_{x \in \mathbb{T}_N^2} \sum_{i=1,2, \delta=\pm 1} \delta \lambda_i(\theta_x) \eta_x (1 - \eta_{x+\delta e_i}) (f(\widehat{\eta}^{x, x+\delta e_i}) - f(\widehat{\eta})),$$

$$\mathcal{L}^G f(\widehat{\eta}) = \sum_{x \in \mathbb{T}_N^2} \eta_x \int_{\mathbb{S}} c_{x, \beta}(\theta, \widehat{\eta}) (f(\widehat{\eta}^{x, \theta}) - f(\widehat{\eta})) d\theta. \quad (1.5)$$

Note that  $\mathcal{L}^{\text{wa}}$  alone is not a Markov generator due to the negative jump rates, but considering the complete displacement generator  $\mathcal{L} + N^{-1}\mathcal{L}^{\text{wa}}$  solves this issue. In the expressions above, we denoted  $\widehat{\eta}^{x,x+z}$  the configuration where the occupation variables  $\widehat{\eta}_x$  and  $\widehat{\eta}_{x+z}$  at sites  $x$  and  $x+z$  have been exchanged in  $\widehat{\eta}$

$$\widehat{\eta}_y^{x,x+z} = \begin{cases} \widehat{\eta}_{x+z} & \text{if } y = x, \\ \widehat{\eta}_x & \text{if } y = x+z, \\ \widehat{\eta}_y & \text{otherwise,} \end{cases}$$

and  $\widehat{\eta}^{x,\theta}$  the configuration where the angle  $\theta_x$  in  $\widehat{\eta}$  has been updated to  $\theta$

$$\widehat{\eta}_y^{x,\theta} = \begin{cases} (\eta_y, \theta) & \text{if } y = x, \\ \widehat{\eta}_y & \text{otherwise.} \end{cases}$$

We choose for  $c_{x,\beta}$  the jump rates

$$c_{x,\beta}(\theta, \widehat{\eta}) = \frac{\exp\left(\beta \sum_{|z-x|=1} \eta_z \cos(\theta_z - \theta)\right)}{\int_{\mathbb{S}} \exp\left(\beta \sum_{|z-x|=1} \eta_z \cos(\theta_z - \theta')\right) d\theta'},$$

which tend to align the angle in  $x$  with the neighboring particles according to a Gibbs measure with inverse temperature  $\beta$ . Note that by construction, for any non-negative  $\beta$ ,  $\int_{\theta} c_{x,\beta}(\theta, \widehat{\eta}) d\theta = 1$  and that the jump rates  $c_{x,\beta}(\theta, \widehat{\eta})$  can be uniformly bounded from above and below by two positive constants depending only on  $\beta$ .

The process defined above will be referred to as Active Exclusion Process, shortened as AEP.

## 1.2 Measures associated to a smooth profile and definition of the Markov process

We now introduce the important measures and macroscopic quantities appearing in the expression of the hydrodynamic limit. Let us denote by  $\mathbb{T}^2$  the periodic domain in dimension 2,

$$\mathbb{T}^2 = [0, 1]^2.$$

**Definition 1.2** (Density profile on  $\mathbb{T}^2$ ). *We call density profile on the torus any function*

$$\widehat{\rho} : (u, d\theta) \mapsto \widehat{\rho}(u, d\theta)$$

such that

- for any  $u \in \mathbb{T}^2$ ,  $\widehat{\rho}(u, \cdot)$  is a positive measure on  $\mathbb{S}$ .
- For any  $u \in \mathbb{T}^2$ , the total mass  $\rho(u)$  of  $\widehat{\rho}(u, \cdot)$  is in  $[0, 1]$ .

For any density profile  $\widehat{\rho}$  on the torus,  $\widehat{\rho}(u, d\theta)$  represents the local density in  $u$  of particles with angle in  $d\theta$ , and  $\rho$  represents the total density of particles in  $u$ .

**Definition 1.3** (Measure associated to a density profile on the torus). *To any density profile on the torus  $\widehat{\rho}$ , we associate  $\mu_{\widehat{\rho}}^N$ , the product measure on  $\Sigma_N$  such that the law of  $\widehat{\eta}_x$  is given for any  $x \in \mathbb{T}_N^2$  by*

$$\begin{cases} \mu_{\widehat{\rho}}^N(\eta_x = 0) = 1 - \rho(x/N), \\ \mu_{\widehat{\rho}}^N(\eta_x = 1) = \rho(x/N), \\ \mu_{\widehat{\rho}}^N(\theta_x \in d\theta \mid \eta_x = 1) = \widehat{\rho}(x/N, d\theta)/\rho(x/N), \end{cases} \quad (1.6)$$

and such that  $\widehat{\eta}_x, \widehat{\eta}_y$  are independent as soon as  $x \neq y$ .

In other words, under  $\mu_{\widehat{\rho}}^N$  an occupied site in  $x \in \mathbb{T}_N^2$  has probability  $\rho(x/N) = \int_{[0;2\pi[} \widehat{\rho}(x/N, \theta) d\theta$ , the angle of an empty site is 0, and the angle of an occupied site  $x$  is distributed according to  $\widehat{\rho}(x/N, \cdot)$ .

**Definition of the process :** Let  $\Sigma_N^{[0,T]} := D([0, T], \Sigma_N)$  denote the space of right-continuous and left-limited (càdlàg) trajectories  $\widehat{\eta} : t \rightarrow \widehat{\eta}(t)$ . We will denote by  $\widehat{\eta}^{[0,T]}$  the elements of  $\Sigma_N^{[0,T]}$ . For any initial measure  $\nu$  on  $\mathbb{T}_N^2$ , any non-negative drift  $\lambda \geq 0$ , and any  $\beta \geq 0$ , we write  $\mathbb{P}_\nu^{\lambda, \beta}$  for the measure on  $\Sigma_N^{[0,T]}$  starting from the measure  $\widehat{\eta}(0) \sim \nu$ , and driven by the Markov generator  $L_N = L_N(\lambda, \beta)$  described earlier. We denote by  $\mathbb{E}_\nu^{\lambda, \beta}$  the expectation w.r.t.  $\mathbb{P}_\nu^{\lambda, \beta}$ . In the case  $\lambda = \beta = 0$ , there is no drift and the angle of the particles are chosen uniformly in  $\mathbb{S}$ . In this case, we will omit  $\lambda$  and  $\beta$  in the previous notation and write  $\mathbb{P}_\nu$  for the measure and  $\mathbb{E}_\nu$  for the corresponding expectation.

Let us now define the initial measure from which we start our process. Let  $\widehat{\zeta} \in C(\mathbb{T}^2 \times \mathbb{S})$  be a continuous function on  $\mathbb{T}^2 \times \mathbb{S}$ , which will define the initial macroscopic state of our particle system. We assume that for any  $u \in \mathbb{T}^2$ ,

$$0 < \zeta(u) := \int_{\mathbb{S}} \widehat{\zeta}(u, \theta) d\theta < 1, \quad (1.7)$$

i.e. that the initial density is less than one initially everywhere on  $\mathbb{T}^2$ , as well as for any  $\theta \in \mathbb{S}$ ,

$$\widehat{\zeta}(u, \theta) > 0. \quad (1.8)$$

We can now define the initial density profile on the torus  $\widehat{\rho}_0$  by

$$\widehat{\rho}_0(u, d\theta) = \widehat{\zeta}(u, \theta) d\theta. \quad (1.9)$$

We start our process from a random configuration

$$\widehat{\eta}(0) \sim \mu^N := \mu_{\widehat{\rho}_0}^N \quad (1.10)$$

fitting the profile  $\widehat{\rho}_0$ , according to Definition 1.3. Given this initial configuration, we define the Markov process  $\widehat{\eta}^{[0,T]} \in \Sigma_N^{[0,T]} \sim \mathbb{P}_{\mu^N}^{\lambda, \beta}$  driven by the generator  $L_N$  introduced in (1.2), starting from  $\mu^N$ .

**Topological setup :** Let us denote by  $\mathcal{M}(\mathbb{T}^2 \times \mathbb{S})$  the space of positive measures on the continuous configuration space, and

$$\mathcal{M}^{[0,T]} = D\left([0, T] \times \mathcal{M}(\mathbb{T}^2 \times \mathbb{S})\right) \quad (1.11)$$

the space of right-continuous and left-limited trajectories of measures on  $\mathbb{T}^2 \times \mathbb{S}$ . Each trajectory  $\widehat{\eta}^{[0,T]}$  of the process admits a natural image in  $\mathcal{M}^{[0,T]}$  through its empirical measure

$$\pi_t^N(\widehat{\eta}^{[0,T]}) = \frac{1}{N^2} \sum_{x \in \mathbb{T}_N^2} \eta_x(t) \delta_{(x/N, \theta_x(t))}.$$

We endow  $\mathcal{M}^{[0,T]}$  with Skorohod's metric defined in Appendix A.1, and the set  $\mathcal{P}(\mathcal{M}^{[0,T]})$  of probability measures on  $\mathcal{M}^{[0,T]}$  with the weak topology. We now define  $\mathcal{Q}^N \in \mathcal{P}(\mathcal{M}^{[0,T]})$  the law of the empirical measure  $\pi_t^N(\widehat{\eta}^{[0,T]})$  of our process  $\widehat{\eta}^{[0,T]} \sim \mathbb{P}_{\mu^N}^{\lambda, \beta}$ .

### 1.3 Hydrodynamic limit

**Self-diffusion coefficient :** In order to describe the hydrodynamic limit, we introduce *the self-diffusion coefficient* which will play a particular role in our model. To define it, consider the symmetric simple exclusion process on  $\mathbb{Z}^2$ , starting from equilibrium under the product measure  $\mu_\rho$  where each site except the origin is occupied with probability  $\rho \in [0, 1]$ . A tagged particle is placed initially at the origin. We keep track of the position  $X(t) = (X_1(t), X_2(t)) \in \mathbb{Z}^2$  of the tracer particle at time  $t$  and denote by  $\mathcal{Q}_\rho^*$  the measure of the process starting with measure  $\mu_\rho$  on  $\mathbb{Z}^2 \setminus \{0\}$  and a particle at the origin.

**Definition 1.4** (Self-Diffusion coefficient). *The self-diffusion coefficient  $d_s(\rho)$  is defined as the limiting variance of the tagged particle*

$$d_s(\rho) := \lim_{t \rightarrow \infty} \frac{\mathbb{E}_{\mathcal{Q}_\rho^*}(X_1(t)^2)}{t}.$$

The self-diffusion coefficient quantifies the capacity of the tagged particle to diffuse in an homogeneous medium. We summarize in appendix A.2 some useful results on the self-diffusion coefficient. For a more extensive study of the self-diffusion coefficient, see for example chapter 6 of [KLO12] for more details on the matter.

**Diffusion, conductivity and alignment coefficients :** Given a density profile on the torus  $\widehat{\rho}(u, d\theta)$ , recall from Definition 1.2 that  $\rho(u) = \int_{\mathbb{S}} \widehat{\rho}(u, d\theta)$  is the local density. We introduce the coefficients

$$\mathfrak{d}(\widehat{\rho}, \rho)(u, d\theta) = \frac{\widehat{\rho}(u, d\theta)}{\rho(u)} (1 - d_s(\rho(u))), \quad \mathfrak{s}(\widehat{\rho}, \rho)(u, d\theta) = (1 - \rho(u) - d_s(\rho(u))) \frac{\widehat{\rho}(u, d\theta)}{\rho(u)}, \quad (1.12)$$

where  $d_s$  is the self-diffusion coefficient described in the previous paragraph. We also define  $\vec{\Omega}(\widehat{\rho})$ , the vector representing the mean direction of the asymmetry under  $\widehat{\rho}$ ,

$$\vec{\Omega}(\widehat{\rho})(u) = \int_{\mathbb{S}} \widehat{\rho}(u, d\theta') \begin{pmatrix} \cos(\theta') \\ \sin(\theta') \end{pmatrix}.$$

as well as  $\Gamma(\widehat{\rho})$  the local creation rate of particles with angle  $\theta$

$$\Gamma(\widehat{\rho})(u, d\theta) = \widehat{\rho}(u, d\theta) \left[ \mathbb{E}_{\widehat{\rho}(u, \cdot)}(c_{x,\beta}(\theta, \widehat{\eta})) - 1 \right],$$

where under  $\mathbb{E}_{\widehat{\rho}(u, \cdot)}$ , each site is occupied independently w.p.  $\rho(u)$ , and the angle of each particle is chosen according to the probability law  $\widehat{\rho}(u, \cdot)/\rho(u)$ . The exact definition of  $\mathbb{E}_{\widehat{\rho}(u, \cdot)}$  is given just below in Definition 2.4.

**Weak solutions of the PDE :** In order to state the hydrodynamic limit of our system, we need to describe the notion of weak solutions in our context.

**Definition 1.5** (Weak solution of the differential equation). *Any trajectory of measures  $(\pi_t)_{t \in [0, T]} \in \mathcal{M}^{[0, T]}$  will be called a weak solution of the partial differential equation*

$$\partial_t \widehat{\rho}_t = \nabla \cdot [\mathfrak{d}(\widehat{\rho}_t, \rho_t) \nabla \rho_t + d_s(\rho_t) \nabla \widehat{\rho}_t] + 2\lambda \nabla \cdot \left[ \mathfrak{s}(\widehat{\rho}_t, \rho_t) \vec{\Omega}_t + \widehat{\rho}_t d_s(\rho_t) \begin{pmatrix} \cos(\theta) \\ \sin(\theta) \end{pmatrix} \right] + \Gamma(\widehat{\rho}_t) \quad \text{and} \quad \widehat{\rho}_0 = \widehat{\zeta}, \quad (1.13)$$

if the following four conditions are satisfied :

i)  $\pi_0(du, d\theta) = \widehat{\zeta}(u, \theta) du d\theta$

ii) for any fixed time  $t \in [0, T]$ , the measure  $\pi_t$  is absolutely continuous in space w.r.t. the Lebesgue measure on  $\mathbb{T}^2$ , i.e. there exists a density profile on the torus (in the sense of Definition 2.1)  $\widehat{\rho}_t$ , such that

$$\pi_t(du, d\theta) = \widehat{\rho}_t(u, d\theta) du$$

iii) Letting  $\rho_t(u) = \int_{\mathbb{S}} \widehat{\rho}_t(u, d\theta)$ ,  $\rho$  is in  $H^1([0, T] \times \mathbb{T}^2)$ , i.e. there exists a family of functions  $\partial_{u_i} \rho_t$  in  $L^1([0, T] \times \mathbb{T}^2)$  such that for any smooth function  $G \in C^{0,1}([0, T] \times \mathbb{T}^2)$ ,

$$\int_{[0, T] \times \mathbb{T}^2} \rho_t(u) \partial_{u_i} G_t(u) dt du = - \int_{[0, T] \times \mathbb{T}^2} G_t(u) \partial_{u_i} \rho_t(u) dt du$$

iv) For any function  $H \in C^{1,2,1}([0, T] \times \mathbb{T}^2 \times \mathbb{S})$ ,

$$\begin{aligned} \langle \pi_T, H_T \rangle - \langle \pi_0, H_0 \rangle &= \int_0^T \langle \pi_t, \partial_t H_t \rangle dt \\ &- \int_0^T \int_{\mathbb{T}^2 \times \mathbb{S}} \left[ \sum_{i=1}^2 \left( \partial_{u_i} H_t(u, \theta) [\mathfrak{d}(\widehat{\rho}_t, \rho_t) - d'_s(\rho_t) \widehat{\rho}_t](u, d\theta) \partial_{u_i} \rho_t(u) - \partial_{u_i}^2 H_t(u, \theta) d_s(\rho_t) \widehat{\rho}_t(u, d\theta) \right. \right. \\ &\quad \left. \left. + \partial_{u_i} H_t(u, \theta) \left[ 2\lambda \mathfrak{s}(\widehat{\rho}_t, \rho_t) \vec{\Omega}_t + 2\lambda_i(\theta) d_s(\rho_t) \widehat{\rho}_t \right](u, d\theta) \right) - H_t(u, \theta) \Gamma(\widehat{\rho}_t)(u, d\theta) \right] du dt, \end{aligned}$$

where the various coefficients are those defined just before, and the functions  $\lambda_i$  are defined in (1.1).

Note that in this Definition, the only quantity required to be in  $H^1$  is the total density  $\rho$  : indeed, the term  $d_s(\rho_t) \nabla \widehat{\rho}_t$  is rewritten as

$$d_s(\rho_t) \nabla \widehat{\rho}_t = \nabla(d_s(\rho_t) \widehat{\rho}_t) - d'_s(\rho_t) \widehat{\rho}_t \nabla \rho_t,$$

and the first term in the right-hand side above allows another derivative to be applied to the test function  $H$ , whereas the second term only involves the derivative of  $\rho$  as wanted.

We are now ready to state our main theorem :

**Theorem 1.6.** *The sequence  $(Q^N)_{N \in \mathbb{N}}$  defined at the end of Section 1.2 is weakly relatively compact, and any of its limit points  $Q^*$  is concentrated on trajectories  $(\pi_t)_{t \in [0, T]}$  which are weak solution of equation (1.13) in the sense of Definition 1.5.*

**Remark 1.7** (Uniqueness of the weak solutions of equation (1.13)). *One of the reasons for our weak formulation of the scaling limit of the Active Exclusion Process is the lack of proof for the uniqueness of weak solutions of equation (1.13). Several features of equation (1.13) make the uniqueness difficult to obtain : First, our differential equation does not really take the form of an autonomous differential equation : the variation of  $\widehat{\rho}_t(u, \theta)$  involves the total density  $\rho$ , therefore the differential equation is in fact a differential system operating on the vector  $(\widehat{\rho}_t(u, \theta), \rho_t(u))$ . Cross-diffusive systems can exhibit pathological behavior when the diffusion matrix has negative eigenvalues, but in our case, both eigenvalues are non-negative and this issue does not appear.*

*However, although cross-diffusive systems are quite well understood (cf. for example [Ama93]), our equation involves a drift term which factors in via the vector  $\vec{\Omega}(\widehat{\rho}_t)$  the whole profile  $(\widehat{\rho}_t(u, \theta))_{\theta \in [0, 2\pi]}$ . One of the consequences of this drift term, which is the main obstacle to prove uniqueness, is that even the uniqueness of the total density  $\rho_t(u)$  is not well established. Indeed, contrary to [Qua92], in which the total density evolves according to the heat equation, the total density in our case is driven by the Burgers-like equation*

$$\partial_t \rho_t(u) = \Delta \rho_t(u) + \nabla \cdot (m_t(u)(1 - \rho_t(u)))$$

*where  $m$  is a quantity which depends on the whole profile  $(\widehat{\rho}_t(u, \theta))_{\theta \in [0, 2\pi]}$ , and for which uniqueness is hard to obtain.*

## 1.4 Instantaneous currents and outline of the proof

In order to get a grasp on the delicate points of the proof, and to introduce the particle currents on which rely the proof of Theorem 1.6, we need a few more notations.

Throughout the proof, for any function  $\varphi : \Sigma_N \rightarrow \mathbb{R}$  and  $x \in \mathbb{T}_N^2$ , we will denote by  $\tau_x \varphi : \Sigma_N \rightarrow \mathbb{R}$  the function which associates to a configuration  $\widehat{\eta}$  the value  $\varphi(\tau_{-x} \widehat{\eta})$ , where  $\tau_{-x} \widehat{\eta}$  is the translation of the configuration  $\widehat{\eta}$  by a vector  $-x$ .

For any function

$$H : [0, T] \times \mathbb{T}^2 \times \mathbb{S} \rightarrow \mathbb{R} \\ (t, u, \theta) \mapsto H_t(u, \theta) ,$$

and any measure  $\pi$  on  $\mathbb{T}^2 \times \mathbb{S}$ , let us denote

$$\langle \pi, H_t \rangle = \int_{\mathbb{T}^2 \times \mathbb{S}} H_t(u, \theta) d\pi(u, \theta)$$

the integral of  $H$  with respect to the measure  $\pi$ . We consider the martingale  $M_t^{H, N}$

$$M_t^{H, N} = \langle \pi_t^N, H_t \rangle - \langle \pi_0^N, H_0 \rangle - \int_0^t (\partial_s + L_N) \langle \pi_s^N, H_s \rangle ds, \quad (1.14)$$

where  $\pi_s^N$  is the empirical measure of the process

$$\pi_s^N = \frac{1}{N^2} \sum_{x \in \mathbb{T}_N^2} \eta_x(s) \delta_{(x/N, \theta_x(s))}.$$



It is well known that the quadratic variation of this martingale is of order  $O(N^{-2})$  (cf. Appendix 1.5 of [KL99]) and therefore vanishes as  $N$  goes to infinity. The martingale thus vanishes uniformly in time, in probability under  $\mathbb{P}_{\mu^{\lambda,\beta}}^N$ . Now let us recall that

$$L_N = N^2 (\mathcal{L} + N^{-1} \mathcal{L}^{\text{WA}}) + \mathcal{L}^G,$$

and that  $\tau_x$  represents the translation of a function by  $x$ . Assume that the function  $H$  takes the form

$$H_s(x, \theta) = G_s(x) \omega(\theta), \quad (1.15)$$

where  $G$  and  $\omega$  are respectively functions on  $[0, T] \times \mathbb{T}^2$  and  $\mathbb{S}$ . From now on, for any function  $\Phi : \mathbb{S} \rightarrow \mathbb{R}$ , any configuration  $\widehat{\eta}$  and any  $x \in \mathbb{T}_N^2$  we will shorten

$$\eta_x^\Phi = \Phi(\theta_x) \eta_x.$$

With these notations, we can write the generator part of the integral term of (1.14) as

$$\int_0^T L_N \langle \pi_s^N, H_s \rangle ds = \frac{1}{N^2} \int_0^T \sum_{x \in \mathbb{T}_N^2} G_s(x/N) (N^2 [\mathcal{L} \eta_x^\omega(s) + N^{-1} \mathcal{L}^{\text{WA}} \eta_x^\omega(s)] + \mathcal{L}^G \eta_x^\omega(s)) ds. \quad (1.16)$$

Let us introduce accordingly the three instantaneous currents in our active exclusion process (AEP).

**Definition 1.8.** *Given a site  $x \in \mathbb{T}_N^2$ , each part of the generator  $L_N$ 's action over  $\eta_x^\omega$  can be written*

$$\mathcal{L} \eta_x^\omega = \sum_{i=1}^2 (\tau_{x-e_i} j_i^\omega - \tau_x j_i^\omega) \quad \text{with} \quad j_i^\omega(\widehat{\eta}) = \eta_0^\omega (1 - \eta_{e_i}) - \eta_{e_i}^\omega (1 - \eta_0), \quad (1.17)$$

$$\mathcal{L}^{\text{WA}} \eta_x^\omega = \sum_{i=1}^2 (\tau_{x-e_i} r_i^\omega - \tau_x r_i^\omega) \quad \text{with} \quad r_i^\omega(\widehat{\eta}) = \eta_0^{\omega \lambda_i} (1 - \eta_{e_1}) + \eta_{e_i}^{\omega \lambda_i} (1 - \eta_0), \quad (1.18)$$

and

$$\mathcal{L}^G \eta_x^\omega = \tau_x \gamma^\omega \quad \text{with} \quad \gamma^\omega(\widehat{\eta}) = \int_{\mathbb{S}} c_{0,\beta}(\theta, \widehat{\eta}) (\omega(\theta) - \omega(\theta_0)) d\theta. \quad (1.19)$$

For  $e_i \in \{1, i\}$  we will at times write  $j_{x, x+e_i}^\omega = \tau_x j_i^\omega$  (resp.  $r_{x, x+e_i}^\omega = \tau_x r_i^\omega$ ), which is interpreted as the instantaneous current with intensity  $\omega$  in the direction  $i$  along the edge  $(x, x + e_i)$  of the symmetric (resp. weakly asymmetric) part of the process. The last quantity  $\tau_x \gamma^\omega$  is the local alignment rate.

When considering the time process  $(\widehat{\eta}(t))_{t \in [0, T]}$  we will, for the sake of concision, write  $j_i^\omega(t)$  for  $j_i^\omega(\widehat{\eta}(t))$ , and in the same fashion  $r_i^\omega(t)$  instead of  $r_i^\omega(\widehat{\eta}(t))$ , and  $\gamma^\omega(t)$  instead of  $\gamma^\omega(\widehat{\eta}(t))$ .

Finally, in the case where  $\omega \equiv 1$ , we will denote by

$$j_i := j_i^1 = \eta_0 - \eta_{e_i}.$$

Performing a first integration by parts on the exclusion part of the right-hand side of (1.16), we obtain thanks to equations (1.17), (1.18) and (1.19)

$$\int_0^T L_N \langle \pi_s^N, H_s \rangle ds = \frac{1}{N^2} \int_0^T \sum_{x \in \mathbb{T}_N^2} \tau_x \left[ \sum_{i=1}^2 (N j_i^\omega(s) + r_i^\omega(s)) \partial_{u_i, N} G_s(x/N) + G_s(x/N) \gamma^\omega(s) \right] ds, \quad (1.20)$$

where  $\partial_{u_i, N}$  is the discrete partial derivative

$$(\partial_{u_i, N} G)(x/N) = N [G((x + e_i)/N) - G(x/N)].$$

The spatial averaging is of great importance throughout the proof of the hydrodynamic limit, we need some convenient notation to represent this operation. For any site  $x \in \mathbb{T}_N^2$  and any integer  $l$ , we denote by

$$B_l(x) = \{ y \in \mathbb{T}_N^2, \quad \|y - x\|_\infty \leq l \}$$

the box of side length  $2l + 1$  around  $x$ . In the case where  $x = 0$  is the origin, we will simply write  $B_l := B_l(0)$ . For any *finite* subset  $B \subset \mathbb{T}_N^2$ , we will denote  $|B|$  the number of sites in  $B$ . Given  $\varphi$  a function on  $\Sigma_N$ , we denote by

$$\langle \varphi \rangle_x^l = \frac{1}{|B_l(x)|} \sum_{y \in B_l(x)} \tau_y \varphi \quad (1.21)$$

the average of the function  $\varphi$  over  $B_l(x)$ . In the case where  $\varphi(\bar{\eta}) = \eta_0^\omega$ , (resp.  $\varphi(\bar{\eta}) = \eta_0$ ), we will write  $\tau_x \rho_l^\omega = \langle \varphi \rangle_x^l$  (resp.  $\tau_x \rho_l$ ) for the empirical average of  $\eta^\omega$  (resp.  $\eta$ ) over the box centered in  $x$  of side length  $2l + 1$ .

We will also denote for any integer  $l$  by  $\widehat{\rho}_l$  the empirical angle measure defined by

$$\widehat{\rho}_l = \frac{1}{|B_l|} \sum_{x \in B_l} \eta_x \delta_{\theta_x} \in \mathcal{M}_1(\mathbb{S}), \quad (1.22)$$

where  $\mathcal{M}_1(\mathbb{S})$  is the set of non-negative measures on  $\mathbb{S}$  with total mass in  $[0, 1]$  (cf. Definition 2.1 below).

Finally, to simplify notations throughout the proof, we will write  $\varepsilon N$  instead of the integer part  $\lfloor \varepsilon N \rfloor$ .

Now that the notations are settled, let us give a brief outline of the proof.

Section 2 has three distinct parts. The first part, Section 2.1, is dedicated to establishing the properties of the canonical and grand canonical measures of the process, we investigate in Appendix B some of their elementary properties. These measures play a crucial role in the proof of the hydrodynamic limit and take an unusual form in our case. The second part 2.2 is focused on the control of the entropy of the process w.r.t. a reference product measure, which proves local equilibrium. Finally, In Section 2.3, we prove that the density is bounded away from 1, which is necessary since ergodicity no longer holds at density 1.

The first important step is the introduction of a macroscopic spatial average in the right-hand side of equation (1.16), in order to replace the various microscopic currents by functions of the empirical density. This is done in the Replacement Lemma 3.1 stated in Section 3.1, following the usual strategy (e.g. see Lemma 1.10, p.77 of [KL99]). The proof in our case, however, requires some technical adjustments, due to the particular nature of the canonical and grand-canonical measures of the process.

As we already pointed out, our system is non-gradient, which means that  $j_i^\omega$  is not a discrete gradient (i.e. cannot be expressed as  $\tau_{e_i} h - h$  for some cylinder function  $h$ ). Before using the replacement Lemma 3.1, one therefore has to balance out the extra factors  $N$  appearing in the velocity of the exclusion process. One of the main difficulties in the proof of the hydrodynamic limit for our system is therefore to replace in the spatial average above  $N j_i^\omega(s)$  by a gradient quantity.

We achieve this goal in Section 5, following the strategy developed by Varadhan [Var94a] and Quastel [Qua92]. Before that, we present in Section 4 the preliminary results needed to obtain the non-gradient estimates. The presence of the weak drift in a non-gradient system poses some extra difficulties, which we will resolve in Section 5.9 following an idea presented in [BFG13] and [QRV99].

All of these results come together in Section 6, in which we prove the hydrodynamic limit and conclude the proof of Theorem 1.6. The non-gradient nature of the diffusive part, however poses some technical difficulties to perform the second integration by parts, therefore some extra work is needed to complete the proof.

## 2 Canonical measures, entropy and irreducibility

### 2.1 Definition of the canonical measures

Due to the presence of angles, the canonical product measures for the AEP are not parameterized by the local density  $\alpha \in [0, 1]$  like the SSEP, but rather by a measure  $\widehat{\alpha}$  on  $[0, 2\pi]$  whose total mass  $\int_{\mathbb{S}} \widehat{\alpha}(d\theta)$  is the local density.

**Definition 2.1** (Angle profile). Recall that  $\mathbb{T}^2$  is the 2-dimensional continuous torus  $(\mathbb{R}/\mathbb{Z})^2$ , and let  $\mathcal{M}(\mathbb{S})$  be the set of non-negative measures on  $\mathbb{S}$ . We will call angle measure any measure  $\widehat{\alpha} \in \mathcal{M}(\mathbb{S})$  with total mass  $\alpha := \int_{\mathbb{S}} \widehat{\alpha}(d\theta) \leq 1$ . We denote by

$$\mathcal{M}_1(\mathbb{S}) = \{ \widehat{\alpha} \in \mathcal{M}(\mathbb{S}), \quad \alpha \in [0, 1] \}, \quad (2.1)$$

the set of angle measures.

We now define a topological setup on  $\mathcal{M}_1(\mathbb{S})$ . Let us consider on  $C^1(\mathbb{S})$ , the set of differentiable functions, the norm  $\|g\|^* = \max(\|g\|_\infty, \|g'\|_\infty)$ , and let  $B^*$  be the unit ball in  $(C^1(\mathbb{S}), \|\cdot\|^*)$ .

**Definition 2.2.** We endow  $\mathcal{M}(\mathbb{S})$ , the vector space of finite mass signed measures on  $\mathbb{S}$ , with the norm

$$\|\widehat{\alpha}\| = \sup_{g \in B^*} \left\{ \int_{\mathbb{S}} g(\theta) d\widehat{\alpha}(\theta) \right\},$$

and with the corresponding distance

$$d(\widehat{\alpha}, \widehat{\alpha}') := \sup_{g \in B^*} \left\{ \int_{\mathbb{S}} g(\theta) d\widehat{\alpha}(\theta) - \int_{\mathbb{S}} g(\theta) d\widehat{\alpha}'(\theta) \right\}.$$

We then endow  $\mathcal{M}_1(\mathbb{S})$  with the topology induced by  $\|\cdot\|$ . This distance is in fact a generalization of the Wasserstein distance to measures which are not probability measures.

**Remark 2.3.** This topology is the simplest to verify that

- for any cylinder function  $\psi$ , the application  $\widehat{\alpha} \mapsto \mathbb{E}_{\widehat{\alpha}}(\psi)$  is Lipschitz-continuous (cf. Proposition [B.2](#)).
- any continuous profile  $\widehat{\alpha}$  is the limit of combinations of Dirac measures.
- if  $\theta_k \rightarrow \theta$ , then  $\|\delta_{\theta_k} - \delta_\theta\| \rightarrow 0$ .

It is therefore the natural choice for our problem. For example, the last condition would not be verified by the weak topology on  $\mathbb{S}$ , since for any  $\theta \neq \theta'$ , one can find a continuous function  $g$  such that  $g(\theta) = 0$  and  $g(\theta') = 1$ .

We now introduce the canonical measures of our process, which are translation-invariant particular cases of measures associated to a density profile, introduced in Definition [1.3](#).

**Definition 2.4** (Grand canonical measures). Consider a translation invariant density profile on the torus  $\widehat{\rho}$ , i.e. such that for any  $u \in \mathbb{T}^2$ ,

$$\widehat{\rho}(u, d\theta) = \widehat{\alpha}(d\theta)$$

for some angle measure  $\widehat{\alpha} \in \mathcal{M}_1(\mathbb{S})$  independent of  $u$ . We will write  $\mu_{\widehat{\alpha}}$  for the product measure  $\mu_{\widehat{\rho}}^N$ , and  $\mathbb{E}_{\widehat{\alpha}}$  will denote the corresponding expectation. This class of measures will be referred to as grand canonical measures. Furthermore, for any  $\alpha \in [0, 1]$ , the measure  $\mu_{\widehat{\alpha}}$  associated with the uniform density profile on the torus

$$\widehat{\rho}(u, d\theta) \equiv \alpha d\theta/2\pi,$$

where the angle of each particle is chosen uniformly in  $\mathbb{S}$ , will be denoted by  $\mu_{\alpha}^*$ , and the corresponding expectation will be denoted by  $\mathbb{E}_{\alpha}^*$ .

Note that these measures are dependent on  $N$ , but due to their translation invariant nature, we will omit this dependency in our notation.

**Remark 2.5.** For any density  $\alpha \in [0, 1]$ , the measure  $\mu_{\alpha}^*$  on  $\Sigma_N$  is not invariant for our dynamic, because although it is invariant for the symmetric part of the exclusion, the weakly asymmetric part (as well as the Glauber part as soon as  $\beta \neq 0$ ) breaks this property. We will however prove in Section 2.2 that due to the scaling in  $N$ , the stationary measure of our dynamics is locally close to a product measure  $\mu_{\alpha}^*$ .

**Definition 2.6** (Canonical measures). Consider  $l \in \mathbb{N}^*$  and let  $K$  be an integer bounded up by  $(2l+1)^2$  and  $\Theta_K = \{\theta_1, \dots, \theta_K\}$  an orderless family of angles, we shorten by  $\widehat{K}$  the pair  $(K, \Theta_K)$ . We will denote by  $\mathbb{K}_l$  the set of all possible  $\widehat{K}$ ,

$$\mathbb{K}_l = \{\widehat{K} = (K, \Theta_K), K \leq (2l+1)^2\}.$$

Since our process is not irreducible when there is only one or less empty site (Cf Section 2.3 below), we also introduce

$$\widetilde{\mathbb{K}}_l = \{\widehat{K} \in \mathbb{K}_l, K \leq (2l+1)^2 - 2\}, \quad (2.2)$$

the set of  $\widehat{K}$  for which the exclusion process on  $B_l$  is irreducible. Furthermore, for any fixed  $\widehat{K} \in \mathbb{K}_l$ , we denote by

$$\Sigma_l^{\widehat{K}} = \left\{ \widehat{\eta} \in \Sigma_N, \sum_{x \in B_l} \eta_x \delta_{\theta_x} = \sum_{k=1}^K \delta_{\theta_k} \right\}, \quad (2.3)$$

the set of configurations with  $K$  particles of angles  $\Theta_K$  in  $B_l$ .

Let  $\mu_{\alpha, l}^*$  denote the measure  $\mu_{\alpha}^*$  on  $B_l$ , for any density  $\alpha \in ]0, 1[$ , we will denote by  $\mu_{l, \widehat{K}}$  the conditioning of  $\mu_{\alpha, l}^*$  to  $\Sigma_l^{\widehat{K}}$ , and by  $\mathbb{E}_{l, \widehat{K}}$  the corresponding expectation

$$\mathbb{E}_{l, \widehat{K}}(g) = \mathbb{E}_{\alpha, l}^* \left( g \mid \widehat{\eta} \in \Sigma_l^{\widehat{K}} \right).$$

These measures will be referred to as canonical measures of the process.

**Definition 2.7.** Fix  $l \in \mathbb{N}$ , we associate to any  $\widehat{K} \in \mathbb{K}_l$  the angle measure

$$\widehat{\alpha}_{\widehat{K}, l} = \frac{1}{(2l+1)^2} \sum_{k=1}^K \delta_{\theta_k}.$$

When there is no ambiguity, we will drop the dependency in  $l$  and simply write  $\widehat{\alpha}_{\widehat{K}} = \widehat{\alpha}_{\widehat{K}, l}$ .

Several results regarding the metric space  $(\mathcal{M}_1(\mathbb{S}), \|\cdot\|)$  are stated in Appendix B : The equivalence of ensembles is briefly proved in Section B.1, the Lipschitz-continuity of the expectation w.r.t.  $\mu_{\widehat{\alpha}}$  in the parameter  $\widehat{\alpha}$  is proven in Section B.2, and finally, the compactness of the set  $(\mathcal{M}_1(\mathbb{S}), \|\cdot\|)$  is proved in Section B.3.

## 2.2 Entropy production and local equilibrium

The proof of the replacement Lemma is based on the control of the entropy production of the process. The difficulty here is that the invariant measures of the process are not known, and the decay of the relative entropy w.r.t. these measures cannot be computed directly. Thus we consider approximations of these measures, and for a fixed non-trivial density  $\alpha \in ]0, 1[$ , our goal is to get an estimate of the entropy of the process's time average with respect to the reference measure  $\mu_{\alpha}^*$  introduced in Definition 2.4.

Let us fix  $\alpha \in ]0, 1[$ , we are going to prove that regardless of the initial density profile, the entropy of the AEP w.r.t the measure of a process started from  $\mu_{\alpha}^*$  and following a symmetric simple exclusion process can be controlled by  $CN^2$  for some constant  $C$ .

The choice of  $\mu_{\alpha}^*$  among the  $\mu_{\alpha'}^*$ ,  $\alpha' \in ]0, 1[$  is not important, since for any different angle density  $\alpha' \in ]0, 1[$ , the relative entropy between the two product measures  $\mu_{\alpha}^*$  and  $\mu_{\alpha'}^*$  is of order  $N^2$  as well.

For some cylinder function  $h \in \mathcal{C}$ , and some edge  $a = (a_1, a_2)$ , we denote by  $\nabla_a$  the gradient representing the transfer of a particle from site  $a_1$  to site  $a_2$  under the exclusion process

$$\nabla_a f(\widehat{\eta}) = \eta_{a_1} (1 - \eta_{a_2}) (f(\widehat{\eta}^{a_1, a_2}) - f(\widehat{\eta})). \quad (2.4)$$

We will shorten this notation in the case where  $a = (0, e_j)$  by writing  $\nabla_j := \nabla_{(0, e_j)}$ . Before turning to the control of the entropy itself, we introduce an important quantity in the context of hydrodynamic limits.

**Definition 2.8** (Dirichlet form of the symmetric dynamics). *Let  $h$  be a cylinder function, we introduce the Dirichlet form of the process*

$$\mathcal{D}_{\widehat{\alpha}}(h) = -\mathbb{E}_{\widehat{\alpha}}(h\mathcal{L}h), \quad (2.5)$$

where  $\mathcal{L}$  is the symmetric exclusion generator defined in equation (1.4). It can be rewritten thanks to the invariance of  $\mu_{\widehat{\alpha}}$  w.r.t the symmetric exclusion process as

$$\mathcal{D}_{\widehat{\alpha}}(h) = \frac{1}{2} \mathbb{E}_{\widehat{\alpha}} \left( \sum_{x \in \mathbb{T}_N^2} \sum_{|z|=1} (\nabla_{x, x+z} h)^2 \right).$$

If there is no ambiguity, we will omit the dependency in  $\widehat{\alpha}$  of the Dirichlet form, and simply denote it by  $\mathcal{D}$ . The Dirichlet form is convex and non-negative. Furthermore, any function  $f$  in its kernel is such that  $f(\widehat{\eta}) = f(\widehat{\eta}')$  for any pair  $(\widehat{\eta}, \widehat{\eta}')$  of configurations with the same number of particles  $K \leq N^2 - 1$  and the same family of angles. We also introduce the Dirichlet form

$$D(h) = \mathcal{D}(\sqrt{h}), \quad (2.6)$$

which has the same properties as  $\mathcal{D}$ .

We now investigate the entropy production of the AEP. Let  $P_t^{N,\lambda,\beta}$  be the semi-group of the AEP associated to the complete generator  $L_N$  introduced in equation (1.2), and  $\mu_t^N = \mu^N P_t^{N,\lambda,\beta}$  the measure of the configuration at time  $t$ . Thanks to the two assumptions (1.7) and (1.8),  $\mu^N$  is absolutely continuous with respect to the product measure  $\mu_\alpha^*$ . This, and the fact that the alignment rates  $c_{x,\beta}$  are bounded from above and below uniformly in  $\theta$ , guarantee that for any time  $t$ ,  $\mu_t^N$  is also absolutely continuous w.r.t.  $\mu_\alpha^*$ . We therefore denote by  $f_t^N = d\mu_t^N/d\mu_\alpha^*$  the density of the measure at time  $t$  w.r.t. the reference measure  $\mu_\alpha^*$ . We now prove the following estimate on the entropy of the function  $f_t^N$ .

**Proposition 2.9** (Control on the entropy and the Dirichlet form of  $f_t^N$ ). *For any density  $f$  w.r.t.  $\mu_\alpha^*$ , we denote by  $H(f) = \mathbb{E}_\alpha^*(f \log f)$  the entropy of the density  $f$ . Then, for any time  $t > 0$ , there exists a constant  $K_0 = K_0(t, \lambda, \beta, \zeta)$  such that*

$$H\left(\frac{1}{t} \int_0^t f_s^N ds\right) \leq K_0 N^2 \quad \text{and} \quad D\left(\frac{1}{t} \int_0^t f_s^N ds\right) \leq K_0.$$

*Proof of Proposition 2.9 :* The density  $f_t^N$  is solution to

$$\begin{cases} \partial_t f_t^N = L_N^* f_t^N \\ f_0^N = d\mu^N/d\mu_\alpha^*, \end{cases} \quad (2.7)$$

where  $L_N^*$  is the adjoint of  $L_N$  in  $L^2(\mu_\alpha^*)$ . To clarify the proof, we divide it in a series of steps.

**Expression of the entropy production of the system :** The relative entropy of  $\mu_t^N$  with respect to the reference measure  $\mu_\alpha^*$  is given by

$$H(\mu_t^N | \mu_\alpha^*) = H(f_t^N) = \mathbb{E}_\alpha^*(f_t^N \log f_t^N),$$

which is non-negative due to the convexity on  $[0, +\infty[$  of  $x \mapsto x \log x$ . According to equation (2.7), its time derivative is

$$\partial_t H(f_t^N) = \mathbb{E}_\alpha^*(\log f_t^N L_N^* f_t^N) + \mathbb{E}_\alpha^*(L_N^* f_t^N). \quad (2.8)$$

The second term on the right-hand side is equal to

$$\mathbb{E}_\alpha^*(L_N^* f_t^N) = \mathbb{E}_\alpha^*(f_t^N L_N \mathbf{1}) = 0,$$

since all constant functions are in the kernel of  $L_N$ . Equation (2.8) can be rewritten, since  $L_N^*$  is the adjoint of  $L_N$  in  $L^2(\mu_\alpha^*)$ , as

$$\partial_t H(f_t^N) = \mathbb{E}_\alpha^*(f_t^N L_N \log f_t^N).$$

Now thanks to the elementary inequality

$$\log b - \log a \leq \frac{2}{\sqrt{a}}(\sqrt{b} - \sqrt{a}),$$

we can control  $L_N \log f_t^N$  by

$$\frac{2}{\sqrt{f_t^N}} L_N \sqrt{f_t^N},$$

therefore, the definition of  $L_N$  yields

$$\partial_t H(f_t^N) \leq -2N^2 D(f_t^N) + 2N \mathbb{E}_\alpha^* \left( \sqrt{f_t^N} \mathcal{L}^{\text{WA}} \sqrt{f_t^N} \right) + 2 \mathbb{E}_\alpha^* \left( \sqrt{f_t^N} \mathcal{L}^{\text{G}} \sqrt{f_t^N} \right),$$

where  $D$  is the Dirichlet form defined in Definition 2.8.

Integrating between the times 0 and  $t$ , we get

$$H(\mu_t^N | \mu_\alpha^*) + 2N^2 \int_0^t D(f_s^N) \leq H(\mu^N | \mu_\alpha^*) + 2 \int_0^t \mathbb{E}_\alpha^* \left( \sqrt{f_s^N} (N \mathcal{L}^{\text{WA}} + \mathcal{L}^{\text{G}}) \sqrt{f_s^N} \right) ds \quad (2.9)$$

Since the Dirichlet form of the symmetric exclusion process is non-negative, we now focus on showing that the part of the entropy due to the weakly asymmetric part and Glauber part do not grow too much in  $N$ , in order to get an upper bound on the Dirichlet form  $D(f)$  and on the entropy  $H(\mu_t^N | \mu_\alpha^*)$ . From here, control over the initial relative entropy should suffice to ensure that the measure of the AEP remains close to a product measure.

**Bound on the entropy production of the asymmetric part of the dynamics :** by definition of the asymmetric dynamic,

$$\mathbb{E}_\alpha^* \left( \sqrt{f_s^N} \mathcal{L}^{\text{WA}} \sqrt{f_s^N} \right) = \mathbb{E}_\alpha^* \left( \sum_{x,i,\delta=\pm 1} \lambda_i(\theta_x) \delta \eta_x (1 - \eta_{\delta e_i}) \sqrt{f_s^N}(\bar{\eta}) \left( \sqrt{f_s^N}(\bar{\eta}^{x,x+\delta e_i}) - \sqrt{f_s^N}(\bar{\eta}) \right) \right).$$

Despite the extra factor  $N$ , the jump rates of the weakly asymmetric dynamics are not very different from symmetric exclusion process jump rates, which allows us to estimate the quantity above in terms of the Dirichlet form. More precisely, thanks to the elementary inequality

$$\mathbb{E}(\varphi\psi) \leq \gamma \mathbb{E}(\varphi^2)/2 + \mathbb{E}(\psi^2)/2\gamma$$

which holds for any positive constant  $\gamma$ , we can write with

$$\varphi = \eta_x (1 - \eta_{\delta e_i}) \left( \sqrt{f_s^N}(\bar{\eta}^{x,x+\delta e_i}) - \sqrt{f_s^N}(\bar{\eta}) \right),$$

and

$$\psi = \lambda(\theta_x) \delta \sqrt{f_s^N}(\bar{\eta})$$

that

$$\mathbb{E}_\alpha^* \left( \sqrt{f_s^N} \mathcal{L}^{\text{WA}} \sqrt{f_s^N} \right) \leq \sum_{x,i,\delta=\pm 1} \left[ \frac{\mathbb{E}_\alpha^* \left( \lambda(\theta_x)^2 f_s^N \right)}{2\gamma} + \frac{\gamma}{2} \mathbb{E}_\alpha^* \left( \eta_x (1 - \eta_{\delta e_i}) \left( \sqrt{f_s^N}(\bar{\eta}^{x,x+\delta e_i}) - \sqrt{f_s^N}(\bar{\eta}) \right)^2 \right) \right].$$

In right-hand side above, letting  $C_\lambda = 4\lambda^2$  the first term can be bounded by  $C_\lambda N^2/2\gamma$ , since the number of terms in the sum is  $4N^2$ , whereas the second sum of terms is  $\gamma D(f_s^N)$ . We then let  $\gamma = N$  to obtain the upper bound

$$2N \mathbb{E}_\alpha^* \left( \sqrt{f_s^N} \mathcal{L}^{\text{WA}} \sqrt{f_s^N} \right) \leq C_\lambda N^2 + N^2 D(f_s^N). \quad (2.10)$$



**Bound on the entropy production of the Glauber part of the dynamics :** thanks to the elementary inequality  $ab \leq (a^2 + b^2)/2$ , and since the jump rates  $c_{x,\beta}$  are less than  $e^{8\beta}/2\pi$ , and  $\eta_x$  by 1

$$\begin{aligned} \mathbb{E}_\alpha^* \left( \sqrt{f_s^N} \mathcal{L}^G \sqrt{f_s^N} \right) &= \mathbb{E}_\alpha^* \left( \sqrt{f_s^N} \sum_{x \in \mathbb{T}_N^2} \eta_x \int_{\mathbb{S}} c_{x,\beta}(\theta, \widehat{\eta}) \left( \sqrt{f_s^N}(\widehat{\eta}^{x,\theta}) - \sqrt{f_s^N}(\widehat{\eta}) \right) d\theta \right) \\ &\leq \frac{e^{8\beta}}{2\pi} \sum_{x \in \mathbb{T}_N^2} \mathbb{E}_\alpha^* \left( \frac{1}{2} \int_{\mathbb{S}} f_s^N(\widehat{\eta}^{x,\theta}) d\theta + \frac{3}{2} f_s^N(\widehat{\eta}) \right). \end{aligned}$$

Since  $\mathbb{E}_\alpha^* \left( \int_{\mathbb{S}} f_s^N(\widehat{\eta}^{x,\theta}) d\theta \right) = \mathbb{E}_\alpha^* (f_s^N)$ , the expectation can be bounded from above by 2, and we can therefore write, letting  $C_\beta = 2e^{8\beta}/\pi$

$$2\mathbb{E}_\alpha^* \left( \sqrt{f_s^N} \mathcal{L}^G \sqrt{f_s^N} \right) \leq C_\beta N^2. \quad (2.11)$$

**Bound on the Dirichlet form and on the entropy production :** at this point, we obtain from (2.9), (2.10) and (2.11)

$$H(\mu_t^N | \mu_\alpha^*) + N^2 \int_0^t D(f_s^N) ds \leq H(\mu^N | \mu_\alpha^*) + t(C_\lambda + C_\beta)N^2$$

By assumption (1.8), the initial density  $\widehat{\zeta} \in C(\mathbb{T}^2 \times \mathbb{S})$  is positive and continuous, therefore there exists two constants  $c$  and  $C$  such that

$$0 < c \leq \widehat{\zeta} \leq C.$$

Furthermore, by assumption (1.7), for any  $u \in \mathbb{T}_N^2$ ,  $\zeta(u) = \int_{\mathbb{S}} \widehat{\zeta}(u, \theta) d\theta \in ]0, 1[$  and is continuous in  $u$ , thus there exists  $c'$  and  $C'$  such that for any  $u \in \mathbb{T}^2$ ,

$$0 < c' \leq \zeta(u) \leq C' < 1.$$

These two conditions yield that for some constant  $K = K(\widehat{\zeta})$ , for any  $N \in \mathbb{N}$ , we can estimate the relative entropy of the initial measure  $\mu^N$  w.r.t.  $\mu_\alpha^*$  by

$$H(\mu^N | \mu_\alpha^*) \leq KN^2. \quad (2.12)$$

We can therefore write

$$H(\mu_t^N | \mu_\alpha^*) + \int_0^t \frac{N^2}{2} D(f_s^N) ds \leq K(t)N^2. \quad (2.13)$$

where  $K(t) = K + t(C_\lambda + C_\beta)$  is a positive constant. Since  $H(f) = \mathbb{E}_\alpha^*(f \log f)$  and  $D(f)$  are both non-negative and convex, we can deduce from (2.13), that for some time-dependent constant  $K_0 = \int_0^t K(s) ds$ , we have

$$H\left(\frac{1}{t} \int_0^t f_s^N ds\right) \leq K_0 N^2 \quad \text{and} \quad D\left(\frac{1}{t} \int_0^t f_s^N ds\right) \leq K_0. \quad (2.14)$$

This upper bound proves proposition 2.9, and will be necessary in the next Section to apply the replacement Lemma 3.1 to the AEP. ■

Before carrying on with the proof of the replacement Lemma, we give a result that will be needed several times throughout the proof, and comes from the entropy inequality. Let us denote by  $\mathcal{L}^{G,\beta=0}$  the modified Glauber generator with uniform update of the angle in  $\mathbb{S}$ , (i.e.  $\beta = 0$ )

$$\mathcal{L}^{G,\beta=0} f(\widehat{\eta}) = \sum_{x \in \mathbb{T}_N^2} \eta_x \frac{1}{2\pi} \int_{\mathbb{S}} (f(\widehat{\eta}^{x,\theta}) - f(\widehat{\eta})) d\theta$$

and denote in a similar fashion

$$L_N^{\beta=0} = N^2 \mathcal{L}^D + \mathcal{L}^{G,\beta=0}. \quad (2.15)$$

Then, accordingly to our previous notations,  $\mathbb{P}_{\mu_\alpha^*}^{\lambda,0}$  is the measure on the trajectories started from  $\mu_\alpha^*$  and driven by the generator  $L_N^{\beta=0}$ . We can now state the following result.

**Proposition 2.10.** *There exists a constant  $K_0 = K_0(T, \beta, \widehat{\rho}_0) > 0$  such that for any function  $X : \Sigma_N^{[0,T]} \rightarrow \mathbb{R}$  and any  $A > 0$ ,*

$$\mathbb{E}_{\mu^N}^{\lambda,\beta} [X(\widehat{\eta}^{[0,T]})] \leq \frac{1}{A} \left( K_0 N^2 + \log \mathbb{E}_{\mu_\alpha^*}^{\lambda,0} \left[ \exp \left( AX(\widehat{\eta}^{[0,T]}) \right) \right] \right),$$

where  $\widehat{\eta}^{[0,T]}$  is the notation already introduced at the end of Section 1.2 for a trajectory  $(\widehat{\eta}(t))_{t \in [0,T]}$ .

*Proof of Proposition 2.10 :* The proof of this Proposition is rather straightforward thanks to the entropy inequality. In a first step, we compare the same process starting from  $\mu_\alpha^*$ . First note that for any function  $X : \Sigma_N^{[0,T]} \rightarrow \mathbb{R}$ , we can write

$$\mathbb{E}_{\mu^N}^{\lambda,\beta} [X(\widehat{\eta}^{[0,T]})] = \mathbb{E}_{\mu_\alpha^*}^{\lambda,\beta} \left( \frac{d\mu^N}{d\mu_\alpha^*}(\widehat{\eta}(0)) X(\widehat{\eta}^{[0,T]}) \right).$$

This yields that

$$\mathbb{E}_{\mu^N}^{\lambda,\beta} [X(\widehat{\eta}^{[0,T]})] \leq \frac{1}{A} \left( H(\mu^N | \mu_\alpha^*) + \log \mathbb{E}_{\mu_\alpha^*}^{\lambda,\beta} \left[ \exp \left( AX(\widehat{\eta}^{[0,T]}) \right) \right] \right). \quad (2.16)$$

In the entropy inequality above,  $\mathbb{E}_{\mu^N}^{\lambda,\beta}$  is the expectation under the measure of the process started from  $\mu^N$ , whereas  $\mathbb{E}_{\mu_\alpha^*}^{\lambda,\beta}$  is that of the process started from the stationary measure  $\mu_\alpha^*$ .

By (2.12), the first term in the right-hand side above is less than  $KN^2/A$  for some fixed constant  $K = K(\zeta)$ . Furthermore, the Radon-Nikodym derivative of the process with alignment ( $\beta > 0$ ) w.r.t the one without alignment ( $\beta = 0$ ) can be explicitly computed. Given a càdlàg trajectory  $\widehat{\eta}^{[0,T]} \in \Sigma_N^{[0,T]}$ , consider  $\tau_1, \dots, \tau_R$  the set of angle jumps between times 0 and  $T$ , let us denote by  $x_i$  the site at which the angle changed at time  $\tau_i$ , and by  $\theta_i = \theta_{x_i}(\tau_i)$  the new angle at site  $x_i$ . Then, the density between the measures with and without alignment is given by

$$\frac{d\mathbb{P}_v^{\lambda,\beta}}{d\mathbb{P}_v^{\lambda,0}}(\widehat{\eta}^{[0,T]}) = \prod_{i=1}^R \frac{c_{x_i,\beta}(\theta_i, \widehat{\eta}(\tau_i))}{c_{x_i,0}(\theta_i, \widehat{\eta}(\tau_i))} \leq e^{8\beta R},$$

where  $R$  is the number of angle updates between times 0 and  $T$ . To establish the estimate above, we used that  $c_{x,\beta}(\theta, \widehat{\eta})$  can be uniformly bounded from above by  $e^{8\beta}/2\pi$ , that  $c_{x,0}(\theta, \widehat{\eta}) = 1/2\pi$ , and that regardless of the configuration and the inverse temperature  $\beta$ , each site updates its angle at rate 1 (i.e.  $\int_{\theta} c_{x,\beta}(\theta, \widehat{\eta}) = 1$ ). We can now estimate the second term in the right-hand side of equation (2.16) by

$$\frac{1}{A} \log \mathbb{E}_{\mu_{\alpha}^*}^{\lambda,0} \left[ e^{8\beta R} \exp \left( AX \left( \widehat{\eta}^{[0,T]} \right) \right) \right].$$

Applying the Cauchy-Schwarz inequality yields that the quantity above is less than

$$\frac{1}{2A} \left( \log \mathbb{E}_{\mu_{\alpha}^*}^{\lambda,0} \left[ e^{16\beta R} \right] + \log \mathbb{E}_{\mu_{\alpha}^*}^{\lambda,0} \left[ \exp \left( 2AX \left( \widehat{\eta}^{[0,T]} \right) \right) \right] \right).$$

Since the spin updates happen in each site at rate 1 except when the site is empty, we can define on the same probability space as our process a family  $P_x$  of i.i.d. Poisson variable with mean  $T$ , and such that  $R \leq \sum_{x \in \mathbb{T}_N^2} P_x$ . thanks to the elementary inequality

$$\log \mathbb{E} \left[ e^{16\beta \sum_{x \in \mathbb{T}_N^2} P_x} \right] = T(e^{16\beta} - 1)N^2,$$

we now only have to let

$$K_0(T, \beta, \widehat{\zeta}) = 2K(\widehat{\zeta}) + T(e^{16\beta} - 1)$$

and replace  $A$  by  $2A$  to conclude the proof of Proposition 2.10. ■

## 2.3 Irreducibility and control on full clusters

*Unlike the exclusion process with one type of particles, the multi-type exclusion process is not irreducible when the number of particles is too large, namely when the domain has less than one empty sites. When all the sites are occupied for example, the process is stuck in its current configuration, up to realignment, due to the exclusion rule. At high density, we therefore lose the mixing properties we need to reach local equilibrium. To illustrate this statement, consider a square macroscopic domain of size  $\varepsilon N$ , and on it a configuration with the bottom half filled with particles with angle  $\theta$ , and the top half filled with particles with angle  $\theta' \neq \theta$ , and letting a finite number of sites be empty, the mixing time of this setup is of order larger than  $N^2$  due to the rigidity of the configuration. In order to reach equilibrium, an empty site needs to "fetch" a particle and transport it in the other cluster, and so on, until the density is homogeneous for both types of particles. The scaling of our alignment dynamics, is, furthermore, not sufficient to ensure sufficiently frequent realignment of the particles to solve this issue.*

*In order to prove the scaling limit of a multi-type exclusion process, it is therefore critical to bound the particle density away from 1. This issue was solved in [Qua92] by using the fact that the total density of the multi type SSEP (the spin blind model) follows the standard SSEP dynamics (with one specie). Thus the total density could be controlled by the classical argument on the hydrodynamic limit for SSEP. In our case, however, the total density does not follow the SSEP dynamics. In fact, it is not even a Markov chain due to the asymmetric parts which depend on the angles. A different argument is therefore required to control the evolution of the total density. This is the purpose of the subsection.*

As investigated in Appendix A.5, if we limit the system to two types of particles, one empty site is sufficient to guarantee the irreducibility of the exclusion dynamics on  $B$ . However, in the general setup where the number of types of particles in a domain  $B$  can reach  $|B|$  (which will often be the case when particles take their angles in  $\mathbb{S}$ ), it is known that the exclusion process with  $|B| - 1$  particles is no longer irreducible, as a consequence of a generalization of the  $n$ -puzzle (cf. Johnson & Story, 1879, see [JS79]). We therefore need to consider only the local configurations with two empty sites, on which the exclusion process is irreducible regardless of the number of types of particles, as stated in the following Lemma.

**Lemma 2.11** (Irreducibility of the displacement process with two empty sites). *Consider a square domain  $B = B_p(x)$ , and two configurations  $\widehat{\eta}, \widehat{\eta}'$  two configurations with the same types and number of particles in  $B$ , i.e. such that*

$$\sum_{x \in B} \eta_x \delta_{\theta_x} = \sum_{x \in B} \eta'_x \delta_{\theta'_x}.$$

*Then, there exists a sequence of configurations  $\widehat{\eta}^0, \dots, \widehat{\eta}^n$ , such that  $\widehat{\eta}^0 = \widehat{\eta}$ ,  $\widehat{\eta}^n = \widehat{\eta}'$ , and such that for any  $k \in \llbracket 0, n-1 \rrbracket$ ,  $\widehat{\eta}^{k+1}$  is reached from  $\widehat{\eta}^k$  by one allowed particle jump, i.e.*

$$\widehat{\eta}^{k+1} = \left(\widehat{\eta}^k\right)^{x_k, x_k+z_k}, \quad \text{and} \quad \eta_{x_k+z_k}^k = 1 - \eta_{x_k}^k = 0 \quad \text{and} \quad |z_k| = 1.$$

*Furthermore, there exists a constant  $C$  such that  $n \leq Cp^4$ .*

*Proof of Lemma 2.11 :* The proof of this statement is quite elementary. Fix a configuration  $\widehat{\eta} \in \Sigma_N$  on a rectangular domain  $B$  with two empty sites, and let  $a = (a_1, a_2)$  be an edge in  $\mathbb{T}_N^2$ . We are first going to prove that  $\widehat{\eta}^{a_1, a_2}$  can be reached from  $\widehat{\eta}$  using allowed particles jumps. Notice that according to the exclusion rule, we can consider that any empty site is allowed to move freely by exchanging their place with any site next to it.

We first bring ourselves back to a configuration described in Fig. 3, where the two closest empty sites are brought next to the edge  $a$ . More precisely, we reach a configuration where the two empty sites and the two sites  $a_1$  and  $a_2$  are at the vertices of a side-1 square. From here, we are able to invert the two particles in  $a_1$  and  $a_2$  by a circular motion of the four empty sites along the edges of the square, and then bring back the empty sites along the paths that brought them next to  $a$  to their original location. Doing so, one reaches exactly the configuration  $\widehat{\eta}^{a_1, a_2}$  from  $\widehat{\eta}$  with allowed particle jumps in  $B$ .

We deduce from this last statement that for any pair of configurations  $\widehat{\eta}, \widehat{\eta}'$  with the same particles in  $B$ ,  $\widehat{\eta}'$  can be reached from  $\widehat{\eta}$  with jumps in  $B$  since the transition can be decomposed along switches of nearest neighbor sites. The process is thus irreducible on the sets with fixed numbers  $\bar{K}$  of particles, as soon as  $K$  is smaller than  $|B| - 2$ . Furthermore, this construction guarantees that any two neighboring particles can be switched with a number of particle exchanges of order  $p$  where we denoted by  $p$  the size of the box. Since one needs to invert  $p$  pairs of particles at most to move one particle to its final position in  $\widehat{\eta}'$ , this proves the last statement. ■

We now prove that large microscopic boxes are rarely fully occupied under the dynamics. Let

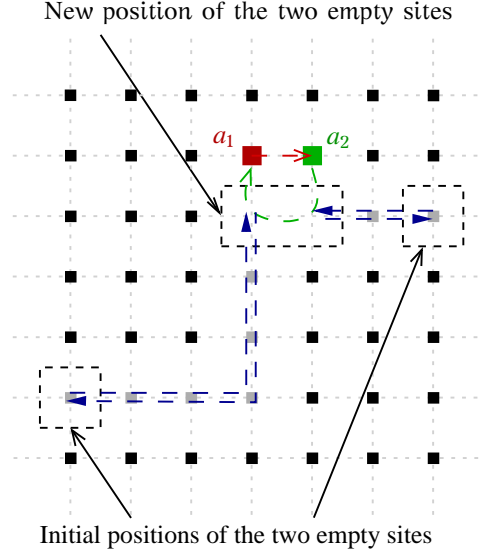
 Figure 3: Reaching  $\widehat{\eta}^{a_1, a_2}$  from  $\eta$ .

us denote by  $E_{p,x}$  the event

$$E_{p,x} = \left\{ \sum_{y \in B_p(x)} \eta_y \leq |B_p(x)| - 2 \right\}, \quad (2.17)$$

on which the box of size  $p$  around  $x$  contains at least two empty sites. When the site  $x$  is the origin, we will simply write  $E_p$  instead of  $E_{p,0}$ . In order to ensure that full clusters very rarely appear in the dynamics, we need the following Lemma.

**Proposition 2.12.** *For any positive time  $T$ ,*

$$\lim_{p \rightarrow \infty} \lim_{N \rightarrow \infty} \mathbb{E}_{\mu^N}^{\lambda, \beta} \left( \int_0^T \frac{1}{N^2} \sum_{x \in \mathbb{T}_N^2} \mathbb{1}_{E_{p,x}^c}(t) dt \right) = 0. \quad (2.18)$$

**Remark 2.13** (Scheme of the proof). *We first sketch the proof in a continuous idealized setup to explain the general ideas before giving the rigorous proof.*

*To prove that the box of microscopic side  $p$  is not full, setting  $p' = (2p + 1)^2$  the cardinal of  $B_p$ , it is enough to prove thanks to the microscopic setting that*

$$\iint_{[0,T] \times \mathbb{T}^2} \rho_t^{p'}(u) du dt \xrightarrow{p' \rightarrow \infty} 0,$$

where  $\rho_t(u)$  denotes the macroscopic density in  $u$  at time  $t$ .

*We expect the total density  $\rho$  to follow the partial differential equation*

$$\partial_t \rho = \Delta \rho + \nabla \cdot (m(1 - \rho)), \quad (2.19)$$

where  $m$  is a random quantity representing the local direction of the asymmetry. Should (2.19) be true, we could therefore write, letting  $\phi(\rho) = 1/(1 - \rho)$

$$\partial_t \int_{\mathbb{T}^2} \phi(\rho_t) du = \int_{\mathbb{T}^2} \phi'(\rho_t) [\Delta \rho_t + \nabla \cdot (m_t(1 - \rho_t))] du$$

$$\begin{aligned}
&= \int_{\mathbb{T}^2} \phi''(\rho_t) \left[ -(\nabla \rho_t)^2 + m_t(1 - \rho_t) \nabla \rho_t \right] du \\
&\leq \int_{\mathbb{T}^2} \phi''(\rho_t) \left[ -(\nabla \rho_t)^2 + \frac{(\nabla \rho_t)^2}{2} + \|m_t\|_\infty^2 (1 - \rho_t)^2 \right] du \\
&\leq \int_{\mathbb{T}^2} \phi''(\rho_t) \|m_t\|_\infty^2 (1 - \rho_t)^2 du = 2 \|m_t\|_\infty^2 \int_{\mathbb{T}^2} \phi(\rho_t) du
\end{aligned} \tag{2.20}$$

One could then apply Gronwall's Lemma to obtain that for any time  $t$ ,

$$\int_{\mathbb{T}^2} \phi(\rho_t) du \leq e^{2\|m\|_\infty^2 t} \int_{\mathbb{T}^2} \phi(\rho_0) du.$$

Furthermore, for any time  $t$ ,

$$\int_{\mathbb{T}^2} \phi(\rho_t) du \geq \frac{1}{\delta} \int_{\mathbb{T}^2} \mathbb{1}_{\{\rho_t \geq 1-\delta\}} + \int_{\mathbb{T}^2} \mathbb{1}_{\{\rho_t \leq 1-\delta\}} = \frac{1-\delta}{\delta} \int_{\mathbb{T}^2} \mathbb{1}_{\{\rho_t \geq 1-\delta\}} + 1,$$

therefore, for any time  $t$ ,

$$\int_{\mathbb{T}^2} \mathbb{1}_{\{\rho_t \geq 1-\delta\}} \leq \frac{\delta}{1-\delta} \left[ e^{2\|m\|_\infty^2 t} \int_{\mathbb{T}^2} \phi(\rho_0) du - 1 \right] \xrightarrow{\delta \rightarrow 0} 0. \tag{2.21}$$

As a consequence, for any time  $t$ , we could therefore write

$$\iint_{[0, T] \times \mathbb{T}^2} \rho_t^{p'}(u) du dt \leq T(1-\delta)^{p'} + \iint_{[0, T] \times \mathbb{T}^2} \mathbb{1}_{\{\rho_t \geq 1-\delta\}}. \tag{2.22}$$

The first term in the right-hand side vanishes for any fixed  $\delta$  as  $p' \rightarrow \infty$ , whereas the second becomes as small as needed letting  $\delta \rightarrow 0$ .

Since our macroscopic density does not verify equation (2.19), however, the operations above need to be performed in a microscopic setup. The derivation of equation (2.21) is the purpose of Proposition 2.14. Two intermediate Lemmas 2.15 and 2.16 prove the microscopic equivalent of equation (2.20).

Before giving the proof of Proposition 2.12, which is postponed to the end of the subsection, we give first the following estimate.

**Proposition 2.14.** *For any positive  $0 < \delta' < 1/2$ , and any time  $t > 0$ , we have the bound*

$$\limsup_{\varepsilon \rightarrow 0} \limsup_{N \rightarrow \infty} \mathbb{E}_{\mu_N^{\lambda, \beta}} \left( \frac{1}{N^2} \sum_{x \in \mathbb{T}_N^2} \mathbb{1}_{\{\tau_x \rho_{\varepsilon N}(t) > 1-2\delta'\}} \right) \leq \delta' C, \tag{2.23}$$

where  $C$  is a finite constant depending continuously on  $t$ , and also depending on the asymmetry  $\lambda$ , and the initial profile  $\widehat{\zeta}$ .

*Proof of Proposition 2.14 :* For any small  $\delta > 0$ , let us denote by  $\phi_\delta$  the application

$$\phi_\delta : [0, 1] \longrightarrow \mathbb{R}_+ \\ \rho \longmapsto \frac{1}{1+\delta-\rho}.$$

Note that all successive derivatives of order less than  $k$  of  $\phi_\delta$  are positive (and increasing) functions, and all are bounded by  $1/\delta^{k+1}$ .

We now fix a  $C^1$  function  $H : \mathbb{T}^2 \rightarrow \mathbb{R}_+$ , and assume that  $\int_{\mathbb{T}^2} H(u) du = 1$ . For any  $u \in \mathbb{T}^2$ , we denote by  $H_u$  the function

$$H_u : v \mapsto H(u - v).$$

In order to simplify the notations, for any configuration  $\widehat{\eta} \in \Sigma_N$ , and given its empirical measure  $\pi^N$ , we shorten

$$\rho_x^{N,H}(\widehat{\eta}) := \langle \pi^N, H_{x/N} \rangle = \frac{1}{N^2} \sum_{y \in \mathbb{T}_N^2} H\left(\frac{x-y}{N}\right) \eta_y. \quad (2.24)$$

We now write

$$\partial_i \mathbb{E}_{\mu^N}^{\lambda,\beta} \left( \frac{1}{N^2} \sum_{x \in \mathbb{T}_N^2} \phi_\delta(\rho_x^{N,H}(\widehat{\eta})) \right) = \mathbb{E}_{\mu^N}^{\lambda,\beta} \left( \frac{1}{N^2} \sum_{x \in \mathbb{T}_N^2} L_N \phi_\delta(\rho_x^{N,H}(\widehat{\eta})) \right), \quad (2.25)$$

where  $L_N$  is the generator of the complete process  $L_N = N^2 \mathcal{L} + N \mathcal{L}^{\text{wa}} + \mathcal{L}^G$ . Our goal is to apply Gronwall's Lemma to the expectation in the left-hand side, therefore we now need to estimate the right-hand side.

Since  $\rho_x^{N,H}$  does not depend on the angles of the particles, neither does  $\phi_\delta(\rho_x^{N,H})$ , and the contribution of the Glauber part  $\mathcal{L}^G$  of the generator  $L_N$  in the right-hand side above vanishes. The two other parts of the generator together yield the wanted bound, and are treated in separate lemmas for the sake of clarity. As mentioned earlier, these two lemmas are the microscopic equivalent of equation (2.20).

**Lemma 2.15.** *[Contribution of the symmetric part] There exists a sequence  $(c_N(\delta, H))_{N \in \mathbb{N}}$  depending only on  $\delta$  and  $H$ , vanishing as  $N \rightarrow \infty$ , and such that for any configuration  $\widehat{\eta} \in \Sigma_N$*

$$\sum_{x \in \mathbb{T}_N^2} \mathcal{L} \phi_\delta(\rho_x^{N,H})(\widehat{\eta}) \leq - \sum_{\substack{x \in \mathbb{T}_N^2 \\ i=1,2}} \frac{\phi_\delta''(\rho_{x+e_i}^{N,H}) + \phi_\delta''(\rho_x^{N,H})}{2} (\rho_{x+e_i}^{N,H} - \rho_x^{N,H})^2(\widehat{\eta}) + c_N(\delta, H). \quad (2.26)$$

**Lemma 2.16.** *[Contribution of the asymmetric part] There exists a sequence  $(\widetilde{c}_N(\delta, H))_{N \in \mathbb{N}}$  depending only on  $\delta$  and  $H$ , vanishing as  $N \rightarrow \infty$ , and such that for any configuration  $\widehat{\eta} \in \Sigma_N$*

$$\frac{1}{N} \sum_{x \in \mathbb{T}_N^2} \mathcal{L}^{\text{wa}} \phi_\delta(\rho_x^{N,H})(\widehat{\eta}) \leq \sum_{x \in \mathbb{T}_N^2} \left[ \sum_{i=1}^2 \frac{\phi_\delta''(\rho_{x+e_i}^{N,H}) + \phi_\delta''(\rho_x^{N,H})}{2} (\rho_{x+e_i}^{N,H} - \rho_x^{N,H})^2 + \frac{2\lambda^2 \phi_\delta(\rho_x^{N,H})}{N^2} \right] (\widehat{\eta}) + \widetilde{c}_N(\delta, H). \quad (2.27)$$

*Proof of Lemma 2.15 :* By definition of the symmetric part of the generator  $\mathcal{L}$ ,

$$\sum_{x \in \mathbb{T}_N^2} \mathcal{L} \phi_\delta(\rho_x^{N,H})(\widehat{\eta}) = \sum_{x, y \in \mathbb{T}_N^2} \sum_{i=1}^2 \mathbb{1}_{\{\eta_y \eta_{y+e_i} = 0\}} \left[ \phi_\delta(\rho_x^{N,H}(\widehat{\eta}^{i,y+e_i})) - \phi_\delta(\rho_x^{N,H}(\widehat{\eta})) \right].$$

We now develop the gradient of  $\phi_\delta$  to the second order, to obtain that the right-hand side above is equal to

$$\sum_{x,y \in \mathbb{T}_N^2} \sum_{i=1}^2 \mathbb{1}_{\{\eta_y \eta_{y+e_i}=0\}} \left[ \phi'_\delta(\rho_x^{N,H}(\widehat{\eta})) (\rho_x^{N,H}(\widehat{\eta}^{y,y+e_i}) - \rho_x^{N,H}(\widehat{\eta})) \right. \\ \left. + \frac{\phi''_\delta(\rho_x^{N,H}(\widehat{\eta}))}{2} (\rho_x^{N,H}(\widehat{\eta}^{y,y+e_i}) - \rho_x^{N,H}(\widehat{\eta}))^2 + o\left((\rho_x^{N,H}(\widehat{\eta}^{y,y+e_i}) - \rho_x^{N,H}(\widehat{\eta}))^2\right) \right].$$

Note that since the successive derivatives of order less than  $k$  of  $\phi_\delta$  are uniformly bounded on  $[0, 1]$  by  $1/\delta^k$ , the vanishing quantity  $o\left((\rho_x^{N,H}(\widehat{\eta}^{y,y+e_i}) - \rho_x^{N,H}(\widehat{\eta}))^2\right)$  can be bounded uniformly in  $\widehat{\eta}$ ,  $x$ ,  $y$  and  $i$  (but not uniformly in  $\delta$ ). Since  $H$  is a smooth function,

$$\left| \rho_x^{N,H}(\widehat{\eta}^{y,y+e_i}) - \rho_x^{N,H}(\widehat{\eta}) \right| = \frac{1}{N^2} \left| H_{x/N}\left(\frac{y+e_i}{N}\right) - H_{x/N}\left(\frac{y}{N}\right) \right|$$

is of order  $N^{-3}$ , the contributions of the second line above are therefore at most of order  $N^{-2}$  and vanish in the limit  $N \rightarrow \infty$ . This yields

$$\sum_{x \in \mathbb{T}_N^2} \mathcal{L}\phi_\delta(\rho_x^{N,H}) = \sum_{x \in \mathbb{T}_N^2} \phi'_\delta(\rho_x^{N,H}(\widehat{\eta})) \sum_{y \in \mathbb{T}_N^2} \sum_{i=1}^2 \mathbb{1}_{\{\eta_y \eta_{y+e_i}=0\}} (\rho_x^{N,H}(\widehat{\eta}^{y,y+e_i}) - \rho_x^{N,H}(\widehat{\eta})) + o_N(1), \quad (2.28)$$

where  $o_N(1)$  is less than a vanishing sequence  $(c_N^1)_{N \in \mathbb{N}}$  depending on  $\delta$  and  $H$  only.

Since for any  $z \in \mathbb{T}^2$ ,  $H_u(v+z) = H_{u-z}(v)$ , the definition of  $\rho_x^{N,H}$  yields

$$\mathbb{1}_{\{\eta_y \eta_{y+e_i}=0\}} (\rho_x^{N,H}(\widehat{\eta}^{y,y+e_i}) - \rho_x^{N,H}(\widehat{\eta})) = \frac{1}{N^2} (\eta_y - \eta_{y+e_i}) \left( H_{x/N}\left(\frac{y+e_i}{N}\right) - H_{x/N}\left(\frac{y}{N}\right) \right) \\ = \frac{1}{N^2} \eta_y \left( H_{x-e_i/N}\left(\frac{y}{N}\right) - H_{x/N}\left(\frac{y}{N}\right) \right) \\ - \frac{1}{N^2} \eta_{y+e_i} \left( H_{x/N}\left(\frac{y+e_i}{N}\right) - H_{x+e_i/N}\left(\frac{y+e_i}{N}\right) \right).$$

Summing the quantity above over  $y$ , one obtains exactly  $\rho_{x-e_i}^{N,H} + \rho_{x+e_i}^{N,H} - 2\rho_x^{N,H}$ . This is the discrete Laplacian in the variable  $x$  of  $\rho_x^{N,H}$ , and a discrete integration by parts allows us to rewrite the first term on the right-hand side of equation (2.28) as

$$- \sum_{x \in \mathbb{T}_N^2} \sum_{i=1}^2 (\phi'_\delta(\rho_{x+e_i}^{N,H}) - \phi'_\delta(\rho_x^{N,H})) (\rho_{x+e_i}^{N,H} - \rho_x^{N,H}).$$

We now write

$$(\phi'_\delta(\rho_{x+e_i}^{N,H}) - \phi'_\delta(\rho_x^{N,H})) = \frac{(\phi''_\delta(\rho_{x+e_i}^{N,H}) + \phi''_\delta(\rho_x^{N,H}))}{2} (\rho_{x+e_i}^{N,H} - \rho_x^{N,H}) + o(\rho_{x+e_i}^{N,H} - \rho_x^{N,H}),$$

in which  $\rho_{x+e_i}^{N,H} - \rho_x^{N,H}$  is of order  $1/N$  because  $H$  is a smooth function, to finally obtain that

$$\sum_{x \in \mathbb{T}_N^2} \mathcal{L}\phi_\delta(\rho_x^{N,H}) = - \sum_{x \in \mathbb{T}_N^2} \sum_{i=1}^2 \frac{\phi''_\delta(\rho_{x+e_i}^{N,H}) + \phi''_\delta(\rho_x^{N,H})}{2} (\rho_{x+e_i}^{N,H} - \rho_x^{N,H})^2 + o_N(1), \quad (2.29)$$

where once again, the  $o_N$  can be bounded by a vanishing sequence  $(c_N)_{N \in \mathbb{N}}$  depending only on  $\delta$ , which completes the proof of Lemma 2.15  $\blacksquare$



*Proof of Lemma 2.16 :* This proof follows the exact same steps as for the previous one. We first obtain by definition of  $\mathcal{L}^{\text{wa}}$  and developing the discrete gradient of  $\phi$  that

$$\frac{1}{N} \sum_{x \in \mathbb{T}_N^2} \mathcal{L}^{\text{wa}} \phi_\delta(\rho_x^{N,H}) = o_N(1) + \frac{1}{N} \sum_{x,y \in \mathbb{T}_N^2} \sum_{i=1}^2 (\tau_y j_i^{\lambda_i}) \phi'_\delta(\rho_x^{N,H}(\bar{\eta})) (\rho_x^{N,H}(\bar{\eta}^{y,y+e_i}) - \rho_x^{N,H}(\bar{\eta})), \quad (2.30)$$

where  $j_i^{\lambda_i}$  is defined according to equation (1.17) as

$$j_i^{\lambda_i}(\bar{\eta}) = \lambda_i(\theta_0)\eta_0(1 - \eta_{e_i}) - \lambda_i(\theta_{e_i})\eta_{e_i}(1 - \eta_0),$$

and  $o_N(1)$  is less than a vanishing sequence depending only on  $\delta$  and  $H$ . Once again, similar steps as in the previous case allow us to rewrite

$$\begin{aligned} (\tau_y j_i^{\lambda_i}) (\rho_x^{N,H}(\bar{\eta}^{y,y+e_i}) - \rho_x^{N,H}(\bar{\eta})) &= \frac{1}{N^2} \left[ \lambda_i(\theta_y)\eta_y(1 - \eta_{y+e_i}) + \lambda_i(\theta_{y+e_i})\eta_{y+e_i}(1 - \eta_y) \right] \left( H_{x/N} \left( \frac{y+e_i}{N} \right) - H_{x/N} \left( \frac{y}{N} \right) \right) \\ &= \frac{1}{N^2} \lambda_i(\theta_y)\eta_y(1 - \eta_{y+e_i}) \left( H_{x/N} \left( \frac{y+e_i}{N} \right) - H_{x/N} \left( \frac{y}{N} \right) \right) + \\ &\quad + \frac{1}{N^2} \lambda_i(\theta_{y+e_i})\eta_{y+e_i}(1 - \eta_y) \left( H_{x/N} \left( \frac{y+e_i}{N} \right) - H_{x/N} \left( \frac{y}{N} \right) \right) \\ &= \frac{1}{N^2} \lambda_i(\theta_y)\eta_y(1 - \eta_{y+e_i}) \left( H_{x/N} \left( \frac{y+e_i}{N} \right) - H_{x+e_i/N} \left( \frac{y+e_i}{N} \right) \right) + \\ &\quad + \frac{1}{N^2} \lambda_i(\theta_{y+e_i})\eta_{y+e_i}(1 - \eta_y) \left( H_{x-e_i/N} \left( \frac{y}{N} \right) - H_{x/N} \left( \frac{y}{N} \right) \right) \end{aligned}$$

Summing once again by parts in  $x$ , we obtain that the second term in the right-hand side of equation (2.30) is

$$\begin{aligned} \frac{1}{N} \sum_{x,y \in \mathbb{T}_N^2} \sum_{i=1}^2 (\tau_y j_i^{\lambda_i}) \phi'_\delta(\rho_x^{N,H}(\bar{\eta})) (\rho_x^{N,H}(\bar{\eta}^{y,y+e_i}) - \rho_x^{N,H}(\bar{\eta})) &= \frac{1}{N^3} \sum_{x \in \mathbb{T}_N^2} \sum_{i=1}^2 \left[ \phi'_\delta(\rho_{x+e_i}^{N,H}(\bar{\eta})) - \phi'_\delta(\rho_x^{N,H}(\bar{\eta})) \right] \times \\ &\quad \sum_{y \in \mathbb{T}_N^2} \left[ \lambda_i(\theta_y)\eta_y(1 - \eta_{y+e_i}) H_{x+e_i/N} \left( \frac{y+e_i}{N} \right) + \lambda_i(\theta_{y+e_i})\eta_{y+e_i}(1 - \eta_y) H_{x/N} \left( \frac{y}{N} \right) \right] \\ &:= S_1 + S_2, \end{aligned} \quad (2.31)$$

where

$$S_1 = \frac{1}{N^3} \sum_{x \in \mathbb{T}_N^2} \sum_{i=1}^2 \left[ \phi'_\delta(\rho_{x+e_i}^{N,H}(\bar{\eta})) - \phi'_\delta(\rho_x^{N,H}(\bar{\eta})) \right] \sum_{y \in \mathbb{T}_N^2} \left[ \lambda_i(\theta_y)\eta_y(1 - \eta_{y+e_i}) H_{x+e_i/N} \left( \frac{y+e_i}{N} \right) \right]$$

and

$$S_2 = \frac{1}{N^3} \sum_{x \in \mathbb{T}_N^2} \sum_{i=1}^2 \left[ \phi'_\delta(\rho_{x+e_i}^{N,H}(\bar{\eta})) - \phi'_\delta(\rho_x^{N,H}(\bar{\eta})) \right] \sum_{y \in \mathbb{T}_N^2} \left[ \lambda_i(\theta_{y+e_i})\eta_{y+e_i}(1 - \eta_y) H_{x/N} \left( \frac{y}{N} \right) \right].$$

These two terms are treated in the exact same fashion, we therefore only treat in full detail the case of  $S_1$ ,  $S_2$  will follow straightforwardly. First, we develop the difference  $\phi'_\delta(\rho_{x+e_i}^{N,H}(\bar{\eta})) - \phi'_\delta(\rho_x^{N,H}(\bar{\eta}))$  to the first order,

$$\phi'_\delta(\rho_{x+e_i}^{N,H}) - \phi'_\delta(\rho_x^{N,H}) = \phi''_\delta(\rho_{x+e_i}^{N,H})(\rho_{x+e_i}^{N,H} - \rho_x^{N,H}) + o(\rho_{x+e_i}^{N,H} - \rho_x^{N,H}).$$

Once again,  $H$  being a smooth function,  $\rho_{x+e_i}^{N,H} - \rho_x^{N,H}$  is of order  $1/N$ , therefore the  $o(\rho_{x+e_i}^{N,H} - \rho_x^{N,H})$  is also a  $o_N(1/N)$ , and the corresponding contribution in  $S_1$  vanishes in the limit  $N \rightarrow \infty$ . Recall that  $\phi''_\delta$  is a positive function, we now apply in  $S_1$  the elementary inequality  $ab \leq a^2/2 + b^2/2$  to

$$a = \sqrt{\phi''_\delta(\rho_{x+e_i}^{N,H})}(\rho_{x+e_i}^{N,H} - \rho_x^{N,H}) \quad \text{and} \quad b = \frac{1}{N^3} \sqrt{\phi''_\delta(\rho_{x+e_i}^{N,H})} \sum_{y \in \mathbb{T}_N^2} \left[ \lambda_i(\theta_{y+e_i}) \eta_{y+e_i} (1 - \eta_y) H_{x/N} \left( \frac{y}{N} \right) \right].$$

This yields

$$|S_1| \leq o_N(1) + \sum_{\substack{x \in \mathbb{T}_N^2 \\ i=1,2}} \left[ \frac{\phi''_\delta(\rho_{x+e_i}^{N,H})}{2} (\rho_{x+e_i}^{N,H} - \rho_x^{N,H})^2 + \frac{\phi''_\delta(\rho_{x+e_i}^{N,H})}{2N^6} \left( \sum_{y \in \mathbb{T}_N^2} \lambda_i(\theta_y) \eta_y (1 - \eta_{y+e_i}) H_{x+e_i/N} \left( \frac{y+e_i}{N} \right) \right)^2 \right].$$

The function  $H$  being non-negative, for any  $y$ , we can write

$$\lambda_i(\theta_y) \eta_y (1 - \eta_{y+e_i}) H_{x+e_i/N} \left( \frac{y+e_i}{N} \right) \leq \lambda(1 - \eta_{y+e_i}) H_{x+e_i/N} \left( \frac{y+e_i}{N} \right).$$

Furthermore, since we assumed that  $\int_{\mathbb{T}^2} H = 1$ , and since  $H$  is smooth, we get that

$$\frac{1}{N^2} \sum_{y \in \mathbb{T}_N^2} H_{x/N}(y/N) = 1 + o_N(1),$$

which yields

$$\left| \frac{1}{N^2} \sum_{y \in \mathbb{T}_N^2} \lambda_i(\theta_y) \eta_y (1 - \eta_{y+e_i}) H_{x+e_i/N} \left( \frac{y+e_i}{N} \right) \right| \leq \lambda(1 - \rho_{x+e_i}^{N,H}) + o_N(1)$$

This, combined with the previous bound, yields that

$$|S_1| \leq o_N(1) + \sum_{\substack{x \in \mathbb{T}_N^2 \\ i=1,2}} \left[ \frac{\phi''_\delta(\rho_{x+e_i}^{N,H})}{2} (\rho_{x+e_i}^{N,H} - \rho_x^{N,H})^2 + \frac{\lambda^2 \phi''_\delta(\rho_{x+e_i}^{N,H})}{2N^2} (1 - \rho_{x+e_i}^{N,H})^2 \right].$$

A similar bound can be achieved for  $S_2$ , this time developing the difference  $\phi'_\delta(\rho_{x+e_i}^{N,H}) - \phi'_\delta(\rho_x^{N,H})$  in  $\rho_x^{N,H}$  instead of  $\rho_{x+e_i}^{N,H}$ ,

$$|S_2| \leq o_N(1) + \sum_{\substack{x \in \mathbb{T}_N^2 \\ i=1,2}} \left[ \frac{\phi''_\delta(\rho_x^{N,H})}{2} (\rho_{x+e_i}^{N,H} - \rho_x^{N,H})^2 + \frac{\lambda^2 \phi''_\delta(\rho_x^{N,H})}{2N^2} (1 - \rho_x^{N,H})^2 \right].$$

Combining these two bounds with identities (2.30) and (2.31), we obtain that

$$\frac{1}{N} \sum_{x \in \mathbb{T}_N^2} \mathcal{L}^{\text{wa}} \phi_\delta(\rho_x^{N,H}) \leq \sum_{\substack{x \in \mathbb{T}_N^2 \\ i=1,2}} \left[ \frac{\phi_\delta''(\rho_x^{N,H}) + \phi_\delta''(\rho_x^{N,H})}{2} (\rho_{x+e_i}^{N,H} - \rho_x^{N,H})^2 + \frac{\lambda^2 \phi_\delta''(\rho_x^{N,H})}{2N^2} (1 - \rho_x^{N,H})^2 \right] + o_N(1),$$

where the  $o_N(1)$  can be bounded by a vanishing sequence  $(\bar{c}_N)_N$  depending only on  $H$  and  $\delta$ . One easily obtains that for any non-negative  $\delta$  and any  $\rho \in [0, 1]$ ,

$$(1 - \rho)^2 \phi_\delta''(\rho) \leq 2\phi_\delta(\rho),$$

thus concluding the proof of Lemma 2.16.  $\blacksquare$

We are now ready to apply Gronwall's Lemma and complete the proof of Proposition 2.14. For that purpose, let us define

$$\Phi(t) = \mathbb{E}_{\mu^N}^{\lambda, \beta} \left( \frac{1}{N^2} \sum_{x \in \mathbb{T}_N^2} \phi_\delta(\rho_x^{N,H}(t)) \right).$$

according to the previous Lemmas 2.15, 2.16 and to equation (2.25), there exists a sequence  $k_N = c_N + \bar{c}_N$  depending only on  $\delta$  and  $H$ , verifying

$$k_N \xrightarrow{N \rightarrow \infty} 0,$$

and such that

$$\partial_t \Phi(t) \leq 2\lambda^2 \Phi(t) + k_N.$$

Since  $\phi_\delta$  is bounded from below by  $1/1 + \delta$ ,  $\Phi(t)$  also is, and therefore

$$\partial_t \Phi(t) \leq (2\lambda^2 + k_N(1 + \delta))\Phi(t).$$

Gronwall's Lemma therefore yields that for any non-negative  $t$ ,

$$\mathbb{E}_{\mu^N}^{\lambda, \beta} \left( \frac{1}{N^2} \sum_{x \in \mathbb{T}_N^2} \phi_\delta(\rho_x^{N,H}(t)) \right) \leq \mathbb{E}_{\mu^N}^{\lambda, \beta} \left( \frac{1}{N^2} \sum_{x \in \mathbb{T}_N^2} \phi_\delta(\rho_x^{N,H}(0)) \right) e^{(2\lambda^2 + k_N(1 + \delta))t},$$

where this time the right-hand side depends on the trajectory only through its initial state  $\widehat{\eta}(0)$ .

Fix a small  $\delta' > 0$ .  $\varphi_\delta$  being a non-decreasing function bounded from below by  $1/1 + \delta$ , one can write for any  $\rho \in [0, 1]$

$$\phi_\delta(\rho) \geq \frac{1}{\delta + \delta'} \mathbb{1}_{\{\rho > 1 - \delta'\}} + \mathbb{1}_{\{\rho \leq 1 - \delta'\}} \frac{1}{1 + \delta} = \frac{1 - \delta'}{(1 + \delta)(\delta + \delta')} \mathbb{1}_{\{\rho > 1 - \delta'\}} + \frac{1}{1 + \delta}$$

We apply this decomposition to the left-hand side of the inequality above, to obtain that

$$\mathbb{E}_{\mu^N}^{\lambda, \beta} \left( \frac{1}{N^2} \sum_{x \in \mathbb{T}_N^2} \mathbb{1}_{\{\rho_x^{N,H}(t) > 1 - \delta'\}} \right) \leq \frac{(1 + \delta)(\delta + \delta')}{1 - \delta'} \left[ \mathbb{E}_{\mu^N}^{\lambda, \beta} \left( \frac{1}{N^2} \sum_{x \in \mathbb{T}_N^2} \phi_\delta(\rho_x^{N,H}(0)) \right) e^{(2\lambda^2 + k_N(1 + \delta))t} - 1 \right]. \quad (2.32)$$

Coming back to the definition (2.24) of  $\rho_x^{N,H}$ , for any smooth non-negative function  $H$  with integral equal to 1, taking the  $\limsup N \rightarrow \infty$ , we thus obtain from equation (2.32)

$$\limsup_{N \rightarrow \infty} \mathbb{E}_{\mu^N}^{\lambda, \beta} \left( \frac{1}{N^2} \sum_{x \in \mathbb{T}_N^2} \mathbb{1}_{\{\rho_x^{N,H}(t) > 1 - \delta'\}} \right) \leq \limsup_{N \rightarrow \infty} \frac{(1 + \delta)(\delta + \delta')}{1 - \delta'} \left[ \mathbb{E}_{\mu^N}^{\lambda, \beta} \left( \frac{1}{N^2} \sum_{x \in \mathbb{T}_N^2} \phi_\delta(\rho_x^{N,H}(0)) \right) e^{2\lambda^2 t} - 1 \right]. \quad (2.33)$$

Fix a small  $\varepsilon > 0$ , and let us denote for any  $u, v \in \mathbb{T}^2$

$$H^\varepsilon(v) = \frac{1}{(2\varepsilon)^2} \mathbb{1}_{[-\varepsilon, +\varepsilon]^2}(v) \quad \text{and} \quad H_u^\varepsilon(v) = \frac{1}{(2\varepsilon)^2} \mathbb{1}_{[-\varepsilon, +\varepsilon]^2}(v - u).$$

Recalling that  $\rho_{\varepsilon N}(t)$  is the empirical density in a box of size  $\varepsilon N$  around the origin at time  $t$ , we can then write

$$\tau_x \rho_{\varepsilon N}(t) = \frac{(2\varepsilon N)^2}{(2\varepsilon N + 1)^2} \rho_x^{N, H^\varepsilon} = \rho_x^{N, H^\varepsilon} + o_N(1).$$

At this point, we want to apply equation (2.33) to  $H = H^\varepsilon$ , which is an indicator function, and thus need to be smoothed out. For that purpose, consider a sequence  $(H_l^\varepsilon)_{l \in \mathbb{N}}$  of functions such that

- $\forall l \in \mathbb{N}, \forall u \in \mathbb{T}^2, H_l^\varepsilon(u) \geq 0$  and  $\sup_{\mathbb{T}^2} H_l^\varepsilon = \sup_{\mathbb{T}^2} H^\varepsilon = 1/(2\varepsilon)^2$ .
- $\forall l \in \mathbb{N}, H_l^\varepsilon \in C^1(\mathbb{T}^2)$  and  $\int_{\mathbb{T}^2} H_l^\varepsilon(u) du = 1$ .
- $H_l^\varepsilon(u) \neq H^\varepsilon(u) \Rightarrow \varepsilon - 1/l < \|u\|_\infty < \varepsilon + 1/l$ .

The existence of such a sequence of functions is quite clear and is left to the reader. In particular, the last condition imposes that

$$I_l := \int_{\mathbb{T}^2} \mathbb{1}_{H_l^\varepsilon(u) \neq H^\varepsilon(u)} du \leq \frac{16\varepsilon}{l},$$

which is the area of the crown on which the two functions may differ. The sequence  $H_l^\varepsilon$  converges for any fixed  $\varepsilon$  towards  $H^\varepsilon$  in  $L^1(\mathbb{T}^2)$ . Furthermore, notice that for any  $x \in \mathbb{T}_N^2$ , since both the  $H_l^\varepsilon$ 's and  $H^\varepsilon$  are bounded by  $1/(2\varepsilon)^2$ ,

$$\begin{aligned} \left| \rho_x^{N, H_l^\varepsilon} - \rho_x^{N, H^\varepsilon} \right| &\leq \frac{1}{N^2} \sum_{y \in \mathbb{T}_N^2} \eta_y \left| H_{l, x/N}^\varepsilon\left(\frac{y}{N}\right) - H_{x/N}^\varepsilon\left(\frac{y}{N}\right) \right| \\ &\leq \left( \frac{16\varepsilon}{l} + o_N(1) \right) (\|H_l^\varepsilon\|_\infty + \|H^\varepsilon\|_\infty) = \frac{8}{\varepsilon l} + o_N(1), \end{aligned}$$

where the last line represents the proportion of sites of the discrete torus in the crown around  $u = x/N$  on which  $H_{l, x/N}^\varepsilon$  and  $H_{x/N}^\varepsilon$  can be different. The last observation yields that for any  $x \in \mathbb{T}_N^2$ , we can write

$$\left| \tau_x \rho_{\varepsilon N}(t) - \rho_x^{N, H_l^\varepsilon}(t) \right| \leq \frac{8}{\varepsilon l} + o_N(1),$$

where the  $o_N(1)$  can be chosen independent of  $\widehat{\eta}$  and  $x$ . Fix  $\varepsilon > 0$  and consider  $N_0$  and  $l_0$  such that for any  $N \geq N_0$  and any  $l \geq l_0$ ,

$$\left| \tau_x \rho_{\varepsilon N}(t) - \rho_x^{N, H_l^\varepsilon}(t) \right| \leq \frac{\delta'}{2}.$$

For any such pair  $l, N$ , we therefore also have

$$\mathbb{1}_{\{\tau_{x\rho_{\varepsilon N}}(t) > 1 - \delta'/2\}} \leq \mathbb{1}_{\left\{\rho_x^{N, H_l^\varepsilon}(t) > 1 - \delta'\right\}}.$$

For any  $l$ , by our assumptions, equation (2.33) holds for  $H = H_l^\varepsilon$  for any positive  $\delta$  and  $\delta'$ . For any  $l \geq l_0$ , we can therefore write

$$\limsup_{N \rightarrow \infty} \mathbb{E}_{\mu^N}^{\lambda, \beta} \left( \frac{1}{N^2} \sum_{x \in \mathbb{T}_N^2} \mathbb{1}_{\{\tau_{x\rho_{\varepsilon N}}(t) > 1 - \delta'/2\}} \right) \leq \limsup_{N \rightarrow \infty} \frac{(1 + \delta)(\delta + \delta')}{1 - \delta'} \left[ \mathbb{E}_{\mu^N}^{\lambda, \beta} \left( \frac{1}{N^2} \sum_{x \in \mathbb{T}_N^2} \phi_\delta \left( \rho_x^{N, H_l^\varepsilon}(0) \right) \right) e^{2\lambda^2 t} - 1 \right].$$

Since  $\delta > 0$ , the dominated convergence theorem and the law of large number yield that right-hand side above is equal to

$$\frac{(1 + \delta)(\delta + \delta')}{1 - \delta'} \left[ e^{2\lambda^2 t} \int_{\mathbb{T}^2} \phi_\delta \left( \zeta * H_l^\varepsilon(v) \right) dv - 1 \right],$$

where  $\zeta$  is the initial density profile defined in assumption (1.7), and " $*$ " denotes the convolution on  $\mathbb{T}^2$ . Since  $\zeta$  is bounded away from 1 uniformly on  $\mathbb{T}^2$ ,  $\zeta * H_l^\varepsilon$  is also bounded away from 1 uniformly in  $\varepsilon$ , and therefore

$$\phi_\delta \left( \zeta * H_l^\varepsilon(v) \right) \leq C^* < 1,$$

where  $C^* = C^*(\zeta)$  is a constant which does not depend on  $l, \varepsilon, v$  or  $\delta$ .

Letting now  $\delta$  go to 0, we obtain that for any  $\varepsilon > 0$  and any time  $t$ ,

$$\limsup_{N \rightarrow \infty} \mathbb{E}_{\mu^N}^{\lambda, \beta} \left( \frac{1}{N^2} \sum_{x \in \mathbb{T}_N^2} \mathbb{1}_{\{\tau_{x\rho_{\varepsilon N}}(t) > 1 - \delta'/2\}} \right) \leq \frac{\delta'}{1 - \delta'} (e^{2\lambda^2 t} C^* - 1),$$

which concludes the proof of Proposition 2.14 since we assumed  $\delta' > 1/2$ . ■

With the estimate stated in Proposition 2.14, we are ready to prove Proposition 2.12.

*Proof of Proposition 2.12 :* First notice that in order to prove (2.18), it is sufficient to prove it both for  $F_{p,x}$  and  $F'_{p,x}$  instead of  $E_{p,x}^c$ , where

$$F_{p,x} = \left\{ \sum_{y \in B_p(x)} \eta_y = |B_p(x)| \right\} \quad \text{and} \quad F'_{p,x} = \left\{ \sum_{y \in B_p(x)} \eta_y = |B_p(x)| - 1 \right\}.$$

We focus on the first case, the second is derived in the exact same fashion.

Unlike in [Qua92], the spin blind process's macroscopic density does not evolve according to the heat equation because of the weak drift. However, thanks to the bound (2.14) on the entropy of the measure  $\mu_t^N$  w.r.t. the reference measure  $\mu_\alpha^*$  and on the Dirichlet form of the density  $f_t^N$ , local equilibrium holds for the angle-blind process. As a consequence, the replacement Lemma 3.1 holds for functions independent of the angles (cf. for example [KL99], p77). One therefore obtains that to prove

$$\lim_{p \rightarrow \infty} \lim_{N \rightarrow \infty} \mathbb{E}_{\mu^N}^{\lambda, \beta} \left( \int_0^T \frac{1}{N^2} \sum_{x \in \mathbb{T}_N^2} \mathbb{1}_{F_{p,x}}(s) ds \right) = 0, \quad (2.34)$$

one can replace  $\mathbb{1}_{F_{p,x}(s)}$  by its expectation under the product measure with parameter  $\tau_x \rho_{\varepsilon N}(s)$ , namely

$$\mathbb{E}_{\tau_x \rho_{\varepsilon N}(s)}(\mathbb{1}_{F_{p,x}}) = [\tau_x \rho_{\varepsilon N}(s)]^{p'}$$

where  $p' = (2p+1)^2$  is the number of sites in  $B_p$ .

To prove equation (2.34), it is therefore sufficient to prove that  $\forall t \in [0, T]$ ,

$$\lim_{p' \rightarrow \infty} \limsup_{\varepsilon \rightarrow 0} \limsup_{N \rightarrow \infty} \mathbb{E}_{\mu^N}^{\lambda, \beta} \left( \frac{1}{N^2} \sum_{x \in \mathbb{T}_N^2} [\tau_x \rho_{\varepsilon N}(t)]^{p'} \right) = 0. \quad (2.35)$$

To prove the latter, since  $\rho_{\varepsilon N}(t)$  is at most 1, one only has to write, as outlined in equation (2.22),

$$\mathbb{E}_{\mu^N}^{\lambda, \beta} \left( \frac{1}{N^2} \sum_{x \in \mathbb{T}_N^2} [\tau_x \rho_{\varepsilon N}(t)]^{p'} \right) \leq (1 - \delta)^{p'} + \mathbb{E}_{\mu^N}^{\lambda, \beta} \left( \frac{1}{N^2} \sum_{x \in \mathbb{T}_N^2} \mathbb{1}_{\{\tau_x \rho_{\varepsilon N}(t) > 1 - \delta\}} \right),$$

which holds for any positive  $\delta$ .

For any fixed  $\delta > 0$ , the first term on the right-hand side vanishes as  $p \rightarrow \infty$ , whereas the second does not depend on  $p$  and we can therefore let  $\delta \rightarrow 0$  after  $N \rightarrow \infty$ , then  $\varepsilon \rightarrow 0$ , then  $p' \rightarrow \infty$ . Since the right-hand side of equation (2.23) vanishes as  $\delta' = 2\delta$  goes to 0, the left-hand side also does, and (2.35) holds for any  $t$  thanks to Proposition 2.14. This proves equation (2.34), and the equivalent proposition with  $F'_{p,x}$  instead of  $F_{p,x}$  is proved in the exact same fashion, thus concluding the proof of Proposition 2.12.  $\blacksquare$

## 3 Law of large number for the spin process

### 3.1 Replacement Lemma

Our goal in this Section is to close the microscopic equations and to replace in the definition of the martingale  $M^{H,N}$  introduced in (1.14) any cylinder (in the sense of Definition 1.1) function  $g(\widehat{\eta})$  by its spatial average  $\mathbb{E}_{\widehat{\rho}_{\varepsilon N}}(g)$ , where  $\widehat{\rho}_{\varepsilon N}$  is the empirical angle measure over a small macroscopic box of size  $\varepsilon N$ . We use this Section to introduce new useful notations. The proof of the main result of this Section, the Replacement Lemma 3.1, follows closely the usual strategy (c.f. Lemma 1.10 p.77 of [KL99]), however it requires several technical adaptations due to the nature of our canonical and grand canonical measure. In particular, we will need the topological setup and the various results obtained in Section 2.

Consider a cylinder function  $g \in C$ , and  $l$  a positive integer. Recall from (1.21) that  $\langle g \rangle_0^l$  is the average of the translations of  $g$  over a box of side  $2l+1$  centered at the origin. Recall from equation (1.22) and Definition 2.1 that the empirical angle measure  $\widehat{\rho}_l$  over the box  $B_l$  of side  $2l+1$  is the measure on  $[0, 2\pi[$

$$\widehat{\rho}_l = \frac{1}{|B_l|} \sum_{x \in B_l} \eta_x \delta_{\theta_x}.$$

Define

$$\mathcal{V}^l(\widehat{\eta}) = \langle g(\widehat{\eta}) \rangle_0^l - \mathbb{E}_{\widehat{\rho}_l}(g) \quad \text{and} \quad \mathcal{W}^l(\widehat{\eta}) = g(\widehat{\eta}) - \mathbb{E}_{\widehat{\rho}_l}(g), \quad (3.1)$$

and for any smooth function  $G \in C(\mathbb{T}^2)$ , let

$$X^{l,N}(G, \widehat{\eta}) = \frac{1}{N^2} \sum_{x \in \mathbb{T}_N^2} G(x/N) \tau_x \mathcal{W}^l. \quad (3.2)$$

We first state that under the measure of AEP, one can replace the average of  $g$  over a small macroscopic box by its expectation w.r.t. the canonical measure with angle measure  $\widehat{\rho}_{\varepsilon N}$ .

**Lemma 3.1** (Replacement Lemma). *For every  $\delta > 0$ , we have with the notation (3.1)*

$$\limsup_{\varepsilon \rightarrow 0} \limsup_{N \rightarrow \infty} \mathbb{P}_{\mu^N}^{\lambda, \beta} \left[ \int_0^T \frac{1}{N^2} \sum_{x \in \mathbb{T}_N^2} \tau_x \left| \mathcal{V}^{\varepsilon N}(\widehat{\eta}(t)) \right| dt > \delta \right] = 0.$$

The proof is postponed to subsection 3.2, and requires the control of the full clusters stated in Proposition 2.12. For now, we can deduce from this lemma the following result, which will allow us to replace in (1.20) the currents by their spatial averages.

**Corollary 3.2.** *For every  $\delta > 0$ , and any continuous function*

$$G : [0, T] \times \mathbb{T}^2 \longrightarrow \mathbb{R} \\ (t, u) \longmapsto G_t(u),$$

we get with the notation (3.2)

$$\limsup_{\varepsilon \rightarrow 0} \limsup_{N \rightarrow \infty} \mathbb{P}_{\mu^N}^{\lambda, \beta} \left[ \left| \int_0^T X^{\varepsilon N, N}(G_t, \widehat{\eta}(t)) dt \right| > \delta \right] = 0.$$

*Proof of Corollary 3.2 :* Recall that  $\varepsilon \rightarrow 0$  after  $N \rightarrow \infty$ , which means that the smoothness of  $G$  allows us to replace in the limit  $G(x/N)$  by its spatial average on a box of size  $\varepsilon$ , which is denoted by

$$G^{\varepsilon N}(x/N) := \frac{1}{(2N\varepsilon + 1)^2} \sum_{y \in B_{\varepsilon N}(x)} G(y/N).$$

More precisely, we can write, using notation (1.21) for the local averaging, and since  $g$  is a cylinder, hence bounded, function,

$$\begin{aligned} \limsup_{\varepsilon \rightarrow 0} \limsup_{N \rightarrow \infty} \int_0^T \frac{1}{N^2} \sum_{x \in \mathbb{T}_N^2} G_t(x/N) \tau_{xg} dt &= \limsup_{\varepsilon \rightarrow 0} \limsup_{N \rightarrow \infty} \int_0^T \frac{1}{N^2} \sum_{x \in \mathbb{T}_N^2} G_t^{\varepsilon N}(x/N) \tau_{xg} dt \\ &= \limsup_{\varepsilon \rightarrow 0} \limsup_{N \rightarrow \infty} \int_0^T \frac{1}{N^2} \sum_{y \in \mathbb{T}_N^2} G_t(y/N) \langle g \rangle_y^{\varepsilon N} dt, \end{aligned} \quad (3.3)$$

where the average  $\langle g \rangle_y^{\varepsilon N}$  is defined in equation (1.21).

As a consequence,  $\tau_y g$  can be replaced by its average  $\langle g \rangle_y^{\varepsilon N}$ . Note that

$$\mathcal{V}^{\varepsilon N}(\widehat{\eta}) = \mathcal{W}^{\varepsilon N}(\widehat{\eta}) + \langle g \rangle_y^{\varepsilon N} - g,$$

and that the replacement Lemma 3.1 implies in particular that for any bounded function  $G$  in  $C([0, T] \times \mathbb{T}^2)$

$$\limsup_{\varepsilon \rightarrow 0} \limsup_{N \rightarrow \infty} \mathbb{P}_{\mu^N}^{\lambda, \beta} \left[ \left| \int_0^T \frac{1}{N^2} \sum_{x \in \mathbb{T}_N^2} G_t(x/N) \tau_x \mathcal{V}^{\varepsilon N}(\widehat{\eta}(t)) dt \right| > \delta \right] = 0.$$

Therefore, thanks to equality (3.3), Corollary 3.2 follows directly from Lemma 3.1.  $\blacksquare$

## 3.2 Proof of the replacement Lemma

In order to prove the replacement Lemma 3.1, we will need the two lemmas below. The first one states that the average of any cylinder function  $\langle g(\widehat{\eta}) \rangle_0^l$  over a large microscopic box (a box of size  $l$  which tends to infinity after  $N$ ) can be replaced by its expected value w.r.t. the canonical measure with parameter the empirical density  $\mathbb{E}_{\widehat{\rho}_l}(g)$ .

The second guarantees that the empirical angle measure does not vary much between a large microscopic box and a small macroscopic box. We state these two results, namely the one and two-blocks estimates, in a quite general setup, because they are necessary in several steps of the proof of the hydrodynamic limit.

**Lemma 3.3** (one-block estimate). *Consider  $\alpha \in ]0, 1[$  and a density  $f$  w.r.t the translation invariant measure  $\mu_\alpha^*$  (cf. Definition 2.4) satisfying*

i) *There exists a constant  $K_0$  such that for any  $N$*

$$H(f) \leq K_0 N^2 \quad \text{and} \quad D(f) \leq K_0.$$



ii)

$$\lim_{p \rightarrow \infty} \lim_{N \rightarrow \infty} \mathbb{E}_\alpha^* \left( f \frac{1}{N^2} \sum_{x \in \mathbb{T}_N^2} \mathbb{1}_{E_{p,x}^c} \right) = 0. \quad (3.4)$$

Then, for any cylinder function  $g$ ,

$$\limsup_{l \rightarrow \infty} \limsup_{N \rightarrow \infty} \mathbb{E}_\alpha^* \left( f \frac{1}{N^2} \sum_{x \in \mathbb{T}_N^2} \tau_x \mathcal{V}^l \right) = 0,$$

where  $\mathcal{V}^l$  was defined in (3.1).

**Lemma 3.4** (two-block estimate). *For any  $\alpha \in ]0, 1[$  and any density  $f$  satisfying conditions i) and ii) of Lemma 3.3,*

$$\limsup_{l \rightarrow \infty} \limsup_{\varepsilon \rightarrow 0} \limsup_{N \rightarrow \infty} \sup_{y \in B_{\varepsilon N}} \mathbb{E}_\alpha^* \left( \frac{1}{N^2} \sum_{x \in \mathbb{T}_N^2} \left\| \tau_{x+y} \widehat{\rho}_l - \tau_x \widehat{\rho}_{\varepsilon N} \right\| f \right) = 0,$$

where  $\tau_z \widehat{\rho}_k$  is the local empirical angle measure in the box of size  $k$  centered in  $z$  introduced in (1.22).

The proofs of these two lemmas will be presented resp. in Section 3.3 and 3.4. For now, let us show that they are sufficient to prove the replacement Lemma 3.1.

*Proof of Lemma 3.1 :* Lemma 3.1 follows from applying the two previous lemmas to the density

$$\overline{f}_T^N = \frac{1}{T} \int_0^T f_t^N dt,$$

where  $f_t^N = d\mu_t^N / d\mu_\alpha^*$ , defined in Section 2.2, is the density of the AEP at time  $t$  started from  $\mu^N$ , and prove that Lemma 3.1 follows. Proposition (2.9) proved that  $\overline{f}_T^N$  satisfies condition i) of Lemma 3.3. Furthermore,  $\overline{f}_T^N$  also satisfies condition ii)

$$\lim_{p \rightarrow \infty} \lim_{N \rightarrow \infty} \mathbb{E}_\alpha^* \left( \overline{f}_T^N \frac{1}{N^2} \sum_{x \in \mathbb{T}_N^2} \mathbb{1}_{E_{p,x}^c} \right) = 0$$

thanks to Proposition 2.12, thus the one-block and two-blocks estimates apply to  $f = \overline{f}_T^N$ .

Now let us recall that we want to prove for any  $\delta > 0$

$$\limsup_{\varepsilon \rightarrow 0} \limsup_{N \rightarrow \infty} \mathbb{P}_{\mu^N}^{\lambda, \beta} \left[ \int_0^T \frac{1}{N^2} \sum_{x \in \mathbb{T}_N^2} \tau_x \left| \mathcal{V}^{\varepsilon N}(\widehat{\eta}(t)) \right| dt > \delta \right] = 0,$$

where

$$\mathcal{V}^{\varepsilon N}(\widehat{\eta}) = \langle g(\widehat{\eta}) \rangle_0^{\varepsilon N} - \mathbb{E}_{\widehat{\rho}_{\varepsilon N}}(g).$$

Thanks to the Markov inequality, it is sufficient to prove that

$$\limsup_{\varepsilon \rightarrow 0} \limsup_{N \rightarrow \infty} \mathbb{E}_{\mu^{\lambda, \beta}} \left[ \int_0^T \frac{1}{N^2} \sum_{x \in \mathbb{T}_N^2} \tau_x \left| \mathcal{V}^{\varepsilon N}(\widehat{\eta}(t)) \right| dt \right] = 0.$$

We can now express the expectation above thanks to the mean density  $\overline{f}_T^N$ . Since  $T$  is fixed, to obtain the replacement Lemma it is enough to show that

$$\limsup_{\varepsilon \rightarrow 0} \limsup_{N \rightarrow \infty} \mathbb{E}_\alpha^* \left( \overline{f}_T^N \frac{1}{N^2} \sum_{x \in \mathbb{T}_N^2} \tau_x \left| \mathcal{V}^{\varepsilon N}(\widehat{\eta}) \right| \right) = 0. \quad (3.5)$$

For any function  $\varphi(\cdot)$  on the torus  $\mathbb{T}_N^2$ , recall that we denoted in (1.21) by  $\langle \varphi(\cdot) \rangle_x^l$  the average of the function  $\varphi$  over a box centered in  $x$  of size  $l$ , and that  $\tau_y \widehat{\rho}_l$  is the empirical angle measure in a box of size  $l$  centered in  $y$  defined in (1.22). Let us add and subtract

$$\langle \langle g(\widehat{\eta}) \rangle_0^l - \mathbb{E}_{\widehat{\rho}_l}(g) \rangle_0^{\varepsilon N} = \frac{1}{(2\varepsilon N + 1)^2} \sum_{x \in B_{\varepsilon N}} \left[ \frac{1}{(2l + 1)^2} \sum_{|y-x| \leq l} \tau_y g - \mathbb{E}_{\tau_y \widehat{\rho}_l}(g) \right]$$

inside  $\left| \mathcal{V}^{\varepsilon N}(\widehat{\eta}) \right|$ . We can then write thanks to the triangular inequality

$$\left| \mathcal{V}^{\varepsilon N}(\widehat{\eta}) \right| \leq (\mathcal{Z}_1^{l, \varepsilon N} + \mathcal{Z}_2^{l, \varepsilon N} + \mathcal{Z}_3^{l, \varepsilon N})(\widehat{\eta}),$$

where

$$\mathcal{Z}_1^{l, \varepsilon N} = \left| \frac{1}{(2\varepsilon N + 1)^2} \sum_{x \in B_{\varepsilon N}} \left( \tau_x g - \frac{1}{(2l + 1)^2} \sum_{|y-x| \leq l} \tau_y g \right) \right|,$$

is the difference between  $g$  and its local average,

$$\mathcal{Z}_2^{l, \varepsilon N} = \frac{1}{(2\varepsilon N + 1)^2} \sum_{x \in B_{\varepsilon N}} \left| \mathbb{E}_{\tau_x \widehat{\rho}_l}(g) - \frac{1}{(2l + 1)^2} \sum_{|y-x| \leq l} \tau_y g \right|,$$

is the difference between the local average of  $g$  and its expectation under the product measure with parameter the local angle measure  $\widehat{\rho}_l$ , and

$$\mathcal{Z}_3^{l, \varepsilon N} = \frac{1}{(2\varepsilon N + 1)^2} \sum_{x \in B_{\varepsilon N}} \left| \mathbb{E}_{\tau_x \widehat{\rho}_l}(g) - \mathbb{E}_{\tau_x \widehat{\rho}_{\varepsilon N}}(g) \right|$$

is the difference between the expectations of  $g$  under the empirical microscopic and macroscopic angle measures  $\widehat{\rho}_l$  and  $\widehat{\rho}_{\varepsilon N}$ .

Let us consider the first term,  $N^{-2} \sum_x \tau_x \mathcal{Z}_1^{l, \varepsilon N}$ . All the terms in  $\mathcal{Z}_1^{l, \varepsilon N}$  corresponding to the  $x$ 's in  $B_{\varepsilon N-l}$  vanish, since they appear exactly once in both parts of the sum. The number of remaining terms can be crudely bounded by  $4\varepsilon N l$ , and each term takes the form  $\tau_x g / (2\varepsilon N + 1)^2$ . Hence, we have the upper bound

$$\mathbb{E}_\alpha^* \left( \overline{f}_T^N \frac{1}{N^2} \sum_{x \in \mathbb{T}_N^2} \tau_x \mathcal{Z}_1^{l, \varepsilon N} \right) \leq \frac{Kl}{\varepsilon N} \mathbb{E}_\alpha^* \left( \overline{f}_T^N \frac{1}{N^2} \sum_{x \in \mathbb{T}_N^2} \tau_x |g| \right).$$

Since  $g$  is a bounded function, this expression can be bounded from above by

$$\frac{Kl\|g\|_\infty}{\varepsilon N} \mathbb{E}_\alpha^* \left( \bar{f}_t^N \right) = C(l, \varepsilon, g) o_N(1),$$

which proves that

$$\limsup_{\varepsilon \rightarrow 0} \limsup_{N \rightarrow \infty} \mathbb{E}_\alpha^* \left( \frac{1}{N^2} \sum_{x \in \mathbb{T}_N^2} \tau_x \mathcal{Z}_1^{l, \varepsilon N} \bar{f}_t^N \right) = 0.$$

Now since

$$\sum_{x \in \mathbb{T}_N^2} \frac{1}{(2\varepsilon N + 1)^2} \sum_{y \in B_{\varepsilon N}(x)} \tau_y g = \sum_{x \in \mathbb{T}_N^2} \tau_x g,$$

the two following terms can respectively be rewritten as

$$\mathbb{E}_\alpha^* \left( \bar{f}_T^N \frac{1}{N^2} \sum_{x \in \mathbb{T}_N^2} \tau_x \mathcal{Z}_2^{l, \varepsilon N} \right) = \mathbb{E}_\alpha^* \left( \bar{f}_T^N \frac{1}{N^2} \sum_{x \in \mathbb{T}_N^2} \tau_x \left| \mathbb{E}_{\widehat{\rho}_l}(g) - \langle g \rangle_0^l \right| \right), \quad (3.6)$$

and

$$\mathbb{E}_\alpha^* \left( \bar{f}_T^N \frac{1}{N^2} \sum_{x \in \mathbb{T}_N^2} \tau_x \mathcal{Z}_3^{l, \varepsilon N} \right) = \mathbb{E}_\alpha^* \left( \bar{f}_T^N \frac{1}{N^2} \sum_{x \in \mathbb{T}_N^2} \tau_x \left| \mathbb{E}_{\widehat{\rho}_l}(g) - \mathbb{E}_{\widehat{\rho}_{\varepsilon N}}(g) \right| \right). \quad (3.7)$$

The quantity (3.6) vanishes in the limit  $N \rightarrow \infty$  then  $l \rightarrow \infty$  thanks to the one-block estimate stated in Lemma 3.3.

Finally, according to Definition 2.2, (3.7) also vanishes thanks to the two-block estimate of Lemma 3.4 and the Lipschitz-continuity of the application

$$\Psi_g : (\mathcal{M}_1(\mathbb{S}), \|\cdot\|) \rightarrow \mathbb{R} \\ \widehat{\alpha} \mapsto \mathbb{E}_{\widehat{\alpha}}(g),$$

which was proved in Proposition B.2. The Replacement Lemma 3.1 thus follows from the one and two-blocks estimates.  $\blacksquare$

In the next two Sections 3.3 and 3.4, we prove the one-block and two-block estimates. The strategy for these proofs follows closely these presented in [KL99], albeit it requires some adjustments due to the measure-valued nature of the parameter of the product measure  $\mu_{\widehat{\alpha}}$  and the necessity to control the full clusters.

### 3.3 Proof of Lemma 3.3 : The one-block estimate

*The usual strategy to prove the one block estimate is to project the estimated quantity on sets with fixed number of particles, on which the density of  $f$  should be constant thanks to the bound on the Dirichlet form.*

To prove the one-block estimate, thanks to the translation invariance of  $\mu_\alpha^*$ , it is sufficient to control the limit as  $N$  goes to  $\infty$ , then  $l \rightarrow \infty$  of

$$\mathbb{E}_\alpha^* \left( f \cdot \frac{1}{N^2} \sum_{x \in \mathbb{T}_N^2} \tau_x \mathcal{V}^l \right) = \mathbb{E}_\alpha^* (\mathcal{V}^l f),$$

where  $\bar{f} = N^{-2} \sum_{\mathbb{T}_N^2} \tau_x f$  is the average over the periodic domain of the translations of the density  $f$ . Before doing so, we need to eliminate the configurations on which the box  $B_l$  is almost full. Notice that the average  $\mathcal{V}^l$  is bounded because  $g$  is a cylinder function. We can therefore write

$$\mathbb{E}_\alpha^*(\mathcal{V}^l \bar{f}) \leq \mathbb{E}_\alpha^*(\mathcal{V}^l \mathbb{1}_{E_l} \bar{f}) + \|\mathcal{V}^l\|_\infty \mathbb{E}_\alpha^*(\mathbb{1}_{E_l^c} \bar{f}),$$

where  $E_l$  is the event on which at least two sites are empty in  $B_l$ , defined after Equation (2.17), and  $E_l^c$  is its complementary event. The second term in the right-hand side vanishes by definition of  $\bar{f}$ , because  $f$  verifies (3.4), and it is therefore sufficient to prove that

$$\limsup_{l \rightarrow \infty} \limsup_{N \rightarrow \infty} \mathbb{E}_\alpha^*(\mathcal{V}^l \mathbb{1}_{E_l} \bar{f}) = 0.$$

Furthermore, the convexity of the Dirichlet form and the entropy yield that condition *i*) of the one-block estimate is also satisfied by  $\bar{f}$ . Since  $\mathcal{V}^l \mathbb{1}_{E_l}$  only depends on  $\widehat{\eta}$  only through the  $\widehat{\eta}_x$ 's in the cube  $B_{l+1}$  we can replace the density  $\bar{f}$  in the formula above by its conditional expectation  $\bar{f}_l$ , defined, for any configuration  $\widehat{\eta}$  on  $B_{l+1}$  by

$$\bar{f}_l(\widehat{\eta}) = \mathbb{E}_\alpha^*(\bar{f} \mid \widehat{\eta}_x = \widehat{\eta}_x, x \in B_{l+1}).$$

For any function  $f$  depending only on spins in  $B_l$  let  $\mathbb{E}_{\alpha,l}^*$  be the expectation with respect to the product measure  $\mu_\alpha^*$  over  $B_l$ . With the previous notations, and in order to prove the one-block estimate, it is sufficient to prove that

$$\limsup_{l \rightarrow \infty} \limsup_{N \rightarrow \infty} \mathbb{E}_{\alpha,l}^*(\mathcal{V}^l \mathbb{1}_{E_l} \bar{f}_l) \leq 0.$$

In order to proceed, we need to estimate the Dirichlet form and the entropy of  $\bar{f}_l$  thanks to that of  $f$ , and prove that

$$D_{l+1}(\bar{f}_l) \leq C(l)N^{-2} \quad \text{and} \quad H(\bar{f}_l) \leq C(l). \quad (3.8)$$

**Estimate on the Dirichlet form of  $\bar{f}_l$ :** we denote by  $\mathcal{L}_{x,y}$  the symmetric part of the exclusion generator corresponding to the transfer of a particle between  $x$  and  $y$

$$\mathcal{L}_{x,y} f(\widehat{\eta}) = (\eta_x - \eta_y) (f(\widehat{\eta}^{y,x}) - f(\widehat{\eta})),$$

and by  $D^{x,y}$  the part of the Dirichlet form of the exclusion process corresponding to  $\mathcal{L}_{x,y}$

$$D^{x,y}(f) = -\mathbb{E}_\alpha^*(\sqrt{f} \mathcal{L}_{x,y} \sqrt{f}).$$

With this notation, we have

$$D(f) = \sum_{|x-y|=1} D^{x,y}(f),$$

where  $D$  is the Dirichlet form introduced in equation (2.6). We denote in a similar fashion the Dirichlet form restricted to the box of size  $l+1$  for any function  $h$  depending only on the spins in  $B_{l+1}$  by

$$D_{l+1}^{x,y}(h) = -\mathbb{E}_{\alpha,l+1}^*(\sqrt{h} \mathcal{L}_{x,y} \sqrt{h}).$$

Since the conditioning  $f \mapsto f_l$  is an expectation, and since the Dirichlet elements  $D_l^{x,y}$  are convex, the inequality

$$D_{l+1}^{x,y}(\bar{f}_l) \leq D^{x,y}(\bar{f})$$

follows from Jensen's inequality. We deduce from the previous inequality, by summing over all edges  $(x, y) \in B_l$ , thanks to the translation invariance of  $\bar{f}$ , that

$$D_{l+1}(\bar{f}_l) \leq \sum_{(x,y) \in B_l} D^{x,y}(\bar{f}) = 2l(2l+1) \sum_{j=1}^2 D^{0,e_j}(\bar{f}) = \frac{(2l+1)^2}{N^2} D(\bar{f}),$$

where  $D_{l+1}$  is the Dirichlet form of the process restricted to the particle transfers with both the start and end site in  $B_l$ . Up to this point, we have proved that for any function  $f$  such that  $D(\bar{f}) \leq D(f) \leq K_0$ , we have as wanted

$$D_{l+1}(\bar{f}_l) \leq C_1(l)N^{-2}. \quad (3.9)$$

**Estimate on the entropy of  $\bar{f}_l$**  : recall that we defined the entropy  $H(f) = \mathbb{E}_\alpha^*(f \log f)$  and that we already established  $H(\bar{f}) \leq K_0 N^2$ . Let us partition  $\mathbb{T}_N^2$  in  $q := \lfloor N/(2l+3) \rfloor^2$  square boxes  $B^1 := B_{l+1}(x_1), \dots, B^q := B_{l+1}(x_q)$ , and  $B^{q+1}$ , which contains all the site that weren't part of any of the boxes. We can thus write

$$\mathbb{T}_N^2 = \bigsqcup_{i=1}^{q+1} B^i.$$

We denote by  $\widehat{\eta}^i$  the configuration restricted to  $B^i$  and by  $\widehat{\xi}^i$  the complementary configuration to  $\widehat{\eta}^i$ . In other words, for any  $i \in \llbracket 1, q+1 \rrbracket$ , we split any configuration on the torus  $\widehat{\eta}$  into  $\widehat{\eta}^i$  and  $\widehat{\xi}^i$ . We define for any  $i \in \llbracket 1, q \rrbracket$  the densities on the  $\widehat{\eta}^i$ 's

$$\bar{f}_l^i(\widehat{\eta}^i) = \mathbb{E}_\alpha^*(\bar{f}(\widehat{\eta}^i, \widehat{\xi}^i) | \widehat{\xi}^i).$$

Let us denote by  $\varphi$  the product density w.r.t.  $\mu_\alpha^*$  with the same marginals as  $\bar{f}$ , defined by

$$\varphi(\widehat{\eta}) = \bar{f}_l^1(\widehat{\eta}^1) \bar{f}_l^2(\widehat{\eta}^2) \dots \bar{f}_l^{q+1}(\widehat{\eta}^{q+1}),$$

elementary entropy computations yield that

$$H(\bar{f}) = H_\varphi(\bar{f}/\varphi) + \sum_{i=1}^{q+1} H(\bar{f}_l^i),$$

where  $H_\varphi(f) = H(f\mu_\alpha^* | \varphi\mu_\alpha^*)$ . Since by construction  $\bar{f}$  is translation invariant, for any  $i = 1, \dots, q$ , we can write  $H(\bar{f}_l^i) = H(\bar{f}_l^1) = H(\bar{f}_l)$ , therefore in particular, the previous bound also yields, thanks to the non-negativity of the entropy, that

$$H(\bar{f}) \geq qH(\bar{f}_l).$$

Since  $q$  is of order  $N^2/l^2$ , this rewrites

$$H(\bar{f}_l) \leq \frac{K_0 N^2}{q} \leq C_2(l), \quad (3.10)$$

and proves equation (3.8).

Thanks to equations (3.9) and (3.10), we now reduced the proof of Lemma 3.3 to

$$\limsup_{l \rightarrow \infty} \limsup_{N \rightarrow \infty} \sup_{\substack{D_{l+1}(f) \leq C_1(l)N^{-2} \\ H(f) \leq C_2(l)}} \mathbb{E}_{\alpha, l}^* \left( \mathcal{V}^l \mathbb{1}_{E_l} f \right) = 0. \quad (3.11)$$

Since the set of measures with density w.r.t.  $\mu_\alpha^*$  such that  $H(f) \leq C_2(l)$  is weakly compact, to prove the one block estimate of Lemma 3.3, it is sufficient to show that

$$\limsup_{l \rightarrow \infty} \sup_{\substack{D_{l+1}(f)=0 \\ H(f) \leq C_2(l)}} \mathbb{E}_{\alpha, l}^* \left( \mathcal{V}^l \mathbb{1}_{E_l} f \right).$$

Before using the equivalence of ensembles, we need to project the limit above over all sets with fixed number of particles  $\Sigma_l^{\widehat{K}}$  defined in equation (2.3). Recall from Definition 2.6 the projection of the grand canonical measures on the sets with fixed number of particles. For any density  $f$  w.r.t.  $\mu_\alpha^*$ , such that  $D_{l+1}(f) = 0$ , thanks to Section 2.3 and the presence of the indicator function,  $f$  is constant on  $\Sigma_l^{\widehat{K}}$  for any  $\widehat{K} \in \mathcal{M}_\epsilon(\mathbb{S})$ . We therefore denote, for any such  $f$ , by  $f(\widehat{K})$  the value of  $f$  on the set  $\Sigma_l^{\widehat{K}}$ . Shortening  $\int_{\widehat{K} \in \widetilde{\mathbb{K}}_l}$  for the sum  $\sum_{K \leq (2l+1)^2} \int_{\theta_1 \in \mathbb{S}} \dots \int_{\theta_K \in \mathbb{S}}$ , we can write thanks to the indicator functions  $\mathbb{1}_{E_l}$ , for any  $f$  satisfying  $D_{l+1}(f) = 0$ ,

$$\mathbb{E}_{\alpha, l}^* \left( \mathcal{V}^l \mathbb{1}_{E_l} f \right) = \int_{\widehat{K} \in \widetilde{\mathbb{K}}_l} f(\widehat{K}) \mathbb{E}_{l, \widehat{K}} \left( \mathcal{V}^l \right) d\mathbb{P}_\alpha^* \left( \widehat{\eta} \in \Sigma_l^{\widehat{K}} \right), \quad (3.12)$$

where  $\widetilde{\mathbb{K}}$  was defined in (2.2).

Since  $\int_{\widehat{K} \in \widetilde{\mathbb{K}}_l} f(\widehat{K}) d\mathbb{P}_\alpha^* \left( \widehat{\eta} \in \Sigma_l^{\widehat{K}} \right) = 1$  and  $\mathbb{E}_{l, \widehat{K}} \left( \mathcal{V}^l \right) \leq \sup_{\widehat{K} \in \widetilde{\mathbb{K}}_l} \mathbb{E}_{l, \widehat{K}} \left( \mathcal{V}^l \right)$ , we obtain

$$\limsup_{l \rightarrow \infty} \limsup_{N \rightarrow \infty} \sup_{\substack{D_{l+1}(f) \leq C_2(l)N^{-2} \\ H(f) \leq C_2(l)}} \mathbb{E}_{\alpha, l}^* \left( \mathcal{V}^l \mathbb{1}_{E_l} f \right) \leq \limsup_{l \rightarrow \infty} \sup_{\widehat{K} \in \widetilde{\mathbb{K}}_l} \mathbb{E}_{l, \widehat{K}} \left( \mathcal{V}^l \right).$$

To conclude the proof of equation (3.11) and the one-block estimate, it is therefore sufficient to prove that the right-hand side above vanishes.

For any  $\widehat{K} \in \widetilde{\mathbb{K}}_l$ , recall that  $\widehat{\alpha}_{\widehat{K}} \in \mathcal{M}_1(\mathbb{S})$  is the angle measure

$$\widehat{\alpha}_{\widehat{K}} = \frac{1}{(2l+1)^2} \sum_{k=1}^K \delta_{\theta_k} \in \mathcal{M}_1(\mathbb{S}).$$

Since the expectation  $\mathbb{E}_{l, \widehat{K}}$  conditions the process to having  $K$  particles with angles  $\Theta_K$  in  $B_l$ , by definition of  $\mathcal{V}_l$ , we can write

$$\mathbb{E}_{l, \widehat{K}} \left( \mathcal{V}^l \right) = \mathbb{E}_{l, \widehat{K}} \left( \left| \mathbb{E}_{\widehat{\alpha}_{\widehat{K}}} (g) - \frac{1}{(2l+1)^2} \sum_{x \in B_l} \tau_x g \right| \right).$$

Let  $k$  be an integer that will go to infinity after  $l$ , and let us divide  $B_l$  according to Figure 4 into  $q$  boxes  $B^1, \dots, B^q$ , each of size  $(2k+1)^2$ , with  $q = \lfloor \frac{2l+1}{2k+1} \rfloor^2$ . Let  $B^0 = B_l - \cup_{i=1}^q B^i$ , the number of sites in  $B^0$  is bounded for some universal constant  $C$  by  $Ckl$ .

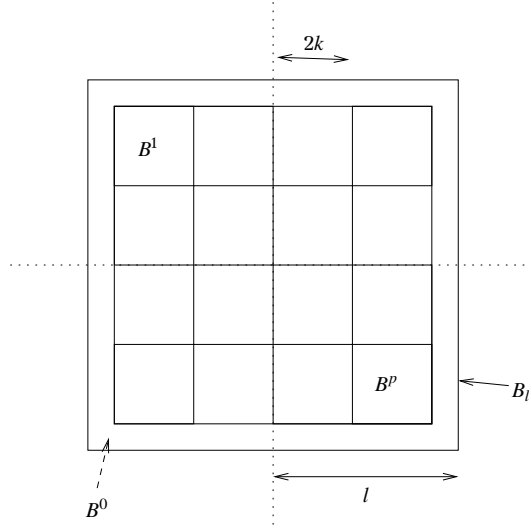
 Figure 4: Construction of the  $B^i$ 

With these notations, the triangular inequality yields

$$\begin{aligned} \mathbb{E}_{l, \widehat{K}} \left( \left| \mathbb{E}_{\widehat{\alpha}_{\widehat{K}}}(g) - \frac{1}{(2l+1)^2} \sum_{x \in B_l} \tau_x g \right| \right) &\leq \frac{|B^i|}{|B_l|} \sum_{i=0}^q \mathbb{E}_{l, \widehat{K}} \left( \left| \mathbb{E}_{\widehat{\alpha}_{\widehat{K}}}(g) - \frac{1}{|B^i|} \sum_{x \in B^i} \tau_x g \right| \right) \\ &= \frac{(2k+1)^2}{(2l+1)^2} \sum_{i=1}^q \mathbb{E}_{l, \widehat{K}} \left( \left| \mathbb{E}_{\widehat{\alpha}_{\widehat{K}}}(g) - \frac{1}{(2k+1)^2} \sum_{x \in B^i} \tau_x g \right| \right) \\ &\quad + O\left(\frac{k}{l}\right) \end{aligned}$$

Since the distribution of the quantity inside the expectation does not depend on  $i$ , the quantity above can be rewritten

$$\underbrace{q \frac{(2k+1)^2}{(2l+1)^2}}_{\rightarrow 1} \mathbb{E}_{l, \widehat{K}} \left( \left| \mathbb{E}_{\widehat{\alpha}_{\widehat{K}}}(g) - \frac{1}{(2k+1)^2} \sum_{x \in B_k} \tau_x g \right| \right) + O\left(\frac{k}{l}\right).$$

Because  $g$  is a cylinder function, and since  $k$  goes to  $\infty$  after  $l$ , the quantity inside absolute values is a local function for any fixed  $k$ . Letting  $l$  go to  $\infty$ , the equivalence of ensembles stated in Proposition B.1 allows us to replace the expectation above, uniformly in  $\widehat{K}$ , by

$$\mathbb{E}_{\widehat{\alpha}_{\widehat{K}}} \left( \left| \mathbb{E}_{\widehat{\alpha}_{\widehat{K}}}(g) - \frac{1}{(2k+1)^2} \sum_{x \in B_k} \tau_x g \right| \right).$$

Finally, since  $\cup_{l \in \mathbb{N}} \{\widehat{\alpha}_{\widehat{K}}, \widehat{K} \in \widetilde{\mathbb{K}}_l\} \subset \mathcal{M}_1(\mathbb{S})$ , where  $\mathcal{M}_1(\mathbb{S})$  is the set of angle density profiles introduced in Definition 2.1,

$$\limsup_{l \rightarrow \infty} \sup_{\widehat{K} \in \widetilde{\mathbb{K}}_l} \mathbb{E}_{l, \widehat{K}}(\mathcal{V}^l) \leq \sup_{\widehat{\alpha} \in \mathcal{M}_1(\mathbb{S})} \mathbb{E}_{\widehat{\alpha}} \left( \left| \mathbb{E}_{\widehat{\alpha}}(g) - \frac{1}{(2k+1)^2} \sum_{x \in B_k} \tau_x g \right| \right),$$

whose right-hand side vanishes as  $k \rightarrow \infty$  by the law of large numbers, thus concluding the proof of the one-block estimate.

### 3.4 Proof of Lemma 3.4 : The two-block estimate

This Section follows the usual strategy for the two-block estimate, with small adaptations to the topological setup on the space of parameters  $\mathcal{M}_1(\mathbb{S})$  introduced in Definition 2.2.

Our goal is to show that for any density  $f$  satisfying conditions *i*) and *ii*) in Lemma 3.3,

$$\limsup_{l \rightarrow \infty} \limsup_{\varepsilon \rightarrow 0} \limsup_{N \rightarrow \infty} \sup_{y \in B_{\varepsilon N}} \mathbb{E}_\alpha^* \left( \frac{1}{N^2} \sum_{x \in \mathbb{T}_N^2} \left\| \tau_{x+y} \widehat{\rho}_l - \tau_x \widehat{\rho}_{\varepsilon N} \right\| f \right) = 0.$$

The previous expectation can be bounded from above by triangle inequality by

$$\mathbb{E}_\alpha^* \left( \frac{1}{N^2} \sum_{x \in \mathbb{T}_N^2} \frac{1}{(2N\varepsilon + 1)^2} \left\| \sum_{z \in B_{N\varepsilon}} (\tau_{x+y} \widehat{\rho}_l - \tau_{x+z} \widehat{\rho}_l) \right\| f \right) + o(l/\varepsilon N).$$

In this way, we reduce the proof to comparing average densities in two boxes of size  $l$  distant of less than  $\varepsilon N$ . Let us extract in the sum inside the integral the terms in  $z$ 's such that  $|y - z| \leq 2l$ , the number of such terms is of order at most  $l/\varepsilon N$ , and this quantity is bounded from above by

$$\mathbb{E}_\alpha^* \left( \frac{1}{N^2} \sum_{x \in \mathbb{T}_N^2} \frac{1}{(2N\varepsilon + 1)^2} \left\| \sum_{\substack{z \in B_{N\varepsilon} \\ |y-z| > 2l}} (\tau_{x+y} \widehat{\rho}_l - \tau_{x+z} \widehat{\rho}_l) \right\| f \right) + o(l/\varepsilon N).$$

This separation was performed in order to obtain independent empirical measures  $\tau_{x+y} \widehat{\rho}_l$  and  $\tau_{x+z} \widehat{\rho}_l$ . Regarding the expectation above, notice that we now only require to bound each term in the sum in  $z$ . In order to prove the two-block estimate, it is thus sufficient to show that for any  $|y| > 2l$

$$\limsup_{l \rightarrow \infty} \limsup_{N \rightarrow \infty} \mathbb{E}_\alpha^* \left( \frac{1}{N^2} \sum_{x \in \mathbb{T}_N^2} \left\| \tau_{x+y} \widehat{\rho}_l - \tau_x \widehat{\rho}_l \right\| f \right) = 0.$$

As in the proof of the one-block estimate, the quantity above can be rewritten

$$\mathbb{E}_\alpha^* \left( \left\| \tau_y \widehat{\rho}_l - \widehat{\rho}_l \right\| \bar{f} \right),$$

where  $\bar{f} = N^{-2} \sum_{x \in \mathbb{T}_N^2} \tau_x f$  is the average of the density  $f$ . As in the one-block estimate, we can introduce the cutoff functions  $\mathbb{1}_{E_l}$  in the expectation above, thanks to  $f$  satisfying (3.4) and  $\left\| \tau_y \widehat{\rho}_l - \widehat{\rho}_l \right\|$  being a bounded quantity.

Let  $B_{y,l}$  be the set  $B_l \cup \tau_y B_l$ , the quantity under the expectation above is measurable with respect to the spins in  $B_{y,l}$ . Before going further, let us denote, for any configuration  $\widehat{\eta} \in \Sigma_N$ ,  $\widehat{\eta}_1$  the configuration restricted to  $B_l$  and  $\widehat{\eta}_2$  the configuration restricted to  $y + B_l = \tau_y B_l$ . We also denote



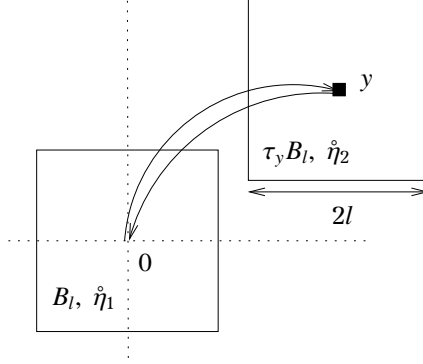

Figure 5

by  $\hat{\eta}$  the configuration  $(\hat{\eta}_1, \hat{\eta}_2)$  on  $B_{y,l}$ . Let us finally write  $\mu_{y,l}$  for the projection of the product measure  $\mu_\alpha^*$  on  $B_{y,l}$ , and  $\mathbb{E}_{y,l}$  the expectation with respect to the latter.

With these notations, the expectation above can be replaced by

$$\mathbb{E}_\alpha^* \left( \left\| \tau_y \widehat{\rho}_l - \widehat{\rho}_l \right\| \mathbb{1}_{E_l} \bar{f}_{y,l} \right),$$

where for any density  $f$ ,  $f_{y,l}$  is its conditional density with respect to the spins in  $B_{y,l}$

$$f_{y,l}(\hat{\eta}) = \frac{1}{\mathbb{E}_{y,l}(\hat{\eta})} \mathbb{E}_\alpha^* \left( \mathbb{1}_{\{\widehat{\eta}|_{B_{y,l}} = \hat{\eta}\}} \cdot f \right),$$

which is well-defined because the two boxes  $B_l$  and  $\tau_y B_l$  are disjoint, thanks to the condition  $|y| > 2l$ .

As in the proof of the one-block estimate, we now need to estimate the Dirichlet form of  $\bar{f}_{y,l}$  in terms of that of  $f$ , on which we have some control. For that purpose, let us introduce with the notations of the previous Section

$$\begin{aligned} D_{l,y}(h) &= -\mathbb{E}_{y,l}(h \cdot \mathcal{L}_{0,y} h) - \sum_{\substack{x,z \in B_l \\ |x-z|=1}} \mathbb{E}_{y,l}(h \cdot \mathcal{L}_{x,z} h) - \sum_{\substack{x,z \in y+B_l \\ |x-z|=1}} \mathbb{E}_{y,l}(h \cdot \mathcal{L}_{x,z} h) \\ &:= D_{l,y}^0 + D_{l,y}^1 + D_{l,y}^2 \end{aligned} \quad (3.13)$$

the Dirichlet form corresponding to particle transfers inside the two boxes, and allowing a particle to transfer from the center of one box to the center of the other, according to Figure 5. The work of the previous Section allows us to write that

$$-\mathbb{E}_{y,l}(\bar{f}_{y,l} \cdot \mathcal{L}_{x,z} \bar{f}_{y,l}) \leq D^{x,z}(\bar{f}),$$

which implies, if  $D(f) \leq C_0$  that

$$D_{l,y}^1(\bar{f}_{y,l}) + D_{l,y}^2(\bar{f}_{y,l}) \leq 2C_0 \frac{(2l+1)^2}{N^2}, \quad (3.14)$$

by translation invariance of  $\mu_{\widehat{\alpha}}$  and  $\bar{f}$ . We now only need to estimate the third term  $D_{l,y}^0$ . Let us consider a path  $x_0 = 0, x_1, \dots, x_k = y$  of minimal length, such that  $|x_i - x_{i+1}| = 1$  for any

$i \in \{0, \dots, k-1\}$ . For any such path, we have  $k \leq 2N\varepsilon$ , since  $|y| \leq N\varepsilon$ , and we can write

$$D_{l,y}^0(\bar{f}) \leq -\mathbb{E}_\alpha^*(\bar{f}\mathcal{L}_{0,y}\bar{f}) = \frac{1}{2}\mathbb{E}_\alpha^* \left[ |\eta_0 - \eta_y| (\bar{f}(\widehat{\eta}^{0,y}) - \bar{f}(\widehat{\eta}))^2 \right]$$

where  $\widehat{\eta}^{0,y}$  here is the state where the sites in 0 and  $y$  are inverted regardless of the occupation of either site. Since  $\eta_0 - \eta_y$  vanishes whenever both sites 0 and  $y$  are occupied or both are empty, we can for example assume that  $\eta_0 = 1$  and  $\eta_y = 0$ . For any configuration  $\widehat{\eta}^0 = \widehat{\eta}$ , we let for any  $i \in \{1, \dots, k\}$

$$\widehat{\eta}^i = (\widehat{\eta}^{i-1})^{x_{i-1}, x_i}$$

Thanks to the elementary inequality

$$\left( \sum_{j=1}^k a_j \right)^2 \leq k \sum_{j=1}^k a_j^2,$$

and by definition of the sequence  $(\widehat{\eta}^i)_{i=0\dots k}$  (which yields in particular  $\widehat{\eta}^0 = \widehat{\eta}$  and  $\widehat{\eta}^k = \widehat{\eta}^{0,y}$ ), the previous equation yields

$$\begin{aligned} \mathbb{E}_\alpha^* \left[ \eta_0(1 - \eta_y)(\bar{f}(\widehat{\eta}^{0,y}) - \bar{f}(\widehat{\eta}))^2 \right] &\leq k \sum_{j=0}^{k-1} \mathbb{E}_\alpha^* \left[ \eta_0(1 - \eta_y)(\bar{f}(\widehat{\eta}^{i+1}) - \bar{f}(\widehat{\eta}^i))^2 \right] \\ &= k \sum_{j=0}^{k-1} \mathbb{E}_\alpha^* \left[ \eta_{x_i}^i (1 - \eta_{x_{i+1}}^i) \left[ \bar{f}((\widehat{\eta}^i)^{x_i, x_{i+1}}) - \bar{f}(\widehat{\eta}^i) \right]^2 \right] \end{aligned}$$

Since  $\mu_\alpha^*$  is invariant through any change of variable  $\widehat{\eta} \rightarrow \widehat{\eta}^i$ , and since we can easily derive the same kind of inequalities with  $\eta_y(1 - \eta_0)$  instead of  $\eta_0(1 - \eta_y)$ , we obtain that

$$D_l^{0,y}(\bar{f}) = k \sum_{i=0}^{k-1} D^{x_{i+1}, x_i}(\bar{f}) = k^2 N^{-2} D(f) \leq 4\varepsilon^2 D(f) \quad (3.15)$$

thanks to the translation invariance of  $\bar{f}$ . Finally, equations (3.13), (3.14) and (3.15) yield

$$D_{l,y}(\bar{f}_{y,l}) \leq 2C_0 \frac{(2l+1)^2}{N^2} + 4C_0\varepsilon^2, \quad (3.16)$$

which vanishes as  $N \rightarrow \infty$  then  $\varepsilon \rightarrow 0$ . A bound on the entropy analogous to (3.8) is straightforward to obtain. Finally, to prove the two-block estimate, as in the proof of the one-block estimate, we can get back to proving that for any density  $f$  on  $B_{y,l}$  satisfying (3.16),

$$\limsup_{l \rightarrow \infty} \limsup_{\varepsilon \rightarrow 0} \limsup_{N \rightarrow \infty} \sup_{2l < |y| < \varepsilon N} \mathbb{E}_{y,l} \left( \left\| \tau_y \widehat{\rho}_l - \widehat{\rho}_l \right\| \mathbb{1}_{E_l} f \right) = 0.$$

Any such density is ultimately constant on any set with fixed number of particles and angles in the set  $B_{y,l}$  with at least two empty sites. The proof of the two-blocks estimate is thus concluded in the exact same way as in the one-block estimate by projecting along these sets, and then using the equivalence of ensembles.

## 4 Preliminaries to the non-gradient method

The main focus of Sections 4 and 5 is the symmetric part of the displacement process, whose generator  $\mathcal{L}$  requires the non-gradient method. Before engaging in the proof of the non-gradient estimates, however, we regroup several results which will be needed throughout the proof.

### 4.1 An integration by parts formula in the context of particle systems

Considering the symmetric exclusion generator  $\mathcal{L}$  as a discrete Laplacian, throughout the proof, we are going to need an integration by parts formula in order to express the expectation of  $\psi \cdot h$  in terms of the gradient of  $h$  and the "integral"  $\nabla \mathcal{L}^{-1} \psi$  of  $\psi$ .

We first extend the definition of the canonical measures given in Definition 2.6 to any domain  $B \subset \mathbb{T}_N^2$ . For that purpose, consider an integer  $K \leq |B|$ , and an orderless family  $\{\theta_1, \dots, \theta_K\} \in \mathbb{S}^K$ . Recall that we denote by  $\widehat{K}$  the pair  $(K, \{\theta_1, \dots, \theta_K\})$ , and we let  $\mu_{B, \widehat{K}}$  be the measure such that the  $K$  particles with fixed angles  $\theta_1, \dots, \theta_K$  are uniformly distributed in the domain  $B$ . If  $B = B_l$  is the ball of radius  $l$ , this notation is shortened as  $\mu_{l, \widehat{K}}$  in accord with Definition 2.6. The expectation w.r.t both of these measures is respectively denoted  $\mathbb{E}_{B, \widehat{K}}$  and  $\mathbb{E}_{l, \widehat{K}}$ . We will, in a similar fashion, write

$$\mathcal{L}_B f(\widehat{\eta}) = \sum_{\substack{x, x+z \in B \\ |z|=1}} \eta_x (1 - \eta_{x+z}) (f(\widehat{\eta}^{x, x+z}) - f(\widehat{\eta})),$$

for the generator of the symmetric exclusion process restricted to  $B$ , shortened as  $\mathcal{L}_l$  if  $B = B_l$ .

Our focus from now on will be a class of local functions, depending only on sites within a domain  $B$ , and with mean 0 w.r.t all canonical measures  $\mu_{B, \widehat{K}}$ . When there are less than one empty site in the domain  $B$ , we require these functions to vanish in order to avoid classifying the irreducible subsets of  $\Sigma_N$  when there is only one empty site. For any cylinder function  $\psi \in \mathcal{C}$ , we will denote by  $s_\psi$  the smallest integer such that  $\psi$  only depends on sites in  $B_{s_\psi}$ , and recall that we already introduced in Definition 2.6 the sets  $\mathbb{K}_l$  and  $\widetilde{\mathbb{K}}_l$ . We now define

$$\widetilde{\mathcal{C}}_0 = \left\{ \psi \in \mathcal{C}, \mathbb{E}_{s_\psi, \widehat{K}}(\psi) = 0 \quad \forall \widehat{K} \in \widetilde{\mathbb{K}}_{s_\psi} \quad \text{and} \quad \psi|_{\Sigma_l^{\widehat{K}}} \equiv 0 \quad \forall \widehat{K} \in \mathbb{K}_{s_\psi} \setminus \widetilde{\mathbb{K}}_{s_\psi} \right\}.$$

In particular, any function  $\psi \in \widetilde{\mathcal{C}}_0$  has mean zero w.r.t any canonical measure. Note that for any  $\psi \in \widetilde{\mathcal{C}}_0$ , and any  $\widehat{\alpha} \in \mathcal{M}_1(\mathbb{S})$ , conditioning w.r.t. the number of particles in  $B_{s_\psi}$ , we obtain in particular that  $\mathbb{E}_{\widehat{\alpha}}(\psi) = 0$ .

The purpose of the non-gradient method is to prove that in the space  $\widetilde{\mathcal{C}}_0$  endowed with an  $H^{-1}$  discrete topology, any element can be expressed as a combination of the instantaneous currents, up to a perturbation of the form  $\mathcal{L}\psi$  for some  $\psi \in \widetilde{\mathcal{C}}_0$  (cf. Proposition 5.32). However, the crude definition of  $\widetilde{\mathcal{C}}_0$  regarding the almost full configuration implies in particular that the instantaneous currents  $j_i = \eta_0 - \eta_{e_i}$  and  $j_i^\omega$ , defined in equation (1.17), are not in  $\widetilde{\mathcal{C}}_0$ .

For that purpose, we therefore consider the enlarged set

$$\mathcal{C}_0 = \widetilde{\mathcal{C}}_0 + \mathcal{J}^\omega, \tag{4.1}$$

where  $J^\omega$  is the linear span of the instantaneous currents due to the symmetric part of the generator, defined in Definition 1.8

$$J^\omega = \left\{ a j_1 + b j_2 + c j_1^\omega + d j_2^\omega, \quad a, b, c, d \in \mathbb{R} \right\}. \quad (4.2)$$

Note that in particular, since the symmetric exclusion process does not create particles, for any  $\psi \in C_0$ , we also have  $\mathcal{L}_{s_\psi} \psi \in C_0$ .

We now have all we need to state an integration by parts formula which will be useful later on in the proof of Theorem 5.1.

**Lemma 4.1** (Integration by parts formula). *Recall that we denoted in (2.4) by  $\nabla_a$  the gradient along an edge  $a$ . Let  $\psi \in \widetilde{C}_0$  be a cylinder function, and  $a \subset B_{s_\psi}$  an oriented edge in its domain. Then,  $\psi$  is in the range of the generator  $\mathcal{L}_{s_\psi}$ , and we can define the "primitive"  $I_a(\psi)$  of  $\psi$  with respect to the gradient along the oriented edge  $a$  as*

$$I_a(\psi) = \frac{1}{2} \nabla_a (-\mathcal{L}_{s_\psi})^{-1} \psi.$$

Furthermore, for any  $B \subset \mathbb{T}_N^2$  containing  $B_{s_\psi}$ , any  $\widehat{K} = (K, (\theta_1, \dots, \theta_K))$  such that  $K \leq |B|$  and  $h \in L^2(\mu_{B, \widehat{K}})$ , we have

$$\mathbb{E}_{B, \widehat{K}}(\psi \cdot h) = \sum_{a \subset B_{s_\psi}} \mathbb{E}_{B, \widehat{K}}(I_a(\psi) \cdot \nabla_a h). \quad (4.3)$$

This result is also true if  $\mu_{B, \widehat{K}}$  is replaced by a grand canonical measure  $\mu_{\widehat{\alpha}}$ . Note that if  $K = |B| - 1$  or  $K = |B|$  the result is trivial because  $\psi$  vanishes.

Furthermore, this integration by parts formula can be extended to the whole  $C_0$ , setting

$$I_a(j_i^\omega) = \begin{cases} -\frac{1}{2} \eta_{a_1}^\omega (1 - \eta_{a_2}) & \text{if } (a_1, a_2) = (0, e_i) \\ \frac{1}{2} \eta_{a_1}^\omega (1 - \eta_{a_2}) & \text{if } (a_1, a_2) = (e_i, 0) \\ 0 & \text{else.} \end{cases}$$

and

$$I_a(j_i) = \begin{cases} -\frac{1}{2} \eta_{a_1} (1 - \eta_{a_2}) & \text{if } (a_1, a_2) = (0, e_i) \\ \frac{1}{2} \eta_{a_1} (1 - \eta_{a_2}) & \text{if } (a_1, a_2) = (e_i, 0) \\ 0 & \text{else.} \end{cases}.$$

*Proof of Lemma 4.1 :* The proof of the previous result is quite elementary. Fix a function  $\psi \in \widetilde{C}_0$ , to prove the integration by parts formula, we first show that  $\psi$  is in the range of  $\mathcal{L}_{s_\psi}$ , by building for any  $\widehat{K}$  a function  $\varphi_{\widehat{K}}$  on  $\Sigma_{\widehat{K}}^{s_\psi}$ , verifying  $\mathcal{L}_{s_\psi} \varphi_{\widehat{K}} = \psi|_{\Sigma_{\widehat{K}}^{s_\psi}}$ . This result is well-known for the color-blind exclusion process, but in our case where each particle has an angle, the canonical measures take an unusual form, and we prove it for the sake of exhaustivity.

Consider the vector space  $E_{\widehat{K}} = \mathcal{F}(\Sigma_{\widehat{K}}^{s_\psi}, \mathbb{R})$  of real-valued functions on  $\Sigma_{\widehat{K}}^{s_\psi}$ . The generator  $\mathcal{L}_{s_\psi}$  can then be seen as a linear application

$$\mathcal{L}_{s_\psi} : E_{\widehat{K}} \longrightarrow E_{\widehat{K}} \\ \varphi \longmapsto \mathcal{L}_{s_\psi} \varphi.$$

Consider  $\varphi \in \text{Ker}_{E_{\widehat{K}}}(\mathcal{L}_{s_\psi})$ , we can write in particular that

$$\mathbb{E}_{B_{s_\psi}, \widehat{K}}(\varphi \mathcal{L}_{s_\psi} \varphi) = -\frac{1}{2} \mathbb{E}_{B_{s_\psi}, \widehat{K}} \left( \sum_{\substack{x, z \in B_{s_\psi} \\ |z-x|=1}} \eta_x(1-\eta_z)(\varphi(\widehat{\eta}^{x,z}) - \varphi(\widehat{\eta}))^2 \right) = 0,$$

therefore  $\varphi$  is invariant under the allowed jump of a particle along any edge in  $B_{s_\psi}$ . Assuming now that  $\widehat{K} \in \widetilde{\mathbb{K}}_{s_\psi}$ , (cf. Definition 2.6) this means that any function  $\varphi \in \text{Ker}_{E_{\widehat{K}}}(\mathcal{L}_{s_\psi})$  must be a constant function, because  $\Sigma_{\widehat{K}}^{s_\psi}$  is then irreducible w.r.t. the exclusion dynamics in  $B_{s_\psi}$ , according to Section 2.3. Since any constant function is trivially in  $\text{Ker}_{E_{\widehat{K}}}(\mathcal{L}_{s_\psi})$ , we finally obtain that  $\text{Dim}(\text{Ker}_{E_{\widehat{K}}}(\mathcal{L}_{s_\psi})) = 1$ , therefore elementary algebra yields

$$\{\varphi \in E_{\widehat{K}}, \mathbb{E}_{B_{s_\psi}, \widehat{K}}(\varphi) = 0\} = \text{Im}_{E_{\widehat{K}}}(\mathcal{L}_{s_\psi}).$$

Let us now get back to our function  $\psi \in \widetilde{C}_0$ , by definition of  $\widetilde{C}_0$ , for any  $\widehat{K} \in \widetilde{\mathbb{K}}_{s_\psi}$ ,  $\psi|_{\Sigma_{\widehat{K}}^{s_\psi}} \in F_{\widehat{K}}$ , and there exists a family of functions  $(\varphi_{\widehat{K}})_{\widehat{K} \in \widetilde{\mathbb{K}}}$  such that  $\varphi_{\widehat{K}} : \Sigma_{\widehat{K}}^{s_\psi} \rightarrow \mathbb{R}$ ,

$$\mathcal{L}_{s_\psi} \varphi_{\widehat{K}} = \psi|_{\Sigma_{\widehat{K}}^{s_\psi}}.$$

Since  $\psi$  vanishes when  $B_{s_\psi}$  has one or less empty site, we also let  $\varphi_{\widehat{K}} = 0$  for any  $\widehat{K} \in \mathbb{K}_{s_\psi} \setminus \widetilde{\mathbb{K}}_{s_\psi}$ . For any configuration  $\widehat{\eta}$  on  $B_{s_\psi}$  with  $\widehat{K}$  particles, we now define  $\varphi^*(\widehat{\eta}) = \varphi_{\widehat{K}}(\widehat{\eta})$ , and we have

$$\psi = \mathcal{L}_{s_\psi} \varphi^*,$$

which proves that any function  $\psi \in \widetilde{C}_0$  is in the range of  $\mathcal{L}_{s_\psi}$ .

We get back to the proof of the integration by parts formula, since we can now write  $\psi = \mathcal{L}_{s_\psi} \mathcal{L}_{s_\psi}^{-1} \psi$ , where  $\mathcal{L}_{s_\psi}^{-1} \psi = \varphi^*$ , and

$$\begin{aligned} \mathbb{E}_{B, \widehat{K}}(h, \psi) &= \mathbb{E}_{B, \widehat{K}}(h, \mathcal{L}_{s_\psi} \mathcal{L}_{s_\psi}^{-1} \psi) \\ &= -\frac{1}{2} \sum_{a \subset B_\psi} \mathbb{E}_{B, \widehat{K}}(\nabla_a \mathcal{L}_{s_\psi}^{-1} \psi, \nabla_a h) \\ &= \sum_{a \subset B_\psi} \mathbb{E}_{B, \widehat{K}}(I_a(\psi), \nabla_a h) \end{aligned}$$

which proves identity (4.3). The same is obviously true when the canonical measure is replaced by a grand canonical measure  $\mu_{\widehat{\alpha}}$  for some couple of densities  $\widehat{\alpha}$ , since we only used the invariance of the measure w.r.t the generator  $\mathcal{L}$ , which concludes the proof of the integration by parts formula on  $\widetilde{C}_0$ .

Furthermore, the extension to  $C_0$  follows immediately from a simple change of variable  $\widehat{\eta} \mapsto \widehat{\eta}^{0, e_i}$ . ■

## 4.2 Spectral gap for the symmetric exclusion spin process

As investigated in Section 2.3, the mixing time for the exclusion dynamics on configurations with angles is not of order  $N^2$ . We therefore cannot consider a general class of functions as dependent on the  $\theta_x$ 's as wanted, and need to restrict to a subclass of functions with low levels of correlations between particle angles, but large enough for the non-gradient method to apply. In this Section, we prove that the spectral gap of the symmetric exclusion process on this class of functions is of order  $N^{-2}$ . This result is derived by Quastel in [Qua92]. We present here a more detailed and slightly modified version. It states that once restricted to a convenient class of semi angle-blind functions, the spin exclusion process has a spectral gap of order  $N^{-2}$ .

Throughout this Section, we consider the square domain

$$A_N = \llbracket 0, N \rrbracket^2$$

with closed boundaries, and denote by  $\mu_{\widehat{\alpha}}^{A_N}$  the product measure with angle measure  $\widehat{\alpha} \in \mathcal{M}_1(\mathbb{S})$ . Recall that  $\mathcal{S}$  was introduced in Definition 1.1 as the set of cylinder angle-blind functions, and that  $\omega$  is the angular dependency of our test function  $H$  (cf. equation (1.15)), we define the subspace of  $\mathcal{S}$

$$T_0^\omega = \left\{ f \in L^2(\mu_{\widehat{\alpha}}^{A_N}), \quad f(\widehat{\eta}) = \varphi(\eta) + \sum_{x \in A_N} (c_1 \eta_x^\omega + c_2 \eta_x) \psi_x(\eta), \quad c_1, c_2 \in \mathbb{R}, \text{ and } \psi_x \in \mathcal{S}, \forall x \in \mathbb{Z}^2, \varphi \in \mathcal{S} \right\} \quad (4.4)$$

**Remark 4.2.** The purpose of the non-gradient method is to replace the instantaneous current  $j_i^\omega$  introduced in equation (1.17) by a gradient quantity  $D(\eta_0 - \eta_{e_i}) + d(\eta_0^\omega - \eta_{e_i}^\omega)$ , and the class  $T_0^\omega$  above is the simplest set of functions, stable by  $\mathcal{L}$  and containing both the currents and the gradients.

**Remark 4.3.** One might expect, that it is not the biggest class of functions on which a spectral gap of order  $N^{-2}$  can be obtained. Indeed, we believe that introducing some finite numbered correlations between spins might not alter too much the order of the spectral gap. It is not, however, the purpose of this Section, and this remark is therefore left as a conjecture at this point.

**Proposition 4.4** (Estimate on the spectral gap for the spin-dependent exclusion process). *For any angle measure  $\widehat{\alpha} \in \mathcal{M}_1(\mathbb{S})$  such that  $0 < \alpha < 1$ , there exists a constant  $C = C(\alpha)$  such that for any functions  $f \in T_0^\omega$  with  $\mathbb{E}_{\widehat{\alpha}}(f) = 0$ ,*

$$\mathbb{E}_{\widehat{\alpha}}(f^2) \leq CN^2 \mathcal{D}(f),$$

where  $\mathcal{D}(f) = \mathcal{D}_{\widehat{\alpha}}(f) = -\mathbb{E}_{\widehat{\alpha}}(f \mathcal{L}f)$  is the Dirichlet form relative to the symmetric part of the exclusion generator on the non-periodic domain  $A_N$ .

In order to prove this estimate, we need the following lemma, which states that the angle-blind process has a spectral gap of order  $N^{-2}$ .

**Lemma 4.5** (Spectral gap for the angle-blind exclusion process). *For any angle measure  $\widehat{\alpha} \in \mathcal{M}_1(\mathbb{S})$  such that  $0 < \alpha < 1$ , there exists a constant  $C = C(\alpha)$  such that for any angle-blind function  $\psi \in \mathcal{S}$  with  $\mathbb{E}_{\widehat{\alpha}}(\psi) = 0$*

$$\mathbb{E}_{\widehat{\alpha}}(\psi^2) \leq CN^2 \mathcal{D}(\psi).$$

The proof of this result can be found in [KL99]. Before deriving Proposition 4.4, we define for any site  $x \in \mathbb{Z}^2$

$$\tilde{\eta}_x = \eta_x^\omega - \mathbb{E}_{\tilde{\alpha}}(\omega)\eta_x = [\omega(\theta_x) - \mathbb{E}_{\tilde{\alpha}}(\omega)]\eta_x, \quad (4.5)$$

where we shortened  $\mathbb{E}_{\tilde{\alpha}}(\omega)$  for  $\mathbb{E}_{\tilde{\alpha}}(\omega(\theta_0))$ . This new occupation variable plays a particular role in the proof of the spectral gap, and we state in the following Lemma two useful identities regarding  $\tilde{\eta}$ , which will be used repeatedly later on.

**Lemma 4.6** (Properties of  $\tilde{\eta}$ ). *let  $x \neq y \in A_N$  be two distinct sites, and consider an angle-blind function  $\psi \in \mathcal{S}$ , we have*

$$\mathbb{E}_{\tilde{\alpha}}(\tilde{\eta}_x\psi) = 0 \quad \text{and} \quad \mathbb{E}_{\tilde{\alpha}}(\tilde{\eta}_x\tilde{\eta}_y\psi) = 0.$$

Furthermore, assuming that  $\psi = \eta_x\psi$  (i.e. that  $\psi$  vanishes when the site  $x$  is empty), we also have

$$\mathbb{E}_{\tilde{\alpha}}(\tilde{\eta}_x^2\psi) = \overline{C}(\tilde{\alpha})\mathbb{E}_{\tilde{\alpha}}(\psi),$$

where  $\overline{C}(\tilde{\alpha}) = \text{Var}_{\tilde{\alpha}}(\omega(\theta_0))$ .

The proof of Lemma 4.6 is immediate and omitted, since under  $\mu_{\tilde{\alpha}}$ , and for any angle-blind function  $\psi \in \mathcal{S}$  and any function  $\Phi$  on  $\mathbb{S}$ , we have

$$\mathbb{E}_{\tilde{\alpha}}(\eta_x^\Phi\psi) = \mathbb{E}_{\tilde{\alpha}}(\Phi)\mathbb{E}_{\tilde{\alpha}}(\eta_x\psi).$$

We get back to the proof of the spectral gap of the spin process.

*Proof of Proposition 4.4 :* First note that we can decompose any function  $f = f(c_1, c_2)$  in  $T_0^\omega$  as  $f = \tilde{f} + f_{sb}$ , where

$$\tilde{f} = c_1 \sum_{x \in A_N} \tilde{\eta}_x\psi_x(\eta) \quad \text{and} \quad f_{sb} = (c_1\mathbb{E}_{\tilde{\alpha}}(\omega) + c_2) \sum_{x \in A_N} \eta_x\psi_x(\eta).$$

We first show that  $\tilde{f}$  and  $f_{sb}$  are orthogonal in  $L^2(\mu_{\tilde{\alpha}})$ . Considering a function  $f \in T_0^\omega$  with mean zero and thanks to the decomposition above,

$$\mathbb{E}_{\tilde{\alpha}}(\tilde{f}f_{sb}) = C \sum_{x \in A_N} \mathbb{E}_{\tilde{\alpha}} \left( \tilde{\eta}_x \left[ \sum_{y \in A_N} \eta_y\psi_x\psi_y \right] \right)$$

vanishes thanks to the first identity in Lemma 4.6 and

$$\mathbb{E}_{\tilde{\alpha}}(f^2) = \mathbb{E}_{\tilde{\alpha}}(\tilde{f}^2) + \mathbb{E}_{\tilde{\alpha}}(f_{sb}^2).$$

With the same reasoning, it is not hard to see that  $\mathbb{E}_{\tilde{\alpha}}(f_{sb}\mathcal{L}\tilde{f}) = \mathbb{E}_{\tilde{\alpha}}(\tilde{f}\mathcal{L}f_{sb}) = 0$ , thus we can also write

$$\mathbb{E}_{\tilde{\alpha}}(f\mathcal{L}f) = \mathbb{E}_{\tilde{\alpha}}(\tilde{f}\mathcal{L}\tilde{f}) + \mathbb{E}_{\tilde{\alpha}}(f_{sb}\mathcal{L}f_{sb}),$$

i.e  $\mathcal{D}(f) = \mathcal{D}(\tilde{f}) + \mathcal{D}(f_{sb})$ . Thanks to Lemma 4.5, to get Proposition 4.4, it is therefore sufficient to show the result for any function  $f = \sum_{x \in A_N} \tilde{\eta}_x\psi_x(\eta)$ . We can also assume without loss of generality that for any  $x$ ,  $\psi_x \mathbb{1}_{\eta_x=0} = 0$ , since when the site is empty the corresponding contribution vanishes. For any such  $f$ ,

$$\mathbb{E}_{\tilde{\alpha}}(f^2) = \sum_{x, y \in A_N} \mathbb{E}_{\tilde{\alpha}}(\tilde{\eta}_x\tilde{\eta}_y\psi_x\psi_y).$$

Thanks to Lemma 4.6 and to our assumption on the  $\psi_x$ 's, the expectation above vanishes whenever  $x \neq y$ . Furthermore,

$$\mathbb{E}_{\widehat{\alpha}}(\widetilde{\eta}_x^2 \psi_x^2) = \overline{C}(\widehat{\alpha}) \mathbb{E}_{\widehat{\alpha}}(\psi_x^2),$$

therefore

$$\mathbb{E}_{\widehat{\alpha}}(f^2) = \overline{C}(\widehat{\alpha}) \sum_{x \in A_N} \mathbb{E}_{\widehat{\alpha}}(\psi_x^2). \quad (4.6)$$

We now turn our attention to  $\mathbb{E}_{\widehat{\alpha}}(f \mathcal{L}f)$ . For any site  $x$  and any angle-blind function  $\psi \in \mathcal{S}$ , we can write

$$\mathcal{L}(\widetilde{\eta}_x \psi) = \widetilde{\eta}_x \mathcal{L}\psi + \sum_{|z|=1} \mathbb{1}_{\{\eta_x \eta_{x+z}=0\}} \psi(\widetilde{\eta}^{x,x+z}) (\widetilde{\eta}_x^{x,x+z} - \widetilde{\eta}_x).$$

If we assume that  $\psi$  vanishes when the site  $x$  is empty,

$$\mathbb{1}_{\{\eta_x \eta_{x+z}=0\}} \psi(\widetilde{\eta}^{x,x+z}) = \mathbb{1}_{\{\eta_x=0, \eta_{x+z}=1\}} \psi(\widetilde{\eta}^{x,x+z}),$$

and the quantity above can be rewritten

$$\mathcal{L}(\widetilde{\eta}_x \psi) = \widetilde{\eta}_x \mathcal{L}\psi + \bar{h}(\psi, x, \cdot),$$

where we denoted

$$\bar{h}(\psi, x, \eta) = \sum_{|z|=1} \mathbb{1}_{\{\eta_x=0, \eta_{x+z}=1\}} \psi(\widetilde{\eta}^{x,x+z}) \widetilde{\eta}_{x+z} = \sum_{|z|=1} \widetilde{\eta}_{x+z} (1 - \eta_x) \psi(\widetilde{\eta}^{x,x+z}).$$

It follows that

$$-\mathbb{E}_{\widehat{\alpha}}(f \mathcal{L}f) = \sum_{x,y \in A_N} \left[ -\mathbb{E}_{\widehat{\alpha}}(\widetilde{\eta}_x \widetilde{\eta}_y \psi_x \mathcal{L}\psi_y) - \mathbb{E}_{\widehat{\alpha}}(\widetilde{\eta}_x \psi_x \bar{h}(\psi_y, y, \cdot)) \right].$$

Since  $\psi_x \mathcal{L}\psi_y$  is still an angle-blind function, the first term in the right-hand side above vanishes as soon as  $x \neq y$ , whereas if  $x = y$ , it is equal by Lemma 4.6 to

$$-\mathbb{E}_{\widehat{\alpha}}(\widetilde{\eta}_x^2 \psi_x \mathcal{L}\psi_x) = \overline{C}(\widehat{\alpha}) \mathcal{D}(\psi_x),$$

because  $\psi_x \mathcal{L}\psi_x$  still vanishes whenever the site  $x$  is unoccupied. Furthermore, by definition of  $\bar{h}$ ,

$$\mathbb{E}_{\widehat{\alpha}}(\widetilde{\eta}_x \psi_x \bar{h}(\psi_y, y, \cdot)) = \sum_{|z|=1} \mathbb{E}_{\widehat{\alpha}}(\widetilde{\eta}_x \widetilde{\eta}_{y+z} \overbrace{(1 - \eta_y) \psi_x(\widetilde{\eta}) \psi_y(\widetilde{\eta}^{y,y+z})}^{\text{function of } \eta}),$$

and as before, this expectation vanishes as soon as  $x \neq y + z$ . The only remaining terms are those for which  $y$  and  $x$  are neighbors, therefore

$$\begin{aligned} \sum_{x,y \in A_N} \mathbb{E}_{\widehat{\alpha}}(\widetilde{\eta}_x \psi_x \bar{h}(\psi_y, y, \cdot)) &= \sum_{x \in A_N, |z|=1} \mathbb{E}_{\widehat{\alpha}}(\widetilde{\eta}_x^2 (1 - \eta_{x+z}) \psi_x \psi_{x+z} (\widetilde{\eta}^{x,x+z})) \\ &= \overline{C}(\widehat{\alpha}) \sum_{x \in A_N, |z|=1} \mathbb{E}_{\widehat{\alpha}}((1 - \eta_{x+z}) \psi_x \psi_{x+z} (\widetilde{\eta}^{x+z,x})). \end{aligned} \quad (4.7)$$

Since  $\mathcal{D}(\phi) = -\mathbb{E}_{\widehat{\alpha}}(\phi \mathcal{L}\phi)$ , up to this point we have obtained that

$$\mathcal{D}(f) = \overline{C}(\widehat{\alpha}) \sum_{x \in A_N} \left[ \mathcal{D}(\psi_x) - \sum_{|z|=1} \mathbb{E}_{\widehat{\alpha}}((1 - \eta_{x+z}) \psi_x \psi_{x+z} (\widetilde{\eta}^{x,x+z})) \right]. \quad (4.8)$$



Let us introduce the Dirichlet form locally cropped in  $x$

$$\mathcal{D}_x^*(\psi) = \frac{1}{2} \mathbb{E}_{\widehat{\alpha}} \left( \sum_{\substack{y \in A_N, |z|=1 \\ y, y+z \neq x}} \eta_y (1 - \eta_{y+z}) (\psi(\widehat{\eta}^{y, y+z}) - \psi(\widehat{\eta}))^2 \right), \quad (4.9)$$

which forbids jumps to and from the site  $x$ . Since  $\psi_x$  vanishes whenever the site  $x$  is empty, the quantity  $\eta_x (1 - \eta_{x+z}) (\psi_x(\widehat{\eta}^{x, x+z}) - \psi_x(\widehat{\eta}))^2$  is also equal to  $(1 - \eta_{x+z}) \psi_x(\widehat{\eta})^2$ , and a similar argument with  $\psi_{x+z}$  allows us to rewrite equation (4.8)

$$\mathcal{D}(f) = \overline{C}(\widehat{\alpha}) \sum_{x \in A_N} \left[ \mathcal{D}_x^*(\psi_x) + \frac{1}{2} \sum_{|z|=1} \mathbb{E}_{\widehat{\alpha}} \left( (1 - \eta_{x+z}) [\psi_{x+z}(\widehat{\eta}^{x, x+z}) - \psi_x(\widehat{\eta})]^2 \right) \right].$$

To obtain Theorem 4.4, thanks to the identity above combined to (4.6) it is enough to prove that for some constant  $C$

$$\sum_{x \in A_N} \mathbb{E}_{\widehat{\alpha}}(\psi_x^2) \leq CN^2 \sum_{x \in A_N} \left[ \mathcal{D}_x^*(\psi_x) + \sum_{|z|=1} \mathbb{E}_{\widehat{\alpha}} \left( (1 - \eta_{x+z}) [\psi_{x+z}(\widehat{\eta}^{x, x+z}) - \psi_x(\widehat{\eta})]^2 \right) \right]. \quad (4.10)$$

**Lemma 4.7** (Spectral gap for the exclusion process with a frozen site). *Let us consider a fixed site  $x \in A_N$ . For any  $\widehat{\alpha} \in \mathcal{M}_1(\mathcal{S})$  such that  $0 < \alpha < 1$ , there exists a constant  $C = C(\alpha)$  such that for any angle-blind function  $\psi \in \mathcal{S}$  with  $\mathbb{E}_{\widehat{\alpha}}(\psi | \eta_x = 1) = 0$*

$$\mathbb{E}_{\widehat{\alpha}}(\psi^2 | \eta_x = 1) \leq CN^2 \mathcal{D}_x^*(\psi | \eta_x = 1),$$

where the conditioned Dirichlet form is defined by the conditional expectation  $\mathbb{E}_{\widehat{\alpha}}(\cdot | \eta_x = 1)$  instead of  $\mathbb{E}_{\widehat{\alpha}}$ ,

$$\mathcal{D}_x^*(\psi | \eta_x = 1) = -\mathbb{E}_{\widehat{\alpha}}(\psi \mathcal{L} \psi | \eta_x = 1).$$

*Proof of Lemma 4.7 :* We do not give the detail of this proof. It is quite similar to the proof without the frozen site for an angle-blind function, the only difference being that whenever a path should go through the site  $x$ , the path is bypassed around it, which results in a larger constant  $C$  but does not affect the order  $N^2$ . ■

We now take a look at the left-hand side of Equation (4.10). Since  $\psi_x$  vanishes whenever  $\eta_x = 0$  we have  $\mathbb{E}_{\widehat{\alpha}}(\psi_x | \eta_x = 1) = \alpha^{-1} \mathbb{E}_{\widehat{\alpha}}(\psi_x)$ , the previous Lemma applied to  $\psi_x - \mathbb{E}_{\widehat{\alpha}}(\psi_x | \eta_x = 1)$  yields

$$\sum_{x \in A_N} \mathbb{E}_{\widehat{\alpha}}(\psi_x^2) - \frac{1}{\alpha} \mathbb{E}_{\widehat{\alpha}}(\psi_x)^2 \leq CN^2 \sum_{x \in A_N} \mathcal{D}_x^*(\psi_x). \quad (4.11)$$

Notice that since  $\sum_{x \in A_N} \widetilde{\eta}_x$  is constant for the simple exclusion dynamic on  $A_N$ , we can add or subtract to  $f$  the function  $\sum_{x \in A_N} \widetilde{\eta}_x \bar{\psi}$ , where  $\bar{\psi} = N^{-2} \sum_{x \in A_N} \psi_x$  at the cost of an angle-blind function. We can therefore safely assume that  $\sum_{x \in A_N} \psi_x = 0$ . Since

$$\sum_{x, y \in A_N} [\mathbb{E}_{\widehat{\alpha}}(\psi_x) - \mathbb{E}_{\widehat{\alpha}}(\psi_y)]^2 = \sum_{x, y \in A_N} [\mathbb{E}_{\widehat{\alpha}}(\psi_x)^2 + \mathbb{E}_{\widehat{\alpha}}(\psi_y)^2] - 2 \sum_{x, y \in A_N} \mathbb{E}_{\widehat{\alpha}}(\psi_x) \mathbb{E}_{\widehat{\alpha}}(\psi_y)$$

$$= 2N^2 \sum_x \mathbb{E}_{\widehat{\alpha}}(\psi_x)^2,$$

since the last term of the first line vanishes thanks to our previous assumption. Furthermore, consider the family of paths  $(\gamma_{x,y})_{x,y \in A_N}$  going from  $x$  to  $y$ , defined thusly : starting from  $x$ , the path  $\gamma_{x,y}$  starts straight in the first direction, until reaching the first coordinate of  $y$ . then, it goes in the second direction until reaching  $y$ . With this construction, each edge  $a$  is used at most  $N^3$  times in the  $\gamma_{x,y}$ 's. Letting  $n_a$  be the number of times the edge  $a$  is used in one of the paths  $\gamma_{x,y}$ , we hence have  $n_a \leq CN^3 \forall a$ . Furthermore, each path  $\gamma_{x,y}$  has length at most  $2N$ . With this construction, we therefore write, since

$$\psi_x - \psi_y = \sum_{a=(a_1,a_2) \in \gamma_{x,y}} (\psi_{a_1} - \psi_{a_2}),$$

and  $(\sum_{k=1}^n x_k)^2 \leq n \sum_{k=1}^n x_k^2$  that

$$\begin{aligned} \sum_{x,y \in A_N} [\mathbb{E}_{\widehat{\alpha}}(\psi_x) - \mathbb{E}_{\widehat{\alpha}}(\psi_y)]^2 &\leq \sum_{x,y \in A_N} 2N \sum_{(a_1,a_2) \in \gamma_{x,y}} [\mathbb{E}_{\widehat{\alpha}}(\psi_{a_1}) - \mathbb{E}_{\widehat{\alpha}}(\psi_{a_2})]^2 \\ &= 2N \sum_{(a_1,a_2) \subset A_N} n_a [\mathbb{E}_{\widehat{\alpha}}(\psi_{a_1}) - \mathbb{E}_{\widehat{\alpha}}(\psi_{a_2})]^2 \\ &\leq 2N^4 \sum_{(a_1,a_2) \subset A_N} [\mathbb{E}_{\widehat{\alpha}}(\psi_{a_1}) - \mathbb{E}_{\widehat{\alpha}}(\psi_{a_2})]^2 \\ &= 2N^4 \sum_{x \in A_N, |z|=1} [\mathbb{E}_{\widehat{\alpha}}(\psi_{x+z}) - \mathbb{E}_{\widehat{\alpha}}(\psi_x)]^2. \end{aligned}$$

Using the two previous identities, we obtain that

$$\sum_{x \in A_N} \mathbb{E}_{\widehat{\alpha}}(\psi_x)^2 \leq N^2 \sum_{x \in A_N, |z|=1} [\mathbb{E}_{\widehat{\alpha}}(\psi_{x+z}) - \mathbb{E}_{\widehat{\alpha}}(\psi_x)]^2. \quad (4.12)$$

Let us consider  $Z(x)$  the empty site nearest to  $x$ , chosen arbitrarily if there are multiple candidates. We want to reach from  $\eta$  a configuration with an empty site in  $x+z$  to offer some counterweight to the second term  $\bar{h}$  in the left-hand side above. To do so, we merely have to "move" the empty site from  $Z(x)$  to  $x+z$ , without crossing any edge twice, which can be done in  $n \leq 2(|Z(x) - x| + 1)$  allowed jumps along the edges  $a_1, \dots, a_n$ . Furthermore, we can also assume that no such edge is of the form  $(x, x+z)$  since to bring the empty site to  $x+z$ , one only has to go around the site  $x$ . For any integer  $r \leq n$  let  $\widehat{\eta}^{(r)} = \widehat{\eta}^{a_1 \dots a_r}$  be the configuration where the empty site has traveled along  $r$  edges. We denote  $\widehat{\eta}^{(0)} = \eta$ , and notice that  $\widehat{\eta}_{x+z}^{(n)} = 0$ . Furthermore, for any function  $h$ , since every successive jump is allowed (each initial site is occupied, each end site is empty) we have

$$(1 - \widehat{\eta}_{x+z}^{(n)}) h(\widehat{\eta}^{(n)}) = h(\widehat{\eta}^{(n)}) = h(\widehat{\eta}) + \sum_{r=1}^n h(\widehat{\eta}^{(r)}) - h(\widehat{\eta}^{(r-1)}) = h(\widehat{\eta}) + \sum_{r=1}^n \nabla_{a_r} h(\widehat{\eta}^{(r-1)}),$$

with  $\nabla_a$  the gradient defined at the start of Section 4.1. We can rewrite this identity

$$h(\widehat{\eta}) = (1 - \widehat{\eta}_{x+z}^{(n)}) h(\widehat{\eta}^{(n)}) - \sum_{r=1}^n \nabla_{a_r} h(\widehat{\eta}^{(r-1)}).$$

Note that in the formula above, both the  $n$  and the  $\widehat{\eta}^{(r)}$ 's depend on  $\eta$ , since they depend on the position of the nearest empty site. From here, letting respectively  $h = \psi_x$  and  $h = \psi_{x+z}(\widehat{\eta}^{x,x+z})$ , for which we can choose a sequence of bonds  $(a_r)$ , we obtain

$$\begin{aligned} \mathbb{E}_{\widehat{\alpha}}(\psi_{x+z}) - \mathbb{E}_{\widehat{\alpha}}(\psi_x) &= \mathbb{E}_{\widehat{\alpha}}(\psi_{x+z}(\widehat{\eta}^{x,x+z}) - \psi_x) \\ &= \mathbb{E}_{\widehat{\alpha}}\left(\sum_{r=1}^n \left[\nabla_{a_r} \psi_x(\widehat{\eta}^{(r-1)}) - \nabla_{a_r} \psi_{x+z}((\widehat{\eta}^{x,x+z})^{(r-1)})\right]\right) \\ &\quad + \mathbb{E}_{\widehat{\alpha}}\left(\left(1 - \widehat{\eta}_{x+z}^{(n)}\right) \left[\psi_{x+z}((\widehat{\eta}^{x,x+z})^{(n)}) - \psi_x(\widehat{\eta}^{(n)})\right]\right). \end{aligned} \quad (4.13)$$

The first part of the quantity above can be controlled thanks to the Dirichlet form of the  $\psi_x$ 's. Indeed, restricting to the configurations  $\widehat{\eta}$  with at least one empty site (if not,  $f = 0$ , and the result is trivially true)

$$\begin{aligned} \mathbb{E}_{\widehat{\alpha}}\left(\sum_{r=1}^{n(Z(x))} \nabla_{a_r} \psi_x(\widehat{\eta}^{(r-1)})\right) &= \sum_{x_0 \in A_N} \sum_{r=1}^{n(x_0)} \mathbb{E}_{\widehat{\alpha}}\left(\mathbb{1}_{\{Z(x)=x_0\}} \nabla_{a_r} \psi_x(\widehat{\eta}^{(r-1)})\right) \\ &\leq \sum_{x_0 \in A_N} \sum_{r=1}^{n(x_0)} \mathbb{E}_{\widehat{\alpha}}\left(\mathbb{1}_{\{Z(x)=x_0\}}\right)^{1/2} \mathbb{E}_{\widehat{\alpha}}\left([\nabla_{a_r} \psi_x(\widehat{\eta}^{(r-1)})]^2\right)^{1/2} \\ &\leq \sum_{x_0 \in A_N} \mathbb{P}_{\widehat{\alpha}}\left(\mathbb{1}_{\{Z(x)=x_0\}}\right)^{1/2} \sum_{r=1}^{n(x_0)} \mathbb{E}_{\widehat{\alpha}}\left([\nabla_{a_r} \psi_x]^2\right)^{1/2} \\ &\leq \sum_{l \leq N/2} \sum_{|x-x_0|=l} \mathbb{P}_{\widehat{\alpha}}\left(\mathbb{1}_{\{Z(x)=x_0\}}\right)^{1/2} Cl^2 \mathbb{E}_{\widehat{\alpha}}\left(\sum_{\substack{a \in B_l(x) \\ a \neq (x,x+z)}} [\nabla_a \psi_x]^2\right)^{1/2}, \end{aligned}$$

for some universal constant  $C$ . In the last inequality, we used that  $\sum_{i=1}^n \sqrt{x_i} \leq n \sqrt{\sum_{i=1}^n x_i}$ , and the fact that each edge in the  $a_i$ 's is used at most once, and that the number of edges in a box of side length  $2l+1$  edges is of order  $l^2$ . Since the probability that  $Z(x) = x_0$  is bounded from above by  $(1-\alpha)^{\binom{|x-x_0|-1}{2}}$ , we finally obtain that

$$\mathbb{E}_{\widehat{\alpha}}\left(\sum_{r=1}^{n(Z(x))} \nabla_{a_r} \psi_x(\widehat{\eta}^{(r-1)})\right) \leq \sum_{l \leq N/2} Cl^3 (1-\alpha)^{(l-1)^2} \mathcal{D}_{x,l}^*(\psi_x)^{1/2} \leq C(\alpha) \mathcal{D}_x^*(\psi_x)^{1/2}, \quad (4.14)$$

where  $\mathcal{D}_x^*$  is the Dirichlet form deprived of the jumps between  $x$  and its neighbors defined in equation (4.9), and  $\mathcal{D}_{x,l}^*$  is the restriction of  $\mathcal{D}_x^*$  to jumps in the box of side  $2l+1$  centered in  $x$ . We obtain in a similar fashion, using this time a sequence of bonds  $(a_r)$  moving the nearest empty site to  $x$  this time, avoiding the sites around  $x+z$ ,

$$\mathbb{E}_{\widehat{\alpha}}\left(-\sum_{r=1}^n \nabla_{a_r} \psi_{x+z}((\widehat{\eta}^{x,x+z})^{(r-1)})\right) \leq C(\alpha) \mathcal{D}_{x+z}(\psi_{x+z})^{1/2}. \quad (4.15)$$

Finally, we can write

$$\begin{aligned} \mathbb{E}_{\widehat{\alpha}}\left(\left(1 - \widehat{\eta}_{x+z}^{(n)}\right) \left[\psi_{x+z}((\widehat{\eta}^{x,x+z})^{(n)}) - \psi_x(\widehat{\eta}^{(n)})\right]\right) &= \mathbb{E}_{\widehat{\alpha}}\left(\left(1 - \eta_{x+z}\right) \left[\psi_{x+z}((\widehat{\eta}^{x,x+z})) - \psi_x\right]\right) \\ &\leq \mathbb{E}_{\widehat{\alpha}}\left(\left(1 - \eta_{x+z}\right) \left[\psi_{x+z}((\widehat{\eta}^{x,x+z})) - \psi_x\right]^2\right)^{1/2}. \end{aligned} \quad (4.16)$$

The three bounds (4.14), (4.15) and (4.16) combined with (4.13) guarantee, since

$$(a + b + c)^2 \leq 3(a^2 + b^2 + c^2),$$

that for some different constant  $C$  depending on  $\widehat{\alpha}$ ,

$$\begin{aligned} N^2 \sum_{x \in A_N} \mathbb{E}_{\widehat{\alpha}}[(\psi_{x+z}) - \mathbb{E}_{\widehat{\alpha}}(\psi_x)]^2 &\leq N^2 \sum_{x \in A_N} \left[ C \mathcal{D}_x^*(\psi_x) + \sum_{|z|=1} \mathbb{E}_{\widehat{\alpha}}((1 - \eta_{x+z})(\psi_{x+z}(\widehat{\eta}^{x,x+z})) - \psi_x)^2 \right] \\ &\leq C' N^2 \sum_{x \in A_N} \left[ \mathcal{D}_x^*(\psi_x) + \sum_{|z|=1} \mathbb{E}_{\widehat{\alpha}}((1 - \eta_{x+z})(\psi_{x+z}(\widehat{\eta}^{x,x+z})) - \psi_x)^2 \right] \end{aligned}$$

This together with (4.12) and (4.11) then yields that (4.10) holds as desired. This concludes the proof of the spectral gap restricted to the set  $T_0^\omega$ .  $\blacksquare$

### 4.3 Comparison with an equilibrium measure

In this section, we prove a result that will be used several times throughout the proof, and which allows to control the exponential moments of a functional  $X$  by a variational formula involving the equilibrium measure  $\mu_\alpha^*$ . This control is analogous to the so called sector condition for asymmetric processes, which guarantees that the mixing due to the symmetric part of the generator is sufficient to balance out the shocks provoked by the antisymmetric part.

**Remark 4.8.** [Non-stationarity of  $\mu_\alpha^*$  for the weakly asymmetric process] It has already been pointed out that  $\mathcal{L}$  is self-adjoint w.r.t any product measure  $\mu_{\widehat{\alpha}}$ , which is not in general the case of  $\mathcal{L}^{G,\beta=0}$ . However,  $\mathcal{L}^{G,\beta=0}$  is self-adjoint w.r.t.  $\mu_\alpha^*$  due to the uniformity in  $\theta$  of that measure. Asymmetric generators are usually "almost" anti-self-adjoint, in the sense that one could expect  $\mathcal{L}^{\text{wa}*} = -\mathcal{L}^{\text{wa}}$ . This identity is for example true for the TASEP, for which the asymmetry is constant and does not depend on each particle.

It is not true in our case however, due to the exclusion rule and the dependency of the asymmetry in the angle of the particle. To clarify this statement, see the adjoint operator as a time-reversal, and consider a configuration with two columns of particles wanting to cross each other. This configuration would be stuck under  $\mathcal{L}^{\text{wa}}$ , however, under the time-reversed dynamics  $\mathcal{L}^{\text{wa}*}$ , it starts to move. This illustrates that in our model, the asymmetric generator  $\mathcal{L}^{\text{wa}}$  is not anti-self-adjoint.

Let us denote accordingly to the previous notation (1.17) and recalling the definition of the  $\lambda_i$ 's (1.1), for  $i = 1, 2$

$$j_i^{\lambda_i} = \lambda_i(\theta_0)\eta_0(1 - \eta_{e_i}) - \lambda_i(\theta_{e_i})\eta_{e_i}(1 - \eta_0).$$

Elementary computations yield accordingly that the adjoint in  $L^2(\mu_\alpha^*)$  of  $\mathcal{L}^{\text{wa}}$  is in fact given by

$$\mathcal{L}^{\text{wa},*} = -\mathcal{L}^{\text{wa}} + 2 \sum_{x \in \mathbb{T}_N^2} \sum_{i=1,2} \tau_x j_i^{\lambda_i}. \quad (4.17)$$

This identity will be necessary to prove the following result, which compares the measure of the process with drift to the measure  $\mu_\alpha^*$ .

**Lemma 4.9.** Fix a function

$$X : \Sigma_N \times [0, T] \longrightarrow \mathbb{R} \\ (\widehat{\eta}, t) \longmapsto X_t(\widehat{\eta}) .$$

For any  $\gamma > 0$ , we have

$$\frac{1}{\gamma N^2} \log \mathbb{E}_{\mu_\alpha^*}^{\lambda, 0} \left[ \exp \left( \gamma N^2 \int_0^T X_t(\widehat{\eta}(t)) dt \right) \right] \leq \frac{2T\lambda^2}{\gamma} + \frac{1}{\gamma} \int_0^T dt \sup_{\varphi} \left\{ \mathbb{E}_\alpha^* (\varphi \gamma X_t(\widehat{\eta})) - \frac{1}{2} D(\varphi) \right\},$$

where the supremum in the right-hand side is taken on the densities w.r.t.  $\mu_\alpha^*$ .

*Proof of Lemma 4.9:* Let us denote by  $P_t^{\lambda, X}$  the modified semi-group

$$P_t^{\lambda, X} = \exp \left[ \int_0^t L_N^{\beta=0} + \gamma N^2 X_s ds \right].$$

where  $L_N^{\beta=0}$  is the alignment-free generator introduced in (2.15) and let us denote in this Section by  $\langle \cdot, \cdot \rangle_\alpha$  the inner product in  $L^2(\mu_\alpha^*)$ . For any  $i = 1, 2$ , and any  $H$ , and  $T > 0$ , the Feynman-Kac formula guarantees that

$$\mathbb{E}_{\mu_\alpha^*}^{\lambda, 0} \left[ \exp \left( \gamma N^2 \int_0^T X_t(\widehat{\eta}(t)) dt \right) \right] = \langle 1, P_T^{\lambda, X} 1 \rangle_\alpha \leq \langle P_T^{\lambda, X} 1, P_T^{\lambda, X} 1 \rangle_\alpha^{1/2} . \quad (4.18)$$

by definition of  $P_t^{\lambda, X}$ ,

$$\frac{d}{dt} \langle P_t^{\lambda, X} 1, P_t^{\lambda, X} 1 \rangle_\alpha = \langle P_t^{\lambda, X} 1, (L_N^{\beta=0} + L_N^{\beta=0, *} + 2\gamma N^2 X_t) P_t^{\lambda, X} 1 \rangle_\alpha, \quad (4.19)$$

where  $M^*$  stands for the adjoint in  $L^2(\mu_\alpha^*)$  of  $M$ . By definition of  $L_N^{\beta=0}$ , we have

$$L_N^{\beta=0, *} = N^2 \mathcal{L}^* + N \mathcal{L}^{\text{wa}, *} + \mathcal{L}^{\text{G}, \beta=0, *}.$$

We now work to control the weakly asymmetric contribution in the right-hand side of equation (4.19), which does not vanish in our case, as a consequence of Remark 4.8. For that purpose, consider a function  $\varphi \in L^2(\mu_\alpha^*)$ , identity (4.17) yields

$$\langle \varphi, (\mathcal{L}^{\text{wa}} + \mathcal{L}^{\text{wa}, *}) \varphi \rangle_\alpha = 2 \sum_{x \in \mathbb{T}_N^2} \sum_{i=1, 2} \mathbb{E}_\alpha^* \left[ \varphi^2 \tau_x J_i^{\lambda_i} \right].$$

Recall the definition of  $\nabla_{af}$  given in equation (2.4). A change of variable  $\widehat{\eta} \mapsto \widehat{\eta}^{x, x+e_i}$  on the second part of  $\tau_x J_i^{\lambda_i}$  yields that for any  $x$

$$\mathbb{E}_\alpha^* (\varphi^2 \tau_x J_i^{\lambda_i}) = -\mathbb{E}_\alpha^* (\lambda_i(\theta_0) \nabla_{x, x+e_i} \varphi^2) = -\mathbb{E}_\alpha^* [\lambda_i(\theta_0) (\varphi(\widehat{\eta}^{x, x+e_i}) + \varphi) \nabla_{x, x+e_i} \varphi],$$

therefore applying the elementary inequality  $ab \leq a^2/2 + b^2/2$ , to

$$a = \sqrt{N} \nabla_{x, x+e_i} \varphi \quad \text{and} \quad b = -\frac{\lambda_i(\theta_0)}{\sqrt{N}} (\varphi(\widehat{\eta}^{x, x+e_i}) + \varphi),$$

we obtain (since  $\lambda_i(\theta)$  is either  $\lambda \cos(\theta)$  or  $\lambda \sin(\theta)$  and is therefore less than  $\lambda$ )

$$\langle \varphi, (\mathcal{L}^{\text{WA}} + \mathcal{L}^{\text{WA},*})\varphi \rangle_\alpha \leq \frac{N}{2} \sum_{x \in \mathbb{T}_N^2} \sum_{i=1,2} \mathbb{E}_\alpha^* \left[ (\nabla_{x,x+e_i} \varphi)^2 \right] + \frac{\lambda^2}{2N} \sum_{x \in \mathbb{T}_N^2} \sum_{i=1,2} \mathbb{E}_\alpha^* \left[ (\varphi(\widehat{\eta}^{x,x+e_i}) + \varphi)^2 \right].$$

Since  $(\varphi(\widehat{\eta}^{x,x+e_i}) + \varphi)^2$  is less than  $2\varphi^2(\widehat{\eta}^{x,x+e_i}) + 2\varphi^2$ , we finally obtain that,

$$\langle \varphi, N(\mathcal{L}^{\text{WA}} + \mathcal{L}^{\text{WA},*})\varphi \rangle_\alpha \leq -N^2 \mathbb{E}_\alpha^* [\varphi \mathcal{L} \varphi] + 4\lambda^2 N^2 \mathbb{E}_\alpha^* [\varphi^2].$$

In particular, applying this identity to  $\varphi = P_t^{\lambda,X} 1$ , we deduce from equation (4.19) that

$$\begin{aligned} \frac{d}{dt} \langle P_t^{\lambda,X} 1, P_t^{\lambda,X} 1 \rangle_\alpha &\leq \langle P_t^{\lambda,X} 1, [2\gamma N^2 X_t + N^2 \mathcal{L} + 2\mathcal{L}^{\text{G},\beta=0} + 4\lambda^2 N^2] P_t^{\lambda,X} 1 \rangle_\alpha \\ &\leq (\nu_\gamma(t) + 4\lambda^2 N^2) \langle P_t^{\lambda,X} 1, P_t^{\lambda,X} 1 \rangle_\alpha + 2 \langle P_t^{\lambda,X} 1, \mathcal{L}^{\text{G},\beta=0} P_t^{\lambda,X} 1 \rangle_\alpha, \end{aligned}$$

where  $\nu_\gamma(t)$  is the largest eigenvalue of the self-adjoint operator  $N^2 \mathcal{L} + 2\gamma N^2 X_t$ . It is not hard to see that the second term above is non-positive. Indeed, for any function  $\varphi$  on  $\Sigma_N$ , by definition of  $\mathcal{L}^{\text{G},\beta=0}$  (cf. equation (1.5))

$$\langle \varphi, \mathcal{L}^{\text{G},\beta=0} \varphi \rangle_\alpha = \sum_{x \in \mathbb{T}_N^2} \mathbb{E}_\alpha^* \left( \eta_x \varphi(\widehat{\eta}) \left[ \frac{1}{2\pi} \int_{\mathbb{S}} \varphi(\widehat{\eta}^{x,\theta}) d\theta - \varphi(\widehat{\eta}) \right] \right) = -\frac{1}{2} \sum_{x \in \mathbb{T}_N^2} \mathbb{E}_\alpha^* \left( \eta_x \left[ \frac{1}{2\pi} \int_{\mathbb{S}} \varphi(\widehat{\eta}^{x,\theta}) d\theta - \varphi(\widehat{\eta}) \right]^2 \right) \leq 0.$$

To establish the last identity, we only used that under  $\mu_\alpha^*$ , the angles are chosen uniformly, and therefore  $\mathbb{E}_\alpha^* (\eta_x \varphi(\theta_x)) = \mathbb{E}_\alpha^* (\eta_x) (1/2\pi) \int_{\mathbb{S}} \varphi(\theta') d\theta'$ . We thus obtain that

$$\frac{d}{dt} \langle P_t^{\lambda,X} 1, P_t^{\lambda,X} 1 \rangle_\alpha \leq (\nu_\gamma(t) + 4\lambda^2 N^2) \langle P_t^{\lambda,X} 1, P_t^{\lambda,X} 1 \rangle_\alpha,$$

and Grönwall's inequality therefore yields that

$$\langle P_T^{\lambda,X} 1, P_T^{\lambda,X} 1 \rangle_\alpha \leq \exp \left( 4T \lambda^2 N^2 + \int_0^T \nu_\gamma(t) dt \right).$$

This, combined with (4.18), allows us to write

$$\frac{1}{\gamma N^2} \log \mathbb{E}_{\mu_\alpha^*}^{\lambda,0} \left[ \exp \left( \gamma N^2 \int_0^T X_t dt \right) \right] \leq \frac{2T \lambda^2}{\gamma} + \int_0^T \frac{\nu_\gamma(t)}{2\gamma N^2} dt. \quad (4.20)$$

The variational formula for the largest eigenvalue of the self-adjoint operator  $N^2(\mathcal{L} + 2\gamma X_t)$  yields that

$$\nu_\gamma(t) = N^2 \sup_{\psi, \mathbb{E}_\alpha^*(\psi^2)=1} \mathbb{E}_\alpha^* (\psi (\mathcal{L} + 2\gamma X_t) \psi) = 2N^2 \sup_{\varphi} \left\{ \gamma \mathbb{E}_\alpha^* (X_t \varphi) - \frac{1}{2} D(\varphi) \right\},$$

where the second supremum is taken over all densities  $\varphi$  w.r.t.  $\mu_\alpha^*$ , which together with (4.20) concludes the proof of Lemma 4.9. To prove the last identity, one only has to note that the supremum must be achieved by functions  $\psi$  of constant sign, so that we can let  $\varphi = \sqrt{\psi}$ . ■

## 4.4 Relative compactness of the sequence $(Q_N)_{N \in \mathbb{N}}$

We prove in this Section that the sequence  $(Q^N)_{N \in \mathbb{N}}$ , defined in equation (A.4), is relatively compact for the weak topology. It follows from two properties stated in Proposition 4.10 below. The first one guarantees that the fixed-time marginals are controlled, whereas the second ensures that the time-fluctuations of the process's measure are not too wide.

Given a function  $H : \mathbb{T}^2 \times \mathbb{S} \rightarrow \mathbb{R}$ , we already introduced in the outline of Section 1.4 the notation

$$\langle \pi, H \rangle = \int_{\mathbb{T}^2 \times \mathbb{S}} H(u, \theta) \pi(du, d\theta).$$

The following result yields sufficient conditions for the weak relative compactness of the sequence  $(Q^N)_N$ .

**Proposition 4.10.** *Let  $P^N$  be a sequence of probability measures on the set of trajectories  $\mathcal{M}^{[0, T]}$  defined in (1.11), such that*

(1) *There exists some  $A_0 > 0$  such that for any  $A > A_0$ ,*

$$\limsup_{N \rightarrow \infty} P^N \left( \sup_{s \in [0, T]} \langle \pi_s, 1 \rangle \geq A \right) = 0$$

(2) *For any  $H \in C(\mathbb{T}^2 \times \mathbb{S})$ ,  $\varepsilon > 0$ ,*

$$\lim_{\delta \rightarrow 0} \limsup_{N \rightarrow \infty} P^N \left( \sup_{\substack{|t-t'| \leq \delta \\ 0 \leq t', t \leq T}} | \langle \pi_{t'}, H \rangle - \langle \pi_t, H \rangle | > \varepsilon \right) = 0.$$

*Then, the sequence  $(P^N)_{N \in \mathbb{N}}$  is relatively compact for the weak topology.*

Since this proposition is, with minor adjustments, found in [Bil99] (cf. Theorem 13.2, page 139), we do not give its proof, and refer the reader to the latter. For now, our focus is the case of the AEP, for which both of these conditions are realized. The strategy of the proof follows closely that of Theorem 6.1, page 180 of [KL99], but requires two adjustments. First, our system is driven out of equilibrium by the drift, and we therefore need to use the Lemma 4.9 stated in the previous section to carry out the proof. The second adaptation comes from the presence of the angles, and since most of the proof is given for a test function  $H(u, \theta) = G(u)\omega(\theta)$ , we need to extend it in the general case where  $H$  cannot be decomposed in this fashion.

**Proposition 4.11.** *The sequence  $Q^N$  defined in equation (A.4) of probabilities on the trajectories of the AEP satisfies conditions (1) and (2) above, and is therefore relatively compact.*

*Proof of Proposition 4.11 :* The first condition does not require any work since the AEP only allows one particle per site and we can thus choose  $A_0 = 1$ . Regarding the second condition, recall that

$$\langle \pi_{t'}, H \rangle - \langle \pi_t, H \rangle = \int_{t'}^t L_N \langle \pi_s, H \rangle ds + M_t^H - M_{t'}^H, \quad (4.21)$$

where  $M^H$  is a martingale with quadratic variation of order  $N^{-2}$ . For more details, we refer the reader to appendix A of [KL99]. First, Doob's inequality yields uniformly in  $\delta$  the crude bound

$$\mathbb{E}_{\mu^N}^{\lambda,\beta} \left( \sup_{t', t \leq \delta} |M_t^H - M_{t'}^H| \right) \leq 2 \mathbb{E}_{\mu^N}^{\lambda,\beta} \left( \sup_{0 \leq t \leq T} |M_t^H| \right) \leq C(H)N^{-1}, \quad (4.22)$$

where  $\mathbb{E}_{\mu^N}^{\lambda,\beta}$  is the expectation w.r.t the measure  $\mathbb{P}_{\mu^N}^{\lambda,\beta}$  introduced just after Definition 2.4 of the complete process  $\widehat{\eta}^{[0,T]}$  started from the initial measure  $\mu^N$ .

Regarding the integral part of (4.21), we first assume like earlier that  $H$  takes the form

$$H(u, \theta) = G(u)\omega(\theta),$$

where  $G$  and  $\omega$  are both  $C^2$  functions. When this is not the case, an application of the periodic Weierstrass Theorem will yield the wanted result. Then, following the same justification as in Section 1.4 we can write

$$\int_{t'}^t L_N \langle \pi_s^N, H \rangle ds = \frac{1}{N^2} \int_{t'}^t ds \sum_{x \in \mathbb{T}_N^2} \tau_x \left( \sum_{i=1}^2 [N j_i^\omega + r_i^\omega](s) \partial_{u_i, N} G(x/N) + \tau_x \gamma^\omega(s) G(x/N) \right),$$

where the instantaneous currents  $j^\omega$ ,  $r^\omega$  and  $\gamma^\omega$  were introduced in Definition 1.8.

The weakly asymmetric and Glauber contributions are easy to control, since both jump rates  $r^\omega$  and  $\gamma^\omega$  can be bounded by a same constant  $K$ , and we can therefore write

$$\begin{aligned} \int_{t'}^t (N\mathcal{L}^{\text{WA}} + \mathcal{L}^{\text{G}}) \langle \pi_s^N, H \rangle ds &\leq K \int_{t'}^t ds \frac{1}{N^2} \sum_{x \in \mathbb{T}_N^2} |G(x/N)| + \sum_{i=1}^2 \left| \partial_{u_i, N} G(x/N) \right| \\ &\rightarrow_{N \rightarrow \infty} K(t-t') \int_{\mathbb{T}^2} |G(u)| + \sum_{i=1}^2 \left| \partial_{u_i} G(u) \right| du, \end{aligned}$$

which vanishes as soon as  $|t' - t| \leq \delta$  in the limit  $\delta \rightarrow 0$ . Finally,

$$\begin{aligned} \mathcal{Q}^N \left( \sup_{\substack{|t-t'| \leq \delta \\ 0 \leq t', t \leq T}} | \langle \pi_{t'}^N, H \rangle - \langle \pi_t^N, H \rangle | > \varepsilon \right) &\leq \mathbb{P}_{\mu^N}^{\lambda,\beta} \left[ \sup_{\substack{|t-t'| \leq \delta \\ 0 \leq t', t \leq T}} \left| \int_{t'}^t N^2 \mathcal{L} \langle \pi_s^N, H \rangle ds \right| > \varepsilon/3 \right] \\ &\quad + \mathbb{P}_{\mu^N}^{\lambda,\beta} \left[ \sup_{\substack{|t-t'| \leq \delta \\ 0 \leq t', t \leq T}} \left| \int_{t'}^t (N\mathcal{L}^{\text{WA}} + \mathcal{L}^{\text{G}}) \langle \pi_s^N, H \rangle ds \right| > \varepsilon/3 \right] \\ &\quad + \mathbb{P}_{\mu^N}^{\lambda,\beta} \left[ \sup_{\substack{|t-t'| \leq \delta \\ 0 \leq t', t \leq T}} |M_t^H - M_{t'}^H| > \varepsilon/3 \right]. \end{aligned}$$

The second line of the right-hand side vanishes in the limit  $N \rightarrow \infty$  then  $\delta \rightarrow 0$  thanks to the computation above, whereas the third line also vanishes thanks to Markov's inequality and equation (4.22). Finally, the first term vanishes accordingly to Lemma 4.12 below and the Markov inequality, thus completing the proof in the case where  $H(u, \theta) = G(u)\omega(\theta)$ . The general case is derived just after the proof of Lemma 4.12.



**Lemma 4.12.** For any function  $H(u, \theta) = G(u)\omega(\theta) \in C^{2,0}(\mathbb{T}^2 \times \mathbb{S})$ ,

$$\lim_{\delta \rightarrow 0} \limsup_{N \rightarrow \infty} \mathbb{E}_{\mu^N}^{\lambda, \beta} \left( \sup_{\substack{|t'-t| \leq \delta \\ 0 \leq t', t \leq T}} \left| \int_{t'}^t N^2 \mathcal{L} \langle \pi_s^N, H \rangle ds \right| \right) = 0. \quad (4.23)$$

*Proof of Lemma 4.12 :* The proof of this Lemma follows, with minor adjustments to account for the drift, the proof given in [KL99]. First, we get rid of the supremum and come back to the reference measure with fixed parameter  $\alpha \in ]0, 1[$  thanks to Lemma 4.9 of Section 4.3. Let us denote

$$g(t) = \int_0^t N^2 \mathcal{L} \langle \pi_s^N, H \rangle ds. \quad (4.24)$$

We now compare the measure of the AEP to that of the process started from equilibrium ( $\mu^N = \mu_\alpha^*$ ), and with no alignment ( $\beta = 0$ ), according to Proposition 2.10 with  $A = RN^2$  and

$$X(\tilde{\eta}^{[0, T]}) = \sup_{\substack{|t'-t| \leq \delta \\ 0 \leq t', t \leq T}} \left| \int_{t'}^t N^2 \mathcal{L} \langle \pi_s^N, H \rangle ds \right| = \sup_{\substack{|t'-t| \leq \delta \\ 0 \leq t', t \leq T}} |g(t) - g(t')|.$$

This yields that for some constant  $K_0 > 0$ , the expectation in equation (4.23) is bounded from above for any positive  $R$  by

$$\frac{1}{RN^2} \left[ K_0 N^2 + \log \mathbb{E}_{\mu_\alpha^*}^{\lambda, 0} \exp \left( RN^2 \sup_{\substack{|t'-t| \leq \delta \\ 0 \leq t', t \leq T}} |g(t) - g(t')| \right) \right]. \quad (4.25)$$

We therefore reduce the proof of Lemma 4.12 to showing that

$$\lim_{\delta \rightarrow 0} \limsup_{N \rightarrow \infty} \frac{1}{R(\delta)N^2} \log \mathbb{E}_{\mu_\alpha^*}^{\lambda, 0} \exp \left( R(\delta)N^2 \sup_{\substack{|t'-t| \leq \delta \\ 0 \leq t', t \leq T}} |g(t) - g(t')| \right) = 0, \quad (4.26)$$

where  $R(\delta)$  goes to  $\infty$  as  $\delta$  goes to 0.

Let  $p$  and  $\psi$  be two strictly increasing functions such that  $\psi(0) = p(0) = 0$  and  $\psi(+\infty) = +\infty$ , we denote

$$I = \int_{[0, T] \times [0, T]} \psi \left( \frac{|g(t) - g(t')|}{p(|t' - t|)} \right) dt' dt,$$

the Garsia-Rodemich-Rumsey inequality [GRR78] yields that

$$\sup_{\substack{|t'-t| \leq \delta \\ 0 \leq t', t \leq T}} |g(t) - g(t')| \leq 8 \int_0^\delta \psi^{-1} \left( \frac{4I}{u^2} \right) p(du). \quad (4.27)$$

Given any positive  $a$ , we choose  $p(u) = \sqrt{u}$  and  $\psi(u) = \exp(u/a) - 1$ , hence  $\psi^{-1}(u) = a \log(1 + u)$ . An integration by parts yields that

$$\int_0^\delta \psi^{-1} \left( \frac{4I}{u^2} \right) p(du) = a \int_0^\delta \log \left( 1 + \frac{4I}{u^2} \right) \frac{du}{2\sqrt{u}}$$

$$\begin{aligned}
&= a\sqrt{\delta}\log(1+4I\delta^{-2}) + a\int_0^\delta \frac{8I}{u^3+4Iu}\sqrt{u}du \\
&\leq a\sqrt{\delta}\log(1+4I\delta^{-2}) + a\int_0^\delta \frac{2}{\sqrt{u}}du \\
&= a\sqrt{\delta}\left[\log(\delta^2+4I) - 2\log\delta + 4\right] \\
&\leq a\sqrt{\delta}\left[-\frac{\log\delta}{2}\log(\delta^2+4I) - 4\log\delta\right] \\
&\leq a\sqrt{\delta}\left[-4\log\delta\log(\delta^2+4I) - 4\log\delta\right], \tag{4.28}
\end{aligned}$$

since for any  $\delta < e^{-2}$ , we have  $-\log(\delta) > 2$ . From equations (4.27) and (4.28) we deduce that

$$\log \mathbb{E}_{\mu_\alpha^*}^{\lambda,0} \exp\left(RN^2 \sup_{\substack{|t'-t|\leq\delta \\ 0\leq t',t\leq T}} |g(t) - g(t')|\right) \leq \log \mathbb{E}_{\mu_\alpha^*}^{\lambda,0} \exp\left(-32aRN^2\sqrt{\delta}\log\delta\left[1 + \log(\delta^2 + 4I + 1)\right]\right)$$

holds for any  $a > 0$ . For  $\delta < 1$ , Let us choose  $a = -(32RN^2\sqrt{\delta}\log\delta)^{-1} > 0$ , we can write for the second term of (4.25) the upper bound

$$\frac{1}{RN^2} \log \mathbb{E}_{\mu_\alpha^*}^{\lambda,0} \exp\left(RN^2 \sup_{\substack{|t'-t|\leq\delta \\ 0\leq t',t\leq T}} |g(t) - g(t')|\right) \leq \frac{1}{RN^2} \left[1 + \log(1 + \delta^2 + 4\mathbb{E}_{\widehat{\alpha}}(I))\right].$$

By definition,

$$I = \int_{[0,T]\times[0,T]} \exp\left(\frac{\left|\int_{t'}^t N^2 \mathcal{L} < \pi_u^N, H > du\right|}{a\sqrt{|t-t'|}}\right) dt' dt - T^2.$$

Let us assume, purely for convenience, that  $T > 1/2$ , for  $\delta$  sufficiently small, we have  $4T^2 - 1 - \delta^2 > 0$ , and the quantity inside the limit in equation (4.26) can be estimated by

$$\begin{aligned}
&\frac{1}{RN^2} \log \mathbb{E}_{\mu_\alpha^*}^{\lambda,0} \exp\left(RN^2 \sup_{\substack{|t'-t|\leq\delta \\ 0\leq t',t\leq T}} |g(t) - g(t')|\right) \\
&\leq \frac{1}{RN^2} \left[1 + \log 4\mathbb{E}_{\mu_\alpha^*}^{\lambda,0} \left[\int_{[0,T]\times[0,T]} \exp\left(\frac{\left|\int_{t'}^t N^2 \mathcal{L} < \pi_s^N, H > ds\right|}{a\sqrt{|t'-t|}}\right) dt' dt\right]\right]. \tag{4.29}
\end{aligned}$$

If  $T \leq 1/2$ , we simply carry out a constant term in the log above, which does not alter the proof.

Let us take a look at the two constants  $a$  and  $R$ . Noting the first bound on the entropy mentioned earlier, in order to keep the first term of (4.25) in check,  $R = R(\delta)$  must simply grow to  $\infty$ . Furthermore, we previously obtained that  $a = -(RN^2 32\sqrt{\delta}\log\delta)^{-1}$ , we can choose  $a = N^{-2}$ , thus  $R = -1/32\sqrt{\delta}\log\delta$ , which is non-negative, and goes to  $\infty$  as  $\delta \rightarrow 0^+$ . Therefore, the second term above can be rewritten

$$\frac{1}{RN^2} \log \int_{[0,T]\times[0,T]} 4\mathbb{E}_{\mu_\alpha^*}^{\lambda,0} \exp\left[\left|\int_{t'}^t \frac{N}{|t'-t|^{1/2}} \sum_{x \in \mathbb{T}_N^2} j_{x,x+e_i}^\omega(s) \partial_{u_i,NG}(x/N) ds\right| dt' dt\right].$$

In order to estimate the expectation above, we can get rid of the absolute value, since  $e^{|x|} \leq e^x + e^{-x}$ , and since the function  $G$  is taken in a symmetric class of functions. Furthermore, Lemma 4.9, applied with  $A = 1$  yields that the second term in the right-hand side of (4.29) is less than

$$\frac{1}{RN^2} \log \int_{[0,T] \times [0,T]} \exp \left[ \frac{(t-t')}{2} [4\lambda^2 N^2 + \nu_N(G, i)] \right] dt dt', \quad (4.30)$$

where  $\nu_N(G, i)$  is the largest eigenvalue in  $L^2(\mu_\alpha^*)$  of the self-adjoint operator

$$N^2 \mathcal{L} + \frac{2N}{|t' - t|^{1/2}} \sum_{x \in \mathbb{T}_N^2} j_{x, x+e_i}^\omega \partial_{u_i, N} G(x/N),$$

which can be rewritten as the variational formula

$$\nu_N(G, i) = \sup_f \left\{ \frac{2N}{|t' - t|^{1/2}} \sum_{x \in \mathbb{T}_N^2} \partial_{u_i, N} G(x/N) \mathbb{E}_\alpha^* (f j_{x, x+e_i}^\omega) - N^2 D(f) \right\}, \quad (4.31)$$

where the supremum is taken on all densities  $f$  w.r.t.  $\mu_\alpha^*$ . In order to prove that the eigenvalue above is of order  $N^2$ , we now want to transform

$$\frac{N}{|t' - t|^{1/2}} \sum_{x \in \mathbb{T}_N^2} \partial_{u_i, N} G(x/N) \mathbb{E}_\alpha^* (f j_{x, x+e_i}^\omega).$$

For any density  $f$ , since  $j_{x, x+e_i}^\omega(\widehat{\eta}^{x, x+e_i}) = -\tau_x j_i^\omega$ , we can write

$$\begin{aligned} \mathbb{E}_\alpha^* (f j_{x, x+e_i}^\omega) \partial_{u_i, N} G(x/N) &= -\frac{1}{2} \mathbb{E}_\alpha^* [(f(\widehat{\eta}^{x, x+e_i}) - f) j_{x, x+e_i}^\omega] \partial_{u_i, N} G(x/N) \\ &\leq \frac{1}{4C} \mathbb{E}_\alpha^* (j_{x, x+e_i}^\omega)^2 (\sqrt{f(\widehat{\eta}^{x, x+e_i})} - \sqrt{f})^2 \\ &\quad + \frac{C}{4} (\partial_{u_i, N} G(x/N))^2 \mathbb{E}_\alpha^* ((\sqrt{f(\widehat{\eta}^{x, x+e_i})} + \sqrt{f})^2). \end{aligned}$$

Since  $(j_{x, x+e_i}^\omega)^2 \leq \|\omega\|_\infty^2 \mathbb{1}_{\eta_x \eta_{x+e_i} = 0}$ , and since  $[\sqrt{f(\widehat{\eta}^{x, x+e_i})} + \sqrt{f}]^2 \leq 2f(\widehat{\eta}^{x, x+e_i}) + 2f$ , we obtain the upper bound

$$N|t' - t|^{-1/2} \sum_{x \in \mathbb{T}_N^2} \partial_{u_i, N} G(x/N) \mathbb{E}_\alpha^* (f j_{x, x+e_i}^\omega) \leq \frac{N|t' - t|^{-1/2} \|\omega\|_\infty^2}{2C} D(f) + N^3 |t' - t|^{-1/2} C \|\partial_{u_i} G\|_\infty^2,$$

which holds for any positive  $C$ . We now set  $C = |t' - t|^{-1/2} \|\omega\|_\infty^2 / N$  so that the Dirichlet form contributions in the variational formula (4.31) cancel out. We finally obtain that for some positive constant  $C_1(G)$ , independent of  $N$ ,

$$\nu_N(G, i) \leq \frac{C_1(G) N^2}{|t - t'|},$$

which yields that (4.30) vanishes in the limit  $N \rightarrow \infty$  and  $\delta \rightarrow 0$ , since  $R = R(\delta)$  goes to  $\infty$  as  $\delta$  goes to 0. Finally, we have proved thanks to equation (4.29) that

$$\lim_{\delta \rightarrow 0} \limsup_{N \rightarrow \infty} \frac{1}{RN^2} \log \mathbb{E}_{\mu_\alpha^*}^{\lambda, 0} \left( \exp \left[ RN^2 \sup_{\substack{|t' - t| \leq \delta \\ 0 \leq t', t \leq T}} |g(t) - g(t')| \right] \right) = 0,$$

which concludes the proof of Lemma (4.12).  $\blacksquare$

In order to complete the proof of Proposition 4.11, we still have to consider the case when  $H$  does not take a product form  $G(u)\omega(\theta)$ . In this case, since  $H$  is smooth it can be approximated by a trigonometric polynomial in  $u_1, u_2$  and  $\theta$ . Each term of the approximation is then of the form  $G(u)\omega(\theta)$ , and the previous result can therefore be applied. More precisely, consider a smooth function  $H$ , and for any  $\alpha > 0$ , there exists a finite family  $(p_{ijk}^\alpha)_{0 \leq i,j,k \leq M_\alpha}$  of coefficients such that

$$\sup_{\substack{u \in \mathbb{T}^2 \\ \theta \in \mathbb{S}}} \left| H(u, \theta) - \sum_{i,j,k \in \llbracket 0, M \rrbracket} p_{ijk}^\alpha u_1^i u_2^j \theta^k \right| \leq \alpha.$$

Let us now fix an  $\varepsilon > 0$ , and let us take  $\alpha = \varepsilon/4$ . Then, considering the corresponding family  $P_{ijk}(u, \theta) = p_{ijk}^\alpha u_1^i u_2^j \theta^k$  we have that

$$\left| \langle \pi_{t'}^N, H \rangle - \langle \pi_t^N, H \rangle \right| \leq \left| \langle \pi_{t'}^N - \pi_t^N, H - \sum_{i,j,k \leq M_\alpha} P_{ijk} \rangle \right| + \sum_{i,j,k \leq M_\alpha} \left| \langle \pi_{t'}^N - \pi_t^N, P_{ijk} \rangle \right|.$$

Since we allow at most 1 particle per site, and since  $H - \sum_{i,j,k \leq M_\alpha} P_{ijk}$  is smaller than  $\varepsilon/4$ , the first term of the right-hand side above is less than  $\varepsilon/2$ . From this, we deduce that for the left-hand side to be greater than  $\varepsilon$ , one of the terms  $\left| \langle \pi_{t'}^N, P_{ijk} \rangle - \langle \pi_t^N, P_{ijk} \rangle \right|$  must be larger than  $\varepsilon/2M_\alpha^3$ . This yields that

$$Q^N \left( \sup_{\substack{|s-t| \leq \delta \\ 0 \leq t', t \leq T}} \left| \langle \pi_{t'}^N, H \rangle - \langle \pi_t^N, H \rangle \right| > \varepsilon \right) \leq \sum_{i,j,k \leq M_\alpha} Q^N \left( \sup_{\substack{|t'-t| \leq \delta \\ 0 \leq t', t \leq T}} \left| \langle \pi_{t'}^N, P_{ijk} \rangle - \langle \pi_t^N, P_{ijk} \rangle \right| > \frac{\varepsilon}{2M_\alpha^3} \right).$$

Since  $\alpha$  is fixed, we can now take the limit  $N \rightarrow \infty$  then  $\delta \rightarrow 0$ , in which the right-hand side vanishes since all functions are decorrelated in  $u$  and  $\theta$ . The result thus holds for any smooth function  $H$ , thus completing the proof of Proposition 4.11.  $\blacksquare$

We now prove that in the limit, the empirical measure of our process admits at any fixed time a density w.r.t. the Lebesgue measure on  $\mathbb{T}^2$ .

**Lemma 4.13.** *Any limit point  $Q^*$  of the sequence  $Q^N$  is concentrated on measures  $\pi \in \widehat{\mathcal{M}}_T$  with time marginals absolutely continuous w.r.t the Lebesgue measure on  $\mathbb{T}^2$ ,*

$$Q^*(\pi, \pi_t(du, d\theta) = \widehat{\rho}_t(u, d\theta)du, \quad \forall t \in [0, T]) = 1.$$

*Proof of Lemma 4.13 :* For any smooth function  $H \in C(\mathbb{T}^2)$  configuration  $\widehat{\eta}$  in  $\Sigma_N$  and any corresponding empirical measure  $\pi^N$ , we have

$$\left| \langle \pi^N, H \rangle \right| = \left| \frac{1}{N^2} \sum_{x \in \mathbb{T}_N^2} H(x/N) \eta_x \right| \leq \frac{1}{N^2} \sum_{x \in \mathbb{T}_N^2} |H(x/N)|.$$

The right-hand side above converges as  $N$  goes to  $\infty$  towards  $\int_{\mathbb{T}^2} |H(u)| du$ . Since for any fixed function  $H$ , the application

$$\pi \mapsto \sup_{0 \leq t \leq T} | \langle \pi_t, H \rangle |$$

is continuous, any limit point  $Q^*$  of  $(Q^N)_N$  is concentrated on trajectories  $\pi$  such that

$$\sup_{0 \leq t \leq T} | \langle \pi_t, H \rangle | \leq \int_{\mathbb{T}^2} |H(u)| du,$$

for any smooth function  $H$  on  $\mathbb{T}^2$ , and therefore is absolutely continuous w.r.t. the Lebesgue measure on  $\mathbb{T}^2$ .  $\blacksquare$

## 4.5 Regularity of the density and energy estimate

*In this Section we prove the regularity of the particle densities needed for equation (1.13). The regularity of the total density is obtained quite easily following the strategy for the proof used in [KL99], however the regularity of the density of each type of particle (with angle  $\theta$ ) is more delicate, and requires the Replacement Lemma 3.1 as well as the tools developed in Section 4.*

Due to the non-constant diffusion coefficients, the second derivative in equation (1.13) cannot be applied to the test function, and we need, according to condition *iii*) of Definition 1.5, to prove that the macroscopic profiles of our particle system are such that  $\nabla \rho$  is well-defined. We are going to prove a slightly stronger result than what is required, and also prove that  $d_s(\rho) \nabla \widehat{\rho}(u, \theta)$  is, once smoothed out by a function  $\omega$ , well-defined as well.

Recall from the irreducibility Section 2.12 the definition of the cutoff functions  $\mathbb{1}_{E_p}$ , where  $E_p$ , defined in equation (2.17), is the event on which the configuration has at least two empty sites in the box  $B_p$  of side length  $2p+1$ . For any angle measure  $\widehat{\alpha}$ , (cf. Definition 2.1) we already introduced  $\alpha = \int_{\mathbb{S}} \widehat{\alpha}(d\theta)$ , we define

$$F^{\omega, p}(\widehat{\alpha}) = \mathbb{E}_{\widehat{\alpha}}(\eta_0^\omega \mathbb{1}_{E_p}) \quad (4.32)$$

the cutoff density. Recall from Lemma 4.13 that any limit point  $Q^*$  of  $(Q^N)_{N \in \mathbb{N}}$  is concentrated on trajectories such that

$$\pi_t(du, d\theta) = \widehat{\rho}_t(u, d\theta) du,$$

and that we denote  $\rho_t(u) = \int_{\mathbb{S}} \widehat{\rho}_t(u, d\theta)$ . We can now state the following result.

**Theorem 4.14.** *Any limit point  $Q^*$  of the measure sequence  $(Q^N)_N$  is concentrated on trajectories with  $\rho_t(u)$  and  $F^{\omega, p}(\widehat{\rho}_t(u))$  in  $H_1 = W^{1,2}([0, T] \times \mathbb{T}^2)$  for any  $p \geq 1$ . In other words, there exists functions  $\partial_{u_i} \rho_t(u)$  and  $\partial_{u_i} F^{\omega, p}(\widehat{\rho}_t(u))$  in  $L^2([0, T] \times \mathbb{T}^2)$  such that for any smooth function  $H \in C^{1,2}([0, T] \times \mathbb{T}^2)$*

$$\iint_{[0, T] \times \mathbb{T}^2} \rho_t(u) \partial_{u_i} H_t(u) du dt = - \iint_{[0, T] \times \mathbb{T}^2} H_t(u) \partial_{u_i} \rho_t(u) du dt \quad (4.33)$$

and

$$\iint_{[0, T] \times \mathbb{T}^2} F^{\omega, p}(\widehat{\rho}_t(u)) \partial_{u_i} H_t(u) du dt = - \iint_{[0, T] \times \mathbb{T}^2} H_t(u) \partial_{u_i} F^{\omega, p}(\widehat{\rho}_t(u)) du dt.$$

Furthermore, there exists a constant  $K = K(T, \lambda, \beta, \widehat{\rho}_0)$  such that for any limit point  $Q^*$  of  $(Q^N)$ , and for any  $i$ ,

$$\mathbb{E}_{Q^*} \left( \iint_{[0, T] \times \mathbb{T}^2} [\partial_{u_i} \rho_t(u)]^2 dudt \right) < K. \quad (4.34)$$

In particular, any such limit point  $Q^*$  is concentrated on measures satisfying condition iii) of Definition 1.5.

**Remark 4.15.** We obtain in fact throughout the proof a stronger regularity than  $\rho, F^{\omega, p}(\widehat{\rho}) \in H_1$ . Indeed, to prove the latter, one only requires according to Riesz representation theorem that

$$\int \rho \nabla H \leq C \left( \int H^2 \right)^{1/2} \quad \text{and} \quad \int F^{\omega, p}(\widehat{\rho}) \nabla H \leq C \left( \int H^2 \right)^{1/2},$$

for some constant  $C$ . In our case, we are really going to prove that

$$\int \rho \nabla H \leq C \left( \int \rho(1 - \rho) H^2 \right)^{1/2} \quad \text{and} \quad \int F^{\omega, p}(\widehat{\rho}) \nabla H \leq C \left( \int \rho H^2 \right)^{1/2},$$

which is obviously a stronger result since  $\rho \leq 1$ . However, since  $\rho, F^{\omega, p}(\widehat{\rho}) \in H_1$  is sufficient to define the differential equation (1.13), we formulate the theorem above with the weaker result instead of the latter.

The proof is postponed to the end of this Section. The usual argument to prove this result is Riesz representation theorem, that guarantees that if

$$\iint_{[0, T] \times \mathbb{T}^2} \rho_t(u) \partial_{u_i} H_t(u) dudt \leq C \|H\|_2^2$$

for any  $H$  there exists a function  $\partial_{u_i} \rho \in L^2([0, T] \times \mathbb{T}^2)$  such that (4.33) holds. We first prove that if  $F^{\omega, p}(\widehat{\rho})$  and  $\rho$  are in  $H^1$ , then  $d_s(\rho) \partial_{u_i} \rho^\omega$  is properly defined. For that purpose, we need the estimate given in Lemma 4.16 below. Fix a direction  $i \in \{1, 2\}$ , for any  $x \in \mathbb{T}_N^2$ , let  $(x_k)_{k \in \{0, \varepsilon N\}}$  be defined by  $x_k = x + k e_i$ . Following the strategy of the energy estimate of [KL99], and recalling that  $\tau_{x, \rho_{\delta N}}$  is the empirical particle density in  $B_{\delta N}(x)$ , we let

$$V_{N,i}(A, \varepsilon, \delta, H, \widehat{\eta}) = \frac{1}{N^2} \sum_{x \in \mathbb{T}_N^2} H(x/N) \left( \frac{1}{\varepsilon} [F^{\omega, p}(\tau_{x+\varepsilon N e_i} \widehat{\rho}_{\delta N}) - F^{\omega, p}(\tau_x \widehat{\rho}_{\delta N})] - \frac{AH(x/N)}{\varepsilon N} \sum_{k=0}^{\varepsilon N-1} \tau_{x_k} \rho_{\delta N} \right).$$

We also introduce the equivalent of  $V_{N,i}$  for the angle-blind configuration  $\eta_x$  instead of  $\eta_x^\omega \mathbb{1}_{E_{p,x}}$ , and let

$$W_{N,i}(\varepsilon, \delta, H, \eta) = \frac{1}{N^2} \sum_{x \in \mathbb{T}_N^2} H(x/N) \left( \frac{1}{\varepsilon} [\tau_{x+\varepsilon N e_i} \rho_{\delta N} - \rho_{\delta N}] - \frac{2H(x/N)}{\varepsilon N} \sum_{k=0}^{\varepsilon N-1} \tau_{x_k} \rho_{\delta N} (1 - \rho_{\delta N}) \right).$$

**Lemma 4.16.** Let  $\{H^l, l \in \mathbb{N}\}$  be a dense sequence in the separable algebra  $C^{0,1}([0, T] \times \mathbb{T}^2)$  endowed with the norm  $\|H\|_\infty + \sum_{i=1}^2 \|\partial_{u_i} H\|_\infty$ . For any  $r = 1, 2$  there exists two positive constants  $A_0 = A_0(p)$  and  $K = K(T, \lambda, \beta, \widehat{\rho}_0)$  such that for any  $k \geq 1$  and  $\varepsilon > 0$ ,

$$\limsup_{\delta \rightarrow 0} \limsup_{N \rightarrow \infty} \mathbb{E}_{\mu^N}^{\lambda, \beta} \left( \max_{1 \leq l \leq k} \int_0^T V_{N,i}(A_0, \varepsilon, \delta, H_t^l, \widehat{\eta}(t)) dt \right) \leq K_0,$$

and

$$\limsup_{\delta \rightarrow 0} \limsup_{N \rightarrow \infty} \mathbb{E}_{\mu^N}^{\lambda, \beta} \left( \max_{1 \leq l \leq k} \int_0^T W_{N,i}(\varepsilon, \delta, H_t^l, \eta(t)) dt \right) \leq K_0.$$

*Proof of Lemma 4.16 :* By the replacement Lemma 3.1, it is sufficient to show the result above without the limit in  $\delta$ , and with  $\widetilde{V}_{N,i}(A, \varepsilon, H_t, \widehat{\eta})$  and  $\widetilde{W}_{N,i}(\varepsilon, H_t, \widehat{\eta})$  instead of  $V_{N,i}$  and  $W_{N,i}$ , where

$$\begin{aligned}\widetilde{V}_{N,i}(A, \varepsilon, H, \widehat{\eta}) &= \frac{1}{N^2} \sum_{x \in \mathbb{T}_N^2} H(x/N) \left( \frac{1}{\varepsilon} \left[ \eta_{x+\varepsilon N e_i}^\omega \mathbb{1}_{\tau_{x+\varepsilon N e_i} E_p} - \eta_x^\omega \mathbb{1}_{\tau_x E_p} \right] - \frac{AH(x/N)}{\varepsilon N} \sum_{k=0}^{\varepsilon N-1} \eta_{x_k} \right) \\ &= \frac{1}{N^2} \sum_{x \in \mathbb{T}_N^2} H(x/N) \frac{1}{\varepsilon N} \sum_{k=0}^{\varepsilon N-1} \left[ N \delta_i(\eta_{x_k}^\omega \mathbb{1}_{E_p, x_k}) - AH(x/N) \eta_{x_k} \right],\end{aligned}$$

and

$$\begin{aligned}\widetilde{W}_{N,i}(\varepsilon, H, \eta) &= \frac{1}{N^2} \sum_{x \in \mathbb{T}_N^2} H(x/N) \left( \frac{1}{\varepsilon} \left[ \eta_{x+\varepsilon N e_i} - \eta_x \right] - \frac{AH(x/N)}{\varepsilon N} \sum_{k=0}^{\varepsilon N-1} \eta_{x_k} (1 - \eta_{x_{k+1}}) \right) \\ &= \frac{1}{N^2} \sum_{x \in \mathbb{T}_N^2} H(x/N) \frac{1}{\varepsilon N} \sum_{k=0}^{\varepsilon N-1} \left[ N(\eta_{x_{k+1}} - \eta_{x_k}) - 2H(x/N) \eta_{x_k} (1 - \eta_{x_{k+1}}) \right].\end{aligned}$$

To obtain the second identities we merely rewrote  $F^{\omega,p}(\tau_{x+\varepsilon N e_i} \widehat{\rho}_{\delta N}) - F^{\omega,p}(\tau_x \widehat{\rho}_{\delta N})$  and  $\tau_{x+\varepsilon N e_i} \rho_{\delta N} - \rho_{\delta N}$  as telescopic sums, and  $\delta_i$  is the discrete derivative in the direction  $e_i$

$$\delta_i g(\widehat{\eta}) = \tau_{e_i} g(\widehat{\eta}) - g(\widehat{\eta}).$$

Applying Proposition 2.10 to  $A = N^2$  and

$$X(\widehat{\eta}^{[0,T]}) = \max_{1 \leq i \leq k} \int_0^T \widetilde{V}_{N,i}(A, \varepsilon, H_i(t, \cdot), \widehat{\eta}(t)) dt,$$

the contribution of the Glauber dynamics and the initial measure can be compared to the case  $\beta = 0$  started from  $\mu_\alpha^*$ ,

$$\begin{aligned}\mathbb{E}_{\mu_N^{\lambda, \beta}}^{\lambda, \beta} \left( \max_{1 \leq l \leq k} \int_0^T \widetilde{V}_{N,i}(A, \varepsilon, H_t^l, \widehat{\eta}(t)) dt \right) \\ \leq K_0(T, \beta, \widehat{\rho}_0) + \frac{1}{N^2} \left( \log \mathbb{E}_{\mu_\alpha^*}^{\lambda, 0} \left[ \exp \left( N^2 \max_{1 \leq l \leq k} \int_0^T \widetilde{V}_{N,i}(A, \varepsilon, H_t^l, \widehat{\eta}(t)) dt \right) \right] \right).\end{aligned}$$

The max can be taken out of the log in the second term because for any finite family  $(u_l)$ ,

$$\exp \left( \max_l u_l \right) \leq \sum \exp u_l \quad \text{and} \quad \limsup_{N \rightarrow \infty} N^{-2} \log \left( \sum_l u_{l,N} \right) \leq \max_l \limsup_{N \rightarrow \infty} N^{-2} \log u_{N,l}.$$

Furthermore, we apply Lemma 4.9 to  $\gamma = 1$ , and  $X_t = \widetilde{V}_{N,i}(A, \varepsilon, H_t, \widehat{\eta})$ , to obtain that

$$\frac{1}{N^2} \log \mathbb{E}_{\mu_\alpha^*}^{\lambda, 0} \left[ \exp \left( N^2 \int_0^T \widetilde{V}_{N,i}(A, \varepsilon, H_t, \widehat{\eta}(t)) dt \right) \right] \leq 2T\lambda^2 + \frac{1}{2} \int_0^T dt \sup_\varphi \left\{ 2\mathbb{E}_\alpha^* (\varphi \widetilde{V}_{N,i}(A, \varepsilon, H_t, \widehat{\eta})) - D(\varphi) \right\},$$

where the supremum is taken over all densities w.r.t.  $\mu_\alpha^*$ . We obtain the same bound with  $\widetilde{W}_{N,i}$  instead of  $\widetilde{V}_{N,i}$ . Letting

$$K(T, \lambda, \beta, \widehat{\rho}_0) = K_0(T, \beta, \widehat{\rho}_0) + 2T\lambda^2,$$

to prove Lemma 4.16 it is therefore sufficient to show that the second term on the right-hand side of the inequality above is non-positive for some constant  $A$ . This will be implied by Lemma 4.17 below, since the time integral is now only applied to  $H$ .  $\blacksquare$

**Lemma 4.17.** *Let  $p > 1$  be some fixed integer, there exists a positive constant  $A_0$  depending only on  $p$  such that for any  $H \in C^1(\mathbb{T}^2)$ , and  $\varepsilon > 0$ ,*

$$\limsup_{N \rightarrow \infty} \sup_{\varphi} \left\{ 2\mathbb{E}_{\alpha}^* \left( \widetilde{V}_{N,i}(A_0, \varepsilon, H, \widehat{\eta})\varphi \right) - D(\varphi) \right\} \leq 0,$$

and

$$\limsup_{N \rightarrow \infty} \sup_{\varphi} \left\{ 2\mathbb{E}_{\alpha}^* \left( \widetilde{W}_{N,i}(\varepsilon, H, \widehat{\eta})\varphi \right) - D(\varphi) \right\} \leq 0,$$

where the supremums are taken over the densities  $\varphi$  w.r.t the product measure  $\mu_{\alpha}^*$ .

*Proof of Lemma 4.17 :* We treat in full detail only the first upper bound, which requires to handle the events  $E_{p,x}$ . The second can be derived in the exact same fashion, and with much less effort. We first work on the expectation of the first part of  $\widetilde{V}_{N,i}\varphi$ , which can be rewritten

$$\frac{2}{N} \mathbb{E}_{\alpha}^* \left( \varphi \sum_{x \in \mathbb{T}_N^2} H(x/N) \frac{1}{\varepsilon N} \sum_{k=0}^{\varepsilon N - 1} \left( \eta_{x_k + e_i}^{\omega} \mathbb{1}_{E_{p,x_{k+1}}} - \eta_{x_k}^{\omega} \mathbb{1}_{E_{p,x_k}} \right) \right). \quad (4.35)$$

In order to transfer the gradient appearing in the expression above on  $\varphi$ , we need a specific change of variable described in Figure 6. For that purpose, given  $x$  in the torus, we denote for any  $m \in \llbracket -p, p \rrbracket$

$$y_m = x - pe_i + me_{i'} \quad \text{and} \quad z_m = x + (p+1)e_i + me_{i'},$$

where  $i' \neq i$  is the other direction on the torus. Given these, we denote for any configuration  $\widehat{\eta}$  by

$$T_{i,p}^x(\widehat{\eta}) = (((\widehat{\eta}^{x, x+e_i})^{y_{-p}, z_{-p}}) \cdots)^{y_p, z_p}$$

the configuration where the sites  $x$  and  $x + e_i$  have been inverted, as well as the boundary sites  $y_m$  and  $z_m$ , according to Figure 6 : the purpose of the inversion between the  $y_m$ 's and  $z_m$ 's is to transform  $\mathbb{1}_{E_{p,x_k}}$  into  $\mathbb{1}_{E_{p,x_{k+1}}}$ .

By definition of  $T_{i,p}^x$ , we thus have

$$\eta_x^{\omega} \mathbb{1}_{E_{p,x}}(T_{i,p}^x \widehat{\eta}) = \eta_{x+e_i}^{\omega} \mathbb{1}_{E_{p,x+e_i}}(\widehat{\eta}),$$

therefore

$$\mathbb{E}_{\alpha}^* \left( \varphi (\eta_{x_k + e_i}^{\omega} \mathbb{1}_{E_{p,x_{k+1}}} - \eta_{x_k}^{\omega} \mathbb{1}_{E_{p,x_k}}) \right) = \mathbb{E}_{\alpha}^* \left[ \left( \varphi(T_{i,p}^{x_k} \widehat{\eta}) - \varphi(\widehat{\eta}) \right) \eta_{x_k}^{\omega} \mathbb{1}_{E_{p,x_k}} \right].$$

Thanks to the elementary inequality

$$\begin{aligned} A(\varphi(\widehat{\eta}') - \varphi(\widehat{\eta})) &\leq A(\sqrt{\varphi(\widehat{\eta}')} + \sqrt{\varphi(\widehat{\eta})})(\sqrt{\varphi(\widehat{\eta}')} - \sqrt{\varphi(\widehat{\eta})}) \\ &\leq \frac{A^2 \gamma}{2} (\sqrt{\varphi(\widehat{\eta}')} + \sqrt{\varphi(\widehat{\eta})})^2 + \frac{1}{2\gamma} (\sqrt{\varphi(\widehat{\eta}')} - \sqrt{\varphi(\widehat{\eta})})^2, \end{aligned}$$

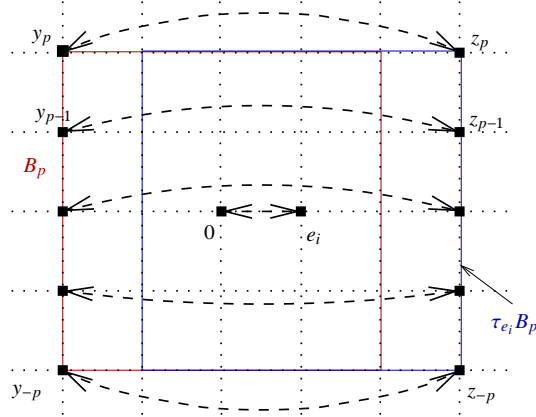

 Figure 6: Change of variable  $\widehat{\eta} \rightarrow T_{i,p}^0 \widehat{\eta}$ .

and the fact that  $|\eta_x^\omega| \leq \|\omega\|_\infty \eta_x$  the quantity  $\mathbb{E}_\alpha^* \left( H(x/N) \varphi(\eta_{x_k+e_i}^\omega \mathbb{1}_{E_{p,x_{k+1}}} - \eta_{x_k}^\omega \mathbb{1}_{E_{p,x_k}}) \right)$  can therefore be bounded for any positive  $\gamma$  by

$$\frac{\gamma \|\omega\|_\infty^2 H(x/N)^2}{2} \mathbb{E}_\alpha^* \left( \left( \sqrt{\varphi}(T_{i,p}^{x_k} \widehat{\eta}) + \sqrt{\varphi}(\widehat{\eta}) \right)^2 \eta_{x_k} \right) + \frac{1}{2\gamma} \mathbb{E}_\alpha^* \left( \mathbb{1}_{E_{p,x_k}} \left( \sqrt{\varphi}(T_{i,p}^{x_k} \widehat{\eta}) - \sqrt{\varphi}(\widehat{\eta}) \right)^2 \right). \quad (4.36)$$

Since  $(a+b)^2 \leq 2(a^2+b^2)$ , the expectation in the left-hand side above can be bounded from above by

$$\gamma \|\omega\|_\infty^2 H(x/N)^2 \mathbb{E}_\alpha^* (\varphi(\eta_{x_{k+1}} + \eta_{x_k})).$$

The corresponding part in (4.35) can therefore be bounded from above by

$$\frac{4\gamma \|\omega\|_\infty^2}{N} \sum_{x \in \mathbb{T}_N^2} H(x/N)^2 \frac{1}{\varepsilon N} \sum_{k=0}^{\varepsilon N-1} \mathbb{E}_\alpha^* (\varphi \eta_{x_k}) + \gamma N o_N(1) \quad (4.37)$$

We now want to estimate the right-hand side of (4.36) by the Dirichlet form. Thanks to the cutoff functions  $\mathbb{1}_{E_{p,x_k}}$ , for any  $k$ , according to Section 2.3 there exists a sequence of allowed jumps in  $B_p(x_k)$  allowing to reach  $T_{i,p}^{x_k} \widehat{\eta}$  from  $\widehat{\eta}$ . More precisely, denote by  $(\widehat{\eta}^l)_{l \in \{0, \dots, L\}}$  the sequence of configurations such that  $\widehat{\eta}^0 = \widehat{\eta}$ ,  $\widehat{\eta}^L = T_{i,p}^{x_k} \widehat{\eta}$ , and for any  $l \leq L$ ,  $\widehat{\eta}^{l+1} = (\widehat{\eta}^l)^{a_l, b_l}$  for two neighboring sites  $a_l$  and  $b_l$  such that the jump from  $a_l$  to  $b_l$  is allowed in  $\widehat{\eta}^l$ . Finally, we can choose  $L$  bounded by some constant  $C_p$ , and we can safely assume by the construction in the Section 2.3 that each edge in  $B_p$  is used at most  $n_p$  times. These notations allow us to rewrite for any fixed  $k \in \{0, \varepsilon N - 1\}$

$$\begin{aligned} \mathbb{E}_\alpha^* \left( \left( \sqrt{\varphi}(T_{x_k} \widehat{\eta}) - \sqrt{\varphi}(\widehat{\eta}) \right)^2 \mathbb{1}_{E_{p,x_k}} \right) &= \mathbb{E}_\alpha^* \left[ \mathbb{1}_{\tau_{x_k} E_p} \left( \sum_{l=0}^{L-1} \sqrt{\varphi}((\widehat{\eta}^l)^{a_l, b_l}) - \sqrt{\varphi}(\widehat{\eta}^l) \right)^2 \right] \\ &\leq C_p \mathbb{E}_\alpha^* \left[ \sum_{l=0}^{L-1} \left( \sqrt{\varphi}((\widehat{\eta}^l)^{a_l, b_l}) - \sqrt{\varphi}(\widehat{\eta}^l) \right)^2 \right] \\ &\leq C_p n_p \mathbb{E}_\alpha^* \left[ \sum_{x, x+z \in B_p(x_k)} (\nabla_{x, x+z} \sqrt{\varphi})^2 \right] \leq \bar{C}_p D_{B_p(x_k)}(\varphi), \end{aligned}$$

where  $D_B(\cdot)$  is the Dirichlet form relative to the symmetric generator  $\mathcal{L}$ , restricted to having both extremities of the jumps in  $B$ , and  $\widetilde{C}_p = 2C_p n_p$  is a constant depending only on  $p$ .

Summing the expression above over  $x$  and  $k$ , since for any  $k$

$$\sum_{x \in \mathbb{T}_N^2} D_{B_p(x_k)}(\varphi) = (2p+1)^2 D(\varphi),$$

there exists a constant  $C'_p = (2p+1)^2 \widetilde{C}_p$  such that

$$\frac{1}{\varepsilon N} \sum_{x \in \mathbb{T}_N^2} \sum_k \mathbb{E}_\alpha^* \left( \left( \sqrt{\varphi}(T_{i,p}^{x_k} \widehat{\eta}) - \sqrt{\varphi} \right)^2 \mathbb{1}_{E_{p,x_k}} \right) \leq C'_p D(\varphi). \quad (4.38)$$

We finally obtain, thanks to (4.36), (4.37) and (4.38), that for some constant  $C(\omega)$ , (4.35) can be bounded from above by

$$\frac{\gamma C(\omega)}{N} \sum_{x \in \mathbb{T}_N^2} H(x/N)^2 \frac{1}{\varepsilon N} \sum_{k=0}^{\varepsilon N-1} \mathbb{E}_\alpha^*(\varphi \eta_{x_k}) + \gamma N o_N(1) + \frac{C'_p}{\gamma N} D(\varphi). \quad (4.39)$$

We then let  $\gamma = C'_p/N$ , and set  $A_0 = C'_p C(\omega)/2$  to obtain that the first bound in Lemma 4.17 holds.

The second term is much easier to derive, and follows the exact same steps as the first. The key idea however, is that this time

$$\eta_{x_{k+1}} - \eta_{x_k} = \eta_{x_{k+1}}(1 - \eta_{x_k}) - \eta_{x_k}(1 - \eta_{x_{k+1}}),$$

and we only need a change of variable  $\widehat{\eta} \rightarrow \widehat{\eta}^{x_k, x_{k+1}}$  to make the Dirichlet form directly appear. ■

Lemma 4.16 allows us to complete the proof of Theorem 4.14. Once again, we only treat in full detail the case of  $F^{\omega,p}(\widehat{\rho})$ , the proof for  $\rho$  follows directly.

*Proof of Theorem 4.14 :* Recall that we defined in Section 1.2  $\mathbb{P}^{\lambda,\beta}_{\mu^N}$ , the measure on the space  $D([0, T], \mathbb{T}_N^2)$  of the AEP  $\widehat{\eta}(s)$  started with the measure  $\mu^N$ , and  $\mathcal{Q}^N$  is the measure on the corresponding measure space  $\mathcal{M}^{[0,T]}$ . Let us introduce

$$\varphi_\delta(u) = (2\delta)^{-2} \mathbb{1}_{[-\delta, \delta]^2}.$$

For any trajectory  $(\pi_t)$  in  $\mathcal{M}^{[0,T]}$ , we define the density profile of the torus (in the sense of Definition 2.1)  $\widehat{\rho}_t^\delta$

$$\widehat{\rho}_t^\delta(u, d\theta) = \langle \pi_t(\cdot, d\theta), \varphi_\delta(\cdot + u) \rangle = \int_{\mathbb{T}^2} \varphi_\delta(v + u) \pi_t(dv, d\theta).$$

The application

$$\pi \mapsto \int_0^T F^{\omega,p}(\widehat{\rho}_t^\delta(u, \cdot)) dt,$$

defined for any trajectory  $\pi \in \mathcal{M}^{[0,T]}$ , is continuous for Skorohod's topology described in Section 4.4. Letting  $Q^*$  be a weak limit point of  $(Q^N)$ , Lemma 4.16 therefore yields that

$$\limsup_{\delta \rightarrow 0} \mathbb{E}_{Q^*} \left( \max_{1 \leq l \leq k} \iint_{[0,T] \times \mathbb{T}^2} \frac{H_l^1(u)}{\varepsilon} (F^{\omega,p}(\widehat{\rho}_t^\delta(u + \varepsilon e_i, \cdot)) - F^{\omega,p}(\widehat{\rho}_t^\delta(u, \cdot))) \right)$$

$$-A_0 \frac{H_i^l(u)^2}{\varepsilon} \left[ \int_{[u, u+\varepsilon e_i]} \rho_i^\delta(v) dv \right] dudt \leq K,$$

where  $\rho_i^\delta(v) = \langle \pi_t, \varphi_\delta(v-\cdot) \rangle$ . Since thanks to Lemma 4.13 any limit point  $Q^*$  of  $(Q^N)$  is concentrated on trajectories absolutely continuous w.r.t. the Lebesgue measure on  $\mathbb{T}^2$ , letting  $\delta$  then  $\varepsilon$  go to 0, by dominated convergence, we obtain that

$$\mathbb{E}_{Q^*} \left( \max_{1 \leq l \leq k} \iint_{[0, T] \times \mathbb{T}^2} \left[ \partial_{u_i} H_i^l(u) F^{\omega, p}(\widehat{\rho}_t(u)) - A_0 H_i^l(u)^2 \rho_t(u) \right] dudt \right) \leq K,$$

where  $\widehat{\rho}_t$  is the density profile on torus, which exists  $Q^*$ -a.s. according to Lemma 4.13, such that  $\pi_t(du, d\theta) = \widehat{\rho}_t(u, d\theta) du$ . By monotone convergence, and since the sequence  $(H_l)$  is dense in  $C^{0,1}([0, T] \times \mathbb{T}^2)$ , the measure  $Q^*$  is concentrated on the trajectories  $\widehat{\rho}$  for which there exists a constant  $A_0$ , such that for any  $i$

$$\mathbb{E}_{Q^*} \left( \sup_H \iint_{[0, T] \times \mathbb{T}^2} \left[ \partial_{u_i} H_t(u) F^{\omega, p}(\widehat{\rho}_t(u)) - A_0 H_t(u)^2 \rho_t(u) \right] dudt \right) \leq K, \quad (4.40)$$

where the supremum is taken over all functions  $H \in C^{0,1}([0, T] \times \mathbb{T}^2)$ . Let us first assume that  $\omega$  is a non-negative function, then

$$(G, H) = \int_{[0, T] \times \mathbb{T}^2} G_t(u) H_t(u) \rho_t(u) dudt,$$

is an inner product on  $C^{0,1}([0, T] \times \mathbb{T}^2)$ . Let  $L_\rho^2$  denote the resulting Hilbert space. Finally, let us denote  $f_i$  the linear operator

$$f_i(H) = \iint_{[0, T] \times \mathbb{T}^2} \partial_{u_i} H_t(u) F^{\omega, p}(\widehat{\rho}_t(u)) dudt,$$

then equation (4.40) yields that for any positive constant  $r$ ,  $r f_i(H) - r^2 A_0 (H, H) \leq K$ , i.e.

$$f_i(H) \leq \frac{1}{r} K + r A_0 (H, H).$$

Letting  $r = \sqrt{K/A_0(H, H)}$ , and  $C_0 = \sqrt{K} (\sqrt{A_0} + \sqrt{A_0}^{-1})$ , we obtain that for any function  $H \in C^{0,1}([0, T] \times \mathbb{T}^2)$ ,

$$f_i(H) \leq C_0 (H, H)^{1/2}.$$

Thus the operator  $f_i$  is bounded in  $L_\rho^2$ . Therefore, for any  $i$ , Riesz's representation Theorem yields that there exists a function denoted  $\widetilde{F}_i^{\omega, p}(\widehat{\rho}_t(u)) \in L_\rho^2$  such that for any  $H \in C^{0,1}([0, T] \times \mathbb{T}^2)$ ,

$$f_i(H) = \iint_{[0, T] \times \mathbb{T}^2} \partial_{u_i} H_t(u) F^{\omega, p}(\widehat{\rho}_t(u)) dudt = \iint_{[0, T] \times \mathbb{T}^2} H_t(u) \widetilde{F}_i^{\omega, p}(\widehat{\rho}_t(u)) \rho_t(u) dudt.$$

Letting  $\partial_{u_i} F^{\omega, p}(\widehat{\rho}_t(u)) = \rho_t(u) \widetilde{F}_i^{\omega, p}(\widehat{\rho}_t(u)) \in L^1([0, T] \times \mathbb{T}^2)$ , we obtain the wanted result. We can follow the same strategy if  $\omega$  is non-positive, which we only used so that  $(G, H)$  would be positive, and finally also for any  $\omega$  since the wanted identity is linear in  $\omega$ . ■

**Remark 4.18.** We have proven in the previous theorem that the differentials  $\partial_{u_i} F^{\omega,p}(\widehat{\rho}_t(u))$  exist. Following the same exact strategy and replacing  $\eta_0^\omega \mathbb{1}_{E_p}$  by  $\eta_0$ , it is easily derived that  $\rho$  is also in  $H^1$ . This time, there is no need for the cutoff functions, since this time the currents and gradients vanish as soon as the configuration is full, and the Dirichlet form appears naturally.

To any density profile on the torus  $\widehat{\rho}$ , we associate  $\rho^\omega$  the angle density smoothed out by  $\omega$

$$\rho^\omega(u) = \int_{\mathbb{S}} \omega(\theta) \widehat{\rho}(u, d\theta).$$

For any large  $p$ , and assuming that the density does not go to 1,  $F^{\omega,p}(\widehat{\rho}_t(u))$  is close to  $\rho_t^\omega(u)$ , and since the gradient of  $F^{\omega,p}(\widehat{\rho}_t(u))$  is well-defined according to Theorem 4.14, that of  $\rho_t^\omega(u)$  should also be well-defined. However, when the density reaches 1, this is no longer the case, and the definition of  $\partial_{u_i} \rho_t^\omega(u)$  becomes problematic. However, this issue can be solved, because the diffusion coefficient relative to  $\rho_t^\omega(u)$  is  $d_s(\rho)$ , which vanishes as the density  $\rho$  reaches 1. This construction of  $\partial_{u_i} \rho_t^\omega(u)$  is given by the following Corollary of Theorem 4.14.

**Corollary 4.19.** Any limit point  $Q^*$  of the measure sequence  $(Q^N)_N$  is concentrated on trajectories  $\pi_t(du, d\theta) = \widehat{\rho}_t(u, d\theta) du$  such that there exists functions  $d_s(\rho) \partial_{u_i} \rho_t^\omega$  in  $L^2([0, T] \times \mathbb{T}^2)$ , verifying for any smooth function  $G \in C^{0,2}([0, T] \times \mathbb{T}^2)$ ,

$$\int_{[0, T] \times \mathbb{T}^2} \rho_t^\omega \partial_{u_i} [d_s(\rho) G_t(u)] dudt = - \int_{[0, T] \times \mathbb{T}^2} G_t(u) d_s(\rho) \partial_{u_i} \rho_t^\omega dudt.$$

*Proof of Corollary 4.19 :* In order to obtain the functions  $\partial_{u_i} \rho_t^\omega$ , recall that  $\widetilde{E}_p$  is the event on which at least two sites in  $B_p \setminus \{0\}$  are empty. In order to make  $E_p$  and  $\eta_0$  independent, we let

$$\widetilde{E}_p = \left\{ \sum_{x \in B_p, x \neq 0} \eta_x \leq (2p+1)^2 - 3 \right\}.$$

Then,  $\widetilde{E}_p$  and  $\widetilde{\eta}_0$  are independent by construction, and

$$F^{\omega,p}(\widehat{\rho}_t(u)) = \rho_t^\omega \mathbb{P}_{\widehat{\rho}_t(u)}(\widetilde{E}_p). \quad (4.41)$$

Also note that  $\mathbb{P}_{\widehat{\rho}_t(u)}(\widetilde{E}_p)$  depends on  $\widehat{\rho}_t(u)$  only through  $\rho(u)$ ,

$$\mathbb{P}_{\widehat{\rho}_t(u)}(\widetilde{E}_p) = 1 - (\rho_t(u) + 4p(p+1)(1 - \rho_t(u))) \rho_t(u)^{4p(p+1)-1}.$$

For any  $\rho \neq 1$ , we can use equation (4.41), and define the derivative as

$$d_s(\rho_t) \partial_{u_i} \rho_t^\omega = \frac{d_s(\rho_t)}{\mathbb{P}_{\widehat{\rho}_t(u)}(\widetilde{E}_p)} \left( F^{\omega,p}(\widehat{\rho}_t(u)) - \rho_t^\omega \mathbb{P}_{\widehat{\rho}_t(u)}(\widetilde{E}_p) \right).$$

Note that a priori this definition depends on  $p$ . In fact, the construction ensures that it does not, but since this is not a crucial point of the proof, we do not develop it further. This quantity is well-defined since  $\rho$  and  $F^{\omega,p}(\widehat{\rho}_t(u))$  are in  $H_1$  according to Theorem 4.14, and since  $d_s(\rho_t) / \mathbb{P}_{\widehat{\rho}_t(u)}(\widetilde{E}_p)$  admits a finite limit as  $\rho$  goes to 1, thus concluding the proof of Corollary 4.19.  $\blacksquare$

## 5 Non-gradient estimates

### 5.1 Replacement of the symmetric current by a macroscopic gradient

In this Section, we focus on the complete exclusion process, and replace the current  $j_i^\omega$  by a quantity of the form  $\tau_{e_i}h - h + \mathcal{L}f$ , with  $f$  a function of the configuration with infinite support. We then show that the perturbation  $\mathcal{L}f$  is of the same order as the weakly asymmetric contribution, and they both contribute to the drift term of equation (1.13). To obtain the non gradient estimates, we use the formalism developed in [KL99] rather than that of [Qua92]. This changes the proof substantially, with the upside that the orders in  $N$ , as well as the studied quantities, are clearly identified at any given point of the proof.

One of the challenges in proving the non-gradient hydrodynamic limit is to replace the local particle currents  $j_i^\omega$  by the gradient of a function of the empirical measure. Recall that we already defined in equation (1.22) the empirical angle measure  $\widehat{\rho}_l \in \mathcal{M}_1(\mathbb{S})$ ,

$$\widehat{\rho}_l = \frac{1}{(2l+1)^2} \sum_{x \in B_l} \eta_x \delta_{\theta_x},$$

and we denote by  $\rho_l$  the empirical density

$$\rho_l = \frac{1}{(2l+1)^2} \sum_{x \in B_l} \eta_x = \widehat{\rho}_l(\mathbb{S}).$$

Let

$$\rho_l^\omega = \frac{1}{(2l+1)^2} \sum_{x \in B_l} \eta_x^\omega,$$

be the average of  $\eta^\omega$  over a box of side  $2l+1$ . Finally, for any function  $\varphi$  on  $\Sigma_N$ , recall that  $\delta_i$  is the discrete derivative

$$\delta_i \varphi = \tau_{e_i} \varphi - \varphi$$

(for example,  $\delta_i \eta_0^\omega = \eta_{e_i}^\omega - \eta_0^\omega$ ).

The usual strategy in the proof of the non-gradient hydrodynamic limit is to show that for some coefficients  $\mathfrak{d}^\omega, \mathfrak{d} : [0, 1] \times \mathbb{R} \rightarrow \mathbb{R}^+$ ,

$$j_i^\omega + \mathfrak{d}^\omega(\rho_{\varepsilon N}, \rho_{\varepsilon N}^\omega) \delta_i \rho_{\varepsilon N}^\omega + \mathfrak{d}(\rho_{\varepsilon N}, \rho_{\varepsilon N}^\omega) \delta_i \rho_{\varepsilon N}$$

vanishes as  $N \rightarrow \infty$ . More precisely, the quantity above is in the range of the generator  $\mathcal{L}$ , which is usually sufficient when the functions of the form  $\mathcal{L}f$  are negligible. In our case, however, due to the addition of a weak drift, the usual martingale estimate does not yield that  $\mathcal{L}f$  is negligible, but that  $\mathcal{L}^{\mathfrak{d}} f = (\mathcal{L} + N^{-1} \mathcal{L}^{\text{wa}})f$  is negligible, therefore this perturbation can be integrated to the drift part, which is done in Section 5.9.

For this replacement, we will need further notations similar to the ones introduced in Section 3.1. In our case, the diffusion coefficient  $\mathfrak{d}^\omega(\rho, \rho^\omega)$  is in fact the self-diffusion coefficient  $d_s(\rho)$ , therefore we will from now on simply write  $d_s(\rho)$  for the diffusion coefficient relative to  $\rho^\omega$ . Note

that it depends on the configuration only through the empirical density, and not on the particle angles. For any positive integer  $l$ , and any cylinder function  $f$ , let us thus denote

$$\mathcal{V}_i^{f,\varepsilon N}(\widehat{\eta}) = j_i^\omega + d_s(\rho_{\varepsilon N}) \delta_i \rho_{\varepsilon N}^\omega + \mathfrak{d}(\rho_{\varepsilon N}, \rho_{\varepsilon N}^\omega) \delta_i \rho_{\varepsilon N} - \mathcal{L}f,$$

where  $\mathfrak{d} : [0, 1] \times \mathbb{R} \rightarrow \mathbb{R}^+$  is the diffusion coefficient given in (1.12).

We introduce for any smooth function  $G \in C^2(\mathbb{T}^2)$

$$X_{i,N}^{f,\varepsilon N}(G, \widehat{\eta}) = \frac{1}{N} \sum_{x \in \mathbb{T}_N^2} G(x/N) \tau_x \mathcal{V}_i^{f,\varepsilon N}. \quad (5.1)$$

Our goal throughout this Section is to prove that under the measure of our process,  $X_{i,N}^{f,\varepsilon N}(G, \widehat{\eta})$  vanishes for any smooth function  $G$ , i.e. that the microscopic currents can be replaced by a macroscopic average of the gradients up to a perturbation  $\mathcal{L}f$  that will be dealt with later on.

The sum contains  $N^2$  terms, and the normalization is only  $1/N$ , therefore an order  $N$  has to be gained, and this is the major difficulty of the non-gradient dynamics. To prove this statement, we decompose  $X_{i,N}^{f,\varepsilon N}(G, \widehat{\eta})$  into distinct vanishing parts. We already introduced in Equation (2.17) the set

$$E_{p,x} = \left\{ \sum_{|y-x| \leq p} \eta_y \leq |B_p| - 2 \right\},$$

such that at least two sites are empty in a vicinity of  $x$  of size  $p$ . The cutoff functions  $\mathbb{1}_{E_{p,x}}$  are crucial in order to control the local variations of the measure of the process with the Dirichlet form.

We set for any integer  $l$

$$\rho_l^{\omega,p} = \frac{1}{(2l+1)^2} \sum_{x \in B_l} \eta_x^\omega \mathbb{1}_{E_{p,x}} \quad \text{and} \quad \bar{\rho}_l^{\omega,p} = \rho_l^\omega - \rho_l^{\omega,p} = \frac{1}{(2l+1)^2} \sum_{x \in B_l} \eta_x^\omega \mathbb{1}_{E_{p,x}^c}, \quad (5.2)$$

where  $E_{p,x}^c$  is the complementary event of  $E_{p,x}$ .

We are now ready to split  $X_{i,N}^{f,\varepsilon N}$  into 4 vanishing parts. Let us denote by

$$\mathcal{W}_1 = \mathcal{W}_{i,1}^{f,l}(\widehat{\eta}) = j_i^\omega - \langle j_i^\omega \rangle_0^{l'} - \left( \mathcal{L}f - \langle \mathcal{L}f \rangle_0^{l-s_f} \right),$$

the difference between  $j_i^\omega - \mathcal{L}f$  and their local average, and by

$$\mathcal{W}_2 = \mathcal{W}_{i,2}^{\varepsilon N,p}(\widehat{\eta}) = d_s(\rho_{\varepsilon N}) \delta_i \bar{\rho}_{\varepsilon N}^{\omega,p}$$

the mesoscopic contributions of full clusters, where  $\bar{\rho}_{\varepsilon N}^{\omega,p}$  was defined in equation (5.2) above. Let us also introduce

$$\mathcal{W}_3 = \mathcal{W}_{i,3}^{l,\varepsilon N,p}(\widehat{\eta}) = d_s(\rho_{\varepsilon N}) \delta_i \rho_{\varepsilon N}^{\omega,p} - d_s(\rho_l) \delta_i \rho_{l_p}^{\omega,p} + \mathfrak{d}(\rho_{\varepsilon N}, \rho_{\varepsilon N}^\omega) \delta_i \rho_{\varepsilon N} - \mathfrak{d}(\rho_l, \rho_l^\omega) \delta_i \rho_{l_p},$$

where  $l_p = l - p - 1$  and  $l' = l - 1$ , which is the difference between the cutoff microscopic and macroscopic gradients. Note that the cutoff functions are not needed for the total density  $\rho$ , because the gradients will vanish on full configurations. Finally, we set

$$\mathcal{W}_4 = \mathcal{W}_{i,4}^{f,l,p}(\widehat{\eta}) = \langle j_i^\omega \rangle_0^{l'} + d_s(\rho_l) \delta_i \rho_{l_p}^{\omega,p} + \mathfrak{d}(\rho_l, \rho_l^\omega) \delta_i \rho_{l_p} - \langle \mathcal{L}f \rangle_0^{l-s_f}, \quad (5.3)$$

the microscopic difference between currents and gradients, taking into consideration the perturbation  $\mathcal{L}f$ . For any smooth function  $G \in C^2(\mathbb{T}^2)$ , we also introduce

$$Y_1 = Y_{i,1}^{f,l}(G, \widehat{\eta}) = \frac{1}{N} \sum_{x \in \mathbb{T}_N^2} G(x/N) \tau_x \mathcal{W}_1, \quad Y_2 = Y_{i,2}^{\varepsilon N,p}(G, \widehat{\eta}) = \frac{1}{N} \sum_{x \in \mathbb{T}_N^2} G(x/N) \tau_x \mathcal{W}_2,$$

$$Y_3 = Y_{i,3}^{l,\varepsilon N,p}(G, \widehat{\eta}) = \frac{1}{N} \sum_{x \in \mathbb{T}_N^2} G(x/N) \tau_x \mathcal{W}_3 \quad \text{and} \quad Y_4 = Y_{i,4}^{f,l,p}(G, \widehat{\eta}) = \frac{1}{N} \sum_{x \in \mathbb{T}_N^2} G(x/N) \tau_x \mathcal{W}_4.$$

By construction,

$$X_{i,N}^{f,\varepsilon N}(G, \widehat{\eta}) = \sum_{k=1}^4 Y_k(G, \widehat{\eta}).$$

We can now state the main result of this Section.

**Theorem 5.1.** *Let  $G$  be a smooth function in  $C^{1,2}([0, T] \times \mathbb{T}^2)$ ,  $T \in \mathbb{R}_+^*$ , and  $i \in \{1, 2\}$ . For any cylinder function  $f$ ,*

$$\limsup_{l \rightarrow \infty} \limsup_{N \rightarrow \infty} \mathbb{E}_{\mu^N}^{\lambda, \beta} \left( \left| \int_0^T Y_{i,1}^{f,l}(G_t, \widehat{\eta}(t)) dt \right| \right) = 0. \quad (5.4)$$

Furthermore,

$$\lim_{p \rightarrow \infty} \limsup_{\varepsilon \rightarrow 0} \limsup_{N \rightarrow \infty} \mathbb{E}_{\mu^N}^{\lambda, \beta} \left( \left| \int_0^T Y_{i,2}^{\varepsilon N,p}(G_t, \widehat{\eta}(t)) dt \right| \right) = 0. \quad (5.5)$$

For any integer  $p > 1$ ,

$$\limsup_{l \rightarrow \infty} \limsup_{\varepsilon \rightarrow 0} \limsup_{N \rightarrow \infty} \mathbb{E}_{\mu^N}^{\lambda, \beta} \left( \left| \int_0^T Y_{i,3}^{l,\varepsilon N,p}(G_t, \widehat{\eta}(t)) dt \right| \right) = 0. \quad (5.6)$$

Finally,

$$\inf_f \lim_{p \rightarrow \infty} \limsup_{l \rightarrow \infty} \limsup_{N \rightarrow \infty} \mathbb{E}_{\mu^N}^{\lambda, \beta} \left( \left| \int_0^T Y_{i,4}^{f,l,p}(G_t, \widehat{\eta}(t)) dt \right| \right) = 0, \quad (5.7)$$

where the infimum in  $f$  is taken over the set  $\mathcal{C}$  of cylinder functions.

The core of this Section is dedicated to proving these four estimates. The proof of equation (5.4) is immediate and is sketched in Section 5.2.

Equation (5.5) is quite delicate, and requires both the control on full clusters derived in equation (2.18) and the energy estimate (4.34). It is proved in Section 5.3, in which the main challenge, as in the control of full clusters, is to carry out the macroscopic estimate (4.34) in a microscopic setup.

The proof of equation (5.6) is given in Section 5.4. This limit is the non-gradient counterpart of the two-block estimate stated in Lemma 3.4. It follows closely the replacement of local gradients by their macroscopic counterparts performed in Lemma 3.1, p.156 of [KL99], but needs some technical adaptation due to the presence of the cutoff functions.

The last limit (5.7) requires the tools developed by Varadhan and Quastel [Var94a] [Qua92] for the hydrodynamic limit for non-gradient systems, and therefore requires more work. It is the non-gradient of the one-block estimate of Lemma 3.3. However, if the latter was essentially a consequence of the law of large numbers, (5.7) is analogous to the central limit theorem, where the gradient term plays the role of  $-\mathbb{E}(J_i^\omega)$ . The limit (5.7) is the focus of Sections 5.5-5.8.

Finally, Section 5.9, and in particular Lemma 5.44, is dedicated to the integration of the contribution  $\mathcal{L}f$  to the drift part of the scaling limit.

These four estimates are sufficient to allow the replacement of currents by macroscopic averages of gradients, up to a perturbation  $\mathcal{L}f$ .

**Corollary 5.2.** *Let  $G$  be a smooth function in  $C^{1,2}([0, T] \times \mathbb{T}^2)$ , and  $T \in \mathbb{R}_+^*$ , and consider  $X_{i,N}^{f,\varepsilon N}$  introduced in (5.1). Then for  $i \in \{1, 2\}$*

$$\inf_f \limsup_{\varepsilon \rightarrow 0} \limsup_{N \rightarrow \infty} \mathbb{E}_{\mu^N}^{\lambda, \beta} \left[ \left| \int_0^T X_{i,N}^{f,\varepsilon N}(G_t, \widehat{\eta}(t)) dt \right| \right] = 0. \quad (5.8)$$

*Proof of Corollary 5.2 :* Since

$$X_{i,N}^{f,\varepsilon N}(G, \widehat{\eta}) = \sum_{k=1}^4 Y_k(G, \widehat{\eta}),$$

this Corollary follows immediately from the triangular inequality, and Theorem 5.1 above, taking the limits  $N \rightarrow \infty$ , then  $\varepsilon \rightarrow 0$  then  $l \rightarrow \infty$ , then  $p \rightarrow \infty$ , and finally the infimums over the local functions  $f$ . ■

## 5.2 Replacement of the currents and $\mathcal{L}f$ by their local average

In this paragraph, we prove equation (5.4), i.e. that for any  $i = 1, 2$ , any function  $G \in C^{1,2}([0, T] \times \mathbb{T}^2)$ , and any cylinder function  $f$ ,

$$\limsup_{l \rightarrow \infty} \limsup_{N \rightarrow \infty} \mathbb{E}_{\mu^N}^{\lambda, \beta} \left( \left| \int_0^T Y_1(G_t, \widehat{\eta}(t)) dt \right| \right) = 0.$$

We set

$$G^{l,N}(x/N) = \frac{1}{(2l+1)^2} \sum_{y \in \mathbb{T}_N^2, |y-x| \leq l} G(y/N),$$

an integration by parts guarantees that, shortening  $l' = l - 1$

$$\frac{1}{N} \sum_{x \in \mathbb{T}_N^2} G(x/N) \left( j_{x, x+e_i}^\omega - \frac{1}{(2l'+1)^2} \sum_{|y-x| \leq l'} j_{y, y+e_i}^\omega \right) = \frac{1}{N} \sum_{x \in \mathbb{T}_N^2} (G(x/N) - G^{l',N}(x/N)) j_{x, x+e_i}^\omega \leq \frac{C(G)l^2}{N}.$$

since the difference  $G(x/N) - G^{l',N}(x/N)$  is a discrete Laplacian, and is therefore of order  $l^2/N^2$ , and the currents  $j_{x, x+e_i}^\omega$  are bounded. By the same reasoning, letting  $l_f = l - s_f$ , we obtain a similar bound on the difference

$$\frac{1}{N} \sum_{x \in \mathbb{T}_N^2} G(x/N) \left( \tau_x \mathcal{L}f - \frac{1}{(2l_f+1)^2} \sum_{|y-x| \leq l_f} \tau_y \mathcal{L}f \right) \leq \frac{C'(G, f)l^2}{N},$$



since  $\mathcal{L}f$  is a bounded function (this last statement comes from the fact that  $f$  is, and depends only on a finite number of sites). These two bounds finally yield that for some constant  $K = C(G) + C'(G, f)$ ,

$$|Y_1(G, \widehat{\eta})| \leq \frac{Kl^2}{N},$$

which immediately yields equation (5.4) for any cylinder function  $f$ .

### 5.3 Estimation of the gradients on full clusters

We now prove that equation (5.5) holds. Our goal is to bound  $Y_{i,2}^{\varepsilon N, p}(G, \widehat{\eta}(s))$  thanks to the control of full clusters functions obtained in (2.18), and to the energy estimate (4.34). For the sake of clarity, we drop the various dependencies, and simply write

$$Y_2 = Y_{i,2}^{\varepsilon N, p}.$$

By definition of  $Y_2$  and  $\bar{\rho}_{\varepsilon N}^{\omega, p}$  (5.2),

$$\begin{aligned} Y_2(G, \widehat{\eta}) &= \frac{1}{N} \sum_{x \in \mathbb{T}_N^2} G(x/N) \tau_x \left( d_s(\rho_{\varepsilon N}) \delta_i \bar{\rho}_{\varepsilon N}^{\omega, p} \right) \\ &= \frac{1}{N} \sum_{x \in \mathbb{T}_N^2} G(x/N) \tau_x \left( d_s(\rho_{\varepsilon N}) \left[ \frac{1}{(2\varepsilon N + 1)^2} \sum_{y \in B_{\varepsilon N}(e_i)} \eta_y^\omega \mathbb{1}_{E_{p,y}^c} - \frac{1}{(2\varepsilon N + 1)^2} \sum_{y \in B_{\varepsilon N}} \eta_y^\omega \mathbb{1}_{E_{p,y}^c} \right] \right), \end{aligned}$$

and we can rewrite it by summation by parts as

$$Y_2(G, \widehat{\eta}) = \frac{1}{N} \sum_{x \in \mathbb{T}_N^2} \eta_x^\omega \mathbb{1}_{E_{p,x}^c} \frac{1}{(2\varepsilon N + 1)^2} \tau_x \left( \sum_{y \in B_{\varepsilon N}(-e_i)} G(y/N) \tau_y d_s(\rho_{\varepsilon N}) - \sum_{y \in B_{\varepsilon N}} G(y/N) \tau_y d_s(\rho_{\varepsilon N}) \right). \quad (5.9)$$

Most of the terms in the parenthesis above cancel out, since the boxes  $B_{\varepsilon N}(-e_i)$  and  $B_{\varepsilon N} = B_{\varepsilon N}(0)$  overlap except on the two sides (cf. Figure 7).

For any  $k \in \llbracket -\varepsilon N, \varepsilon N \rrbracket$ , we let according to Figure 7

$$y_k = -(\varepsilon N + 1)e_i + ke_{i'} \quad \text{and} \quad z_k = \varepsilon N e_i + ke_{i'},$$

where  $i' \neq i$  is the second direction on the torus, which are defined so that  $B_{\varepsilon N}(-e_i) \setminus B_{\varepsilon N} = \{y_{-\varepsilon N}, \dots, y_{\varepsilon N}\}$  and  $B_{\varepsilon N} \setminus B_{\varepsilon N}(-e_i) = \{z_{-\varepsilon N}, \dots, z_{\varepsilon N}\}$ .

We thus obtain from (5.9)

$$Y_2(G, \widehat{\eta}(s)) = \frac{1}{N} \sum_{x \in \mathbb{T}_N^2} \eta_x^\omega \mathbb{1}_{E_{p,x}^c} \frac{1}{(2\varepsilon N + 1)^2} \left( \sum_{k=-\varepsilon N}^{\varepsilon N} G\left(\frac{x+y_k}{N}\right) d_s(\tau_{x+y_k} \rho_{\varepsilon N}) - G\left(\frac{x+z_k}{N}\right) d_s(\tau_{x+z_k} \rho_{\varepsilon N}) \right). \quad (5.10)$$

We can now rewrite the quantity inside the parenthesis as the sum over  $k$  of

$$\left[ G\left(\frac{x+y_k}{N}\right) - G\left(\frac{x+z_k}{N}\right) \right] d_s(\tau_{x+y_k} \rho_{\varepsilon N}) - G\left(\frac{x+z_k}{N}\right) \left[ d_s(\tau_{x+z_k} \rho_{\varepsilon N}) - d_s(\tau_{x+y_k} \rho_{\varepsilon N}) \right].$$

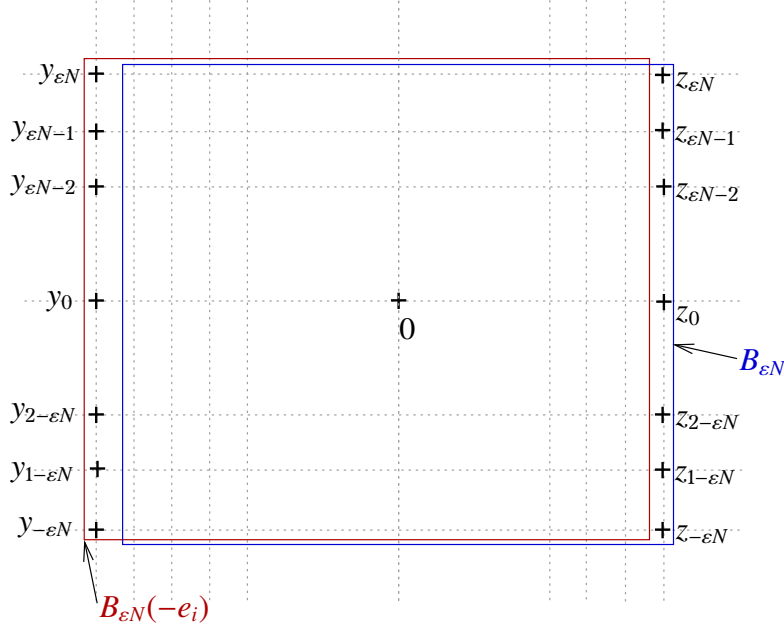
Figure 7: Definition of the  $y_k$ 's and  $z_k$ 's.

Since  $y_k$  and  $z_k$  are distant of  $2\varepsilon N + 1$ , the first term in the decomposition above can be bounded in absolute value uniformly in  $x$  and  $k$  by  $(2\varepsilon N + 1) \|\partial_{u_i} G\|_\infty / N$ . Let  $C(G, \omega) = \|\partial_{u_i} G\|_\infty \|\omega\|_\infty \|d_s\|_\infty$ , the corresponding contribution in (5.10) is

$$\frac{1}{N} \sum_{x \in \mathbb{T}_N^2} \underbrace{\eta_x^\omega}_{\leq \|\omega\|_\infty} \mathbb{1}_{E_{p,x}^c} \frac{1}{(2\varepsilon N + 1)^2} \left( \sum_{k=-\varepsilon N}^{\varepsilon N} \underbrace{\left[ G\left(\frac{x+y_k}{N}\right) - G\left(\frac{x+z_k}{N}\right) \right]}_{\leq (2\varepsilon N + 1) \|\partial_{u_i} G\|_\infty / N} \underbrace{d_s(\tau_{x+y_k} \rho_{\varepsilon N})}_{\leq \|d_s\|_\infty} \right),$$

and can therefore be bounded by

$$\frac{C(G, \omega)}{N^2} \sum_{x \in \mathbb{T}_N^2} \mathbb{1}_{E_{p,x}^c}.$$

Furthermore, since  $d_s$  is  $C^\infty$  on  $[0, 1]$ , it is Lipschitz-continuous on  $[0, 1]$  with lipschitz constant  $c$ , we let  $C'(G, \omega) = c \|G\|_\infty \|\omega\|_\infty / 2$ . We can now write thanks to the previous considerations that

$$|Y_2| \leq \frac{C(G, \omega)}{N^2} \sum_{x \in \mathbb{T}_N^2} \mathbb{1}_{E_{p,x}^c} + \frac{C'(G, \omega)}{N^2} \sum_{x \in \mathbb{T}_N^2} \frac{1}{(2\varepsilon N + 1)} \sum_{k=-\varepsilon N}^{\varepsilon N} \mathbb{1}_{E_{p,x}^c} \frac{|\tau_{x+y_k} \rho_{\varepsilon N} - \tau_{x+z_k} \rho_{\varepsilon N}|}{\varepsilon}.$$

For any positive  $\gamma$ , we have the elementary bound

$$\mathbb{1}_{E_{p,x}^c} \frac{|\tau_{x+y_k} \rho_{\varepsilon N} - \tau_{x+z_k} \rho_{\varepsilon N}|}{\varepsilon} \leq \gamma \mathbb{1}_{E_{p,x}^c} + \frac{1}{\gamma} \frac{(\tau_{x+y_k} \rho_{\varepsilon N} - \tau_{x+z_k} \rho_{\varepsilon N})^2}{\varepsilon^2},$$

and finally, for any positive  $\gamma$ ,

$$|Y_2| \leq \frac{C + \gamma C'}{N^2} \sum_{x \in \mathbb{T}_N^2} \mathbb{1}_{E_{p,x}^c} + \frac{C'}{\gamma N^2} \sum_{x \in \mathbb{T}_N^2} \frac{1}{(2\varepsilon N + 1)} \sum_{k=-\varepsilon N}^{\varepsilon N} \frac{(\tau_{x-(\varepsilon N+1)e_i} \rho_{\varepsilon N} - \tau_{x+\varepsilon N e_i} \rho_{\varepsilon N})^2}{\varepsilon^2}$$

$$= \frac{C + \gamma C'}{N^2} \sum_{x \in \mathbb{T}_N^2} \mathbb{1}_{E_{p,x}^c} + \frac{C'}{\gamma N^2} \sum_{x \in \mathbb{T}_N^2} \frac{(\tau_{x-(\varepsilon N+1)e_i} \rho_{\varepsilon N} - \tau_{x+\varepsilon N e_i} \rho_{\varepsilon N})^2}{\varepsilon^2}. \quad (5.11)$$

Recall that we want to prove (5.5), i.e.

$$\lim_{p \rightarrow \infty} \limsup_{\varepsilon \rightarrow 0} \limsup_{N \rightarrow \infty} \mathbb{E}_{\mu^N}^{\lambda, \beta} \left( \int_0^T |Y_2(G_t, \widehat{\eta}(t))| dt \right) = 0.$$

The contribution of the first term in the bound for  $|Y_2|$  in equation (5.11) vanishes for any  $\gamma$  as  $N$  then  $p$  goes to  $\infty$ , thanks to Proposition 2.12.

Furthermore, we can replace  $\tau_{x-(\varepsilon N+1)e_i} \rho_{\varepsilon N}$  by  $\tau_{x-\varepsilon N e_i} \rho_{\varepsilon N}$  in (5.11) since the difference between these two quantities is of order  $1/N$  and vanishes in the limit  $N \rightarrow \infty$ . This replacement allows us to work only with quantities that can be expressed in terms of the empirical measure of the process. Equation (5.5) therefore holds according to Lemma 5.3 below, letting  $\gamma$  go to  $\infty$  after  $N \rightarrow \infty$  then  $\varepsilon \rightarrow 0$  then  $p \rightarrow \infty$ .  $\blacksquare$

**Lemma 5.3.** *There exists a positive constant  $K$  such that*

$$\limsup_{\varepsilon \rightarrow 0} \limsup_{N \rightarrow \infty} \mathbb{E}_{\mu^N}^{\lambda, \beta} \left( \int_0^T \frac{1}{N^2} \sum_{x \in \mathbb{T}_N^2} \frac{(\tau_{x-\varepsilon N e_i} \rho_{\varepsilon N}(t) - \tau_{x+\varepsilon N e_i} \rho_{\varepsilon N}(t))^2}{\varepsilon^2} dt \right) \leq K.$$

*Proof of Lemma 5.3 :* This Lemma states that the difference of macroscopic densities between two points distant from  $2\varepsilon$  is also of order  $\varepsilon$ , and is a consequence of the energy estimate (4.34). We are going to prove this macroscopic estimate in the topological setup of the space of càdlàg trajectories of measures on  $\mathbb{T}^2 \times \mathbb{S}$ . Recall from Section 4.4 that  $\mathcal{M}(\mathbb{T}^2 \times \mathbb{S})$  is the space of positive measures on the continuous configuration space,

$$\mathcal{M}^{[0, T]} = D([0, T] \times \mathcal{M}(\mathbb{T}^2 \times \mathbb{S}))$$

is the space of right-continuous, left-limit trajectories on the set of measures on  $\mathbb{T}^2 \times \mathbb{S}$ , and that  $Q^N$  is the law on  $\mathcal{M}_T(\mathbb{T}^2 \times \mathbb{S})$  of the process empirical measure  $\pi^N$ . We have proved in Proposition 4.11 that the sequence  $(Q^N)_{N \in \mathbb{N}}$  is relatively compact for the weak topology. Let  $\Lambda_\varepsilon = [\varepsilon, \varepsilon]^2 \subset \mathbb{T}^2$  be the cube of size  $\varepsilon$ , and  $(\varphi_\varepsilon)_{\varepsilon > 0}$  be a family of localizing functions on  $\mathbb{T}^2$

$$\varphi_\varepsilon(\cdot) = \frac{1}{(2\varepsilon)^2} \mathbb{1}_{\Lambda_\varepsilon}(\cdot),$$

we then have

$$\tau_x \rho_{\varepsilon N}(t) = \frac{(2\varepsilon N)^2}{(2\varepsilon N + 1)^2} \langle \pi_t^N, \varphi_\varepsilon(\cdot + x/N) \rangle.$$

For any  $u \in \mathbb{T}^2$  we define the *mesoscopic gradient*

$$\nabla_i^\varepsilon \varphi(\cdot) = \varepsilon^{-1} (\varphi(\cdot - \varepsilon e_i) - \varphi(\cdot + \varepsilon e_i)),$$

represented in Figure 8b. Note that  $\nabla_i^\varepsilon \varphi_\varepsilon$  is at most of order  $\varepsilon^{-3}$  since  $\varphi_\varepsilon$  is of order  $\varepsilon^{-2}$ . We can rewrite the left-hand side in Lemma 5.3 as

$$\mathbb{E}_{Q^N} \left( \int_0^T \frac{1}{N^2} \sum_{x \in \mathbb{T}_N^2} \langle \pi_t, \nabla_i^\varepsilon \varphi_\varepsilon(\cdot + x/N) \rangle^2 dt \right) + o_N(1). \quad (5.12)$$

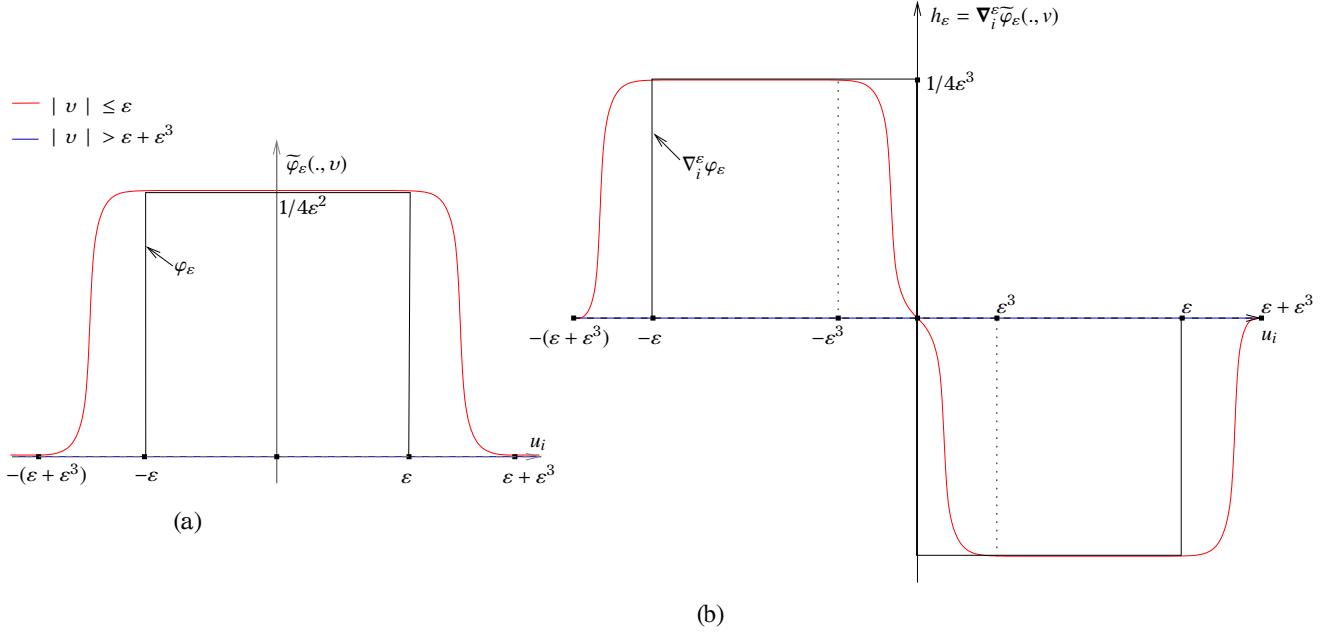

Figure 8: (a) Representations of  $\tilde{\varphi}_\varepsilon(\cdot, v)$  depending on the value of  $v$ .  
(b) Representation of  $h_\varepsilon(\cdot, v) = \nabla_i^\varepsilon \tilde{\varphi}_\varepsilon(\cdot, v)$  depending on the value of  $v$ .

Furthermore, since for any two sites  $x, x' \in \mathbb{T}^2$  distant from less than  $1/N$ ,

$$\left| \langle \pi_t, \nabla_i^\varepsilon \varphi_\varepsilon(\cdot + x/N) \rangle - \langle \pi_t, \nabla_i^\varepsilon \varphi_\varepsilon(\cdot + x'/N) \rangle \right| \leq C(\varepsilon) \frac{1}{N},$$

we can replace the sum above by the integral over the continuous torus.

However, regarding the weak topology on  $\mathcal{M}(\mathbb{T}^2 \times \mathbb{S})$ , it will be convenient later on to consider smooth functions instead of  $\varphi_\varepsilon$ . We therefore introduce for any  $\varepsilon$  a function  $\tilde{\varphi}_\varepsilon$ , represented in Figure 8a verifying

- $\tilde{\varphi}_\varepsilon = \varphi_\varepsilon$  on  $\Lambda_\varepsilon$  and on  $\mathbb{T}^2 \setminus \Lambda_{\varepsilon+\varepsilon^3}$ .
- $\|\tilde{\varphi}_\varepsilon\|_\infty = \|\varphi_\varepsilon\|_\infty$ .
- $\tilde{\varphi}_\varepsilon$  is in  $C^1(\mathbb{T}^2)$ .

Since  $\tilde{\varphi}_\varepsilon$  and  $\varphi_\varepsilon$  coincide everywhere except on  $\Lambda_{\varepsilon+\varepsilon^3} \setminus \Lambda_\varepsilon$ , and since  $\|\tilde{\varphi}_\varepsilon\|_\infty = (2\varepsilon)^{-2}$  we can write for any  $x \in \mathbb{T}_N^2$

$$\begin{aligned} \left| \langle \pi_t^N, \varphi_\varepsilon(\cdot + x/N) \rangle - \langle \pi_t^N, \tilde{\varphi}_\varepsilon(\cdot + x/N) \rangle \right| &\leq \frac{1}{(2\varepsilon)^2} \underbrace{\langle \pi_t^N, \mathbb{1}_{\Lambda_{\varepsilon+\varepsilon^3} \setminus \Lambda_\varepsilon}(\cdot + x/N) \rangle}_{\leq 4\varepsilon \times \varepsilon^3} \\ &\leq C\varepsilon^2, \end{aligned}$$

for some positive constant  $C$ . This bound immediately yields

$$\left| \langle \pi_t^N, \nabla_i^\varepsilon \varphi_\varepsilon(\cdot + x/N) \rangle - \langle \pi_t^N, \nabla_i^\varepsilon \tilde{\varphi}_\varepsilon(\cdot + x/N) \rangle \right| \leq C\varepsilon,$$

which allows us to replace in equation (5.12), in the limit  $N \rightarrow \infty$  then  $\varepsilon \rightarrow 0$ ,  $\varphi_\varepsilon$  by  $\widetilde{\varphi}_\varepsilon$ .

To prove Lemma 5.3 it is therefore sufficient to prove that

$$\limsup_{\varepsilon \rightarrow 0} \limsup_{N \rightarrow \infty} \mathbb{E}_{Q^N} \left( \iint_{[0,T] \times \mathbb{T}^2} \langle \pi_t, h_\varepsilon(\cdot + u) \rangle^2 dudt \right) \leq K, \quad (5.13)$$

where  $h_\varepsilon = \nabla_i^\varepsilon \widetilde{\varphi}_\varepsilon$ , is a continuous bounded function, represented in Figure 8b. Let us denote by  $\Pi$  the subset of  $\mathcal{M}^{[0,T]}$

$$\Pi = \left\{ \pi \in \mathcal{M}^{[0,T]}, \quad \sup_{t \in [0,T]} \langle \pi_t, 1 \rangle \leq 1 \right\}$$

of trajectories with mass less than one at all times, which is compact w.r.t Skorohod's topology introduced in Section 4.4.

Consider a weakly convergent subsequence  $Q_{N_k} \rightarrow Q^*$ , in order to substitute  $Q^*$  to  $Q^N$  in the limit above, we want to prove that for any fixed  $\varepsilon > 0$ , the application

$$I_\varepsilon : \pi \mapsto \iint_{[0,T] \times \mathbb{T}^2} \langle \pi_t, h_\varepsilon(\cdot + u) \rangle^2 dudt$$

is bounded, and continuous on  $\Pi$  w.r.t. Skorohod's topology.

Note that this application is bounded on  $\Pi$  by construction, we now prove the following Lemma.

**Lemma 5.4.** *Fix  $\varepsilon > 0$ , the application  $I_\varepsilon$  is continuous on  $(\Pi, d)$ , where  $d$  is the Skorohod metric defined in Equation (A.3).*

*Proof of Lemma 5.4 :* For any two trajectories  $\pi$  and  $\pi'$  in  $\Pi$ , and some continuous strictly increasing function  $\kappa$  from  $[0, T]$  into itself, such that  $\kappa_0 = 0$  and  $\kappa_T = T$ , we can write

$$I_\varepsilon(\pi) - I_\varepsilon(\pi') = \iint_{[0,T] \times \mathbb{T}^2} du \langle \pi'_t + \pi_t, h_\varepsilon(\cdot + u) \rangle \langle \pi'_t - \pi_{\kappa_t} + \pi_{\kappa_t} - \pi_t, h_\varepsilon(\cdot + u) \rangle dt.$$

The first factor  $\langle \pi'_t + \pi_t, h_\varepsilon(\cdot + u) \rangle$  can be crudely controlled by  $2\|h_\varepsilon\|_\infty$ , which yields

$$\left| I_\varepsilon(\pi) - I_\varepsilon(\pi') \right| \leq 2\|h_\varepsilon\|_\infty \iint_{[0,T] \times \mathbb{T}^2} \left| \langle \pi'_t - \pi_{\kappa_t}, h_\varepsilon(\cdot + u) \rangle + \langle \pi_{\kappa_t} - \pi_t, h_\varepsilon(\cdot + u) \rangle \right| dudt. \quad (5.14)$$

Note that by definition of  $\|\kappa\|$ , one easily gets that for any  $t \in [0, T]$ ,  $|t - \kappa_t| \leq T(e^{\|\kappa\|} - 1)$ , therefore,  $\kappa_t \rightarrow t$  uniformly on  $[0, T]$  as  $\|\kappa\| \rightarrow 0$ . Let us fix  $\pi \in \Pi$ , and assume that  $d(\pi, \pi^n) \rightarrow 0$  for some sequence of trajectories  $(\pi^n)_n \in \Pi^\mathbb{N}$ , there exists a sequence  $(\kappa^n)_{n \in \mathbb{N}}$  such that  $\|\kappa^n\| \rightarrow 0$  and  $\lim_{n \rightarrow \infty} \sup_{t \in [0, T]} \delta(\pi_t^n, \pi_{\kappa_t^n}) = 0$ . This last statement yields in particular that for any  $t \in [0, T]$ ,  $\delta(\pi_t^n, \pi_{\kappa_t^n}) \rightarrow 0$ , therefore for any  $t \in [0, T]$ , and for any  $u \in \mathbb{T}^2$ ,

$$\lim_{n \rightarrow \infty} \langle \pi_t^n - \pi_{\kappa_t^n}, h_\varepsilon(\cdot + u) \rangle = 0,$$

since  $h_\varepsilon(\cdot + u)$  is a continuous bounded function, and  $\delta$  is a metric of the weak convergence. Furthermore, since  $\kappa_t^n$  converges uniformly towards  $t$  on  $[0, T]$  and since  $t \rightarrow \pi_t$  is weakly continuous almost everywhere on  $[0, T]$  by definition of  $\mathcal{M}^{[0,T]}$ , we also have that for any  $(t, u) \in [0, T] \times \mathbb{T}^2$ ,

$$\lim_{n \rightarrow \infty} \langle \pi_{\kappa_t^n} - \pi_t, h_\varepsilon(\cdot + u) \rangle = 0.$$

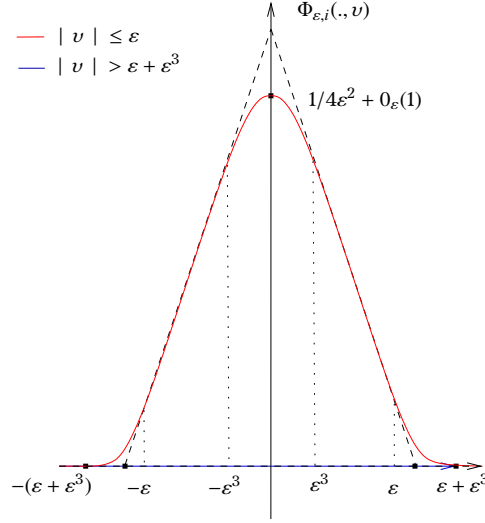
Figure 9: Representation of  $\Phi_{\varepsilon,i}(\cdot, v)$  depending on  $v$ .

Since  $\pi$  and the  $\pi^n$ 's are in  $\Pi$ , both of these quantities are crudely bounded in absolute value by  $2\|h_\infty\|$ , which is naturally integrable on  $[0, T] \times \mathbb{T}^2$ . One finally obtains by dominated convergence, from (5.14) applied to  $\pi' = \pi^n$  and  $\kappa = \kappa^n$ , that

$$\left| I_\varepsilon(\pi) - I_\varepsilon(\pi^n) \right| \xrightarrow{n \rightarrow \infty} 0.$$

Lemma 5.4 is complete.  $\blacksquare$

We have now proved that the application  $I_\varepsilon$  is continuous for any fixed  $\varepsilon$ , therefore the left-hand side of (5.13) is less than

$$\limsup_{\varepsilon \rightarrow 0} \sup_{Q^*} \mathbb{E}_{Q^*} \left( \iint_{[0, T] \times \mathbb{T}^2} du \langle \pi_t, h_\varepsilon(\cdot + u) \rangle^2 dt \right),$$

where the supremum is taken over all limit points  $Q^*$  of the sequence  $Q^N$ . Since by definition  $h_\varepsilon = \nabla_i^\varepsilon \widetilde{\varphi}_\varepsilon$  does not depend on  $\theta$ , we drop the dependency of  $\pi$  on  $\theta$  and consider simply for any  $u \in \mathbb{T}_N^2$ ,  $\rho(t, u) = \int_{\mathbb{S}} \widehat{\rho}_t(u, d\theta)$ , where  $\widehat{\rho}_t(u, d\theta)$  is the density of  $\pi_t(\cdot, d\theta)$  w.r.t. the Lebesgue measure  $\mathbb{T}^2$ , which exists  $Q^*$ -a.s. according to Lemma 4.13. We can write

$$\mathbb{E}_{Q^*} \left( \iint_{[0, T] \times \mathbb{T}^2} du \langle \pi_t, h_\varepsilon(\cdot + u) \rangle^2 dt \right) = \mathbb{E}_{Q^*} \left( \iint_{[0, T] \times \mathbb{T}^2} \left( \int_{v \in \mathbb{T}^2} \rho(t, v) \nabla_i^\varepsilon \widetilde{\varphi}_\varepsilon(v + u) dv \right)^2 dudt \right). \quad (5.15)$$

We can now express  $\nabla_i^\varepsilon \widetilde{\varphi}_\varepsilon$  as a gradient, by writing

$$\nabla_i^\varepsilon \widetilde{\varphi}_\varepsilon(u) = \partial_{u_i} \int_{-1/2}^{u_i} \nabla_i^\varepsilon \widetilde{\varphi}_\varepsilon(v e_i + u_{i'} e_{i'}) dv = \partial_{u_i} \Phi_{\varepsilon,i},$$

where  $i' \neq i$  still denotes the second direction on the torus.

Furthermore,  $\Phi_{\varepsilon,i}$ , represented in Figure 9, is in  $C^2(\mathbb{T}_N^2)$  because  $\widetilde{\varphi}_\varepsilon$  is  $C^1$ , and the various integrals can be freely swapped since all quantities are bounded at any fixed  $\varepsilon$ . Since  $Q^*$ -a.s.

$\rho \in W^{1,2}([0, T] \times \mathbb{T}^2)$  according to Theorem 4.14, the right-hand side in equation (5.15) is therefore equal to

$$\mathbb{E}_{Q^*} \left( \iint_{[0, T] \times \mathbb{T}^2} \left( \int_{v \in \mathbb{T}^2} \Phi_{\varepsilon, i}(v + u) \partial_{u_i} \rho(t, v) dv \right)^2 dudt \right). \quad (5.16)$$

In order to conclude, we adapt the proof of Young's Inequality, and apply Cauchy-Schwarz inequality to  $f = (\Phi_{\varepsilon, i}(v + u))^{1/2}$  and  $g = (\Phi_{\varepsilon, i}(v + u))^{1/2} \partial_{u_i} \rho(t, v)$ , to finally obtain that

$$\begin{aligned} \mathbb{E}_{Q^*} \left( \iint_{[0, T] \times \mathbb{T}^2} du \langle \pi_t, h_\varepsilon(\cdot + u) \rangle^2 dt \right) &\leq \mathbb{E}_{Q^*} \left( \iint_{[0, T] \times \mathbb{T}^2} \|\Phi_{\varepsilon, i}\|_1 \left[ \int_{v \in \mathbb{T}^2} \Phi_{\varepsilon, i}(v + u) (\partial_{u_i} \rho(t, v))^2 dv \right] dudt \right) \\ &= \|\Phi_{\varepsilon, i}\|_1^2 \mathbb{E}_{Q^*} \left( \iint_{[0, T] \times \mathbb{T}^2} (\partial_{u_i} \rho(t, u))^2 dudt \right), \end{aligned}$$

where the last identity was obtained by integrating first w.r.t.  $u$ , then w.r.t.  $v$ . Since  $\|\Phi_{\varepsilon, i}\|_1 = 1 + o_\varepsilon(1)$ , Lemma 5.3 follows from equation (4.34).  $\blacksquare$

## 5.4 Replacement of the macroscopic gradients by their local counterparts

We now prove equation (5.6), i.e. that the macroscopic average of the gradients can be replaced by a local average. To simplify the notations, throughout this Section, we drop the various dependencies of  $Y_{i,3}^{\lambda, \varepsilon N, p}$  and simply denote it by  $Y_3$ .

Recall that  $\mathcal{L}^{G, \beta=0}$  stands for the modified Glauber generator without alignment of the spins, where each angle is updated uniformly in  $\mathbb{S}$ ,

$$\mathcal{L}^{G, \beta=0} f(\widehat{\eta}) = \sum_{x \in \mathbb{T}_N^2} \eta_x \int_{\mathbb{S}} \frac{(f(\widehat{\eta}^{x, \theta}) - f(\widehat{\eta}))}{2\pi} d\theta,$$

and

$$L_N^{\beta=0} = N^2 \mathcal{L}^D + \mathcal{L}^{G, \beta=0}.$$

Recall that  $\mathbb{P}_{\mu_\alpha^*}^{\lambda, 0}$  is the measure on the trajectories starting from the equilibrium measure  $\mu_\alpha^*$  and driven by the generator  $L_N^{\beta=0}$ , and that the expectation w.r.t the latter is denoted by  $\mathbb{E}_{\mu_\alpha^*}^{\lambda, 0}$ . We first apply Proposition 2.10 to the positive functional

$$X(\widehat{\eta}^{[0, T]}) = \left| \int_0^T Y_3(G_t, \widehat{\eta}(t)) dt \right|,$$

letting  $A = \gamma N^2$ , and obtain that for some constant  $K_0 = K_0(T, \beta, \widehat{\rho}_0)$ ,

$$\mathbb{E}_{\mu_N^{\lambda, \beta}}^{\lambda, \beta} \left( \left| \int_0^T Y_3(G_t, \widehat{\eta}(t)) dt \right| \right) \leq \frac{K_0}{\gamma} + \frac{1}{\gamma N^2} \log \mathbb{E}_{\mu_\alpha^*}^{\lambda, 0} \left[ \exp \left( \gamma N^2 \left| \int_0^T Y_3(G_t, \widehat{\eta}(t)) dt \right| \right) \right].$$

Letting  $\gamma$  go to  $\infty$  after  $N$ , to prove (5.6) it is therefore enough to show that for any integer  $p > 1$

$$\lim_{\gamma \rightarrow \infty} \limsup_{l \rightarrow \infty} \limsup_{\varepsilon \rightarrow 0} \limsup_{N \rightarrow \infty} \frac{1}{\gamma N^2} \log \mathbb{E}_{\mu_\alpha^*}^{\lambda, 0} \left[ \exp \left( \gamma N^2 \left| \int_0^T Y_3(G_t, \widehat{\eta}(t)) dt \right| \right) \right] = 0. \quad (5.17)$$

We now get rid of the absolute value by using both of the elementary inequalities

$$e^{|x|} \leq e^x + e^{-x}$$

and

$$\limsup_{N \rightarrow \infty} \frac{1}{N^2} \log(a_N + b_N) \leq \max \left( \limsup_{N \rightarrow \infty} \frac{1}{N^2} \log a_N, \limsup_{N \rightarrow \infty} \frac{1}{N^2} \log b_N \right).$$

Both of these imply that the limit in equation (5.6) is bounded up by the maximum of the limits of

$$\frac{1}{\gamma N^2} \log \mathbb{E}_{\mu_\alpha^*}^{\lambda, 0} \left[ \exp \left( \gamma N^2 \int_0^T Y_3(G_t, \widehat{\eta}(t)) dt \right) \right]$$

and

$$\frac{1}{\gamma N^2} \log \mathbb{E}_{\mu_\alpha^*}^{\lambda, 0} \left[ \exp \left( -\gamma N^2 \int_0^T Y_3(G_t, \widehat{\eta}(t)) dt \right) \right].$$

Since  $-Y_3(G, \widehat{\eta}) = Y_3(-G, \widehat{\eta})$ , and since the identity above must be true for any function  $G$ , to obtain the wanted result it is sufficient to show that for any  $\gamma$  and any  $G \in C^{1,2}([0, T] \times \mathbb{T}^2)$

$$\lim_{\gamma \rightarrow \infty} \inf_f \limsup_{\varepsilon \rightarrow 0} \limsup_{N \rightarrow \infty} \frac{1}{\gamma N^2} \log \mathbb{E}_{\mu_\alpha^*}^{\lambda, 0} \left[ \exp \left( \gamma N^2 \int_0^T Y_3(G_t, \widehat{\eta}(t)) dt \right) \right] \leq 0. \quad (5.18)$$

We now get back to a variational problem, since Lemma 4.9 yields

$$\frac{1}{\gamma N^2} \log \mathbb{E}_{\mu_\alpha^*}^{\lambda, 0} \left[ \exp \left( \gamma N^2 \int_0^T Y_3(G_t, \widehat{\eta}(t)) dt \right) \right] \leq \frac{2T\lambda^2}{\gamma} + \frac{1}{\gamma} \int_0^T \sup_{\varphi} \left\{ \mathbb{E}_\alpha^* (\varphi \gamma Y_3(G_t, \widehat{\eta})) - \frac{1}{2} D(\varphi) \right\}.$$

The first term in the right-hand side above vanishes as  $\gamma$  goes to  $\infty$ . Furthermore, the time integral is now only applied to the function  $G_t$ , therefore to obtain equation (5.6), it is sufficient to prove that for any  $\gamma$  and any function  $G \in C^2(\mathbb{T}^2)$ ,

$$\limsup_{l \rightarrow \infty} \limsup_{\varepsilon \rightarrow 0} \limsup_{N \rightarrow \infty} \sup_{\varphi} \{ 2\gamma \mathbb{E}_\alpha^* (\varphi Y_3(G, \widehat{\eta})) - D(\varphi) \} \leq 0. \quad (5.19)$$

Since this must be true for any  $G$  and any  $\gamma$ , we can safely assume that  $\gamma = 1/2$ , and equation (5.19) follows from Lemma 5.5 below. Thus this completes the proof of (5.6).

In order to avoid repeating a similar proof twice, we forget for the moment that  $\mathfrak{d}^\omega(\rho, \rho^\omega) = d_s(\rho)$  only depends on the total particle density, and present the proof of the following Lemma in the most difficult case where the gradient is on  $\rho^{\omega, p}$  and where the diffusion coefficient depends on both  $\rho$  and  $\rho^\omega$ . We simply assume throughout this proof that the diffusion coefficient  $\mathfrak{d}^\omega$  is a uniformly continuous function of  $\rho$  and  $\rho^\omega$  on the set

$$\{(\alpha, \alpha_\omega) \in [0, 1] \times [-\|\omega\|_\infty, \|\omega\|_\infty], \quad |\alpha_\omega| \leq \|\omega\|_\infty \alpha\}.$$

**Lemma 5.5.** *Let us fix  $1 \leq i, j \leq 2$ , we shorten*

$$\mathcal{D}_k = \mathfrak{d}^\omega(\rho_k, \rho_k^\omega) \text{ and } v_k = \delta_i \rho_k^{\omega, p}.$$

For any  $G \in C^2(\mathbb{T}^2)$

$$\limsup_{l \rightarrow \infty} \limsup_{\varepsilon \rightarrow 0} \limsup_{N \rightarrow \infty} \sup_{\varphi} \left\{ \sum_{x \in \mathbb{T}_N^2} \left[ \frac{1}{N} G(x/N) \mathbb{E}_\alpha^* (\varphi \tau_x (\mathcal{D}_{\varepsilon N} v_{\varepsilon N} - \mathcal{D}_l v_l)) \right] - D(\varphi) \right\} \leq 0, \quad (5.20)$$



where as before  $l_p = l - p - 1$ , and the supremum is taken over all probability densities with respect to  $\mu_\alpha^*$ . The same result is true for the gradients  $v_k = \delta_i \rho_k$  instead of  $\delta_i \rho_k^{\omega, p}$ ,  $\mathfrak{d}$  instead of  $\mathfrak{d}^\omega$ , and  $l' = l - 1$  instead of  $l_p$ .

*Proof of Lemma 5.5 :* The difficulty of this Lemma comes from the extra factor  $N$ , which prevents us from using directly the replacement Lemma 3.1. We hence need to get some precise control over each term to ensure that they are small enough. We start by splitting in two parts the quantity in Lemma 5.5 by noticing that

$$\mathcal{D}_{\varepsilon N} v_{\varepsilon N} - \mathcal{D}_l v_{l_p} = \mathcal{D}_{\varepsilon N}(v_{\varepsilon N} - v_{l_p}) + (\mathcal{D}_{\varepsilon N} - \mathcal{D}_l)v_{l_p}. \quad (5.21)$$

Both terms are treated in the same fashion due to the continuity of the diffusion coefficients (which follows directly from their explicit expression). More precisely, we intend to show that the difference between the average over a microscopic and macroscopic box is of order  $1/N$ , and hence yields the extra factor  $N$  needed to use the replacement Lemma. Let us thus consider the first term appearing in the Lemma, namely

$$\frac{1}{N} \mathbb{E}_\alpha^* \left( \varphi \sum_{x \in \mathbb{T}_N^2} G(x/N) \tau_x \mathcal{D}_{\varepsilon N}(v_{\varepsilon N} - v_{l_p}) \right).$$

Recall that we denoted  $B_l = \{x \in \mathbb{T}_N^2, |x| \leq l\}$ , and  $|B_l| = (2l+1)^2$ . Since both  $v_{\varepsilon N}$  and  $v_{l_p}$  are merely spatial averages of the gradients  $\delta_i(\eta_0^\omega \mathbb{1}_{E_p})$ , a first summation by parts yields that the quantity above is equal to

$$\frac{1}{N} \mathbb{E}_\alpha^* \left( \varphi \sum_{x \in \mathbb{T}_N^2} (\eta_{x+e_i}^\omega \mathbb{1}_{E_{p,x+e_i}} - \eta_x^\omega \mathbb{1}_{E_{p,x}}) \left[ \frac{1}{|B_{\varepsilon N}|} \sum_{|y-x| \leq \varepsilon N} G(y/N) \tau_y \mathcal{D}_{\varepsilon N} - \frac{1}{|B_{l_p}|} \sum_{|y-x| \leq l_p} G(y/N) \tau_y \mathcal{D}_{\varepsilon N} \right] \right).$$

Now let us denote  $S_x(\widehat{\eta})$  the quantity inside braces, i.e

$$S_x(\widehat{\eta}) = \frac{1}{|B_{\varepsilon N}|} \sum_{|y-x| \leq \varepsilon N} G(y/N) \tau_y \mathcal{D}_{\varepsilon N} - \frac{1}{|B_{l_p}|} \sum_{|y-x| \leq l_p} G(y/N) \tau_y \mathcal{D}_{\varepsilon N}.$$

We are now going to prove that

$$\limsup_{l \rightarrow \infty} \limsup_{\varepsilon \rightarrow 0} \limsup_{N \rightarrow \infty} \sup_{\varphi} \left\{ \frac{1}{N} \mathbb{E}_\alpha^* \left( \varphi \sum_{x \in \mathbb{T}_N^2} S_x(\widehat{\eta}^\omega_{x+e_i} \mathbb{1}_{E_{p,x+e_i}} - \eta_x^\omega \mathbb{1}_{E_{p,x}}) \right) - \frac{1}{2} D(\varphi) \right\} \leq 0. \quad (5.22)$$

In order to transfer the gradient appearing in the expression above on  $\varphi$  and  $S_x$ , we need the same change of variable as the one already introduced in Figure 6 of Section 4.5. For any direction  $i \in \{1, 2\}$ , let  $i' \neq i$  be the second direction on the torus. Given  $x$  in the torus, we denote for any  $k \in \llbracket -p, p \rrbracket$  (See Figure 7)

$$y_k = x - p e_i + k e_{i'} \in B_p(x) \quad \text{and} \quad z_k = x + (p+1) e_i + k e_{i'} \in B_p(x + e_i).$$

Given these, recall that we denote, for any configuration  $\widehat{\eta}$ , by

$$T_{i,p}^x(\widehat{\eta}) = ((\widehat{\eta}^{x, x+e_i})^{y_{-p}, z_{-p}} \cdots)^{y_p, z_p}$$

the configuration where the sites  $x$  and  $x + e_i$  have been swapped, as well as the boundary sites  $y_k$  and  $z_k$ .

By definition, we have

$$\eta_x^\omega \mathbb{1}_{E_{p,x}}(T_{i,p}^x \widehat{\eta}) = \eta_{x+e_i}^\omega \mathbb{1}_{E_{p,x+e_i}}(\widehat{\eta})$$

The first term in the left-hand side of (5.22) can be rewritten as

$$\begin{aligned} \frac{1}{N} \mathbb{E}_\alpha^* \left( \varphi \sum_{x \in \mathbb{T}_N^2} S_x (\eta_{x+e_i}^\omega \mathbb{1}_{E_{p,x+e_i}} - \eta_x^\omega \mathbb{1}_{E_{p,x}}) \right) &= - \frac{1}{N} \mathbb{E}_\alpha^* \left( \sum_{x \in \mathbb{T}_N^2} \eta_x^\omega \mathbb{1}_{E_{p,x}} \left( (\varphi S_x)(T_{i,p}^x \widehat{\eta}) - \varphi S_x \right) \right) \\ &= - \frac{1}{N} \sum_{x \in \mathbb{T}_N^2} \mathbb{E}_\alpha^* \left( \eta_x^\omega \mathbb{1}_{E_{p,x}} \left[ \varphi(T_{i,p}^x \widehat{\eta}) \left( S_x(T_{i,p}^x \widehat{\eta}) - S_x \right) \right. \right. \\ &\quad \left. \left. + (\varphi(T_{i,p}^x \widehat{\eta}) - \varphi) S_x \right] \right). \end{aligned} \quad (5.23)$$

We are going to show that the contribution of the first term of the right-hand side in (5.23) vanishes in the limit  $N \rightarrow \infty$ , whereas the second term can be controlled with the Dirichlet form  $D(\varphi)$ . Recall that  $S_x$  is defined as

$$S_x(\widehat{\eta}) = \frac{1}{|B_{\varepsilon N}|} \sum_{|y-x| \leq \varepsilon N} G(y/N) \tau_y \mathcal{D}_{\varepsilon N} - \frac{1}{|B_{l_p}|} \sum_{|y-x| \leq l_p} G(y/N) \tau_y \mathcal{D}_{\varepsilon N}.$$

Since the only dependency of  $S_x$  in  $\widehat{\eta}$  lies in  $\mathcal{D}_{\varepsilon N}$ , which is the diffusion coefficient evaluated in the macroscopic empirical density  $\widehat{\rho}_{\varepsilon N}$ , in order to control the first term in the right-hand side of (5.23), we can write

$$\begin{aligned} S_x(T_{i,p}^x \widehat{\eta}) - S_x &= \\ \frac{1}{|B_{\varepsilon N}|} \sum_{|y-x| \leq \varepsilon N} G(y/N) \tau_y \left[ \mathcal{D}_{\varepsilon N}(T_{i,p}^x \widehat{\eta}) - \mathcal{D}_{\varepsilon N}(\widehat{\eta}) \right] &- \frac{1}{|B_{l_p}|} \sum_{|y-x| \leq l_p} G(y/N) \tau_y \left[ \mathcal{D}_{\varepsilon N}(T_{i,p}^x \widehat{\eta}) - \mathcal{D}_{\varepsilon N}(\widehat{\eta}) \right]. \end{aligned} \quad (5.24)$$

Recall that  $\tau_y \mathcal{D}_{\varepsilon N}(\widehat{\eta}) = \mathfrak{d}^\omega(\tau_y \rho_{\varepsilon N}, \tau_y \rho_{\varepsilon N}^\omega)$ . Since it depends on the configuration through an average over  $B_{\varepsilon N}(y)$ ,  $\tau_y \mathcal{D}_{\varepsilon N}(\widehat{\eta})$  is invariant under any exchange of a pair of sites with both ends in  $B_{\varepsilon N}(y)$ . We deduce from this remark that for any  $|y-x| \leq l_p$ , the quantity

$$\tau_y \left[ \mathcal{D}_{\varepsilon N}(T_{i,p}^x \widehat{\eta}) - \mathcal{D}_{\varepsilon N}(\widehat{\eta}) \right]$$

vanishes, since all the exchanges happen between sites at a distance at most  $p$  of  $x$ , and therefore at a distance at most  $p + l_p$  of  $y$ . This yields that the second term in the right-hand side of (5.24) vanishes.

We now consider the first term in the right-hand side of (5.24). For the same reason as before, for any  $y$  in  $B_{\varepsilon N-p-1}(x)$ , all the exchanges in  $T_{i,p}^x$  have both ends in  $B_{\varepsilon N}(y)$ , and  $\tau_y \left[ \mathcal{D}_{\varepsilon N}(T_{i,p}^x \widehat{\eta}) - \mathcal{D}_{\varepsilon N}(\widehat{\eta}) \right]$  vanishes. We can finally rewrite (5.24) as

$$S_x(T_{i,p}^x \widehat{\eta}) - S_x = \frac{1}{|B_{\varepsilon N}|} \sum_{y \in B_{\varepsilon N}(x) \setminus B_{\varepsilon N-p-1}(x)} G(y/N) \tau_y \left[ \mathcal{D}_{\varepsilon N}(T_{i,p}^x \widehat{\eta}) - \mathcal{D}_{\varepsilon N}(\widehat{\eta}) \right]. \quad (5.25)$$

We now take a closer look at each of the remaining term. By definition, the configuration  $T_{i,p}^x \widehat{\eta}$  can be obtained from  $\widehat{\eta}$  by inverting  $2p+2$  pair of sites in  $\widehat{\eta}$ . Furthermore, fix a  $y$  in the sum above, and consider any inversion  $\widehat{\eta}^{z_1, z_2}$  with  $z_1 \in B_{\varepsilon N}(y)$  and  $z_2 \notin B_{\varepsilon N}(y)$ , we can write by definition of  $\rho_{\varepsilon N}$  and  $\rho_{\varepsilon N}^\omega$

$$\left| \tau_y \rho_{\varepsilon N}(\widehat{\eta}^{z_1, z_2}) - \tau_y \rho_{\varepsilon N}(\widehat{\eta}) \right| \leq \frac{1}{|B_{\varepsilon N}|} \quad \text{and} \quad \left| \tau_y \rho_{\varepsilon N}^\omega(\widehat{\eta}^{z_1, z_2}) - \tau_y \rho_{\varepsilon N}^\omega(\widehat{\eta}) \right| \leq \frac{2\|\omega\|_\infty}{|B_{\varepsilon N}|}.$$

By assumption,  $\mathfrak{d}^\omega(\alpha, \alpha_\omega)$  is uniformly continuous on the set

$$\{(\alpha, \alpha_\omega) \in [0, 1] \times [-\|\omega\|_\infty, \|\omega\|_\infty], \quad |\alpha_\omega| \leq \|\omega\|_\infty \alpha\}.$$

We deduce from this that

$$\tau_y (\mathcal{D}_{\varepsilon N}(\widehat{\eta}^{z_1, z_2}) - \mathcal{D}_{\varepsilon N}(\widehat{\eta})) = o_N(1),$$

therefore

$$\left| \tau_y (\mathcal{D}_{\varepsilon N}(T_{i,p}^x \widehat{\eta}) - \mathcal{D}_{\varepsilon N}(\widehat{\eta})) \right| \leq o_N(1),$$

where this time  $o_N(1)$  stands for a constant depending on  $p$  which vanishes as  $N \rightarrow \infty$ . We inject the latter identity in equation (5.25), to obtain that

$$S_x(T_{i,p}^x \widehat{\eta}) - S_x = \frac{|B_{\varepsilon N}(x) \setminus B_{\varepsilon N-p-1}(x)|}{|B_{\varepsilon N}|} o_N(1) = \frac{1}{N} o_N(1),$$

where the last  $o_N(1)$  depends on  $p$  and  $\varepsilon$ , but vanishes as  $N \rightarrow \infty$ . This allows us to get back to equation (5.23), in which the first term in the right-hand side can be rewritten

$$\left| \frac{1}{N} \sum_{x \in \mathbb{T}_N^2} \mathbb{E}_\alpha^* \left( \eta_x^\omega \mathbb{1}_{E_{p,x}} \varphi(T_{i,p}^x \widehat{\eta}) (S_x(T_{i,p}^x \widehat{\eta}) - S_x) \right) \right| \leq \frac{\|\omega\|_\infty}{N^2} \sum_{x \in \mathbb{T}_N^2} \mathbb{E}_\alpha^* \left( \varphi(T_{i,p}^x \widehat{\eta}) \right) o_N(1) = o_N(1),$$

since  $\mu_\alpha^*$  is invariant under the change of variable  $T_{i,p}^x \widehat{\eta}$ , and therefore  $\mathbb{E}_\alpha^* \left( \varphi(T_{i,p}^x \widehat{\eta}) \right) = \mathbb{E}_\alpha^* (\varphi) = 1$ .

We now work on the contribution of the second part of (5.23), namely

$$\mathbb{E}_\alpha^* \left( N^{-1} \sum_{x \in \mathbb{T}_N^2} \eta_x^\omega \mathbb{1}_{E_{p,x}} S_x(\widehat{\eta}) \left[ \varphi(T_{i,p}^x \widehat{\eta}) - \varphi \right] \right), \quad (5.26)$$

that we wish to estimate by the Dirichlet form  $D(\varphi)$ . The elementary bound

$$cd(a-b) \leq \frac{Ac^2}{2} (\sqrt{a} - \sqrt{b})^2 + \frac{d^2}{2A} (\sqrt{a} + \sqrt{b})^2,$$

which holds for any positive constant  $A$ , applied to

$$a = \varphi(T_{i,p}^x \widehat{\eta}), \quad b = \varphi, \quad c = \eta_x^\omega S_x \quad \text{and} \quad d = \mathbb{1}_{E_{p,x}}$$

yields that the quantity above (5.26) can be bounded from above for any positive  $A$  by

$$\frac{1}{N} \sum_{x \in \mathbb{T}_N^2} \mathbb{E}_\alpha^* \left( \frac{A}{2} (\eta_x^\omega S_x)^2 (\sqrt{\varphi}(T_{i,p}^x \widehat{\eta}) + \sqrt{\varphi})^2 + \frac{1}{2A} \mathbb{1}_{E_{p,x}} (\sqrt{\varphi}(T_{i,p}^x \widehat{\eta}) - \sqrt{\varphi})^2 \right). \quad (5.27)$$

Since we already established that  $S_x(T_{i,p}^x \widehat{\eta}) = S_x + (\varepsilon N)^{-1} o_N(1)$ , since  $\eta_x^\omega$  can be bounded by  $C(\omega) > 0$ , and since  $\mathbb{1}_{E_{p,x}} \leq \mathbb{1}_{E_{p+1,x}}$  the sum above is less than

$$\frac{AC^2}{N} \sum_{x \in \mathbb{T}_N^2} \mathbb{E}_\alpha^*(\varphi S_x^2) + \frac{1}{2AN} \sum_{x \in \mathbb{T}_N^2} \mathbb{E}_\alpha^* \left( \mathbb{1}_{E_{p+1,x}} \left( \sqrt{\varphi}(T_{i,p}^x \widehat{\eta}) - \sqrt{\varphi} \right)^2 \right) + o_N(1). \quad (5.28)$$

According to Section 2.3, on the event  $E_{p+1,x}$  on which there are two empty sites in  $B_{p+1}$ , there exists a sequence of allowed jumps permitting to reach  $T_{i,p}^x \widehat{\eta}$  from  $\widehat{\eta}$ . However, this sequence is random, which we avoid by crudely bounding

$$\mathbb{1}_{E_{p+1,x}} \leq \sum_{z_1, z_2 \in B_{p+1}} (1 - \eta_{z_1})(1 - \eta_{z_2}),$$

since the right-hand side only vanishes when there are less than one empty site in  $B_{p+1}$ . Given two fixed empty sites  $z_1$  and  $z_2$  there exists an integer  $n_p(z_1, z_2)$  bounded by a constant  $C_p$ , and a sequence of edges  $((a_m, b_m))_{m \in \llbracket 0, n_p \rrbracket}$  such that

$$\widehat{\eta} = \widehat{\eta}(0), \quad T_{i,p}^x \widehat{\eta} = \widehat{\eta}(n_p), \quad \text{and} \quad \widehat{\eta}(m+1) = \widehat{\eta}(m)^{a_m, b_m} \quad \forall m \in \llbracket 0, n_p - 1 \rrbracket,$$

where  $a_m$  and  $b_m$  are neighboring sites in  $B_{p+1}(x)$  and  $\eta_{a_m}(\widehat{\eta}(m)) = 1 - \eta_{b_m}(\widehat{\eta}(m)) = 1$ . We can therefore write

$$\begin{aligned} \mathbb{E}_\alpha^* \left( \mathbb{1}_{E_{p,x}} \left( \sqrt{\varphi}(T_{i,p}^x \widehat{\eta}) - \sqrt{\varphi} \right)^2 \right) &\leq \sum_{z_1, z_2 \in B_{p+1}} \mathbb{E}_\alpha^* \left( n_p \sum_{m=0}^{n_p-1} \mathbb{1}_{E_{p,x}} \left( \sqrt{\varphi}(\widehat{\eta}(m+1)) - \sqrt{\varphi}(\widehat{\eta}(m)) \right)^2 \right) \\ &\leq K_p D_{N,p+1}(\varphi), \end{aligned}$$

since  $\widehat{\eta}(m+1)$  is reached from  $\widehat{\eta}(m)$  by an allowed particle jump, where  $D_{N,p+1}(\varphi)$  is the contribution of edges in  $B_{p+1}$  in  $D(\varphi)$ .

The sum in the second term of (5.28) can therefore be bounded by  $C_p^* D(\varphi)$ , where  $C_p^* = (2p+1)^2 K_p$ . Finally, (5.26) can be bounded, for any positive  $A$  by

$$\frac{AC^2}{N} \sum_{x \in \mathbb{T}_N^2} \mathbb{E}_\alpha^*(\varphi S_x^2) + \frac{C_p^*}{2AN} D(\varphi) + o_N(1).$$

We can now set  $A = C_p^*/N$ , to obtain that

$$\mathbb{E}_\alpha^* \left( N^{-1} \sum_{x \in \mathbb{T}_N^2} \eta_x^\omega \mathbb{1}_{E_{p,x}} S_x(\widehat{\eta}) \left[ \varphi(T_{i,p}^x \widehat{\eta}) - \varphi \right] \right) \leq \frac{C(p, \omega)}{N^2} \sum_{x \in \mathbb{T}_N^2} \mathbb{E}_\alpha^*(\varphi S_x^2) + \frac{1}{2} D(\varphi) + o_N(1).$$

The first term in the right-hand side above vanishes as a consequence of the two-block estimate stated in Lemma 3.3, since the diffusion coefficients are continuous according to their explicit expression. This concludes the proof of equation (5.22).

The contribution of the second part of equation (5.21) is treated in a similar fashion. Denoting by

$$S'_x(\widehat{\eta}) = \frac{1}{|B_{l_p}|} \sum_{|y-x| \leq l_p} G(y/N)(\tau_y \mathcal{D}_{\varepsilon N} - \tau_y \mathcal{D}_l).$$

As before, the corresponding contribution in the left-hand side of (5.20) can be written as

$$-\frac{1}{N} \sum_{x \in \mathbb{T}_N^2} \mathbb{E}_\alpha^* \left( \eta_x^\omega \mathbb{1}_{E_{p,x}} \left( \varphi(T_{i,p}^x \widehat{\eta}) - \varphi \right) S'_x \right),$$

since this time,  $S'_x$  is invariant under the action of  $T_{i,p}^x$  by definition of  $l_p$ , whereas the second term can be controlled in the limit  $N \rightarrow \infty$  as well by  $D(\varphi)/2$ . This completes the proof of Lemma 5.5 in the case where  $\mathcal{D}_k = \mathfrak{d}^\omega(\rho_k, \rho_k^\omega)$  and  $\nu_k = \delta_i \rho_k^{\omega,p}$ .

In the case where  $\mathcal{D}_k = \mathfrak{d}(\rho_k, \rho_k^\omega)$  and  $\nu_k = \delta_i \rho_k$ , the proof is easier and no longer requires indicator functions, since unlike  $\delta_i \eta_x^\omega$ ,  $\delta_i \eta_x$  vanishes when there is no empty site. We do not give a detailed proof, which would be an easier version of the previous case. We will instead just give a brief outline and the equivalent quantities to the previous ones. The same summation by parts allows us to rewrite

$$\frac{1}{N} G(x/N) \mathbb{E}_\alpha^* \left( \varphi \tau_x (\mathcal{D}_{\varepsilon N} \nu_{\varepsilon N} - \mathcal{D}_{l_p} \nu_{l_p}) \right) = \frac{1}{N} \mathbb{E}_\alpha^* \left( \varphi \sum_{x \in \mathbb{T}_N^2} (S_x + S'_x) (\eta_{x+e_i} - \eta_x) \right),$$

where

$$S_x = \frac{1}{|B_{\varepsilon N}|} \sum_{|y-x| \leq \varepsilon N} G(y/N) \tau_y \mathcal{D}_{\varepsilon N} - \frac{1}{|B_{l_p}|} \sum_{|y-x| \leq l_p} G(y/N) \tau_y \mathcal{D}_{\varepsilon N},$$

and

$$S'_x(\widehat{\eta}) = \frac{1}{|B_{l_p}|} \sum_{|y-x| \leq l_p} G(y/N) (\tau_y \mathcal{D}_{\varepsilon N} - \tau_y \mathcal{D}_l).$$

We can now rewrite  $\eta_{x+e_i} - \eta_x = \eta_{x+e_i}(1 - \eta_x) - \eta_x(1 - \eta_{x+e_i})$ , to obtain that the quantity above is

$$\frac{1}{N} \sum_{x \in \mathbb{T}_N^2} \mathbb{E}_\alpha^* \left( \eta_x (1 - \eta_{x+e_i}) \left( (S_x + S'_x) \varphi \right) (\widehat{\eta}^{x, x+e_i}) - (S_x + S'_x) \varphi \right).$$

The gradients of  $S_x$  and  $S'_x$  still vanish, whereas the average of the gradients  $\varphi(\widehat{\eta}^{x, x+e_i}) - \varphi$  can be controlled by the sum of a vanishing term and the Dirichlet form of  $\varphi$ , since this time the jump rates  $\eta_x(1 - \eta_{x+e_i})$  are already present. This concludes the proof of Lemma 5.5.  $\blacksquare$

## 5.5 Projection on non-full sets and reduction to a variance problem

We now prove the limit (5.7), which states that in a local average, the current can be replaced by gradients, up to a perturbation  $\mathcal{L}f$ . Following the exact same steps as in Section 5.4, up until the statement of Lemma 5.5, where we reduced the proof of equation (5.6) to (5.19), we reduce the proof of equation (5.7) to the variational formula

$$\inf_f \lim_{p \rightarrow \infty} \limsup_{l \rightarrow \infty} \limsup_{N \rightarrow \infty} \sup_{\varphi} \{ \mathbb{E}_\alpha^* (\varphi Y_4(G, \widehat{\eta})) - D(\varphi) \} \leq 0, \quad (5.29)$$

where we shortened

$$Y_4(G, \widehat{\eta}) = Y_{i,4}^{f,l,p}(G, \widehat{\eta}) = \frac{1}{N} \sum_{x \in \mathbb{T}_N^2} G(x/N) \tau_x \mathcal{W}_{i,4}^{f,l,p},$$

and  $\mathcal{W}_{i,4}^{f,l,p}$  was introduced in equation (5.3). Since this step is performed in the exact same way as in the beginning of Section 5.4, we do not detail them here and refer the reader to the latter. To simplify notations, we shorten

$$\mathcal{W}_i^l = \mathcal{W}_{i,4}^{f,l,p}$$

for the local average of the difference between gradients and currents in the direction  $i$ .

We will now work to get an estimate of the largest eigenvalue of the small perturbation  $\mathcal{L} + Y_4$  of  $\mathcal{L}$ . The strategy is close to the one used in the one-block estimate of Section 3.3. To do so, we break down the process on finite boxes with a fixed number of particles, where the generator  $\mathcal{L}$  has a positive spectral gap. In order to introduce this restriction, we adopt once again the notations introduced in Section 3.3, which we briefly recall here. Let  $B_l = \llbracket -l, l \rrbracket^2$  be the box of size  $l$ ,  $\widehat{K} = (K, \{\theta_1, \dots, \theta_K\})$  be some particle number and angles. Recall that  $\mathbb{K}_l$  is the set of  $\widehat{K}$ 's such that  $K \leq (2l+1)^2$ , and denote by  $\widehat{\alpha}_{\widehat{K}}$  the angle measure

$$\widehat{\alpha}_{\widehat{K}} = \frac{1}{(2l+1)^2} \sum_{k=1}^K \delta_{\theta_k} \in \mathcal{M}_1(\mathbb{S}).$$

Recall that we already defined in (2.3)

$$\Sigma_l^{\widehat{K}} = \left\{ \widehat{\eta} \in \Sigma_N, \quad \widehat{\rho}_l = \widehat{\alpha}_{\widehat{K}} \right\}$$

the set of configurations with  $K$  particles in  $B_l$  with angles  $\theta_k$ 's. Also recall that  $\mu_{l,\widehat{K}}$  is the canonical measure  $\mu_\alpha^*(\cdot | \Sigma_l^{\widehat{K}})$  conditioned to particle configurations of the form  $\widehat{K}$  in  $B_l$ .

We denote for any site  $x$   $\varphi^x = \tau_{-x}\varphi$ , and by  $\varphi_{l,\widehat{K}}^x$  the density induced by  $\varphi^x$  on  $\Sigma_l^{\widehat{K}}$ . It can be defined for any configuration  $\widehat{\zeta}$  on  $B_l$  by

$$\varphi_{l,\widehat{K}}^x(\widehat{\zeta}) = \frac{\mathbb{E}_\alpha^*(\varphi^x | \widehat{\eta}_{|B_l} = \widehat{\zeta})}{\mathbb{E}_\alpha^*(\varphi^x | \Sigma_l^{\widehat{K}})}.$$

Let us now get back to the quantity of interest,

$$\mathbb{E}_\alpha^*(\varphi Y_4(G, \widehat{\eta})) = \frac{1}{N} \sum_{x \in \mathbb{T}_N^2} G(x/N) \mathbb{E}_\alpha^*(\varphi \tau_x \mathcal{W}_i^l) = \frac{1}{N} \sum_{x \in \mathbb{T}_N^2} G(x/N) \mathbb{E}_\alpha^*(\mathcal{W}_i^l \varphi^x). \quad (5.30)$$

Because  $\mathcal{W}_i^l$  only depends on the vertices in  $B_l$ , we can replace the expectation under  $\mu_\alpha^*$  by the integral over  $\mathbb{K}_l$  of the expectation under  $\mu_{l,\widehat{K}}$ . More precisely, let us denote

$$m_x(d\widehat{K}) = \mathbb{E}_\alpha^*(\varphi^x \mathbb{1}_{\Sigma_l^{\widehat{K}}}),$$

the infinitesimal probability of being on the set  $\Sigma_l^{\widehat{K}}$  under the measure with density  $\varphi^x$  w.r.t  $\mu_\alpha^*$ . Thanks to (5.30), letting  $\mathbb{E}_{l,\alpha}^*$  be the conditional expectation of  $\mathbb{E}_\alpha^*$  w.r.t the spins inside of  $B_l$ , we can write

$$\mathbb{E}_\alpha^*(\varphi Y_4(G, \widehat{\eta})) = \frac{1}{N} \sum_{x \in \mathbb{T}_N^2} G(x/N) \mathbb{E}_{l,\alpha}^*(\mathcal{W}_i^l \varphi^x)$$

$$= \frac{1}{N} \sum_{x \in \mathbb{T}_N^2} G(x/N) \int_{\widehat{K} \in \mathbb{K}_l} \mathbb{E}_{l, \widehat{K}} \left( \mathcal{W}_i^l \varphi_{l, \widehat{K}}^x \right) m_x(d\widehat{K}). \quad (5.31)$$

Let us now decompose in a similar fashion the Dirichlet form. For  $\varphi$  some density with respect to  $\mu_{\widehat{\alpha}}$ , let  $D_{l, \widehat{K}}$  be the Dirichlet form on  $\Sigma_l^{\widehat{K}}$

$$D_{l, \widehat{K}}(\varphi) = \frac{1}{2} \sum_{\substack{x, y \in B_l \\ |x-y|=1}} \mathbb{E}_{l, \widehat{K}} \left[ \eta_x(1 - \eta_y) \left( \sqrt{\varphi(\widehat{\eta}^{x,y})} - \sqrt{\varphi} \right)^2 \right].$$

We have with the same tools as in the proof of Lemma 3.3

$$\sum_{x \in \mathbb{T}_N^2} \int_{\widehat{K} \in \mathbb{K}_l} D_{l, \widehat{K}} \left( \varphi_{l, \widehat{K}}^x \right) m(d\widehat{K}) \leq (2l+1)^2 D(\varphi). \quad (5.32)$$

From the previous considerations, we can localize the quantity inside braces in equation (5.29), which is bounded above thanks to (5.31) and (5.32) by

$$\begin{aligned} \mathbb{E}_{\alpha}^* (\varphi Y_4(G, \widehat{\eta})) - D(\varphi) &= \sum_{x \in \mathbb{T}_N^2} \int_{\widehat{K} \in \mathbb{K}_l} m(d\widehat{K}) \left( \frac{1}{N} G(x/N) \mathbb{E}_{l, \widehat{K}} \left( \mathcal{W}_i^l \varphi_{l, \widehat{K}}^x \right) - (2l+1)^{-2} D_{l, \widehat{K}} \left( \varphi_{l, \widehat{K}}^x \right) \right) \\ &\leq \kappa_1 \sum_{x \in \mathbb{T}_N^2} \sup_{\widehat{K} \in \mathbb{K}_l} \left[ \frac{\kappa_2}{N} \mathbb{E}_{l, \widehat{K}} \left( \mathcal{W}_i^l \varphi_{l, \widehat{K}}^x \right) - D_{l, \widehat{K}} \left( \varphi_{l, \widehat{K}}^x \right) \right] \\ &\leq \kappa_1 \sum_{x \in \mathbb{T}_N^2} \sup_{\widehat{K} \in \mathbb{K}_l} \sup_{\psi} \left[ \frac{\kappa_2}{N} \mathbb{E}_{l, \widehat{K}} \left( \mathcal{W}_i^l \psi \right) - D_{l, \widehat{K}}(\psi) \right], \end{aligned} \quad (5.33)$$

since  $\int_{\widehat{K} \in \mathbb{K}_l} m(d\widehat{K}) = 1$ , where

$$\kappa_1 = (2l+1)^{-2} \quad \text{and} \quad \kappa_2 = G(x/N)(2l+1)^2,$$

and the supremum is taken over all densities  $\psi$  with respect to  $\mu_{l, \widehat{K}}$ .

We now wish to exclude in the supremum over  $\widehat{K}$  above the configurations with one or less empty sites since on the corresponding sets, the exclusion process is not irreducible as investigated in Section 2.3. First note that for any  $\widehat{K}$  such that  $K = |B_l|$ ,  $\mathcal{W}_i^l$  vanishes. Indeed, thanks to our cutoff functions  $\mathbb{1}_{E_p}$ , and since  $l$  goes to  $\infty$  before  $p$ , in that case, the currents, the gradients as well as the  $\mathcal{L}f$ 's in  $\mathcal{W}_i^l$  all vanish as well as  $D_{l, \widehat{K}}(\psi)$ .

We now consider the case where  $K = |B_l| - 1$ , i.e. when there is one empty site in  $B_l$ . We state the corresponding estimate as a separate lemma for the sake of clarity.

**Lemma 5.6.** *There exists a constant  $C = C(G, \omega, f)$  such that for any  $\widehat{K}$  such that  $K = |B_l| - 1$ ,*

$$\frac{\kappa_2}{N} \mathbb{E}_{l, \widehat{K}} \left( \mathcal{W}_i^l \psi \right) \leq D_{l, \widehat{K}}(\psi) + \frac{C}{N^2}.$$

*Proof of Lemma 5.6 :* First note that all the gradients  $\delta_i \eta^{\omega, p}$  vanish in the expression of  $\mathcal{W}_i^l$  due

to the cutoff functions. We can therefore write, for any configuration with one or less empty site, that

$$\mathcal{W}_i^l = \frac{1}{(2l'+1)^2} \sum_{x \in B_{l'}} \left( j_{x,x+e_i}^\omega + \mathfrak{d}_{\widehat{K}} j_{x,x+e_i} \right) - \frac{1}{(2l_f+1)^2} \mathcal{L}_l \bar{f},$$

where we denoted by  $\mathfrak{d}_{\widehat{K}}$  the value on  $\Sigma_l^{\widehat{K}}$  of  $\mathfrak{d}(\rho_l, \rho_l^\omega)$ , which does not depend on the configuration, and  $\bar{f} = \sum_{x \in B_{l'}} \tau_x f$ . The quantity we want to estimate can therefore be rewritten

$$\frac{\kappa_2}{N} \mathbb{E}_{l, \widehat{K}} (\mathcal{W}_i^l \psi) = \frac{\kappa_2}{N(2l'+1)^2} \mathbb{E}_{l, \widehat{K}} \left( \psi \sum_{x \in B_{l'}} \left( j_{x,x+e_i}^\omega + \mathfrak{d}_{\widehat{K}} j_{x,x+e_i} \right) \right) - \frac{\kappa_2}{N(2l_f+1)^2} \mathbb{E}_{l, \widehat{K}} (\psi \mathcal{L}_l \bar{f}).$$

Since  $\kappa_2$ ,  $(2l'+1)^2$ , and  $(2l_f+1)^2$  are of order  $(2l+1)^2$ , and since the sign of  $f$  is arbitrary, to prove Lemma 5.6 it is sufficient to prove both

$$\frac{1}{N} \mathbb{E}_{l, \widehat{K}} \left( \psi \sum_{x \in B_{l'}} \left( j_{x,x+e_i}^\omega + \mathfrak{d}_{\widehat{K}} j_{x,x+e_i} \right) \right) \leq \frac{D_{l, \widehat{K}}(\psi)}{2} + \frac{C(\omega)}{N^2} \quad \text{and} \quad \frac{1}{N} \mathbb{E}_{l, \widehat{K}} (\psi \mathcal{L}_l \bar{f}) \leq \frac{D_{l, \widehat{K}}(\psi)}{2} + \frac{C(f)}{N^2}. \quad (5.34)$$

The two inequalities above are proven in the same way. We treat in detail the second, which is the most delicate, and simply sketch the adaptations to obtain the first. Using the elementary inequality

$$ab \leq \frac{\gamma a^2}{2} + \frac{b^2}{2\gamma}, \quad (5.35)$$

which holds for any positive  $\gamma$ , we first write

$$\begin{aligned} \mathbb{E}_{l, \widehat{K}} (\psi \mathcal{L}_l \bar{f}) &= \sum_{x, x+z \in B_l} \mathbb{E}_{l, \widehat{K}} (\psi \nabla_{x, x+z} \bar{f}) \\ &= -\frac{1}{2} \sum_{x, x+z \in B_l} \mathbb{E}_{l, \widehat{K}} (\nabla_{x, x+z} \psi \nabla_{x, x+z} \bar{f}) \\ &\leq \sum_{x, x+z \in B_l} \frac{\gamma}{4} \mathbb{E}_{l, \widehat{K}} ((\nabla_{x, x+z} \sqrt{\psi})^2) + \frac{1}{4\gamma} \mathbb{E}_{l, \widehat{K}} ((\nabla_{x, x+z} \bar{f})^2 (\sqrt{\psi} + \sqrt{\psi}(\widehat{\eta}^{x, x+z}))^2) \\ &= \frac{\gamma}{2} D_{l, \widehat{K}}(\psi) + \frac{1}{4\gamma} \mathbb{E}_{l, \widehat{K}} \left( \sum_{x, x+z \in B_l} \eta_x (1 - \eta_{x+z}) (\bar{f} - \bar{f}(\widehat{\eta}^{x, x+z}))^2 (\sqrt{\psi} + \sqrt{\psi}(\widehat{\eta}^{x, x+z}))^2 \right). \end{aligned}$$

One only has now to carefully account for the order of the different quantities in the second term. Since  $f$  is a bounded local function, by definition of  $\bar{f}$ , it is invariant under particle jumps with both ends outside of its domain. There hence exists a constant  $C(f)$  such that for any  $x$  and  $x+z$ ,  $\bar{f} - \bar{f}(\widehat{\eta}^{x, x+z}) \leq C(f)$ . In particular, the constant  $C(f)$  does not depend on  $l$ . We can also crudely bound  $\eta_x$  by 1 and  $(\sqrt{\psi} + \sqrt{\psi}(\widehat{\eta}^{x, x+z}))^2$  by  $2\psi + \psi(\widehat{\eta}^{x, x+z})$ . These bounds and a change of variable  $\widehat{\eta} \rightarrow \widehat{\eta}^{x, x+z}$  finally yield that for any positive  $\gamma$ ,

$$\mathbb{E}_{l, \widehat{K}} (\psi \mathcal{L}_l \bar{f}) \leq \frac{\gamma}{2} D_{l, \widehat{K}}(\psi) + \frac{C(f)}{2\gamma} \mathbb{E}_{l, \widehat{K}} \left( \sum_{x, x+z \in B_l} (2 - \eta_x - \eta_{x+z}) \psi \right).$$



Furthermore, since there is only one empty site in  $B_l$ ,

$$\sum_{|y| \leq l-1} (2 - \eta_y - \eta_{y+e_i}) = \underbrace{|B_{l-1}| - \sum_{y \in B_{l-1}} \eta_y}_{\leq 1} + \underbrace{|\tau_{e_i} B_{l-1}| - \sum_{y \in \tau_{e_i} B_{l-1}} \eta_y}_{\leq 1} \leq 2,$$

therefore, since  $\psi$  is a probability density, and setting  $\gamma = N$  proves the second identity of (5.34).

The second identity is obtained in the same way, since

$$\frac{1}{N} \mathbb{E}_{l, \widehat{K}} \left( \psi \sum_{x \in B_l'} (j_{x, x+e_i}^\omega + \mathfrak{d}_{\widehat{K}} j_{x, x+e_i}) \right) = \frac{1}{N} \sum_{|y| \leq l-1} \mathbb{E}_{l, \widehat{K}} \left( (\omega(\theta_y) + \mathfrak{d}_{\widehat{K}}) \nabla_{y, y+e_i} \psi \right),$$

we also obtain

$$\frac{1}{N} \mathbb{E}_{l, \widehat{K}} \left( \psi \sum_{x \in B_l'} (j_{x, x+e_i}^\omega + \mathfrak{d}_{\widehat{K}} j_{x, x+e_i}) \right) \leq \frac{\gamma}{2} D_{l, \widehat{K}}(\psi) + \frac{(\|\omega\|_\infty + \|\mathfrak{d}\|_\infty)^2}{2\gamma} \mathbb{E}_{l, \widehat{K}} \left( \sum_{x, x+e_i \in B_l} (2 - \eta_x - \eta_{x+e_i}) \psi \right).$$

The last estimate, in turn, yields the first inequality in (5.34), which concludes the proof of Lemma 5.6.  $\blacksquare$

In the limit  $N \rightarrow \infty$  then  $l \rightarrow \infty$ , Lemma 5.6 guarantees, since  $\kappa_1$  vanishes as  $l \rightarrow \infty$ , and since all quantities vanish when  $K = |B_l|$ , that

$$\kappa_1 \sum_{x \in \mathbb{T}_N^2} \sup_{\substack{\widehat{K} \in \mathbb{K}_l \\ K \geq |B_l| - 1}} \sup_{\psi} \left[ \frac{\kappa_2}{N} \mathbb{E}_{l, \widehat{K}} (\mathcal{W}_i^l \psi) - D_{l, \widehat{K}}(\psi) \right] \rightarrow 0.$$

We can therefore restrict the supremum over  $\widehat{K}$  to those satisfying  $K \leq |B_l| - 2$ . Recall that we denoted in equation (2.2) by  $\mathbb{K}_l$  the set of such  $\widehat{K}$ , the left-hand side of (5.29) is bounded by

$$\inf_f \lim_{p \rightarrow \infty} \limsup_{l \rightarrow \infty} \limsup_{N \rightarrow \infty} \kappa_1 \sum_{x \in \mathbb{T}_N^2} \sup_{\widehat{K} \in \mathbb{K}_l} \sup_{\psi} \left[ \frac{\kappa_2}{N} \mathbb{E}_{l, \widehat{K}} (\mathcal{W}_i^l \psi) - D_{l, \widehat{K}}(\psi) \right], \quad (5.36)$$

where the supremum is taken over all densities  $\psi$  w.r.t.  $\mu_{l, \widehat{K}}$ . On all the sets  $\Sigma_l^{\widehat{K}}$  considered,  $\mathcal{L}_l$  is invertible and the supremum over  $\psi$  is a variational formula for the largest eigenvalue of the operator  $\mathcal{L}_l + \kappa_2 \mathcal{W}_i^l / N$ . Proposition A.6 then allows us to bound the quantity whose limit is taken in (5.36) by

$$\sup_{\widehat{K} \in \mathbb{K}_l} \frac{\kappa_1 \kappa_2^2}{1 - 2\gamma_l \|\mathcal{W}_i^l\|_\infty \kappa_2 N^{-1}} \mathbb{E}_{l, \widehat{K}} (\mathcal{W}_i^l (-\mathcal{L}_l)^{-1} \mathcal{W}_i^l) \leq (2l+1)^2 \sup_{\widehat{K} \in \mathbb{K}_l} \mathbb{E}_{l, \widehat{K}} (\mathcal{W}_i^l (-\mathcal{L}_l)^{-1} \mathcal{W}_i^l),$$

where  $\widetilde{\kappa}_2 = \|G\|_\infty (2l+1)^2$ . To obtain the last inequality, we denoted by  $\gamma_l$  the spectral gap of the local generator  $\mathcal{L}_l$ , which is positive, and used that  $\|\mathcal{W}_i^l\|_\infty$  is finite, and  $\kappa_1 \kappa_2^2$  is of order  $(2l+1)^2$ . In order to obtain inequality (5.29), and conclude the proof of equation (5.7), it is therefore sufficient to prove the following result.

**Proposition 5.7.** *Recall that  $\mathcal{W}_i^l$  is the local average of the difference between currents and gradients up to  $\mathcal{L}f$ , namely*

$$\mathcal{W}_i^l = \langle J_i^\omega \rangle_0^l + d_s(\rho_l) \delta_i \rho_{i_p}^{\omega, p} + \mathfrak{d}(\rho_l, \rho_l^\omega) \delta_i \rho_l - \langle \mathcal{L}f \rangle_0^l,$$

where  $\mathfrak{d}$  is given by equation (1.12). Recall that  $\widehat{\mathbb{K}}_l$  only takes into account configurations with two empty sites in  $B_l$ . Then,

$$\inf_f \lim_{p \rightarrow \infty} \limsup_{l \rightarrow \infty} \sup_{\widehat{K} \in \widehat{\mathbb{K}}_l} (2l+1)^2 \mathbb{E}_{l, \widehat{K}} \left( \mathcal{W}_i^l(-\mathcal{L}l)^{-1} \mathcal{W}_i^l \right) = 0. \quad (5.37)$$

We now take a step back from that result in order to introduce the concept of discrete differential forms, which is essential to prove that the quantity above vanishes.

## 5.6 Discrete differential forms in the context of particles systems

We introduce in this Section the concept of discrete differential forms in the context of particle systems. The key point of the non-gradient method is that any translation-invariant closed form can be decomposed as the sum of a gradient of a translation-invariant function and the currents. This result is stated in Proposition 5.14, and directly rewrites as an approximation (in the sense of equation (5.37)) of any function in  $C_0$  by a linear combination of the currents up to an elements of  $\mathcal{L}C_0$ .

Let us denote by  $\Sigma_\infty$  the set of configurations on  $\mathbb{Z}^2$

$$\Sigma_\infty = \left\{ (\eta_x, \theta_x)_{x \in \mathbb{Z}^2} \in (\{0, 1\} \times \mathbb{S})^{\mathbb{Z}^2}, \quad \theta_x = 0 \text{ if } \eta_x = 0 \right\}.$$

We consider here the graph  $\mathcal{G} = (\Sigma_\infty, E)$  with edge set

$$E = \left\{ (\widehat{\eta}, \widehat{\eta}') \in \Sigma_\infty^2 \mid \widehat{\eta}' = \widehat{\eta}^{x, x+e_i} \text{ and } \eta_x(1 - \eta_{x+e_i}) + \eta_{x+e_i}(1 - \eta_x) = 1 \right\}. \quad (5.38)$$

In other words, two vertices  $\widehat{\eta}$  and  $\widehat{\eta}'$  are connected if and only if one can be reached from the other with exactly one allowed particle jump. We endow  $\mathcal{G}$  with the usual distance on graphs, i.e.  $d(\widehat{\eta}, \widehat{\eta}')$  is the minimal number of particle jumps necessary to go from one configuration to the other. Note that this graph is not connected, since for example a configuration  $\widehat{\eta}$  with no particles is not accessible from any configuration  $\widehat{\eta}'$  with any number of particles. This is also the case for two configurations with different angle distributions. In such a case where there is no path between  $\widehat{\eta}'$  and  $\widehat{\eta}$ , we will adopt the usual convention  $d(\widehat{\eta}, \widehat{\eta}') = \infty$ . By abuse of notation, we also denote by  $\mu_{\widehat{\alpha}}$  (cf. Definition 2.4) the grand canonical measure measure on  $\mathbb{Z}^2$  with parameter  $\widehat{\alpha}$ , and write  $\mathbb{E}_{\widehat{\alpha}}(\cdot)$  for the expectation w.r.t  $\mu_{\widehat{\alpha}}$ , which will not be a problem since we only consider cylinder functions.

In order to illustrate the notion of closed form of the graph  $\mathcal{G}$ , let us start first consider the following example. For any edge  $a = (a_1, a_2) \subset \mathbb{Z}^2$ , we defined the gradient of a cylinder function  $f \in C$  along the edge  $a$  as

$$\nabla_a f = \eta_{a_1}(1 - \eta_{a_2})(f(\widehat{\eta}^{a_1, a_2}) - f(\widehat{\eta})),$$

and shortened  $\nabla_i = \nabla_{0, e_i}$ .

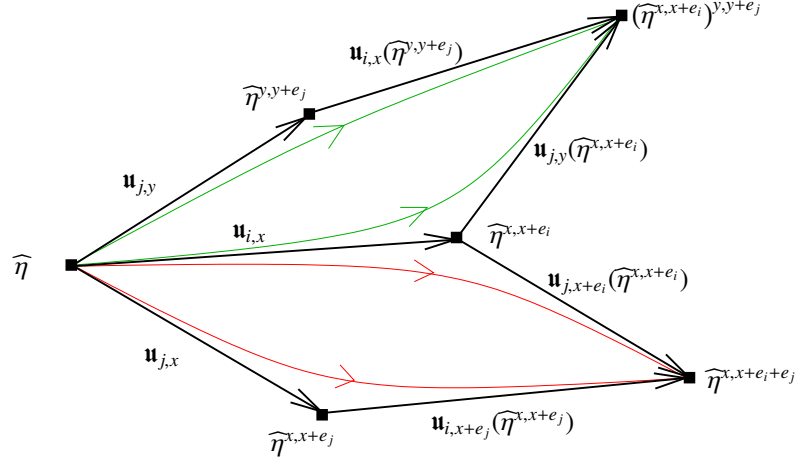

Figure 10: Representation of a differential form  $\mathbf{u}$  on the graph  $\mathcal{G}$  : if  $\mathbf{u}$  is closed, the weight of both green paths is identical, and the weight of both red path also is.

Let us now fix a cylinder function  $F \in C$ . For any  $x \in \mathbb{Z}^2$ ,  $i \in \{1, 2\}$ , we define

$$\mathbf{u}_{i,x}^F(\widehat{\eta}) = \nabla_{x,x+e_i} F(\widehat{\eta}) = \eta_x(1 - \eta_{x+e_i})(F(\widehat{\eta}^{x,x+e_i}) - F(\widehat{\eta})). \quad (5.39)$$

$\mathbf{u}_{i,x}^F$  can be interpreted as the "cost" for the function  $F$  to transfer a particle from  $x$  to  $x+e_i$ . For any configuration  $\widehat{\eta}$  with  $\eta_x = 1 - \eta_{x+e_i} = 1$ , to each edge  $(\widehat{\eta}, \widehat{\eta}^{x,x+e_i}) \in E$  (cf. equation (5.38)) in our graph  $\mathcal{G}$  we therefore associate the "cost"  $\mathbf{u}_{i,x}^F$ . The collection  $(\mathbf{u}_{i,x}^F)_{i,x}$  is a particular type of closed form, called an *exact form*, because it can be written as the gradient of a local function, in the sense of equation (5.39). However, we do not need a function  $F$  to define such a collection of variables, and the idea of closed forms is to generalize this notion of gradient on the graph  $\mathcal{G}$ .

We will now define the notions of exact and closed forms on the metric space  $(\mathcal{G}, d)$ , which will be necessary in order to prove Theorem 5.25.

**Definition 5.8** (Differential forms on  $(\mathcal{G}, d)$ ). A differential form on  $(\mathcal{G}, d)$  is a collection of functions  $(\mathbf{u}_{i,x})_{i \in \{1,2\}, x \in \mathbb{Z}^2}$ , with

$$\mathbf{u}_{i,x}(\widehat{\eta}) = \eta_x(1 - \eta_{x+e_i})v_{i,x}(\widehat{\eta}) \in L^2(\mu_{\widehat{\alpha}}),$$

and  $v_{i,x} : \Sigma_{\infty} \rightarrow \mathbb{R}$ .

As outlined before,  $\mathbf{u}_{i,x}(\widehat{\eta})$  can be interpreted as the "cost" of a particle's transfer from  $x$  to  $x+e_i$  in the configuration  $\widehat{\eta}$ . A differential form is closed if the "cost" of a path only depends on its endpoints. It is easy to see that a form is closed if and only if the previous property is true for any two-edge path. Since a two-edge path consists either in a particle moved twice or in two particles moved once each, we can give the following definition.

**Definition 5.9** (Closed forms on  $(\mathcal{G}, d)$ ). A differential form  $(\mathbf{u}_{i,x})_{i \in \{1,2\}, x \in \mathbb{Z}^2}$  is closed if both of the following equalities hold for any  $x, y \in \mathbb{Z}^2$ ,  $i, j \in \{1, 2\}$  :

$$\mathbf{u}_{i,x}(\widehat{\eta}) + \mathbf{u}_{j,x+e_i}(\widehat{\eta}^{x,x+e_i}) = \mathbf{u}_{j,x}(\widehat{\eta}) + \mathbf{u}_{i,x+e_j}(\widehat{\eta}^{x,x+e_j}) \quad (5.40)$$

$$\mathbf{u}_{i,x}(\widehat{\eta}) + \mathbf{u}_{j,y}(\widehat{\eta}^{x,x+e_i}) = \mathbf{u}_{j,y}(\widehat{\eta}) + \mathbf{u}_{i,x}(\widehat{\eta}^{y,y+e_j}) \quad (5.41)$$

for any  $\widehat{\eta}$  such that both paths are allowed, i.e whenever  $\eta_x = 1$ ,  $\eta_{x+e_i} = \eta_{x+e_j} = \eta_{x+e_i+e_j} = 0$  in the first case,  $\eta_x = \eta_y = 1$ ,  $\eta_{x+e_i} = \eta_{y+e_j} = 0$  in the second. The first identity states that transferring a particle from  $x$  to  $x + e_i$  then to  $x + e_i + e_j$  creates the same cost as transferring it first to  $x + e_j$  and then to  $x + e_j + e_i$ . The second states that transferring a particle in  $x$  to  $x + e_i$  then another from  $y$  to  $y + e_j$  is the same as transferring a particle from  $y$  to  $y + e_j$  then the other from  $x$  to  $x + e_i$ .

Given two configurations  $\widehat{\eta}, \widehat{\eta}'$  such that  $d(\widehat{\eta}, \widehat{\eta}') = 2$ , the two properties above ensure in particular that the cost of any finite path on  $\mathcal{G}$  from  $\widehat{\eta}$  to  $\widehat{\eta}'$  is the same.

In particular, we easily see that for a closed form, the "cost" for a particle to jump from  $x$  to  $x - e_i$  is  $-\mathbf{u}_{i,x-e_i}(\widehat{\eta}^{x,x-e_i})$ : making the particle in  $x$  jump in the direction  $e_i$ , then make it jump back in the direction  $-e_i$  should have no cost :

$$\mathbf{u}_{i,x-e_i}(\widehat{\eta}) - \mathbf{u}_{i,x-e_i}(\widehat{\eta}^{x,x-e_i}) = 0.$$

As outlined in the introductory example, for any cylinder function  $F$ , the differential form  $(\mathbf{u}_{i,x})$  defined for any  $i$  and  $x$  by  $\mathbf{u}_{i,x} = \mathbf{u}_{i,x}^F$  is a particular type of closed form.

**Definition 5.10** (Exact forms on  $(\mathcal{G}, d)$ ). A differential form  $(\mathbf{u}_{i,x})_{i \in \{1,2\}, x \in \mathbb{Z}^2}$  is exact if there exists a function  $F : \Sigma_\infty \rightarrow \mathbb{R}$  such that for any  $x \in \mathbb{Z}^2$ ,  $i \in \{1, 2\}$

$$\mathbf{u}_{i,x}(\widehat{\eta}) = \nabla_i F(x) = \eta_x(1 - \eta_{x+e_i})(F(\widehat{\eta}^{x,x+e_i}) - F(\widehat{\eta})).$$

We now investigate further the case of translation invariant closed forms.

**Definition 5.11** (Germs of a closed form). A pair  $\mathbf{u} = (\mathbf{u}_1, \mathbf{u}_2)$  of functions on  $\Sigma_\infty$  is a germ of a closed form if  $(\tau_x \mathbf{u}_i)_{i \in \{1,2\}, x \in \mathbb{Z}^2}$  is a closed form. We endow the set of germs of closed forms with its  $L^2(\mu_{\widehat{\alpha}})$  norm

$$\|\mathbf{u}\|_{\widehat{\alpha},2} = \left[ \mathbb{E}_{\widehat{\alpha}}(\mathbf{u}_1^2 + \mathbf{u}_2^2) \right]^{1/2} \quad (5.42)$$

We denote by  $\mathfrak{C}$  the vector space of germs of closed forms, and by  $\mathfrak{C}_{\widehat{\alpha}}$  its weak closure in  $L^2(\mu_{\widehat{\alpha}})$ . Note that in the Banach  $L^2(\mu_{\widehat{\alpha}})$ , and since  $\mathfrak{C}$  is a vector space, the weak and strong closure coincide, and therefore  $\mathfrak{C}_{\widehat{\alpha}}$  is also the strong closure of  $\mathfrak{C}$  in  $L^2(\mu_{\widehat{\alpha}})$ .

**Definition 5.12** (Germs of an exact form). A pair  $\mathbf{u} = (\mathbf{u}_1, \mathbf{u}_2)$  will be called germ of an exact form if we can write

$$(\mathbf{u}_1, \mathbf{u}_2) = \nabla \Sigma_h = (\nabla_1 \Sigma_h, \nabla_2 \Sigma_h)$$

for some cylinder function  $h$ , where  $\Sigma_h$  is defined as the formal sum  $\Sigma_h = \sum_{x \in \mathbb{Z}^2} \tau_x h$ . We denote by  $\mathfrak{E}$  the vector space of germs of exact forms, and by  $\mathfrak{E}_{\widehat{\alpha}}$  its weak (and also strong, cf. Definition 5.11) closure in  $L^2(\mu_{\widehat{\alpha}})$ .

**Remark 5.13.** Since the function  $\Sigma_h$  is ill-defined as a series, one could argue that the definition of a germ of an exact form is also ill-defined. However, for any given direction  $i$  and since the functions  $h$  have finite support,  $\nabla_i \Sigma_h$  is well-defined as a finite sum. Also note that the collection of translations of a germ of an exact form does not necessarily yield an exact form. We will see later on, though, that it produces at least a closed form.

In order to investigate the structure of the set of germs of closed forms, let us expand briefly on some of its noteworthy subsets. The first such subset is the set of germs of exact forms. Indeed, it

is easily verified that if the germ is the gradient of some "translation-invariant" function, the cost for a path only depends on its endpoints, and therefore

$$\mathfrak{E}_{\widehat{\alpha}} \subset \mathfrak{C}_{\widehat{\alpha}}.$$

Before introducing the second particular subset, let us first describe the closed forms representing the particle currents. Let us consider the closed form defined by

$$\mathbf{j}_{i,x}^1 = \mathbb{1}_{i=1}\eta_x(1 - \eta_{x+e_1}).$$

This differential form is trivially closed, since the cost of any path is the algebraic number of particle jumps to the left along the trajectory defined by this path, which does not depend on the trajectory but only on the first and last configurations. This differential form is translation invariant with germ

$$\mathbf{j}^1 = (\mathbf{j}_1^1, \mathbf{j}_2^1) = (\eta_0(1 - \eta_{e_1}), 0), \quad (5.43)$$

and it can be interpreted as the gradient of the formal function  $F_1(\eta) = \sum_{x \in \mathbb{Z}^2} x_1 \eta_x$ , which gains 1 when a particle jumps to the right, and decreases by the same amount when a particle jumps to the left. However, since  $F_1$  is not a well-defined function, the closed form associated with  $\mathbf{j}^1$  is not an exact form. We can define in a similar fashion the germ of the closed form representing the particle current in the second direction, namely

$$\mathbf{j}^2 = (0, \eta_0(1 - \eta_{e_2})), \quad (5.44)$$

whose associated closed form is the gradient of the formal sum  $F_2(\eta) = \sum_{x \in \mathbb{Z}^2} x_2 \eta_x$ , which gains 1 when a particle jumps up, and loses 1 when a particle jumps down. Regarding the angle-blind exclusion process, these two forms would be sufficient to account for the particle currents on  $\mathbb{Z}^2$ . In our case however, consider for example the germs

$$\mathbf{j}^{1,\theta} = (\eta_0^\theta(1 - \eta_{e_1}), 0), \quad \mathbf{j}^{2,\theta} = (0, \eta_0^\theta(1 - \eta_{e_2})),$$

where we defined  $\eta_x^\theta = \mathbb{1}_{\theta_x = \theta} \eta_x$ . These germs represent the current of particles with spin  $\theta$ , and cannot be expressed by a combination of  $\mathbf{j}^1$  and  $\mathbf{j}^2$ . It is not hard to see that these are also germs of closed forms, since the corresponding differential forms count the algebraic number of left-wise particle jumps with angle  $\theta$ , in the corresponding direction.

Any germ of a closed form in the context of particle systems can usually be expressed as the sum of a germ of an exact form and of the macroscopic currents. In our case, this would mean that any  $\theta$ -dependent germ of a closed form can be expressed as a combination of all the  $\mathbf{j}^{1,\theta}$  and  $\mathbf{j}^{2,\theta}$ , up to the germ of an exact form  $\nabla \Sigma_f$ .

Recall that  $\mathfrak{C}_{\widehat{\alpha}}$  and  $\mathfrak{E}_{\widehat{\alpha}}$  are introduced in Definitions 5.11 and 5.12. The main result of this Section is that any closed form in  $\mathfrak{C}_{\widehat{\alpha}}$  is a combination of the forms  $\mathbf{j}^i$  and  $\mathbf{j}^{i,\theta}$ , with a perturbation in  $\mathfrak{E}_{\widehat{\alpha}}$ . However, the proof of this decomposition requires a sharp estimate of the spectral gap of the generator of the symmetric exclusion process, which we do not have in our case because of the angles, as outlined in Section 4.2. Furthermore, we do not need to understand each current of particles with angle  $\theta$ , but rather an observable current weighted by  $\omega$ . For this reason, one can restrict to the class of semi angle-blind functions, with no correlations between angles. More precisely, recall that we already introduced in (4.4)  $T_0^\omega$  the subspace of  $L^2(\mu_{\widehat{\alpha}}^*)$

$$T_0^\omega = \left\{ f \in L^2(\mu_{\widehat{\alpha}}^*), \quad f(\eta) = \varphi(\eta) + \sum_{x \in \mathbb{Z}^2} (c_1 \eta_x^\omega + c_2 \eta_x) \psi_x(\eta), \quad c_1, c_2 \in \mathbb{R}, \quad \text{and } \psi_x \in \mathcal{S} \forall x \in \mathbb{Z}^2, \varphi \in \mathcal{S} \right\}.$$

For  $i = 1, 2$ , let  $E_i$  be the space

$$E_i = \left\{ f, \quad \mathbb{E}_{\widehat{\alpha}} \left( \mathbb{1}_{\{\eta_0 \eta_{e_i} = 0\}} f^2 \right) < \infty \right\} \subset L^2(\mu_{\widehat{\alpha}})$$

and  $T_i^\omega$  the closure in  $E_i$  of  $T_0^\omega$  (Once again, strong closure and weak closure coincide, and we therefore do not need to specify which one we consider). Let  $T_i^{\omega\perp}$  be its orthogonal in  $E_i$ , and let us denote by  $\mathfrak{I}^\omega$  the set of pairs of random variables with each coordinate in  $T_i^\omega$

$$\mathfrak{I}^\omega = \left\{ \mathbf{t} \in \left( L^2(\mu_{\widehat{\alpha}}) \right)^2, \quad \mathbf{t}_i \in T_i^\omega \quad \forall i \in \{1, 2\} \right\}. \quad (5.45)$$

The embedding in  $E_i$  is performed for purely technical reasons. Essentially, it allows  $T_i^\omega$  as well as  $T_i^{\omega\perp}$  to be stable under the action of the symmetric generator  $\mathcal{L}$ , but since this is not a crucial point of the proof, we do not give more detail here.

Finally, we define the germs of closed forms

$$\mathbf{j}^{1,\omega} = \left( \eta_0^\omega (1 - \eta_{e_1}), 0 \right), \quad \mathbf{j}^{2,\omega} = \left( 0, \eta_0^\omega (1 - \eta_{e_2}) \right), \quad (5.46)$$

and let  $\mathfrak{J}^\omega$  be the linear span of the four germs of closed forms described through equations (5.43), (5.44) and (5.46)

$$\mathfrak{J}^\omega = \left\{ a_1 \mathbf{j}^1 + a_2 \mathbf{j}^2 + b_1 \mathbf{j}^{1,\omega} + b_2 \mathbf{j}^{2,\omega}, \quad (a_1, a_2, b_1, b_2) \in \mathbb{R}^4 \right\}$$

**Proposition 5.14.** *For any angle measure  $\widehat{\alpha} \in \mathcal{M}_1(\mathbb{S})$ , with the notations above we have the decomposition*

$$\mathfrak{C}_{\widehat{\alpha}} \cap \mathfrak{I}^\omega = (\mathfrak{E}_{\widehat{\alpha}} \cap \mathfrak{I}^\omega) + \mathfrak{J}^\omega.$$

**Remark 5.15.** *Notice that the  $\mathbf{j}^i$  and  $\mathbf{j}^{i,\omega}$  are in  $\mathfrak{I}^\omega$ , therefore we do not need to restrict  $\mathbf{j}^\omega$  to  $\mathfrak{I}^\omega$ . Finally, we can safely assume that the total density  $\alpha$  is in  $]0, 1[$ . If not, the graph  $\mathcal{G}$  is trivial since its edge set is empty. This assumption will be made throughout the rest of this Section.*

Before turning to the proof of the last proposition, we investigate the case of a finite domain configuration. Considering the graph  $\mathcal{G}_n$  with vertices the *non-periodic configurations*  $\widehat{\eta}$  on the box  $B_n = \{-n, \dots, n\}^2$ , and connected in the same way as on the infinite graph if one can be reached from the other with one allowed jump. We define the sets  $\mathfrak{C}_{\widehat{\alpha},n}$  and  $\mathfrak{E}_{\widehat{\alpha},n}$  the closure of the sets of closed and exact forms on the graph  $\mathcal{G}_n$  in  $L^2(\mu_{\widehat{\alpha}})$ . On this graph, we have the following result.

**Proposition 5.16.** *For any density parameter  $\widehat{\alpha}$ , with the notations above we have the decomposition,*

$$\mathfrak{C}_{\widehat{\alpha},n} = \mathfrak{E}_{\widehat{\alpha},n}.$$

*i.e. on a finite set, all closed forms are exact forms.*

*Proof of Proposition 5.16 :* It is important to consider only a non-periodic domain, because in the periodic case, the differential form associated to any of the germs in  $\mathbf{j}^\omega$  are not closed. In particular, in a non-periodic domain, it is not true that a differential form is closed if and only if the cost of any path of length 2 only depends on its end points.

We simply sketch the proof, and refer the reader to appendix 3 of [KL99] for the detailed proof. The basic idea is quite simple. For any given closed form  $\mathbf{u} = (\mathbf{u}_{i,x})_{i,x}$  and any given particle number  $\widehat{K}$  such that  $K < (2l + 1)^2$ , choose a reference configuration  $\widehat{\eta}_{\widehat{K}}$  with  $\widehat{K}$  particles in  $B_n$ , for which

we set  $F(\widehat{\eta}_{\widehat{K}}) = 0$ . Then, for any configuration  $\widehat{\eta}'$  with  $\widehat{K}$  particles in  $B_n$  which is reachable from  $\widehat{\eta}$  (in particular, any configuration is if  $K < (2n+1)^2 - 1$ , cf. Section 2.3), choose a path of neighbor configurations in  $\mathcal{G}_n$ ,  $\gamma = (\widehat{\eta}_i)_{i=1,\dots,l}$  between  $\widehat{\eta}_1 = \widehat{\eta}_{\widehat{K}}$  and  $\widehat{\eta}_l = \widehat{\eta}'$ . We then let

$$F(\widehat{\eta}') = \sum_{i=1}^{l-1} u(\widehat{\eta}_i, \widehat{\eta}_{i+1}),$$

where  $u(\widehat{\eta}_i, \widehat{\eta}_{i+1})$  is the cost, according to the differential form  $(\mathbf{u}_{i,x})_{i,x}$  of the jump from  $\widehat{\eta}_i$  to  $\widehat{\eta}_{i+1}$ . It is then easy to see that this defines a function  $F$ , whose gradient is the closed form  $\mathbf{u}$ . ■

We now turn to the proof of the decomposition of germs of closed forms on the infinite configurations.

*Proof of Proposition 5.14 :* We have seen previously that the elementary currents  $\mathbf{j}^i$ ,  $\mathbf{j}^{i,\omega}$  are all germs of closed forms, hence their linear span is included in  $\mathfrak{C}_{\widehat{\alpha}}$ . Let  $\mathbf{u} = \nabla \Sigma_h$  be the germ of an exact form, with  $h$  some cylinder function in  $L^2(\mu_{\widehat{\alpha}})$ , let us show that  $\mathbf{u}$  is the germ of a closed form. The differential form associated to  $\mathbf{u}$  is

$$\mathbf{u}_{i,x}(\widehat{\eta}) = \eta_x(1 - \eta_{x+e_i}) [\Sigma_h(\widehat{\eta}^{x,x+e_i}) - \Sigma_h(\widehat{\eta})],$$

which is the form associated to the formal function  $\Sigma_h$ . Since it is not a proper function,  $u$  is not exact, however when the particle jumps are allowed, the variation of  $u$  only depends on the trajectory through its endpoints, since this differential form restricted to any finite subset of  $\mathbb{Z}^2$  is the gradient of a function. The form  $(\tau_x \mathbf{u}_i)_{i \in \{1,2\}, x \in \mathbb{Z}^2}$  is therefore closed, and by definition  $u$  is a germ of a closed form.

We have now proven that

$$\mathfrak{C}_{\widehat{\alpha}} \supset \mathfrak{E}_{\widehat{\alpha}} + \{\mathbf{j}^i, \mathbf{j}^{i,\omega}, \quad i \in \{1,2\}\}.$$

We now come to the main part of this result, namely the reverse inclusion. The strategy of the proof is rather straightforward, let us give a brief outline right now. Given a germ of closed form  $\mathbf{u} = (\mathbf{u}_1, \mathbf{u}_2)$ , the main idea of the proof is to project the associated closed form  $(\tau_x \mathbf{u}_i)_{i,x}$  on large finite cubes, on which it is exact according to Proposition 5.16. This will allow us to write  $\mathbf{u}_i$  as the gradient of a local average, up to a boundary term. The gradient will converge towards the germ of an exact form after local averaging, whereas the boundary term is ultimately in  $\mathbf{j}^\omega$ .

Let  $\mathbf{u}$  be the germ of a closed form in the subspace  $\mathfrak{I}^\omega$  defined in (5.45), and  $(\mathbf{u}_{i,x})_{i,x} = (\tau_x \mathbf{u}_i)_{i,x}$  the associated closed form. For any fixed integer  $n$ , let  $\mathcal{F}_n$  be the  $\sigma$ -algebra generated by the spins inside  $B_n$

$$\mathcal{F}_n = \sigma(\widehat{\eta}_x, x \in \llbracket -n, n \rrbracket^2).$$

Furthermore, let  $\mathbf{u}_{i,x}^n$  be the conditional expectation

$$\mathbf{u}_{i,x}^n = \mathbb{E}_{\widehat{\alpha}}(\mathbf{u}_{i,x} \mid \mathcal{F}_n).$$

Note in particular that  $\mathbf{u}_{i,x}^n$  is also in  $\mathfrak{I}^\omega$ .

Recall that the gradient of a local function  $\varphi$  when a particle jumps from  $x$  to  $x + e_i$  is defined as

$$\nabla_{x,x+e_i} \varphi(\widehat{\eta}) = \eta_x(1 - \eta_{x+e_i}) (\varphi(\widehat{\eta}^{x,x+e_i}) - \varphi(\widehat{\eta}))$$



Since according to Proposition 5.16, any closed form on a finite box is exact, there exists a family of  $\mathcal{F}_n$ -measurable function  $\varphi_n \in L^2(\mu_{\widehat{\alpha}})$  such that

$$\mathbf{u}_{i,x}^n = \nabla_{x,x+e_i}\varphi_n = \tau_x \nabla_{0,e_i} \tau_{-x} \varphi_n. \quad (5.47)$$

Furthermore, since the gradient of any constant vanishes, we can safely assume that for any  $n$ ,  $\mathbb{E}_{\widehat{\alpha}}(\varphi_n) = 0$ . Let us fix  $n \in \mathbb{N}$ , and consider the germ of an exact form  $\frac{1}{(2n)^2} \nabla_{0,e_i} \Sigma \varphi_n$

$$\frac{1}{(2n)^2} \nabla_{0,e_i} \Sigma \varphi_n = \frac{1}{(2n)^2} \nabla_{0,e_i} \sum_{x \in \mathbb{Z}^2} \tau_x \varphi_n = \frac{1}{(2n)^2} \sum_{x \in \mathbb{Z}^2} \tau_{-x} \nabla_{x,x+e_i} \varphi_n.$$

Since  $\varphi_n$  is  $\mathcal{F}_n$ -measurable,  $\nabla_{x,x+e_i} \varphi_n$  vanishes as soon as both  $x$  and  $x + e_i$  are not in  $B_n$ . Hence, the previous quantity is equal to

$$\frac{1}{(2n)^2} \nabla_{0,e_i} \Sigma \varphi_n = \frac{1}{(2n)^2} \sum_{\substack{-n-1 \leq x_i \leq n \\ |x_j| \leq n, j \neq i}} \tau_{-x} \nabla_{x,x+e_i} \varphi_n = R_{n,i} + \frac{1}{(2n)^2} \sum_{\substack{-n \leq x_i \leq n-1 \\ x \in B_n}} \tau_{-x} \nabla_{x,x+e_i} \varphi_n, \quad (5.48)$$

where the boundary term  $R_{n,i}$  is

$$R_{n,i} = \frac{1}{(2n)^2} \left[ \sum_{\substack{x_i = -n-1 \\ |x_j| \leq n, j \neq i}} \tau_{-x} \nabla_{x,x+e_i} \varphi_n + \sum_{\substack{x_i = n \\ x \in B_n}} \tau_{-x} \nabla_{x,x+e_i} \varphi_n \right].$$

Since  $\varphi_n$  is supported in  $B_n$ , the exchanges at the boundary act as reservoirs with creation (first term in  $R_{n,i}$ ) at the sites  $x$  with  $x_i = -n$ , and annihilation of particles (second term in  $R_{n,i}$ ) at the sites  $x$  such that  $x_i = n$ .

Let us focus on the resulting equation and its behavior as  $n$  goes to infinity :

$$\frac{1}{(2n)^2} \nabla_{0,e_i} \Sigma \varphi_n = R_{n,i} + \frac{1}{(2n)^2} \sum_{\substack{-n \leq x_i \leq n-1 \\ x \in B_n}} \tau_{-x} \nabla_{x,x+e_i} \varphi_n.$$

For any  $n$ , the left-hand side is the germ of an exact form as introduced in Definition 5.12, and the limit is therefore in  $\mathfrak{E}_{\widehat{\alpha}}$ . We will see that the second term of the right-hand side converges in  $L^2(\mu_{\widehat{\alpha}})$  as  $n$  goes to infinity towards  $\mathbf{u}_i$ . Hence to prove Proposition 5.14 it will be sufficient to show that the boundary term  $R_{n,i}$  remains in a compact set, and that any of its limit points is in the linear span of the elementary currents. In order to do that, we must first obtain some control over the boundary term, i.e. to estimate it by the Dirichlet form of the  $\varphi_n$ 's. The difficulty here is that the Dirichlet form records only the displacements of particles, whereas the boundary term involves creation and annihilation of particles.

Let us briefly illustrate that statement : consider one element in the boundary term  $R_{n,i}$ , say  $x \in B_n$  such that  $x_i = n$ , and consider the gradient  $\nabla_{x,x+e_i} \varphi_n$ . For any configuration  $\widehat{\eta}$  with a particle in  $x$ , let us denote  $\widehat{\eta} - \delta^x$  the configuration equal to  $\widehat{\eta}$  everywhere except in  $x$  where the site is now empty. Since  $\varphi_n$  is  $\mathcal{F}_n$ -measurable, the previous gradient is equal to

$$\nabla_{x,x+e_i} \varphi_n(\widehat{\eta}) = \eta_x (1 - \eta_{x+e_i}) (\varphi_n(\widehat{\eta} - \delta_x) - \varphi_n(\widehat{\eta})). \quad (5.49)$$



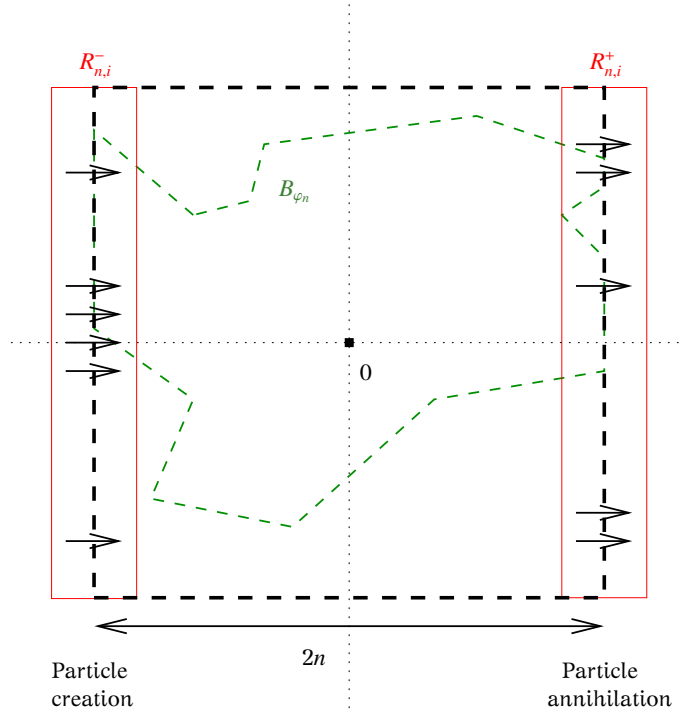

Figure 11: Description of the boundary terms  $\widetilde{R}_{n,i}$  in equation (5.51).

Creation and annihilation of particles cannot be directly estimated by the Dirichlet form. In order to circumvent this problem, we need to smooth out  $\varphi_n$  on a larger domain and consider

$$\widetilde{\varphi}_n = \mathbb{E}_{\widetilde{\alpha}}(\varphi_{3n} | \mathcal{F}_n).$$

Rewrite (5.48) with  $\widetilde{\varphi}_n$  instead of  $\varphi_n$

$$\frac{1}{(2n)^2} \nabla_{0,e_i} \Sigma \widetilde{\varphi}_n = \frac{1}{(2n)^2} \sum_{\substack{-n \leq x_j \leq n-1 \\ x \in B_n}} \tau_{-x} \nabla_{x,x+e_i} \widetilde{\varphi}_n + \widetilde{R}_{n,i}, \quad (5.50)$$

where this time

$$\widetilde{R}_{n,i} = \frac{1}{(2n)^2} \left[ \sum_{\substack{x_i = -n-1 \\ |x_j| \leq n, j \neq i}} \tau_{-x} \nabla_{x,x+e_i} \widetilde{\varphi}_n + \sum_{\substack{x_i = n \\ x \in B_n}} \tau_{-x} \nabla_{x,x+e_i} \widetilde{\varphi}_n \right]. \quad (5.51)$$

We are going to show that

- the bulk term converges as  $n$  goes to infinity to  $\mathbf{u}_i$ .
- the limiting boundary terms are all in the linear span of the currents.

For the sake of clarity, we state both of these results as separate lemmas, and we will prove them afterwards.

**Lemma 5.17** (Convergence of the bulk term towards  $\mathbf{u}_i$ ). *For any  $i \in \{1, 2\}$ , the convergence*

$$\frac{1}{(2n)^2} \sum_{\substack{-n \leq x_i \leq n-1 \\ x \in B_n}} \tau_{-x} \nabla_{x, x+e_i} \tilde{\varphi}_n \xrightarrow{n \rightarrow \infty} \mathbf{u}_i$$

holds in  $L^2(\mu_{\tilde{\alpha}})$ .

Let us state the second part of the convergence before giving the proofs.

**Lemma 5.18** (Limit of the boundary term). *For any  $i \in \{1, 2\}$ , we split the boundary term according to Figure 11 as*

$$\tilde{R}_{n,i} = \tilde{R}_{n,i}^- + \tilde{R}_{n,i}^+,$$

where

$$\tilde{R}_{n,i}^- = \frac{1}{(2n)^2} \sum_{\substack{x_i = -n-1 \\ |x_j| \leq n, j \neq i}} \tau_{-x} \nabla_{x, x+e_i} \tilde{\varphi}_n, \quad \text{and} \quad \tilde{R}_{n,i}^+ = \frac{1}{(2n)^2} \sum_{\substack{x_i = n \\ x \in B_n}} \tau_{-x} \nabla_{x, x+e_i} \tilde{\varphi}_n, \quad (5.52)$$

which will be referred to respectively as *negative and positive boundary terms*. With the previous notations, both sequences  $(\tilde{R}_{n,i}^-)_{n \in \mathbb{N}}$  and  $(\tilde{R}_{n,i}^+)_{n \in \mathbb{N}}$  are bounded in  $L^2(\mu_{\tilde{\alpha}})$ . Furthermore, for any weakly convergent subsequence  $\tilde{R}_{k_n,i}^- \rightarrow \mathfrak{R}_i^-$ , there exists  $a_i, b_i \in \mathbb{R}$  such that

$$\mathfrak{R}_i^- = a_i \eta_0^\omega (1 - \eta_{e_i}) + b_i \eta_0 (1 - \eta_{e_i}).$$

The same is true for the positive boundary term.

Before giving the proof of the two Lemmas 5.17 and 5.18, we conclude the proof of Proposition 5.14. Recall from equation (5.50) that

$$\frac{1}{(2n)^2} \sum_{\substack{-n \leq x_i \leq n-1 \\ x \in B_n}} \tau_{-x} \nabla_{x, x+e_i} \tilde{\varphi}_n = \frac{1}{(2n)^2} \nabla_{0, e_i} \Sigma_{\tilde{\varphi}_n} - \tilde{R}_{n,i},$$

Lemma 5.17 guarantees that the left-hand side converges in  $L^2(\mu_{\tilde{\alpha}})$  towards  $\mathbf{u}_i$ , whereas the first term in the right-hand side is the limit of a sequence of germs of exact forms. Finally, Lemma 5.18 guarantees that

$$\lim_{n \rightarrow \infty} (\tilde{R}_{n,1}, \tilde{R}_{n,2}) = \sum_{i=1}^2 a_i \mathfrak{I}^i + b_i \mathfrak{I}^{i,\omega},$$

where  $\mathfrak{I}^i$  and  $\mathfrak{I}^{i,\omega}$  were defined in (5.43), (5.44) and (5.46). This yields, as wanted, that

$$\mathfrak{C}_{\tilde{\alpha}} \cap \mathfrak{I}^\omega \subset (\mathfrak{E}_{\tilde{\alpha}} \cap \mathfrak{I}^\omega) + \mathfrak{J}^\omega,$$

which proves Proposition 5.14. ■

The proof of Lemma 5.17 is simple, we treat it right now before turning to the proof of Lemma 5.18, which is a little more elaborate.

*Proof of Lemma 5.17*: We want to prove that the convergence

$$\lim_{n \rightarrow \infty} \frac{1}{(2n)^2} \sum_{\substack{-n \leq x_i \leq n-1 \\ x \in B_n}} \tau_{-x} \nabla_{x, x+e_i} \tilde{\varphi}_n = \mathbf{u}_i,$$

holds in  $L^2(\mu_{\widehat{\alpha}})$ . By construction, for any  $x, x + e_i \in B_n$ ,

$$\nabla_{x, x+e_i} \widetilde{\varphi}_n = \nabla_{x, x+e_i} \mathbb{E}_{\widehat{\alpha}}(\varphi_{3n} | \mathcal{F}_n) = \mathbb{E}_{\widehat{\alpha}}(\nabla_{x, x+e_i} \varphi_{3n} | \mathcal{F}_n),$$

since both  $x$  and  $x + e_i$  are in  $B_n$ . Since by definition of  $\varphi_n$ ,  $\mathbf{u}_{i,x}^n = \nabla_{x, x+e_i} \varphi_n$  we deduce that

$$\nabla_{x, x+e_i} \widetilde{\varphi}_n = \mathbb{E}_{\widehat{\alpha}}(\mathbf{u}_{i,x}^{3n} | \mathcal{F}_n) = \mathbb{E}_{\widehat{\alpha}}(\mathbf{u}_{i,x} | \mathcal{F}_n).$$

The random variable  $\mathbf{u}_{i,0}^n = \mathbb{E}_{\widehat{\alpha}}(\mathbf{u}_{i,0} | \mathcal{F}_n)$  converges in  $L^2(\mu_{\widehat{\alpha}})$  to  $\mathbf{u}_{i,0} = \mathbf{u}_i$ . Therefore, consider  $\varepsilon > 0$ , there exists some integer  $n_0$  such that

$$\mathbb{E}_{\widehat{\alpha}}\left(\left|\mathbf{u}_{i,0}^{n_0} - \mathbf{u}_i\right|^2\right) \leq \varepsilon,$$

and it is easy to see that for any  $n \geq n_0$  and  $x \in B_{n-n_0}$ , we also have

$$\mathbb{E}_{\widehat{\alpha}}\left(\left|\tau_{-x} \mathbf{u}_{i,x}^n - \mathbf{u}_i\right|^2\right) \leq \varepsilon$$

since  $\mathbb{E}_{\widehat{\alpha}}$  is translation invariant. Now we have some control over the convergence of  $\mathbf{u}_{i,x}^n$  for any  $x \in B_{n-n_0}$ , we can prove Lemma 5.17. For any  $n \geq n_0$ ,

$$\begin{aligned} \mathbb{E}_{\widehat{\alpha}}\left(\left(\frac{1}{(2n)^2} \sum_{\substack{-n \leq x_i \leq n-1 \\ x \in B_n}} \tau_{-x} \mathbf{u}_{i,x}^n - \mathbf{u}_i\right)^2\right) &\leq \frac{1}{(2n)^2} \sum_{\substack{-n \leq x_i \leq n-1 \\ x \in B_n}} \mathbb{E}_{\widehat{\alpha}}\left(\left(\tau_{-x} \mathbf{u}_{i,x}^n - \mathbf{u}_i\right)^2\right) \\ &= \frac{1}{(2n)^2} \sum_{x \in B_{n-n_0}} \mathbb{E}_{\widehat{\alpha}}\left(\left(\tau_{-x} \mathbf{u}_{i,x}^n - \mathbf{u}_i\right)^2\right) + \frac{1}{(2n)^2} \sum_{\substack{-n \leq x_i \leq n-1 \\ x \in B_n - B_{n-n_0}}} \mathbb{E}_{\widehat{\alpha}}\left(\left(\tau_{-x} \mathbf{u}_{i,x}^n - \mathbf{u}_i\right)^2\right) \\ &\leq \frac{(2(n-n_0)+1)^2}{(2n)^2} \varepsilon + \frac{4nn_0}{(2n)^2} C_i \\ &\leq \varepsilon + o_n(1), \end{aligned}$$

where  $C_i$  is a crude bound on

$$\mathbb{E}_{\widehat{\alpha}}\left(\left(\tau_{-x} \mathbf{u}_{i,x}^n - \mathbf{u}_i\right)^2\right) \leq 2\mathbb{E}_{\widehat{\alpha}}\left(\left(\mathbf{u}_{i,0}^n\right)^2\right) + 2\mathbb{E}_{\widehat{\alpha}}\left(\mathbf{u}_i^2\right) \leq 4\mathbb{E}_{\widehat{\alpha}}\left(\mathbf{u}_i^2\right) := C_i,$$

thanks to the conditional Jensen inequality. Finally, for any  $\varepsilon > 0$ , we can write

$$\lim_{n \rightarrow \infty} \mathbb{E}_{\widehat{\alpha}}\left(\left(\frac{1}{(2n)^2} \sum_{\substack{-n \leq x_i \leq n-1 \\ x \in B_n}} \tau_{-x} \mathbf{u}_{i,x}^n - \mathbf{u}_i\right)^2\right) \leq \varepsilon,$$

and we have shown Lemma 5.17. ■

We now prove the second Lemma, i.e. that the limiting boundary term is in the linear span of the currents, which is the main difficulty of this Section.

*Proof of Lemma 5.18:* The proof of this Lemma being long, we split it into three steps.

- We first control the  $L^2(\mu_{\widehat{\alpha}})$  norm of the  $\widetilde{\varphi}_n$ 's.

- Thanks to this control, we prove that the boundary terms  $\widetilde{R}_{n,i}^\pm$  are bounded in  $L^2(\mu_{\widehat{\alpha}})$ , and therefore weakly compact.
- Finally, we prove that the limiting boundary terms  $\mathfrak{R}_i^\pm$  can only depend on the configuration through  $\widehat{\eta}_0$  and  $\widehat{\eta}_{e_i}$ , and that they can be written as a combination of the  $\mathbf{j}^i$  and  $\mathbf{j}^{i,\omega}$ .

The scheme follows closely that of Theorem 4.14 in Appendix 3 of [KL99] however adjustments are needed in the second and third step to take into account the presence of the angles.

First step : Control on the  $L^2$  norm of the  $\varphi_n$ 's.

We proved in Section 4.2 that, even though we do not have a sufficiently sharp spectral gap on the set  $C_0$  defined in (4.1), we could circumvent this difficulty by restricting ourselves to a convenient class of functions not too dependent on the spins. This spectral gap estimate is needed to control the norm of the  $\varphi_n$ 's. This is one of the reasons for limiting the result to closed forms in  $\mathfrak{T}^\omega$  defined in (5.45). We state this step as a separate lemma for the sake of clarity.

**Lemma 5.19.** *There exists a constant  $K$  depending only on  $\widehat{\alpha}$ , such that  $\varphi_n$ , introduced in (5.47) verifies for any  $n \in \mathbb{N}$ ,*

$$\mathbb{E}_{\widehat{\alpha}}(\varphi_n^2) \leq Kn^4 \|\mathbf{u}\|_{2,\widehat{\alpha}}^2.$$

*Proof of Lemma 5.19 :* For  $f$  a function in  $T_i^\omega$ , one can check that the symmetric gradient

$$\widetilde{\nabla}_i f := \mathbb{1}_{\{\eta_0 \eta_{e_i} = 0\}}(f(\widehat{\eta}^{0,e_i}) - f)$$

is also in  $T_i^\omega$ . Furthermore, a simple change of variables shows that for any functions  $f, g \in E_i$ , this modified gradient is symmetric indeed, i.e.

$$\mathbb{E}_{\widehat{\alpha}}(f \widetilde{\nabla}_i g) = \mathbb{E}_{\widehat{\alpha}}(g \widetilde{\nabla}_i f).$$

This implies that  $T_i^{\omega,\perp}$  is invariant by the action of  $\widetilde{\nabla}_i$ , therefore for any function such that  $\widetilde{\nabla}_i \varphi \in T_i^\omega$ , we also have  $\varphi \in T_i^\omega$ . With that in mind, note that for any function  $\varphi$ , we have the identity

$$\widetilde{\nabla}_i \varphi(\widehat{\eta}) = \nabla_i \varphi(\widehat{\eta}) - \nabla_i \varphi(\widehat{\eta}^{0,e_i}).$$

In our case,  $\tau_{-x} \mathbf{u}_{i,x}^n = \nabla_{0,e_i} \tau_{-x} \varphi_n$  hence

$$\widetilde{\nabla}_i \tau_{-x} \varphi_n = \tau_{-x} \mathbf{u}_{i,x}^n(\widehat{\eta}) - \tau_{-x} \mathbf{u}_{i,x}^n(\widehat{\eta}^{0,e_i}).$$

Now since the right-hand side of the identity above is in  $T_i^\omega$ , we obtain that  $\widetilde{\nabla}_i \tau_{-x} \varphi_n \in T_i^\omega$ , which yields thanks to the observation above  $\tau_{-x} \varphi_n \in T_i^\omega$  and  $\varphi_n \in T_i^\omega$ . We can now use the estimate of the spectral gap obtained in Proposition 4.4, which yields since we assumed that the  $\varphi_n$ 's have mean 0 w.r.t.  $\mu_{\widehat{\alpha}}$ ,

$$\mathbb{E}_{\widehat{\alpha}}(\varphi_n \mathcal{L}_n \varphi_n) \leq -\frac{C}{n^2} \mathbb{E}_{\widehat{\alpha}}(\varphi_n^2)$$

hence

$$\mathbb{E}_{\widehat{\alpha}}(\varphi_n^2) \leq C^{-1} n^2 \mathcal{D}_n(\varphi_n),$$

where  $\mathcal{D}_n(f) = -\mathbb{E}_{\widehat{\alpha}}(f\mathcal{L}_n f)$  is the Dirichlet form relative to the symmetric exclusion process restricted to  $B_n$ . Recall from the definition of  $\mathcal{D}_n$  that

$$\mathcal{D}_n(\varphi_n) = \frac{1}{2} \sum_{i=1}^2 \sum_{\delta \in \{-1,1\}} \sum_{x, x+\delta e_i \in B_n} \mathbb{E}_{\widehat{\alpha}} \left[ (\nabla_{x,+\delta e_i} \varphi_n)^2 \right].$$

Since  $\nabla_{x,x+e_i} \varphi_n = \mathbf{u}_{i,x}^n$  and  $\nabla_{x,x-e_i} \varphi_n = -\mathbf{u}_{i,x-e_i}^n (\widehat{\eta}^{x,x-e_i})$ , Jensen's inequality yields

$$\mathcal{D}_n(\varphi_n) = \sum_{i=1}^2 \sum_{x, x+e_i \in B_n} \mathbb{E}_{\widehat{\alpha}} \left[ (\mathbf{u}_{i,x}^n)^2 \right] \leq \sum_{i=1}^2 \sum_{x, x+e_i \in B_n} \mathbb{E}_{\widehat{\alpha}} \left[ (\mathbf{u}_i)^2 \right] \leq Cn^2 \|\mathbf{u}\|_{2,\widehat{\alpha}}^2, \quad (5.53)$$

for some constant  $C$ , thanks to a change of variable  $\eta \rightarrow \widehat{\eta}^{x,x+e_i}$  under which  $\mu_{\widehat{\alpha}}$  is invariant. We obtain as wanted, thanks to the spectral gap,

$$\mathbb{E}_{\widehat{\alpha}}(\varphi_n^2) \leq Kn^4 \|\mathbf{u}\|_{2,\widehat{\alpha}}^2, \quad (5.54)$$

where  $K$  is a constant depending only on  $\widehat{\alpha}$ . ■

### Second step : Control on the $L^2$ norm of the boundary terms.

Recall that in order to control the boundary terms, we have to deal with creation and annihilation of particles. We now prove thanks to Lemma 5.19 that the boundary terms are bounded in  $L^2(\mu_{\widehat{\alpha}})$ , which is the main difficulty of the proof of Lemma 5.18.

**Lemma 5.20.** *Given the definition in equation (5.52) of both boundary terms  $\widetilde{R}_{n,i}^-$  and  $\widetilde{R}_{n,i}^+$ , there is a constant  $C = C(\widehat{\alpha})$ , such that uniformly in  $n$*

$$\mathbb{E}_{\widehat{\alpha}} \left( \left[ \widetilde{R}_{n,i}^- \right]^2 \right) \leq C \|\mathbf{u}\|_{2,\widehat{\alpha}}^2 \quad \text{and} \quad \mathbb{E}_{\widehat{\alpha}} \left( \left[ \widetilde{R}_{n,i}^+ \right]^2 \right) \leq C \|\mathbf{u}\|_{2,\widehat{\alpha}}^2.$$

*Proof of Lemma 5.20 :* We will treat in full detail only the case of the negative boundary term

$$\widetilde{R}_{n,i}^- = \frac{1}{(2n)^2} \sum_{\substack{x_i = -n-1 \\ |x_j| \leq n, j \neq i}} \tau_{-x} \nabla_{x,x+e_i} \widetilde{\varphi}_n,$$

since the positive boundary term is treated in a similar fashion. The elementary inequality

$$\left( \sum_{i=1}^n a_i \right)^2 \leq n \sum_{i=1}^n a_i^2, \quad (5.55)$$

yields

$$\mathbb{E}_{\widehat{\alpha}} \left( \left[ \widetilde{R}_{n,i}^- \right]^2 \right) \leq \frac{2n}{(2n)^4} \sum_{\substack{x_i = -n-1 \\ |x_j| \leq n, j \neq i}} \mathbb{E}_{\widehat{\alpha}} \left( (\tau_{-x} \nabla_{x,x+e_i} \widetilde{\varphi}_n)^2 \right) = \frac{1}{8n^3} \sum_{\substack{x_i = -n-1 \\ |x_j| \leq n, j \neq i}} \mathbb{E}_{\widehat{\alpha}} \left( (\nabla_{x,x+e_i} \widetilde{\varphi}_n)^2 \right),$$

by translation invariance of  $\mu_{\widehat{\alpha}}$ . At this point, we reduced our control over the boundary term to a sum of  $L^2$  bounds on  $\nabla_{x,x+e_i}\widetilde{\varphi}_n$ , which we wrote explicitly in equation (5.49) for any  $x$  in the negative boundary ( $x_i = -n - 1$ ,  $|x_j| \leq n$ ),

$$\nabla_{x,x+e_i}\widetilde{\varphi}_n(\widehat{\eta}) = \eta_x(1 - \eta_{x+e_i})\left(\widetilde{\varphi}_n(\widehat{\eta} + \delta_{x+e_i}^\theta) - \widetilde{\varphi}_n(\widehat{\eta})\right), \quad (5.56)$$

where  $\widehat{\eta} + \delta_{x+e_i}^\theta$  is the configuration equal to  $\widehat{\eta}$  everywhere except in  $x + e_i$ , where the site contains a particle with angle  $\theta$  distributed as  $\widehat{\alpha}/\alpha$  independently of  $\widehat{\eta}$ . Note that in the expectation  $\mathbb{E}_{\widehat{\alpha}}$ , we will also take the expectation w.r.t.  $\theta$ , but still denote it by  $\mathbb{E}_{\widehat{\alpha}}$  for the sake of concision. Since  $\varphi_n$  is independent of  $\widehat{\eta}_x$  for any  $x$  in the negative boundary term, the  $L^2$  norm of the gradient can be rewritten thanks to equation (5.56)

$$\mathbb{E}_{\widehat{\alpha}}(\eta_x)\mathbb{E}_{\widehat{\alpha}}\left((1 - \eta_{x+e_i})\left(\widetilde{\varphi}_n(\widehat{\eta} + \delta_{x+e_i}^\theta) - \widetilde{\varphi}_n(\widehat{\eta})\right)^2\right) = \alpha\mathbb{E}_{\widehat{\alpha}}\left((1 - \eta_{x+e_i})\left(\widetilde{\varphi}_n(\widehat{\eta} + \delta_{x+e_i}^\theta) - \widetilde{\varphi}_n(\widehat{\eta})\right)^2\right),$$

and the  $L^2$  norm of the boundary term can be bounded from above by

$$\mathbb{E}_{\widehat{\alpha}}\left(\left[\widetilde{R}_{n,i}\right]^2\right) \leq \frac{\alpha}{8n^3} \sum_{\substack{x_i=-n-1 \\ |x_j| \leq n, j \neq i}} \mathbb{E}_{\widehat{\alpha}}\left((1 - \eta_{x+e_i})\left[\widetilde{\varphi}_n(\widehat{\eta} + \delta_{x+e_i}^\theta) - \widetilde{\varphi}_n(\widehat{\eta})\right]^2\right), \quad (5.57)$$

where the expectation w.r.t  $\theta$  is taken under the law  $\widehat{\alpha}/\alpha$ . Thanks to the identity above, and since the number of terms in (5.57) is of order  $n$ , Lemma 5.20 follows from Lemma 5.21 below.  $\blacksquare$

**Lemma 5.21.** *There exists a constant  $C$  depending only on  $\widehat{\alpha}$ , such that for any  $x \in B_n$  such that  $x_i = -n - 1$ ,*

$$\mathbb{E}_{\widehat{\alpha}}\left((1 - \eta_{x+e_i})\left[\widetilde{\varphi}_n(\widehat{\eta} + \delta_{x+e_i}^\theta) - \widetilde{\varphi}_n(\widehat{\eta})\right]^2\right) \leq Cn^2 \|\mathbf{u}\|_{2,\widehat{\alpha}}^2.$$

*Proof of Lemma 5.21 :* Let us fix  $x$ ,  $x_i = -n - 1$  in the negative boundary. To make the Dirichlet form appear, we are going to force an occupied site in a neighborhood of  $x$ , and transform the creation process into a particle transfer. For the sake of clarity, any configuration  $\widehat{\eta}$  on  $B_{3n}$  will be considered as the pair of an interior configuration  $\widehat{\zeta}$  on  $B_n$  (which is hence  $\mathcal{F}_n$ -measurable), and an exterior configuration  $\widehat{\xi}$  on  $B_{3n} - B_n$ . With the previous notations in mind, and since  $\widetilde{\varphi}_n = \mathbb{E}(\varphi_{3n} | \mathcal{F}_n)$  we have the following equalities for  $\widetilde{\varphi}_n(\widehat{\zeta} + \delta_{x+e_i}^\theta)$  which appears in (5.57) :

$$\widetilde{\varphi}_n(\widehat{\zeta} + \delta_{x+e_i}^\theta) = \mathbb{E}_{\widehat{\alpha}}(\varphi_{3n} | \mathcal{F}_n)(\widehat{\zeta} + \delta_{x+e_i}^\theta) = \mathbb{E}_{\widehat{\alpha}}(\varphi_{3n}(\widehat{\zeta}', \widehat{\xi}) | \widehat{\zeta}' = \widehat{\zeta} + \delta_{x+e_i}^\theta).$$

where in last term, the expectation is only taken w.r.t  $B_{3n} - B_n$ .

We compute now  $\widetilde{\varphi}_n(\widehat{\zeta} + \delta_{x+e_i}^\theta) - \widetilde{\varphi}_n(\widehat{\zeta})$ . For any  $y \in B_{3n} - B_n$ , we rewrite using the identity  $(1 - \alpha)^{-1}[1 - \xi + \xi - \alpha] = 1$

$$\widetilde{\varphi}_n(\widehat{\zeta} + \delta_{x+e_i}^\theta) = \frac{1}{1 - \alpha} \left( \mathbb{E}_{\widehat{\alpha}}((1 - \xi_y)\varphi_{3n} | \mathcal{F}_n) + \mathbb{E}_{\widehat{\alpha}}((\xi_y - \alpha)\varphi_{3n} | \mathcal{F}_n) \right) (\widehat{\zeta} + \delta_{x+e_i}^\theta),$$

where  $\xi_y$  is the occupation variable in  $y$ , and is either 1 or 0 depending on whether the site  $y$  is empty or not.

The first part of this decomposition will be controlled by the Dirichlet form, as the existence of an empty site in  $y$  (thanks to  $1 - \xi_y$ ) will allow us to reconstruct a particle transfer from  $y$  to  $x + e_i$ .

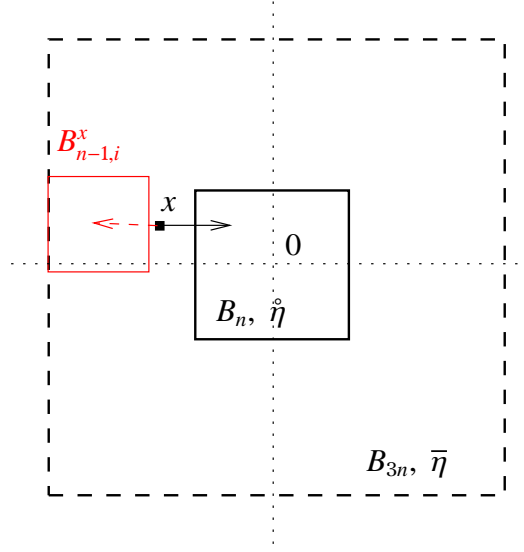
 Figure 12: Construction of  $B_{n-1,i}^x$ 

The second term will be estimated after a spatial averaging over a large microscopic box. This box must be measurable with respect to the spins in  $B_{3n} - B_n$ , in order to be able to introduce it inside the expectation. For any  $x$  in the negative boundary, consider the set

$$B_{n-1,i}^x = x - ne_i + B_{n-1},$$

depicted in Figure 12, which is the box of radius  $n-1$  centered in  $x - ne_i$ . Remark that the cardinal of  $B_{n-1,i}^x$  is  $(2n-1)^2$ , so that averaging the previous identity over the  $y$ 's in  $B_{n-1,i}^x$  allows us to write

$$\bar{\varphi}_n(\zeta + \delta_{x+e_i}^\theta) = \frac{1}{(2n-1)^2} \sum_{y \in B_{n-1,i}^x} \left( \mathbb{E}_{\hat{\alpha}} \left( \frac{1-\xi_y}{1-\alpha} \varphi_{3n} \mid \mathcal{F}_n \right) + \mathbb{E}_{\hat{\alpha}} \left( \frac{\xi_y - \alpha}{1-\alpha} \varphi_{3n} \mid \mathcal{F}_n \right) \right) (\zeta + \delta_{x+e_i}^\theta). \quad (5.58)$$

Let us consider the first term of the previous equality. For any  $y$  in the boundary, thanks to the factor  $1 - \xi_y$  the site  $y$  is empty. By the change of variable  $\hat{\xi} \rightarrow \hat{\xi} - \delta_y$  where  $\hat{\xi} - \delta_y$  is the configuration identical to  $\hat{\xi}$  everywhere except in  $y$  where the site is now empty, so that

$$\begin{aligned} \mathbb{E}_{\hat{\alpha}} \left( \frac{1-\xi_y}{1-\alpha} \varphi_{3n} \mid \mathcal{F}_n \right) (\zeta + \delta_{x+e_i}^\theta) &= \mathbb{E}_{\hat{\alpha}} \left( \frac{\xi_y}{\alpha} \varphi_{3n}(\hat{\xi} - \delta_y) \mid \mathcal{F}_n \right) (\zeta + \delta_{x+e_i}^\theta) \\ &= \mathbb{E}_{\hat{\alpha}} \left( \frac{\xi_y}{\alpha} [\varphi_{3n}(\zeta + \delta_{x+e_i}^\theta, \hat{\xi} - \delta_y) - \varphi_{3n}(\zeta, \hat{\xi})] \mid \mathcal{F}_n \right) + \mathbb{E}_{\hat{\alpha}} \left( \frac{\xi_y}{\alpha} \varphi_{3n}(\zeta, \hat{\xi}) \mid \mathcal{F}_n \right). \end{aligned}$$

We deduce from the last identity and equation (5.58) that we can write  $\bar{\varphi}_n(\zeta + \delta_{x+e_i}^\theta)$  as

$$\begin{aligned} \bar{\varphi}_n(\zeta + \delta_{x+e_i}^\theta) &= \frac{1}{(2n-1)^2} \sum_{y \in B_{n-1,i}^x} \left[ \mathbb{E}_{\hat{\alpha}} \left( \frac{\xi_y}{\alpha} [\varphi_{3n}(\zeta + \delta_{x+e_i}^\theta, \hat{\xi} - \delta_y) - \varphi_{3n}(\zeta, \hat{\xi})] \mid \mathcal{F}_n \right) \right. \\ &\quad \left. + \mathbb{E}_{\hat{\alpha}} \left( \varphi_{3n}(\zeta, \hat{\xi}) \mid \mathcal{F}_n \right) + \mathbb{E}_{\hat{\alpha}} \left( \frac{\xi_y - \alpha}{1-\alpha} \varphi_{3n}(\zeta + \delta_{x+e_i}^\theta, \hat{\xi}) \mid \mathcal{F}_n \right) \right]. \end{aligned}$$

We are therefore able to rewrite the difference  $\widetilde{\varphi}_n(\widehat{\zeta} + \delta_{x+e_i}^\theta) - \widetilde{\varphi}_n(\widehat{\zeta})$  as

$$\begin{aligned} \widetilde{\varphi}_n(\widehat{\zeta} + \delta_{x+e_i}^\theta) - \widetilde{\varphi}_n(\widehat{\zeta}) &= \frac{1}{(2n-1)^2} \sum_{y \in B_{n-1,i}^x} \left[ \mathbb{E}_{\widehat{\alpha}} \left( \frac{\xi_y}{\alpha} \left[ \varphi_{3n}(\widehat{\zeta} + \delta_{x+e_i}^\theta, \widehat{\xi} - \delta_y) - \varphi_{3n}(\widehat{\zeta}, \widehat{\xi}) \right] \middle| \mathcal{F}_n \right) \right. \\ &\quad \left. + \mathbb{E}_{\widehat{\alpha}} \left( \frac{\xi_y - \alpha}{\alpha} \varphi_{3n}(\widehat{\zeta}, \widehat{\xi}) \middle| \mathcal{F}_n \right) + \mathbb{E}_{\widehat{\alpha}} \left( \frac{\xi_y - \alpha}{1-\alpha} \varphi_{3n}(\widehat{\zeta} + \delta_{x+e_i}^\theta, \widehat{\xi}) \middle| \mathcal{F}_n \right) \right]. \end{aligned} \quad (5.59)$$

using the elementary bound (5.55) as well as Jensen's inequality yields

$$\begin{aligned} &\mathbb{E}_{\widehat{\alpha}} \left( (1 - \eta_{x+e_i}) (\widetilde{\varphi}_n(\widehat{\eta} + \delta_{x+e_i}^\theta) - \widetilde{\varphi}_n(\widehat{\eta}))^2 \right) \\ &\leq \frac{3}{(2n-1)^2} \left[ \sum_{y \in B_{n-1,i}^x} \mathbb{E}_{\widehat{\alpha}} \left( \frac{\eta_y (1 - \eta_{x+e_i})}{\alpha^2} \left[ \varphi_{3n}(\widehat{\eta} + \delta_{x+e_i}^\theta - \delta_y) - \varphi_{3n}(\widehat{\eta}) \right]^2 \right) \right] \\ &\quad + 3 \mathbb{E}_{\widehat{\alpha}} \left( \mathbb{E}_{\widehat{\alpha}} \left( \left( \frac{1}{(2n-1)^2} \sum_{y \in B_{n-1,i}^x} \frac{\eta_y - \alpha}{\alpha} \right) \varphi_{3n} \middle| \mathcal{F}_n \right)^2 \right) \\ &\quad + 3 \mathbb{E}_{\widehat{\alpha}} \left( \mathbb{E}_{\widehat{\alpha}} \left( \left( \frac{(1 - \eta_{x+e_i})}{(2n-1)^2} \sum_{y \in B_{n-1,i}^x} \frac{\eta_y - \alpha}{1-\alpha} \right) \varphi_{3n}(\widehat{\eta} + \delta_{x+e_i}^\theta) \middle| \mathcal{F}_n \right)^2 \right). \end{aligned} \quad (5.60)$$

From now on, the strategy to prove Lemma 5.21 is straightforward. We are going to prove that each of the three terms in the right-hand side above is of order  $n^2$ :

- The second and third line above are controlled thanks to the spatial averaging by the  $L^2$  norm of the  $\varphi_n$ 's.
- In the first line, the angle of the particle deleted in  $y$  is not necessarily the same as the one of the particle created in  $x + e_i$ , because the angle  $\theta$  above is distributed according to  $\widehat{\alpha}/\alpha$  and independent of the configuration. However, since the  $\varphi_n$  are in  $T_0^\omega$  their dependency in the angles can be sharply estimated. Once this difficulty is dealt with, the remaining quantity will be controlled by the Dirichlet form.

We first treat the first step above. Thanks to the Cauchy-Schwarz inequality, we can estimate the second line

$$\begin{aligned} \mathbb{E}_{\widehat{\alpha}} \left( \mathbb{E}_{\widehat{\alpha}} \left( \left( \frac{1}{(2n-1)^2} \sum_{y \in B_{n-1,i}^x} \frac{\eta_y - \alpha}{\alpha} \right) \varphi_{3n} \middle| \mathcal{F}_n \right)^2 \right) &\leq \frac{1}{\alpha^2} \mathbb{E}_{\widehat{\alpha}} \left( \left( \frac{1}{(2n-1)^2} \sum_{y \in B_{n-1,i}^x} \eta_y - \alpha \right)^2 \right) \mathbb{E}_{\widehat{\alpha}} (\varphi_{3n}^2) \\ &= \frac{\text{Var}_{\widehat{\alpha}}(\eta_0)}{\alpha^2 (2n-1)^2} \mathbb{E}_{\widehat{\alpha}} (\varphi_{3n}^2), \end{aligned}$$

since under  $\mu_{\widehat{\alpha}}$ , the  $\eta_y$ 's are i.i.d. variables. We can now use the bound obtained in Lemma 5.19, which yields that for some constant  $C_1 = C_1(\widehat{\alpha})$ ,

$$\mathbb{E}_{\widehat{\alpha}} \left( \mathbb{E}_{\widehat{\alpha}} \left( \left( \frac{1}{(2n-1)^2} \sum_{y \in B_{n-1,i}^x} \eta_y - \alpha \right) \varphi_{3n} \middle| \mathcal{F}_n \right)^2 \right) \leq C_1 n^2 \|\mathbf{u}\|_{2,\widehat{\alpha}}^2. \quad (5.61)$$



We obtain in the exact same fashion, since

$$\mathbb{E}_{\widehat{\alpha}} \left( (1 - \eta_{x+e_i}) \varphi_{3n} \left( \widehat{\eta} + \delta_{x+e_i}^\theta \right)^2 \right) = \mathbb{E}_{\widehat{\alpha}} (\eta_{x+e_i} \varphi_{3n}^2) \leq \mathbb{E}_{\widehat{\alpha}} (\varphi_{3n}^2),$$

that

$$\mathbb{E}_{\widehat{\alpha}} \left( \mathbb{E}_{\widehat{\alpha}} \left( \left( \frac{1}{(2n-1)^2} \sum_{y \in B_{n-1,i}^x} \eta_y - \alpha \right) (1 - \eta_{x+e_i}) \varphi_{3n} \left( \widehat{\eta} + \delta_{x+e_i}^\theta \right) \middle| \mathcal{F}_n \right)^2 \right) \leq C_2 n^2 \|\mathbf{u}\|_{2,\widehat{\alpha}}^2 \quad (5.62)$$

We now turn to the second step, and obtain an estimate on the first line of the right-hand side of (5.60), namely

$$\frac{1}{(2n-1)^2} \sum_{y \in B_{n-1,i}^x} \mathbb{E}_{\widehat{\alpha}} \left( \frac{\eta_y (1 - \eta_{x+e_i})}{\alpha^2} \left[ \varphi_{3n} \left( \widehat{\eta} + \delta_{x+e_i}^\theta - \delta_y \right) - \varphi_{3n} \left( \widehat{\eta} \right) \right]^2 \right). \quad (5.63)$$

We first deal with the fact that the deleted and created particles do not have the same angle. Recall that  $\widehat{\eta}^{y,\theta}$  is the configuration where the angle of the particle at the site  $y$  has been set to  $\theta$ , we can thus write

$$\widehat{\eta} + \delta_{x+e_i}^\theta - \delta_y = \left( \widehat{\eta}^{y,\theta} \right)^{y,x+e_i},$$

therefore

$$\left( \varphi_{3n} \left( \widehat{\eta} + \delta_{x+e_i}^\theta - \delta_y \right) - \varphi_{3n} \left( \widehat{\eta} \right) \right)^2 \leq 2 \left[ \varphi_{3n} \left( \left( \widehat{\eta}^{y,\theta} \right)^{y,x+e_i} \right) - \varphi_{3n} \left( \widehat{\eta}^{y,\theta} \right) \right]^2 + 2 \left[ \varphi_{3n} \left( \widehat{\eta}^{y,\theta} \right) - \varphi_{3n} \left( \widehat{\eta} \right) \right]^2,$$

Since  $\theta$  is distributed according to  $\widehat{\alpha}/\alpha$ ,  $\widehat{\eta}^{y,\theta}$  has the same distribution as  $\widehat{\eta}$  under  $\mu_{\widehat{\alpha}}$ , and we can therefore control (5.63) by

$$\frac{2}{\alpha^2 (2n-1)^2} \sum_{y \in B_{n-1,i}^x} \left[ \mathbb{E}_{\widehat{\alpha}} \left( \eta_y (1 - \eta_{x+e_i}) \left[ \varphi_{3n} \left( \widehat{\eta}^{y,x+e_i} \right) - \varphi_{3n} \left( \widehat{\eta} \right) \right]^2 \right) + \mathbb{E}_{\widehat{\alpha}} \left( \eta_y \left[ \varphi_{3n} \left( \widehat{\eta}^{y,\theta} \right) - \varphi_{3n} \left( \widehat{\eta} \right) \right]^2 \right) \right]. \quad (5.64)$$

Once again, we are going to prove that the contributions of both terms in the right-hand side above are of order  $n^2$ .

We first need to decompose, as in the proof of the two-block estimate of Lemma 3.4, the particle jumps appearing in the first term into nearest neighbor jumps. More precisely, there exists a finite family  $x_0, \dots, x_p$  such that  $x_0 = y$ ,  $x_p = x$  and for any  $k \in \llbracket 0, p-1 \rrbracket$ ,  $|x_k - x_{k+1}| = 1$ . Furthermore, we can safely assume that  $p = |y - x|$ . With this construction, for any  $y \in B_{n-1,i}^x$ , we can write

$$\begin{aligned} \mathbb{E}_{\widehat{\alpha}} \left[ \eta_y (1 - \eta_{x+e_i}) \left( \varphi_{3n} \left( \widehat{\eta}^{y,x+e_i} \right) - \varphi_{3n} \left( \widehat{\eta} \right) \right)^2 \right] &\leq |y - x| \sum_{k=1}^{|y-x|} \mathbb{E}_{\widehat{\alpha}} \left[ \eta_{x_k} (1 - \eta_{x_{k+1}}) \left( \varphi_{3n} \left( \widehat{\eta}^{x_k, x_{k+1}} \right) - \varphi_{3n} \left( \widehat{\eta} \right) \right)^2 \right] \\ &\leq |y - x| \sum_{k=1}^{|y-x|} \mathbb{E}_{\widehat{\alpha}} \left( \left[ \nabla_{x_k, x_{k+1}} \varphi_{3n} \left( \widehat{\eta} \right) \right]^2 \right), \end{aligned} \quad (5.65)$$

since  $(\sum_{k=1}^p a_k)^2 \leq p \sum_{k=1}^p a_k^2$ . Furthermore, by definition of  $\varphi_{3n}$ , assume that  $x_{k+1} = x_k + e_j$  in which case  $\nabla_{x_k, x_{k+1}} \varphi_{3n} \left( \widehat{\eta} \right) = \mathbf{u}_{x_k, j}^{3n}$ , we obtain by Jensen's Inequality that

$$\mathbb{E}_{\widehat{\alpha}} \left( \left[ \nabla_{x_k, x_{k+1}} \varphi_{3n} \left( \widehat{\eta} \right) \right]^2 \right) \leq \mathbb{E}_{\widehat{\alpha}} \left( \tau_{x_k} \left( \mathbf{u}_j \right)^2 \right) \leq \|\mathbf{u}\|_{2,\widehat{\alpha}}^2.$$

The same bound holds if  $x_{k+1} = x_k - e_j$  for some  $j$ , and we can finally rewrite (5.65) as

$$\mathbb{E}_{\widehat{\alpha}} \left[ \eta_y (1 - \eta_{x+e_i}) (\varphi_{3n}(\widehat{\eta}^{y,x+e_i}) - \varphi_{3n}(\widehat{\eta}))^2 \right] \leq |y-x| \sum_{k=1}^{|y-x|} \|\mathbf{u}\|_{2,\widehat{\alpha}}^2 = |y-x|^2 \|\mathbf{u}\|_{2,\widehat{\alpha}}^2.$$

We now get back to the first term in (5.64). It is not hard to see that  $\sum_{y \in B_{n-1,i}^x} |y-x|^2$  is of order  $n^4$ , and we obtain as wanted that for some constant  $C_3$  depending only on  $\widehat{\alpha}$ ,

$$\frac{2}{\alpha^2(2n-1)^2} \sum_{y \in B_{n-1,i}^x} \mathbb{E}_{\widehat{\alpha}} \left( \eta_y (1 - \eta_{x+e_i}) [\varphi_{3n}(\widehat{\eta}^{y,x+e_i}) - \varphi_{3n}(\widehat{\eta})]^2 \right) \leq C_3 n^2 \|\mathbf{u}\|_{2,\widehat{\alpha}}^2. \quad (5.66)$$

We now estimate the second contribution in (5.64). The only difference between  $\varphi_{3n}(\widehat{\eta}^{y,\theta})$  and  $\varphi_{3n}(\widehat{\eta})$  is the angle of the particle at site  $y$ . We proved along with Lemma 5.19 that  $\varphi_n \in T_i^\omega$ , therefore the variation of  $\varphi_n$  when an angle is changed can be precisely estimated. For the sake of simplicity, we assume that  $\varphi_n$  is in the set  $T_0^\omega$  we defined in (4.4), but if it is not the case, the estimate we are going to obtain still holds, once  $\varphi_n$  is replaced by a sequence in  $T_0^\omega$  which converges towards  $\varphi_n$ . If  $\varphi_n \in T_0^\omega$ , for any  $n$ , there exists two constants  $a_{1,n}$  and  $a_{2,n}$ , a family of angle-blind functions  $(\psi_{n,x})_{x \in \mathbb{Z}^2}$ , and an angle-blind function  $\psi_n^* \in \mathcal{S}$ , such that

$$\varphi_{3n} = \psi_n^* + \sum_{x \in \mathbb{Z}^2} (a_{1,n} \eta_x + a_{2,n} \eta_x^\omega) \psi_{n,x}.$$

Since the only difference between  $\widehat{\eta}^{y,\theta}$  and  $\widehat{\eta}$  is in the angle present at the site  $y$ , we can write

$$\varphi_{3n}(\widehat{\eta}^{y,\theta}) - \varphi_{3n}(\widehat{\eta}) = a_{2,n} (\omega(\theta) - \omega(\theta_y)) \eta_y \psi_{n,y}(\eta),$$

therefore the second line in (5.64) can be rewritten

$$\frac{2}{\alpha^2(2n-1)^2} \sum_{y \in B_{n-1,i}^x} \mathbb{E}_{\widehat{\alpha}} \left( \eta_y (\omega(\theta) - \omega(\theta_y))^2 \psi_{n,y}^2 \right) \leq \frac{4a_{2,n} \text{Var}_{\widehat{\alpha}}(\omega)}{\alpha^2(2n-1)^2} \sum_{y \in \mathbb{Z}^2} \mathbb{E}_{\widehat{\alpha}} \left( \eta_y \psi_{n,y}^2 \right), \quad (5.67)$$

where we shortened  $\text{Var}_{\widehat{\alpha}}(\omega) = \text{Var}_{\widehat{\alpha}}(\omega(\theta_0))$ , since the angles are independent of the configuration conditionally to the presence of a particle. Recall from Section 4.2 that we can write

$$\varphi_n = \varphi_n^{sb} + \varphi_n^\omega,$$

where

$$\varphi_n^{sb} = \psi_n^* + \sum_{x \in \mathbb{Z}^2} b_{1,n} \eta_x \psi_{n,x} \quad \text{and} \quad \varphi_n^\omega = \sum_{x \in \mathbb{Z}^2} a_{2,n} (\omega(\theta_x) - \mathbb{E}_{\widehat{\alpha}}(\omega)) \eta_x \psi_{n,x},$$

where  $b_{1,n} = a_{1,n} + \mathbb{E}_{\widehat{\alpha}}(\omega)$  and  $\mathbb{E}_{\widehat{\alpha}}(\omega)$  stands for  $\mathbb{E}_{\widehat{\alpha}}(\omega(\theta_0))$ . Furthermore, one obtains

$$\mathbb{E}_{\widehat{\alpha}}(\varphi_n^2) = \mathbb{E}_{\widehat{\alpha}}((\varphi_n^{sb})^2) + \mathbb{E}_{\widehat{\alpha}}((\varphi_n^\omega)^2),$$

as well as

$$\mathbb{E}_{\widehat{\alpha}}((\varphi_n^\omega)^2) = a_{2,n} \text{Var}_{\widehat{\alpha}}(\omega) \sum_{x \in \mathbb{Z}^2} \mathbb{E}_{\widehat{\alpha}}(\eta_x \psi_{n,x}^2).$$

The two previous identities finally yield that

$$a_{2,n} \text{Var}_{\widehat{\alpha}}(\omega) \sum_{x \in \mathbb{Z}^2} \mathbb{E}_{\widehat{\alpha}}(\eta_x \psi_{n,x}^2) \leq \mathbb{E}_{\widehat{\alpha}}(\varphi_n^2).$$

We now use the previous identity as well as (5.67) and Lemma 5.19 to obtain that for some constant  $C_4$  depending only on  $\widehat{\alpha}$

$$\frac{2}{\alpha^2(2n-1)^2} \sum_{y \in B_{n-1,i}^x} \mathbb{E}_{\widehat{\alpha}} \left( \eta_y \left[ \varphi_{3n}(\widehat{\eta}^{y,\theta}) - \varphi_{3n}(\widehat{\eta}) \right]^2 \right) \leq C_4 n^2 \|\mathbf{u}\|_{2,\widehat{\alpha}}^2. \quad (5.68)$$

This is the estimate we wanted for the second line of (5.64).

Letting  $C = 3(C_1 + C_2 + C_3 + C_4)$ , we now use the four bounds (5.61), (5.62), (5.66) and (5.68) in equation (5.60), to obtain that

$$\mathbb{E}_{\widehat{\alpha}} \left( (1 - \eta_{x+e_i})(\widetilde{\varphi}_n(\widehat{\eta} + \delta_{x+e_i}^\theta) - \widetilde{\varphi}_n(\widehat{\eta}))^2 \right) \leq C n^2 \|\mathbf{u}\|_{2,\widehat{\alpha}}^2$$

as wanted, which concludes the proof of Lemma 5.21.  $\blacksquare$

We have now finished the second step, and proven that the boundary terms  $(\widetilde{R}_{n,i}^+)_{n \in \mathbb{N}}$  and  $(\widetilde{R}_{n,i}^-)_{n \in \mathbb{N}}$  are bounded in  $L^2(\mu_{\widehat{\alpha}})$ . To conclude the proof of Lemma 5.18 we still have to prove that all limiting points  $\mathfrak{R}_i^-$  of  $(\widetilde{R}_{n,i}^-)$  are in the linear span of the currents. The main difficulty is to prove that any limit point only depends on  $\widehat{\eta}_0$  and  $\widehat{\eta}_{e_i}$ , which we state as a separate lemma.

Third step : Proof that  $\mathfrak{R}_i^-$  only depends on  $\widehat{\eta}$  through  $\widehat{\eta}_0$  and  $\widehat{\eta}_{e_i}$

Let us denote

$$\mathbb{Z}_{+,i}^2 = \{x_i > 0\} \cap \mathbb{Z}^2 \setminus \{e_i\},$$

we first prove the following intermediate result.

**Lemma 5.22.** *Any weak limit point  $\mathfrak{R}_i^-$  of the sequence  $(\widetilde{R}_{n,i}^-)$  is measurable w.r.t. the sites in  $\mathbb{Z}^2 \cap \{x_i > 0\} \cup \{0\}$ . Furthermore, for any edge  $(z, z \pm e_j)$  with both ends in the set  $\mathbb{Z}_{+,i}^2$ , the gradient  $\nabla_{z,z \pm e_j} \mathfrak{R}_i^-$  vanishes in  $L^2(\mu_{\widehat{\alpha}})$ .*

*Proof of Lemma 5.22 :* In order to avoid taking subsequences, let us also assume that  $(\widetilde{R}_{n,i}^-)$  weakly converges towards  $\mathfrak{R}_i^-$ . We first prove the first statement, which is elementary. For any  $x$  in the boundary,  $\tau_{-x} \widetilde{\varphi}_n$  is measurable with respect to the half plane  $\{x_i > 0\}$ , therefore  $\nabla_{0,e_i} \tau_{-x} \widetilde{\varphi}_n$  is measurable with respect to the sites in  $\{x_i > 0\} \cup \{0\}$ . We deduce from the last remark that for any  $n$ ,  $\widetilde{R}_{n,i}^-$  is measurable for any  $n$  w.r.t. the sites in  $\{x_i > 0\} \cup \{0\}$ , therefore  $\mathfrak{R}_i^-$  also is.

We now show that for any edge  $\{z, z \pm e_j\} \subset \mathbb{Z}_{+,i}^2$ , the gradient  $\nabla_{z,z \pm e_j} \mathfrak{R}_i^-$  vanishes. Fix an edge  $(z, z \pm e_j)$  with both ends in  $\mathbb{Z}_{+,i}^2$ . We are going to prove that the sequence  $(\nabla_{z,z \pm e_j} \widetilde{R}_{n,i}^-)_{n \in \mathbb{N}}$  vanishes in  $L^2(\mu_{\widehat{\alpha}})$ . By definition,

$$\begin{aligned} \nabla_{z,z \pm e_j} \widetilde{R}_{n,i}^- &= \frac{1}{(2n)^2} \sum_{x_i = -n-1} \nabla_{z,z \pm e_j} \tau_{-x} \nabla_{x,x+e_i} \widetilde{\varphi}_n \\ &= \frac{1}{(2n)^2} \sum_{x_i = -n-1} \nabla_{z,z \pm e_j} \nabla_{0,e_i} \tau_{-x} \widetilde{\varphi}_n. \end{aligned}$$

Because  $z, z + e_j$  are different from 0 and  $e_i$ , the two gradients in the formula above commute, therefore using once again  $(\sum_{i=1}^n a_i)^2 \leq n \sum_{i=1}^n a_i^2$ , as well as the crude bound  $\mathbb{E}_{\widehat{\alpha}}((\nabla_a f)^2) \leq 4\mathbb{E}_{\widehat{\alpha}}(f^2)$ , yields

$$\begin{aligned} \mathbb{E}_{\widehat{\alpha}} \left[ (\nabla_{z, z \pm e_j} \widetilde{R}_{n,i}^-)^2 \right] &\leq \frac{2n}{(2n)^4} \sum_{x_i = -n-1} \mathbb{E}_{\widehat{\alpha}} \left[ (\nabla_{0, e_i} \nabla_{z, z \pm e_j} \tau_{-x} \widetilde{\varphi}_n)^2 \right] \\ &\leq \frac{1}{(2n)^3} \sum_{x_i = -n-1} \mathbb{E}_{\widehat{\alpha}} \left[ (\nabla_{0, e_i} \tau_{-x} \nabla_{z+x, z+x \pm e_j} \widetilde{\varphi}_n)^2 \right] \\ &\leq \frac{4}{(2n)^3} \sum_{x_i = -n-1} \mathbb{E}_{\widehat{\alpha}} \left[ (\nabla_{z+x, z+x \pm e_j} \widetilde{\varphi}_n)^2 \right]. \end{aligned} \quad (5.69)$$

There are three cases to consider to estimate  $\mathbb{E}_{\widehat{\alpha}} \left[ (\nabla_{z+x, z+x \pm e_j} \widetilde{\varphi}_n)^2 \right]$ .

1. The first one is the case where both  $x+z$  and  $x+z \pm e_j$  are in  $B_n^c$ , the complementary set of  $B_n$ . In that case,

$$\mathbb{E}_{\widehat{\alpha}} \left[ (\nabla_{z+x, z+x \pm e_j} \widetilde{\varphi}_n)^2 \right] = 0,$$

because  $\widetilde{\varphi}_n$  is  $\mathcal{F}_n$ -measurable.

2. The second case when both  $x+z$  and  $x+z \pm e_j$  are in  $B_n$ . in that case, we can write

$$\begin{aligned} \nabla_{z+x, z+x \pm e_j} \widetilde{\varphi}_n &= \nabla_{z+x, z+x \pm e_j} \mathbb{E}_{\widehat{\alpha}}(\varphi_{3n} \mid \mathcal{F}_n) = \mathbb{E}_{\widehat{\alpha}}(\nabla_{z+x, z+x \pm e_j} \varphi_{3n} \mid \mathcal{F}_n) \\ &= \mathbb{E}_{\widehat{\alpha}}(\mathbf{u}_{j, z+x} \mid \mathcal{F}_n), \end{aligned} \quad (5.70)$$

therefore Jensen's inequality yields

$$\mathbb{E}_{\widehat{\alpha}} \left[ (\nabla_{z+x, z+x \pm e_j} \widetilde{\varphi}_n)^2 \right] \leq 4 \|\mathbf{u}\|_{2, \widehat{\alpha}}^2.$$

3. The last case to consider is if  $x+z$  and  $x+z \pm e_j$  link  $B_n$  and  $B_n^c$ . Then, an elementary adaptation of Lemma 5.21 yields that

$$\mathbb{E}_{\widehat{\alpha}} \left[ (\nabla_{z+x, z+x \pm e_j} \widetilde{\varphi}_n)^2 \right] \leq Cn^2 \|\mathbf{u}\|_{2, \widehat{\alpha}}^2.$$

We treat separately the two cases for  $j$ . Fix an edge  $(z, z \pm e_j)$  with both ends in  $\mathbb{Z}_{+, i}^2$ . If  $j = i$ , for any  $n$  large enough (more precisely as soon as  $2n + 2 \geq z_i$ ), for any  $x$  such that  $x_1 = -n - 1$ , either  $x+z$  and  $x+z \pm e_j$  are both in  $B_n$  or both are in its complementary set  $B_n^c$ . We are therefore either in the first or in the second case above, and since the number of terms in the sum is  $O(n)$ , equation (5.69) yields

$$\mathbb{E}_{\widehat{\alpha}} \left[ (\nabla_{z, z \pm e_j} \widetilde{R}_{n,i}^-)^2 \right] \leq \frac{K}{n^2} \|\mathbf{u}\|_{2, \widehat{\alpha}}^2 \xrightarrow{n \rightarrow \infty} 0,$$

for some constant  $K$  depending only on  $\widehat{\alpha}$ .

If now  $j \neq i$ , there can be only two terms in the sum over  $x$  for which  $x+z$  and  $x+z \pm e_j$  link  $B_n$  and  $B_n^c$  (third case above), whereas all the others are either in the first or the second case. We deduce from this that in this case, equation (5.69) yields

$$\mathbb{E}_{\widehat{\alpha}} \left[ (\nabla_{z, z \pm e_j} \widetilde{R}_{n,i}^-)^2 \right] \leq \frac{K'}{n^2} + \frac{K''n^2}{n^3} \|\mathbf{u}\|_{2, \widehat{\alpha}}^2 \xrightarrow{n \rightarrow \infty} 0,$$

where  $K'$  and  $K''$  are different constants depending only on  $\widehat{\alpha}$ . This proves that the sequence  $(\nabla_{z,z\pm e_j} \widetilde{R}_{n,i}^-)_n$  vanishes in  $L^2(\mu_{\widehat{\alpha}})$  for any edge  $(z, z \pm e_j)$  with both ends in  $\mathbb{Z}_{+,i}^2$ . Since the gradient  $\nabla_{z,z\pm e_j}$  is a continuous functional,  $\nabla_{z,z\pm e_j} \mathfrak{R}_i^-$  vanishes for any edge  $(z, z \pm e_j)$  with both ends in  $\mathbb{Z}_{+,i}^2$ . This concludes the proof of Lemma 5.22  $\blacksquare$

**Lemma 5.23.** *Any weak limit point  $\mathfrak{R}_i^-$  of the sequence  $(\widetilde{R}_{n,i}^-)_{n \in \mathbb{N}}$  only depends on the configuration through  $\widehat{\eta}_0$  and  $\widehat{\eta}_{e_i}$ . The same is true for the limit points of the positive boundary terms  $(\widetilde{R}_{n,i}^+)_{n \in \mathbb{N}}$ .*

*Proof of Lemma 5.23 :* This Lemma is a consequence of Lemma 5.22. Consider the localization  $\mathfrak{R}_{i,n}^- = \mathbb{E}_{\widehat{\alpha}}(\mathfrak{R}_i^- | \mathcal{F}_n)$ , then  $\mathfrak{R}_{i,n}^-$  also has the two previous properties : the measurability with respect to the sites in  $\{x_i > 0\} \cup \{0\}$  is trivial. The fact that its gradient vanish is easily obtained as well, since

$$\nabla_{z,z+e_j} \mathfrak{R}_{i,n}^- = \eta_z(1 - \eta_{z+e_j}) \mathbb{E}_{\widehat{\alpha}}(\mathfrak{R}_i^-(\widehat{\eta}^{z,z+e_j}) - \mathfrak{R}_i^-(\widehat{\eta}) | \mathcal{F}_n),$$

which vanishes since  $\mathfrak{R}_i^-(\widehat{\eta}^{z,z+e_j}) - \mathfrak{R}_i^-(\widehat{\eta})$  vanish by assumption as soon as  $\eta_z(1 - \eta_{z+e_j}) \neq 0$ . Let

$$B_{i,n}^+ = B_n \cap \mathbb{Z}_{+,i}^2,$$

since the gradients of  $\mathfrak{R}_i^-$  vanish for any edge in  $B_{i,n}^+$ , on the event on which there are at least two empty sites in  $B_{i,n}^+$ ,  $\mathfrak{R}_i^-$  only depends on the  $\widehat{\eta}_x$ ,  $x \in B_{i,n}^+$  through the empirical measure on  $B_{i,n}^+$

$$\widehat{\rho}_{B_{i,n}^+} := \frac{1}{|B_{i,n}^+|} \sum_{B_{i,n}^+} \eta_x \delta_{\theta_x}.$$

Indeed, for two configurations  $\widehat{\eta}$  and  $\widehat{\eta}'$  with the same number of particles, and with the same angles in  $B_{i,n}^+$ , we can reach one from the other with a combination of the previous gradients, hence the difference  $\mathfrak{R}_{i,n}^-(\widehat{\eta}) - \mathfrak{R}_{i,n}^-(\widehat{\eta}')$  vanishes. This is not true whenever there is one or less empty site in  $B_{i,n}^+$ , but since we are under the product measure, this happens with exponentially small probability and will not be an issue.

Let us denote by  $E_n^*$  the event "there are at least two empty sites in  $B_{i,n}^+$ ", the previous statement rewrites as

$$\mathfrak{R}_{i,n}^- \mathbb{1}_{E_n^*} = \mathbb{E}_{\widehat{\alpha}} \left( \mathfrak{R}_{i,n}^- \mathbb{1}_{E_n^*} \left| \widehat{\eta}_0, \widehat{\eta}_{e_i}, \widehat{\rho}_{B_{i,n}^+} \right. \right).$$

For any cylinder function  $f$ , we are going to prove that  $\mathbb{E}_{\widehat{\alpha}}(f \cdot \mathfrak{R}_i^-) = \mathbb{E}_{\widehat{\alpha}} \left[ f \cdot \mathbb{E}(\mathfrak{R}_i^- | \widehat{\eta}_0, \widehat{\eta}_{e_i}) \right]$ . Let

$$f_n = \mathbb{E}(f | \widehat{\eta}_x, x \in \{x_i > 0\} \cup \{0\})$$

be the conditional expectation with respect to the sites in  $\{x_i > 0\} \cup \{0\}$ . Since  $f$  is a cylinder function, so is  $f_n$ , therefore for any sufficiently large integer  $n$ , we can write

$$\begin{aligned} \mathbb{E}_{\widehat{\alpha}}(f \cdot \mathfrak{R}_i^- \mathbb{1}_{E_n^*}) &= \mathbb{E}_{\widehat{\alpha}}(f \cdot \mathfrak{R}_{i,n}^- \mathbb{1}_{E_n^*}) \\ &= \mathbb{E}_{\widehat{\alpha}} \left( \mathbb{E}_{\widehat{\alpha}} \left( f \cdot \mathfrak{R}_{i,n}^- \mathbb{1}_{E_n^*} \left| \widehat{\eta}_0, \widehat{\eta}_{e_i}, \widehat{\rho}_{B_{i,n}^+} \right. \right) \right) \\ &= \mathbb{E}_{\widehat{\alpha}} \left( \mathfrak{R}_{i,n}^- \mathbb{1}_{E_n^*} \mathbb{E}_{\widehat{\alpha}} \left( f \left| \widehat{\eta}_0, \widehat{\eta}_{e_i}, \widehat{\rho}_{B_{i,n}^+} \right. \right) \right) \end{aligned}$$

$$\begin{aligned}
&= \mathbb{E}_{\widehat{\alpha}} \left( \mathfrak{R}_{i,n}^- \mathbb{1}_{E_n^*} \mathbb{E}_{\widehat{\alpha}} \left( f_n \mid \widehat{\eta}_0, \widehat{\eta}_{e_i}, \widehat{\rho}_{B_{i,n}^+} \right) \right) \\
&= \mathbb{E}_{\widehat{\alpha}} \left( \mathfrak{R}_{i,n}^- \mathbb{E}_{\widehat{\alpha}} \left( f_n \mid \widehat{\eta}_0, \widehat{\eta}_{e_i}, \widehat{\rho}_{B_{i,n}^+} \right) \right) + \mathbb{E}_{\widehat{\alpha}} \left( \mathfrak{R}_{i,n}^- \mathbb{1}_{E_n^{*c}} \mathbb{E}_{\widehat{\alpha}} \left( f_n \mid \widehat{\eta}_0, \widehat{\eta}_{e_i}, \widehat{\rho}_{B_{i,n}^+} \right) \right) \\
&= \mathbb{E}_{\widehat{\alpha}} \left( \mathfrak{R}_i^- \mathbb{E}_{\widehat{\alpha}} \left( f_n \mid \widehat{\eta}_0, \widehat{\eta}_{e_i} \right) \right) + o_n(1), \tag{5.71}
\end{aligned}$$

since

$$\mathbb{E}_{\widehat{\alpha}} \left( f_n \mid \widehat{\eta}_0, \widehat{\eta}_{e_i}, \widehat{\rho}_{B_{i,n}^+} \right) \xrightarrow[n \rightarrow \infty]{L^2(\mu_{\widehat{\alpha}})} \mathbb{E}_{\widehat{\alpha}} \left( f_n \mid \widehat{\eta}_0, \widehat{\eta}_{e_i} \right),$$

because  $\rho_{B_{i,n}^+}$  converges  $\mu_{\widehat{\alpha}}$  a.s. as  $n \rightarrow \infty$  towards  $\widehat{\alpha}$ . and

$$\mathbb{E}_{\widehat{\alpha}} \left( \mathfrak{R}_{i,n}^- \mathbb{1}_{E_n^{*c}} \mathbb{E}_{\widehat{\alpha}} \left( f_n \mid \widehat{\eta}_0, \widehat{\eta}_{e_i}, \widehat{\rho}_{B_{i,n}^+} \right) \right) \xrightarrow[n \rightarrow \infty]{} 0,$$

because  $f_n$  is a bounded function, and  $\mathfrak{R}_{i,n}^-$  is in  $L^2(\mu_{\widehat{\alpha}})$ . For the same reason, the left-hand side in (5.71) converges as  $n$  goes to  $\infty$  towards  $\mathbb{E}_{\widehat{\alpha}}(f \cdot \mathfrak{R}_i^-)$ , and therefore

$$\mathbb{E}_{\widehat{\alpha}} \left( \mathfrak{R}_i^- \mathbb{E}_{\widehat{\alpha}} \left( f_n \mid \widehat{\eta}_0, \widehat{\eta}_{e_i} \right) \right) = \mathbb{E}_{\widehat{\alpha}}(f \cdot \mathfrak{R}_i^-) + o_n(1).$$

We finally obtain

$$\mathbb{E}_{\widehat{\alpha}}(f \cdot \mathfrak{R}_i^-) = \mathbb{E}_{\widehat{\alpha}} \left( \mathfrak{R}_i^- \mathbb{E}_{\widehat{\alpha}} \left( f_n \mid \widehat{\eta}_0, \widehat{\eta}_{e_i} \right) \right) + o_n(1) = \mathbb{E}_{\widehat{\alpha}} \left( f_n \mathbb{E}_{\widehat{\alpha}} \left( \mathfrak{R}_i^- \mid \widehat{\eta}_0, \widehat{\eta}_{e_i} \right) \right) + o_n(1),$$

from which we deduce what we wanted, since the previous is true for any cylinder function  $f$ , i.e. that

$$\mathfrak{R}_i^- = \mathbb{E}_{\widehat{\alpha}} \left( \mathfrak{R}_i^- \mid \widehat{\eta}_0, \widehat{\eta}_{e_i} \right).$$

This concludes the proof of Lemma 5.23. ■

To complete the proof of Lemma 5.18, now that we have proven that all limit points of the boundary terms are function of  $\widehat{\eta}_0$  and  $\widehat{\eta}_{e_i}$ , we still have to show that such limit points can be expressed as linear combination of the currents. To do so, first notice that any limit point of the negative boundary  $\mathfrak{R}_i^-$  verifies

$$\eta_{e_i} \mathfrak{R}_i^- = (1 - \eta_0) \mathfrak{R}_i^- = 0. \tag{5.72}$$

Indeed,

$$\eta_{e_i} \mathfrak{R}_i^- = \lim_{n \rightarrow \infty} \frac{1}{(2n)^2} \sum_{\substack{x_j = -n-1 \\ |x_j| \leq n, j \neq i}} \eta_{e_i} \tau_{-x} \nabla_{x, x+e_i} \widetilde{\varphi}_n = \lim_{n \rightarrow \infty} \frac{1}{(2n)^2} \sum_{\substack{x_j = -n-1 \\ |x_j| \leq n, j \neq i}} \eta_{e_i} \nabla_{0, e_i} \tau_{-x} \widetilde{\varphi}_n,$$

since  $\tau_x \nabla_a f = \nabla_{\tau_x a} \tau_x f$ . Now the latter obviously vanishes since  $\eta_{e_i} \nabla_{0, e_i} = 0$ . The second identity is proven in the same way.

Since the  $\widetilde{\varphi}_n$ 's are in  $T_0^\omega$ ,  $\mathfrak{R}_i^-$  also is, and can therefore be expressed as

$$\mathfrak{R}_i^-(\overline{\eta}) = \sum_x (c_1 \eta_x^\omega + c_2 \eta_x) \psi_x(\eta).$$

Injecting in this identity that  $\mathfrak{R}_i^-$  only depends on  $\widehat{\eta}_0$  and  $\widehat{\eta}_{e_i}$  yields  $\psi_x = 0$  for any  $x \neq 0, e_i$ . Furthermore, since  $\eta_{e_i} \mathfrak{R}_i^-$  vanishes, we also obtain that  $\psi_{e_i} = 0$ . Finally, we can write

$$\mathfrak{R}_i^-(\widehat{\eta}) = (c_1 \eta_0^\omega + c_2 \eta_0) \psi_0(\eta_0, \eta_{e_i}).$$

Since we must also have

$$\eta_{e_i} \psi_0(\eta_0, \eta_{e_i}) = (1 - \eta_0) \psi_0(\eta_0, \eta_{e_i}) = 0,$$

we obtain that  $\psi_0(\eta_0, \eta_{e_i})$  is proportional to  $\eta_0(1 - \eta_{e_i})$ , and finally,

$$\mathfrak{R}_i^-(\widehat{\eta}) = (c_1 \eta_0^\omega + c_2 \eta_0)(1 - \eta_{e_i}).$$

The previous equation states that the limiting boundary terms are in  $\mathfrak{F}^\omega$ , which is what we wanted to show. The proof of Lemma 5.18 is thus complete.  $\blacksquare$

## 5.7 Space-time covariance limit

In Section 5.5, we reduced our problem to a local covariance problem. The first part of this section introduces several notations as well as the limiting covariance  $\ll . \gg_{\widehat{\alpha}}$  which is the focus of the next section. Although it does not constitute a proof, the second part of this section provides some heuristic insight on the correspondence between closed forms and functions in  $C_0$ , as well as on the definition of  $\ll . \gg_{\widehat{\alpha}}$ . We will also use this section to introduce several notations that will be useful later.

In Section 5.5 we reduced the proof of equation (5.7) to proving Proposition 5.7, i.e. that

$$\inf_f \lim_{P \rightarrow \infty} \limsup_{l \rightarrow \infty} \sup_{\widehat{K} \in \widetilde{\mathbb{K}}_l} (2l + 1)^2 \mathbb{E}_{l, \widehat{K}} \left( \mathcal{W}_i^l (-\mathcal{L}_l)^{-1} \mathcal{W}_i^l \right) = 0,$$

where

$$\mathcal{W}_i^l = \langle j_i^\omega \rangle_0^l + d_s(\rho_l) \delta_i \rho_l^{\omega, P} + \mathfrak{d}(\rho_l, \rho_l^\omega) \delta_i \rho_l - \langle \mathcal{L}f \rangle_0^l$$

is the local average of the difference between gradients and currents,  $\mathfrak{d}$  is given by (1.12),  $\mathcal{L}_l$  is the symmetric exclusion generator restricted to  $B_l$ ,

$$\delta_i h = \tau_{e_i} h - h \tag{5.73}$$

is the discrete derivative in the direction  $e_i$ , and  $\widetilde{\mathbb{K}}_l$  was defined in (2.2) and only takes into account configurations with at least two empty sites.

To prove Proposition 5.7, we are now going to investigate the limit as  $l \rightarrow \infty$  and  $\widehat{\alpha}_{\widehat{K}_l} \rightarrow \widehat{\alpha}$  (cf Definition 2.2) of

$$\frac{1}{(2l + 1)^2} \mathbb{E}_{l, \widehat{K}_l} \left( \mathcal{L}_l^{-1} \sum_{x \in B_{l_\psi}} \tau_x \psi \cdot \sum_{x \in B_{l_\psi}} \tau_x \psi \right) := \ll \psi \gg_{\widehat{\alpha}}, \tag{5.74}$$

where  $\psi$  is supported by  $B_{d_\psi}$  and  $l_\psi = l - d_\psi - 1$  is chosen such that  $\sum_{x \in B_{l_\psi}} \tau_x \psi$  is measurable w.r.t. sites in  $B_l$ . There are therefore two important steps to prove (5.37) :

- Prove that the limit (5.74) is well-defined for any function  $\psi$  in a convenient class of functions containing at least the currents, the gradients and the functions of the type  $\mathcal{L}f$ .
- Prove that, letting

$$\mathfrak{d}(\widehat{\alpha}) = \frac{\mathbb{E}_{\widehat{\alpha}}(\eta_0^\omega)}{\alpha} (1 - d_s(\alpha)), \quad (5.75)$$

we have

$$\inf_f \sup_{\widehat{\alpha}} \ll j_i^\omega + d_s(\alpha) \delta_i(\eta_0^\omega \mathbb{1}_{E_p}) + \mathfrak{d}(\widehat{\alpha}) \delta_i \eta_0 - \mathcal{L}f \gg_{\widehat{\alpha}} = 0. \quad (5.76)$$

where the infimum is taken w.r.t. local functions with mean 0 w.r.t. all canonical measures.

### Introduction of the limiting covariance

In order to properly introduce the limiting covariance  $\ll \cdot \gg_{\widehat{\alpha}}$ , which we are going to define by a variational formula, let us recall some notations and introduce some others. Recall from equation (4.1) that we denote by  $C_0$ , the space of cylinder functions with mean zero w.r.t. every canonical measure and vanishing for any configuration with strictly less than two empty sites in their support, and by

$$T_0^\omega = \left\{ \sum_{x \in \mathbb{T}_N^2} (c_1 \eta_x^\omega + c_2 \eta_x) \psi_x(\eta), \quad c_1, c_2 \in \mathbb{R}, \text{ and } \psi_x \in \mathcal{S} \forall x \in \mathbb{T}_N^2 \right\}.$$

Furthermore, we introduce

$$\mathcal{T}_0^\omega = T_0^\omega \cap C_0. \quad (5.77)$$

Note in particular that these three sets are stable by the symmetric exclusion generator  $\mathcal{L}$ . This is trivial, since  $\mathcal{L}$  does not introduce correlations between angles.

For  $i = 1, 2$ , and  $x \in \mathbb{T}_N^2$ ,  $j_{x, x+e_i}^\omega$  is the instantaneous symmetric currents with angle dependency  $\omega$  along the edge  $(x, x + e_i)$  introduced in equation (1.17), where we want to replace the current

$$j_i^\omega = \eta_0^\omega (1 - \eta_{e_i}) - \eta_{e_i}^\omega (1 - \eta_0)$$

by the gradient quantity

$$\mathfrak{d}^\omega(\eta_{e_i}^\omega - \eta_0^\omega) + \mathfrak{d}(\eta_{e_i} - \eta_0).$$

Let  $j^\omega$  and  $j$  denote the two-dimensional random vectors

$$j^\omega = (j_1^\omega, j_2^\omega) \quad \text{and} \quad j = (j_1, j_2),$$

where  $j_i = \eta_0 - \eta_{e_i}$  is the total current along the edge  $(0, e_i)$ . Finally, for any  $a = (a_1, a_2)$  and  $b = (b_1, b_2) \in \mathbb{R}^2$ , we will write

$$j^{a,b} = a \cdot j^\omega + b \cdot j \in J^\omega, \quad (5.78)$$

where “ $\cdot$ ” is the usual scalar product in  $\mathbb{R}^2$  and  $J^\omega$  is the linear span of the currents already introduced in equation (4.2). We introduce analogous notations for germs of closed forms, and let

$$\mathfrak{i}^{a,b} = \sum_{i=1}^2 a_i \mathfrak{i}^{i,\omega} + b_i \mathfrak{i}^i \in \mathfrak{F}^\omega, \quad (5.79)$$



where  $\mathbf{j}^i$  and  $\mathbf{j}^{i,\omega}$  were introduced in (5.43), (5.44) and (5.46).

For  $g \in C_0$ , recall that  $\Sigma_g$  is the formal sum  $\Sigma_g = \sum_{x \in \mathbb{Z}^2} \tau_x g$ . This formal function's gradient along any particle jump is well-defined, as well as its expectation against any cylinder (therefore local) function in  $C_0$ . Finally, recall that  $\nabla_i = \nabla_{0,e_i}$  stands for the derivative in the direction  $e_i$  in the sense of equation (2.4),

$$\nabla_i f(\widehat{\eta}) = \eta_0 (1 - \eta_{e_i}) (f(\widehat{\eta}^{0,e_i}) - f(\widehat{\eta})),$$

we denote by  $\nabla f = (\nabla_1 f, \nabla_2 f)$  the two dimensional gradient vector of  $f$ .

We now have all the notations needed to introduce the limiting covariance  $\ll \cdot \gg_{\widehat{\alpha}}$ .

**Definition 5.24** (Definition of  $\ll \cdot \gg_{\widehat{\alpha}}$ ). *Let  $\widehat{\alpha} \in \mathcal{M}_1(\mathbb{S})$  be an angle measure, and consider  $f \in C_0$ , where  $C_0$  was defined in (4.1). In particular,  $f$  is a local function, and has mean 0 w.r.t. any grand canonical measure  $\mu_{\widehat{\alpha}}$ , and we can define*

$$\ll f \gg_{\widehat{\alpha}} = \sup_{\substack{g \in \mathcal{T}_0^\omega \\ a, b \in \mathbb{R}^2}} \left\{ 2\mathbb{E}_{\widehat{\alpha}} \left( f \cdot \left[ \Sigma_g + \sum_{y \in \mathbb{Z}^2} (y \cdot a) \eta_y^\omega + (y \cdot b) \eta_y \right] \right) - \|\nabla \Sigma_g + \mathbf{j}^{a,b}\|_{2,\widehat{\alpha}}^2 \right\}, \quad (5.80)$$

where  $\|\cdot\|_{2,\widehat{\alpha}}$  is the norm with which we provided the space of germs of closed forms (cf. Definition 5.11).

For any cylinder function  $\psi$ , recall that  $s_\psi$  is the smallest fixed integer such that  $\psi$  is measurable with respect to  $\mathcal{F}_{s_\psi}$ , and let  $l_\psi = l - d_\psi - 1$  for any integer  $l$  large enough. The following result states that the quantity  $\ll \cdot \gg_{\widehat{\alpha}}$  introduced in the previous Definition 5.24 is indeed the limit of (5.74) for any function  $\psi \in \mathcal{T}_0^\omega$ .

**Theorem 5.25.** *Consider  $\widehat{\alpha} \in \mathcal{M}_1(\mathbb{S})$ , and a sequence  $(\widehat{K}_l)_{l \in \mathbb{N}}$  such that  $\widehat{K}_l \in \mathbb{K}_l$  and  $\|\widehat{\alpha}_{\widehat{K}_l} - \widehat{\alpha}\| \rightarrow 0$ , where  $\widehat{\alpha}_{\widehat{K}_l} \in \mathcal{M}_1(\mathbb{S})$  is the angle measure defined in (2.7). Then, for any function  $\psi \in \mathcal{T}_0^\omega$ , we have*

$$\lim_{l \rightarrow \infty} \frac{1}{(2l+1)^2} \mathbb{E}_{l,\widehat{K}_l} \left( -\mathcal{L}_l^{-1} \sum_{x \in B_{l_\psi}} \tau_x \psi \cdot \sum_{x \in B_{l_\psi}} \tau_x \psi \right) = \ll \psi \gg_{\widehat{\alpha}}. \quad (5.81)$$

Furthermore, for any function  $\psi \in \mathcal{T}_0^\omega$ , the application  $\widehat{\alpha} \rightarrow \ll \psi \gg_{\widehat{\alpha}}$  is continuous in  $\widehat{\alpha}$ , and the convergence above is uniform in  $\widehat{\alpha}$ . In particular, for any  $\psi \in \mathcal{T}_0^\omega$ ,

$$\limsup_{l \rightarrow \infty} \sup_{\widehat{K}_l \in \mathbb{K}_l} \frac{1}{(2l+1)^2} \mathbb{E}_{l,\widehat{K}_l} \left( -\mathcal{L}_l^{-1} \sum_{x \in B_{l_\psi}} \tau_x \psi \cdot \sum_{x \in B_{l_\psi}} \tau_x \psi \right) = \sup_{\widehat{\alpha} \in \mathcal{M}_1(\mathbb{S})} \ll \psi \gg_{\widehat{\alpha}}. \quad (5.82)$$

**Remark 5.26.** *Although it is not clear from its definition,  $\ll \cdot \gg_{\widehat{\alpha}}^{1/2}$  is a norm on  $\mathcal{T}_0^\omega / \text{Ker} \ll \cdot \gg_{\widehat{\alpha}}$ . This is shown in Proposition 5.27. Assuming it is, however, we can define the corresponding inner product*

$$\ll \varphi, \psi \gg_{\widehat{\alpha}} = \frac{1}{4} (\ll \varphi + \psi \gg_{\widehat{\alpha}} - \ll \varphi - \psi \gg_{\widehat{\alpha}}),$$

and for any functions  $\varphi, \psi \in \mathcal{T}_0^\omega$ , the previous theorem then also yields that

$$\lim_{l \rightarrow \infty} \frac{1}{(2l+1)^2} \mathbb{E}_{l,\widehat{K}_l} \left( \sum_{x \in B_{l_\varphi}} \tau_x \varphi \cdot (-\mathcal{L}_l)^{-1} \sum_{y \in B_{l_\psi}} \tau_y \psi \right) = \ll \varphi, \psi \gg_{\widehat{\alpha}}.$$

The proof of Theorem 5.25 follows very closely the proof given in [KL99], we recall it in our case only for the sake of exhaustivity in Appendix C. The key to the proof is to divide  $B_l$  into boxes of size  $k$  which goes to infinity after  $l$ , in order to be able to replace the expectation w.r.t the canonical measure by the expectation w.r.t  $\mu_{\hat{\alpha}}$ . The rest of this section is dedicated to giving heuristic insight regarding the shape of  $\ll \cdot \gg_{\hat{\alpha}}$ , and why Theorem 5.25 should hold.

### Heuristic insight on Definition 5.24 and Theorem 5.25

The purpose of the second part of this Section is to explain the variational formula for the limiting covariance  $\ll \psi \gg_{\hat{\alpha}}$ . Given the generator  $\mathcal{L}$  of the SSEP on  $\mathbb{Z}^2$ , for any function  $f \in C_0$ , consider the linear application

$$\mathfrak{F} : f \mapsto \nabla \mathcal{L}^{-1} \Sigma_f = \begin{pmatrix} \nabla_1 \mathcal{L}^{-1} \Sigma_f \\ \nabla_2 \mathcal{L}^{-1} \Sigma_f \end{pmatrix}. \quad (5.83)$$

This definition raises a few questions. First of all, notice that it is not well-defined for any function  $f$  in  $C_0$  : indeed, even though  $f$  is a local cylinder function,  $\mathcal{L}^{-1}f$  is no longer local, therefore it is not sure that  $\nabla \mathcal{L}^{-1} \Sigma_f$  only involves a finite number of non-zero contribution. Second, the gradient in this expression, assuming that  $f$  is such that  $\nabla \mathcal{L}^{-1} \Sigma_f$  is well-defined, would indicate thanks to the "translation invariance" of  $\Sigma_f$  and  $\mathcal{L}^{-1}$ , that  $\mathfrak{F}(f)$  is the germ of a closed form as introduced in Section 5.6. To illustrate this last remark, we describe the effect of this application over two particular subsets of  $C_0$ , namely  $\mathcal{L}C_0$  and  $J^\omega$  introduced in (4.2).

We first investigate the action of  $\mathfrak{F}$  on the linear span of the currents  $J^\omega$ . Consider an infinite configuration  $\widehat{\eta}$  with no particles outside of some large compact set  $K$ . For the sake of concision, we will call such a configuration *bounded*. Then, we can write

$$\sum_{x \in \mathbb{Z}^2} x_i \mathcal{L} \eta_x^\omega = \sum_{x \in \mathbb{Z}^2} \tau_x J_i^\omega = \Sigma_{J_i^\omega}.$$

Since the configuration was assumed bounded, both of the sums above are finite, and the identity above is well posed. Coming back to our application  $\mathfrak{F}$ , the previous identity yields that

$$\mathfrak{F}(J_i^\omega) = \begin{pmatrix} \nabla_1 \mathcal{L}^{-1} \Sigma_{J_i^\omega} \\ \nabla_2 \mathcal{L}^{-1} \Sigma_{J_i^\omega} \end{pmatrix} = \begin{pmatrix} \nabla_1 \sum_{x \in \mathbb{Z}^2} x_i \eta_x^\omega \\ \nabla_2 \sum_{x \in \mathbb{Z}^2} x_i \eta_x^\omega \end{pmatrix}.$$

Since the only positive contributions in the right hand side above are for  $x \in \{0, e_i\}$ , elementary calculations yield

$$\mathfrak{F}(J_i^\omega) = \mathbf{j}^{i,\omega},$$

where the  $\mathbf{j}^{i,\omega}$ 's are the germs introduced in equation (5.46). For any bounded configuration, we can generalize this identity according to the notations (5.78) and (5.79), and obtain

$$\mathfrak{F}(J^{a,b}) = \mathbf{j}^{a,b}, \quad (5.84)$$

which once again holds for any bounded configuration. We can therefore expect that  $\mathfrak{F}$  maps  $J^\omega$  into  $\mathfrak{F}^\omega$ .

We now investigate the action of  $\mathfrak{F}$  on  $\mathcal{LC}_0$ . Another way to write  $\mathfrak{F}$  is  $\mathfrak{F}(f) = \nabla \Sigma_{\mathcal{L}^{-1}f}$ , and therefore

$$\mathfrak{F}(\mathcal{L}f) = \nabla \sum_{x \in \mathbb{Z}^2} \tau_x \mathcal{L}^{-1} \mathcal{L}f = \nabla \Sigma_f.$$

This allows us to define  $\mathfrak{F}$  on  $\mathcal{LC}_0$  as well, by

$$\mathfrak{F}(\mathcal{L}f) = \nabla \Sigma_f, \quad (5.85)$$

which is the germ of an exact form associated to  $f$ , and we can thus expect  $\mathfrak{F}$  to map  $\mathcal{LC}_0$  into the set of germs of exact forms  $\mathfrak{E}$  introduced in Definition 5.12.

The two constructions above allow us to define the bijective application

$$\begin{aligned} \mathfrak{F} &: \mathcal{LC}_0 + J^\omega \longrightarrow \mathfrak{E} + \mathfrak{F}^\omega \\ \mathcal{L}f + j^{a,b} &\mapsto \nabla \Sigma_f + \mathfrak{i}^{a,b}. \end{aligned}$$

Taking the closure of both spaces in  $L^2(\mu_{\widehat{\alpha}})$  and restricting to the subset  $\mathcal{T}_0^\omega \subset C_0$ , we obtain that the application  $\mathfrak{F}$  is a one-to-one mapping between  $\overline{\mathcal{LT}}_0^\omega + J^\omega$  and  $\mathfrak{E}_{\widehat{\alpha}} \cap \mathfrak{F}^\omega + \mathfrak{F}^\omega$ , where  $\overline{\mathcal{LT}}_0^\omega$  is the closure w.r.t.  $\ll \cdot \gg_{\widehat{\alpha}}^{1/2}$  of  $\mathcal{LT}_0^\omega$ . Note that taking the closure and restriction of  $J^\omega$  is not necessary, being a finite-dimension space included in  $T_0^\omega$ . Furthermore, we proved in Proposition 5.14 that

$$\mathfrak{E}_{\widehat{\alpha}} \cap \mathfrak{F}^\omega + \mathfrak{F}^\omega = \mathfrak{C}_{\widehat{\alpha}} \cap \mathfrak{F}^\omega.$$

We can therefore build an isomorphism

$$\mathfrak{F} : \overline{\mathcal{LT}}_0^\omega + J^\omega \longrightarrow \mathfrak{C}_{\widehat{\alpha}} \cap \mathfrak{F}^\omega. \quad (5.86)$$

Thanks to the isomorphism described in (5.86), this one-to-one mapping therefore gives  $\mathcal{T}_0^\omega / \text{Ker}_{\widehat{\alpha}}(\mathfrak{F})$  the same structure as  $\mathfrak{C}_{\widehat{\alpha}} \cap \mathfrak{F}^\omega$ . Denoting by  $\text{Ker}_{\widehat{\alpha}}(\mathfrak{F})$  the kernel of  $\mathfrak{F}$  w.r.t.  $\| \cdot \|_{2, \widehat{\alpha}}$  this mapping yields the decomposition

$$\frac{\mathcal{T}_0^\omega}{\text{Ker}_{\widehat{\alpha}}(\mathfrak{F})} = \frac{\overline{\mathcal{LT}}_0^\omega}{\text{Ker}_{\widehat{\alpha}}(\mathfrak{F})} \oplus J^\omega,$$

which is strictly analogous to the one stated in Proposition 5.14. However, this construction is purely heuristic, and its rigorous derivation is given a bit later in Proposition 5.32. This decomposition, however, is the reason why (5.76) should hold :  $\delta_i(\eta_0^\omega \mathbb{1}_{E_p})$  is a function in  $\mathcal{T}_0^\omega$ , and can therefore be written as a combination of the currents  $\delta_i \eta_0 = j_i$  and  $j_i^\omega$ , up to a perturbation  $\mathcal{L}f$ . The rigorous derivation of (5.76), and the derivation of the explicit form of the conductivity and diffusion coefficients is the purpose of Section 5.8.

We now explain further the variational formula for the limiting covariance  $\ll \cdot \gg_{\widehat{\alpha}}$  introduced in Definition 5.24. Let us now admit for a moment that  $\mathfrak{F}$  is well-defined on all  $\mathcal{T}_0^\omega$ , and takes its value in the set of germs of closed forms.  $\mathfrak{F}$  is now a surjective linear application  $\mathcal{T}_0^\omega \rightarrow \mathfrak{C}_{\widehat{\alpha}} \cap \mathfrak{F}^\omega$ . Recall that we endowed  $\mathfrak{C}_{\widehat{\alpha}}$  with its  $L^2$  norm

$$\|\mathbf{u}\|_{2, \widehat{\alpha}} = \left[ \mathbb{E}_{\widehat{\alpha}}(\mathbf{u}_1^2 + \mathbf{u}_2^2) \right]^{1/2}.$$

It can be rewritten for any closed form  $\mathbf{u} = (\mathbf{u}_1, \mathbf{u}_2) \in \mathfrak{C}_{\widehat{\alpha}} \cap \mathfrak{I}^\omega$ , as

$$\|\mathbf{u}\|_{2,\widehat{\alpha}}^2 = \sup_{\substack{g \in \mathcal{T}_0^\omega \\ a, b \in \mathbb{R}^2}} \left\{ 2\mathbb{E}_{\widehat{\alpha}} \left( \mathbf{u} \cdot (\nabla \Sigma_g + \mathbf{i}^{a,b}) \right) - \|\nabla \Sigma_g + \mathbf{i}^{a,b}\|_{2,\widehat{\alpha}}^2 \right\}, \quad (5.87)$$

since

$$\inf_{\substack{g \in \mathcal{T}_0^\omega \\ a, b \in \mathbb{R}^2}} \|\mathbf{u} - (\nabla \Sigma_g + \mathbf{i}^{a,b})\|_{2,\widehat{\alpha}}^2 = 0$$

according to Proposition 5.14.

Since  $\text{Ker}_{\widehat{\alpha}}(\mathfrak{F})$  is the kernel of  $\mathfrak{F}$  w.r.t  $\|\cdot\|_{2,\widehat{\alpha}}$ ,  $\mathfrak{F}$  is an isomorphism between  $\mathcal{T}_0^\omega / \text{Ker}_{\widehat{\alpha}}(\mathfrak{F})$  and  $\mathfrak{C}_{\widehat{\alpha}} \cap \mathfrak{I}^\omega$ , and we can therefore equip  $\mathcal{T}_0^\omega / \text{Ker}_{\widehat{\alpha}}(\mathfrak{F})$  with the norm  $\ll \cdot \gg_{\widehat{\alpha}}^{1/2}$  induced by the mapping  $\mathfrak{F}$ , defined as

$$\ll f \gg_{\widehat{\alpha}}^{1/2} = \|\mathfrak{F}(f)\|_{2,\widehat{\alpha}}.$$

Since  $\mathfrak{F}(f)$  was assumed to be the germ of a closed form, we can rewrite thanks to (5.87)

$$\ll f \gg_{\widehat{\alpha}} = \sup_{\substack{g \in \mathcal{T}_0^\omega \\ a, b \in \mathbb{R}^2}} \left\{ 2\mathbb{E}_{\widehat{\alpha}} \left( \mathfrak{F}(f) \cdot (\nabla \Sigma_g + \mathbf{i}^{a,b}) \right) - \|\nabla \Sigma_g + \mathbf{i}^{a,b}\|_{2,\widehat{\alpha}}^2 \right\}.$$

This expression for  $\ll \cdot \gg_{\widehat{\alpha}}$  is in fact identical to that given in Definition 5.24, once admitted that the correct expression in a general setting for  $\mathfrak{F}$  is (5.83), and that the integration by parts formula of Section 4.1 can be generalized. However, once again, this construction is not rigorous, and the correct definition for  $\ll \cdot \gg_{\widehat{\alpha}}$  is the one given in Definition 5.24.

We now briefly carry on with our heuristics and explain why Theorem 5.25 holds, which is rigorously proven in Appendix C. The proof is based on the integration by parts obtained in subsection 4.1. Applying it to  $\sum_{x \in B_{l_\psi}} \tau_x \psi$  yields that the quantity in the right-hand side of (5.81) can be rewritten

$$\lim_{l \rightarrow \infty} \frac{1}{(2l+1)^2} \mathbb{E}_{l, \widehat{K}_l} \left( \frac{1}{2} \sum_{\substack{x \in B_l \\ |z|=1}} \left[ \nabla_{x, x+z} \mathcal{L}_l^{-1} \sum_{x \in B_{l_\psi}} \tau_x \psi \right]^2 \right).$$

Assuming that one is able to replace  $\mu_{l, \widehat{K}_l}$  by the translation invariant grand canonical measure  $\mu_{\widehat{\alpha}}$ , and all quantities being ultimately translation invariant, this limit should be the same as

$$\begin{aligned} \lim_{l \rightarrow \infty} \frac{1}{(2l+1)^2} \mathbb{E}_{\widehat{\alpha}} \left( \frac{1}{2} \sum_{\substack{x \in B_l \\ |z|=1}} \left[ \nabla_{x, x+z} \mathcal{L}_l^{-1} \sum_{x \in B_{l_\psi}} \tau_x \psi \right]^2 \right) &= \lim_{l \rightarrow \infty} \mathbb{E}_{\widehat{\alpha}} \left( \sum_{i=1,2} \left[ \nabla_{0, e_i} \mathcal{L}_l^{-1} \sum_{x \in B_{l_\psi}} \tau_x \psi \right]^2 \right) \\ &= \|\mathfrak{F}(\psi)\|_{2,\widehat{\alpha}}^2 \\ &= \ll \psi \gg_{\widehat{\alpha}}. \end{aligned}$$

The rigorous proof of this result, however, is complicated due to the delicate nature of  $\mathcal{L}^{-1}$ . In the next section, we derive the diffusion and conductivity matrices, by investigating the properties of  $\ll \cdot \gg_{\widehat{\alpha}}$ .

## 5.8 Diffusion and drift coefficients

In this Section we derive the diffusion and conductivity coefficients given in Theorem 1.6, and conclude the proof of the limit (5.7). To do so, we investigate the properties of the semi-norm  $\ll \cdot \gg_{\widehat{\alpha}}^{1/2}$ , and the structure of the quotient of the set  $\mathcal{T}_0^\omega$  defined in equation (5.77) by the kernel of  $\ll \cdot \gg_{\widehat{\alpha}}$ .

In Section 5.5 we reduced the proof of equation 5.7 to proving Proposition 5.7, namely

$$\inf_f \lim_{p \rightarrow \infty} \limsup_{l \rightarrow \infty} \sup_{\widehat{K} \in \widehat{\mathbb{R}}_l} (2l+1)^2 \mathbb{E}_{l, \widehat{K}} \left( \mathcal{W}_i^l (-\mathcal{L}_l)^{-1} \mathcal{W}_i^l \right) = 0,$$

where

$$\mathcal{W}_i^l = \mathcal{W}_{i,p}^{f,l} = \langle j_i^\omega \rangle_0^{l'} + d_s(\rho_l) \delta_i \rho_{l_p}^{\omega,p} + \mathfrak{d}(\rho_l, \rho_l^\omega) \delta_i \rho_{l'} - \langle \mathcal{L}f \rangle_0^{l'f}.$$

Thanks to equation (5.82) of Theorem 5.25, we can also write

$$\limsup_{l \rightarrow \infty} \sup_{\widehat{K}} (2l+1)^2 \mathbb{E}_{l, \widehat{K}} \left( \mathcal{W}_{i,p}^{f,l} (-\mathcal{L}_l)^{-1} \mathcal{W}_{i,p}^{f,l} \right) = \sup_{\widehat{\alpha} \in \mathcal{M}_1(\mathbb{S})} \ll \mathcal{V}_{i,p}^f(\widehat{\alpha}) \gg_{\widehat{\alpha}},$$

with

$$\mathcal{V}_{i,p}^f(\widehat{\alpha}) = j_i^\omega + d_s(\alpha) \delta_i \eta_0^{\omega,p} + \mathfrak{d}(\widehat{\alpha}) \delta_i \eta_0 + \mathcal{L}f, \quad (5.88)$$

and  $\mathfrak{d}(\widehat{\alpha})$  is given by (5.75). The main result of this section is the estimate

$$\inf_{f \in \mathcal{C}_0} \lim_{p \rightarrow \infty} \sup_{\widehat{\alpha} \in \mathcal{M}_1(\mathbb{S})} \ll \mathcal{V}_{i,p}^f(\widehat{\alpha}) \gg_{\widehat{\alpha}} = 0, \quad (5.89)$$

which is stated at the end of the section in Proposition 5.38 and concludes the proof of equation (5.7), and thus the proof of Theorem 5.1.

Keeping the notations introduced in Section 5.7, we first investigate the properties of  $\ll \cdot \gg_{\widehat{\alpha}}$  introduced in Definition 5.24.

**Proposition 5.27.** *The quantity  $\ll \cdot \gg_{\widehat{\alpha}}^{1/2}$  defined in (5.80) is a semi-norm on the space  $\mathcal{T}_0^\omega$  (cf. (5.77)), and thus extends via the polarization identity into a semi-inner product on  $\mathcal{T}_0^\omega$ . Furthermore, let  $g$  and  $h$  be two functions in  $\mathcal{T}_0^\omega$ , and  $a, b \in \mathbb{R}^2$ . We have the following identities :*

$$\ll \mathcal{L}g, h \gg_{\widehat{\alpha}} = -\mathbb{E}_{\widehat{\alpha}}(\Sigma_g \cdot h), \quad (5.90)$$

$$\ll j^{a,b}, h \gg_{\widehat{\alpha}} = - \sum_{x \in \mathbb{Z}^2} [(a \cdot x) \mathbb{E}_{\widehat{\alpha}}(h \cdot \eta_x^\omega) + (b \cdot x) \mathbb{E}_{\widehat{\alpha}}(h \cdot \eta_x)], \quad (5.91)$$

and

$$\ll \mathcal{L}g + j^{a,b} \gg_{\widehat{\alpha}} = \|\nabla \Sigma_g + \mathbf{i}^{a,b}\|_{2, \widehat{\alpha}}^2. \quad (5.92)$$

where  $(a \cdot x)$  is the canonical scalar product on  $\mathbb{R}^2$ , and  $j^{a,b} = a \cdot j^\omega + b \cdot j$  was defined in (5.78).

**Remark 5.28.** *The following identities immediately derive from (5.92), and will be used numerous times throughout the proof :*

$$\ll j_i \gg_{\widehat{\alpha}} = \alpha(1 - \alpha), \quad \ll j_i^\omega \gg_{\widehat{\alpha}} = \mathbb{E}_{\widehat{\alpha}}(\omega^2) \alpha(1 - \alpha) \quad \text{and} \quad \ll j_i, j_i^\omega \gg_{\widehat{\alpha}} = \mathbb{E}_{\widehat{\alpha}}(\omega) \alpha(1 - \alpha).$$

*Proof of Proposition 5.27 :* Although this result is expected from the heuristic derivation of the variational formula for  $\ll \cdot \gg_{\hat{\alpha}}$ , its proof comes from Theorem 5.25. The fact that  $\ll \cdot \gg_{\hat{\alpha}}$  is a semi-norm is rather straightforward. Its positivity directly results from Theorem 5.25, as well as the homogeneity. The triangular inequality follows directly from the positivity.

We first prove equation (5.90). Let  $g, h \in \mathcal{T}_0^\omega$ , Theorem 5.25 yields

$$\ll \mathcal{L}g, h \gg_{\hat{\alpha}} = \lim_{l \rightarrow \infty} \frac{1}{(2l+1)^2} \mathbb{E}_{l, \widehat{K}_l} \left( (-\mathcal{L}_l^{-1}) \sum_{x \in B_{lg}} \tau_x \mathcal{L}g \cdot \sum_{y \in B_{lh}} \tau_y h \right).$$

Given the definition of  $l_g$ , for any  $x \in B_{lg}$ , we have  $\tau_x \mathcal{L}g = \mathcal{L}\tau_x g = \mathcal{L}_l \tau_x g$ , therefore the expectation in the right-hand side above is equal to

$$\mathbb{E}_{l, \widehat{K}_l} \left( \sum_{x \in B_{lg}} \tau_x g \cdot \sum_{y \in B_{lh}} \tau_y h \right) = \sum_{x \in B_{lg}} \mathbb{E}_{l, \widehat{K}_l} \left( \tau_x \left[ g \cdot \sum_{y \in B_{lh}} \tau_{y-x} h \right] \right).$$

Now let us fix some  $x \in \mathbb{Z}^2$ ,  $\mathbb{E}_{l, \widehat{K}_l} \left( \tau_x \left[ g \cdot \sum_{y \in B_{lh}} \tau_{y-x} h \right] \right)$  is equal for  $l$  large enough to  $\mathbb{E}_{l, \widehat{K}_l} (\tau_x [g \cdot \Sigma_h])$ . Therefore, it converges thanks to the translation invariance of  $\mu_{\hat{\alpha}}$  and the equivalence of ensembles stated in Proposition B.1 towards  $\mathbb{E}_{\hat{\alpha}}(g \Sigma_h)$  uniformly in  $x$ , which completes the proof of identity (5.90). Note that at no point did we use that  $g$  and  $h$  are in  $\mathcal{T}_0^\omega$ , we only used that  $g$  and  $h$  are in  $\mathcal{C}_0$ .

We now turn to equation (5.91), which is proved in the same way. Thanks to the elementary identities

$$\mathcal{L}_l \sum_{x \in B_l} x_i \eta_x^\omega = \sum_{x, x+e_i \in B_l} j_{x, x+e_i}^\omega \quad \text{and} \quad \mathcal{L}_l \sum_{x \in B_l} x_i \eta_x = \sum_{x, x+e_i \in B_l} j_{x, x+e_i},$$

we obtain

$$\ll j_i^\omega, h \gg_{\hat{\alpha}} = \lim_{l \rightarrow \infty} \frac{1}{(2l+1)^2} \mathbb{E}_{l, \widehat{K}_l} \left( (-\mathcal{L}_l^{-1}) \sum_{x, x+e_i \in B_l} j_{x, x+e_i}^\omega \cdot \sum_{x \in B_{lh}} \tau_x h \right) \quad (5.93)$$

$$= \lim_{l \rightarrow \infty} \frac{1}{(2l+1)^2} \mathbb{E}_{l, \widehat{K}_l} \left( \sum_{x \in B_l} x_i \eta_x^\omega \cdot \sum_{x \in B_{lh}} \tau_x h \right), \quad (5.94)$$

therefore once again using the equivalence of ensembles finally yields

$$\ll j_i^\omega, h \gg_{\hat{\alpha}} = - \sum_{x \in \mathbb{Z}^2} x_i \mathbb{E}_{\hat{\alpha}} (h \cdot \eta_x^\omega).$$

An analogous identity holds for  $j_i$ , which proves equation (5.91).

We now prove (5.92). Equations (5.90) and (5.91) yield

$$\ll \mathcal{L}g + j^{a,b} \gg_{\hat{\alpha}} = - \mathbb{E}_{\hat{\alpha}} \left( (\mathcal{L}g + j^{a,b}) \cdot \left[ \Sigma_g + \sum_{x \in \mathbb{Z}^2} (a \cdot x) \eta_x^\omega + (b \cdot x) \eta_x \right] \right), \quad (5.95)$$

we split the right-hand side above in two parts.

First, recall that we introduced in (5.79) the notation  $\mathbf{j}^{a,b}$ , we can rewrite for any  $l \geq s_g + 1$

$$\begin{aligned}
 \mathbb{E}_{\widehat{\alpha}} \left( \mathcal{L}g \cdot \left[ \Sigma_g + \sum_{x \in \mathbb{Z}^2} (a \cdot x) \eta_x^\omega + (b \cdot x) \eta_x \right] \right) \\
 &= -\frac{1}{2} \sum_{\substack{(y,y+z) \in B_l \\ |z|=1}} \mathbb{E}_{\widehat{\alpha}} \left( \nabla_{y,y+z} g \cdot \nabla_{y,y+z} \left[ \Sigma_g + \sum_{x \in \mathbb{Z}^2} (a \cdot x) \eta_x^\omega + (b \cdot x) \eta_x \right] \right) \\
 &\stackrel{(i)}{=} -\sum_{i=1}^2 \sum_{(y,y+e_i) \in B_l} \mathbb{E}_{\widehat{\alpha}} \left( \nabla_{y,y+e_i} g \cdot \nabla_{y,y+e_i} \left[ \Sigma_g + \sum_{x \in \mathbb{Z}^2} a_i x_i \eta_x^\omega + b_i x_i \eta_x \right] \right) \\
 &\stackrel{(ii)}{=} -\sum_{i=1}^2 \mathbb{E}_{\widehat{\alpha}} \left( \nabla_i \left[ \sum_{(y,y+e_i) \in B_l} \tau_{-y} g \right] \cdot (\nabla_i \Sigma_g + \mathbf{i}_i^{a,b}) \right) \\
 &= -\sum_{i=1}^2 \mathbb{E}_{\widehat{\alpha}} \left( \nabla_i \Sigma_g \cdot (\nabla_i \Sigma_g + \mathbf{i}_i^{a,b}) \right) \tag{5.96}
 \end{aligned}$$

with the following justifications :

(i) The change of variable  $\widehat{\eta} \mapsto \widehat{\eta}^{y,y+e_i}$  transforms  $\nabla_{y,y+e_i}$  into  $-\nabla_{y,y+e_i}$ , therefore

$$\sum_{\substack{(y,y+z) \in B_l \\ |z|=1}} \mathbb{E}_{\widehat{\alpha}} \left( \nabla_{y,y+z} f \nabla_{y+z,y} g \right) = 2 \sum_{y,y+e_i \in B_l} \mathbb{E}_{\widehat{\alpha}} \left( \nabla_{y,y+e_i} f \nabla_{y,y+e_i} g \right).$$

Finally, for any  $i \neq j$ ,

$$\nabla_{y,y+e_i} \sum_{x \in \mathbb{Z}^2} x_j \eta_x^\omega = \nabla_{y,y+e_i} \sum_{x \in \mathbb{Z}^2} x_j \eta_x = 0.$$

(ii) translation invariance of  $\mu_{\widehat{\alpha}}$ , as well as the elementary identities

$$\begin{aligned}
 \tau_{-x} \nabla_{x,x+e_i} g &= \nabla_i \tau_{-x} g, \\
 \nabla_{0,e_i} \sum_{x \in \mathbb{Z}^2} x_i \eta_x^\omega &= \eta_0^\omega (1 - \eta_{e_i}) = \mathbf{i}_i^{\omega,i} \quad \text{and} \quad \nabla_{0,e_i} \sum_{x \in \mathbb{Z}^2} x_i \eta_x = \eta_0 (1 - \eta_{e_i}) = \mathbf{i}_i^i.
 \end{aligned}$$

Regarding the second part of (5.95), for any function  $h$ , a change of variable  $\widehat{\eta} \mapsto \widehat{\eta}^{0,e_i}$  in the second part of  $j_i^\omega$  yields

$$\mathbb{E}_{\widehat{\alpha}} (j_i^\omega h) = -\mathbb{E}_{\widehat{\alpha}} \left( \eta_0^\omega (1 - \eta_{e_i}) (h(\widehat{\eta}^{0,e_i}) - h(\widehat{\eta})) \right) = -\mathbb{E}_{\widehat{\alpha}} (\mathbf{i}_i^{\omega,i} \cdot \nabla_{0,e_i} h).$$

Using the latter with  $h = \Sigma_g + \sum_{x \in \mathbb{Z}^2} (a \cdot x) \eta_x^\omega + (b \cdot x) \eta_x$ , and since  $\nabla_i \sum_{x \in \mathbb{Z}^2} x_i \eta_x^\omega = \eta_0^\omega (1 - \eta_{e_i})$ , we obtain

$$\mathbb{E}_{\widehat{\alpha}} \left( j_i^\omega \cdot \left( \Sigma_g + \sum_{x \in \mathbb{Z}^2} (a \cdot x) \eta_x^\omega + (b \cdot x) \eta_x \right) \right) = -\mathbb{E}_{\widehat{\alpha}} \left( \mathbf{i}_i^{\omega,i} \cdot (\nabla_i \Sigma_g + \mathbf{i}_i^{a,b}) \right).$$

A similar identity holds for  $j_i$ , therefore for any  $a$  and  $b$  in  $\mathbb{R}^2$ ,

$$\mathbb{E}_{\widehat{\alpha}} \left( j_i^{a,b} \cdot \left( \Sigma_g + \sum_{x \in \mathbb{Z}^2} (a \cdot x) \eta_x^\omega + (b \cdot x) \eta_x \right) \right) = -\mathbb{E}_{\widehat{\alpha}} \left( \mathbf{j}_i^{a,b} \cdot (\nabla \Sigma_g + \mathbf{j}_i^{a,b}) \right).$$

This last identity, together with (5.95) and (5.96), proves (5.92) and concludes the proof of Lemma 5.27.  $\blacksquare$

**Remark 5.29.** Let us denote by  $\mathcal{L}^{(i)}$  the part of the generator  $\mathcal{L}$  representing jumps in the  $i$ -th direction

$$\mathcal{L}^{(i)}f = \sum_x \sum_{\delta=\pm 1} \eta_x (1 - \eta_{x+\delta e_i}) (f(\widehat{\eta}^{x, x+\delta e_i}) - f(\widehat{\eta})).$$

Performing computations as in the proof of equation (5.96) yield

$$\ll \mathcal{L}^{(i)}f, \mathcal{L}f \gg_{\widehat{\alpha}} = \mathbb{E}_{\widehat{\alpha}} \left[ \left( \nabla_i \Sigma_f \right)^2 \right],$$

which means that for any given function  $f, g \in \mathcal{T}_0^\omega$ , and any  $a, b, c, d \in \mathbb{R}$  we can write thanks to (5.92) and to the definition of  $\|\cdot\|_{2, \widehat{\alpha}}^2$  (which splits the coordinates)

$$\ll a j_i^\omega + b j_i + \mathcal{L}^{(i)}f, c j_k^\omega + d j_k + \mathcal{L}^{(k)}g \gg_{\widehat{\alpha}} = \mathbb{1}_{i=k} \mathbb{E}_{\widehat{\alpha}} \left( \left[ a \mathbf{i}_i^i + b \mathbf{i}_i^{i, \omega} + \nabla_i \Sigma_f \right] \left[ c \mathbf{i}_k^k + d \mathbf{i}_k^{k, \omega} + \nabla_k \Sigma_g \right] \right).$$

Since the right-hand side above vanishes if  $i \neq k$ , we have for any  $i \neq k$

$$\ll \mathcal{L}^{(i)}f, \mathcal{L}^{(k)}g \gg_{\widehat{\alpha}} = 0. \quad (5.97)$$

**Remark 5.30.** Proposition 5.27 allows us, for any function  $h \in \mathcal{T}_0^\omega$ , to rewrite  $\ll h \gg_{\widehat{\alpha}}$ , according to its Definition 5.24 as

$$\ll h \gg_{\widehat{\alpha}} = \sup_{\substack{g \in \mathcal{T}_0^\omega \\ a, b \in \mathbb{R}^2}} \left\{ 2 \ll h, \mathcal{L}g + j^{a, b} \gg_{\widehat{\alpha}} - \ll \mathcal{L}g + j^{a, b} \gg_{\widehat{\alpha}} \right\}. \quad (5.98)$$

therefore for any  $h \in \mathcal{T}_0^\omega$ , we have

$$\inf_{\substack{g \in \mathcal{T}_0^\omega \\ a, b \in \mathbb{R}^2}} \ll h - (\mathcal{L}g + j^{a, b}) \gg_{\widehat{\alpha}} = 0.$$

Denote

$$\mathcal{N}_{\widehat{\alpha}} = \left\{ h \in \mathcal{T}_0^\omega, \ll h \gg_{\widehat{\alpha}} = 0 \right\}, \quad (5.99)$$

one can therefore expect that in the space  $\mathcal{T}_0^\omega / \mathcal{N}_{\widehat{\alpha}}$ , any function  $h$  can be ultimately written as  $\mathcal{L}g + j^{a, b}$ . However, proving that this decomposition is unique requires Corollary 5.31 below, we therefore postpone it for now.

Before carrying on with the proof, we set some more notations. We shorten

$$\mathbb{E}_{\widehat{\alpha}}(\omega) := \mathbb{E}_{\widehat{\alpha}}(\omega(\theta_0) \mid \eta_0 = 1) \quad \text{and} \quad \text{Var}_{\widehat{\alpha}}(\omega) := \text{Var}_{\widehat{\alpha}}(\omega(\theta_0) \mid \eta_0 = 1),$$

as well as  $\alpha_\omega = \mathbb{E}_{\widehat{\alpha}}(\eta_0^\omega) = \alpha \mathbb{E}_{\widehat{\alpha}}(\omega)$ . We also denote by

$$\chi^\omega = \mathbb{E}_{\widehat{\alpha}}\left((\eta_0^\omega)^2\right) - \mathbb{E}_{\widehat{\alpha}}(\eta_0^\omega)^2 = \alpha_{\omega^2} - (\alpha_\omega)^2$$

the variance of  $\eta_0^\omega$  w.r.t  $\mu_{\widehat{\alpha}}$ .



In the rest of the section, it will be convenient to express differently the gradient part of  $\mathcal{V}_{i,p}^f$ , defined in (5.88) : on the one hand, we want a term which is constant in  $\theta$  and on the other hand a mean 0 term which fluctuates in  $\theta$ . For this purpose, we define

$$\xi_x^p = \left( \omega(\theta_x) \mathbb{1}_{\tau_x E_p} - \mathbb{E}_{\widehat{\alpha}}(\omega) \right) \eta_x.$$

where

$$E_p = \left\{ \sum_{x \in B_p} \eta_x \leq |B_p| - 2 \right\}$$

is the event on which at least two sites are empty in  $B_p$ . Recall that

$$\delta_i \eta_0^{\omega,p} = \eta_{e_i}^{\omega} \mathbb{1}_{\tau_{e_i} E_p} - \eta_0^{\omega} \mathbb{1}_{E_p}.$$

The quantity  $\xi_x^p$  is defined so that

$$\delta_i \xi_0^p = \delta_i \eta_0^{\omega,p} + \mathbb{E}_{\widehat{\alpha}}(\omega) j_i, \quad (5.100)$$

therefore elementary computations and the expression (1.12) of  $\mathfrak{d}$  allow us to rewrite in (5.88)

$$\mathcal{V}_{i,p}^f(\widehat{\alpha}) = j_i^{\omega} + d_s(\alpha) \delta_i \xi_0^p + \mathbb{E}_{\widehat{\alpha}}(\omega) \delta_i \eta_0 + \mathcal{L}f. \quad (5.101)$$

Note that  $\xi^p$  depends on  $\widehat{\alpha}$  as well as  $\omega$ , but for the sake of clarity, we drop this dependency in our notation. The reason for this change of variable is explained later on in Remark 5.34.

We now state the following Corollary of Proposition 5.27.

**Corollary 5.31.** *Denote  $p' = (2p + 1)^2$  and*

$$P_p(\alpha) = 1 - \alpha^{p'-1} - (p' - 1)(1 - \alpha)\alpha^{p'-2},$$

*the probability for a binomial distribution with parameters  $p' - 1$  and  $1 - \alpha$  to be strictly more than 1. Recall that we introduced in (5.100) the gradient  $\delta_i \xi_0^p$ , for any integer  $p$  and any  $\widehat{\alpha}$  in  $\mathcal{M}_1(\mathbb{S})$ ,*

$$\ll \delta_i \xi_0^p, j^{a,b} \gg_{\widehat{\alpha}} = -a_i \alpha \text{Var}_{\widehat{\alpha}}(\omega) P_p(\alpha) + (\mathbb{E}_{\widehat{\alpha}}(\omega) a_i + b_i) \mathbb{E}_{\widehat{\alpha}}(\omega) (1 - \alpha) \alpha^{p'-1}. \quad (5.102)$$

*Furthermore, for any function  $g \in \mathcal{T}_0^{\omega}$ , and any cylinder function  $h \in T_0^{\omega}$ ,*

$$\ll \mathcal{L}g, \delta_i h \gg_{\widehat{\alpha}} = 0. \quad (5.103)$$

In other words, the last identity states that any gradient expression is orthogonal to any  $\mathcal{L}g$  w.r.t.  $\ll \cdot, \cdot \gg_{\widehat{\alpha}}$ . In particular, for any function  $g \in \mathcal{T}_0$ ,

$$\ll \mathcal{L}g, \delta_i \xi_0^p \gg_{\widehat{\alpha}} = 0 \quad \text{and} \quad \ll \mathcal{L}g, \delta_i \eta_0 \gg_{\widehat{\alpha}} = - \ll \mathcal{L}g, j_i \gg_{\widehat{\alpha}} = 0.$$

*Proof of Corollary 5.31 :* The proof follows from Proposition 5.27. We first treat the case where  $\widehat{\alpha}$  is such that  $\alpha = 0$  or  $\alpha = 1$ . In this case, all quantities vanish and the two identities are trivially true. We now assume that  $\alpha \in ]0, 1[$ .

We start with (5.103), which is a direct consequence of (5.85) : for any  $g \in \mathcal{T}_0$ ,

$$\ll \mathcal{L}g, \delta_i h \gg_{\widehat{\alpha}} = -\mathbb{E}_{\widehat{\alpha}}\left( (\tau_{e_i} h - h) \Sigma_g \right),$$

which vanishes thanks to the translation invariance of  $\mu_{\widehat{\alpha}}$  and  $\Sigma_g$ .

Thanks to Proposition 5.27, proving identity (5.102) is a matter of careful computation, and poses no special difficulty. First, equation (5.91) yields

$$\begin{aligned} \ll \delta_i \eta_0^{\omega,p}, j_k^\omega \gg_{\widehat{\alpha}} &= - \sum_{x \in \mathbb{Z}^2} x_k \mathbb{E}_{\widehat{\alpha}} \left( \delta_i \eta_0^{\omega,p} \cdot \eta_x^\omega \right) \\ &= \sum_{x \in \mathbb{Z}^2} x_k \mathbb{E}_{\widehat{\alpha}} \left( \left[ \eta_0^\omega \mathbb{1}_{E_p} - \eta_{e_i}^\omega \mathbb{1}_{\tau_{e_i} E_p} \right] \eta_x^\omega \right) \end{aligned}$$

If  $x \neq 0$ ,  $e_i$ , under the product measure  $\mu_{\widehat{\alpha}}$ , we have

$$\mathbb{E}_{\widehat{\alpha}} \left( \eta_0^\omega \mathbb{1}_{E_p} \eta_x^\omega \right) = \mathbb{E}_{\widehat{\alpha}} \left( \eta_{e_i}^\omega \mathbb{1}_{\tau_{e_i} E_p} \eta_x^\omega \right),$$

and the corresponding contribution vanishes, and the contribution in  $e_i$  vanishes if  $i \neq k$  for the same reason. The contribution for  $x = 0$  also vanishes because of the factor  $x_k$ . Finally, we can write

$$\ll \delta_i \eta_0^{\omega,p}, j_k^\omega \gg_{\widehat{\alpha}} = \mathbb{1}_{i=k} \mathbb{E}_{\widehat{\alpha}} \left( \left[ \eta_0^\omega \mathbb{1}_{E_p} - \eta_{e_i}^\omega \mathbb{1}_{\tau_{e_i} E_p} \right] \eta_{e_i}^\omega \right).$$

Writing  $\mathbb{1}_{E_p} = 1 - \mathbb{1}_{E_p^c}$ , this identity now becomes

$$\ll \delta_i \eta_0^{\omega,p}, j_k^\omega \gg_{\widehat{\alpha}} = \mathbb{1}_{i=k} \left( \mathbb{E}_{\widehat{\alpha}} \left( \left[ \eta_0^\omega - \eta_{e_i}^\omega \right] \cdot \eta_{e_i}^\omega \right) - \mathbb{E}_{\widehat{\alpha}} \left( \left[ \eta_0^\omega \mathbb{1}_{E_p^c} - \eta_{e_i}^\omega \mathbb{1}_{\tau_{e_i} E_p^c} \right] \eta_{e_i}^\omega \right) \right). \quad (5.104)$$

Following the same steps, we can also write

$$\ll \mathbb{E}_{\widehat{\alpha}}(\omega) j_i, j_k^\omega \gg_{\widehat{\alpha}} = -\mathbb{1}_{i=k} \mathbb{E}_{\widehat{\alpha}}(\omega) \mathbb{E}_{\widehat{\alpha}} \left( \left[ \eta_0 - \eta_{e_i} \right] \cdot \eta_{e_i}^\omega \right).$$

Since by definition  $\delta_i \xi_0^p = \delta_i \eta_0^{\omega,p} + \mathbb{E}_{\widehat{\alpha}}(\omega) j_i$  and  $\mathbb{E}_{\widehat{\alpha}}(\eta_x^\omega) = \mathbb{E}_{\widehat{\alpha}}(\omega) \mathbb{E}_{\widehat{\alpha}}(\eta_x)$ , taking the sum of those two identities finally yields

$$\ll \delta_i \xi_0^p, j_k^\omega \gg_{\widehat{\alpha}} = -\mathbb{1}_{i=k} \alpha \text{Var}_{\widehat{\alpha}}(\omega) - \mathbb{1}_{i=k} \mathbb{E}_{\widehat{\alpha}} \left( \left[ \eta_0^\omega \mathbb{1}_{E_p^c} - \eta_{e_i}^\omega \mathbb{1}_{\tau_{e_i} E_p^c} \right] \eta_{e_i}^\omega \right). \quad (5.105)$$

Furthermore, since the expectations is taken w.r.t. the product measure  $\mu_{\widehat{\alpha}}$ , the second term can be explicitly computed, and it is straightforward to obtain that

$$\mathbb{E}_{\widehat{\alpha}} \left( \left[ \eta_0^\omega \mathbb{1}_{E_p^c} - \eta_{e_i}^\omega \mathbb{1}_{\tau_{e_i} E_p^c} \right] \eta_{e_i}^\omega \right) = -\alpha \text{Var}_{\widehat{\alpha}}(\omega) \left( \alpha^{p'-1} + (p'-1)(1-\alpha)\alpha^{p'-2} \right) - \mathbb{E}_{\widehat{\alpha}}(\omega)^2 (1-\alpha)\alpha^{p'-1}. \quad (5.106)$$

We denote as stated in Corollary 5.31

$$P_p(\alpha) = 1 - \alpha^{p'-1} - (p'-1)(1-\alpha)\alpha^{p'-2},$$

which is the probability for a binomial distribution with parameters  $p'-1$  and  $1-\alpha$  to be strictly more than 1 and vanishes uniformly as soon as  $\widehat{\alpha}$  is bounded away from 1. With this notation and equations (5.105) and (5.106), we obtain as wanted

$$\ll \delta_i \xi_0^p, j_k^\omega \gg_{\widehat{\alpha}} = \mathbb{1}_{i=k} \left[ -\alpha \text{Var}_{\widehat{\alpha}}(\omega) P_p(\alpha) + \mathbb{E}_{\widehat{\alpha}}(\omega)^2 (1-\alpha)\alpha^{p'-1} \right]. \quad (5.107)$$

We can derive in the same way

$$\ll \delta_i \eta_0^{\omega,p}, j_k \gg_{\widehat{\alpha}} = \mathbb{1}_{i=k} (-\alpha_\omega (1-\alpha) + \mathbb{E}_{\widehat{\alpha}}(\omega) (1-\alpha)\alpha^{p'-1}),$$

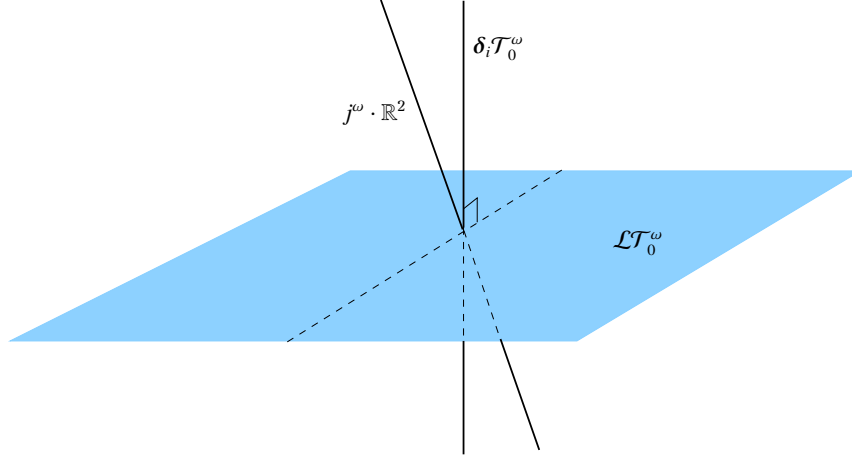

Figure 13: Representation of the different subspaces of  $\mathcal{H}_{\widehat{\alpha}}$  :  $\mathcal{L}\mathcal{T}_0^\omega$  is orthogonal to the set of microscopic gradients  $\delta_i \mathcal{T}_0^\omega$ , but not to the set of currents  $j^\omega \cdot \mathbb{R}^2$ .

and

$$\ll \mathbb{E}_{\widehat{\alpha}}(\omega) j_i, j_k \gg_{\widehat{\alpha}} = \mathbb{1}_{i=k} \mathbb{E}_{\widehat{\alpha}}(\omega) \alpha_\omega (1 - \alpha),$$

therefore, we also have

$$\ll \delta_i \xi_0^p, j_k \gg_{\widehat{\alpha}} = \mathbb{1}_{i=k} \left[ \mathbb{E}_{\widehat{\alpha}}(\omega) (1 - \alpha) \alpha^{p'-1} \right].$$

This, together with (5.107), concludes the proof of equation (5.102).  $\blacksquare$

Now that we have derived the main properties of  $\ll \cdot \gg_{\widehat{\alpha}}$ , we are ready to investigate the structure of  $\mathcal{T}_0^\omega$  with respect to this semi-norm. Let us denote

$$\mathcal{N}_{\widehat{\alpha}} = \text{Ker } \ll \cdot \gg_{\widehat{\alpha}},$$

$\ll \cdot \gg_{\widehat{\alpha}}^{1/2}$  is therefore a norm on  $\mathcal{T}_0^\omega / \mathcal{N}_{\widehat{\alpha}}$ . Letting  $\mathcal{H}_{\widehat{\alpha}}$  be the completion of  $\mathcal{T}_0^\omega / \mathcal{N}_{\widehat{\alpha}}$  with respect to  $\ll \cdot \gg_{\widehat{\alpha}}^{1/2}$ , we can now state the following result :

**Proposition 5.32.** *For any  $\widehat{\alpha} \in \mathcal{M}_1(\mathcal{S})$ ,  $(\mathcal{H}_{\widehat{\alpha}}, \ll \cdot \gg_{\widehat{\alpha}}^{1/2})$  is a Hilbert space, and the following decomposition holds :*

$$\mathcal{H}_{\widehat{\alpha}} = \frac{\overline{\mathcal{L}\mathcal{T}_0^\omega}}{\mathcal{N}_{\widehat{\alpha}}} \oplus J^\omega,$$

where  $\overline{\mathcal{L}\mathcal{T}_0^\omega} / \mathcal{N}_{\widehat{\alpha}}$  is the closure of  $\mathcal{L}\mathcal{T}_0^\omega / \mathcal{N}_{\widehat{\alpha}}$  w.r.t.  $\ll \cdot \gg_{\widehat{\alpha}}$  and  $J^\omega = j^\omega \cdot \mathbb{R}^2 + j \cdot \mathbb{R}^2 \subset \mathcal{T}_0^\omega$  is the linear span of the currents defined in equation (4.2).

This decomposition is represented in Figure 13

*Proof of Proposition 5.32 :* First note that if  $\alpha = 0$  or  $1$ ,  $\ll \cdot \gg_{\widehat{\alpha}} \equiv 0$  and therefore  $\mathcal{H}_{\widehat{\alpha}} = \{0\}$  is trivial. We now assume that  $\widehat{\alpha}$  is such that  $\alpha \in ]0, 1[$ .

Since we took the quotient by  $\mathcal{N}_{\widehat{\alpha}}$ , the fact that  $(\mathcal{H}_{\widehat{\alpha}}, \ll \cdot \gg_{\widehat{\alpha}}^{1/2})$  is a Hilbert space is immediate. The first inclusion

$$\mathcal{H}_{\widehat{\alpha}} \supset \frac{\overline{\mathcal{L}\mathcal{T}_0^\omega}}{\mathcal{N}_{\widehat{\alpha}}} \oplus J^\omega$$

is immediate, since  $\mathcal{L}\mathcal{T}_0^\omega \subset \mathcal{T}_0^\omega$  and since the currents are also in  $\mathcal{T}_0^\omega$ . Regarding the reverse inclusion, since  $\frac{\mathcal{L}\mathcal{T}_0^\omega}{N_{\widehat{\alpha}}} \oplus J^\omega$  is a closed linear subspace of  $\mathcal{H}_{\widehat{\alpha}}$ , we have

$$\mathcal{H}_{\widehat{\alpha}} = \left( \frac{\mathcal{L}\mathcal{T}_0^\omega}{N_{\widehat{\alpha}}} + J^\omega \right) \oplus \left( \frac{\mathcal{L}\mathcal{T}_0^\omega}{N_{\widehat{\alpha}}} + J^\omega \right)^\perp,$$

therefore we only need to prove that  $\left( \frac{\mathcal{L}\mathcal{T}_0^\omega}{N_{\widehat{\alpha}}} + J^\omega \right)^\perp = \{0\}$ . To do so, assume that there exists a function  $h \in \mathcal{T}_0^\omega$  such that  $\ll h, \mathcal{L}g + j^{a,b} \gg_{\widehat{\alpha}} = 0$ , then by (5.98), we obtain that  $\ll h \gg_{\widehat{\alpha}} = 0$ , therefore  $h = 0$  in  $\mathcal{H}_{\widehat{\alpha}}$ . The reverse inclusion thus holds.

To prove that the sum is direct, consider a function  $h$  in the intersection. Assume that

$$h = j^{a^h, b^h} = \mathcal{L}g_h$$

for some cylinder function  $g_h \in \mathcal{T}_0^\omega$  and  $a^h, b^h \in \mathbb{R}^2$ . Thanks to equation (5.103), we can thus write

$$\ll \delta_i \xi_0^p, h \gg_{\widehat{\alpha}} = \ll \delta_i \xi_0^p, j^{a^h, b^h} \gg_{\widehat{\alpha}} = \ll \delta_i \xi_0^p, \mathcal{L}g_h \gg_{\widehat{\alpha}} = 0.$$

Since we assumed that  $0 < \alpha < 1$ , this identity together with (5.102) yields in the limit  $p \rightarrow \infty$

$$a_i^h \alpha \text{Var}_{\widehat{\alpha}}(\omega) = 0. \quad (5.108)$$

- If  $\text{Var}_{\widehat{\alpha}}(\omega) = 0$ , in  $\mathcal{H}_{\widehat{\alpha}}$ ,  $j^\omega = \mathbb{E}_{\widehat{\alpha}}(\omega)j_i$ , therefore  $J^\omega = \mathbb{R}^2 \cdot j$  in  $\mathcal{H}_{\widehat{\alpha}}$ , which is orthogonal to  $\mathcal{L}\mathcal{T}_0^\omega$  according to (5.103), and the sum is direct.
- If  $\text{Var}_{\widehat{\alpha}}(\omega) \neq 0$ , and since we assumed  $\alpha \neq 0$ , (5.108) yields  $a_i^h = 0$ , therefore  $h = \mathcal{L}g_h = b^h \cdot j$ . According to (5.103),  $h$  is thus self-orthogonal, and vanishes.

In both cases, the sum is direct, which concludes the proof of Proposition 5.32.  $\blacksquare$

The next Proposition states that we can indeed write the currents  $j_i^\omega$  as combination of gradients, up to a function which takes the form  $\mathcal{L}g$ , and that the coefficients converge as  $p \rightarrow \infty$  to those given in (5.101).

**Proposition 5.33** (Decomposition of the currents). *Fix  $i \in 1, 2$  and  $\widehat{\alpha} \in \mathcal{M}_1(\mathbb{S})$ . For any  $p \in \mathbb{N}^*$ , there exists two coefficients  $c_p(\widehat{\alpha})$  and  $d_p(\widehat{\alpha}) \in \mathbb{R}$ , such that*

$$\inf_{g \in \mathcal{T}_0^\omega} \ll j_i^\omega + c_p(\widehat{\alpha})\delta_i \xi_0^p + d_p(\widehat{\alpha})\delta_i \eta_0 + \mathcal{L}g \gg_{\widehat{\alpha}} = 0. \quad (5.109)$$

Furthermore,

$$c_p(\widehat{\alpha}) \xrightarrow{p \rightarrow \infty} d_s(\alpha) \quad \text{and} \quad d_p(\widehat{\alpha}) \xrightarrow{p \rightarrow \infty} \mathbb{E}_{\widehat{\alpha}}(\omega), \quad (5.110)$$

and for any positive  $\epsilon$ , this convergence is uniform on

$$\mathcal{M}_\epsilon(\mathbb{S}) := \{ \widehat{\alpha} \in \mathcal{M}_1(\mathbb{S}), \quad \alpha < 1 - \epsilon \}.$$

Finally, any sequence  $(g_m)_m$  ultimately realizing (5.109) can be chosen independently of  $p$ , and also ultimately realizes

$$\inf_{g \in \mathcal{T}_0^\omega} \ll j_i^\omega + \mathcal{L}g \gg_{\widehat{\alpha}}. \quad (5.111)$$

**Remark 5.34.** We can now explain the reason behind the change of variable  $\delta_i \eta_0^{\omega,p} \mapsto \delta_i \xi^p$ . The basic idea is that even when  $\omega$  is not degenerate, for an infinite number of angle measures  $\widehat{\alpha} \in \mathcal{M}_1(\mathbb{S})$ , we may have  $\text{Var}_{\widehat{\alpha}}(\omega) = 0$ . To justify this statement, assume for example that for some arbitrary angles  $\theta$  and  $\theta'$ , we have  $\omega(\theta) = \omega(\theta')$ . Then, for any  $\alpha$  and  $\alpha'$  such that  $\alpha + \alpha' \leq 1$ , any measure  $\widehat{\alpha} = \alpha \delta_\theta + \alpha' \delta_{\theta'} \in \mathcal{M}_1(\mathbb{S})$  will verify  $\text{Var}_{\widehat{\alpha}}(\omega) = 0$ . Note that for any such  $\widehat{\alpha}$ , we can write in  $\mathcal{H}_{\widehat{\alpha}}$

$$j^\omega = \mathbb{E}_{\widehat{\alpha}}(\omega)j,$$

because  $\omega$  is constant w.r.t  $\widehat{\alpha}$ . Assuming then that there exists a decomposition

$$\delta_i \eta_0^{\omega,p} + a j_i + b j_i^\omega + \mathcal{L}f = 0$$

in  $\mathcal{H}_{\widehat{\alpha}}$ , this decomposition is by no means unique if  $\text{Var}_{\widehat{\alpha}}(\omega) = 0$ . This degenerate case poses some issues to invert this decomposition and obtain equation (5.109). More precisely, without the change of variable, writing

$$\inf_{g \in \mathcal{T}_0^\omega} \ll j_i^\omega + \widetilde{c}_p(\widehat{\alpha}) \delta_i \eta_0^{\omega,p} + \widetilde{d}_p(\widehat{\alpha}) \delta_i \eta_0 + \mathcal{L}g \gg_{\widehat{\alpha}} = 0,$$

both coefficients  $\widetilde{d}_p(\widehat{\alpha})$  and  $\widetilde{c}_p(\widehat{\alpha})$  can diverge as  $\text{Var}_{\widehat{\alpha}}(\omega) \rightarrow 0$ . In fact, however, these two infinite coefficients cancel out, and the system does not really degenerate as  $\text{Var}_{\widehat{\alpha}} \rightarrow 0$ . To circumvent this (apparent) issue, the "right" way to obtain coefficients  $c_p(\widehat{\alpha})$  and  $d_p(\widehat{\alpha})$  which are continuous in  $\widehat{\alpha}$  even when  $\text{Var}_{\widehat{\alpha}}(\omega) \rightarrow 0$  is to perform the change of variable  $\delta_i \eta_0^{\omega,p} \mapsto \delta_i \xi^p$ , which expresses  $j_i^\omega$  as a constant term in  $\theta$ , namely  $\mathbb{E}_{\widehat{\alpha}}(\omega)j_i$ , and a fluctuating term  $d_s(\alpha) \delta_i \xi_0^p$  with mean 0 in  $\theta$ , up to a perturbation  $\mathcal{L}f$ .

*Proof of Proposition 5.33 :* We start by proving the last statement, which is immediate and will be needed later on. Since the gradients are orthogonal to the  $\mathcal{L}g$ 's, we can rewrite for any  $g \in \mathcal{T}_0$  the quantity in (5.109) as

$$\begin{aligned} \ll j_i^\omega + c_p(\widehat{\alpha}) \delta_i \xi_0^p + d_p(\widehat{\alpha}) \delta_i \eta_0 + \mathcal{L}g \gg_{\widehat{\alpha}} &= \ll j_i^\omega + \mathcal{L}g \gg_{\widehat{\alpha}} \\ &+ 2 \ll j_i^\omega, c_p(\widehat{\alpha}) \delta_i \xi_0^p + d_p(\widehat{\alpha}) \delta_i \eta_0 \gg_{\widehat{\alpha}} + \ll c_p(\widehat{\alpha}) \delta_i \xi_0^p + d_p(\widehat{\alpha}) \delta_i \eta_0 \gg_{\widehat{\alpha}}. \end{aligned}$$

The second line does not depend on  $g$ , therefore any sequence which ultimately realizes the infimum of the first line of the right-hand side above also realizes the infimum of the left-hand side, and vice-versa, and such a sequence can be chosen independently of  $p$ , which proves the last statement.

We now turn to the main identity, namely (5.109). Once again, we start by clearing out the trivial cases when  $\widehat{\alpha}$  is such that  $\alpha = 0$  and  $\alpha = 1$ . In those, all quantities vanish and (5.109) and (5.110) are trivially true for  $c_p(\widehat{\alpha}) = d_s(\alpha)$  and  $d_p(\widehat{\alpha}) = \mathbb{E}_{\widehat{\alpha}}(\omega)$ . We now consider  $\widehat{\alpha} \in \mathcal{M}_1(\mathbb{S})$  such that  $\alpha \in ]0, 1[$ .

Fix  $p \in \mathbb{N}$ , we now prove that (5.109) holds for some well-chosen coefficients  $c_p$  and  $d_p$ . The function  $\delta_i \xi_0^p$  is in  $\mathcal{H}_{\widehat{\alpha}}$ , therefore according to Proposition 5.32, there exists  $a^p$  and  $b^p$  in  $\mathbb{R}^2$  such that,

$$\inf_{g \in \mathcal{T}_0^\omega} \ll \delta_i \xi_0^p + j^{a^p, b^p} + \mathcal{L}g \gg_{\widehat{\alpha}} = 0. \quad (5.112)$$

In order to clarify the proofs, we will sometimes assume that the infimum in  $g$  is reached, i.e. that there exists a function  $g_p \in \mathcal{T}_0^\omega$  such that

$$\ll \delta_i \xi_0^p + j^{a^p, b^p} + \mathcal{L}g_p \gg_{\widehat{\alpha}} = 0. \quad (5.113)$$

This assumption is purely for convenience, and we can substitute at any time to  $g^p$  a sequence of functions  $(g_m^p)_{m \in \mathbb{N}}$  such that the previous identity holds in the limit  $m \rightarrow \infty$ .

We first want to prove that the contribution of the currents in the direction  $k \neq i$  in the decomposition (5.113) vanishes. Consider some index  $k \neq i$ , we now show that  $a_k^p j_k^\omega + b_k^p j_k = 0$ . Recall that we introduced in Remark 5.29 the generator  $\mathcal{L}^{(i)}$  with jumps only in the direction  $i$ . We now take the inner product of the quantity in (5.113) with  $a_k^p j_k^\omega + b_k^p j_k + \mathcal{L}^{(k)} g_p$ , with respect to which  $\delta_i \xi_0^p$ ,  $j_i^\omega$ ,  $j_i$  and  $\mathcal{L}^{(i)} g_p$  are orthogonal according to Remark 5.29 and Corollary 5.31, and because  $i \neq k$ . This yields

$$\ll \delta_i \xi_0^p + j_i^{\omega, b^p} + \mathcal{L} g_p, a_k^p j_k^\omega + b_k^p j_k + \mathcal{L}^{(k)} g_p \gg_{\widehat{\alpha}} = \ll a_k^p j_k^\omega + b_k^p j_k + \mathcal{L}^{(k)} g_p \gg_{\widehat{\alpha}} = 0.$$

In the last identity, we obtained that some quantity of the form  $\mathcal{L}f$  is equal to a combination of currents. We can repeat the proof given in Proposition 5.32 that the sum of the two spaces was direct, to obtain that  $a_k^p j_k^\omega + b_k^p j_k = 0$ , which is what we wanted to prove.

We now drop our assumption that the infimum was reached. Since we proved that the currents in the direction  $k \neq i$  vanish, Equation (5.112) becomes

$$\inf_{g \in \mathcal{T}_0^\omega} \ll \delta_i \xi_0^p + a_i^p(\widehat{\alpha}) j_i^\omega + b_i^p(\widehat{\alpha}) j_i + \mathcal{L}g \gg_{\widehat{\alpha}} = 0. \quad (5.114)$$

We first consider the possibility that  $a_i^p(\widehat{\alpha}) = 0$ , and prove that it implies  $Var_{\widehat{\alpha}}(\omega) = 0$ . In this case, since both  $\delta_i \xi_0^p$  and  $j_i = -\delta_i \eta_0$  are orthogonal to  $\mathcal{L}g$  in  $\mathcal{H}_{\widehat{\alpha}}$  by equation (5.103), we could write

$$\ll \delta_i \xi_0^p + b_i^p(\widehat{\alpha}) j_i \gg_{\widehat{\alpha}} = 0.$$

Taking the inner product of this quantity w.r.t.  $j_i^\omega$  and  $j_i$ , we obtain according to Proposition 5.27 and Corollary 5.31 the two identities

$$-\alpha Var_{\widehat{\alpha}}(\omega) P_p(\widehat{\alpha}) + \alpha_\omega^2 (1 - \alpha) \alpha^{p'-3} + b_i^p(\widehat{\alpha}) \alpha_\omega (1 - \alpha) = 0 \quad \text{and} \quad \alpha_\omega (1 - \alpha) \alpha^{p'-2} + b_i^p(\widehat{\alpha}) \alpha (1 - \alpha).$$

Multiplying the second identity by  $\mathbb{E}_{\widehat{\alpha}}$  and subtracting it to the first, we obtain that  $a_i^p(\widehat{\alpha}) = 0$  if and only if

$$\alpha Var_{\widehat{\alpha}}(\omega) P_p(\widehat{\alpha}) = 0.$$

We already cleared out the special cases  $\alpha = 0$  and  $\alpha = 1$ , thus the only remaining possibility to have  $a_i^p = 0$  is  $Var_{\widehat{\alpha}}(\omega) = 0$ . We show at the end of the proof that if this is the case, the decomposition (5.109) is not unique, but one can choose the coefficients  $c_p$  and  $d_p$  so that (5.110) holds uniformly on  $\mathcal{M}_\epsilon(\mathbb{S})$ .

We can therefore assume that  $a_i^p \neq 0$  and since  $j_i = -\delta_i \eta_0$ , we can rewrite (5.114)

$$\inf_{g \in \mathcal{T}_0^\omega} \ll j_i^\omega + \frac{1}{a_i^p(\widehat{\alpha})} \delta_i \xi_0^p - \frac{b_i^p(\widehat{\alpha})}{a_i^p(\widehat{\alpha})} \delta_i \eta_0 + \mathcal{L}g \gg_{\widehat{\alpha}} = 0. \quad (5.115)$$

Denoting  $c_p(\widehat{\alpha}) = 1/a_i^p$  and  $d_p(\widehat{\alpha}) = -b_i^p/a_i^p$  proves equation (5.109).

We now prove that the coefficients  $c_p$  and  $d_p$  converge. Once again, we assume for convenience that the infimum in (5.109) is reached by a function  $g_p$  which allows us in particular to write

$$\ll j_i^\omega + c_p \delta_i \xi_0^p + d_p \delta_i \eta_0 + \mathcal{L}g_p, j_i^\omega + \mathcal{L}g_p \gg_{\widehat{\alpha}} = 0,$$

which is a restatement in  $\mathcal{H}_{\widehat{\alpha}}$  of  $\ll 0$ ,  $j_i^\omega + \mathcal{L}g_p \gg_{\widehat{\alpha}} = 0$ . Since by equation (5.109), the gradients are orthogonal to the currents, this identity can be rewritten

$$\ll j_i^\omega + \mathcal{L}g_p \gg_{\widehat{\alpha}} = -c_p \ll \delta_i \xi_0^p, j_i^\omega \gg_{\widehat{\alpha}} - d_p \ll \delta_i \eta_0, j_i^\omega \gg_{\widehat{\alpha}}.$$

Taking now the inner product of  $j_i^\omega + c_p \delta_i \xi_0^p + d_p \delta_i \eta_0 + \mathcal{L}g_p$  with  $j_i$ , we also obtain

$$\ll j_i^\omega + \mathcal{L}g_p, j_i \gg_{\widehat{\alpha}} = \ll j_i^\omega, j_i \gg_{\widehat{\alpha}} = -c_p \ll \delta_i \xi_0^p, j_i \gg_{\widehat{\alpha}} - d_p \ll \delta_i \eta_0, j_i \gg_{\widehat{\alpha}}.$$

These two identities can be written in matrix form, since we already established that the functions realizing the infimums (5.109) and (5.111) coincide,

$$\begin{pmatrix} \inf_{g \in \mathcal{T}_0^\omega} \ll j_i^\omega + \mathcal{L}g \gg_{\widehat{\alpha}} \\ \ll j_i^\omega, j_i \gg_{\widehat{\alpha}} \end{pmatrix} = A_p(\widehat{\alpha}) \begin{pmatrix} c_p(\widehat{\alpha}) \\ d_p(\widehat{\alpha}) \end{pmatrix}, \quad (5.116)$$

where

$$A_p(\widehat{\alpha}) = - \begin{pmatrix} \ll \delta_i \xi_0^p, j_i^\omega \gg_{\widehat{\alpha}} & \ll \delta_i \eta_0, j_i^\omega \gg_{\widehat{\alpha}} \\ \ll \delta_i \xi_0^p, j_i \gg_{\widehat{\alpha}} & \ll \delta_i \eta_0, j_i \gg_{\widehat{\alpha}} \end{pmatrix}.$$

Each coefficient of the matrix  $A_p(\widehat{\alpha})$  is explicitly known, according to Proposition 5.27 and Corollary 5.31, and we can therefore write

$$A_p(\widehat{\alpha}) = \begin{pmatrix} \alpha \text{Var}_{\widehat{\alpha}}(\omega) P_p(\alpha) - \mathbb{E}_{\widehat{\alpha}}(\omega)^2 (1-\alpha) \alpha^{p'-1} & \alpha_\omega (1-\alpha) \\ -\mathbb{E}_{\widehat{\alpha}}(\omega) (1-\alpha) \alpha^{p'-1} & \chi = \alpha(1-\alpha) \end{pmatrix}.$$

Elementary computations also yield

$$\text{Det}(A_p(\widehat{\alpha})) = \alpha^2 (1-\alpha) \text{Var}_{\widehat{\alpha}}(\omega) P_p(\alpha), \quad (5.117)$$

which is non-zero as soon as  $\alpha \neq 0, 1$  and  $\text{Var}_{\widehat{\alpha}}(\omega) \neq 0$ . If  $\widehat{\alpha}$  meets these two conditions, we can then rewrite equation (5.116) as

$$\begin{pmatrix} c_p(\widehat{\alpha}) \\ d_p(\widehat{\alpha}) \end{pmatrix} = A_p^{-1}(\widehat{\alpha}) \begin{pmatrix} \inf_{g \in \mathcal{T}_0^\omega} \ll j_i^\omega + \mathcal{L}g \gg_{\widehat{\alpha}} \\ \ll j_i^\omega, j_i \gg_{\widehat{\alpha}} \end{pmatrix}. \quad (5.118)$$

The matrix  $A_p^{-1}(\widehat{\alpha})$  is explicitly known, as well as  $\ll j_i^\omega, j_i \gg_{\widehat{\alpha}} = \alpha_\omega (1-\alpha)$ , therefore the only missing coefficient to compute  $c_p$  and  $d_p$  is  $\inf_{g \in \mathcal{T}_0^\omega} \ll j_i^\omega + \mathcal{L}g \gg_{\widehat{\alpha}}$ , which is given by the following Lemma.

**Lemma 5.35.** *For any  $\widehat{\alpha} \in \mathcal{M}_1(\mathbb{S})$ ,*

$$\inf_{g \in \mathcal{T}_0^\omega} \ll j_i^\omega + \mathcal{L}g \gg_{\widehat{\alpha}} = s^\omega(\widehat{\alpha}),$$

where the conductivity coefficient  $s^\omega$  is given by

$$s^\omega(\widehat{\alpha}) = \mathbb{E}_{\widehat{\alpha}}(\omega) \alpha_\omega (1-\alpha) + \alpha \text{Var}_{\widehat{\alpha}}(\omega) d_s(\alpha). \quad (5.119)$$

The proof of Lemma 5.35 is postponed for now, in order to complete the proof of Lemma 5.33. Thanks to Lemma 5.35, we can now rewrite (5.118) as

$$\begin{pmatrix} c_p(\widehat{\alpha}) \\ d_p(\widehat{\alpha}) \end{pmatrix} = \frac{1}{\text{Det}(A_p(\widehat{\alpha}))} \begin{pmatrix} \alpha(1-\alpha) & -\alpha\omega(1-\alpha) \\ \mathbb{E}_{\widehat{\alpha}}(\omega)(1-\alpha)\alpha^{p'-1} & \alpha \text{Var}_{\widehat{\alpha}}(\omega) P_p(\alpha) - \mathbb{E}_{\widehat{\alpha}}(\omega)^2(1-\alpha)\alpha^{p'-1} \end{pmatrix} \\ \times \begin{pmatrix} \mathbb{E}_{\widehat{\alpha}}(\omega)\alpha\omega(1-\alpha) + \alpha \text{Var}_{\widehat{\alpha}}(\omega) d_s(\alpha) \\ \alpha\omega(1-\alpha) \end{pmatrix}.$$

Using (5.117) for  $\text{Det}(A_p(\widehat{\alpha}))$ , computing the matrix product above finally yields

$$c_p(\widehat{\alpha}) = \frac{d_s(\alpha)}{P_p(\alpha)} \quad \text{and} \quad d_p(\widehat{\alpha}) = \mathbb{E}_{\widehat{\alpha}}(\omega) \left[ 1 + \frac{d_s(\alpha)\alpha^{p'-1}}{P_p(\alpha)} \right]. \quad (5.120)$$

In the cases where  $\alpha = 0$  or  $\text{Var}_{\widehat{\alpha}}(\omega) = 0$ , the matrix  $A_p$  is no longer invertible. However, we leave to the reader to verify that the coefficients  $c_p$  and  $d_p$  given by (5.120) are still solution of (5.116), even though this solution is not unique. In those cases, we can therefore choose  $c_p$  and  $d_p$  as in (5.120). This continuity as  $\text{Var}_{\widehat{\alpha}}(\omega)$  vanishes is, as explained in Remark 5.34, the reason for the change of variable  $\delta_i \eta_0^{\omega,p} \mapsto \delta_i \xi_0^p$ . Since  $P_p(\alpha)$  converges uniformly to 1 if  $\alpha$  is bounded away from 1,  $c_p$  and  $d_p$  converge uniformly on

$$\mathcal{M}_\epsilon(\mathbb{S}) := \{ \widehat{\alpha} \in \mathcal{M}_1(\mathbb{S}), \quad \alpha < 1 - \epsilon \},$$

towards  $d_s(\alpha)$  and  $\mathbb{E}_{\widehat{\alpha}}(\omega)$ , which completes the proof of Proposition 5.33.  $\blacksquare$

**Remark 5.36** (Stokes-Einstein Relation). *Letting  $p$  go to  $\infty$ , equation (5.116) becomes the Stokes-Einstein relation*

$$\begin{pmatrix} \inf_{g \in \mathcal{T}_0^\omega} \ll j_i^\omega + \mathcal{L}g \gg_{\widehat{\alpha}} \\ \inf_{g \in \mathcal{T}_0^\omega} \ll j_i + \mathcal{L}g \gg_{\widehat{\alpha}} \end{pmatrix} = \mathcal{X} \begin{pmatrix} d_s(\widehat{\alpha}) \\ \mathbb{E}_{\widehat{\alpha}}(\omega) \end{pmatrix}, \quad (5.121)$$

where  $\mathcal{X}$  is the compressibility of the system, and can be written as the limit  $p \rightarrow \infty$  of the matrix  $A_p$ ,  $d_s(\widehat{\alpha})$  and  $\mathbb{E}_{\widehat{\alpha}}(\omega)$  are the diffusion coefficients, and  $\inf_{g \in \mathcal{T}_0^\omega} \ll j_i^\omega + \mathcal{L}g \gg_{\widehat{\alpha}}$  and  $\inf_{g \in \mathcal{T}_0^\omega} \ll j_i + \mathcal{L}g \gg_{\widehat{\alpha}} = \alpha(1-\alpha)$  are the conductivity coefficients. Note that the diffusion and conductivity coefficients are not those presented in equation (1.12) because of our change of coordinates

$$\begin{pmatrix} \delta_i \eta_0^{\omega,p} \\ \delta_i \eta_0 \end{pmatrix} \mapsto \begin{pmatrix} \delta_i \xi_0^p \\ \delta_i \eta_0 \end{pmatrix}.$$

Note that the Stokes-Einstein relation is a matrix identity, and not a vector identity like (5.121). In fact, the matrix identity also holds, however we only wrote the part of the relation which was relevant in our context, the omitted part being trivial.

Before proving Lemma 5.35, we state the following elementary Corollary of Proposition 5.33.

**Corollary 5.37.** *There exists a constant  $C$  depending only on  $\omega$ , such that for any  $\widehat{\alpha} \in \mathcal{M}_1(\mathbb{S})$  and any integer  $p$ ,*

$$\ll \delta_i \xi_0^p \gg_{\widehat{\alpha}} \leq C.$$

*Proof of Corollary 5.37 :* The proof of this result follows directly from that of Proposition 5.33. We obtained in the latter that

$$\inf_{g \in \mathcal{T}_0^\omega} \ll \delta_i \xi_0^p + a^p(\widehat{\alpha}) j_i^\omega + b^p(\widehat{\alpha}) j_i + \mathcal{L}g \gg_{\widehat{\alpha}} = 0, \quad (5.122)$$



and by construction,  $c_p = 1/a^p$  and  $d_p = -b^p/a^p$ , where  $c_p$  and  $b_p$  are given for any  $\widehat{\alpha}$  such that  $\alpha \neq 1$  by (5.120).

Thanks to (5.120), this yields

$$a_p(\widehat{\alpha}) = \frac{P_p(\alpha)}{d_s(\alpha)} \quad \text{and} \quad b_p(\widehat{\alpha}) = \mathbb{E}_{\widehat{\alpha}}(\omega) \left[ \frac{P_p(\alpha)}{d_s(\alpha)} + \alpha^{p'-1} \right].$$

Elementary computations show that  $P_p(\alpha) = o_{\alpha \rightarrow 1}(1-\alpha)$ , and  $d_s(\alpha)$  is bounded from below by  $c(1-\alpha)$  according to Proposition A.3. We therefore obtain that if  $\alpha \neq 1$  both  $a_p(\widehat{\alpha})$  and  $b_p(\widehat{\alpha})$  are bounded uniformly in  $\widehat{\alpha}$  and  $p$  by some constant  $C'$  depending only on  $\omega$ .

Once again, we assume for the sake of clarity that the infimum (5.122) is reached by a function  $g_p$ . Since by (5.103)  $\delta_i \xi_0^p$  is orthogonal to  $\mathcal{L}g_p$ , we can write

$$\ll \delta_i \xi_0^p \gg_{\widehat{\alpha}} + \ll \mathcal{L}g_p \gg_{\widehat{\alpha}} = \ll \delta_i \xi_0^p + \mathcal{L}g_p \gg_{\widehat{\alpha}} = \ll a^p(\widehat{\alpha})j_i^\omega + b^p(\widehat{\alpha})j_i \gg_{\widehat{\alpha}}.$$

Since the coefficients  $a_p$  and  $b_p$  are bounded uniformly in  $\widehat{\alpha}$ , all quantities above being non-negative, we finally obtain that for any  $\widehat{\alpha}$  such that  $\alpha \neq 1$

$$\ll \delta_i \xi_0^p \gg_{\widehat{\alpha}} \leq a^p(\widehat{\alpha})^2 \ll j_i^\omega \gg_{\widehat{\alpha}} + b^p(\widehat{\alpha})^2 \ll j_i \gg_{\widehat{\alpha}} \quad (5.123)$$

$$\leq C(\omega). \quad (5.124)$$

Since when  $\alpha = 1$ ,  $\ll \delta_i \xi_0^p \gg_{\widehat{\alpha}} = 0$ , this concludes the proof of the Lemma.  $\blacksquare$

We now prove Lemma 5.35, whose proof was postponed.

*Proof of Lemma 5.35 :* Once again, we first consider the trivial case  $\alpha = 0$  or  $1$ . Since  $d_s(1) = 0$ , in the latter case, Lemma 5.35 is trivially true, because both sides of the identity vanish.

We now assume that  $\alpha \in ]0, 1[$ . Denote

$$\omega_0 = \omega - \mathbb{E}_{\widehat{\alpha}}(\omega),$$

and consider the mean-zero current

$$j_i^{\omega_0} = (\omega(\theta_0) - \mathbb{E}_{\widehat{\alpha}}(\omega))\eta_0(1 - \eta_{e_i}) - (\omega(\theta_{e_i}) - \mathbb{E}_{\widehat{\alpha}}(\omega))\eta_{e_i}(1 - \eta_0),$$

we have  $\ll j_i, j_i^{\omega_0} \gg_{\widehat{\alpha}} = 0$ . This last statement is a consequence of Proposition 5.27, which yields

$$\ll j_i, j_i^{\omega_0} \gg_{\widehat{\alpha}} = \underbrace{\mathbb{E}_{\widehat{\alpha}}(\omega_0)}_{=0} \ll j_i \gg_{\widehat{\alpha}} = 0.$$

Note that  $\omega_0$  depends on  $\widehat{\alpha}$ , but since in this proof  $\widehat{\alpha}$  is fixed in  $\mathcal{M}_1(\mathbb{S})$ , it is not an issue. Since  $j_i^\omega = j_i^{\omega_0} + \mathbb{E}_{\widehat{\alpha}}(\omega)j_i$ , we can now write

$$\begin{aligned} s^\omega &= \inf_{g \in \mathcal{T}_0^\omega} \ll j_i^\omega + \mathcal{L}g \gg_{\widehat{\alpha}} = \inf_{g \in \mathcal{T}_0^\omega} \ll \mathbb{E}_{\widehat{\alpha}}(\omega)j_i + j_i^{\omega_0} + \mathcal{L}g \gg_{\widehat{\alpha}} \\ &= \ll \mathbb{E}_{\widehat{\alpha}}(\omega)j_i \gg_{\widehat{\alpha}} + \inf_{g \in \mathcal{T}_0^\omega} \ll j_i^{\omega_0} + \mathcal{L}g \gg_{\widehat{\alpha}} \\ &= \mathbb{E}_{\widehat{\alpha}}(\omega)\alpha_\omega(1 - \alpha) + \inf_{g \in \mathcal{T}_0^\omega} \ll j_i^{\omega_0} + \mathcal{L}g \gg_{\widehat{\alpha}}. \end{aligned} \quad (5.125)$$

Note that the computation above guarantees that any sequence of functions  $g_m$  ultimately realizing  $\inf_g \ll j_i^\omega + \mathcal{L}g \gg_{\widehat{\alpha}}$  also realizes  $\inf_g \ll j_i^{\omega_0} + \mathcal{L}g \gg_{\widehat{\alpha}}$ .

In order to prove Lemma 5.35, it is therefore sufficient to show that

$$\inf_{g \in \mathcal{T}_0} \ll j_i^{\omega_0} + \mathcal{L}g \gg_{\widehat{\alpha}} = \alpha \text{Var}_{\widehat{\alpha}}(\omega) d_s(\alpha).$$

Recall from Proposition 5.27 that

$$\ll j^{a,b} + \mathcal{L}g \gg_{\widehat{\alpha}} = \|\mathbf{j}^{a,b} + \nabla \Sigma_g\|_{2,\widehat{\alpha}}^2,$$

therefore, since  $j_i^{\omega_0}$  is indeed of the form  $j^{a,b}$  for  $a = e_i$  and  $b = -\mathbb{E}_{\widehat{\alpha}}(\omega)e_i$  (here, we identified for the convenience of notations  $a$  and  $b$  with vectors of  $\mathbb{R}^2$ ),

$$\ll j_i^{\omega_0} + \mathcal{L}g \gg_{\widehat{\alpha}} = \mathbb{E}_{\widehat{\alpha}} \left( \sum_{i=1}^2 \left[ \eta_0^{\omega_0} (1 - \eta_{e_i}) + \nabla_i \sum_{x \in \mathbb{Z}^2} \tau_x g \right]^2 \right).$$

We now need to replace the gradient in the expression above by its symmetric counterpart. The right-hand side above rewrites

$$\begin{aligned} \mathbb{E}_{\widehat{\alpha}} \left( \left[ \eta_0^{\omega_0} (1 - \eta_{e_i}) + \nabla_i \sum_{x \in \mathbb{Z}^2} \tau_x g \right]^2 \right) &= \mathbb{E}_{\widehat{\alpha}} \left( \eta_0 (1 - \eta_{e_i}) \left[ \eta_0^{\omega_0} + \Sigma_g(\widehat{\eta}^{0,e_i}) - \Sigma_g \right]^2 \right) \\ &= \frac{1}{2} \mathbb{E}_{\widehat{\alpha}} \left( \eta_0 (1 - \eta_{e_i}) \left[ \eta_0^{\omega_0} + \Sigma_g(\widehat{\eta}^{0,e_i}) - \Sigma_g \right]^2 \right) \\ &\quad + \frac{1}{2} \mathbb{E}_{\widehat{\alpha}} \left( \eta_{e_i} (1 - \eta_0) \left[ \eta_{e_i}^{\omega_0} + \Sigma_g - \Sigma_g(\widehat{\eta}^{0,e_i}) \right]^2 \right), \end{aligned}$$

since  $\mathbb{E}_{\widehat{\alpha}}(f) = [\mathbb{E}_{\widehat{\alpha}}(f) + \mathbb{E}_{\widehat{\alpha}}(f(\widehat{\eta}^{0,e_i}))]/2$ . Furthermore, considering that only one of  $\eta_0(1 - \eta_{e_i})$  and  $\eta_{e_i}(1 - \eta_0)$  can be non-zero, and replacing  $\eta_0(1 - \eta_{e_i}) + \eta_{e_i}(1 - \eta_0)$  by  $\mathbb{1}_{\{\eta_0 \eta_{e_i} = 0\}}$  we can rewrite,

$$\ll j_i^{\omega_0} + \mathcal{L}g \gg_{\widehat{\alpha}} = \frac{1}{2} \mathbb{E}_{\widehat{\alpha}} \left( \mathbb{1}_{\{\eta_0 \eta_{e_i} = 0\}} \left[ \eta_{e_i}^{\omega_0} - \eta_0^{\omega_0} + \Sigma_g(\widehat{\eta}^{0,e_i}) - \Sigma_g \right]^2 \right). \quad (5.126)$$

Note that  $T_0^\omega$  can also be defined as

$$T_0^\omega = \left\{ \sum_{x \in \mathbb{Z}^2} (C_1 \eta_x^{\omega_0} + C_2 \eta_x) \psi_x(\eta), \quad C_1, C_2 \in \mathbb{R}, \text{ and } \psi_x \in \mathcal{S}, \quad \forall x \in \mathbb{T}_N^2 \right\},$$

therefore taking the infimum over  $g \in \mathcal{T}_0^\omega$  is equivalent to taking the infimum over  $C_1, C_2$ , and the family of angle-blind functions  $(\psi_x)_{x \in \mathbb{T}_N^2} \in (\mathcal{S} \cap C_0)^{\mathbb{T}_N^2}$ . Letting  $\widetilde{\nabla}_i$  denote the symmetric gradient

$$\widetilde{\nabla}_i f = \mathbb{1}_{\eta_0 \eta_{e_i} = 0} (f(\widehat{\eta}^{0,e_i}) - f),$$

(5.126) thus yields

$$\inf_{g \in \mathcal{T}_0^\omega} \ll j_i^{\omega_0} + \mathcal{L}g \gg_{\widehat{\alpha}} = \frac{1}{2} \inf_{C_1, C_2, \psi_x} \mathbb{E}_{\widehat{\alpha}} \left( \left[ \mathbb{1}_{\{\eta_0 \eta_{e_i} = 0\}} (\eta_{e_i}^{\omega_0} - \eta_0^{\omega_0}) + C_1 \widetilde{\nabla}_i \sum_{x, y \in \mathbb{Z}^2} \tau_y \eta_x^{\omega_0} \psi_x(\eta) \right]^2 \right) + \mathbb{E}_{\widehat{\alpha}} \left( \left[ C_2 \widetilde{\nabla}_i \sum_{x, y \in \mathbb{Z}^2} \tau_y \eta_x \psi_x(\eta) \right]^2 \right).$$

To split the two parts, we simply used that for any  $\widehat{\alpha} \in \mathcal{M}_1(\mathbb{S})$ , any  $x \in \mathbb{T}_N^2$ , and any angle-blind function  $\Psi$ ,  $\mathbb{E}_{\widehat{\alpha}}(\eta_x^{\omega_0} \Psi) = 0$  because the angular dependency of  $\eta^{\omega_0}$  in  $\theta_x$  has mean 0.

We now simply have to chose  $C_2 = 0$ , and notice that  $\sum_{x, y \in \mathbb{Z}^2} \tau_y \eta_x^{\omega_0} \psi_x(\eta) = \sum_{z \in \mathbb{Z}^2} \eta_z^{\omega_0} \tau_z \psi'(\eta)$  for the angle-blind formal sum  $\psi' = \sum_{y \in \mathbb{Z}^2} \psi_y \in \mathcal{S}$  (which is well-defined since only a finite number of terms are non-zero), to get that

$$\inf_{g \in \mathcal{T}_0^\omega} \ll j_i^{\omega_0} + \mathcal{L}g \gg_{\widehat{\alpha}} = \frac{1}{2} \inf_{\psi'} \mathbb{E}_{\widehat{\alpha}} \left( \left[ \mathbb{1}_{\{\eta_0 \eta_{e_i} = 0\}} (\eta_{e_i}^{\omega_0} - \eta_0^{\omega_0}) + \widetilde{\nabla}_i \sum_{z \in \mathbb{Z}^2} \eta_z^{\omega_0} \tau_z \psi'(\eta) \right]^2 \right).$$

We take the terms  $z = 0$  and  $z = e_i$  out of the sum, the right-hand side above is equal to

$$\frac{1}{2} \inf_{\psi'} \mathbb{E}_{\widehat{\alpha}} \left( \left[ \mathbb{1}_{\{\eta_0 \eta_{e_i} = 0\}} (\eta_{e_i}^{\omega_0} - \eta_0^{\omega_0}) + \widetilde{\nabla}_i \eta_0^{\omega_0} \psi' + \widetilde{\nabla}_i \eta_{e_i}^{\omega_0} \tau_{e_i} \psi' + \widetilde{\nabla}_i \sum_{z \in \mathbb{Z}^2 \setminus \{0, e_i\}} \eta_z^{\omega_0} \tau_z \psi' \right]^2 \right). \quad (5.127)$$

For any  $z \in \mathbb{Z}^2 \setminus \{0, e_i\}$ ,  $\widetilde{\nabla}_i \eta_z^{\omega_0} \tau_z \psi'$  is equal to  $\eta_z^{\omega_0} \widetilde{\nabla}_i \tau_z \psi'$ . Furthermore,

$$\widetilde{\nabla}_i \eta_0^{\omega_0} \psi' = \mathbb{1}_{\eta_0 \eta_{e_i} = 0} (\eta_{e_i}^{\omega_0} \psi'(\widehat{\eta}^{0, e_i}) - \eta_0^{\omega_0} \psi'),$$

and

$$\widetilde{\nabla}_i \eta_{e_i}^{\omega_0} \tau_{e_i} \psi' = \mathbb{1}_{\eta_0 \eta_{e_i} = 0} (\eta_0^{\omega_0} \tau_{e_i} \psi'(\widehat{\eta}^{0, e_i}) - \eta_{e_i}^{\omega_0} \tau_{e_i} \psi').$$

Regrouping the terms in  $\eta_{e_i}^{\omega_0}$  and  $\eta_0^{\omega_0}$ , (5.127) is equal to

$$\frac{1}{2} \inf_{\psi'} \mathbb{E}_{\widehat{\alpha}} \left( \mathbb{1}_{\{\eta_0 \eta_{e_i} = 0\}} \left( \eta_{e_i}^{\omega_0} [1 + \psi'(\widehat{\eta}^{0, e_i}) - \tau_{e_i} \psi'] + \eta_0^{\omega_0} [-1 + \tau_{e_i} \psi'(\widehat{\eta}^{0, e_i}) - \psi'] + \sum_{z \in \mathbb{Z}^2 \setminus \{0, e_i\}} \eta_z^{\omega_0} \widetilde{\nabla}_i \tau_z \psi' \right)^2 \right).$$

For any  $z \neq z'$  and any angle-blind function  $\psi \in \mathcal{S}$ , we have already established in Section 4.2 that

$$\mathbb{E}_{\widehat{\alpha}}(\eta_z^{\omega_0} \eta_{z'}^{\omega_0} \psi(\eta)) = 0.$$

The previous quantity now rewrites

$$\inf_{g \in \mathcal{T}_0^\omega} \ll j_i^{\omega_0} + \mathcal{L}g \gg_{\widehat{\alpha}} = \frac{1}{2} \inf_{\psi'} \sum_i \mathbb{E}_{\widehat{\alpha}} \left( (1 - \eta_0) \eta_{e_i}^{\omega_0 2} [1 + \psi'(\widehat{\eta}^{0, e_i}) - \tau_{e_i} \psi']^2 \right) + \mathbb{E}_{\widehat{\alpha}} \left( (1 - \eta_{e_i}) \eta_0^{\omega_0 2} [-1 + \tau_{e_i} \psi'(\widehat{\eta}^{0, e_i}) - \psi']^2 \right) + \sum_{z \in \mathbb{Z}^2 \setminus \{0, e_i\}} \mathbb{E}_{\widehat{\alpha}} \left( \mathbb{1}_{\{\eta_0 \eta_{e_i} = 0\}} \eta_z^{\omega_0 2} [\widetilde{\nabla}_i \tau_z \psi']^2 \right).$$

We translate the first term by  $-e_i$ , thanks to the translation invariance of  $\mathbb{E}_{\widehat{\alpha}}$ , the former is equal to

$$\begin{aligned} & \frac{1}{2} \inf_{\psi'} \mathbb{E}_{\widehat{\alpha}} \left( (1 - \eta_{-e_i}) \eta_0^{\omega_0^2} \left[ 1 + \tau_{-e_i} \left[ \psi' \left( \widehat{\eta}^{0,e_i} \right) \right] - \psi' \right]^2 \right) \\ & + \mathbb{E}_{\widehat{\alpha}} \left( (1 - \eta_{e_i}) \eta_0^{\omega_0^2} \left[ -1 + \tau_{e_i} \psi' \left( \widehat{\eta}^{0,e_i} \right) - \psi' \right]^2 \right) + \sum_{z \in \mathbb{Z}^2 \setminus \{0, e_i\}} \mathbb{E}_{\widehat{\alpha}} \left( \mathbb{1}_{\{\eta_0 \eta_{e_i} = 0\}} \eta_z^{\omega_0^2} \left[ \widetilde{\nabla}_i \tau_z \psi' \right]^2 \right). \end{aligned}$$

Notice that with respect to  $\psi$ , we only place on the event  $\eta_0^{\omega_0} \neq 0$ , (since the last term is translated by  $z$ ), we can hence only consider the functions  $\psi$  independent of  $\eta_0$ . With that condition,  $\psi' \left( \widehat{\eta}^{0,e_i} \right)$  is independent of  $\eta_{e_i}$ , therefore  $\tau_{-e_i} \left[ \psi' \left( \widehat{\eta}^{0,e_i} \right) \right]$  is independent of  $\eta_0$ . We also have  $\tau_{e_i} \psi'$  is independent of  $\eta_{e_i}$ , and  $\tau_{e_i} \psi' \left( \widehat{\eta}^{0,e_i} \right)$  is also independent of  $\eta_0$ . Finally,  $\widetilde{\nabla}_i \tau_z \psi'$  is independent of  $\eta_z$ . Elementary computations yield

$$\mathbb{E}((\eta_0^{\omega_0})^2) = \alpha \text{Var}_{\widehat{\alpha}}(\omega),$$

and because the two directions  $i = 1$  and  $i = 2$  are orthogonal in  $\mathcal{H}_{\widehat{\alpha}}$  and play identical roles, the previous quantity now becomes

$$\begin{aligned} \inf_{f \in \mathcal{T}_0^\omega} \ll j_i^{\omega_0} + \mathcal{L}f \gg_{\widehat{\alpha}} &= \frac{1}{2} \inf_{f \in \mathcal{T}_0^\omega} \ll \sum_{k=1}^2 j_k^{\omega_0} + \mathcal{L}f \gg_{\widehat{\alpha}} \\ &= \frac{\alpha \text{Var}_{\widehat{\alpha}}(\omega)}{4} \inf_{\psi'} \left\{ \sum_i \mathbb{E}_{\widehat{\alpha}} \left( (1 - \eta_{-e_k}) \left[ 1 + \tau_{-e_k} \left[ \psi' \left( \widehat{\eta}^{0,e_k} \right) \right] - \psi' \right]^2 \right) \right. \\ & \quad \left. + \mathbb{E}_{\widehat{\alpha}} \left( (1 - \eta_{e_k}) \left[ -1 + \tau_{e_k} \psi' \left( \widehat{\eta}^{0,e_k} \right) - \psi' \right]^2 \right) + \sum_{z \in \mathbb{Z}^2 \setminus \{0, e_k\}} \mathbb{E}_{\widehat{\alpha}} \left( \mathbb{1}_{\{\eta_0 \eta_{e_k} = 0\}}^2 \left[ \widetilde{\nabla}_k \tau_z \psi' \right]^2 \right) \right\} \\ &= \alpha \text{Var}_{\widehat{\alpha}}(\omega) d_s(\alpha), \end{aligned}$$

where  $d_s$  is the self-diffusion coefficient for which a variational formula is given in Proposition A.2. This completes the proof of Lemma 5.35.  $\blacksquare$

We now prove equation (5.89), and thus concludes the proof of Theorem 5.1.

**Proposition 5.38.** *Identity (5.89) holds, in the sense that*

$$\inf_{g \in \mathcal{C}_0} \lim_{p \rightarrow \infty} \sup_{\widehat{\alpha} \in \mathcal{M}_1(\mathbb{S})} \ll j_i^\omega + d_s(\alpha) \delta_i \xi_0^p + \mathbb{E}_{\widehat{\alpha}}(\omega) \delta_i \eta_0 + \mathcal{L}g \gg_{\widehat{\alpha}} = 0.$$

*Proof of Proposition 5.38:* There are two important steps to prove Proposition 5.38. First, for any density  $\widehat{\alpha} \in \mathcal{M}_1(\mathbb{S})$ , according to Proposition 5.33, a local function  $g_{\widehat{\alpha}} \in \mathcal{T}_0^\omega$  such that

$$\ll j_i^\omega + c_p(\widehat{\alpha}) \delta_i \xi_0^p + d_p(\widehat{\alpha}) \delta_i \eta_0 + \mathcal{L}g_{\widehat{\alpha}} \gg_{\widehat{\alpha}} \leq \delta.$$

However, since this function depends on  $\widehat{\alpha}$ , we still need to construct a cylinder function independent of  $\widehat{\alpha}$  which satisfies (5.89).

Furthermore, the diffusion coefficients are not those wanted in Proposition 5.38, and  $c_p(\widehat{\alpha})$  and  $d_p(\widehat{\alpha})$  do not converge uniformly towards  $d_s(\alpha)$  and  $\mathbb{E}_{\widehat{\alpha}}(\omega)$  on  $\mathcal{M}_1(\mathbb{S})$ . This won't be an issue, however, because the quantity above vanishes as  $\alpha$  goes to 1 regardless of the diffusion coefficients, and because according to Proposition 5.33, the convergence is uniform on

$$\mathcal{M}_\epsilon(\mathbb{S}) = \{\widehat{\alpha} \in \mathcal{M}_1(\mathbb{S}), \quad \alpha < 1 - \epsilon\},$$

for any  $\epsilon$ .

The proof being a little bit intricate due to the degenerate case  $\alpha \rightarrow 1$ , we split it in two Lemmas.

**Lemma 5.39.** *For any  $\delta > 0$  there exists a cylinder function  $f_\delta \in C_0$  such that for any  $\epsilon > 0$*

$$\lim_{p \rightarrow \infty} \sup_{\widehat{\alpha} \in \mathcal{M}_\epsilon(\mathbb{S})} \ll j_i^\omega + c_p(\widehat{\alpha})\delta_i \xi_0^p + d_p(\widehat{\alpha})\delta_i \eta_0 + \mathcal{L}f_\delta \gg_{\widehat{\alpha}} \leq 3\delta.$$

Furthermore, there exists a constant  $C$  such that for any  $\widehat{\alpha} \in \mathcal{M}_1(\mathbb{S})$ ,

$$\left| \ll j_i^\omega + \mathcal{L}f_\delta \gg_{\widehat{\alpha}} - \inf_{g \in \mathcal{F}_0^\omega} \ll j_i^\omega + \mathcal{L}g \gg_{\widehat{\alpha}} \right| \leq C\delta. \quad (5.128)$$

**Lemma 5.40.** *For any  $\delta > 0$ , consider the cylinder function  $f_\delta$  defined by Lemma 5.39, there exists  $\epsilon = \epsilon_\delta > 0$  such that*

$$\lim_{p \rightarrow \infty} \sup_{\widehat{\alpha} \in \mathcal{M}_1(\mathbb{S}) \setminus \mathcal{M}_\epsilon(\mathbb{S})} \ll j_i^\omega + d_s(\alpha)\delta_i \xi_0^p + \mathbb{E}_{\widehat{\alpha}}(\omega)\delta_i \eta_0 + \mathcal{L}f_\delta \gg_{\widehat{\alpha}} \leq 4\delta.$$

Before proving these two Lemmas, we show that they are sufficient to obtain Proposition 5.38. Fix  $\delta > 0$ , and consider the  $\epsilon = \epsilon_\delta$  given by Lemma 5.40 and  $f_\delta$  given by Lemma 5.39, we have

$$\begin{aligned} \sup_{\widehat{\alpha} \in \mathcal{M}_1(\mathbb{S})} \ll j_i^\omega + d_s(\alpha)\delta_i \xi_0^p + \mathbb{E}_{\widehat{\alpha}}(\omega)\delta_i \eta_0 + \mathcal{L}f_\delta \gg_{\widehat{\alpha}} \\ \leq \sup_{\widehat{\alpha} \in \mathcal{M}_\epsilon(\mathbb{S})} \ll j_i^\omega + d_s(\alpha)\delta_i \xi_0^p + \mathbb{E}_{\widehat{\alpha}}(\omega)\delta_i \eta_0 + \mathcal{L}f_\delta \gg_{\widehat{\alpha}} \\ + \sup_{\widehat{\alpha} \in \mathcal{M}_1(\mathbb{S}) \setminus \mathcal{M}_\epsilon(\mathbb{S})} \ll j_i^\omega + d_s(\alpha)\delta_i \xi_0^p + \mathbb{E}_{\widehat{\alpha}}(\omega)\delta_i \eta_0 + \mathcal{L}f_\delta \gg_{\widehat{\alpha}}. \end{aligned} \quad (5.129)$$

In the limit  $p \rightarrow \infty$ , the second term in the right-hand side is bounded by  $4\delta$  according to Lemma 5.40.

Regarding the first term in the right hand side, we write by triangular inequality

$$\begin{aligned} \sup_{\widehat{\alpha} \in \mathcal{M}_\epsilon(\mathbb{S})} \ll j_i^\omega + d_s(\alpha)\delta_i \xi_0^p + \mathbb{E}_{\widehat{\alpha}}(\omega)\delta_i \eta_0 + \mathcal{L}f_\delta \gg_{\widehat{\alpha}} \\ \leq \sup_{\widehat{\alpha} \in \mathcal{M}_\epsilon(\mathbb{S})} \ll j_i^\omega + c_p(\widehat{\alpha})\delta_i \xi_0^p + d_p(\widehat{\alpha})\delta_i \eta_0 + \mathcal{L}f_\delta \gg_{\widehat{\alpha}} \\ + \sup_{\widehat{\alpha} \in \mathcal{M}_\epsilon(\mathbb{S})} \ll (c_p(\widehat{\alpha}) - d_s(\alpha))\delta_i \xi_0^p + (d_p(\widehat{\alpha}) - \mathbb{E}_{\widehat{\alpha}}(\omega))\delta_i \eta_0 \gg_{\widehat{\alpha}} \end{aligned} \quad (5.130)$$

The limit  $p \rightarrow \infty$  of the first term in the right-hand side is less than  $3\delta$  according to Lemma 5.39. By triangular inequality, the second term is less than

$$\begin{aligned} \sup_{\widehat{\alpha} \in \mathcal{M}_\epsilon(\mathbb{S})} \ll (c_p(\widehat{\alpha}) - d_s(\alpha))\delta_i \xi_0^p + (d_p(\widehat{\alpha}) - \mathbb{E}_{\widehat{\alpha}}(\omega))\delta_i \eta_0 \gg_{\widehat{\alpha}} \\ \leq \sup_{\widehat{\alpha} \in \mathcal{M}_\epsilon(\mathbb{S})} \left\{ (c_p(\widehat{\alpha}) - d_s(\alpha))^2 \ll \delta_i \xi_0^p \gg_{\widehat{\alpha}} + (d_p(\widehat{\alpha}) - \mathbb{E}_{\widehat{\alpha}}(\omega))^2 \ll \delta_i \eta_0 \gg_{\widehat{\alpha}} \right\}. \end{aligned}$$

As a consequence of Proposition 5.33 and Corollary 5.37, both  $\ll \delta_i \xi_0^p \gg_{\widehat{\alpha}}$  and  $\ll \delta_i \eta_0 \gg_{\widehat{\alpha}}$  are bounded uniformly in  $\widehat{\alpha} \in \mathcal{M}_1(\mathbb{S})$  and  $p$ , whereas  $c_p$  and  $d_p$  converge uniformly on  $\mathcal{M}_\epsilon(\mathbb{S})$ , as

$p \rightarrow \infty$ , to  $d_s$  and  $\mathbb{E}_{\widehat{\alpha}}(\omega)$ . Therefore, as  $p \rightarrow \infty$ , the second term in the right-hand side of (5.130) vanishes, and

$$\lim_{p \rightarrow \infty} \sup_{\widehat{\alpha} \in \mathcal{M}_\epsilon(\mathbb{S})} \ll j_i^\omega + d_s(\alpha) \delta_i \xi_0^p + \mathbb{E}_{\widehat{\alpha}}(\omega) \delta_i \eta_0 + \mathcal{L} f_\delta \gg_{\widehat{\alpha}} \leq 3\delta. \quad (5.131)$$

This, combined with (5.129), finally yields that

$$\lim_{p \rightarrow \infty} \sup_{\widehat{\alpha} \in \mathcal{M}_1(\mathbb{S})} \ll j_i^\omega + d_s(\alpha) \delta_i \xi_0^p + \mathbb{E}_{\widehat{\alpha}}(\omega) \delta_i \eta_0 + \mathcal{L} f_\delta \gg_{\widehat{\alpha}} \leq 7\delta,$$

which proves Proposition 5.38. ■

We now prove both Lemmas 5.39 and 5.40.

*Proof of Lemma 5.39 :* For any  $\delta > 0$ , we want to build a cylinder function  $f_\delta \in C_0$  such that

$$\lim_{p \rightarrow \infty} \sup_{\widehat{\alpha} \in \mathcal{M}_\epsilon(\mathbb{S})} \ll j_i^\omega + c_p(\widehat{\alpha}) \delta_i \xi_0^p + d_p(\widehat{\alpha}) \delta_i \eta_0 + \mathcal{L} f_\delta \gg_{\widehat{\alpha}} \leq \delta.$$

By Theorem 5.25 the application  $\widehat{\alpha} \mapsto \ll \psi \gg_{\widehat{\alpha}}$  is continuous on  $\mathcal{M}_1(\mathbb{S})$ , and thanks to equation (5.89), for any parameter  $\widehat{\alpha}_0$ , there exists a function  $g_{\widehat{\alpha}_0} \in \mathcal{T}_0^\omega$  and a neighborhood  $\mathcal{N}_{\widehat{\alpha}_0}$  of  $\widehat{\alpha}_0$  such that for any  $\widehat{\alpha} \in \mathcal{N}_{\widehat{\alpha}_0}$ ,

$$\ll j_i^\omega + c_p(\widehat{\alpha}_0) \delta_i \xi_0^p + d_p(\widehat{\alpha}_0) \delta_i \eta_0 + \mathcal{L} g_{\widehat{\alpha}_0} \gg_{\widehat{\alpha}} \leq 2\delta.$$

Furthermore, thanks to the last statement in Proposition 5.33, this function is an approximation of the one realizing  $\inf_{g \in \mathcal{T}_0^\omega} \ll j_i^\omega + \mathcal{L} g \gg_{\widehat{\alpha}_0}$ , and can be chosen independently of  $p$ .

We prove in Proposition B.3 that  $\mathcal{M}_1(\mathbb{S})$  is compact, it therefore admits a finite covering  $\mathcal{M}_1(\mathbb{S}) \subset \cup_{j=1}^m \mathcal{N}_{\widehat{\alpha}_j}$ . We can build a  $C^2$  interpolation of the  $g_{\widehat{\alpha}_j}$ 's, and therefore obtain a function  $(\widehat{\alpha}, \eta) \mapsto \Phi(\widehat{\alpha}, \eta)$  which coincides in  $\widehat{\alpha} = \widehat{\alpha}_j$  with  $g_{\widehat{\alpha}_j}$ , with the two following properties :

- let  $B$  be a finite set of edges in  $\mathbb{Z}^2$  containing the support of all the  $g_{\widehat{\alpha}_j}$ 's,  $\Phi(\widehat{\alpha}, \cdot)$  is a cylinder function in  $\mathcal{T}_0^\omega$  with support included in  $B$  for any  $\widehat{\alpha} \in \mathcal{M}_1(\mathbb{S})$ .
- For any fixed configuration  $\widehat{\eta}$ ,  $\Phi(\cdot, \widehat{\eta})$  is in  $C^2(\mathcal{M}_1(\mathbb{S}))$ .

Furthermore, by construction of  $\Phi$  and thanks to the continuity in  $\widehat{\alpha}$  of the diffusion coefficients and  $\xi_0^p$ , for any  $\widehat{\alpha} \in \mathcal{M}_1(\mathbb{S})$

$$\ll j_i^\omega + c_p(\widehat{\alpha}) \delta_i \xi_0^p + d_p(\widehat{\alpha}) \delta_i \eta_0 + \mathcal{L} \Phi(\widehat{\alpha}, \cdot) \gg_{\widehat{\alpha}} \leq 2\delta. \quad (5.132)$$

Recall that we introduced in (1.22) the empirical angle measure

$$\widehat{\rho}_r = \frac{1}{|B_r|} \sum_{x \in B_r} \eta_x \delta_{\theta_x}$$

the empirical angle measure in the box of side  $(2r + 1)$  around the origin. For some fixed large integer  $r$ , let us now consider the function

$$f_r(\widehat{\eta}) = \Phi(\widehat{\rho}_r, \widehat{\eta}),$$

which is a function in  $C_0$  as soon as the support  $B$  of the  $\Phi(\widehat{\alpha}, \eta)$ 's are contained in  $B_r$  which happens for  $r$  large enough. Note that  $f_r$  is not necessarily in  $\mathcal{T}_0$ , therefore,  $\ll \mathcal{L}f_r \gg_{\widehat{\alpha}}$  should a priori be ill-defined. In fact, it is not, because for any  $f \in C_0$ , we can define

$$\ll \mathcal{L}f \gg_{\widehat{\alpha}} = \sum_i \mathbb{E}_{\widehat{\alpha}}((\nabla_i \Sigma_f)^2), \quad \text{and} \quad \ll \mathcal{L}f, g \gg_{\widehat{\alpha}} = \mathbb{E}_{\widehat{\alpha}}(g \cdot \Sigma f),$$

which is consistent with our prior definition of  $\ll . \gg_{\widehat{\alpha}}$  on  $\mathcal{L}\mathcal{T}_0^\omega$ . This problem being purely cosmetic, we therefore keep the same notations as if  $\mathcal{L}f_r$  was in  $\mathcal{H}_{\widehat{\alpha}}$ .

By triangle inequality,

$$\sup_{\widehat{\alpha} \in \mathcal{M}_\epsilon(\mathbb{S})} \ll j_i^\omega + c_p(\widehat{\alpha})\delta_i \xi_0^p + d_p(\widehat{\alpha})\delta_i \eta_0 + \mathcal{L}f_r \gg_{\widehat{\alpha}} \leq 2\delta + \sup_{\widehat{\alpha} \in \mathcal{M}_\epsilon(\mathbb{S})} \ll \mathcal{L}(f_r - \Phi(\widehat{\alpha}, .)) \gg_{\widehat{\alpha}}. \quad (5.133)$$

The second term in the right-hand side above is explicitly known thanks to Proposition 5.27, and is equal to

$$\sum_i \mathbb{E}_{\widehat{\alpha}} \left( \left( \nabla_i \sum_{x \in \mathbb{Z}^2} \tau_x [f_r - \Phi(\widehat{\alpha}, .)] \right)^2 \right) = \sum_i \mathbb{E}_{\widehat{\alpha}} \left( \left( \sum_{x \in \mathbb{Z}^2} \nabla_{x, x+e_i} [f_r - \Phi(\widehat{\alpha}, .)] \right)^2 \right),$$

by translation invariance of  $\mu_{\widehat{\alpha}}$ , and because  $\nabla_i \tau_x = \tau_x \nabla_{-x, -x+e_i}$ . We extend  $B$  by 1 in such a way that for any edge  $a$  outside of  $B$ ,  $\nabla_a \Phi(\widehat{\alpha}, .)$  vanishes. Therefore, the only contributions outside of  $B$  in the sums above are at the boundary of  $B_l$ , where  $f_r$  has a variation in its first argument of order  $(2r+1)^{-2}$ . Thanks to the regularity of  $\Phi$  in  $\widehat{\alpha}$ , and since the number of corresponding edges is roughly  $4(2r+1)$ , the contribution of all these jumps is of order  $r^{-1}$  in the whole sum.

Then, since the number of edges in  $B$  depends only on  $\Phi$ , and since  $\mathbb{E}_{\widehat{\alpha}}((\nabla_a f)^2) \leq 4\mathbb{E}_{\widehat{\alpha}}(f^2)$ , we obtain by the definition of  $f_r$  that

$$\sup_{\widehat{\alpha} \in \mathcal{M}_\epsilon(\mathbb{S})} \ll \mathcal{L}(f_r - \Phi(\widehat{\alpha}, .)) \gg_{\widehat{\alpha}} \leq \sup_{\widehat{\alpha} \in \mathcal{M}_\epsilon(\mathbb{S})} C(\Phi) \mathbb{E}_{\widehat{\alpha}} \left[ (\Phi(\widehat{\rho}_r, .) - \Phi(\widehat{\alpha}, .))^2 \right] + O(r^{-2}), \quad (5.134)$$

whose right-hand side vanishes as  $r$  goes to infinity by the law of large numbers.

Let us fix  $r_\delta$  such that the right-hand side of (5.134) is less than  $\delta$ , and let  $f_\delta = f_{r_\delta}$ , (5.133) finally yields

$$\sup_{\widehat{\alpha} \in \mathcal{M}_\epsilon(\mathbb{S})} \ll j_i^\omega + c_p(\widehat{\alpha})\delta_i \xi_0^p + d_p(\widehat{\alpha})\delta_i \eta_0 + \mathcal{L}f_\delta \gg_{\widehat{\alpha}} \leq 3\delta, \quad (5.135)$$

as wanted. The last statement of the Lemma is a direct consequence of the construction of  $f_\delta$  and of Proposition 5.33. This concludes the proof of Lemma 5.39. ■

*Proof of Lemma 5.40 :* We now prove that given  $\delta > 0$  and the function  $f_\delta$  built in Lemma 5.39, there exists a constant  $C$  such that

$$\lim_{p \rightarrow \infty} \sup_{\widehat{\alpha} \in \mathcal{M}_1(\mathbb{S}) \setminus \mathcal{M}_\epsilon(\mathbb{S})} \ll j_i^\omega + d_s(\alpha)\delta_i \xi_0^p + \mathbb{E}_{\widehat{\alpha}}(\omega)\delta_i \eta_0 + \mathcal{L}f_\delta \gg_{\widehat{\alpha}} \leq C\epsilon + 3\delta,$$

which proves Lemma 5.40. We first write by triangular inequality

$$\begin{aligned} & \ll j_i^\omega + d_s(\alpha)\delta_i\xi_0^p + \mathbb{E}_{\widehat{\alpha}}(\omega)\delta_i\eta_0 + \mathcal{L}f_\delta \gg_{\widehat{\alpha}} \\ & \leq \ll \mathcal{L}f_\delta - \mathcal{L}\Phi(\widehat{\alpha}, \cdot) \gg_{\widehat{\alpha}} + \ll j_i^\omega + d_s(\alpha)\delta_i\xi_0^p + \mathbb{E}_{\widehat{\alpha}}(\omega)\delta_i\eta_0 + \mathcal{L}\Phi(\widehat{\alpha}, \cdot) \gg_{\widehat{\alpha}} \end{aligned}$$

where  $\Phi(\widehat{\alpha}, \cdot)$  is the function built in the proof of Lemma 5.39. The first term in the right hand side being less than  $\delta$  by construction of  $f_\delta$ , we focus on the second term. Using once again the triangular inequality, we can bound it from above by

$$\ll j_i^\omega + \mathcal{L}\Phi(\widehat{\alpha}, \cdot) \gg_{\widehat{\alpha}} + d_s(\alpha)^2 \ll \delta_i\xi_0^p \gg_{\widehat{\alpha}} + \mathbb{E}_{\widehat{\alpha}}(\omega)^2 \ll \delta_i\eta_0 \gg_{\widehat{\alpha}}. \quad (5.136)$$

For any  $\widehat{\alpha}$  such that  $\alpha > 1 - \epsilon$ ,  $\ll \delta_i\eta_0 \gg_{\widehat{\alpha}} = \alpha(1 - \alpha) < \epsilon$ , and for some constant  $C$ ,  $d_s(\alpha) \leq C(1 - \alpha) \leq C\epsilon$  according to Proposition A.3. This yields,  $\ll \delta_i\xi_0^p \gg_{\widehat{\alpha}}$  being bounded according to Corollary 5.37, that the two last terms in equation (5.136) are bounded from above by  $C\epsilon$  for some constant  $C$  depending only on  $\omega$ .

We now turn to the first term in (5.136). For any function  $f$ , we can write by triangular inequality

$$\begin{aligned} \ll j_i^\omega + \mathcal{L}\Phi(\widehat{\alpha}, \cdot) \gg_{\widehat{\alpha}} & \leq \ll j_i^\omega + \mathcal{L}f \gg_{\widehat{\alpha}} + \ll j_i^\omega + c_p(\widehat{\alpha})\delta_i\xi_0^p + d_p(\widehat{\alpha})\delta_i\eta_0 + \mathcal{L}f \gg_{\widehat{\alpha}} \\ & \quad + \ll j_i^\omega + c_p(\widehat{\alpha})\delta_i\xi_0^p + d_p(\widehat{\alpha})\delta_i\eta_0 + \mathcal{L}\Phi(\widehat{\alpha}, \cdot) \gg_{\widehat{\alpha}}. \end{aligned}$$

We now let  $f$  ultimately realize both of the infimums (5.109) and (5.111). The first term above converges according to Lemma 5.35 towards  $\mathbb{E}_{\widehat{\alpha}}(\omega)\alpha_\omega(1 - \alpha) + \alpha\text{Var}_{\widehat{\alpha}}(\omega)d_s(\alpha)$ . The second term vanishes, whereas the last term is less than  $2\delta$  by equation (5.132). Finally, we obtain

$$\ll j_i^\omega + \mathcal{L}\Phi(\widehat{\alpha}, \cdot) \gg_{\widehat{\alpha}} \leq \alpha\text{Var}_{\widehat{\alpha}}(\omega)d_s(\alpha) + 2\delta \leq C'\epsilon + 2\delta$$

for some constant  $C'$  depending only on  $\omega$ .

Finally, choosing  $\epsilon_\delta = \delta/(C + C')$  concludes the proof of Lemma 5.40.  $\blacksquare$

## 5.9 Drift part of the hydrodynamic limit

Recall that  $L_N = N^2\mathcal{L} + N\mathcal{L}^{\text{wa}} + \mathcal{L}^G$  is the complete generator of our process introduced in (1.2). In the previous section, we proved that the symmetric currents can be replaced by a gradient, up to a perturbation  $\mathcal{L}f$ . In our case, this perturbation is not negligible, and must be added to the asymmetric currents induced by the asymmetric generator  $\mathcal{L}^{\text{wa}}$  to complete the drift term in equation (1.13). This is the purpose of this Section.

To achieve that goal, we need notations similar to the ones introduced in Section 3.1. For any positive integer  $l$ , and any smooth function  $G \in C([0, T] \times \mathbb{T}^2)$ , let us introduce

$$\mathcal{R}_i^{f,l}(\widehat{\eta}) = r_i^\omega + \mathcal{L}^{\text{wa}}f - \mathbb{E}_{\widehat{\rho}_l}(r_i^\omega + \mathcal{L}^{\text{wa}}f),$$

and

$$Y_{i,N}^{f,l}(G, \widehat{\eta}) = \frac{1}{N^2} \sum_{x \in \mathbb{T}_N^2} G(x/N) \tau_x \mathcal{R}_i^{f,l},$$



where  $r_i^\omega$  is the asymmetric current introduced in (1.18). According to Theorem 5.1, for any  $i$ , there exists a family of cylinder functions  $(f_\delta)_{\delta>0}$  introduced in Lemma 5.39 such that

$$\lim_{\gamma \rightarrow \infty} \lim_{\delta \rightarrow 0} \limsup_{\varepsilon \rightarrow 0} \limsup_{N \rightarrow \infty} \frac{1}{\gamma N^2} \log \mathbb{E}_{\mu_\alpha^*}^{\lambda, \beta} \left[ \exp \left( \gamma N^2 \left| \int_0^T X_{i,N}^{f_\delta, \varepsilon N}(G_t, \widehat{\eta}(t)) dt \right| \right) \right] = 0,$$

where  $X_{i,N}^{f_\delta, \varepsilon N}$  was defined in equation (5.1). Furthermore, we also established in equation 5.128 that this sequence satisfies for any  $\widehat{\alpha} \in \mathcal{M}_1(\mathbb{S})$

$$\lim_{\delta \rightarrow 0} \ll j_i^\omega + \mathcal{L}f_\delta \gg_{\widehat{\alpha}} = \inf_{f \in \mathcal{T}_0^\omega} \ll j_i^\omega + \mathcal{L}f \gg_{\widehat{\alpha}}. \quad (5.137)$$

The replacement Lemma 3.1 applied to  $g(\widehat{\eta}) = r_i^\omega + \mathcal{L}^{\text{wa}} f$  yields the following result.

**Lemma 5.41.** *Let  $G$  be some smooth function in  $C^{1,2}([0, T] \times \mathbb{T}^2)$ , and  $T \in \mathbb{R}_+^*$ , then for  $i \in \{1, 2\}$  we have*

$$\lim_{\delta \rightarrow 0} \limsup_{\varepsilon \rightarrow 0} \limsup_{N \rightarrow \infty} \mathbb{E}_{\mu^N}^{\lambda, \beta} \left[ \left| \int_0^T Y_{i,N}^{f_\delta, \varepsilon N}(G, \widehat{\eta}) ds \right| \right] = 0.$$

Furthermore, we now prove the following result, which states that any function of the form  $N\mathcal{L}^D f$  vanishes in the hydrodynamic limit, where  $\mathcal{L}^D = \mathcal{L} + N^{-1}\mathcal{L}^{\text{wa}}$  is the generator of whole exclusion process.

**Lemma 5.42.** *For any function  $G : [0, T] \times \mathbb{T}^2 \rightarrow \mathbb{R}$  in  $C^{1,2}$ , and any cylinder function  $f$ ,*

$$\limsup_{N \rightarrow \infty} \mathbb{E}_{\mu^N} \left[ \left| \int_0^T \frac{1}{N} \sum_{x \in \mathbb{T}_N^2} G(s, x/N) \tau_x \mathcal{L}^D f(\widehat{\eta}(s)) ds \right| \right] = 0.$$

*Proof of Lemma 5.42 :* For any such smooth function  $H$  and cylinder function  $f$ , let us denote

$$F_G(s, \widehat{\eta}(s)) = N^{-2} \sum_{x \in \mathbb{T}_N^2} G(s, x/N) \tau_x f(\widehat{\eta}(s)).$$

The time process

$$M_G(t) = F_G(t, \widehat{\eta}(t)) - F_G(0, \widehat{\eta}(0)) - \int_0^t \partial_s F_G(s, \widehat{\eta}(s)) ds - \int_0^t L_N F_G(s, \widehat{\eta}(s)) ds$$

is a martingale, where  $L_N$  is the complete generator of our process, introduced in (1.2). Since  $f$  is bounded, the first three terms are of order 1, it remains to control  $\int_0^T L_N F_G ds$ . The quadratic variation of this martingale is given by

$$\begin{aligned} [M_G(\cdot, \widehat{\eta}(\cdot))]_t &= \int_0^t L_N F_G(s, \widehat{\eta}(s))^2 - 2F_G(s, \widehat{\eta}(s)) L_N F_G(s, \widehat{\eta}(s)) ds \\ &= \int_0^t ds N^2 \sum_{\substack{x \in \mathbb{T}_N^2 \\ \delta = \pm 1, i \in \{1, 2\}}} \tau_{x, z, i, \delta}^\lambda \left[ F_G(s, \widehat{\eta}^{x, x + \delta e_i}(s)) - F_G(s, \widehat{\eta}(s)) \right]^2 \\ &\quad + \int_0^t ds \sum_{x \in \mathbb{T}_N^2} \eta_x \int_{\mathbb{S}} c_{x, \beta}(\theta, \widehat{\eta}) \left[ F_G(s, \widehat{\eta}^{x, \theta}(s)) - F_G(s, \widehat{\eta}(s)) \right]^2 d\theta \end{aligned}$$

$$\begin{aligned}
&= \frac{1}{N^2} \int_0^T ds \sum_{\substack{x \in \mathbb{T}_N^2 \\ \delta = \pm 1, i \in \{1,2\}}} \tau_{x,z,i,\delta}^\lambda(\widehat{\eta}(s)) \left[ \sum_{y \in \mathbb{T}_N^2} G(s, y/N) (\tau_y f(\widehat{\eta}^{x,x+z}(s)) - \tau_y f(\widehat{\eta}(s))) \right]^2 \\
&\quad + \frac{1}{N^4} \int_0^T ds \sum_{x \in \mathbb{T}_N^2} \eta_x \int_{\mathbb{S}} c_{x,\beta}(\theta, \widehat{\eta}) \left[ \sum_{y \in \mathbb{T}_N^2} G(s, y/N) (\tau_y f(\widehat{\eta}^{x,x+z}(s)) - \tau_y f(\widehat{\eta}(s))) \right]^2 d\theta,
\end{aligned}$$

where

$$\tau_{x,z,i,\delta}^\lambda(\widehat{\eta}) = \left( 1 + \frac{\delta \lambda_i(\theta_x)}{N} \right) \eta_x (1 - \eta_{x+z})$$

is the total displacement jump rate.

Since  $f$  is a local function, all but a finite number of terms in the  $y$  sum vanish, and the quadratic variation is hence of order  $N^{-2}$ . (For a reference on the quadratic variation, cf. Appendix 1.5, Lemma 5.1 in [KL99]). We deduce from the estimate of the quadratic variation of  $M_G$  and the order of the three first terms in the expression of  $M_G$  that

$$\mathbb{E}_{\mu^N} \left( \left| \int_0^T N^{-1} L_N F_G(s, \widehat{\eta}(s)) ds \right| \right) \leq N^{-1} \left[ \underbrace{\mathbb{E}_{\mu^N} ([M_G(t, \widehat{\eta}(t))]^{1/2})}_{O(N^{-1})} + O_N(1) \right] \xrightarrow{N \rightarrow \infty} 0.$$

The previous martingale estimate shows that  $\mathbb{E}_{\mu^N} \left( \left| \int_0^T N^{-1} L_N F_G(s, \widehat{\eta}(s)) ds \right| \right)$  vanishes in the limit  $N \rightarrow \infty$ . Furthermore, elementary computations yield a crude bound on the contribution of the Glauber generator of order  $N^{-1}$ . Finally, since  $L_N = N^2 \mathcal{L}^D + \mathcal{L}^G$ , we obtain

$$\mathbb{E}_{\mu^N} \left( \left| \int_0^T N \mathcal{L}^D F_G(s, \widehat{\eta}(s)) ds \right| \right) \xrightarrow{N \rightarrow \infty} 0,$$

which completes the proof of Lemma 5.42.  $\blacksquare$

We now use these two Lemmas to prove that the total displacement current can be replaced by the wanted averages. More precisely, let

$$\mathcal{U}_i^{f,l}(\widehat{\eta}) = j_i^\omega + \frac{1}{N} r_i^\omega + d_s(\rho_l) \delta_i \rho_l^\omega + \mathfrak{d}(\rho_l, \rho_l^\omega) \delta_i \rho_l - \frac{1}{N} \mathbb{E}_{\widehat{\rho}_l}(r_i^\omega + \mathcal{L}^{\text{wa}} f),$$

we can state the following result.

**Corollary 5.43.** *Let  $G$  be some smooth function in  $C^{1,2}([0, T] \times \mathbb{T}^2)$ , and  $T \in \mathbb{R}_+^*$ , then for  $i \in \{1, 2\}$  we have*

$$\lim_{\delta \rightarrow 0} \limsup_{\varepsilon \rightarrow 0} \limsup_{N \rightarrow \infty} \mathbb{E}_{\mu^N}^{\lambda, \beta} \left[ \left| \int_0^T \frac{1}{N} \sum_{x \in \mathbb{T}_N^2} G(x/N) \mathcal{U}_i^{f, \delta, \varepsilon N}(G, \widehat{\eta}) ds \right| \right] = 0.$$

*Proof of Corollary 5.43 :* Adding and subtracting  $(1/N) \mathcal{L}^{\text{wa}} f_\delta$  to the definition of  $\mathcal{U}_i^{f, \delta, \varepsilon N}$ , we can split it into three parts,

$$j_i^\omega + d_s(\rho_{\varepsilon N}) \delta_i \rho_{\varepsilon N}^\omega + \mathfrak{d}(\rho_{\varepsilon N}, \rho_{\varepsilon N}^\omega) \delta_i \rho_{\varepsilon N} + \mathcal{L} f_\delta,$$

$$\frac{1}{N}(r_i^\omega + \mathcal{L}^{\text{WA}} f_\delta) - \frac{1}{N} \mathbb{E}_{\widehat{\rho}_{\varepsilon N}}(r_i^\omega + \mathcal{L}^{\text{WA}} f_\delta), \quad \text{and} \quad -\mathcal{L}^{\text{D}} f_\delta.$$

The contribution of the first quantity vanishes in the limit of Corollary 5.43, according to Corollary 5.2. The second contribution also does thanks to Lemma 5.41, as well as the third due to Lemma 5.42, thus completing the proof of the Corollary. ■

We now derive an explicit expression for the quantity  $\mathbb{E}_{\widehat{\rho}_{\varepsilon N}}(r_i^\omega + \mathcal{L}^{\text{WA}} f_\delta)$  as  $\delta$  goes to 0, which is the main result of this section.

**Lemma 5.44.** *For any angle measure  $\widehat{\alpha} \in \mathcal{M}_\varepsilon(\mathbb{S})$ ,*

$$\lim_{\delta \rightarrow 0} \mathbb{E}_{\widehat{\alpha}}(r_i^\omega + \mathcal{L}^{\text{WA}} f_\delta) = 2d_s(\alpha)\alpha_{\omega\lambda_i} + 2\frac{\alpha_\omega\alpha_{\lambda_i}}{\alpha}(1 - \alpha - d_s(\alpha)), \quad (5.138)$$

where for any function  $\Phi : \mathbb{S} \rightarrow \mathbb{R}$ , we defined  $\alpha_\Phi = \mathbb{E}_{\widehat{\alpha}}(\Phi(\theta_0)\eta_0)$ .

**Remark 5.45** (extension of  $\ll . \gg_{\widehat{\alpha}}$ ). *For any function  $\Phi$ , we denoted*

$$j_i^\Phi = \Phi(\theta_0)\eta_0(1 - \eta_{e_i}) - \Phi(\theta_{e_i})\eta_{e_i}(1 - \eta_0).$$

Note that our definition of  $\mathcal{H}_{\widehat{\alpha}}$  is intrinsically dependent on  $\omega$ . In order to move forward with the proof and state the proof of Lemma 5.44 in a form as simple as possible, we need to enlarge the space  $\mathcal{H}_{\widehat{\alpha}}$  to functions and currents depending on the  $\lambda_i$ 's. For this purpose, we set  $\eta_x^{a,b,c,d} = a\eta_x^\omega + b\eta_x^{\lambda_1} + c\eta_x^{\lambda_2} + d\eta_x$ ,

$$\begin{aligned} \widetilde{\mathcal{T}}_0 &= \mathcal{C}_0 \cap \left\{ \sum_{x \in \mathbb{T}_N^2} \eta_x^{a,b,c,d} \psi_x(\eta), \quad a, b, c, d \in \mathbb{R}, \text{ and } \psi_x \in \mathcal{S}, \quad \forall x \in \mathbb{T}_N^2 \right\}, \\ \ll f \gg_{\widehat{\alpha}} &= \sup_{\substack{g \in \widetilde{\mathcal{T}}_0 \\ a,b,c,d \in \mathbb{R}^2}} \left\{ 2\mathbb{E}_{\widehat{\alpha}} \left( f \cdot \left[ \Sigma_g + \sum_{y \in \mathbb{Z}^2} y_1 \eta_x^{a_1, b_1, c_1, d_1} + y_2 \eta_x^{a_2, b_2, c_2, d_2} \right] \right) - \left\| \nabla \Sigma_g + \mathbf{i}^{a,b,c,d} \right\|_{2,\widehat{\alpha}}^2 \right\}, \end{aligned}$$

where

$$\mathbf{i}^{a,b,c,d} = a_1 \mathfrak{U}^\omega + a_2 \mathfrak{B}^\omega + b_1 \mathfrak{U}^{\lambda_1} + b_2 \mathfrak{B}^{\lambda_1} + c_1 \mathfrak{U}^{\lambda_2} + c_2 \mathfrak{B}^{\lambda_2} + d_1 \mathfrak{U} + d_2 \mathfrak{B}.$$

One easily proves that  $\ll . \gg_{\widehat{\alpha}}$  thus defined is a semi-norm, and, letting  $\mathcal{N}_{\widehat{\alpha}}$  be its kernel, we still have the decomposition

$$\frac{\widetilde{\mathcal{T}}_0}{\mathcal{N}_{\widehat{\alpha}}} = \frac{\overline{\mathcal{L}\widetilde{\mathcal{T}}_0}}{\mathcal{N}_{\widehat{\alpha}}} \oplus J,$$

where  $J = j^\omega \cdot \mathbb{R}^2 + j^{\lambda_1} \cdot \mathbb{R}^2 + j^{\lambda_2} \cdot \mathbb{R}^2 + j \cdot \mathbb{R}^2 \subset \mathcal{T}_0^\omega$  is the linear span of the currents. We can also state a result similar to Proposition 5.27 in this new space  $\mathcal{H}_{\widehat{\alpha}}$ .

*Proof of Lemma 5.44 :* The proof of the previous Lemma is mainly based on Proposition 5.27. First note that by definition of  $r_i^\omega = \lambda_i(\theta_0)\omega(\theta_0)\eta_0(1 - \eta_{e_1}) + \lambda_i(\theta_{e_i})\omega(\theta_{e_i})\eta_{e_i}(1 - \eta_0)$ , we can write

$$\mathbb{E}_{\widehat{\alpha}}(r_i^\omega) = 2\mathbb{E}_{\widehat{\alpha}}(\lambda_i(\theta_0)\omega(\theta_0))\mathbb{E}_{\widehat{\alpha}}(\mathfrak{U}) = 2 \ll j_i^{\lambda_i}, j_i^\omega \gg_{\widehat{\alpha}}. \quad (5.139)$$

For any cylinder function  $f$ , with equation (5.90) and the translation invariance of the product measure, as well as  $\eta \rightarrow \widehat{\eta}^{x,x+\delta e_1}$  changes of variable, setting respectively  $\Phi(\theta) = \lambda_1(\theta)$  and  $\lambda_2(\theta)$ , we can write

$$\begin{aligned}
\ll \sum_{i=1}^2 j_i^{\lambda_i}, \mathcal{L}f \gg_{\widehat{\alpha}} &= \ll \sum_{i=1}^2 \lambda_i(\theta_0)\eta_0(1-\eta_{e_i}) - \lambda_i(\theta_{e_i})\eta_{e_i}(1-\eta_0), \mathcal{L}f \gg_{\widehat{\alpha}} \\
&= -\mathbb{E}_{\widehat{\alpha}} \left( \sum_{x \in \mathbb{T}_N^2, i \in \{1,2\}} [\lambda_i(\theta_0)\eta_0(1-\eta_{e_i}) - \lambda_i(\theta_{e_i})\eta_{e_i}(1-\eta_0)] \tau_x f \right) \\
&= -\mathbb{E}_{\widehat{\alpha}} \left( \sum_{x \in \mathbb{T}_N^2, i \in \{1,2\}} [\lambda_i(\theta_x)\eta_x(1-\eta_{x+e_i}) - \lambda_i(\theta_{x+e_i})\eta_{x+e_i}(1-\eta_x)] f \right) \\
&= \mathbb{E}_{\widehat{\alpha}} \left( \sum_{x \in \mathbb{T}_N^2, i \in \{1,2\}} \lambda_i(\theta_x)\eta_x(1-\eta_{x+e_i})(f(\widehat{\eta}^{x,x+e_i}) - f) \right) \\
&= \frac{1}{2} \mathbb{E}_{\widehat{\alpha}} \left( \sum_{x \in \mathbb{T}_N^2, i \in \{1,2\}} \lambda_i(\theta_x)\eta_x(1-\eta_{x+e_i})(f(\widehat{\eta}^{x,x+e_i}) - f) \right. \\
&\quad \left. - \lambda_i(\theta_x)\eta_x(1-\eta_{x-e_i})(f(\widehat{\eta}^{x,x-e_i}) - f) \right) \\
&= \frac{1}{2} \mathbb{E}_{\widehat{\alpha}}(\mathcal{L}^{\text{wa}} f)
\end{aligned}$$

i.e.

$$\mathbb{E}_{\widehat{\alpha}}(\mathcal{L}^{\text{wa}} f) = 2 \ll j_1^{\lambda_1} + j_2^{\lambda_2}, \mathcal{L}f \gg_{\widehat{\alpha}}. \quad (5.140)$$

Combining the two identities (5.139) and (5.140), we can therefore write,

$$\mathbb{E}_{\widehat{\alpha}}(r_i^\omega + \mathcal{L}^{\text{wa}} f) = 2 \ll j_i^{\lambda_i}, j_i^\omega + \mathcal{L}f \gg_{\widehat{\alpha}}. \quad (5.141)$$

By definition of  $f_\delta = f_\delta^\omega$  (Cf. Lemma 5.39)  $j_i^\omega + \mathcal{L}f_\delta$  being ultimately, as  $\delta \rightarrow 0$ , a combination of gradients and therefore orthogonal to any  $\mathcal{L}f$  according to equation (5.109). This yields

$$\begin{aligned}
\lim_{\delta \rightarrow 0} \ll j_i^{\lambda_i}, j_i^\omega + \mathcal{L}f_\delta^\omega \gg_{\widehat{\alpha}} &= \lim_{\delta \rightarrow 0} \ll j_i^{\lambda_i} + \mathcal{L}f_\delta^{\lambda_i}, j_i^\omega + \mathcal{L}f_\delta^\omega \gg_{\widehat{\alpha}} \\
&= \lim_{\delta \rightarrow 0} \frac{1}{2} \left[ \ll j_i^{\lambda_i+\omega} + \mathcal{L}f_\delta^{\lambda_i+\omega} \gg_{\widehat{\alpha}} - \ll j_i^{\lambda_i} + \mathcal{L}f_\delta^{\lambda_i} \gg_{\widehat{\alpha}} - \ll j_i^\omega + \mathcal{L}f_\delta^\omega \gg_{\widehat{\alpha}} \right].
\end{aligned} \quad (5.142)$$

In the identity above, we used that  $f_\delta^\omega + f_\delta^{\lambda_i} = f_\delta^{\omega+\lambda_i}$ , in the sense that if  $\mathcal{L}f_\delta^\omega$  (resp.  $\mathcal{L}f_\delta^{\lambda_i}$ ) ultimately realize the difference between the currents and gradients with angular dependency  $\omega$  (resp.  $\lambda_i$ ). Indeed, if we can write both

$$\ll j_i^\omega + \mathfrak{d}_p^\omega \delta_i \eta_0^{\omega,p} + \mathfrak{d}_p \delta_i \eta_0^p + \mathcal{L}f_\delta^\omega \gg_{\widehat{\alpha}} \xrightarrow{p \rightarrow \infty, \delta \rightarrow 0} 0$$

$$\ll j_i^{\lambda_i} + \mathfrak{d}_p^{\lambda_i} \delta_i \eta_0^{\lambda_i} + \mathfrak{d}_p \delta_i \eta_0^p + \mathcal{L}f_\delta^{\lambda_i} \gg_{\widehat{\alpha}} \xrightarrow{p \rightarrow \infty, \delta \rightarrow 0} 0,$$

then we can write

$$\ll j_i^{\lambda_i+\omega} + \mathfrak{d}_p^{\lambda_i+\omega} \delta_i \eta_0^{\lambda_i+\omega} + \mathfrak{d}_p \delta_i \eta_0^p + \mathcal{L}(f_\delta^{\lambda_i} + f_\delta^\omega) \gg_{\widehat{\alpha}} \xrightarrow{p \rightarrow \infty, \delta \rightarrow 0} 0,$$

which is to say that

$$\ll j_i^{\lambda_i+\omega} + \mathcal{L}(f_\delta^{\lambda_i} + f_\delta^\omega) \gg_{\widehat{\alpha}} = \inf_f \ll j_i^{\lambda_i+\omega} + \mathcal{L}f \gg_{\widehat{\alpha}}.$$

Equation (5.142) thus holds, and the three parts of the right-hand side respectively converge towards  $\mathfrak{s}^{\lambda_i+\omega}(\widehat{\alpha})$ ,  $\mathfrak{s}^{\lambda_i}(\widehat{\alpha})$  and  $\mathfrak{s}^\omega(\widehat{\alpha})$ , where  $\mathfrak{s}^\omega$  was introduced in equation (5.119). Since  $\alpha_{\omega+\lambda_i} = \alpha_\omega + \alpha_{\lambda_i}$  and  $\eta_0^{\omega+\lambda_i} = \eta_0^\omega + \eta_0^{\lambda_i}$ , the second line of (5.142) thus rewrites

$$\lim_{\delta \rightarrow 0} \ll j_i^{\lambda_i}, j_i^\omega + \mathcal{L}f_\delta^\omega \gg_{\widehat{\alpha}} = 2 \left[ \frac{\alpha_\omega \alpha_{\lambda_i}}{\alpha} (1 - \alpha - d_s(\alpha)) + \mathbb{E}_{\widehat{\alpha}}(\eta_0^\omega \eta_0^{\lambda_i}) d_s(\alpha) \right],$$

which is what we wanted to show. ■

## 6 Proof of the hydrodynamic limit

We now have all the pieces to prove Theorem 1.6. The last remaining difficulty is to perform the second integration by parts, since even the gradients obtained in Section 5 are not exactly microscopic gradients due to the non-constant diffusion coefficient. This is not a problem when the variations only depend on one quantity, the density for example, since we can then simply consider a primitive of the diffusion coefficient and obtain at the highest order in  $N$  a discrete gradient. This is not the case here, and we need some more work to obtain the wanted gradient.

Let us recall from Section 1.4 that for any smooth function  $H \in C^{1,2,2}([0, T] \times \mathbb{T}^2 \times \mathbb{S})$ , that we denoted by  $M_t^{H,N}$  the martingale

$$M_t^{H,N} = \langle \pi_t^N, H_t \rangle - \langle \pi_0^N, H_0 \rangle - \int_0^t \left[ \langle \pi_s^N, \partial_s H_s \rangle + L_N \langle \pi_s^N, H_s \rangle \right] ds, \quad (6.1)$$

where

$$\pi_s^N = \frac{1}{N^2} \sum_{x \in \mathbb{T}_N^2} \eta_x(t) \delta(x/N) \times \delta_{\theta_x(s)}$$

is the empirical measure of the process on  $\mathbb{T}^2 \times \mathbb{S}$ .

*Proof of Theorem 1.6:* The quadratic variation  $[M^{H,N}]_t$  of  $M_t^{H,N}$  (cf. A1.5. Lemma 5.1 in [KL99]) is

$$\begin{aligned} [M^{H,N}]_t &= \int_0^t L_N \langle \pi_s^N, H_s \rangle^2 - 2 \langle \pi_s^N, H_s \rangle L_N \langle \pi_s^N, H_s \rangle ds \\ &= \int_0^t \frac{1}{N^4} \sum_{x \in \mathbb{T}_N^2} \left[ \sum_{|z|=1} A_1(\widehat{\eta}, x, z) H_s(x/N) H_s((x+z)/N) + A_2(\widehat{\eta}, x) H_s(x/N)^2 \right] ds \\ &\leq \int_0^t \frac{1}{N^4} \sum_{x \in \mathbb{T}_N^2} C \|H\|_\infty^2 ds \leq \frac{1}{N^2} t C \|H\|_\infty^2, \end{aligned}$$

where  $C$ ,  $A_1(\widehat{\eta}, x, z)$  and  $A_2(\widehat{\eta}, x)$  are finite quantities independent of  $N$ . The quadratic variation  $[M^{H,N}]_t$  is therefore of order  $N^{-2}$ , and vanishes as  $N$  goes to infinity. The Doob's inequality hence gives us for any  $T > 0$ ,  $\delta > 0$

$$\lim_{N \rightarrow \infty} \mathbb{P}_{\mu^N}^{\lambda, \beta} \left( \sup_{0 \leq t \leq T} |M_t^{H,N}| \geq \delta \right) = 0,$$

and in particular

$$\lim_{N \rightarrow \infty} \mathbb{P}_{\mu^N}^{\lambda, \beta} \left( |M_T^{H,N}| \geq \delta \right) = 0. \quad (6.2)$$

We first consider the case of a function  $H$  such that

$$H_t(u, \theta) = G_t(u) \omega(\theta),$$

the general case will be a simple consequence of a periodic version of the Weierstrass approximation Theorem. For any such  $H$ , we can write

$$\int_0^T L_N \langle \pi_t^N, H_t \rangle dt = \frac{1}{N^2} \int_0^T dt \sum_{x \in \mathbb{T}_N^2} \tau_x \left[ \sum_{i=1}^2 [N j_i^\omega + r_i^\omega](t) \partial_{u_i, N} G_t(x/N) + G_t(x/N) \gamma^\omega(t) \right], \quad (6.3)$$

where  $j_i^\omega$ ,  $r_i^\omega$  and  $\gamma^\omega$  were introduced in Definition 1.8, and

$$\partial_{u_i, N} G(x/N) = N(G(x + e_i/N) - G(x/N))$$

is a microscopic approximation of the spatial derivative  $\partial_{u_i} G$ .

Thanks to Sections 3 and 5, we can perform the following replacements, in the expectation of the expression above, and in the limit  $N \rightarrow \infty$  then  $\varepsilon \rightarrow 0$ :

- Thanks to Corollary 5.43, we can replace,  $j_i^\omega$  by

$$- \left[ d_s(\rho_{\varepsilon N}) \delta_i \rho_{\varepsilon N}^\omega + \mathfrak{d}(\rho_{\varepsilon N}, \rho_{\varepsilon N}^\omega) \delta_i \rho_{\varepsilon N} \right], \quad (6.4)$$

where  $\mathfrak{d}$  is given by equation (5.75),

$$\mathfrak{d}(\rho, \rho^\omega) = \rho^\omega(1 - d_s(\rho))/\rho,$$

- Thanks to Corollary 5.43 and Lemma 5.44,  $r_i^\omega$  can be replaced by

$$R_i^\omega(\widehat{\rho}_{\varepsilon N}) := 2 \left[ d_s(\rho_{\varepsilon N}) \mathbb{E}_{\widehat{\rho}_{\varepsilon N}}(\eta_0^{\omega \lambda_i}) + \frac{\mathbb{E}_{\widehat{\rho}_{\varepsilon N}}(\eta_0^\omega) \mathbb{E}_{\widehat{\rho}_{\varepsilon N}}(\eta_0^{\lambda_i})}{\rho_{\varepsilon N}} (1 - \rho_{\varepsilon N} - d_s(\rho_{\varepsilon N})) \right].$$

- Finally, the Replacement Lemma 3.1 yields that  $\gamma^\omega$  can be replaced by  $\mathbb{E}_{\widehat{\rho}_{\varepsilon N}}(\gamma^\omega)$ .

In other words, thanks to equation (6.2), for any  $H_s(u, \theta) = G_s(u)\omega(\theta)$ , we can write

$$\limsup_{\varepsilon \rightarrow 0} \lim_{N \rightarrow \infty} \mathbb{P}_{\mu^N}^{\lambda, \beta} \left( \left| \widetilde{M}_T^{H, N, \varepsilon} \right| \geq \delta \right) = 0, \quad (6.5)$$

where

$$\begin{aligned} \widetilde{M}_T^{H, N, \varepsilon} = & \langle \pi_T^N, H_T \rangle - \langle \pi_0^N, H_0 \rangle - \int_0^T \langle \pi_t^N, \partial_t H_t \rangle dt \\ & + \int_0^T dt \left[ \frac{1}{N^2} \sum_{x \in \mathbb{T}_N^2} \tau_x \sum_{i=1}^2 \left[ N \left( d_s(\rho_{\varepsilon N}) \delta_i \rho_{\varepsilon N}^\omega + \mathfrak{d}(\rho_{\varepsilon N}, \rho_{\varepsilon N}^\omega) \delta_i \rho_{\varepsilon N} \right) + R_i^\omega(\widehat{\rho}_{\varepsilon N}) \right] \partial_{u_i, N} G_t(x/N) \right. \\ & \left. - G_t(x/N) \mathbb{E}_{\widehat{\rho}_{\varepsilon N}}(\gamma^\omega) \right] (t), \quad (6.6) \end{aligned}$$

In order to give a clear scheme, we divide the end of the proof in a series of steps.

**Performing the second integration by parts :** Due to the presence of the diffusion coefficients, one cannot switch directly the last discrete derivatives  $\delta_i \rho_{\varepsilon N}$  and  $\delta_i \rho_{\varepsilon N}^\omega$  onto the smooth function  $G$ . In one dimension, one would consider a primitive  $d(\rho)$  of the diffusion coefficient  $D(\rho)$ , and write that

$$D(\rho_{\varepsilon N}) \delta_i \rho_{\varepsilon N} = \delta_i d(\rho_{\varepsilon N}) + o_N(\delta_i \rho_{\varepsilon N}).$$

However, our case cannot be solved that way because the differential form

$$(\rho, \rho^\omega) \mapsto d_s(\rho) d\rho^\omega + \mathfrak{d}(\rho, \rho^\omega) d\rho,$$

is not closed, and therefore not exact either, which means that we cannot express (6.4) as

$$\delta_i F(\rho_{\varepsilon N}, \rho_{\varepsilon N}^\omega) + o_N(1/N).$$

We thus need another argument to obtain the differential equation (1.13).

First, we get rid of the part with  $\delta_i \rho^\omega$ . To do so, notice that

$$\begin{aligned} \delta_i \left[ d_s(\rho_{\varepsilon N}) \rho_{\varepsilon N}^\omega \right] &= d_s(\rho_{\varepsilon N}) \delta_i \rho_{\varepsilon N}^\omega + \rho_{\varepsilon N}^\omega \delta_i d_s(\rho_{\varepsilon N}) + o_N(1/N) \\ &= d_s(\rho_{\varepsilon N}) \delta_i \rho_{\varepsilon N}^\omega + \rho_{\varepsilon N}^\omega d'_s(\rho_{\varepsilon N}) \delta_i \rho_{\varepsilon N} + o_N(1/N). \end{aligned}$$

We can therefore write

$$d_s(\rho_{\varepsilon N}) \delta_i \rho_{\varepsilon N}^\omega = \delta_i \left[ d_s(\rho_{\varepsilon N}) \rho_{\varepsilon N}^\omega \right] - \rho_{\varepsilon N}^\omega d'_s(\rho_{\varepsilon N}) \delta_i \rho_{\varepsilon N} + o_N(1/N). \quad (6.7)$$

Let us denote for any  $x \in \mathbb{T}_N^2$

$$D_x^{\varepsilon N} = \tau_x \left( \mathfrak{d}(\rho_{\varepsilon N}, \rho_{\varepsilon N}^\omega) - \rho_{\varepsilon N}^\omega d'_s(\rho_{\varepsilon N}) \right).$$

We perform a second integration by parts in the contribution of the first term in the right-hand side of (6.7), whereas the left-hand side is added to the existing contribution of  $\delta_i \rho_{\varepsilon N}$ , with the modified diffusion coefficient  $D_x^{\varepsilon N}$  defined above. We can now rewrite  $\widetilde{M}_T^{H, N, \varepsilon}$  as

$$\langle \pi_T^N, H_T \rangle - \langle \pi_0^N, H_0 \rangle - \int_0^T \langle \pi_t^N, \partial_t H_t \rangle dt - \int_0^T I_1(t, \widehat{\eta}_t) - I_2(t, \widehat{\eta}_t) dt + o_N(1), \quad (6.8)$$

where

$$I_1(t, \widehat{\eta}) = \frac{1}{N^2} \sum_{x \in \mathbb{T}_N^2} \tau_x \left[ \sum_{i=1}^2 d_s(\rho_{\varepsilon N}) \rho_{\varepsilon N}^\omega \partial_{u_i, N}^2 G_t(x/N) - R_i^\omega(\widehat{\rho}_{\varepsilon N}) \partial_{u_i, N} G_t(x/N) + G_t(x/N) \mathbb{E}_{\widehat{\rho}_{\varepsilon N}}(\gamma^\omega) \right]$$

and

$$\begin{aligned} I_2(t, \widehat{\eta}) &= \frac{1}{N^2} \sum_{x \in \mathbb{T}_N^2} \tau_x \sum_{i=1}^2 N D_0^{\varepsilon N} \delta_i \rho_{\varepsilon N} \partial_{u_i, N} G_t(x/N) \\ &= \frac{1}{N^2} \sum_{x \in \mathbb{T}_N^2} \sum_{i=1}^2 N D_x^{\varepsilon N} (\tau_{x+e_i} \rho_{\varepsilon N} - \tau_x \rho_{\varepsilon N}) \partial_{u_i, N} G_t(x/N). \end{aligned}$$

In  $I_1$ , we regrouped all the terms for which taking the limit  $N \rightarrow \infty$  is not a problem, whereas  $I_2$  is the term where the extra factor  $N$  still has to be absorbed in a spatial derivative.

**Replacement of the microscopic gradient by a mesoscopic gradient :** Since we cannot switch the derivative on the smooth function  $G$  due to the diffusion coefficient, we need to obtain the gradient of  $\rho$  in another way. For this purpose, we need to replace the microscopic gradient  $\tau_{x+e_i} \rho_{\varepsilon N} - \tau_x \rho_{\varepsilon N}$  by a mesoscopic gradient, and make the derivative (in a weak sense) of  $\rho$  appear directly. More precisely, let us define

$$\widetilde{I}_2(t, \widehat{\eta}) = \frac{1}{N^2} \sum_{x \in \mathbb{T}_N^2} \sum_{i=1}^2 D_x^{\varepsilon N} \frac{\tau_{x+\varepsilon^3 N e_i} \rho_{\varepsilon N} - \tau_{x-\varepsilon^3 N e_i} \rho_{\varepsilon N}}{2\varepsilon^3} \partial_{u_i, N} G_t(x/N).$$



We are going to prove that for any configuration  $\widehat{\eta}$ ,

$$\left| I_2(t, \widehat{\eta}) - \widetilde{I}_2(t, \widehat{\eta}) \right| \leq o_N(1) + o_\varepsilon(1), \quad (6.9)$$

uniformly in  $\widehat{\eta}$ . To prove the latter, for any  $k \in \llbracket -\varepsilon^3 N, \varepsilon^3 N \rrbracket$ , let us denote by  $x_k = x + ke_i$ ,

$$\tau_{x+\varepsilon^3 N e_i} \rho_{\varepsilon N} - \tau_{x-\varepsilon^3 N e_i} \rho_{\varepsilon N} = \sum_{k=-\varepsilon^3 N}^{k=\varepsilon^3 N-1} \tau_{x_{k+1}} \rho_{\varepsilon N} - \tau_{x_k} \rho_{\varepsilon N}.$$

A summation by parts therefore allows us to rewrite  $\widetilde{I}_2$  as

$$\widetilde{I}_2(t, \widehat{\eta}) = \frac{1}{N^2} \sum_{x \in \mathbb{T}_N^2} \sum_{i=1}^2 \left[ \frac{1}{2N\varepsilon^3} \sum_{k=-\varepsilon^3 N}^{k=\varepsilon^3 N-1} D_{x_k}^{\varepsilon N} \partial_{u_i, N} G_t(x_k/N) \right] N(\tau_{x+e_i} \rho_{\varepsilon N} - \tau_x \rho_{\varepsilon N}).$$

Furthermore, we can write for any  $x \in \mathbb{T}_N^2$

$$\begin{aligned} & \left| D_x^{\varepsilon N} \partial_{u_i, N} G_t(x/N) - \frac{1}{2\varepsilon^3 N} \sum_{k=-\varepsilon^3 N}^{k=\varepsilon^3 N-1} D_{x_k}^{\varepsilon N} \partial_{u_i, N} G_t(x_k/N) \right| \\ & \leq \frac{1}{2\varepsilon^3 N} \sum_{k=-\varepsilon^3 N}^{k=\varepsilon^3 N-1} \left| D_x^{\varepsilon N} (\partial_{u_i, N} G_t(x/N) - \partial_{u_i, N} G_t(x_k/N)) \right| + \left| \partial_{u_i, N} G_t(x_k/N) (D_x^{\varepsilon N} - D_{x_k}^{\varepsilon N}) \right|. \end{aligned}$$

Since the diffusion coefficients are bounded and  $G_s$  is  $C^2$ , and since  $x$  and the  $x_k$ 's are distant of  $\varepsilon^3 N$ , we can write

$$\left| D_x^{\varepsilon N} (\partial_{u_i, N} G_t(x/N) - \partial_{u_i, N} G_t(x_k/N)) \right| \leq C(G_t) \varepsilon^3.$$

Since  $D_{x_k}^{\varepsilon N}$  depends on the macroscopic density  $\widehat{\rho}_{\varepsilon N}$ , and since the diffusion coefficients can be extended as  $C^1$  functions due to their explicit expression, we also have

$$\left| \partial_{u_i, N} G_t(x_k/N) (D_x^{\varepsilon N} - D_{x_k}^{\varepsilon N}) \right| \leq C'(G_t) \left( \left| \tau_x \rho_{\varepsilon N} - \tau_{x_k} \rho_{\varepsilon N} \right| + \left| \tau_x \rho_{\varepsilon N}^\omega - \tau_{x_k} \rho_{\varepsilon N}^\omega \right| \right) \leq C''(G_t, \omega) \frac{\varepsilon^3 N}{\varepsilon N}.$$

These two bounds finally yield that

$$\left| D_x^{\varepsilon N} \partial_{u_i, N} G_t(x/N) - \frac{1}{2\varepsilon^3 N} \sum_{k=-\varepsilon^3 N}^{k=\varepsilon^3 N-1} D_{x_k}^{\varepsilon N} \partial_{u_i, N} G_t(x_k/N) \right| \leq C(G_t) \varepsilon^3 + C''(G_t, \omega) \varepsilon^2 = o_\varepsilon(\varepsilon). \quad (6.10)$$

By definition of  $I_2$  and  $\widetilde{I}_2$ , the triangular inequality yields

$$\left| I_2 - \widetilde{I}_2 \right| \leq \frac{1}{N^2} \sum_{x \in \mathbb{T}_N^2} \sum_{i=1}^2 \left| D_x^{\varepsilon N} \partial_{u_i, N} G_t(x/N) - \frac{1}{2\varepsilon^3 N} \sum_{k=-\varepsilon^3 N}^{k=\varepsilon^3 N-1} D_{x_k}^{\varepsilon N} \partial_{u_i, N} G_t(x_k/N) \right| N(\tau_{x+e_i} \rho_{\varepsilon N} - \tau_x \rho_{\varepsilon N}). \quad (6.11)$$

The quantity inside the absolute values in the right-hand side above is  $o_N(1) + o_\varepsilon(\varepsilon)$ , thanks to (6.10), whereas  $N(\tau_{x+e_i} \rho_{\varepsilon N} - \tau_x \rho_{\varepsilon N})$  is of order at most  $1/\varepsilon$ , whereas the quantity inside absolute values is  $o_\varepsilon(\varepsilon)$ , therefore their product vanishes as  $\varepsilon \rightarrow 0$ , which proves equation (6.9). We therefore have obtained as wanted that

$$\limsup_{\varepsilon \rightarrow 0} \limsup_{N \rightarrow \infty} I_2(t, \widehat{\eta}) - \widetilde{I}_2(t, \widehat{\eta}) = 0, \quad (6.12)$$

uniformly in  $\widehat{\eta}$ . We can now replace in equation (6.8)  $I_2$  by  $\widetilde{I}_2$ .

**Embedding in the space of trajectories of measures  $\mathcal{M}^{[0,T]}$**  : Recall that  $Q^N$  is the distribution of the empirical measure of our process. We now wish to express the martingale  $\widetilde{M}_t^{H,N,\varepsilon}$  introduced after equation (6.5) as an explicit function of the empirical measure  $\pi^N$  in order to characterize the limit points  $Q^*$  of the compact sequence  $Q^N$ . For that purpose, let  $(\varphi_\varepsilon)_{\varepsilon \rightarrow 0}$  be a family of localizing functions on  $\mathbb{T}^2$ ,

$$\varphi_\varepsilon(\cdot) = (2\varepsilon)^{-2} \mathbb{1}_{[-\varepsilon,\varepsilon]^2}(\cdot),$$

and recall that we defined the empirical measure as

$$\pi_t^N = \frac{1}{N^2} \sum_{x \in \mathbb{T}_N^2} \eta_x(t) \delta_{x/N, \theta_x(t)}.$$

Then, for any function  $\Phi : \mathbb{S} \rightarrow \mathbb{R}$ , and any  $u \in \mathbb{T}^2$  we denote by  $\varphi_{\varepsilon,u}^\Phi$  the function

$$\begin{aligned} \varphi_{\varepsilon,u}^\Phi & : \mathbb{T}^2 \times \mathbb{S} \longrightarrow \mathbb{R} \\ (v, \theta) & \longmapsto \varphi_\varepsilon(v - u) \Phi(\theta). \end{aligned}$$

With this notation, we can therefore write

$$\mathbb{E}_{\tau_{x\rho_{\varepsilon N}}}(\eta_0^\Phi) = \frac{1}{(2\varepsilon N + 1)^2} \sum_{\|y-x\|_\infty \leq \varepsilon N} \eta_y^\Phi = \frac{(2\varepsilon N)^2}{(2\varepsilon N + 1)^2} \langle \pi^N, \varphi_{\varepsilon,x/N}^\Phi \rangle.$$

In the particular case where  $\Phi \equiv 1$ , (resp.  $\Phi = \omega$ ), the above reads as

$$\tau_{x\rho_{\varepsilon N}} = \frac{(2\varepsilon N)^2}{(2\varepsilon N + 1)^2} \langle \pi^N, \varphi_{\varepsilon,x/N}^1 \rangle \quad \left( \text{resp. } \tau_{x\rho_{\varepsilon N}}^\omega = \frac{(2\varepsilon N)^2}{(2\varepsilon N + 1)^2} \langle \pi^N, \varphi_{\varepsilon,x/N}^\omega \rangle \right).$$

Since  $(2\varepsilon N)^2 / (2\varepsilon N + 1)^2 = 1 + o_N(1)$ , we can replace in the limit  $N \rightarrow \infty$  the quantity  $\mathbb{E}_{\tau_{x\rho_{\varepsilon N}}}(\eta_0^\Phi)$  (resp.  $\tau_{x\rho_{\varepsilon N}}$ ,  $\tau_{x\rho}^\omega$ ) by the function of the empirical measure  $\langle \pi^N, \varphi_{\varepsilon,x/N}^\Phi \rangle$  (resp.  $\langle \pi^N, \varphi_{\varepsilon,x/N}^1 \rangle$ ,  $\langle \pi^N, \varphi_{\varepsilon,x/N}^\omega \rangle$ ).

We deduce from equations (6.5), (6.8) and (6.12) and what precedes that for any positive  $\delta$ ,

$$\limsup_{\varepsilon \rightarrow 0} \limsup_{N \rightarrow \infty} Q^N \left( \left| N_T^{H,N}(\pi^{[0,T]}) \right| \geq \delta \right) = 0. \quad (6.13)$$

where  $N_T^{H,N}$  is defined as

$$\begin{aligned} N_T^{H,N}(\pi^{[0,T]}) &= \langle \pi_T, H_T \rangle - \langle \pi_0, H_0 \rangle - \int_0^T \langle \pi_t, \partial_t H_t \rangle dt \\ &\quad - \int_0^T \left[ \frac{1}{N^2} \sum_{x \in \mathbb{T}_N^2} \sum_{i=1}^2 \widetilde{d}_{x/N,\varepsilon}(\pi_t) \partial_{u_i,N}^2 G_t(x/N) - \widetilde{R}_{x/N,\varepsilon,i}(\pi_t) \partial_{u_i,N} G_t(x/N) + \Gamma_{x/N,\varepsilon}^\omega(\pi_t) G_t(x/N) \right] dt \\ &\quad + \int_0^T \left[ \frac{1}{N^2} \sum_{x \in \mathbb{T}_N^2} \sum_{i=1}^2 \widetilde{D}_{x/N,\varepsilon}(\pi_t) \langle \pi_t, \frac{\varphi_{\varepsilon,x/N+\varepsilon^3 e_i}^1 - \varphi_{\varepsilon,x/N-\varepsilon^3 e_i}^1}{2\varepsilon^3} \rangle \partial_{u_i,N} G_t(x/N) \right] dt. \end{aligned} \quad (6.14)$$

In the identity above, we denoted

$$\begin{aligned}\widetilde{d}_{x/N,\varepsilon}(\pi) &= d_s(\langle \pi, \varphi_{\varepsilon,x/N}^1 \rangle) \langle \pi, \varphi_{\varepsilon,x/N}^\omega \rangle \\ \widetilde{D}_{x/N,\varepsilon}(\pi) &= \mathfrak{d}(\langle \pi, \varphi_{\varepsilon,x/N}^1 \rangle, \langle \pi, \varphi_{\varepsilon,x/N}^\omega \rangle) - \langle \pi, \varphi_{\varepsilon,x/N}^\omega \rangle d'_s(\langle \pi, \varphi_{\varepsilon,x/N}^1 \rangle) \\ \widetilde{R}_{x/N,\varepsilon,i}(\pi) &= d_s(\langle \pi, \varphi_{\varepsilon,x/N}^1 \rangle) \langle \pi, \varphi_{\varepsilon,x/N}^{\omega\lambda_i} \rangle \\ &\quad + \frac{\langle \pi, \varphi_{\varepsilon,x/N}^\omega \rangle \langle \pi, \varphi_{\varepsilon,x/N}^{\lambda_i} \rangle}{\langle \pi, \varphi_{\varepsilon,x/N}^1 \rangle} \left[ 1 - \langle \pi, \varphi_{\varepsilon,x/N}^1 \rangle - d_s(\langle \pi, \varphi_{\varepsilon,x/N}^1 \rangle) \right],\end{aligned}$$

and  $\Gamma_{u,\varepsilon}^\omega(\pi) = \mathbb{E}_{\widetilde{\alpha}_{x/N,\varepsilon}(\pi)}(\gamma^\omega)$ , where  $\widetilde{\alpha}_{x/N,\varepsilon}(\pi) \in \mathcal{M}_1(\mathbb{S})$  is the measure on  $\mathbb{S}$

$$\widetilde{\alpha}_{x/N,\varepsilon}(\pi)(d\theta) = \int_{\mathbb{T}^2} \varphi_\varepsilon(\cdot - x/N) \pi(du, d\theta).$$

**Limit  $N \rightarrow \infty$  :** We can now let  $N$  go to  $\infty$  in (6.13). Since  $G$  is a smooth function, one can replace in (6.14) the discrete space derivatives  $\partial_{u_i,N}$  by the continuous derivative  $\partial_{u_i}$ , the sums  $N^{-2} \sum_{x \in \mathbb{T}_N^2}$  by the integral  $\int_{\mathbb{T}^2} du$ , and the variables  $x/N$  by  $u$ . Since the quantity inside the absolute values is a continuous function (for Skorohod's topology defined in Appendix A.1) of  $\pi^{[0,T]}$ , the whole event is an open set, we obtain that for any weak limit point  $Q^*$  of  $(Q^N)$ , and any positive  $\delta$ ,

$$\begin{aligned}\limsup_{\varepsilon \rightarrow 0} Q^* \left( \left| \langle \pi_T, H_T \rangle - \langle \pi_0, H_0 \rangle - \int_0^T \langle \pi_t, \partial_t H_t \rangle dt \right. \right. \\ \left. \left. - \int_0^T \int_{\mathbb{T}^2} \sum_{i=1}^2 \left[ \widetilde{d}_{u,\varepsilon}(\pi_t) \partial_{u_i}^2 G_t(u) - \widetilde{R}_{u,\varepsilon,i}(\pi_t) \partial_{u_i} G_t(u) + \Gamma_{u,\varepsilon}^\omega(\pi_t) G_t(u) \right] dudt \right. \right. \\ \left. \left. + \int_0^T \int_{\mathbb{T}^2} \sum_{i=1}^2 \left[ \widetilde{D}_{u,\varepsilon}(\pi_t) \langle \pi_t, \frac{\varphi_{\varepsilon,u+\varepsilon^3 e_i}^1 - \varphi_{\varepsilon,u-\varepsilon^3 e_i}^1}{2\varepsilon^3} \rangle \partial_{u_i} G_t(u) \right] dudt \right| > \delta \right) = 0\end{aligned}\quad (6.15)$$

**Limit  $\varepsilon \rightarrow 0$  :** In order to consider the limite  $\varepsilon \rightarrow 0$ , we need to express

$$\left\langle \pi_t, \frac{\varphi_{\varepsilon,u+\varepsilon^3 e_i}^1 - \varphi_{\varepsilon,u-\varepsilon^3 e_i}^1}{2\varepsilon^3} \right\rangle$$

in the third line above as an approximation of the gradient of the density  $\partial_{u_i} \rho_t(u)$ . As in the proof of Lemma 5.3, consider a smooth function  $h_{\varepsilon,i,u}$  such that

$$\int_{\mathbb{T}^2} \left| \frac{\varphi_{\varepsilon,u+\varepsilon^3 e_i}^1 - \varphi_{\varepsilon,u-\varepsilon^3 e_i}^1}{2\varepsilon^3}(v) - h_{\varepsilon,i,u} \right| dv = o_\varepsilon(1).\quad (6.16)$$

Since such a function is very similar to the one already presented in Lemma 5.3, we do not give a detailed construction here. Then, we can build a smooth antiderivative  $H_{\varepsilon,u}$  of  $h_{\varepsilon,i,u}$ , and we can write for any  $u \in \mathbb{T}^2$ , and any density  $\rho$  in  $H^1$ ,

$$\int_{\mathbb{T}^2} \rho(v) h_{\varepsilon,i,u}(v) dv = - \int_{\mathbb{T}^2} \partial_{u_i} \rho(v) H_{\varepsilon,u}(v) dv.$$

Regarding the third line of (6.15), this yields

$$\langle \pi_t, \frac{\varphi_{\varepsilon, u + \varepsilon^3 e_t}^1 - \varphi_{\varepsilon, u - \varepsilon^3 e_t}^1}{2\varepsilon^3} \rangle = - \int_{\mathbb{T}^2} \partial_{u_i} \rho(v) H_{\varepsilon, u}(v) dv + o_\varepsilon(1),$$

where  $H_{\varepsilon, u}$  is a smooth approximation of a Dirac in  $u$  and  $o_\varepsilon(1)$  is uniform in  $u$ . According to (4.34),  $\partial_{u_i} \rho$  is in  $L^2([0, T] \times \mathbb{T}^2)$   $Q^*$ -a.s, therefore

$$\int_{\mathbb{T}^2} \partial_{u_i} \rho_t(v) H_{\varepsilon, u}(v) dv \xrightarrow[\varepsilon \rightarrow 0]{L^2([0, T] \times \mathbb{T}^2)} \partial_{u_i} \rho_t(u), \quad (6.17)$$

$Q^*$ -a.s. (see, for example, Theorem 4.22, p.109 in [Bre10]).

By Lemma 4.13 any limit point  $Q^*$  of  $(Q^N)$  is concentrated on measures absolutely continuous w.r.t. the Lebesgue measure on  $\mathbb{T}^2$ . For any such measure  $\pi^{[0, T]}$ , we denote by  $\widehat{\rho}_t(u, d\theta)$  its corresponding density profile on the torus at time  $t$ , and let

$$\rho_t^\omega(u) = \int_{\mathbb{S}} \omega(\theta) \widehat{\rho}_t(u, d\theta).$$

We also shorten  $\rho(u) = \rho^1(u)$ . Thanks to this last remark and using both (6.17) and the dominated convergence theorem for the second line of (6.15), we can now let  $\varepsilon$  go to 0 in equation (6.15), to obtain that for any limit point  $Q^*$  of  $(Q^N)$  and any  $\delta > 0$ ,

$$\begin{aligned} Q^* \left( \left| \langle \pi_T, H_T \rangle - \langle \pi_0, H_0 \rangle - \int_0^T \langle \pi_t, \partial_t H_t \rangle dt \right. \right. \\ \left. \left. - \int_0^T \int_{\mathbb{T}^2} \sum_{i=1}^2 d_s(\rho_t) \rho_t^\omega \partial_{u_i}^2 G_t(u) - 2 \left[ d_s(\rho_t) \rho_t^{\lambda_i \omega} + \frac{\rho_t^\omega}{\rho_t} (1 - \rho_t - d_s(\rho_t)) \rho_t^{\lambda_i} \right] \partial_{u_i} G_t(u) + \mathbb{E}_{\widehat{\rho}_t}(\gamma^\omega) G_t(u) \right) dudt \right. \\ \left. + \int_0^T \int_{\mathbb{T}^2} \sum_{i=1}^2 [d(\rho_t, \rho_t^\omega) - d'_s(\rho_t) \rho_t^\omega] (\partial_{u_i} \rho_t) \partial_{u_i} G_t(u) dudt \right| > \delta \Big) = 0. \quad (6.18) \end{aligned}$$

**Conclusion :** As expected, all the quantities above are linear in  $\omega$ , and elementary computations yield that

$$\mathbb{E}_{\widehat{\rho}_t(u, \cdot)}(\gamma^\omega) = \int_{\mathbb{S}} \omega(\theta) [\mathbb{E}_{\widehat{\rho}_t(u, \cdot)}(c_{u, \beta}(\theta, \widehat{\eta})) - 1] \widehat{\rho}_t(u, d\theta).$$

Furthermore, since  $H_t(u, \theta) = G_t(u) \omega(\theta)$ , we can write for  $k = 1, 2$

$$\rho_t^\omega \partial_{u_i}^k G_t(u) = \int_{\mathbb{S}} \omega(\theta) \partial_{u_i}^k G_t(u) \widehat{\rho}_t(u, d\theta) = \int_{\mathbb{S}} \partial_{u_i}^k H_t(u, \theta) \widehat{\rho}_t(u, d\theta).$$

Similar identities can be obtained when  $\omega$  is replaced for example by  $\omega \lambda_i$ . Using in Equation (6.18) the identities above finally yield, as wanted, that for any  $\delta > 0$

$$\begin{aligned} Q^* \left( \left| \langle \pi_T, H_T \rangle - \langle \pi_0, H_0 \rangle - \int_0^T \langle \pi_t, \partial_t H_t \rangle dt \right. \right. \\ \left. \left. + \int_0^T \int_{\mathbb{T}^2 \times \mathbb{S}} \left[ \sum_{i=1}^2 \left( \partial_{u_i} H_t(u, \theta) [d(\widehat{\rho}_t, \rho_t) - d'_s(\rho_t) \widehat{\rho}_t](u, d\theta) \partial_{u_i} \rho_t(u) - \partial_{u_i}^2 H_t(u, \theta) d_s(\rho_t) \widehat{\rho}_t(u, d\theta) \right) \right] \right. \right. \end{aligned}$$

$$+ \partial_{u_i} H_t(u, \theta) \left[ 2\lambda_s(\widehat{\rho}_t, \rho_t) \vec{\Omega}(\widehat{\rho}_t) + 2\lambda_i(\theta) d_s(\rho_t) \widehat{\rho}_t \right] (u, d\theta) - H_t(u, \theta) \Gamma(\widehat{\rho}_t)(u, d\theta) \Big|_{dudt} > \delta \Big) = 0.$$

As in the proof of Proposition 4.11, this last identity can be extended in the case where  $H_t(u, \theta)$  does not take the form  $G_t(u)\omega(\theta)$  by using a periodic version of the Weierstrass Theorem, thus letting  $\delta \rightarrow 0$  completes the proof of Theorem 1.6. ■



---



---

## APPENDIX

---



---

### A General tools

This appendix regroups a general definitions and results that we will be used throughout the proof.

#### A.1 Topological setup

This paragraph defines the topological setup we endow the trajectories space for our process with. Denoting by  $\mathcal{M}(\mathbb{T}^2 \times \mathbb{S})$  the space of positive measures on the continuous configuration space, and

$$\mathcal{M}^{[0,T]} = D([0, T] \times \mathcal{M}(\mathbb{T}^2 \times \mathbb{S}))$$

the space of right-continuous and left-limited trajectories of measures on  $\mathbb{T}^2 \times \mathbb{S}$ . Each trajectory  $\widehat{\eta}^{[0,T]}$  of our process admits a natural image in  $\mathcal{M}^{[0,T]}$  through its empirical measure

$$\pi_t^N(\widehat{\eta}^{[0,T]}) = \frac{1}{N^2} \sum_{x \in \mathbb{T}_N^2} \eta_x(t) \delta_{(x/N, \theta_x(t))}. \quad (\text{A.1})$$

Let  $(f_k)_{k \in \mathbb{N}}$  be a dense family of functions in  $C^\infty(\mathbb{T}^2 \times \mathbb{S})$ , and assume that  $f_0 \equiv 1$ . The weak topology on  $\mathcal{M}(\mathbb{T}^2 \times \mathbb{S})$  is metrisable, by letting

$$\delta(\pi_0, \pi'_0) = \sum_{k=0}^{\infty} \frac{1}{2^k} \frac{|\langle \pi_0, f_k \rangle - \langle \pi'_0, f_k \rangle|}{1 + |\langle \pi_0, f_k \rangle - \langle \pi'_0, f_k \rangle|}. \quad (\text{A.2})$$

Given this metric,  $\mathcal{M}^{[0,T]}$  is endowed with Skorohod's metric, defined as

$$d(\pi, \pi') = \inf_{\kappa \in F} \max \left\{ \|\kappa\|, \sup_{[0,T]} \delta(\pi_t, \pi'_{\kappa_t}) \right\}, \quad (\text{A.3})$$

where  $F$  is the set of strictly increasing continuous functions from  $[0, T]$  into itself, such that  $\kappa_0 = 0$  and  $\kappa_T = T$ , equipped with the norm

$$\|\kappa\| = \sup_{s,t \in [0,T]} \left\{ \log \left[ \frac{\kappa_s - \kappa_t}{s - t} \right] \right\}.$$

Now,  $(\mathcal{M}^{[0,T]}, d)$  is a metric space, and we endow the set  $\mathcal{P}(\mathcal{M}^{[0,T]})$  of probability measures on  $\mathcal{M}^{[0,T]}$  with the weak topology.

Given the empirical measure  $\pi_t^N$  of the process at time  $t$ , defined in equation (A.1), define the application

$$\pi^N : \begin{array}{l} \Sigma_N^{[0,T]} \longrightarrow \mathcal{M}^{[0,T]} \\ \widehat{\eta}^{[0,T]} \longmapsto \left( \pi_t^N \left( \widehat{\eta}^{[0,T]} \right) \right)_{t \in [0,T]} \end{array},$$

we define

$$Q^N = \mathbb{P}_{\mu^N}^{\lambda,\beta} \circ (\pi^N)^{-1} \in \mathcal{P}(\mathcal{M}^{[0,T]}) \quad (\text{A.4})$$

the pushforward of  $\mathbb{P}_{\mu^N}^{\lambda,\beta}$  by  $\pi^N$ .

## A.2 Self-diffusion coefficient

We regroup in this paragraph some useful results regarding the self-diffusion coefficient. Consider on  $\mathbb{Z}^2$ , an initial configuration where each site is initially occupied w.p.  $\rho \in [0, 1]$ , and with a tagged particle at the origin. Each particle then follows a symmetric exclusion process with finite range transition matrix  $p(\cdot)$ , verifying  $\sum_z zp(z) = 0$ , and  $p(z) = 0$  outside of a finite set of vertices  $B$ .

**Definition A.1** (Self-Diffusion Coefficient). *Given  $X_t = (X_t^1, \dots, X_t^d)$  the position at time  $t$  of the tagged particle, the  $d$ -dimensional self-diffusion matrix  $D_s = D_s(\rho)$  is defined as*

$$yD_s y^* = \lim_{t \rightarrow \infty} \frac{\mathbb{E}((y \cdot X_t)^2)}{t} \quad \forall y \in \mathbb{R}^d, \quad (\text{A.5})$$

where  $y^*$  is the transposed vector of  $y$  and  $(\cdot)$  is the usual inner product in  $\mathbb{R}^d$ .

This result follows from [KV86]. Our system being invariant through coordinates inversions, it is shown in [MFGW89] that the matrix  $D_s$  is diagonal, and can therefore be written

$$D_s(\rho) = d_s(\rho)I.$$

The following Lemma gives a variational formula for  $d_s$  and was obtained in Spohn [Spo90].

**Proposition A.2.** *The self diffusion coefficient  $d_s(\rho)$  is given by the variational formula*

$$d_s(\rho) = \inf_f \left\{ \sum_{\substack{i \in \{1,2\} \\ \delta \in \{-1,1\}}} \mathbb{E}_\rho \left( (1 - \eta_{\delta e_i}) [\delta - (f(\tau_{\delta e_i} \eta) - f(\eta))]^2 + \sum_{x \in \mathbb{Z}^2 \setminus \{0, e_i\}} \eta_x (1 - \eta_{x + \delta e_i}) [f(\eta^{x, x + \delta e_i}) - f(\eta)]^2 \right) \right\}.$$

Finally, the regularity of the self-diffusion coefficient follows from [LOV01], and a lower and upper bound was derived by Varadhan in all dimensions by Varadhan in [Var94b].

**Proposition A.3.** *in any dimension  $d \geq 1$ , the self-diffusion coefficient  $d_s$  is  $C^\infty([0, 1])$ , and for some constant  $C > 0$ , we can write*

$$\frac{1}{C}(1 - \rho) \leq d_s(\rho) \leq C(1 - \rho).$$



### A.3 Entropy

Given two measures on a space  $E$ , let us denote

$$H(\mu | \nu) = \mathbb{E}_\nu \left( \frac{d\mu}{d\nu} \log \frac{d\mu}{d\nu} \right)$$

the relative entropy of  $\mu$  w.r.t  $\nu$ .

**Proposition A.4** (Entropy inequality). *Let  $\pi$  be a reference measure on some probability space  $E$ . Let  $f$  be a function  $E \rightarrow \mathbb{R}$ , and  $\gamma \in \mathbb{R}^+$ . Then, for any positive measure  $\mu$  on  $E$ , we have*

$$\int f d\mu \leq \frac{1}{\gamma} \left[ \log \left( \int e^{\gamma f} d\pi \right) + H(\mu|\pi) \right],$$

where  $H(\mu|\pi)$  is the relative entropy of  $\mu$  with respect to  $\pi$ .

*Proof of Proposition A.4 :* This result is a direct consequence of the variational formula for the entropy

$$H(\mu | \pi) = \sup_{\varphi} \left\{ \int \varphi d\mu - \log \int e^{\varphi} d\pi \right\},$$

where the supremum is taken over all bounded functions  $\varphi$ . To prove the latter, consider

$$\Psi : \varphi \mapsto \int \varphi d\mu - \log \int e^{\varphi} d\pi.$$

This application is concave, and its gradient vanishes in any  $\varphi$  such that

$$\int \psi d\mu = \frac{\int \psi e^{\varphi} d\pi}{\int e^{\varphi} d\pi} \tag{A.6}$$

for any function  $\psi$ . Considering such a gradient-vanishing function  $\varphi$ , and since  $\Psi(\varphi + C) = \Psi(\varphi)$  for any constant  $C \in \mathbb{R}$ , we can safely assume that  $\int e^{\varphi} d\pi = 1$ , and therefore equation (A.6) yields that

$$\varphi = \log \left( \frac{d\mu}{d\pi} \right),$$

which yields the wanted result. ■

**Remark A.5** (Utilization throughout the proof). *This inequality is used throughout this proof with  $\mu_s^N$  the marginal at time  $s$  of the measure of the process started from an initial profile  $\mu^N$ , and with  $\pi = \mu_{\widehat{\alpha}}$  the equilibrium measure of a symmetric simple exclusion process with angle measure  $\widehat{\alpha}$ . Then, for any fixed time  $s$  and for any function  $f$  and any positive  $\gamma$*

$$\mathbb{E}_{\mu_s^N}(f) \leq \frac{1}{\gamma} \left[ \log \mathbb{E}_{\widehat{\alpha}}(e^{\gamma f}) + H(\mu_s^N | \mu_{\widehat{\alpha}}) \right].$$

*This inequality will be our main tool to bound expectation w.r.t the measure of our process of vanishing quantities .*

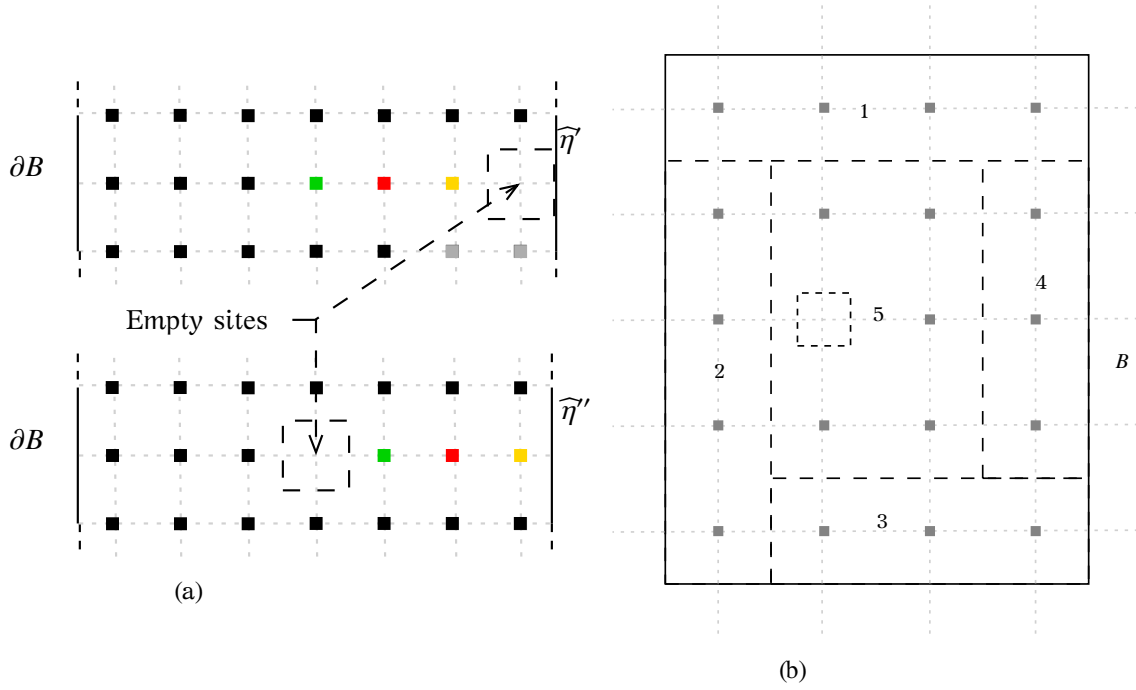

Figure 14: (a) Getting back to a configuration with the empty site in the center. (b) Order of the row/column updating.

### A.4 Bound on the largest eigenvalue of a perturbed Markov generator

**Proposition A.6** (Largest eigenvalue for a small perturbation of a markov generator). *Let us consider a Markov Generator  $L$  with positive spectral gap  $\gamma$  and a bounded function  $V$  with mean 0 with respect to the equilibrium measure  $\mu_{\hat{\alpha}}$  of the Markov process. Then, for any small  $\varepsilon > 0$ , the Largest eigenvalue of the operator  $L + \varepsilon V$  can be bounded from above by*

$$\sup_f \left\{ \varepsilon \mathbb{E}_{\hat{\alpha}}(Vf^2) + \mathbb{E}_{\hat{\alpha}}(fLf) \right\} \leq \frac{\varepsilon^2}{A - 2\varepsilon\gamma \|V\|_{\infty}} \mathbb{E}_{\hat{\alpha}}(V(-L)^{-1}V),$$

where the supremum in the variational formula is taken among the probability densities  $f$  w.r.t  $\mu_{\hat{\alpha}}$ .

The proof of this result is omitted, it is given in Theorem A3.1.1, p.375 in [KL99].

### A.5 Configurations with one empty site

We prove, even though we don't need it in the proof of the hydrodynamic limit, the irreducibility of the 2-spins process on a rectangle finite domain  $B$ , when one site is empty.

**Proposition A.7.** *Let us consider  $B$  a rectangular domain  $B$  such that  $|B| < \infty$ , and a pair  $\widehat{K} = (K^+, K^-)$  such that  $K = K^+ + K^- = |B| - 1$ . Then, the exclusion process restricted to the set with  $\widehat{K}$  particles in  $B$  is irreducible.*

*Proof of Proposition A.7 :*

Let  $\widehat{\eta}$  be a configuration on  $B$  with exactly one empty site, and let  $\widehat{\eta}'$  be another such configuration with the same number of + and – spins in  $B$  as  $\widehat{\eta}$ . We are going to show that  $\widehat{\eta}'$  can be reached from  $\widehat{\eta}$  with allowed particle jumps inside  $B$ .

We can assume that the empty site in  $\widehat{\eta}$  is in the center part of  $B$ , i.e. in the set of points such that the distance from the empty site to two opposing boundaries of  $B$  differs at most by 1. If it is not, we first reach the configuration  $\widehat{\eta}''$  described in Figure 14a to anticipate the transfer of the empty site from its interior position to its actual position in  $\widehat{\eta}'$ . The configuration  $\widehat{\eta}'$  can easily be reached from the configuration  $\widehat{\eta}''$ , therefore we only have to show that  $\widehat{\eta}''$  can be reached from  $\widehat{\eta}$ . Now that the empty site is at the center, we are going to update the rows and columns of particles in  $\widehat{\eta}$  in the order described in Figure 14b, starting with the smallest row or column  $R$  (which size we will denote by  $r$ ) of the domain  $B$ . Since any particle can be moved along a path of width 2 (Cf Figure 15a), we can update the whole row  $R$  except its last site, for which the path is not wide enough. To circumvent that difficulty, notice that we can rotate the spin sequence along any fixed path by rotating the empty site in the other direction. Hence, instead of rebuilding the set  $R$ , we build the  $r - 1$  last spins of  $R$  in the first  $r - 1$  slots. Then, we are able to locate the first spin of  $R$  next to the second spin. As soon as this is done, we only need to rotate the whole row by one slot as described in Figure 15b, and the whole set  $R$  of spins of  $\widehat{\eta}'$  has been reconstructed. The number of jumps necessary to update the set  $R$  is bounded from above by  $Cr^2$ . We can reiterate the process until only remains the core of size  $2 * 3$ . It is not hard to see that the set of configurations with 5 particles in a  $2 * 3$  domain is irreducible assuming that the number of + and – particles do not vary.

$$n(\eta, \eta') \leq C' \sum_{r=1}^b r^2 \leq C'' b^3, \tag{A.7}$$

where  $b$  is the length of the largest side of  $B$ . ■

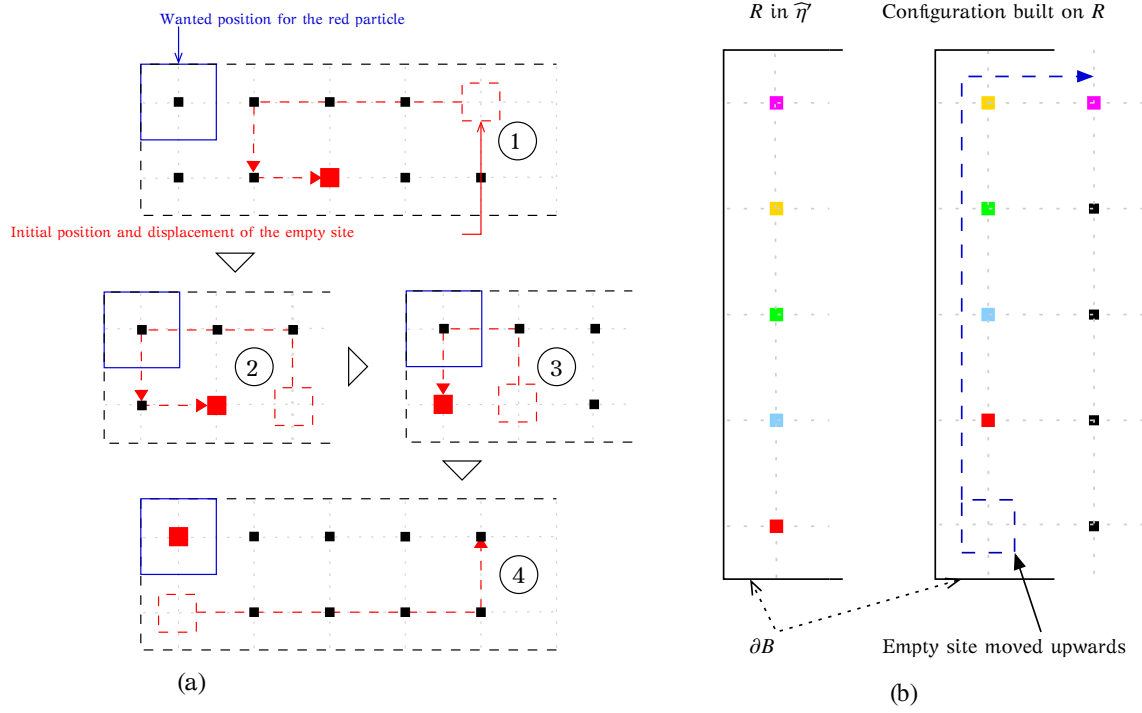

Figure 15: (b) update of a single spin in a tight corridor. (a) Update of the row  $R$ .

## B Space of parameters $\mathcal{M}_1(\mathbb{S})$

In this appendix, we prove some useful results regarding the space of parameters  $(\mathcal{M}_1(\mathbb{S}), \|\cdot\|)$  introduced in Section 2.1.

### B.1 Equivalence of ensembles

**Proposition B.1** (Equivalence of ensembles). *Let  $f$  be a cylinder function (in the sense of Definition 1.1), we have*

$$\limsup_{l \rightarrow \infty} \sup_{\widehat{K} \in \mathbb{K}_l} \left| \mathbb{E}_{l, \widehat{K}}(f) - \mathbb{E}_{\widehat{\alpha}_{\widehat{K}}}(f) \right| \rightarrow 0,$$

where the first measure is the projection along sets with  $\widehat{K}$  particles in  $B_l$ , whereas the second is the grand canonical measure with parameter  $\widehat{\alpha} = \widehat{\alpha}_{\widehat{K}}$  introduced in Definition 2.7.

*Proof of Proposition B.1:* The proof of this result is quite elementary, and is a matter of carefully writing expectations for a random sampling with (grand canonical measures) and without (canonical measures) replacement.

The proof of this problem can be reduced to the following : Consider two sampling of  $M$  integers, chosen among  $L$ . The first sampling is made without replacement, and the sampled numbers will be denoted  $X_1, \dots, X_M$ . The second sampling is made with replacement, and will be denoted  $Y_1, \dots, Y_M$ .

Then, for any function

$$g : \{1, \dots, L\}^M \rightarrow \mathbb{R},$$

we have

$$| \mathbb{E}(g(X_1, \dots, X_M)) - \mathbb{E}(g(Y_1, \dots, Y_M)) | = \|g\|_\infty o_L(1),$$

where the  $o_L(1)$  only depends on  $L$ . The proof of the last statement is elementary, and is therefore omitted here.

To come back to our Proposition,  $M$  represents the number of sites on which depends the cylinder function  $g$ ,  $L = (2l + 1)^2$  represents the number of sites in  $B_l$ , the  $X_i$ 's are the possible values for the  $\widehat{\eta}_x$ 's ( $x \in B_l$ ) under the canonical measure  $\mu_{l, \widehat{\kappa}}$ , and the  $Y_i$ 's are the possible values for the  $\widehat{\eta}_x$ 's ( $x \in B_l$ ) under the grand canonical measure  $\mu_{\widehat{\alpha}, \widehat{\kappa}}$ . ■

## B.2 Dependency of the grand canonical measures $\mu_{\widehat{\alpha}}$ in $\widehat{\alpha}$

**Proposition B.2.** *Consider the set of local profiles  $\mathcal{M}_1(\mathbb{S})$  equipped with the norm  $\| \cdot \|$  defined in Definition 2.2. Then, given a function  $g \in C$ , the application*

$$\begin{aligned} \Psi & : (\mathcal{M}_1(\mathbb{S}), \| \cdot \|) \longrightarrow \mathbb{R} \\ & \quad \widehat{\alpha} \longmapsto \mathbb{E}_{\widehat{\alpha}}(g) \end{aligned}$$

is Lipschitz-continuous with Lipschitz constant depending on the function  $g$ .

*Proof of Proposition B.2 :* Let us consider a cylinder function  $g$  depending only on vertices  $x_1, \dots, x_M$ , and let us start by assuming that  $g$  vanishes as soon as one of the sites  $x_1, \dots, x_M$  is empty. We can then rewrite  $g(\widehat{\eta})$  as  $\eta_{x_1} \dots \eta_{x_M} g(\theta_{x_1}, \dots, \theta_{x_M})$ , and  $\mathbb{E}_{\widehat{\alpha}}(g)$  as

$$\alpha^M \int_{\theta_1} \dots \int_{\theta_M} g(\theta_{x_1}, \dots, \theta_{x_M}) \frac{d\widehat{\alpha}(\theta_{x_1})}{\alpha} \dots \frac{d\widehat{\alpha}(\theta_{x_M})}{\alpha} = \int_{\theta_1} \dots \int_{\theta_M} g(\theta_{x_1}, \dots, \theta_{x_M}) d\widehat{\alpha}(\theta_{x_1}) \dots d\widehat{\alpha}(\theta_{x_M}).$$

We can now proceed by recurrence over  $M$ . Given a function  $g$  depending only on a site  $x_1$ , and for any two angle measures  $\widehat{\alpha}$  and  $\widehat{\alpha}'$  we can write

$$\mathbb{E}_{\widehat{\alpha}}(g) - \mathbb{E}_{\widehat{\alpha}'}(g) = \|g\|^* \int_{\theta_{x_1}} \frac{g(\theta_{x_1})}{\|g\|^*} d(\widehat{\alpha} - \widehat{\alpha}')(\theta_{x_1}) \leq \|g\|^* \| \widehat{\alpha} - \widehat{\alpha}' \|$$

Assuming now that the proposition is true for any function depending on  $M-1$  sites, and considering a function  $g$  depending on  $M$  vertices, we can write

$$\mathbb{E}_{\widehat{\alpha}}(g) - \mathbb{E}_{\widehat{\alpha}'}(g) = \mathbb{E}_{\widehat{\alpha}}(\mathbb{E}_{\widehat{\alpha}}(g | \widehat{\eta}_{x_2}, \dots, \widehat{\eta}_{x_M})) - \mathbb{E}_{\widehat{\alpha}'}(\mathbb{E}_{\widehat{\alpha}'}(g | \widehat{\eta}_{x_2}, \dots, \widehat{\eta}_{x_M})). \quad (\text{B.1})$$

Fix any angle  $\theta$ , and let  $g^\theta$  be the function  $g^\theta(\widehat{\eta}) = g(\theta, \theta_{x_2}, \dots, \theta_{x_M})$ , we can write thanks to the recurrence hypothesis that

$$| \mathbb{E}_{\widehat{\alpha}}(g^\theta) - \mathbb{E}_{\widehat{\alpha}'}(g^\theta) | \leq C_\theta \| \widehat{\alpha} - \widehat{\alpha}' \|,$$

which, integrated in  $\theta$  against  $\widehat{\alpha}'$ , yields

$$| \mathbb{E}_{\widehat{\alpha}'}(\mathbb{E}_{\widehat{\alpha}'}(g | \widehat{\eta}_{x_2}, \dots, \widehat{\eta}_{x_M})) - \mathbb{E}_{\widehat{\alpha}}(\mathbb{E}_{\widehat{\alpha}}(g | \widehat{\eta}_{x_2}, \dots, \widehat{\eta}_{x_M})) | \leq C_1 \| \widehat{\alpha} - \widehat{\alpha}' \|,$$

On the other hand, we can also write

$$\left| \mathbb{E}_{\widehat{\alpha}}(\mathbb{E}_{\widehat{\alpha}}(g \mid \widehat{\eta}_{x_2}, \dots, \widehat{\eta}_{x_M})) - \mathbb{E}_{\widehat{\alpha}'}(\mathbb{E}_{\widehat{\alpha}'}(g \mid \widehat{\eta}_{x_2}, \dots, \widehat{\eta}_{x_M})) \right| \leq C_2 \|\widehat{\alpha} - \widehat{\alpha}'\|,$$

therefore (B.1) yields that

$$\left| \mathbb{E}_{\widehat{\alpha}}(g) - \mathbb{E}_{\widehat{\alpha}'}(g) \right| \leq (C^1 + C^2) \|\widehat{\alpha} - \widehat{\alpha}'\|,$$

which is what we wanted to show.

To complete the proof of Proposition B.2, we now only need to extend the result to functions  $g$  which do not necessarily vanish when one site in their domain is empty. This case is easily derived, since any function  $g$  depending on vertices  $x_1, \dots, x_M$  can be rewritten

$$g(\widehat{\eta}_{x_1}, \dots, \widehat{\eta}_{x_M}) = \sum_{B \subset \{1, \dots, M\}} g_B(\theta_{x_i}, i \in B), \quad (\text{B.2})$$

where  $g_B(\theta_{x_i}, i \in B)$  is defined in the following fashion : recall that  $\widehat{\eta}_x = (\eta_x, \theta_x)$ , with  $\theta_x = 0$  if  $\eta_x = 0$ , and let us assume that  $B$  is the set of increasing indexes  $i_1, \dots, i_p$ , then  $g_B$  is defined as

$$g_B(\theta_{x_{i_1}}, \dots, \theta_{x_{i_p}}) = \eta_{x_{i_1}} \dots \eta_{x_{i_p}} g((0, 0), \dots, (0, 0), (1, \theta_{x_{i_1}}), (0, 0), \dots, (0, 0), (1, \theta_{x_{i_p}}), (0, 0), \dots, (0, 0)).$$

These functions all vanish whenever one of their depending sites is empty, therefore according to the beginning of the proof, there exists a family of constants  $C_B$  such that for any  $B \subset \{1, \dots, M\}$  we have

$$\left| \mathbb{E}_{\widehat{\alpha}}(g_B) - \mathbb{E}_{\widehat{\alpha}'}(g_B) \right| \leq C_B \|\widehat{\alpha} - \widehat{\alpha}'\|.$$

We now only need to let  $C = \sum_{B \subset \{1, \dots, M\}} C_B$  to obtain thanks to the decomposition (B.2) that

$$\left| \mathbb{E}_{\widehat{\alpha}}(g) - \mathbb{E}_{\widehat{\alpha}'}(g) \right| \leq C \|\widehat{\alpha} - \widehat{\alpha}'\|$$

as intended. This completes the proof of Proposition B.2. ■

### B.3 Compactness ( $\mathcal{M}_1(\mathbb{S}), \|\cdot\|$ )

**Proposition B.3.** *The metric space ( $\mathcal{M}_1(\mathbb{S}), \|\cdot\|$ ) introduced in Definition 2.2 is totally bounded and Cauchy complete, and is therefore compact.*

*Proof of Proposition B.3 :* The proof of the Cauchy-completeness is almost immediate, we treat it first. Consider a Cauchy sequence  $(\widehat{\alpha}_k)_{k \in \mathbb{N}} \in \mathcal{M}_1(\mathbb{S})^{\mathbb{N}}$ , then by definition of  $\|\cdot\|$ , for any  $g \in B^*$ , the sequence  $(\int_{\mathbb{S}} g(\theta) \widehat{\alpha}_k(d\theta))_k$  is a real Cauchy sequence and therefore converges, and we can let

$$\int_{\mathbb{S}} g(\theta) \widehat{\alpha}^*(d\theta) = \lim_{k \rightarrow \infty} \int_{\mathbb{S}} g(\theta) \widehat{\alpha}_k(d\theta).$$

This definition can be extended to any  $C^1(\mathbb{S})$  function  $g$  by letting

$$\int_{\mathbb{S}} g(\theta) \widehat{\alpha}^*(d\theta) = \max(\|g\|_{\infty}, \|g'\|_{\infty}) \lim_{k \rightarrow \infty} \int_{\mathbb{S}} \frac{g(\theta)}{\max(\|g\|_{\infty}, \|g'\|_{\infty})} \widehat{\alpha}_k(d\theta).$$

This defines a measure  $\widehat{\alpha}^*$  on  $\mathbb{S}$ , whose total mass is given by

$$\int_{\mathbb{T}^2} \widehat{\alpha}^*(d\theta) = \lim_{k \rightarrow \infty} \int_{\mathbb{T}^2} \widehat{\alpha}_k(d\theta) \in [0, 1],$$

which proves the Cauchy completeness of  $(\mathcal{M}_1(\mathbb{S}), \|\cdot\|)$ .

We now prove that  $(\mathcal{M}_1(\mathbb{S}), \|\cdot\|)$  is totally bounded. For any integer  $n$ , we are going to construct a finite set  $\mathcal{M}_{1,n} \subset \mathcal{M}_1(\mathbb{S})$  such that

$$\sup_{\widehat{\alpha} \in \mathcal{M}_1(\mathbb{S})} \inf_{\widehat{\alpha}' \in \mathcal{M}_{1,n}} \|\widehat{\alpha} - \widehat{\alpha}'\| \leq \frac{1}{n}.$$

For any  $n \in \mathbb{N}$  and any  $j \in \llbracket 0, n-1 \rrbracket$ , we denote  $\theta_{j,n} = 2\pi j/n$ , and  $\theta_{n,n} = \theta_{0,n} = 0$ . We can now define

$$\mathcal{M}_{1,n} = \left\{ \sum_{j=0}^{n-1} \frac{k_j}{n^2} \delta_{\theta_{j,n}}, \quad k_j \in \llbracket 0, n^2 \rrbracket, \quad \sum_j k_j \leq n^2 \right\}.$$

The inclusion  $\mathcal{M}_{1,n} \subset \mathcal{M}_1(\mathbb{S})$  is trivial thanks to the condition  $\sum_j k_j \leq n^2$ , and  $\mathcal{M}_{1,n}$  is finite since the  $k_j$ 's can each take only a finite number of values. We now prove that any angle measure  $\widehat{\alpha} \in \mathcal{M}_1(\mathbb{S})$  is at distance at most  $1/n$  of an element  $\widehat{\alpha}_n \in \mathcal{M}_{1,n}$ .

Fix an angle measure  $\widehat{\alpha} \in \mathcal{M}_1(\mathbb{S})$ , and let

$$k_j = \lfloor n^2 \widehat{\alpha}([\theta_{j,n}, \theta_{j+1,n}[) \rfloor.$$

Since  $\widehat{\alpha} \in \mathcal{M}_1(\mathbb{S})$ , its total mass is in  $[0, 1]$ , and the conditions  $k_j \in \llbracket 0, n^2 \rrbracket$  and  $\sum_j k_j \leq n^2$  are trivially verified. We now let

$$\widehat{\alpha}_n = \sum_{j=0}^{n-1} \frac{k_j}{n^2} \delta_{\theta_{j,n}},$$

and prove that  $\|\widehat{\alpha} - \widehat{\alpha}_n\| \leq 2/n$ . Fix a function  $g \in C^1(\mathbb{S})$  such that  $\max(\|g\|_\infty, \|g'\|_\infty) \leq 1$ , we can write

$$\begin{aligned} \int_{\mathbb{S}} g(\theta)(\widehat{\alpha} - \widehat{\alpha}_n)(d\theta) &= \sum_{j=0}^{n-1} \int_{\theta_{j,n}}^{\theta_{j+1,n}} g(\theta) \widehat{\alpha}(d\theta) - \frac{k_j}{n^2} g(\theta_{j,n}) \\ &= \sum_{j=0}^{n-1} \widehat{\alpha}([\theta_{j,n}, \theta_{j+1,n}[) g(\theta_{j,n}) - \frac{k_j}{n^2} g(\theta_{j,n}) + \sum_{j=0}^{n-1} \int_{\theta_{j,n}}^{\theta_{j+1,n}} (g(\theta) - g(\theta_{j,n})) \widehat{\alpha}(d\theta) \\ &\leq \sum_{j=0}^{n-1} \|g\|_\infty \underbrace{\left| \widehat{\alpha}([\theta_{j,n}, \theta_{j+1,n}[) - \frac{k_j}{n^2} \right|}_{\leq 1/n^2} + \sum_{j=0}^{n-1} \|g'\|_\infty \underbrace{|\theta_{j+1,n} - \theta_{j,n}|}_{\leq 1/n} \int_{\theta_{j,n}}^{\theta_{j+1,n}} \widehat{\alpha}(d\theta) \\ &\leq \frac{\|g\|_\infty + \|g'\|_\infty}{n} \leq 2/n. \end{aligned}$$

Finally, we have proved that

$$\|\widehat{\alpha} - \widehat{\alpha}_n\| \leq 2/n,$$

which proves that  $\mathcal{M}_1(\mathbb{S})$  is totally bounded. This, together with the Cauchy completeness, immediately yields the compactness, and concludes the proof of Proposition B.3. ■

## C Proof of Theorem 5.25 : Limiting space-time covariance

In this Appendix we give for the sake of exhaustivity the proof of Theorem 5.25. The strategy of the proof, whose heuristics has been given just after the theorem, follows the same scheme as in Section 7.4 of [KL99].

Recall that we denoted

$$\ll f \gg_{\widehat{\alpha}} = \sup_{\substack{g \in \mathcal{T}_0^\omega \\ a, b \in \mathbb{R}^2}} \left\{ 2\mathbb{E}_{\widehat{\alpha}} \left( f \cdot \left[ \Sigma_g + \sum_{y \in \mathbb{Z}^2} (y.a)\eta_y^\omega + (y.b)\eta_y \right] \right) - \|\nabla \Sigma_g + \mathbf{i}^{a,b}\|_{2,\widehat{\alpha}}^2 \right\}.$$

We first want to prove that for any sequence  $(\widehat{K}_l)_l$  such that

$$\widehat{\alpha}_{\widehat{K}_l} \xrightarrow{l \rightarrow \infty} \widehat{\alpha},$$

in the sense of Definition 2.2, and any cylinder function  $\psi$ , we have

$$\lim_{l \rightarrow \infty} \frac{1}{(2l+1)^2} \mathbb{E}_{l, \widehat{K}_l} \left( (-\mathcal{L}_l)^{-1} \sum_{x \in B_{l_\psi}} \tau_x \psi \cdot \sum_{x \in B_{l_\psi}} \tau_x \psi \right) = \ll \psi \gg_{\widehat{\alpha}}.$$

In the left-hand side above, the integer  $l_\psi$  is defined in such a way that  $\sum_{x \in B_{l_\psi}} \tau_x \psi$  is measurable with respect to the spins in  $B_l$ . We are going to prove the previous identity as two separate inequalities, stated as distinct Lemmas.

**Lemma C.1.** *Under the assumptions of Theorem 5.25,*

$$\limsup_{l \rightarrow \infty} \frac{1}{(2l+1)^2} \mathbb{E}_{l, \widehat{K}_l} \left( (-\mathcal{L}_l)^{-1} \sum_{x \in B_{l_\psi}} \tau_x \psi \cdot \sum_{x \in B_{l_\psi}} \tau_x \psi \right) \leq \ll \psi \gg_{\widehat{\alpha}}.$$

*Proof of Lemma C.1 :* The first step to prove the inequality above is the replacement of the canonical measure  $\mu_{\widehat{K}_l, l}$  by the grand canonical measure  $\mu_{\widehat{\alpha}}$  thanks to the equivalence of ensembles stated in Proposition B.1. The main obstacle in doing so is that the support of the function whose expectation we want to estimate grows with  $l$ . To circumvent this obstacle, we split the sum of translations of  $\psi$  in finite boxes with respect to  $l$  and bound the difference.

Since the Dirichlet form is non-negative, the application  $(f, g) \rightarrow -\mathbb{E}_{l, \widehat{K}_l}(f \mathcal{L}_l g)$  is an inner product on the subspace of  $C_0$  of functions measurable w.r.t.  $\mathcal{F}_l$ . We proved along with the integration by parts formula of Lemma 4.1, any such  $f$  is in the range of  $\mathcal{L}_l$ , and can be rewritten  $f = -\mathcal{L}_l g$ , thus

$$\mathbb{E}_{\widehat{K}_l, l}(f(-\mathcal{L}_l)^{-1}f)^{1/2} = \mathbb{E}(g(-\mathcal{L}_l)g)^{1/2}$$

is a norm and defines via polarization identities another inner product. We are therefore able to write the variational formula

$$\mathbb{E}_{l, \widehat{K}_l} \left( (-\mathcal{L}_l)^{-1} \sum_{x \in B_{l_\psi}} \tau_x \psi \cdot \sum_{x \in B_{l_\psi}} \tau_x \psi \right) = \sup_{h \in \mathcal{T}_0^\omega} \left\{ 2\mathbb{E}_{l, \widehat{K}_l} \left( \sum_{x \in B_{l_\psi}} \tau_x \psi \cdot h \right) - \mathbb{E}_{l, \widehat{K}_l} (h \cdot (-\mathcal{L}_l h)) \right\}$$



The second term in the right-hand side is the Dirichlet form of the exclusion process restricted  $\Sigma_l^{\widehat{K}_l}$ , which we denote by  $\mathcal{D}(\mu_{l,\widehat{K}_l}, h)$ . Regarding the first part, thanks to the integration by parts formula stated in Lemma 4.1 and to the elementary inequality  $2ab \leq \gamma^{-1}a^2 + \gamma b^2$ , we can write

$$\begin{aligned} 2\mathbb{E}_{l,\widehat{K}_l} \left( \sum_{x \in B_{l,\psi}} \tau_x \psi \cdot h \right) &= 2 \sum_{x \in B_{l,\psi}} \sum_{a \in B_\psi(x)} \mathbb{E}_{l,\widehat{K}_l} (I_a(\tau_x \psi) \cdot \nabla_a h) \\ &\leq \sum_{x \in B_{l,\psi}} \sum_{a \in B_\psi(x)} \frac{1}{\gamma} \mathbb{E}_{l,\widehat{K}_l} (I_a(\tau_x \psi)^2) + \gamma \mathbb{E}_{l,\widehat{K}_l} ((\nabla_a h)^2) \end{aligned}$$

which holds for any positive constant  $\gamma$ . The first term  $\gamma^{-1} \sum_{a \in B_\psi(x)} \mathbb{E}_{l,\widehat{K}_l} (I_a(\tau_x \psi)^2)$  does not depend on  $x$ , and since  $\psi$  is a local function,  $\mathbb{E}_{l,\widehat{K}_l} (I_a(\tau_x \psi)^2)$  is bounded by some constant depending only on  $\psi$ . The first part of the whole sum above is therefore bounded by  $\gamma^{-1}(2l+1)^2 |B_\psi| C_1(\psi)$ . Regarding the second term, the number of time each edge  $a$  appears can be crudely bounded by  $2|B_\psi|$ , which means that

$$\gamma \sum_{x \in B_{l,\psi}} \sum_{a \in x+B_\psi} \mathbb{E}_{l,\widehat{K}_l} ((\nabla_a h)^2) \leq 2\gamma |B_\psi| \mathcal{D}(\mu_{l,\widehat{K}_l}, h),$$

therefore for some well chosen constant  $\gamma$

$$2\mathbb{E}_{l,\widehat{K}_l} \left( \sum_{x \in B_{l,\psi}} \tau_x \psi \cdot h \right) \leq (2l+1)^2 C_3(\psi) + \frac{1}{2} \mathcal{D}(\mu_{l,\widehat{K}_l}, h) \quad (\text{C.1})$$

and we have the upper bound

$$\mathbb{E}_{l,\widehat{K}_l} \left( (-\mathcal{L}_l)^{-1} \sum_{x \in B_{l,\psi}} \tau_x \psi \cdot \sum_{x \in B_{l,\psi}} \tau_x \psi \right) \leq \sup_{h \in \mathcal{T}_0^\omega} \left\{ (2l+1)^2 C_3(\psi) - \frac{1}{2} \mathcal{D}(\mu_{l,\widehat{K}_l}, h) \right\}.$$

The left-hand side is non-negative, whereas the quantity inside braces is negative for any function  $h$  with Dirichlet form  $\mathcal{D}(\mu_{l,\widehat{K}_l}, h)$  greater than  $2(2l+1)^2 C_3(\psi)$ . Regarding the variational formula above, we can therefore restrict ourselves to functions  $h$  with Dirichlet form bounded by  $2(2l+1)^2 C_3(\psi)$ .

As in the proof of the one-block-estimate, let  $k$  be an integer that will go to  $\infty$  after  $l$ , and let us divide  $B_l$  into disjoint boxes  $B^0, \dots, B^p$ , where  $p = \lfloor \frac{(2l+1)^2}{(2k+1)^2} \rfloor$ , and  $B^0 = B_l - \cup_{i=1}^p B^i$ , whose cardinal is bounded by  $Ckl$  for some constant  $C$ . Recall that  $s_\psi$  is the smallest integer such that  $\psi$  is measurable with respect to the spins in  $B_{s_\psi}$ . Let us denote by  $\mathring{B}^i$  and  $\partial B^i$  the interior and the frontier of  $B^i$ , defined as

$$\mathring{B}^i = \{x \in B^i, d(x, B^{i,c}) \geq s_\psi\} \text{ and } \partial B^i = B^i - \mathring{B}^i.$$

Finally, let us denote

$$\mathring{B}_l = \cup_{i=1}^p \mathring{B}^i \text{ and } \partial B_l = B_l - \mathring{B}_l.$$

Let  $h$  be a function in  $\mathcal{T}_0^\omega$ , we can split

$$\sum_{x \in B_{l,\psi}} \mathbb{E}_{l,\widehat{K}_l} (\tau_x \psi \cdot h) = \sum_{x \in B_l} \mathbb{E}_{l,\widehat{K}_l} (\tau_x \psi \cdot h) + \sum_{x \in \partial B_l \cap B_{l,\psi}} \mathbb{E}_{l,\widehat{K}_l} (\tau_x \psi \cdot h). \quad (\text{C.2})$$

With the same method we used to get equation (C.1), we obtain that the second part of the right-hand side of the equation above can be bounded up by

$$C_4(\psi) \min_{\gamma>0} \{\gamma^{-1} |\partial B_l| + \gamma l^2\}$$

for any  $h$  with Dirichlet form bounded by  $C_5(\psi)l^2$ . This minimum is obtained for  $\gamma = \sqrt{|\partial B_l|}l^{-2}$ . The number of boundary sites in  $|\partial B_l|$  can also be bounded by the number of sites in the boundaries of the  $B^i$ 's added to the number of terms in  $B^0$ , hence  $|\partial B_l| \leq C_6(\psi)(l^2k^{-1} + kl)$  this yields that

$$\sum_{x \in \partial B_l \cap B_l^\psi} \mathbb{E}_{l, \widehat{K}_l}(\tau_x \psi \cdot h) = C_7(\psi) \sqrt{|\partial B_l|} l^2 \leq C_8(\psi) l^2 \sqrt{k^{-1} + kl^{-1}}$$

Regarding the first part of the right-hand side in equation (C.2), we defined the  $\hat{B}^i$ 's in such a way that for any  $x \in \hat{B}^i$ ,  $\tau_x \psi$  is measurable with respect to the spins in  $B^i$ . In that prospect, for any function  $h$ , let us denote  $h_i = \mathbb{E}_{l, \widehat{K}_l}(h | \eta_x, x \in B^i)$  the conditional expectation of  $h$  with respect to the spins in  $B^i$ . We hence have for any  $x \in B^i$  that  $\mathbb{E}_{l, \widehat{K}_l}(h \tau_x \psi) = \mathbb{E}_{l, \widehat{K}_l}(h_i \tau_x \psi)$ . For any finite set  $B$ , let  $\mathcal{D}_B(\mu_{l, \widehat{K}_l}, h)$  be the restriction of the Dirichlet form to edges with both ends in  $B$ . Because we lost the edges between the  $B^i$ 's, and thanks to the convexity of the Dirichlet form already used, we have

$$\mathcal{D}(\mu_{l, \widehat{K}_l}, h) \geq \sum_{i=1}^p \mathcal{D}_{B^i}(\mu_{l, \widehat{K}_l}, h) \geq \sum_{i=1}^p \mathcal{D}_{B^i}(\mu_{l, \widehat{K}_l}, h_i),$$

therefore  $2\mathbb{E}_{l, \widehat{K}_l}(\sum_{x \in B_l^\psi} \tau_x \psi \cdot h) - \mathbb{E}_{\widehat{K}_l, l}(h \cdot (-\mathcal{L}_l h))$  is less than

$$\sum_{i=1}^p \left\{ 2 \sum_{x \in \hat{B}^i} \mathbb{E}_{l, \widehat{K}_l}(\tau_x \psi \cdot h_i) - \mathcal{D}_{B^i}(\mu_{l, \widehat{K}_l}, h_i) \right\} + C_8(\psi) l^2 \sqrt{k^{-1} + kl^{-1}}.$$

Let  $M_k$  be the space of functions in  $\mathcal{T}_0^\omega$  measurable with respect to the spins in  $B_k$ , the supremum of the expression above over all functions  $h$  can be bounded from above, since all the terms in the sum in  $i$  above are identically distributed, by

$$p \cdot \sup_{f \in M_k} \left\{ 2 \sum_{x \in \hat{B}_k} \mathbb{E}_{l, \widehat{K}_l}(\tau_x \psi \cdot f) - \mathcal{D}_{B_k}(\mu_{l, \widehat{K}_l}, f) \right\} + C(\psi)(2l+1)^2 \sqrt{k^{-1} + kl^{-1}}.$$

Now since  $p$  is roughly equal to  $(2l+1)^2(2k+1)^{-2}$ , the quantity of interest to prove Lemma C.1

$$\limsup_{l \rightarrow \infty} \frac{1}{(2l+1)^2} \mathbb{E}_{l, \widehat{K}_l} \left( \mathcal{L}_l^{-1} \sum_{x \in B_l^\psi} \tau_x \psi \cdot \sum_{x \in B_l^\psi} \tau_x \psi \right)$$

is bounded from above for any  $k$  by

$$\frac{1}{(2k+1)^2} \limsup_{l \rightarrow \infty} \sup_{f \in M_k} \left\{ 2 \sum_{x \in \hat{B}_k} \mathbb{E}_{l, \widehat{K}_l}(\tau_x \psi \cdot f) - \mathcal{D}_{B_k}(\mu_{l, \widehat{K}_l}, f) \right\} + C(\psi) \sqrt{k^{-1}}$$

$$= \frac{1}{(2k+1)^2} \limsup_{l \rightarrow \infty} \mathbb{E}_{l, \widehat{K}_l} \left( \left[ \sum_{|x| \leq k-s_\psi} \tau_x \psi \right] (-\mathcal{L}_k)^{-1} \left[ \sum_{|x| \leq k-s_\psi} \tau_x \psi \right] \right) + C(\psi) \sqrt{k^{-1}}$$

thanks to the variational formula for the variance introduced at the beginning of the proof. Thanks to the equivalence of ensembles stated in Proposition B.1, since the function inside the expectation now has finite support, we can replace in the limit  $l$  goes to infinity and  $\widehat{K}_l(2l+1)^{-2} \rightarrow \widehat{\alpha}$  the expectation above by the grand canonical measure  $\mu_{\widehat{\alpha}}$ . Finally, taking the limit as  $k \rightarrow \infty$ ,

$$\limsup_{l \rightarrow \infty} \frac{1}{(2l+1)^2} \mathbb{E}_{l, \widehat{K}_l} \left( (-\mathcal{L}_l)^{-1} \sum_{x \in B_{l_\psi}} \tau_x \psi \cdot \sum_{x \in B_{l_\psi}} \tau_x \psi \right) \leq \limsup_{k \rightarrow \infty} \frac{1}{(2k+1)^2} \mathbb{E}_{\widehat{\alpha}} \left( (-\mathcal{L}_k)^{-1} \sum_{x \in B_{k_\psi}} \tau_x \psi \cdot \sum_{x \in B_{k_\psi}} \tau_x \psi \right).$$

Now that we have replaced the canonical measure by the grand canonical measure, we are ready to complete the proof of Lemma C.1, which is reduced to showing that

$$\limsup_{k \rightarrow \infty} \frac{1}{(2k+1)^2} \mathbb{E}_{\widehat{\alpha}} \left( (-\mathcal{L}_k)^{-1} \sum_{x \in B_{k_\psi}} \tau_x \psi \cdot \sum_{x \in B_{k_\psi}} \tau_x \psi \right) \leq \ll \psi \gg_{\widehat{\alpha}}. \quad (\text{C.3})$$

The left-hand side in the equation above is equal thanks to the variational formula for the variance to

$$\frac{1}{(2k+1)^2} \sup_{f \in M_k} \left\{ 2 \sum_{x \in B_{k_\psi}} \mathbb{E}_{\widehat{\alpha}} (\tau_x \psi \cdot f) - \mathcal{D}_{B_k}(\mu_{\widehat{\alpha}}, f) \right\}.$$

For the same reason as before, for some constant  $C(\psi)$ , the quantity above is negative for any  $f$   $\sigma(\mathcal{F}_k)$ -measurable with Dirichlet form with respect to  $\mu_{\widehat{\alpha}}$  not bounded by  $C(\psi)k^2$ . Using once again the integration by parts formula of Lemma 4.1 yields

$$\mathbb{E}_{\widehat{\alpha}} (\tau_x \psi \cdot f) = \sum_{x \in B_\psi(x)} \mathbb{E}_{\widehat{\alpha}} (I_a(\tau_x \psi) \nabla_a f),$$

where  $I_a(\psi) = (1/2) \nabla_a (-\mathcal{L}_{s_\psi})^{-1} \psi$ . For any edge  $a$ , let us denote  $B^\psi(a)$  the set of sites  $x \in \mathbb{Z}^2$  such that  $a$  is in  $B_\psi(x)$ , and  $\widetilde{B}_k^\psi(a) = B^\psi(a) \cap B_{k_\psi}$ . Note that for any edge  $a \in B_{k_\psi-s_\psi}$ , these two sets coincide. The integration by parts formula then allows us to write

$$\begin{aligned} \sum_{x \in B_{k_\psi}} \mathbb{E}_{\widehat{\alpha}} (\tau_x \psi \cdot f) &= \sum_{a \in B_k} \sum_{x \in \widetilde{B}_k^\psi(a)} \mathbb{E}_{\widehat{\alpha}} (I_a(\tau_x \psi) \nabla_a f) \\ &= \sum_{a \in B_k} \sum_{x \in B^\psi(a)} \mathbb{E}_{\widehat{\alpha}} (I_a(\tau_x \psi) \nabla_a f) - \sum_{a \in B_k} \sum_{x \in B^\psi - \widetilde{B}_k^\psi(a)} \mathbb{E}_{\widehat{\alpha}} (I_a(\tau_x \psi) \nabla_a f) \\ &= \sum_{a \in B_k} \sum_{x \in B^\psi(a)} \mathbb{E}_{\widehat{\alpha}} (I_a(\tau_x \psi) \nabla_a f) - \sum_{a \in B_k - B_{k_\psi-s_\psi}} \sum_{x \in B^\psi - \widetilde{B}_k^\psi(a)} \mathbb{E}_{\widehat{\alpha}} (I_a(\tau_x \psi) \nabla_a f). \end{aligned}$$

By Schwarz inequality, the second sum in the right-hand side is smaller than

$$\sum_{a \in B_k - B_{k_\psi-s_\psi}} \sum_{x \in B^\psi - \widetilde{B}_k^\psi(a)} \mathbb{E}_{\widehat{\alpha}} (I_a(\tau_x \psi) \nabla_a f)$$

$$\begin{aligned}
&\leq \mathbb{E}_{\widehat{\alpha}} \left[ \left( \sum_{a \in B_k - B_{k\psi - s\psi}} \left( \sum_{x \in B^\psi - \bar{B}_k^\psi(a)} I_a(\tau_x \psi) \right) \right)^2 \right]^{1/2} \left( \sum_{a \in B_k - B_{k\psi - s\psi}} (\nabla_a f)^2 \right)^{1/2} \\
&\leq \mathbb{E}_{\widehat{\alpha}} \left[ \sum_{a \in B_k - B_{k\psi - s\psi}} \left( \sum_{x \in B^\psi - \bar{B}_k^\psi(a)} I_a(\tau_x \psi) \right)^2 \right]^{1/2} \mathbb{E}_{\widehat{\alpha}} \left[ \sum_{a \in B_k - B_{k\psi - s\psi}} (\nabla_a f)^2 \right]^{1/2} \\
&\leq \mathbb{E}_{\widehat{\alpha}} \left[ \sum_{a \in B_k - B_{k\psi - s\psi}} \sum_{x \in B^\psi} Ck I_a(\tau_x \psi)^2 \right]^{1/2} [\mathcal{D}_{B_k}(\mu_{\widehat{\alpha}}, f)]^{1/2}, \\
&\leq \left( Ck \sum_{a \in B_k - B_{k\psi - s\psi}} \underbrace{\mathbb{E}_{\widehat{\alpha}} \left[ \sum_{x \in B^\psi} I_a(\tau_x \psi)^2 \right]}_{\leq C(\psi)} \right)^{1/2} [\mathcal{D}(f)]^{1/2}.
\end{aligned}$$

The latter is of order  $k^{d/2}$ , and therefore vanishes in the limit  $k \rightarrow \infty$ . Letting  $\bar{I}_a(\psi) = \sum_{x \in B^\psi(a)} I_a(\tau_x \psi)$ , the left-hand side of equation (C.3) is therefore smaller in the limit  $k \rightarrow \infty$  than

$$\frac{1}{(2k+1)^2} \sup_{f \in M_k} \left\{ 2 \sum_{a \in B_k} \mathbb{E}_{\widehat{\alpha}}(\bar{I}_a(\psi) \nabla_a f) - \mathcal{D}_{B_k}(\mu_{\widehat{\alpha}}, f) \right\}.$$

Let  $(f_k)_k$  be a family of functions such that  $f_k$  is  $\mathcal{F}_{B_k}$ -measurable function in  $T_0$ , such that the limsup of the quantity above verifies

$$\begin{aligned}
&\limsup_{k \rightarrow \infty} \frac{1}{(2k+1)^2} \sup_{f \in M_k} \left\{ 2 \sum_{a \in B_k} \mathbb{E}_{\widehat{\alpha}}(\bar{I}_a(\psi) \nabla_a f) - \mathcal{D}_{B_k}(\mu_{\widehat{\alpha}}, f) \right\} \\
&= \lim_{k \rightarrow \infty} \frac{1}{(2k+1)^2} \left\{ 2 \sum_{a \in B_k} \mathbb{E}_{\widehat{\alpha}}(\bar{I}_a(\psi) \nabla_a f_k) - \mathcal{D}_{B_k}(\mu_{\widehat{\alpha}}, f_k) \right\}. \quad (\text{C.4})
\end{aligned}$$

Thanks to the translation invariance of  $\mu_{\widehat{\alpha}}$ , and since  $\tau_y \bar{I}_a(\psi) = \bar{I}_{\tau_y a}(\psi)$ , letting  $y = a_1$  be the first site of the edge  $a = (a_1, a_2)$ , we have

$$\mathbb{E}_{\widehat{\alpha}}(\bar{I}_a(\psi) \nabla_a f_k) = \mathbb{E}_{\widehat{\alpha}}(\bar{I}_{(0, a_2 - a_1)}(\psi) \nabla_{(0, a_2 - a_1)} \tau_{-a_1} f_k).$$

As seen before, a simple change of variable yields that  $\mathbb{E}_{\widehat{\alpha}}(\nabla_a f \cdot \nabla_a g) = \mathbb{E}_{\widehat{\alpha}}(\nabla_{-a} f \cdot \nabla_{-a} g)$ , from which we deduce

$$2 \sum_{a \in B_k} \mathbb{E}_{\widehat{\alpha}}(\bar{I}_a(\psi) \nabla_a f_k) = 4 \sum_{i=1}^2 \mathbb{E}_{\widehat{\alpha}} \left( \bar{I}_{(0, e_i)}(\psi) \cdot \nabla_{(0, e_i)} \sum_{x, x+e_i \in B_k} \tau_{-x} f_k \right).$$

Let us introduce

$$\mathbf{u}_i^k = \frac{1}{(2k+1)^2} \nabla_{(0, e_i)} \sum_{x, x+e_i \in B_k} \tau_{-x} f_k \in T_i^\omega,$$

where  $T_i^\omega = \overline{T_0^\omega}$  is the closure of  $T_0^\omega$  in  $E_i$

$$E_i = \left\{ f, \mathbb{E}_{\widehat{\alpha}} \left( \mathbb{1}_{\{\eta_0 \eta_{e_i} = 0\}} f^2 \right) < \infty \right\}.$$

The  $L^2$  norm of the differential form  $\mathbf{u}^k$  can be bounded since  $(\sum_{i=1}^n a_i)^2 \leq n \sum_{i=1}^n a_i^2$  by

$$\begin{aligned} \sum_{i=1}^2 \mathbb{E}_{\widehat{\alpha}}((\mathbf{u}_i^k)^2) &\leq \frac{2k(2k+1)}{(2k+1)^4} \sum_{x, x+e_i \in B_k} \mathbb{E}_{\widehat{\alpha}} \left( (\nabla_{(x, x+e_i)} f_k)^2 \right) \\ &= \frac{2k}{(2k+1)^3} \mathcal{D}_{B_k}(\mu_{\widehat{\alpha}}, f_k) \end{aligned}$$

Thanks to this inequality, equation (C.4) yields

$$(2k+1)^{-2} \mathbb{E}_{\widehat{\alpha}} \left( (-\mathcal{L}_k)^{-1} \sum_{x \in B_{k\psi}} \tau_x \psi \cdot \sum_{x \in B_{k\psi}} \tau_x \psi \right) \leq \lim_{k \rightarrow \infty} \left\{ 4 \sum_{i=1}^2 \mathbb{E}_{\widehat{\alpha}}(\bar{I}_{(0, e_i)}(\psi) \cdot \mathbf{u}_i^k) - \sum_{i=1}^2 \mathbb{E}_{\widehat{\alpha}}((\mathbf{u}_i^k)^2) \right\}$$

The inequality above and the control over the Dirichlet form of the  $f_k$ 's guarantee that the sequence of differential forms  $(\mathbf{u}^k)_{k \in \mathbb{N}}$  is bounded in  $L^2(\mu_{\widehat{\alpha}})$ . Let  $\mathbf{u} = (\mathbf{u}_1, \mathbf{u}_2)$  be a limit point of the sequence, thanks to the gradient in the expression of the  $\mathbf{u}^k$ 's,  $\mathbf{u}$  is in  $\mathfrak{C}_{\widehat{\alpha}} \cap \mathfrak{I}^\omega$ , as introduced in Section 5.6. Proposition 5.14 thus yields the estimate

$$\begin{aligned} \lim_{k \rightarrow \infty} \left\{ 4 \sum_{i=1}^2 \mathbb{E}_{\widehat{\alpha}}(\bar{I}_{(0, e_i)}(\psi) \cdot \mathbf{u}_i^k) - \sum_{i=1}^2 \mathbb{E}_{\widehat{\alpha}}((\mathbf{u}_i^k)^2) \right\} \\ \leq \sup_{\substack{g \in \mathcal{T}_0^\omega \\ a, b \in \mathbb{R}^2}} \left\{ 4 \sum_{i=1}^2 \mathbb{E}_{\widehat{\alpha}}(\bar{I}_{(0, e_i)}(\psi) \cdot (\mathbf{i}_i^{a,b} + \nabla_{(0, e_i)} \Sigma_g)) - \sum_{i=1}^2 \mathbb{E}_{\widehat{\alpha}}((\mathbf{i}_i^{a,b} + \nabla \Sigma_g)^2) \right\} \\ = \sup_{\substack{g \in \mathcal{T}_0^\omega \\ a, b \in \mathbb{R}^2}} \left\{ 2 \mathbb{E}_{\widehat{\alpha}} \left( \psi \cdot \left[ \Sigma_g + \sum_{y \in \mathbb{Z}^2} (y \cdot a) \eta_y^\omega + (y \cdot b) \eta_y \right] \right) - \|\nabla \Sigma_g + \mathbf{i}^{a,b}\|_{2, \widehat{\alpha}}^2 \right\}. \end{aligned}$$

The last identity is easily checked and is a direct consequence of the integration by parts formula (cf. Proof of Proposition 5.27 in Section 5.8). The right-hand-side above is  $\ll \cdot \gg_{\widehat{\alpha}}$  as defined in Theorem 5.25, which concludes the proof of the first Lemma.  $\blacksquare$

The second inequality is more straightforward, since this time the supremum works in our favor.

**Lemma C.2.** *Under the assumption of Theorem 5.25,*

$$\limsup_{l \rightarrow \infty} \frac{1}{(2l+1)^2} \mathbb{E}_{l, \widehat{K}_l} \left( (-\mathcal{L}_l^{-1}) \sum_{x \in B_{l\psi}} \tau_x \psi \cdot \sum_{x \in B_{l\psi}} \tau_x \psi \right) \geq \ll \psi \gg_{\widehat{\alpha}}. \quad (\text{C.5})$$

*Proof of Lemma C.2 :* We start once again with the variational formula

$$\begin{aligned} -\mathbb{E}_{l, \widehat{K}_l} \left( \mathcal{L}_l^{-1} \sum_{x \in B_{l_\psi}} \tau_x \psi \cdot \sum_{x \in B_{l_\psi}} \tau_x \psi \right) &= \sup_{h \in L^2(\mu_{l, \widehat{K}_l}) \cap T_0} \left\{ 2\mathbb{E}_{l, \widehat{K}_l} \left( \sum_{x \in B_{l_\psi}} \tau_x \psi \cdot h \right) - \mathbb{E}_{\widehat{K}_l} (h \cdot (-\mathcal{L}_l h)) \right\} \\ &\geq \sup_{h \in F} \left\{ 2\mathbb{E}_{l, \widehat{K}_l} \left( \sum_{x \in B_{l_\psi}} \tau_x \psi \cdot h \right) - \mathbb{E}_{\widehat{K}_l} (h \cdot (-\mathcal{L}_l h)) \right\}, \end{aligned} \quad (\text{C.6})$$

where  $F$  is the subspace of  $L^2(\mu_{l, \widehat{K}_l}) \cap T_0$

$$F = F_l = \left\{ h_{g,a,b,l} = \sum_{x \in B_{l_g}} \tau_x g + \sum_{x \in B_l} ((a \cdot x) \eta_x^\omega + (b \cdot x) \eta_x), \quad g \in \mathcal{T}_0^\omega, a, b \in \mathbb{R}^2 \right\}.$$

We first show that in the variational formula above, we can replace in the limit  $l \rightarrow \infty$  the canonical measures by the grand canonical measure  $\mu_{\widehat{\alpha}}$ . Regarding the first term, for any  $h_{g,a,b} \in F$ ,

$$\frac{1}{(2l+1)^2} \mathbb{E}_{l, \widehat{K}_l} \left( \sum_{x \in B_{l_\psi}} \tau_x \psi \cdot h_{g,a,b,l} \right) = \frac{1}{(2l+1)^2} \sum_{x \in B_{l_\psi}} \mathbb{E}_{l, \widehat{K}_l} \left( \tau_x \psi \left[ \sum_{|y| \leq l_g} \tau_y g + \sum_{y \in B_l} ((a \cdot y) \eta_y^\omega + (b \cdot y) \eta_y) \right] \right).$$

This time, for some fixed  $x \in B_{l_\psi}$ , the function inside the expectation is local because  $\tau_x \psi$  is, and Proposition B.1 guarantees that in the limit of the quantity above as  $l \rightarrow \infty$ , we can replace  $\mu_{l, \widehat{K}_l}$  by  $\mu_{\widehat{\alpha}}$ . The translation invariance of  $\mu_{\widehat{\alpha}}$ , then yields

$$\lim_{l \rightarrow \infty} \frac{1}{(2l+1)^2} \mathbb{E}_{l, \widehat{K}_l} \left( \sum_{x \in B_{l_\psi}} \tau_x \psi \cdot h_{g,a,b,l} \right) = \mathbb{E}_{\widehat{\alpha}} \left( \psi \sum_{y \in \mathbb{Z}^2} \left[ \tau_y g + \sum_{i=1}^2 ((a \cdot x) \eta_y^\omega + (b \cdot y) \eta_y) \right] \right).$$

Let us now switch to the second part of (C.6). For any  $h = h_{g,a,b,l} \in F$ , we have, since

$$\sum_{|x| \leq l} x_i \mathcal{L}_l \eta_x^\omega = \sum_{x, x+e_i \in B_l} j_{x, x+e_i}^\omega,$$

that

$$\begin{aligned} \frac{1}{(2l+1)^2} \mathbb{E}_{\widehat{K}_l} (h \cdot (-\mathcal{L}_l h)) &= \frac{1}{(2l+1)^2} \left( -\mathbb{E}_{l, \widehat{K}_l} \left( \left[ \sum_{|x| \leq l_g} \tau_x g \right] \mathcal{L}_l \left[ \sum_{|x| \leq l_g} \tau_x g \right] \right) \right. \\ &\quad \left. - 2 \mathbb{E}_{l, \widehat{K}_l} \left( \left[ \sum_{|x| \leq l_g} \tau_x g \right] \cdot \left[ \sum_{x, x+e_i \in B_l} \tau_x (a \cdot j^\omega) + (b \cdot j) \right] \right) \right. \\ &\quad \left. - \mathbb{E}_{l, \widehat{K}_l} \left( \left[ \sum_{y \in B_l} ((a \cdot y) \eta_y^\omega + (b \cdot y) \eta_y) \right] \cdot \left[ \sum_{x, x+e_i \in B_l} \tau_x (a \cdot j^\omega) + (b \cdot j) \right] \right) \right) \end{aligned}$$

Since there is no  $\mathcal{L}_l^{-1}$ , the functions are all still cylinder, and the equivalence of ensembles allows us to replace  $\mu_{l,\widehat{K}_l}$  by  $\mu_{\widehat{\alpha}}$ . The first term in the right-hand side above can be rewritten thanks to the integration by parts formula as

$$\frac{1}{2(2l+1)^2} \sum_{a \subset B_l} \mathbb{E}_{l,\widehat{K}_l} \left( \left[ \nabla_a \sum_{|x| \leq l_g} \tau_x g \right]^2 \right) = \frac{1}{(2l+1)^2} \sum_{x,x+e_i \in B_l} \mathbb{E}_{l,\widehat{K}_l} \left( \left[ \nabla_{x,x+e_i} \sum_{|y| \leq l_g} \tau_y g \right]^2 \right).$$

For any  $x \in B_{l-s_\psi-2}$ , we have  $\nabla_{x,x+e_i} \sum_{|y| \leq l_g} \tau_y g = \nabla_{x,x+e_i} \Sigma_g$ , and since the number of terms in the crown  $B_l - B_{l-s_\psi-2}$  is a  $o(l^2)$ , the previous quantity rewrites by translation invariance, in the limit  $l \rightarrow \infty$  as  $\mathbb{E}_{\widehat{\alpha}} \left( (\nabla \Sigma_g)^2 \right)$ . Elementary computation and the translation invariance of  $\mu_{\widehat{\alpha}}$  yield that the second term

$$-\frac{2}{(2l+1)^2} \mathbb{E}_{l,\widehat{K}_l} \left( \left[ \sum_{|x| \leq l_g} \tau_x g \right] \cdot \left[ \sum_{x,x+e_i \in B_l} \tau_x (a \cdot j^\omega) + (b \cdot j) \right] \right) \xrightarrow{l \rightarrow \infty} -2 \mathbb{E}_{\widehat{\alpha}} \left( [(a \cdot j^\omega) + (b \cdot j)] \Sigma_g \right).$$

Let us consider only the contribution of  $j_1^\omega$  in the right-hand side in the identity above. The corresponding contribution is

$$\mathbb{E}_{\widehat{\alpha}} \left( j_1^\omega \Sigma_g \right) = \mathbb{E}_{\widehat{\alpha}} \left( \eta_0^\omega (1 - \eta_{e_1}) \Sigma_g(\widehat{\eta}) \right) - \mathbb{E}_{\widehat{\alpha}} \left( \eta_{e_1}^\omega (1 - \eta_0) \Sigma_g(\widehat{\eta}) \right) = -\mathbb{E}_{\widehat{\alpha}} \left( \eta_0^\omega (1 - \eta_{e_1}) \nabla_i \Sigma_g \right),$$

which is equal to  $-\mathbb{E}_{\widehat{\alpha}}(\mathbf{i}^i \cdot \nabla \Sigma_g)$ . We deduce from this the identity

$$\mathbb{E}_{\widehat{\alpha}} \left( [(a \cdot j^\omega) + (b \cdot j)] \Sigma_g \right) = -\mathbb{E}_{\widehat{\alpha}}(\mathbf{i}^{a,b} \cdot \nabla \Sigma_g).$$

Finally, elementary computations allow us to write regarding the last term

$$\begin{aligned} \frac{1}{(2l+1)^2} -\mathbb{E}_{l,\widehat{K}_l} \left( \left[ \sum_{y \in B_l} ((a \cdot y) \eta_y^\omega + (b \cdot y) \eta_y) \right] \cdot \left[ \sum_{x,x+e_i \in B_l} \tau_x (a \cdot j^\omega) + (b \cdot j) \right] \right) \\ \xrightarrow{l \rightarrow \infty} \mathbb{E}_{\widehat{\alpha}} \left( \|a\|^2 \eta_0^\omega (1 - \eta_{e_1}) + \|b\|^2 \eta_0 (1 - \eta_{e_1}) \right), \end{aligned}$$

which is equal to  $\mathbb{E}_{\widehat{\alpha}}(\|\mathbf{i}^{a,b}\|^2)$ . These three limits finally yield

$$\lim_{l \rightarrow \infty} \frac{1}{(2l+1)^2} \mathbb{E}_{\widehat{K}_l} \left( h_{g,a,b,l} \cdot (-\mathcal{L}) h_{g,a,b,l} \right) = \|\nabla \Sigma_g + \mathbf{i}^{a,b}\|_{2,\widehat{\alpha}}^2,$$

and equation (C.6) holds, which gives inequality (C.5) and concludes the proof of the Lemma. ■

In order to complete the proof of Theorem 5.25, we still need to prove that the convergence is uniform in  $\widehat{\alpha}$ , which will yield identity (5.82). Let us denote

$$V_{l,\psi}(\widehat{K}(2l+1)^{-2}) = \frac{1}{(2l+1)^2} \mathbb{E}_{l,\widehat{K}_l} \left( -\mathcal{L}_l^{-1} \sum_{x \in B_{l,\psi}} \tau_x \psi \cdot \sum_{x \in B_{l,\psi}} \tau_x \psi \right),$$

and let us extend smoothly the domain of definition of  $V_{l,\psi}$  to  $\mathcal{M}_1(\mathbb{S})$ . The two previous Lemmas guarantee that  $V_{l,\psi}(\widehat{K}_l(2l+1)^{-2})$  converges as  $l$  goes to  $\infty$  to  $\ll \psi \gg_{\widehat{\alpha}}$  as soon as  $\widehat{K}_l$  converges towards the profile  $\widehat{\alpha}$ , hence in particular,  $V_{l,\psi}(\widehat{\alpha}_l)$  converges as  $l$  goes to  $\infty$  towards  $\ll \psi \gg_{\widehat{\alpha}}$  as soon as  $\widehat{\alpha}_l$  goes to  $\widehat{\alpha}$ . For that reason,  $\ll \cdot \gg_{\widehat{\alpha}}$  is continuous, and  $V_{l,\psi}(\widehat{\alpha})$  converges uniformly in  $\widehat{\alpha}$  towards  $\ll \psi \gg_{\widehat{\alpha}}$  as  $l$  goes to  $\infty$ . This, combined with the two lemmas C.1 and C.2, completes the proof of Theorem 5.25.





## Notations glossary

<p><math>E</math> ... set of edges <math>(\widehat{\eta}, \widehat{\eta}^{x,x+z})</math>, <math>\eta_x = 1</math>, <math>\eta_{x+z} = 0</math>, <b>120</b></p> <p><math>F^{\omega,p}(\widehat{\alpha})</math> ... cutoff density, <math>\mathbb{E}_{\widehat{\alpha}}(\eta_0^\omega 1_{E_p})</math>, <b>91</b></p> <p><math>I_a</math> ... the "inverse" of <math>\nabla_a</math>, <b>74</b></p> <p><math>Q^*</math> ... a limit point of the sequence <math>(Q^N)_{N \in \mathbb{N}}</math>, <b>90</b></p> <p><math>T_0^\omega</math> ... set of semi angle-blind functions, <b>76</b></p> <p><math>\widetilde{\eta}_x</math> ... modification of <math>\eta_x^\omega</math> with mean 0 w.r.t. <math>\theta_x</math>, <b>77</b></p> <p><math>C_0</math> ... sum of <math>\widetilde{C}_0</math> and <math>J^\omega</math>, <b>74</b></p> <p><math>\mathcal{L}_B</math> ... part of <math>\mathcal{L}</math> with jumps inside <math>B</math>, <b>73</b></p> <p><math>\mathcal{L}_l</math> ... part of <math>\mathcal{L}</math> with jumps inside <math>B_l</math>, <b>73</b></p> <p><math>\mathcal{L}^{\beta=0}</math> ... Glauber generator with <math>\beta = 0</math>, <b>48</b></p> <p><math>\mathcal{H}_{\widehat{\alpha}}</math> ... quotient of <math>\mathcal{T}_0^\omega</math> by <math>\text{Ker} \ll \cdot \gg_{\widehat{\alpha}}</math>, <b>153</b></p> <p><math>\nabla_j</math> ... gradient due to a particle jump <math>0 \rightarrow e_j</math>, <b>44</b></p> <p><math>D(h)</math> ... <math>\mathcal{D}(\sqrt{h})</math>, <b>44</b></p> <p><math>D^{x,y}</math> ... part of the Dirichlet form due to <math>\mathcal{L}_{x,y}</math>, <b>66</b></p> <p><math>J^\omega</math> ... linear span of the currents <math>j_i</math>, <math>j_i^\omega</math>, <b>74</b></p> <p><math>\widetilde{C}_0</math> ... space of mean 0 func. w.r.t. any <math>\mu_{l,\widehat{K}}</math>, <b>73</b></p> <p><math>s_\psi</math> ... smallest <math>l</math>, <math>\psi</math> depends only on sites in <math>B_l</math>, <b>73</b></p> <p><math>\mathcal{C}</math> ... set of cylinder functions, <b>32</b></p> <p><math>\mathcal{G}</math> ... the graph <math>(\Sigma_\infty, E)</math>, <b>120</b></p> <p><math>\langle \pi, H \rangle</math> ... integral of <math>H</math> w.r.t. the measure <math>\pi</math>, <b>38</b></p> <p><math>A_N</math> ... <math>\llbracket 0, N \rrbracket^2</math>, closed boundary conditions, <b>76</b></p> <p><math>B_l</math> ... <math>B_l(0)</math>, <b>40</b></p> <p><math>B_l(x)</math> ... <math>\{y \in \mathbb{T}_N^2,  y - x  \leq l\}</math>, <b>40</b></p> <p><math>E_p</math> ... <math>E_{p,0}</math>, <b>51</b></p> <p><math>E_{p,x}</math> ... <math>B_p(x)</math> contains at least 2 empty sites, <b>51</b></p> <p><math>G_t(u)</math> ... smooth function on <math>[0, T] \times \mathbb{T}^2</math>, <b>37</b></p> <p><math>H_t(u, \theta)</math> ... smooth function on <math>[0, T] \times \mathbb{T}^2 \times \mathbb{S}</math>, <b>37</b></p> <p><math>L_N</math> ... complete generator of the AEP, <b>33</b></p> <p><math>L_N^{\beta=0}</math> ... generator of the AEP for <math>\beta = 0</math>, <b>48</b></p> <p><math>Q^N</math> ... law of <math>(\pi_t^N)_{t \in [0, T]}</math> for the AEP, <b>36, 182</b></p> <p><math>T_{i,p}^x</math> ... exchanges <math>\eta_x^\omega 1_{E_{p,x}}</math> and <math>\eta_{x+e_i}^\omega 1_{E_{p,x+e_i}}</math>, <b>94</b></p> <p><math>\mathbb{E}_{\alpha,l}^*</math> ... expectation w.r.t. <math>\mu_{\alpha,l}^*</math>, <b>43</b></p> <p><math>\mathbb{E}_{l,\widehat{K}}</math> ... expectation w.r.t. <math>\mu_{l,\widehat{K}}</math>, <b>43</b></p> <p><math>\mathbb{E}_{\widehat{\alpha}}</math> ... expectation w.r.t. <math>\mu_{\widehat{\alpha}}</math>, <b>43</b></p> <p><math>\mathbb{E}_\alpha^*</math> ... expectation w.r.t. <math>\mu_\alpha^*</math>, <b>43</b></p> <p><math>\Gamma</math> ... local creation rate of <math>\theta</math>-particles, <b>36</b></p> <p><math>\widehat{K}</math> ... a pair <math>(K, \Theta_K)</math>, <b>43</b></p> <p><math>\mathbb{K}_l</math> ... the set of possible <math>\widehat{K} = \widehat{\rho}_l</math>, <b>43</b></p> <p><math>\widetilde{\mathbb{K}}_l</math> ... the set of <math>\widehat{K}</math> such that <math>K \leq  B_l  - 2</math>, <b>43</b></p> <p><math>\mathbb{P}_\nu^{\lambda,\beta}</math> ... measure of AEP <math>(\lambda, \beta)</math> started from <math>\nu</math>, <b>35</b></p> <p><math>\mathcal{S}</math> ... set of angle-blind functions, <b>32</b></p> <p><math>\Theta_K</math> ... a orderless family of <math>K</math> angles, <b>43</b></p> <p><math> B </math> ... number of sites in <math>B</math>, <b>40</b></p>	<p><math> z </math> ... <math>\sum_i  z_i </math>, <b>33</b></p> <p><math>\alpha</math> ... total mass of <math>\widehat{\alpha}</math>, <b>42</b></p> <p><math>\beta</math> ... inverse temperature for <math>\mathcal{L}^G</math>, <b>34</b></p> <p><math>\widehat{\rho}</math> ... density profile on the torus, <b>34</b></p> <p><math>\widehat{\rho}_0</math> ... initial density profile on the torus, <b>35</b></p> <p><math>\mathfrak{F}</math> ... natural application from <math>\mathcal{C}_0</math> to <math>\mathfrak{C}_{\widehat{\alpha}}</math>, <b>144</b></p> <p><math>\eta_x</math> ... occupation state of the site <math>x</math>, <b>32</b></p> <p><math>\eta_x^\Phi</math> ... <math>\Phi(\theta_x)\eta_x</math>, <b>39</b></p> <p><math>\widehat{\eta}</math> ... family of the <math>\widehat{\eta}_x</math>, <math>x \in \mathbb{T}_N^2</math>, <b>32</b></p> <p><math>\widehat{\eta}^{[0,T]}</math> ... element of <math>\Sigma_N^{[0,T]}</math>, <b>35</b></p> <p><math>\widehat{\eta}^{x,\theta}</math> ... <math>\widehat{\eta}</math> after setting <math>\theta_x = \theta</math>, <b>34</b></p> <p><math>\widehat{\eta}^{x,y}</math> ... <math>\widehat{\eta}</math> after inversion of <math>\widehat{\eta}^x</math> and <math>\widehat{\eta}^y</math>, <b>34</b></p> <p><math>\widehat{\eta}_x</math> ... the pair <math>(\eta_x, \theta_x)</math>, <b>32</b></p> <p><math>\mathbb{T}^2</math> ... continuous 2-dimensional torus, <b>34</b></p> <p><math>\mathbb{S}</math> ... set of angles <math>[0, 2\pi[</math>, <b>32</b></p> <p><math>j_i</math> ... total instant. sym. current on <math>(0, 0 + e_i)</math>, <b>39</b></p> <p><math>r_i^\omega</math> ... instant. current of <math>\eta_0^\omega</math> on the edge <math>(0, 0 + e_i)</math> of the asymmetric gen. <math>\mathcal{L}^{\text{wa}}</math>, <b>39</b></p> <p><math>\mathbf{j}^1, \mathbf{j}^2</math> ... closed forms assoc. to <math>j_1, j_2</math>, <b>123</b></p> <p><math>\mathbf{j}^{1,\omega}, \mathbf{j}^{2,\omega}</math> ... closed forms assoc. to <math>j_1^\omega, j_2^\omega</math>, <b>124</b></p> <p><math>J_i^\omega</math> ... instant. current of <math>\eta_0^\omega</math> on the edge <math>(0, 0 + e_i)</math> due to <math>\mathcal{L}</math>, <b>39</b></p> <p><math>\widehat{\rho}_l</math> ... empirical angle measure over <math>B_l</math>, <b>40</b></p> <p><math>\mathfrak{d}</math> ... diffusion coefficient relative to <math>\nabla \rho</math>, <b>36</b></p> <p><math>\mathcal{D}</math> ... Dirichlet form of the exclusion process, <b>44</b></p> <p><math>\mathfrak{s}</math> ... conductivity coefficient, <b>36</b></p> <p><math>\gamma^\omega</math> ... instant. creation rate of <math>\eta_0^\omega</math> due to <math>\mathcal{L}^G</math>, <b>39</b></p> <p><math>\mu_{\widehat{\alpha}}</math> ... grand canonical measure GCM <math>(\widehat{\alpha})</math>, <b>43</b></p> <p><math>\mathcal{L}</math> ... symmetric part of <math>L_N</math>, <b>33</b></p> <p><math>\mathcal{L}_{x,y}</math> part of <math>\mathcal{L}</math> due to jumps between <math>x</math> and <math>y</math>, <b>66</b></p> <p><math>\mathcal{L}^D</math> ... displacement part of <math>L_N</math>, <b>33</b></p> <p><math>\mathcal{L}^G</math> ... Glauber part of <math>L_N</math>, <b>33</b></p> <p><math>\mathcal{L}^{\text{wa}}</math> ... weakly asymmetric part of <math>L_N</math>, <b>33</b></p> <p><math>\nabla_a</math> ... gradient due to a particle jump <math>a_1 \rightarrow a_2</math>, <b>44</b></p> <p><math>\lambda</math> ... real parameter tuning the asymmetry, <b>33</b></p> <p><math>\lambda_i(\theta)</math> strength of the asymmetry in the direction <math>i</math> on a particle with angle <math>\theta</math>, <b>33</b></p> <p><math>\langle \varphi \rangle_x^l</math> ... average over <math>B_l(x)</math> of the <math>\tau_y \varphi</math>, <b>40</b></p> <p><math>\mathcal{M}(\mathbb{T}^2 \times \mathbb{S})</math> space of measures on <math>\mathbb{T}^2 \times \mathbb{S}</math>, <b>36, 181</b></p> <p><math>\mathcal{M}^{[0,T]}</math> ... space of càdlàg traj. on <math>\mathcal{M}(\mathbb{T}^2 \times \mathbb{S})</math>, <b>36, 181</b></p> <p><math>\mu_\alpha^*</math> ... GCM with uniform angles, <b>43</b></p>
---	---

- $\mu_{\alpha,l}^* \dots \mu_{\alpha}^*$  restricted to configurations on  $B_l$ , 43
- $\mu^N$  ... initial measure of the AEP, fitting  $\widehat{\rho}_0$ , 35
- $\mu_{\widehat{\rho}}^N$  . product measure on  $\Sigma_N$  associated to  $\widehat{\rho}$ , 35
- $\mu_{l,\widehat{K}} \dots \mu_{\alpha,l}^*$  conditioned to  $\widehat{\eta} \in \Sigma_l^{\widehat{K}}$ , 43
- $\omega$  ..... smooth function on  $\mathbb{S}$ , 37
- $\vec{\Omega}$  ..... local direction of the asymmetry, 36
- $\widehat{\alpha}$  ..... angle measure, element of  $\mathcal{M}_1(\mathbb{S})$ , 42
- $\widehat{\alpha}_{\widehat{K}}$  angle measure in  $\mathcal{M}_1(\mathbb{S})$  associated to  $\widehat{K}$  , 68
- $\partial_s, \partial_t$  ..... time derivative, 38
- $\partial_{u_i,N}$  ..... discrete approximation of  $\partial_{u_i}$ , 40
- $\partial_{u_i}$  .....  $i$ -th continuous space derivative, 91
- $\pi_t^N$  ..... empirical measure at time  $s$ , 36, 181
- $\mathcal{M}_1(\mathbb{S})$  ..... set of angle measures, 42
- $\rho(u)$  ..... mass of the measure  $\widehat{\rho}(u, \cdot)$ , 34
- $\rho_l^\omega$  ..... average of  $\eta_x^\omega$  over  $B_l$ , 40
- $\rho_l$  ..... empirical particle density in  $B_l$ , 40
- $\ll \cdot \gg_{\widehat{\alpha}}$  .. limit of the space time covariance, 143
- $d_s$  ..... self-diffusion coefficient, 36
- $\Sigma_N$  ..... set of configurations on  $\mathbb{T}_N^2$ , 32
- $\Sigma_N^{[0,T]}$  ..... space of càdlàg trajectories on  $\Sigma_N$ , 35
- $\Sigma_\infty$  ..... set of configurations on  $\mathbb{Z}^2$ , 120
- $\Sigma_l^{\widehat{K}}$  ..... set of confs. with  $\widehat{K}$  particles in  $B_l$ , 43
- $\tau_x$  ..... translation by  $x$  on the discrete torus, 38
- $\theta_x$  ..... angle of the particle in  $x$ , 32
- $\mathbb{T}_N^2$  ..... discrete torus of size  $N$ , 32
- $\mathcal{T}_0^\omega$  .. space of semi angle-blind functions in  $C_0$ ,  
142
- $\widehat{\zeta}$  ..... initial macroscopic profile, 35
- $c_{x\beta}$  ..... jump rates for  $\mathcal{L}^c$ , 34
- $\| \cdot \|$  ..... norm on  $\mathcal{M}_1(\mathbb{S})$ , 42

## References

- [Ama93] H. Amann. Nonhomogeneous linear and quasilinear elliptic and parabolic boundary value problems. *Function Spaces, Differential Operators and Nonlinear Analysis*, pages 9–126, 1993.
- [Aok82] I. Aoki. A simulation study of the schooling mechanism. *Bulletin of the Japanese Society of Scientific Fisheries*, 48(8):1081–1088, 1982.
- [BCC<sup>+</sup>08] M. Ballerini, N. Cabibbo, R. Candelier, A. Cavagna, E. Cisbani, I. Giardina, V. Lecomte, A. Orlandi, G. Parisi, A. Procaccini, M. Viale, and V. Zdravkovic. Interaction ruling animal collective behavior depends on topological rather than metric distance: Evidence from a field study. *Proceedings of the National Academy of Sciences*, 105(4):1232, 2008.
- [BCC10] F. Bolley, J. A. Cañizo, and J. A. Carrillo. Stochastic mean-field limit: Non-lipschitz forces and swarming. *Mathematical Models and Methods in Applied Sciences*, 21, September 2010.
- [BCC11] F. Bolley, J. A. Cañizo, and J. A. Carrillo. Mean-field limit for the stochastic vicsek model. *Applied Mathematics Letters*, 25:339–343, 2011.
- [BFG13] L. Bertini, A. Faggionato, and D. Gabrielli. Large deviation principles for nongradient weakly asymmetric stochastic lattice gases. *Ann. Appl. Probab.*, 23(1):1–65, February 2013.
- [Bil99] P. Billingsley. *Convergence of probability measures*. Wiley series in Probability and Statistics: Probability and Statistics. John Wiley & Sons Inc., New York, second edition, 1999.
- [BPSV00] S. Brassesco, E. Presutti, V. Sidoravicius, and M.E. Vares. Ergodicity and exponential convergence of a glauber+kawasaki process. *On Dobrushin's way. From probability theory to statistical physics*, pages 37–49, 2000.
- [Bre10] H. Brezis. *Functional Analysis, Sobolev Spaces and Partial Differential Equations*. Springer, 1st edition, November 2010.
- [BVDP06] Ch. Becco, N. Vandewalle, J. Delcourt, and P. Poncin. Experimental evidences of a structural and dynamical transition in fish school. *Physica A: Statistical Mechanics and its Applications*, 367:487–493, July 2006.
- [CDW13] E. Carlen, P. Degond, and B. Wennberg. Kinetic limits for pair-interaction driven master equations and biological swarm models. *Mathematical Models and Methods in Applied Sciences*, 23:1339–1376, 2013.
- [CHM14] J. A. Carrillo, Y. Huang, and S. Martin. Explicit flock solutions for quasi-morse potentials. *European Journal of Applied Mathematics*, 25:553 – 578, October 2014.
- [CT13] M. E. Cates and J. Tailleur. When are active brownian particles and run-and-tumble particles equivalent? consequences for motility-induced phase separation. *EPL (Europhysics Letters)*, 101, January 2013.

- [CT15] M. E. Cates and J. Tailleur. Motility-induced phase separation. *Annual Review of Condensed Matter Physics*, 6:219–244, March 2015.
- [CY13] J. A. Carrillo and B. Yan. An asymptotic preserving scheme for the diffusive limit of kinetic systems for chemotaxis. *Multiscale Modeling and Simulation*, 11:336–361, 2013.
- [DFL13] P. Degond, A. Frouvelle, and J.-G. Liu. Macroscopic limits and phase transition in a system of self-propelled particles. *Journal of Nonlinear Science*, 23(3):427–456, 2013.
- [DFL14] P. Degond, A. Frouvelle, and J.-G. Liu. Phase transitions, hysteresis, and hyperbolicity for self-organized alignment dynamics. *Archive for Rational Mechanics and Analysis*, 2014.
- [DLMP13] P. Degond, J.-G. Liu, S. Motsch, and V. Panferov. Hydrodynamic models of self-organized dynamics: derivation and existence theory. *Methods and Applications of Analysis*, 20:089–114, 2013.
- [DM08] P. Degond and S. Motsch. Continuum limit of self-driven particles with orientation interaction. *Mathematical Models and Methods in Applied Sciences*, 18, October 2008.
- [DMF15] Anna De Masi and Pablo A. Ferrari. Separation versus diffusion in a two species system. *Brazilian Journal of Probability and Statistics*, 29(2):387–412, May 2015.
- [DMFL86] A. De Masi, P. A. Ferrari, and J. L. Lebowitz. Reaction-diffusion equations for interacting particle systems. *Journal of Statistical Physics*, 44, January 1986.
- [DPS87] A. De Masi, E. Presutti, and E. Scacciatelli. The weakly asymmetric simple exclusion process. *CARR reports in mathematical physics*, 1987.
- [DY10] P. Degond and T. Yang. Diffusion in a continuum model of self-propelled particles with alignment interaction. *Mathematical Models and Methods in Applied Sciences*, 20:1459–1490, February 2010.
- [Fro12] A. Frouvelle. A continuum model for alignment of self-propelled particles with anisotropy and density-dependent parameters. *Mathematical Models and Methods in Applied Sciences*, 22(7), December 2012.
- [FSV10] J. Farfan, A. B. Simas, and F. J. Valentim. Dynamical large deviations for a boundary driven stochastic lattice gas model with many conserved quantities. *Journal of Statistical Physics*, 139:658–685, May 2010.
- [GC04] G. Grégoire and H. Chaté. Onset of collective and cohesive motion. *Physical Review Letters*, 92(2):025702, January 2004.
- [GKPCA07] P. Galajda, J. Keymer and P. Chaikin, and R. Austin. A wall of funnels concentrates swimming bacteria. *Journal of Bacteriology*, 189(23):8704–8707, 2007.
- [GLM00] Giambattista Giacomin, Joel L. Lebowitz, and Rossana Marra. Macroscopic evolution of particle systems with short and long range interactions. *Nonlinearity*, 13(6), 2000.
- [GRR78] A.M. Garcia, E. Rodemich, and H. Rumsey. A real variable lemma and the continuity of paths of some gaussian processes. *Indiana Math. J.*20, 565-578., 1978.

- [Hug02] R.L. Hughes. A continuum theory for the flow of pedestrians. *Transportation Research Part B: Methodological*, 36(6):507 – 535, 2002.
- [JLV93] G. Jona-Lasinio, C. Landim, and M.E. Vares. Large deviations for a reaction diffusion model. *Probability Theory and Related Fields*, 97:339–361, 1993.
- [JS79] Wm.W. Johnson and W.E. Story. notes on the "15" puzzle. *American Journal of Mathematics*, 2(4):pp. 397–404, December 1879.
- [KL99] C. Kipnis and C. Landim. *Scaling limits of interacting particle systems*, volume 320 of *Grundlehren der Mathematischen Wissenschaften [Fundamental Principles of Mathematical Sciences]*. Springer-Verlag, Berlin, 1999.
- [KLO12] T. Komorowski, C. Landim, and S. Olla. *Fluctuations in Markov Processes. Time Symmetry and Martingale Approximation*. Springer, Berlin, 2012.
- [KV86] C. Kipnis and S.R.S. Varadhan. Central limit theorem for additive functionals of reversible markov processes and applications to simple exclusions. *Communications in Mathematical Physics*, 104(1):1–19, 1986.
- [LOV01] C. Landim, S. Olla, and S.R.S. Varadhan. Symmetric simple exclusion process: Regularity of the self-diffusion coefficient. *Communications in Mathematical Physics*, 224(1):307–321, 2001.
- [MFGW89] A. Masi, P.A. Ferrari, S. Goldstein, and W.D. Wick. An invariance principle for reversible markov processes. applications to random motions in random environments. *Journal of Statistical Physics*, 55(3-4):787–855, 1989.
- [MW66] N. D. Mermin and H. Wagner. Absence of ferromagnetism or antiferromagnetism in one- or two-dimensional isotropic heisenberg models. *Phys. Rev. Lett.*, 17:1133–1136, November 1966.
- [NK80] Kazuo Nakazato and Kazuo Kitahara. Site blocking effect in tracer diffusion on a lattice. *Progress of Theoretical Physics*, 64(6):2261–2264, 1980.
- [OL01] A. Okubo and S.A. Levin. *Diffusion and ecological problems : modern perspectives*. Interdisciplinary applied mathematics. Springer, New York, 2001.
- [OS13] S. Olla and M. Sasada. Macroscopic energy diffusion for a chain of anharmonic oscillators. *Probability Theory and Related Fields*, 157:721–775, September 2013.
- [PE99] J. K. Parrish and L. Edelstein-Keshet. Complexity, pattern, and evolutionary trade-offs in animal aggregation. *Science*, 284:99, April 1999.
- [QRV99] J. Quastel, F. Rezakhanlou, and S. R. S. Varadhan. Large deviations for the symmetric simple exclusion process in dimensions  $d$ . *Probability Theory and Related Fields*, 113(1):1–84, 1999.
- [Qua92] J. Quastel. Diffusion of colour in the simple exclusion process. *Communications on Pure and Applied Mathematics*, 45:623–679, 1992.

- [Sas10a] M. Sasada. Hydrodynamic limit for exclusion processes with velocities. *Markov Processes and Related Rielsds*, October 2010.
- [Sas10b] M. Sasada. Hydrodynamic limit for two-species exclusion processes. *Stochastic Processes and their Application*, 120(4):494–521, April 2010.
- [SCB<sup>+</sup>15] A. P. Solon, J.-B. Caussin, D. Bartolo, H. Chaté, and J. Tailleur. Pattern formation in flocking models: A hydrodynamic description. *Physical Review E*, *In press*, September 2015.
- [SCT15] A. P. Solon, M. E. Cates, and J. Tailleur. Active brownian particles and run-and-tumble particles: A comparative study. *European Physical Journal Special Topics*, 224:1231, July 2015.
- [Sha78] E. Shaw. Schooling fishes. *American Scientist*, 66:166–175, March 1978.
- [Sim10] A.B. Simas. Hydrodynamic limit for a boundary driven stochastic lattice gas model with many conserved quantities. *Journal of Statistical Physics*, 139(2):219–251, 2010.
- [Spo90] H. Spohn. Tracer diffusion in lattice gases. *Journal of Statistical Physics*, 59(5-6):1227–1239, 1990.
- [Spo91] H. Spohn. *Large scale dynamics of interacting particles*, volume 825. Springer Berlin, 1991.
- [ST15] A. P. Solon and J. Tailleur. Flocking with discrete symmetry: the 2d active ising model. *Physics Review E*, 92, 2015.
- [Uva66] B. Uvarov. *Grasshoppers and locusts : a handbook of general acridology / by Sir Boris Uvarov. Vol.2. Behaviour, ecology, biogeography, population dynamics*. Centre for Overseas Pest Research London, 1966.
- [Var94a] S. R. S. Varadhan. non-linear diffusion limit for a system with nearest-neighbor interactions ii. In *Asymptotic problems in probability theory : stochastic models and diffusion on fractals*, number 283 in Pitman Research Notes in Mathematics, pages 75–128. Springer-Verlag, 1994.
- [Var94b] S. R. S. Varadhan. Regularity of self-diffusion coefficient. In *The Dynkin Festschrift: Markov processes and their applications*, number 34 in Progress in Probability, pages 387–397. Springer-Verlag, 1994.
- [VCB<sup>+</sup>95] T. Vicsek, A. Czirók, E. Ben-Jacob, I. Cohen, and O. Shochet. Novel type of phase transition in a system of self-driven particles. *Physical Review Letters*, 75:1226–1229, August 1995.
- [VZ12] T. Vicsek and A. Zafeiris. Collective motion. *Physics Reports*, 517(3):71–140, 2012.

**Titre : limite Hydrodynamique pour un Gaz Sur Réseau de Particules Actives**

**Mots clés : Physique Statistique, Limites Hydrodynamiques, Transitions de Phase, Probabilités**

**Résumé : l'étude des dynamiques collectives, observables chez de nombreuses espèces animales, a motivé dans les dernières décennies un champ de recherche actif et transdisciplinaire. De tels comportements sont souvent modélisés par de la matière active, c'est-à-dire par des modèles dans lesquels chaque individu est caractérisé par une vitesse propre qui tend à s'aligner avec celle de ses voisins.**

**Dans un modèle fondateur proposé par Vicsek & al., ainsi que dans de nombreux modèles de matière active liés à ce dernier, une transition de phase entre un comportement chaotique à forte température, et un comportement global et cohérent à faible température, a été observée. De nombreuses preuves numériques de telles transitions de phase ont été obtenues dans le cadre des dynamiques collectives. D'un point de vue mathématique, toutefois, ces systèmes actifs sont encore mal compris. Plusieurs résultats ont été obtenus récemment sous une approximation de champ moyen, mais il n'y a encore à ce jour que peu d'études mathématiques de modèles actifs faisant intervenir des interactions purement microscopiques.**

**Dans ce manuscrit, nous décrivons un système de particules actives sur réseau interagissant localement pour aligner leurs vitesses. L'objet de cette thèse est l'obtention rigoureuse, à l'aide du formalisme des limites hydrodynamiques pour les gaz sur réseau, de la limite macroscopique de ce système hors-équilibre, qui pose de nombreuses difficultés techniques et théoriques.**

**Title : hydrodynamic Limit for an Active Stochastic Lattice Gas**

**Keywords : Statistical Physics, Hydrodynamic Limits, Phase Transitions, Probability Theory**

**Abstract : collective dynamics can be observed among many animal species, and have given rise in the last decades to an active and interdisciplinary field of study. Such behaviors are usually modeled by active matter, in which each individual is self-driven and tends to align its velocity with that of its neighbors.**

**In a classical model introduced by Vicsek & al., as well as in numerous related active matter models, a phase transition between chaotic behavior at high temperature and global order at low temperature can be observed. Even though ample evidence of these phase transitions has been obtained for collective dynamics, from a mathematical standpoint, such active systems are not fully understood yet. Some progress has been achieved in the recent years under an assumption of mean-field interactions, however to this day, few rigorous results have been obtained for models involving purely local interactions.**

**In this manuscript, we describe a lattice active particle system interacting locally to align their velocities. This thesis aims at rigorously obtaining, using the formalism developed for hydrodynamic limits of lattice gases, the scaling limit of this out-of-equilibrium system, for which numerous technical and theoretical difficulties arise.**