



HAL
open science

Evaluation technico-économique et environnementale du stockage par méthane des énergies renouvelables, dans les conditions spécifiques de la Roumanie et dans un cas générique européen

Ovidiu Mihai Balan

► **To cite this version:**

Ovidiu Mihai Balan. Evaluation technico-économique et environnementale du stockage par méthane des énergies renouvelables, dans les conditions spécifiques de la Roumanie et dans un cas générique européen. Energie électrique. Ecole nationale supérieure d'arts et métiers - ENSAM; Universitatea politehnica (Bucarest), 2016. Français. NNT : 2016ENAM0064 . tel-01525826

HAL Id: tel-01525826

<https://pastel.hal.science/tel-01525826>

Submitted on 22 May 2017

HAL is a multi-disciplinary open access archive for the deposit and dissemination of scientific research documents, whether they are published or not. The documents may come from teaching and research institutions in France or abroad, or from public or private research centers.

L'archive ouverte pluridisciplinaire **HAL**, est destinée au dépôt et à la diffusion de documents scientifiques de niveau recherche, publiés ou non, émanant des établissements d'enseignement et de recherche français ou étrangers, des laboratoires publics ou privés.

École doctorale n° 432 : Science des Métiers de l'ingénieur

Doctorat ParisTech

T H È S E

pour obtenir le grade de docteur délivré par

l'École Nationale Supérieure d'Arts et Métiers

Spécialité "Génie énergétique (AM)"

présentée et soutenue publiquement par

Ovidiu Mihai BALAN

8 Décembre 2016

Technical, economic and environmental evaluation of renewable energy storage as methane in the current specific Romanian context and in a generic European case

Directeur de thèse : **Daniel FROELICH**

Directeur de thèse : **Adrian BADEA**

Jury

M. George DARIE, Professeur, Université Polytechnique de Bucarest

M. Daniel BRISSAUD, Professeur, Grenoble INP

M. Marcel ISTRATE, Professeur, « Gheorghe Asachi » Technical University of Iasi

M. Jerome PAYET, Professeur, CYCLECO, EPFL Lausanne

M. Daniel FROELICH, Professeur, Institut de Chambéry, Arts et Métiers ParisTech

M. Adrian BADEA, Professeur, Université Polytechnique de Bucarest

M. Aymeric BRUNOT, Ingénieur, CEA Grenoble

Président

Rapporteur

Rapporteur

Examineur

Examineur

Examineur

Invité

**T
H
È
S
E**

TABLE OF CONTENTS

1. Introduction.....	1
1.1 Context.....	1
1.2 Response.....	3
1.3 Thesis overview.....	5
2 Development of Energy Storage in Link with Renewable Energy Integration.....	10
2.1 Climate change – main driver of progress	10
2.2 Challenges related to renewable energy integration	12
2.3 Available options for efficient renewable energy integration.....	14
2.4 Deployment of energy storage in link with renewable energy integration	16
2.5 Perspectives.....	17
3 Romanian Energy Context.....	20
3.1 Electric Energy Sector.....	20
3.1.1 Overview.....	20
3.1.2 Production.....	21
3.1.3 Transport and Distribution.....	24
3.2 Natural Gas Sector	25
3.2.1 Overview.....	25
3.2.2 Demand.....	26
3.2.3 Production.....	26
3.2.4 Transport and Distribution.....	27
3.2.5 Natural Gas Storage	28
3.3 Energy Markets	29
3.3.1 Electricity Market	29
3.3.2 Natural Gas Market.....	31
3.4 Romania and the Energy Trilemma	34

4	The Power-to-Gas concept	37
4.1	Functions of the Power-to-Gas concept	38
4.2	Power-to-Gas pathways.....	40
4.2.1	Power-to-Gas Hydrogen	41
4.2.2	Power-to-Gas SNG	41
4.3	Integrating hydrogen in the natural gas infrastructure	43
4.4	Policy and support mechanisms	48
5	Components of the Power-to-Gas concept	50
5.1	Renewable Energy.....	50
5.2	Electrolysis	52
5.2.1	General description	52
5.2.2	Electrolysis technologies	55
5.3	Methanation.....	63
5.4	CO ₂ Capture	65
5.4.1	Post-combustion.....	68
5.4.2	Pre-combustion	68
5.4.3	Oxy-fuel combustion	69
5.4.4	Economics of CO ₂ capture.....	70
5.5	Hydrogen compression, storage and injection	71
5.5.1	Storage	71
5.5.2	Compression	72
5.5.3	Injection components	72
6	Developing an analysis framework for Power-to-Gas projects.....	74
6.1	The need for an analysis framework	74
6.2	Stages of the analysis framework.....	75
7	Methanation process	81
7.1	Introduction	81

7.2	Chemical fundamentals	82
7.3	Methanation kinetics	82
7.4	SNG production – Methanation reactor design.....	85
7.5	Methanation process modeling.....	88
7.5.1	Physical properties	89
7.5.2	Conceptual design.....	94
8	Leveraging Power-to-Gas in the Romanian case	102
8.1	Context identification.....	102
8.2	Perimeter definition and data input	102
8.3	Technical sizing.....	106
8.4	Economic analysis of the current Romanian case	113
8.4.1	Power-to-Gas Hydrogen	113
8.4.2	Power-to-Gas SNG	124
8.5	Influence of future T&E developments on the Romanian case	133
8.5.1	Motivation and methodology.....	133
8.5.2	2030 Romanian case using alkaline electrolysis.....	135
8.5.3	2030 Romanian case using PEM electrolysis	143
8.6	Discussion	151
9	Leveraging Power-to-Gas in the French context with participation to the balancing market	154
9.1	French energy context	154
9.2	Integrating Power-to-Gas and the balancing market.....	155
9.2.1	Balancing mechanisms.....	155
9.2.2	Advantages of using Power-to-Gas in conjunction with the balancing market	155
9.2.3	Balancing market – a high value market for Power-to-Gas applications?.....	156
9.3	Technical and economic evaluation of Power-to-Gas in the French context.....	157
9.3.1	Methodology	157

9.3.2	Technical sizing	162
9.4	Economic analysis of Power-to-Gas in the French context	163
9.4.1	Power-to-Gas Hydrogen	163
9.4.2	Power-to-Gas SNG	171
9.5	Discussion	178
10	Environmental evaluation of Power-to-Gas.....	180
10.1	Theoretical considerations on Life Cycle Assessment.....	180
10.2	Goal and Scope.....	181
10.2.1	Goal definition	181
10.2.2	Scope Definition	183
10.3	Life Cycle Inventories	188
10.3.1	Methodology.....	188
10.3.2	Qualitative and quantitative description of the elementary processes	189
10.3.3	Complex Power-to-Gas processes	206
10.4	Life cycle assessment results.....	211
10.4.1	Greenhouse gas emissions	211
10.4.1.1	Hydrogen production.....	211
10.4.2	Cumulative Energy Demand.....	225
10.5	Discussion	229
11	Conclusions and perspective.....	232
11.1	Main findings	232
11.2	Concluding statements	235
11.3	Limitations of the work	238
11.4	Future work and perspective	239
12	Bibliography	241

LIST OF FIGURES

Figure 2.1 Development of installed power capacities at European level by 2050 (source: [European Commission DG ENER 2013]).....	11
Figure 2.2 Capacity of various energy storage technologies [source: [Hydrogenious 2015)]	16
Figure 3.1 Structure of the delivered energy based on energy sources in Romania [Source: Departamentul pentru Energie 2014]	21
Figure 3.2 Import/Export balance associated to the Romanian electric energy sector [Source: Departamentul pentru Energie 2014]	21
Figure 3.3 Evolution of the Romanian electric energy production capacities between 2009 and 2013 [Source: Departamentul pentru Energie 2014].....	22
Figure 3.4 Evolution of the Romanian natural gas import and internal production between 2009 and 2013 2013 [Source: Departamentul pentru Energie 2014]	27
Figure 3.5 Internal vs Import natural gas price in Romania [Source: Departamentul pentru Energie 2014].....	33
Figure 3.6 Natural gas prices for household consumers expressed in Euro/kWh [Source: Eurostat]	33
Figure 3.7 Natural gas prices for industrial consumers expressed in Euro/kWh [Source: Eurostat]	34
Figure 3.8 Romania's ratings in the World Energy Council's Trilemma Index 2014	35
Figure 4.1 The Power-to-Gas concept (source: [Stern 2009])	38
Figure 4.2 Schematic representation of the Power-to-Gas Hydrogen pathway	41
Figure 4.3 Schematic representation of the Power-to-Gas SNG pathway	42
Figure 4.4 Evolution of Wobbe index depending on the concentration of hydrogen	46
Figure 4.5 Concentration of hydrogen in natural gas limits in European countries (Source: [ADEME 2014], ITM Power)	48
Figure 5.1 Merit order curves in the context of deploying Power-to-Gas [Source: Jentsch et al. 2011]	50
Figure 5.2 Working principle of an Alkaline electrolysis cell (Source: Santos et al. 2013)	55
Figure 5.3 Working principle of a PEM electrolyser (Source: [Electrochemistry Encyclopedia 2011]).....	58
Figure 5.4 Working principle of a SOEC electrolyser (Source: [Petipas 2013])	61
Figure 5.5 Capital and operational costs of methanation (source: [DNV KEMA Energy & Sustainability 2013])	65
Figure 5.6 Overview on carbon capture technologies (Source: [Intergovernmental Panel on Climate Change 2011])	66
Figure 5.7 Post-combustion carbon capture (Source: [International Energy Agency 2008])	68
Figure 5.8 Pre-combustion carbon capture (Source: [International Energy Agency 2008]).....	69
Figure 5.9 Oxy-fuel combustion carbon capture (Source: [International Energy Agency 2008]).....	70
Figure 5.10 Capital costs of hydrogen storage tanks depending on the storage pressure [Source: [ADEME 2014])	71
Figure 5.11 Capital costs of hydrogen compressors (Source: [Beccali et al. 2013])	72
Figure 6.1 The novel analysis framework for Power-to-Gas projects developed as part of the thesis	76
Figure 7.1 Lurgi process, adapted from [Kopyscinski et al. 2010]	87
Figure 7.2 Linde process, adapted from [Kopyscinski et al. 2010]	87
Figure 7.3 TREMP process, adapted from [Kopyscinski et al. 2010]	88
Figure 7.4 Schematic representation of carbon dioxide methanation process	89
Figure 7.5 Maximum temperature of the first reactor bed versus the reactants ratio $F_{1,CO_2} / F_{1,H_2}$, at various values of the recycle fraction R	91
Figure 7.6 H_2 conversion versus first reactor-inlet carbon dioxide flow rate at different recycle ratio. $F_{1,H_2} = 54$ kmol/h (108 kg/h)	93

Figure 7.7 CO ₂ conversion versus first reactor-inlet carbon dioxide flow rate at different recycle ratio. F ₁ ,H ₂ = 54 kmol/h (108 kg/h)	94
Figure 7.8 Flowsheet of CO ₂ methanation process (CO ₂ separation – recycle)	95
Figure 8.1 Energy production of the wind park (Romanian case)	104
Figure 8.2 Day-Ahead Market (DAM) energy prices (Romanian Case)	104
Figure 8.3 Creation of the Power-to-Gas project using ODYSSEY	107
Figure 8.4 Levelized Cost of Energy depending on different energy market price threshold values in the Power-to-Gas Hydrogen pathway	109
Figure 8.5 Levelized Cost of Energy depending on different energy market price threshold values in the Power-to-Gas SNG pathway	110
Figure 8.6 Energy balance of Power-to-Gas Hydrogen in the Romanian Case	112
Figure 8.7 Energy balance of Power-to-Gas SNG in the Romanian Case	112
Figure 8.8 2015 Romanian Case Power-to-Gas Hydrogen Influence of price premiums on the NPV of the project	122
Figure 8.9 Levelized Cost of Energy in the 2015 Romanian Case Power-to-Gas Hydrogen pathway	123
Figure 8.10 2015 Romanian Case Power-to-Gas SNG Influence of price premiums on the NPV of the project	132
Figure 8.11 Levelized Cost of Energy in the 2015 Romanian Case Power-to-Gas SNG pathway	132
Figure 8.12 Levelized Cost of Energy depending on different energy market price threshold values in the 2030 Power-to-Gas Hydrogen pathway using alkaline electrolysis	136
Figure 8.13 Levelized Cost of Energy depending on different energy market price threshold values in the 2030 Power-to-Gas SNG pathway using alkaline electrolysis	137
Figure 8.14 Romanian Case 2030 Power-to-Gas Hydrogen using alkaline electrolysis influence of price premiums on the NPV of the project	140
Figure 8.15 Romanian Case 2030 Power-to-Gas SNG using alkaline electrolysis influence of price premiums on the NPV of the project	143
Figure 8.16 Levelized Cost of Energy depending on different energy market price threshold values in the 2030 Power-to-Gas Hydrogen pathway using PEM electrolysis	144
Figure 8.17 Levelized Cost of Energy depending on different energy market price threshold values in the 2030 Power-to-Gas SNG pathway using PEM electrolysis	145
Figure 8.18 Romanian Case 2030 Power-to-Gas Hydrogen using PEM electrolysis influence of price premiums on the NPV of the project	148
Figure 8.19 Romanian Case 2030 Power-to-Gas SNG using PEM electrolysis influence of price premiums on the NPV of the project	151
Figure 9.1 Balancing market mechanism (source: RTE)	159
Figure 9.2 Energy production of the simulated wind park in the French context	161
Figure 9.3 EPEX spot DAM prices corresponding to the energy production of the simulated wind park in the French context	161
Figure 9.4 Sensitivity analysis on the influence of potential price premiums for renewable hydrogen in the French Case of Power-to-Gas Hydrogen Injection participating on the BAM	169
Figure 9.5 Sensitivity analysis on the influence of potential price premiums for renewable hydrogen in the French Case of Power-to-Gas Hydrogen Injection without participating on the BAM	170
Figure 9.6 Sensitivity analysis on the influence of potential price premiums for renewable hydrogen in the French Case of Power-to-Gas SNG participating on the BAM	177
Figure 9.7 Sensitivity analysis on the influence of potential price premiums for renewable hydrogen in the French Case of Power-to-Gas SNG without participating on the BAM	178
Figure 10.1 Stages of Life Cycle Assessment	181
Figure 10.2 Single Power-to-Gas cycle diagram	207

Figure 10.3 Double Power-to-Gas cycle diagram.....	208
Figure 10.4 GWP emissions of the operation phase in the considered hydrogen production scenarios	213
Figure 10.5 GWP emissions of hydrogen production scenarios	214
Figure 10.6 GWP emissions of electricity production scenarios	215
Figure 10.7 GWP emissions of electricity production in complex Power-to-Gas scenarios using fossil carbon from power plants.....	219
Figure 10.8 GWP emissions of electricity production in complex Power-to-Gas scenarios using fossil carbon from the cement industry.....	223
Figure 10.9 GWP emissions of heat production scenarios	224
Figure 10.10 CED of hydrogen production scenarios.....	226
Figure 10.11 CED of electricity production scenarios.....	228
Figure 10.12 CED of heat production scenarios	229
Figure 11.1 Summary of the required price premiums for reaching the breaking even point for all the analyzed scenarios	234

LIST OF TABLES

Table 3.1 Natural gas storage facilities [Source: Departamentul pentru Energie 2014]	28
Table 3.2 Evolution of the average annual prices on the Romanian energy markets [Source: Departamentul pentru Energie 2014]	31
Table 5.1 Key performance indicators of Alkaline and PEM electrolysis technologies in 2015 and 2030	62
Table 5.2 Carbon Capture Technologies	67
Table 7.1 Kinetic parameters	84
Table 7.2 Selection of methanation process developments (1955-2013).....	86
Table 7.3 Effect of the recycle ratio on the gas composition and operating conditions at the outlet of the first methanation reactor and on the SNG composition	92
Table 7.4 Stream results for the reaction section for 110.58 kg/h hydrogen (2030 Romanian case Power-to-Gas SNG using PEM electrolysis).....	96
Table 7.5 Stream results for the reaction section for 107.91 kg/h hydrogen (2015 Romanian case Power-to-Gas SNG).....	97
Table 7.6 Stream results for the reaction section for 103.4 kg/h hydrogen (French case Power-to-Gas SNG with BAM participation).....	98
Table 7.7 Stream results for the reaction section for 99.7 kg/h hydrogen (French case Power-to-Gas SNG without BAM participation).....	99
Table 7.8 Stream results for the reaction section for 77.83 kg/h hydrogen (2030 Romania case Power-to-Gas SNG using alkaline electrolysis)	100
Table 8.1 Economic assumptions for the Romanian case.....	105
Table 8.2 Key performance indicators of the electrolysis process used for the high-level technical and economic simulation	107
Table 8.3 Key performance indicators for hydrogen storage and methanation reactor	108
Table 8.4 LCOE of the Power-to-Gas Hydrogen pathway	109
Table 8.5 LCOE of the Power-to-Gas SNG pathway	110
Table 8.6 Romanian Case 2015 Power-to-Gas Hydrogen inputs	114
Table 8.7 2015 Romanian Case Power-to-Gas Hydrogen initial investment	115
Table 8.8 2015 Romanian Case Power-to-Gas Hydrogen CAPEX & Depreciation.....	116
Table 8.9 2015 Romanian Case Power-to-Gas Hydrogen Profits & Losses.....	119
Table 8.10 2015 Romanian Case Power-to-Gas Hydrogen Cash Flow	120
Table 8.11 2015 Romanian Case Power-to-Gas Hydrogen NPV Calculation.....	120
Table 8.12 2015 Romanian Case Power-to-Gas Hydrogen price premium sensitivity analysis.....	121
Table 8.13 Romanian Case 2015 Power-to-Gas SNG inputs	124
Table 8.14 Romanian Case Power-to-Gas SNG initial investment	126

Table 8.15 2015 Romanian Case Power-to-Gas SNG CAPEX & Depreciation	127
Table 8.16 2015 Romanian Case Power-to-Gas SNG Profits & Losses.....	128
Table 8.17 2015 Romanian Case Power-to-Gas SNG Cash Flow	129
Table 8.18 2015 Romanian Case Power-to-Gas SNG NPV Calculation.....	129
Table 8.19 2015 Romanian Case Power-to-Gas SNG price premium sensitivity analysis.....	131
Table 8.20 Technical assumptions taken into consideration for the 2015 and 2030 comparative assessment of Power-to-Gas in the Romanian case	134
Table 8.21 Economic assumptions taken into consideration for the 2015 and 2030 comparative assessment of Power-to-Gas.....	135
Table 8.22 LCOE of the 2030 Power-to-Gas Hydrogen pathway using alkaline electrolysis	136
Table 8.23 LCOE of the 2030 Power-to-Gas SNG pathway using alkaline electrolysis	137
Table 8.24 Romanian Case 2030 Power-to-Gas Hydrogen using alkaline electrolysis Inputs	138
Table 8.25 Romanian Case 2030 Power-to-Gas Hydrogen using alkaline electrolysis Initial Investment	139
Table 8.26 Romanian Case 2030 Power-to-Gas Hydrogen using alkaline electrolysis price premiums sensitivity analysis	139
Table 8.27 Romanian Case 2030 Power-to-Gas SNG using alkaline electrolysis Inputs	140
Table 8.28 Romanian Case 2030 Power-to-Gas SNG using alkaline electrolysis Initial Investment	141
Table 8.29 Romanian Case 2030 Power-to-Gas SNG using alkaline electrolysis price premiums sensitivity analysis	142
Table 8.30 LCOE of the 2030 Power-to-Gas Hydrogen pathway using PEM electrolysis	143
Table 8.31 LCOE of the 2030 Power-to-Gas SNG pathway using PEM electrolysis	144
Table 8.32 Romanian Case 2030 Power-to-Gas Hydrogen using PEM electrolysis Inputs	145
Table 8.33 Romanian Case 2030 Power-to-Gas Hydrogen using PEM electrolysis Initial Investment	146
Table 8.34 Romanian Case 2030 Power-to-Gas Hydrogen using PEM electrolysis price premiums sensitivity analysis	147
Table 8.35 Romanian Case 2030 Power-to-Gas SNG using PEM electrolysis Inputs	148
Table 8.36 Romanian Case 2030 Power-to-Gas SNG using PEM electrolysis Initial Investment	149
Table 8.37 Romanian Case 2030 Power-to-Gas SNG using PEM electrolysis price premiums sensitivity analysis	150
Table 9.1 Parameters taken into account for evaluating the optimum scenario for the French case	158
Table 9.2 Key parameters of modeling the French Case in Odyssey	162
Table 9.3 Results of the optimization process performed in Odyssey	163
Table 9.4 Key Inputs for the economic analysis of Power-to-Gas Hydrogen in the French case with participation to the balancing market.....	164
Table 9.5 Initial Investment for Power-to-Gas Hydrogen in the French case (with participation to the balancing market).....	165
Table 9.6 Power-to-Gas Hydrogen French Case (with BAM participation) CAPEX & Depreciation	165

Table 9.7 Power-to-Gas Hydrogen French case (with participation to BAM) Profits & Losses	166
Table 9.8 Power-to-Gas Hydrogen French case (with participation to BAM) Cash Flow	167
Table 9.9 Power-to-Gas Hydrogen French case (with participation to BAM) NPV calculation	168
Table 9.10 Key Inputs for the economic analysis of Power-to-Gas SNG in the French case with participation to the balancing market.....	171
Table 9.11 Initial Investment for Power-to-Gas SNG in the French case (with participation to the balancing market).....	172
Table 9.12 Table 6 Power-to-Gas SNG French Case (with BAM participation) CAPEX & Depreciation	173
Table 9.13 Power-to-Gas SNG French case (with participation to BAM) Profits & Losses	174
Table 9.14 Power-to-Gas SNG French case (with participation to BAM) Cash Flow	175
Table 9.15 Power-to-Gas Hydrogen French case (with participation to BAM) NPV calculation	176
Table 10.1 Scenarios considered in the LCA study	184
Table 10.2 Impact categories considered in the LCA study	187
Table 10.3 Electrolyser Component inventory	191
Table 10.4 Diaphragm compressor inventory.....	192
Table 10.5 Storage module inventory.....	193
Table 10.6 Walls and foundation inventory.....	193
Table 10.7 Other components inventory.....	194
Table 10.8 Maintenance inventory	194
Table 10.9 Operation inventory	195
Table 10.10 Hydrogen production and storage inventory.....	195
Table 10.11 SNG production from methanation inventory	197
Table 10.12 Electricity production in a natural gas power plant equipped with carbon capture (from natural gas) inventory.....	198
Table 10.13 Electricity production in natural gas power plant with carbon capture (using hydrogen as fuel) inventory.....	200
Table 10.14 Electricity production in natural gas power plant with carbon capture (using SNG as fuel) inventory	202
Table 10.15 SNG burned in boiler inventory.....	204
Table 10.16 Heat produced in boiler using SNG as fuel inventory	205
Table 10.17 Electricity production in natural gas power plant (no carbon capture) using SNG as fuel inventory	205
Table 10.18 Single Power-to-Gas cycle inventory	207
Table 10.19 Double Power-to-Gas cycle inventory.....	209
Table 10.20 Single Power-to-Gas cycle applied in the cement industry inventory	210
Table 10.21 Double Power-to-Gas cycle applied in the cement industry inventory.....	211

Table 10.22 Double Power-to-Gas cycle applied in the cement industry inventory	212
Table 10.23 GWP emissions of electricity production scenarios	216
Table 10.24 GWP emissions of electricity production in complex Power-to-Gas scenarios using fossil carbon from power plants.....	217
Table 10.25 GWP emissions of electricity production in complex Power-to-Gas scenarios using fossil carbon from the cement industry	220
Table 10.26 GWP emissions of heat production scenarios	224
Table 10.27 CED of hydrogen production scenarios	225
Table 10.28 CED of electricity production scenarios	227
Table 10.29 CED of heat production scenarios	229

LIST OF ABBREVIATIONS

BAM	–	Balancing Market
BoY	–	Beginning of the Year
CAPEX	–	Capital Expenditures
CC	–	Carbon Capture
CED	–	Cumulative Energy Demand
CHP	–	Combined Heat and Power
CMBC	-	Centralized Market for Bilateral Contracts
CNG	–	Compressed Natural Gas
DAM	–	Day-Ahead Market
DCF	–	Discounted Cash Flow
DSM	–	Demand Side Management
EBIT	-	Earnings Before Interest and Taxes
EBITDA	-	Earnings Before Interest, Taxes, Depreciation and Amortization
EBT	–	Earnings Before Taxes
EoY	–	End of the Year
EPEX	–	European Power Exchange
EU	–	European Union
FCFF	-	Free Cash Flow for the Firm
GHG	–	Greenhouse Gases
GWh	–	Gigawatt Hour
GWP	–	Global Warming Potential
HENG	–	Hydrogen Enriched Natural Gas
HHV	–	Higher Heating Value
IM	–	Intraday Market
IRR	–	Internal Rate of Return
KPI	–	Key Performance Indicators
LCA	–	Life Cycle Assessment
LCOE	–	Levelized Cost of Energy
LHV	–	Lower Heating Value
MJ	–	Mega Joule
MW	–	Megawatt
NGPP	–	Natural Gas Power Plant

NPV – Net Present Value
OPCOM – Romanian Gas and Electricity Market Operator
OPEX – Operational Expenditures
PEM – Proton Exchange Membrane
PHES – Pumped Heat Electrical Storage
RES – Renewable Energy Sources
RWGS – Water Gas Shift Reaction
SNG – Substitute Natural Gas
SOEC – Solid Oxide Electrolysis Cells
TREMPE - Topsoe’s Recycle Energy-efficient Methanation Process
TSO – Transmission System Operator
TWh - Terawatt Hour

ACKNOWLEDGEMENTS

Wow...it's been a journey. And like with any journey, the road itself is the truly worthy experience rather than the destination. And what would a journey be without the people you meet along the way?

I find it close to impossible to acknowledge and express my deep gratitude to every person that has helped or supported me throughout these last four years in any other way than chronologically. There will be a lot of "thank you" in the next paragraphs.

So, it all has to start with the great people at ICSI Rm. Valcea, especially Mr. Varlam and Prof. Stefanescu, that guided me towards starting a PhD and offered their full support during all these years, even agreeing to me going to France for 18 months and staying away from the Institute's activities.

Then, I remember how it all started with a phone call from Prof. Adrian Badea, in a cold February morning, telling me that there might be an opportunity for a scholarship in France and that we should meet and discuss about it. Dear Prof. Badea, I know that nothing would have been possible without your guidance and I am deeply grateful for this.

Fast forward a couple of weeks to the first meeting with representatives of GDF Suez Energy Romania, CEA and l' Institut Français de Roumanie. I have to thank Mr. Olivier Maigrot as one of the main supporters of the idea behind this Thesis for the trust you had in me in the beginning. The French Embassy in Bucharest and l' Institut Français de Roumanie, Mr. Fabien Flori, Ms. Isabelle Glas and Ms. Justine Lacousse, have been of huge support in dealing with the quite complicated administrative details of the Thesis.

And since we arrived at this point, my sincere gratitude goes to GDF Suez Energy Romania, now ENGIE, as the company that financed the Thesis and all the wonderful people that offered support whenever I had a question or needed some data. Mr. Razvan Grecu, I am deeply grateful for your extremely precious insight and expertise on the changing energy domain, for your advice, kind and encouraging words and for the few, but very consistent discussions we

had. It meant a lot. I know that you always asked me to call you by your first name, which I haven't really done until now. Thank you, Razvan!

Grenoble became my second home for roughly 18 months and the I must send all my gratitude to the wonderful people from CEA and especially the L2ED laboratory for making it a lot easier, for showing what a team is and for all the knowledge and experience that has been shared. Pierre, François, Isabelle, Bénédicte, Elise, Cyril, Florent, Julie and all the other great persons that were part of the lab, thank you for your patience with my French skills and for the great times we've had at lunch every day. Alexander, Margalida and Mathias, you were the best office colleagues and you were so interested in everything about Romania. Benjamin, thank you for your help with Odyssey, it was an invaluable tool for the Thesis. I highly appreciate the time we spent together trying to make it work. Also, thanks for your insight on the balancing market and all your kind and patient answers. Mr. Alain Bengaouer, many thanks for your help in precisely sizing the methanation reactor.

Dear Aymeric, these are the pages that took me the most time to write in all my Thesis and one of the reasons is that I don't really know how to express my gratitude towards you. Our brainstorming sessions were the backbone of this Thesis and I simply cannot thank you enough for all your kindness and support. Words do no justice here, so I just hope that we'll meet again really soon.

Prof. Froelich, a huge thank you for accepting me as your student even though I did not have any experience with environmental evaluations. I will definitely remember the private crash course on LCA you kindly gave me in Chambéry. Thank you for all your support throughout the Thesis, I know it wasn't easy at all.

One has to admit when chemistry is not his strong point and there was plenty of chemistry in this Thesis. So, Ramona, thank you for all your help in everything related to the methanation side. Also, I really must thank you and Alex for taking over my work-related tasks whenever I needed to focus on the Thesis or during my time spent in France.

I cannot end without thanking my family for all the support and for their patience with me. I definitely need to show my gratitude more often, although I am sure you are aware of my appreciation.

Andreea...thank you!

Thesis financed by ENGIE Romania through the French Embassy in Bucharest in cooperation with CEA Liten Grenoble.

1 INTRODUCTION

The general context and goal of the work was initially described by ENGIE Romania (former GDF Suez Energy Romania), as financiers of the Thesis, operators of the natural gas distribution network and owners of a 50 MW wind park in the Dobrogea region of Romania: investigating storing renewable energy under the form of methane, using a technology widely known as Power-to-Gas, in order to optimize the operation of the wind park and offer better value to surplus energy. The goal of the Thesis was further refined in cooperation with Thesis partners CEA Liten Grenoble, into investigating the feasibility of a Power-to-Gas project working in conjunction with a wind park, thus fed only by renewable electricity, through a three-level approach: technical, economic and environmental.

Besides being the first study concerning Power-to-Gas in the current context of the Romanian energy system, a novel aspect of the current Thesis lays in the multidisciplinary approach towards this technology. While technical and economic evaluations are essential in proposing a suitable technical solution and establishing its economic feasibility, the environmental assessment is useful in determining whether or not Power-to-Gas can bring value in terms of reducing GWP emissions and improving energy efficiency by reducing fossil energy use, a potential incipient step in adopting a legal framework and support measures for such energy storage technologies.

1.1 CONTEXT

The last couple of decades have brought a major change in the way the industrial stakeholders, scientific community and the public opinion sees the future of the energy sector. While fossil fuels have been and will continue to be used at least for the foreseeable medium term future, obviously the focus has shifted on sustainable ways of producing energy, ones that don't have a finite character and a less significant impact on the environment.

At this moment, the energy sector has encountered a crossroad. In numerous countries, renewable energy sources have started to represent an ever-increasing percentage of the energy mix and while this certainly is good news in terms of long term sustainability of the energy sector and lowering greenhouse gas emissions, the other not so positive aspects also have to be taken in to consideration. Without doubt the one that has the biggest significance is the intermittent nature of the renewable energy sources that can be used for multi-megawatt energy production. Whether we are talking about photovoltaic panels and their ability to feed energy to the system during sun hours, or wind turbines that are directly dependent on wind energy, it is often extremely difficult to have a precise forecast on the amount of energy they are able to produce in a given period of time. The intermittency leads to the next issue related to renewable energy sources, a very often time mismatch between the electricity they are able to supply to the grid and the demand of the market. As a consequence, renewable energy sources are not optimally used and a loss of economic value frequently occurs. In addition to all the previously mentioned issues, there are specific cases where renewable energy sources are concentrated in a certain region thanks to its energetic potential, causing a high level of saturation in the electric grid and difficulties in transporting the energy to other regions where it might be needed.

[Faulstich et al. 2011] states that the further development of renewable electric energy production facilities has an uncertain future behind a certain threshold until the scientific and industrial community surrounding the energy sector will find a way to surpass the above-mentioned issues. The topic has been widely investigated especially in the last decade and one of the conclusions was that a form of large scale energy storage is necessary in order to solve the intermittency and the time mismatch issues, in addition to providing valuable grid balancing services. Due to the fact that traditional energy storage solutions (batteries, pumped hydro energy storage or compressed air energy storage) come with certain disadvantages as presented by [stoRE project 2012], the scientific community has turned its attention towards a new energy carrier: hydrogen. In collaboration with the suitable energy storage and reconversion technical solutions, it has the potential to represent the answer to the issues related to the expansion of renewable energy sources, in the so called “Power-to-Gas” projects.

Two of the most relevant reports in the domain, [European Commission 2014] and [EWEA 2014] reveal that in the last several years, Romania has been one of the most attractive European countries in terms of renewable energy investments. The extremely generous governmental green certificate support scheme has helped the country record a massive boost in wind power installed capacity, from nearly zero in 2007 (about 7 MW), to 1905 MW at the

end of 2012, with 3990 more MW already approved. Therefore, in spite of the recent cuts in the renewable energy incentive scheme, Romania is and will definitely continue to be a competitive market for renewable energy investments.

However, Romania's renewable energy potential and existent investments, especially in wind energy, are concentrated in a single part of the country, Dobrogea region. This aspect raises some serious issues related to the saturation of the electricity transport network. The infrastructure is old and was not designed and sized for handling such a massive amount of fluctuating renewable energy. In addition, wind farms produce a significant quantity of energy during off-peak hours, excess energy that cannot be efficiently used, leading to a massive loss of value. The current situation added to the already approved future investments in wind farms, has led renewable energy producers, energy transport and distribution companies, authorities and policy makers to start analyzing the possibility of deploying a new technical solution that would bring balance to the energy system.

1.2 RESPONSE

Power-to-Gas represents an innovative concept that offers a new way of managing energy generation and loads, allowing a significant quantity of fluctuating electricity produced by renewable energy sources to be accommodated in the energy system. Technologically speaking, Power-to-Gas offers important functions for the energy system: a) energy storage of the otherwise unused or low value surplus electric energy generated by renewable energy sources and b) energy transport, by using the existing natural gas transport and distribution network instead of the increasingly saturated electricity network. Existing studies confirm Power-to-Gas as a scalable complex technical solution that is capable of offering storage capacity and adding an important degree of flexibility to the energy system [Jentsch et al. 2014], [Sterner 2009].

Leveraging Power-to-Gas in the current Romanian context has the potential of solving all the aforementioned issues. Comprehensive studies are already in development, evaluating the technical, economic and environmental aspects of deploying the Power-to-Gas concept, in all its forms, in Romania. The high complexity of the concept, given by the number of different technical processes that have to work perfectly together, by using two or even three energy vectors (electricity, hydrogen and methane) and by creating a bidirectional connection between

the electricity and the natural gas grid, will require a sustained combined effort from the scientific and industrial community in order to offer the right answer to the questions: “Can Power-to-Gas represent a feasible solution for the current Romanian context, from technical, economic and environmental point of view?” and “If not, what needs to be changed in order to become?”.

Judging by all the standards of the concept, Dobrogea (Romania) is a text book scenario for leveraging Power-to-Gas. Renewable energy production capabilities, large CO₂ emitters (that will be used for converting hydrogen to methane), a saturated electricity transport and distribution grid and a well-developed natural gas grid coexist in a relatively small area, offering many possibilities for connecting the bricks in order to obtain the most efficient solution.

Extending the horizon of the Romanian study, Power-to-Gas can potentially be a solution to a changing energy paradigm at European level, where each country has its own particularities. France represents one of the most interesting case studies for energy storage solutions due to its unique energy mix dominated by nuclear energy that has a controversial future in the following years. In a country where peak-energy is extremely valuable, Power-to-Gas technology is regarded as a potentially valuable tool in the transition toward a future energy system, taking into account its possible synergies and identification of high-value markets.

The outlook of the Thesis consists in a multidisciplinary approach to Power-to-Gas, rather than focusing on a very specific area of the subject. Therefore, the objectives of the current work can be summarized by the following points, which also define the backbone of the Thesis that runs through eleven chapters:

- Develop a deep understanding of the Power-to-Gas concept and its role in the current and future energy context.
- Establish a thorough knowledge base on the main technologies that represent the components of Power-to-Gas, their key performance indicators and their expected evolution.
- Perform a techno-economic evaluation of the possibility of leveraging the Power-to-Gas technology (in the Hydrogen and SNG pathways) in a non-holistic, private stakeholder implementation in conjunction with a wind park, taking into account the Romanian context, in two temporal perspectives: 2015 and 2030.

- Investigate the possibility of providing ancillary services as a high-value market for Power-to-Gas applications in the current French energy context.
- Evaluate the environmental impact of leveraging Power-to-Gas in several specific implementation scenarios by performing a simplified life cycle assessment.

1.3 THESIS OVERVIEW

The Thesis is divided into eleven chapters, with the first three describing the “Thesis Context”, the “Development of Energy Storage in Link with Renewable Energy Integration” and the “Romanian Energy Context”, establishing the landmarks based on which the further assessments are performed.

The fourth chapter presents “The Power-to-Gas Concept”, its main functions related to energy storage, transport, conversion, as well as a possible environmental function. The two Power-to-Gas pathways taken into consideration for the Thesis are detailed: Hydrogen (renewable energy is transformed into hydrogen which is directly injected in the natural gas grid) and SNG (hydrogen is combined with CO₂ and transformed into SNG – Substitute Natural Gas – which is injected into the natural gas grid without any concentration limitations). Another key section of the chapter deals with the constraints related to integrating hydrogen in the natural gas grid, including a discussion on the legislative aspects currently in place in several European countries.

The next chapter reviews the “Components of the Power-to-Gas Concept”, focusing on electrolysis and methanation technologies, as well as hydrogen compression and storage, presenting the options that are currently available to choose from in establishing the proposed technical solutions for the context of the Thesis. Current Key Performance Indicators (KPIs) regarding efficiency, flexibility, lifetime and cost figures are presented, as well as the expected further developments and trends for each technology.

Chapter number six is focusing on “Developing an analysis framework for Power-to-Gas projects”, basically establishing the theoretical methodology for evaluating such projects given similar input data with the ones available in the current case. A strategy for sizing the components of the Power-to-Gas chain is proposed based on setting several threshold values for the electricity price in order to calculate the amount of surplus (or low value) energy that is available for storage. The sizing of the components is performed in link with a simple strategy

based on a price threshold on the electricity market price: if the market price is lower than the given value the electricity is the input of the electrolysis prices, if not, the electricity is sold on the energy market. Sensitivity on both technical sizing and market price threshold is then performed to identify an optimum in the sizing of the components and operating strategy in terms of price threshold.

In order to perform the techno-economic assessment of the Power-to-Gas SNG pathway, a thorough “Modeling of the Methanation Process” was performed in chapter seven. A TREMP-like (Topsoe’s Recycle Energy-efficient Methanation Process developed by Haldor-Topsoe) catalytic methanation process was taken into consideration since the goal was to analyze a Power-to-Gas solution containing mature technologies that can be deployed at the considered scale in the immediate future. Based on the calculated hydrogen output of the electrolysis process, an Aspen Plus simulation was carried out to size the methanation reactor, determine the necessary fresh CO₂ flow as well as the SNG output and composition and the residual heat of the exothermic process.

The next chapter “Leveraging Power-to-Gas in the Romanian Case” contains the techno-economic assessment of deploying Power-to-Gas in the previously described national context. The input data for the technical evaluation consists of real measurements of the energy production of a 50 MW wind turbine park situated in the South-Eastern part of Romania, along with the corresponding hourly prices on the Romanian day ahead electricity market. Starting from this information, six threshold values were chosen as different scenarios: 20, 30, 40, 50, 60 and 70 EUR/MWh. Using ODYSSEY, software developed internally in CEA, data regarding the wind park’s energy production and the electricity prices was processed to calculate the amount of surplus (or low value) electricity available for each scenario. Using the same software and on the technical hypothesis describing alkaline electrolysis units, the resulting quantity of hydrogen produced in each scenario is calculated. For each price threshold, different potential sizes of electrolysis units are considered (10, 20, 30, 40 and 50 MW). The available input hydrogen quantity for the methanation reactor is obtained. Intermediate storage of hydrogen between electrolysis and methanation is considered to ensure an optimum continuous operation of the methanation reactor. For Power-to-Gas Hydrogen – with an overall efficiency of 62%, the yearly output of renewable hydrogen is 945,000 kg H₂ corresponding to 37,245 MWh HHV. Since the capacity factor of the electrolysis unit in this scenario is just below 71%, a stack replacement operation is required after 10 years of running time. The NPV (Net Present Value) calculated for a discount rate of 10% is negative for a

project lifetime of 20 years – -21.1 Million Euro in case there are no incentives for renewable hydrogen injected in the natural gas grid where it would be valued as natural gas at a price of 19.56 Euro/MWh. The results of the sensitivity analysis on the quantum of the price premium for renewable hydrogen indicate that the break-even point for this pathway is reached for a price premium of 68.1 Euro/MWh. For Power-to-Gas SNG – with the calculated efficiency of 54% (not taking into account the residual heat from the methanation reaction, nor the energy required for capturing the required CO₂) for a yearly output of approximately 28,600 MWh HHV of renewable SNG the calculated NPV is again negative, -26.6 Million Euro, for the same discount rate of 10% and 20 years' lifetime, with no incentives for renewable SNG being injected in the natural gas grid. The break-even point would be reached for a price premium of 112 Euro/MWh, potentially enabled by a support scheme for renewable SNG. In the 2030 scenario, due to reduced CAPEX and OPEX costs, the operating strategy shifts to using a lower energy price threshold (40 Euro/MWh for alkaline electrolysis and 50 Euro/MWh for PEM electrolysis) for the Hydrogen pathway, as well as for the SNG pathway. The required price premiums for reaching the break-even point drop considerably, but interestingly alkaline electrolysis will still offer better economic efficiency.

Chapter nine deals with “Leveraging Power-to-Gas in the French Context with Participation to the Balancing Market”. The capacity factor of the electrolysis units is increased by operating on the Balancing Market when there is no demand from the EPEX Spot Market leading to a 4% improvement in the NPV economic indicator when using the BAM compared to the situation in which the BAM is not used, but only if the initial conditions of the sizing stage are not modified: if the final product of the process is hydrogen, (thus only for the Power-to-Gas Hydrogen) and if no support mechanisms are put into place. This leads to the conclusion that a different strategy for determining the optimum sizing is required if the desired result is the optimum scenario. The current sizing strategy can be applied successfully only if we are looking to determine the optimum project size and operating strategy in the current context, and only for the Power-to-Gas Hydrogen pathway.

The tenth chapter, “Environmental Evaluation of Power-to-Gas” is intended to offer an overview of the environmental impacts associated with various Power-to-Gas pathways and scenarios. It is not intended to be exhaustive for each scenario, but rather focuses on providing a broad perspective of the impacts associated to multiple energy related applications of Power-to-Gas technology. The choice of the three functional units covers the whole range of applications for the Power-to-Gas scenarios considered inside the Thesis: 1 kg of hydrogen, 1

kWh of electricity and 1 MJ of heat and there are three different energy mix scenarios chosen for the source of the electricity: Romanian, French and 100% renewable mix. Since the LCA is considering energy-related applications, two impact categories were chosen to be specifically relevant for this type of study: global warming potential (GWP 100 years IPCC 2007) and primary energy consumption (Cumulative Energy Demand). Lacking foreground data that would have led to a more comprehensive life cycle assessment of Power-to-Gas, the objective of the study was to cover a broader range of applications developed around the technological concept. Inventories were generally assembled from background data from literature, except the methanation stage, while process data was imported from the technical simulation performed in the previous chapters of the Thesis. One of the most interesting findings, that had an impact on the way the study was performed, was the significant influence of the electricity required for the hydrogen compression phase in the operation stage of hydrogen production. Looking at hydrogen production, it is clearly visible that renewable hydrogen has a lower GWP impact compared to the reference steam reforming scenario. The CED indicator also shows that it is a more favorable pathway to choose in terms of avoiding the use of fossil energy, especially in the scenario that uses 100% renewable energy. Producing electricity from renewable hydrogen is more favorable than using SNG for the same purpose, both in terms of GWP emissions and cumulative energy demand. Hydrogen does not carry a CO₂ burden and requires less transformation processes before its final use, the hydrogen pathway proving to be the one to choose when considering environmental and resource depletion benefits. When considering complete Power-to-Gas cycles that rely on fossil carbon captured from power plants of the cement industry, the results indicate that trapping carbon dioxide inside the loop multiple times results in GWP emission and fossil energy demand reductions, basically incentivizing multiple energetic use of the same quantity of CO₂ before finally emitting it. Compared to the reference electricity from natural gas scenario, both Single and Double Power-to-Gas cycle scenarios provide better results in terms of GWP impact and fossil cumulative energy demand (with the exception of the Single Power-to-Gas cycle using the Romanian mix). In the case of Single and Double Power-to-Gas cycles that use fossil carbon dioxide captured from the cement industry, a big influence in the GWP and CED indicators comes from the source of energy used in the carbon capture process. Integrating the waste heat of the SNG production stage with the carbon capture process in the cement industry has the potential to lead towards even lower impacts. The infrastructure and consumables required for the analyzed scenarios have little influence, their associated impact in GWP and CED indicators being low in comparison with the impact of the energy required in different processes.

The last chapter states the “Conclusions and Perspective” of the Thesis, the most notable being that the results of the evaluation indicate that Power-to-Gas is not a financially viable investment at the moment without taking into consideration financial incentives, in the current Romanian context and given the technology costs that were considered. However, the latest reports point towards drastic reductions in CAPEX costs for electrolysis earlier than it was previously expected and more efficient electrolysis technologies such as high temperature electrolysis, leading to more favorable business cases. In addition, the analysis has revealed that high value markets need to be identified for renewable hydrogen and renewable methane in order to reduce the project’s feasibility dependency on significant price premiums. In addition to monetizing the outputs of the Power-to-Gas process on high value markets, establishing a strategy in which it can provide services to the energy system in terms of capacity and frequency control will also open new opportunities for this technology. From an environmental point of view, it is interesting to observe that the various applications developed around the Power-to-Gas core provide environmental benefits compared to their reference counterparts, both in terms of GWP emissions and fossil energy use. These can potentially represent the starting point in developing a support scheme that would incentivize the environmental benefits to encourage market deployment in spite of the current economic indicators.

2 DEVELOPMENT OF ENERGY STORAGE IN LINK WITH RENEWABLE ENERGY INTEGRATION

2.1 CLIMATE CHANGE – MAIN DRIVER OF PROGRESS

Starting with the last decade of the 20th century renewable energy began recording a steady increase in the energy mix at European level, an effort that was and continues to be encouraged by drastic goals imposed by climate change policy that target aggressive CO₂ reductions. Also encouraged by the success the expansion of renewable energy sources had in countries like Germany, member countries of the European Union have embarked on a mission to integrate an ever increasing share of renewable energy in their grid mix in order to achieve ambitious targets related not only to reductions in CO₂ emissions, but also a reduced dependency on energy related imports, an aspect that has become of major importance given the unexpected strategic and geo-political changes taking part in the Eastern part of the continent.

The first major initiative addressing energy and climate change objectives established by the European Commission was the “Energy 2020: A strategy for competitive, sustainable and secure energy” [European Commission 2010] that imposed the following objectives: a 20% reduction of greenhouse gas (GHG) emissions compared to 1990 levels, a 20% increase in the share of renewable energy mix and a 20% improvement in energy efficiency. The intermediate results the implementation of Energy 2020 were considered to be encouraging, but the need for a more comprehensive program for the long-term future was identified. Energy Roadmap 2050 [European Climate Foundation 2010] was established as a new set of policy guidelines for setting the trajectory of the European energy sector, promoting a reduction of 80 to 95 percent of GHG emissions compared to 1990 levels by 2050. The levers of this change have been identified in three categories: a decreased primary energy demand leading to energy savings, an increased share of renewable energy (reaching up to 97% in the so-called “high renewable

energy scenario”) and a 40% increase in interconnection capacity between EU countries. As an intermediate step between the two aforementioned milestones and consolidating on the lessons learned from Energy 2020, in October 2014 the European Commission adopted a new document, the 2030 Framework for Climate and Energy Policies [European Council 2014] which aims at increasing the competitiveness and the levels of security and sustainability of the European Union’s economy while transforming it into a low-carbon economy. The key milestone of the document lies in reducing the level of GHG emissions by 40% compared to 1990 values by the year 2030. In addition, the share of renewable energy will have to reach at least 27% of the energy consumption by 2030, while the same percentage is required to be applied to an increase in energy efficiency.

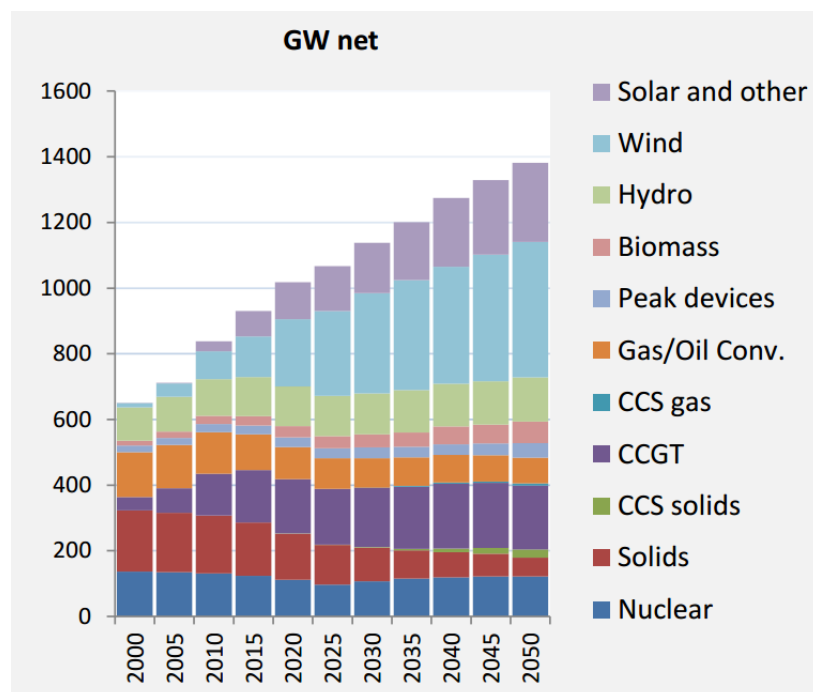

Figure 2.1 Development of installed power capacities at European level by 2050 (source: [European Commission DG ENER 2013])

The progress recorded up until this moment, along with the binding targets assumed by the EU member countries, indicate that the current growth in renewable energy expansion will not only continue, but its rate of development is expected to grow in the foreseeable future time frame as presented by Figure 2.1. This translates into the fact that an ever-increasing share of renewable energy must be integrated in the energy mix at European level. However, this change is not as straightforward as it might seem at first, since the integration of a high share of renewable energy into the mix brings along challenges and consequences that have the potential of completely changing the way current energy systems work and a significant amount of effort

will be required in developing the means that will allow the almost complete overhaul of the energy system.

2.2 CHALLENGES RELATED TO RENEWABLE ENERGY INTEGRATION

A significant increase in the share of renewable energy in the mix will require a drastic change in the way energy systems work. This type of energy will not only focus on electricity production, but it will extend over the areas of mobility and thermal energy production, creating synergies between bricks that today are functioning as independent systems.

The biggest challenge related to a larger share of renewable energy is caused by their inherent intermittent nature. Photovoltaic panels and wind turbines cannot produce energy when it is needed, but only during sun hours and, respectively, when the wind is blowing. While biomass can be regarded as dispatchable renewable energy source, its contribution in the total production will probably be low, in spite of the huge theoretical potential it has. Hydro power will continue to account for a large share of renewable energy production, but major new investments in this domain are less likely to happen, at least at European level. For this reason, renewable energy sources cannot provide direct substitutability for traditional energy generation plants, which cannot be taken out of operation and replaced only by their equivalent in wind turbines or PV panels. Due to the fact that energy still has to be produced during the periods when renewable sources cannot cover the demand, standard power plants (ideally gas power plants) will still have to be maintained in operation. However, the fact that they will only operate in part load, during peak demand hours, translates into a low economic efficiency and expensive energy which contradicts the purpose of a gain in economic competitiveness. The low capacity factor of PV panels and wind turbines is a measure of the intermittency of these energy generating technologies, one that can only be improved by coupling them with other technical concepts that would ensure a secure supply of energy [SBC Energy Institute 2014].

Somehow linked with the intermittency of renewable energy sources is their largely unpredictable character. Of course, weather prediction systems have evolved during the years and it is expected that in the near future the energy producers will be able to predict significant fluctuations caused by meteorological conditions based on more advanced prognosis methods.

However, there will always be a certain level of uncertainty in renewable energy production caused by the lack of accuracy in weather prediction, forcing the need for balancing technologies in order to maintain the stability of the energy system.

Another important challenge related to renewable energy is the lack of flexibility. At the moment, energy systems are operating on the basis of a very delicate balance between supply and demand. The load curve can take very different profiles and it is almost impossible to foresee its precise evolution during a day, meaning that in the current energy systems the generation has to carefully follow the load. In this endeavor, dispatchable and highly flexible energy generators are used for providing services that are categorized depending on the timescale: stability (frequency and voltage control over seconds up to a minute), balancing (deals with variation in load from minutes to days) and adequacy (refers to the power generation capacity that is needed for meeting the peak demand over longer periods of time). As renewable energy resources are variable and unpredictable on the supply side, their integration in the energy system leads to increased requirements for flexibility, decreasing the energy efficiency of the whole system. Thus, a new demand for curtailment and back-up generation means is created.

In the current way the energy system is organized, flexibility issues are addressed taking in to consideration the technical capability of a generation technology to respond to demands and on their marginal cost of production. One of the issues that has been identified related to the integration of renewable sources is their very low, close to zero, marginal cost, meaning that they will be the first option in the merit order ranking. This will impact conventional energy generation plants by pushing them away from the baseload and endangering their amortization rates (these plants have to run for as much time as possible in order to cover their capital and operational expenditures). Therefore, if renewable sources are deployed without any efficient means of controlling their supply, the system will probably be faced with a rise in costs associated to energy production.

Since renewable energy sources lack a high level of flexibility on the supply side, it is expected that in a likely high penetration scenario the way energy systems are operated (with generation closely following the load) will have to suffer interesting changes, meaning that new flexibility resources will have to be added outside the energy production area.

2.3 AVAILABLE OPTIONS FOR EFFICIENT RENEWABLE ENERGY INTEGRATION

Taking into consideration the above-mentioned constraints related to renewable energy and the challenges it poses, a consensus has been reached regarding the fact that a larger share of renewable energy cannot be accommodated by the energy system without additional technologies that will enable the transition towards an evolved system.

At the moment three technical solutions have been identified as possible options for efficiently integrating a large share of renewable energy:

- a. Grid expansion – represents the most straightforward option given the fact that the required technology is commercially available and it is not a technology that is yet to pass the “valley of death”. It has the potential of improving essential aspects like energy security and reliability of supply, but does not represent the best option in terms of flexibility. By exploiting the geographic diversity of renewable energy generation across Europe, grid expansion can also lower the level of uncertainty in energy production. However, grid expansion at all voltage levels and across Europe is required, studies revealing the need for more than 52000 km only for high voltage power lines. Consequently, grid expansion at this level would be a process that would stretch for over 10 years and will have to face the social acceptance test concerning land use and the inherent environmental impacts. Up to a certain degree, grid expansion will be deployed in the following years as part of the current plans of some of the European Union member states for improved interconnection.
- b. Demand Side Management (DSM) – it includes several mechanisms that can be deployed in order to improve flexibility on the demand side and change the way the energy system is governed (with a flexible load following the generation). DSM technologies have the potential of shifting consumption from peak periods to off-peak periods. Demand Side Management can be regarded as a necessary stage in the development of smart grid systems. There are several categories where DSM can be deployed: industry (has a high technical potential especially in chemical, cement, food and steel industry, however the economic potential remains to be established, having significant variability on a case by case basis), household applications (with again a considerable theoretical potential given by the high number of appliances present in a general household, along with HVAC solutions, but the impact on the overall comfort

levels has to be taken into consideration) and e-mobility (which potentially links the transport system to the energy system by allowing load shifting on a grid-to-vehicle and vehicle-to-grid basis. However, this solution is largely dependent on the growth of the number of electric vehicles and at the moment it is regarded as a medium-future solution. DSM is an elegant technical solution, but it requires action on several levels and its main downside is that it can only provide load management services on hourly level. [HyUnder 2013]

- c. Energy storage – out of all the options presented until now energy storage certainly provides the highest level of flexibility for integrating larger shares of renewable energy. Depending on the scale, there are numerous technical options for energy storage: capacitors, flywheels, batteries, compressed air, pumped hydro and Power-to-Gas. The level of evolution of all these technologies is not uniform at the moment. While some of them have existed for several decades, they have mostly been applied to much smaller scales, take for example batteries, where new developments are put in place in order to make this technology suitable for medium to large scale energy storage (evolution of flow or redox batteries). Pumped hydro energy storage is a mature technology from all points of view and the one with the highest efficiency levels. However, it has issues caused by the availability of suitable geographic locations for such projects and the social and environmental impacts they have. On the other hand, Power-to-Gas is the most flexible energy storage solution and one that can also provide interesting synergies with certain industrial branches or the mobility sector. However, although it has been technologically proven, it still has to pass through the “valley of death” until it will become widely regarded as a commercially mature energy storage solution [SBC Energy Institute 2014]. Compared to the other options for renewable energy integration, energy storage can provide load management on all time frames, even seasonal in the case of Power-to-Gas where the gas infrastructure is able to provide sufficient storage capacity, as depicted by Figure 2.2.

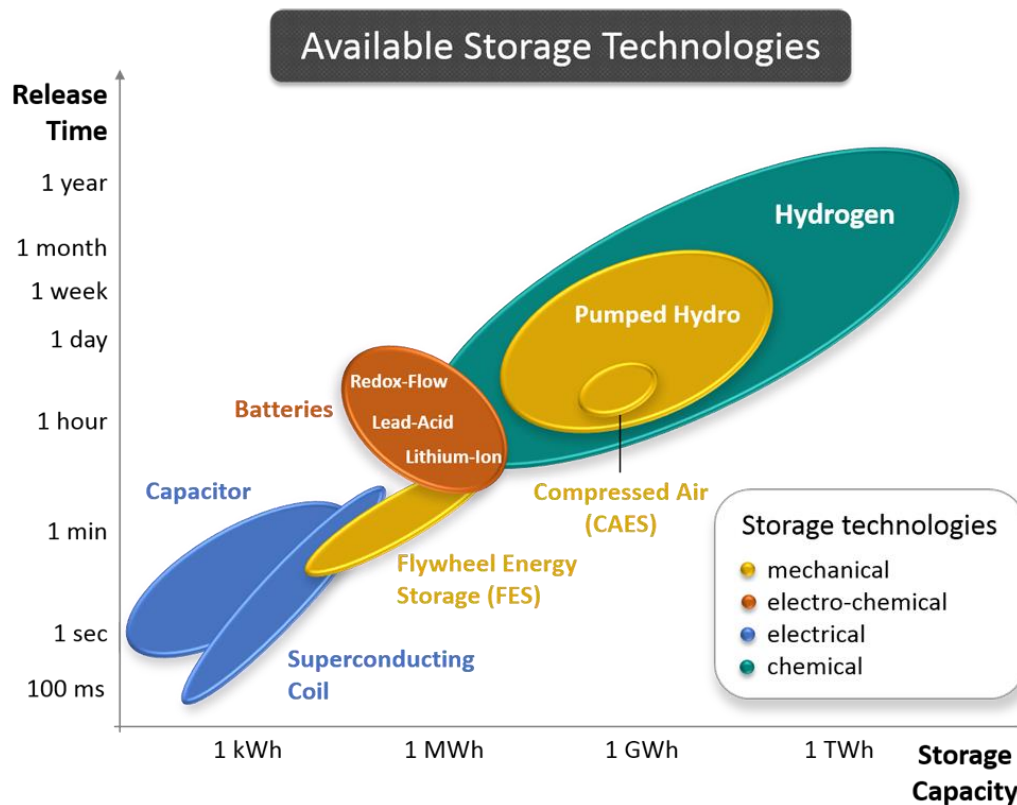

Figure 2.2 Capacity of various energy storage technologies [source: [Hydrogenious 2015]]

2.4 DEPLOYMENT OF ENERGY STORAGE IN LINK WITH RENEWABLE ENERGY INTEGRATION

Studies conducted at German energy system level [Fraunhofer Institute for Solar Energy Systems 2015], [Jentsch et al. 2014], [Agora 2014], which is currently the most advanced in Europe in terms of renewable energy development, have taken into account several scenarios for the future and analyzed the requirement for energy storage in the context of high renewable energy sources penetration and two different grid expansion scenarios. Up to 2030 horizon, energy storage is not economically justified if we consider that grid expansion will remove all energy transport and distribution constrains. However, in the case of a low connectivity grid, using energy storage will be justified even in both hypotheses of the 2030 scenario (reference and high RES penetration). In the 2050 high RES penetration scenario envisioned in the study, there will be an important amount of excess energy that is going to be available for energy storage, making it economically viable in both connectivity hypotheses. Note that a high CO₂

reduction scenario directly involves significantly higher costs for CO₂ emission certificates compared to the cost of today (100 Euro/t CO₂ compared to approximately 5 Euro/t CO₂).

In all the projected scenarios that are taken into consideration for high renewable energy integration and consequently high CO₂ reduction levels, mobility is regarded as becoming an important component of the energy system if energy storage is deployed. In the case of Power-to-Gas, renewable hydrogen or methane cannot be cost effective compared to natural gas in any reasonable scenario, therefore economically viable solutions consist in using it as fuel in the transportation system for future gas powered or fuel cell vehicles that are expected to become more popular and bring their contribution to reaching CO₂ reduction targets.

At the moment energy storage technologies can only reach economic feasibility in few specific cases where then can take full benefit of high value markets. However, in order to expand these solutions at a bigger level, there is a certain need for pull measures that would ease the transition towards a new energy system. A comprehensive update on the current policy framework in order to include measures that will support energy storage technologies is a frequent topic of discussion among the specialists in the domain. However, balancing these measures will prove to be an extremely difficult task, especially in the current situation in which European Union countries don't share a unified policy regarding energy related measures. The goal is to offer a level playing field to all the energy storage solutions that can be integrated into the system, without making any type of discrimination.

2.5 PERSPECTIVES

For the moment the energy systems of the European Union member countries do not need energy storage with few minor exceptions [ADEME 2014] [SBC Energy Institute 2014]. In the current state of development and integration of renewable energy sources the system can be balanced using the existent infrastructure. However, things are going to change with the increased share of renewable energy in the energy mix, a measure driven especially by the need of reducing CO₂ emissions. First, there will be a need for short-time energy storage with the purpose of consolidating the flexibility of the system and providing valuable ancillary services, while in the more distant future there will be a need for long-term energy storage (even seasonal) that will mainly contribute towards ensuring the security of supply and energy independence of the European Union.

Technically, energy storage has been solved. Of course, there will be further progress regarding efficiency, improved lifetime and the inherent marginal gains, but the technologies have been proven. However, energy storage technologies still have to pass the so-called “valley of death” (see Figure 2.3) and this means achieving economic feasibility [SBC Energy Institute 2014]. Although we are facing a significant reduction in capital costs of most energy storage options in the last period, there is still room for improvement and the general consensus is that the most powerful tool for cost reduction is the market. Therefore, gradual market implementation coupled with further progress in research & development is expected to drive the costs down quickly, in a similar manner to the success of the photovoltaic sector [Agora 2014].

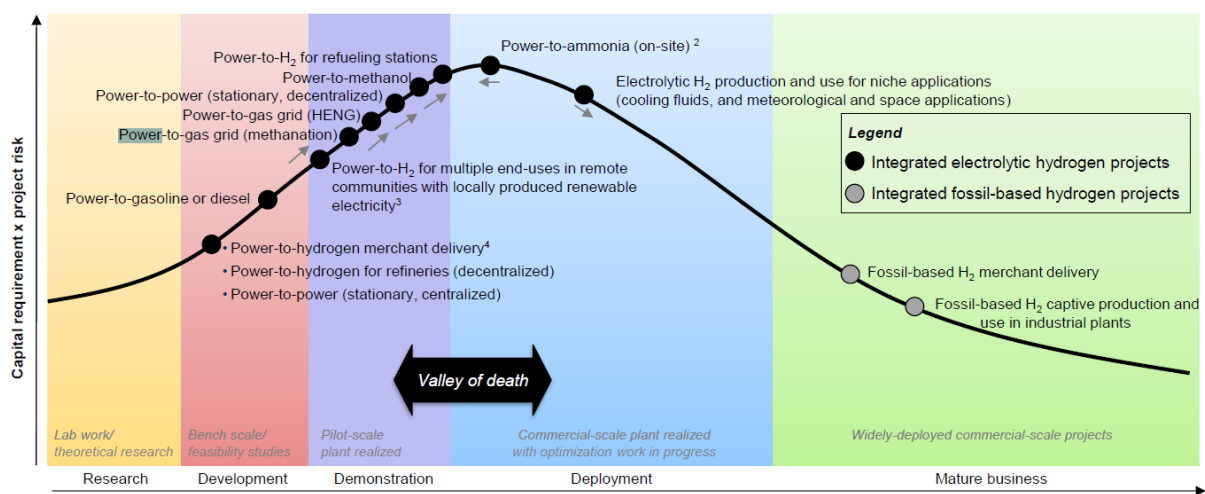

Figure 2.3 Commercial maturity of different Power-to-Gas projects (source: [SBC Energy Institute 2014])

Building on the two previous paragraphs, it is important to note that there are still several competing technologies for energy storage. Grid expansion will be deployed first because it is cheaper and will represent the first measure taken for integrating an increasing share of renewable energy. However, energy storage will follow grid expansion when the increased share of renewables will require long term energy storage and a high level of flexibility. Inside the energy storage community, the idea that “there is no silver bullet” has been widely accepted. The energy system is going to radically change in the future and this will create room for a wide array of technologies and strategies.

A study conducted in Germany, [Fraunhofer Institute for Solar Energy Systems 2015], indicates that reaching the ambitious imposed CO₂ reduction targets of above 82% cannot be achieved without deploying Power-to-Gas technology, whether the Hydrogen or the SNG pathway is taken into consideration. In addition to this claim, the same study indicates that using Power-to-Gas can bring considerable savings to the system (approximately 60 billion

Euro per year) compared to the situation in which the technology is not used. A third important conclusion of the study refers to achieving energy independency, suggesting that the SNG produced by leveraging Power-to-Gas can replace the import of fossil natural gas.

Changes will also have to occur when taking into consideration policy measures needed to sustain the development of energy storage. However, it seems that these measures will not be targeted at offering subsidies, as many expected, but at removing barriers and creating a legal context that will help establish energy storage as the fourth pillar of the energy system along with production, transport and distribution [Agora 2014].

3 ROMANIAN ENERGY CONTEXT

3.1 ELECTRIC ENERGY SECTOR

3.1.1 Overview

Since 1990 electric energy demand has recorded significant variations in Romania in correlation with industrial, economic and societal evolutions. Therefore, in the first decade, between 1990 and 2000, the electric energy demand reduced considerably as a consequence of the degradation of the industrial sector. Beginning with the year 2000, the demand curve started to stabilize and the energy demand recorded the first positive evolution in a decade. Until 2008, the Romanian electric energy demand recorded a constant growth and peaked in the same year, in direct correlation with the economic situation of the country. Between 2008 and 2013, the gross electric energy demand suffered a 6% drop, being heavily influenced by the economic crisis and the further contraction of the industrial sector.

According to [Departamentul pentru Energie 2014] in 2013, the total electric energy demand was 49.706 TWh, 4.8% lower than the one recorded in the previous year. The industrial sector continues to have the main share in the demand structure with 56.1%, followed by the population with 23.9%. The total number of electric energy consumers was 9,011,095, with 99.8% present on the regulated market, while 0.2% represented consumers on the competitive market (with a share of 56.7% in terms of energy demand volume). The total energy produced in Romania in 2013 was 55.78 TWh, while the total energy delivered was 51.70 TWh. The structure of the delivered energy based on energy sources from 2008 to 2013 is presented in the following figure:

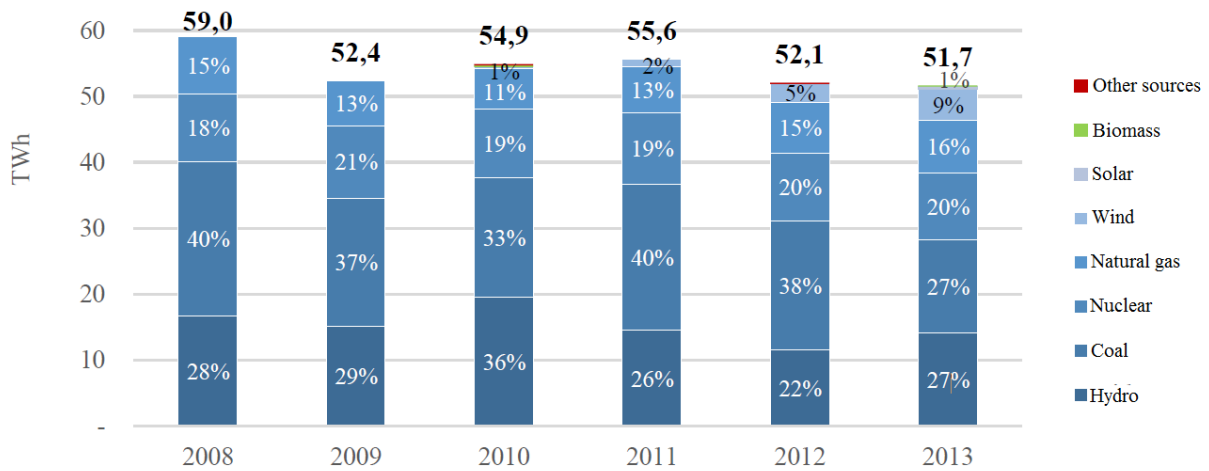

Figure 3.1 Structure of the delivered energy based on energy sources in Romania [Source: Departamentul pentru Energie 2014]

Coal and hydropower together have a share of 54.7% in the electric energy production, while nuclear energy covered 20.6% of the total share. With the expansion of renewable energy sources, wind energy has reached 9% in the energy production mix at 2013 level. In 2013, Romania imported 0.45 TWh of electric energy and exported 2.47 TWh. The aim at national level consists in maintaining the country's role as an important electric energy exporter in the Central and Eastern European market. The import and export balance between 2009 and 2013 is presented in the following figure:

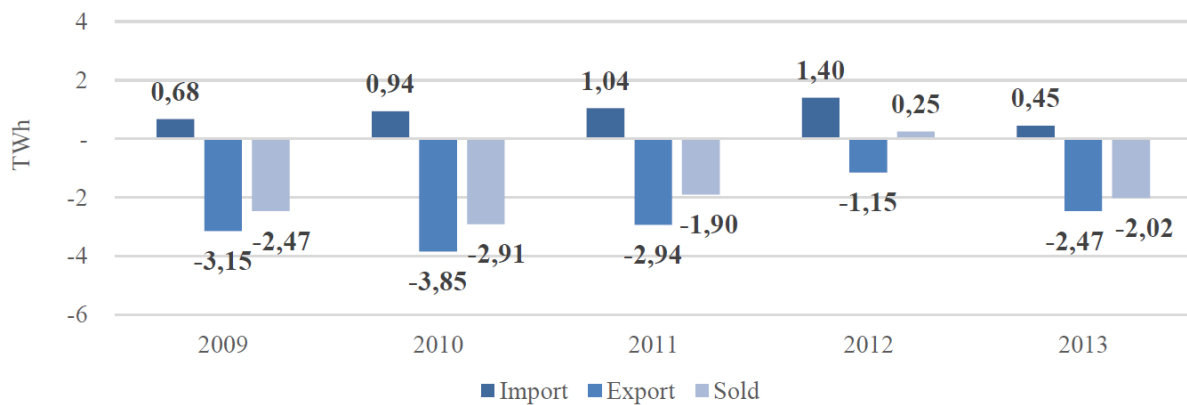

Figure 3.2 Import/Export balance associated to the Romanian electric energy sector [Source: Departamentul pentru Energie 2014]

3.1.2 Production

At 2013 level, the gross installed electric energy production capacity peaked at 23.7 GW, while the net production capacity was approximately 18 GW, Romania being the leading country in this sector in the South-Eastern part of Europe. The Romanian energy production capacities

are varied, the National Energy System containing hydropower, thermoelectric (coal and natural gas) and nuclear plants, as well as wind, photovoltaic and biomass production facilities. However, in spite of a balanced mix, the country is facing a series of significant challenges regarding the energy production facilities caused by the fact that most of them have exceeded their designed lifetime and are now economically inefficient and pollutant. More than 30% of these facilities have exceeded a lifetime of 40 years, 25% exceeded 30 years, while only 15% have been deployed in the last 5 years.

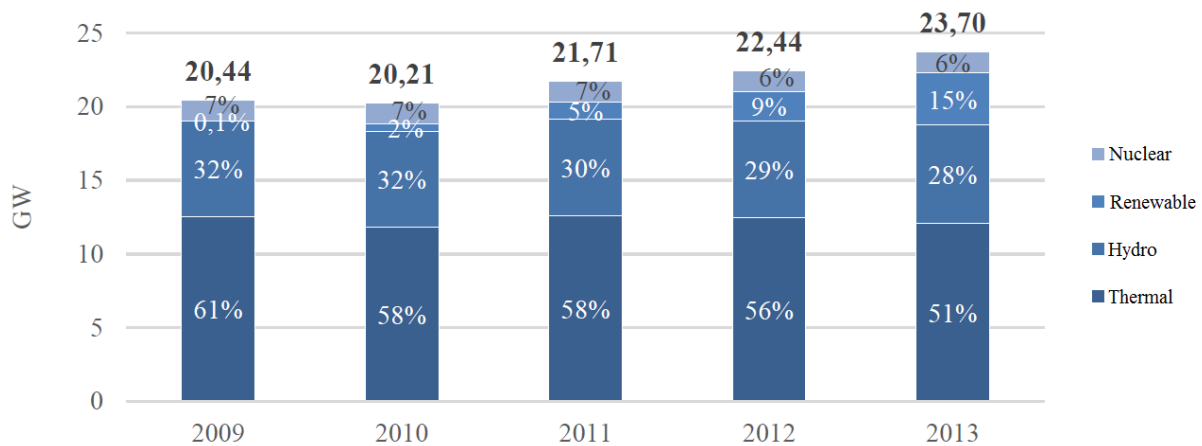

Figure 3.3 Evolution of the Romanian electric energy production capacities between 2009 and 2013 [Source: Departamentul pentru Energie 2014]

Nuclear - currently Romania has two nuclear units (Cernavoda 1 and 2) powered by CANDU 6 reactors using heavy water and natural uranium, each of the two groups having a total installed capacity of 706.5 MWe. The first unit started its operation in 1996, while the second was connected to the National Energy System in 2007, both having a theoretical lifetime of 55 years after the refurbishing operations necessary after 25 years of functioning. At the moment, there are plans to develop two additional 720 MWe units (Cernavoda 3 and 4), equipped with the same CANDU 6 reactor types, providing and envisioned annual production capacity of 11 TWh. The expansion of the Cernavoda nuclear power plant with two additional units has been identified as the most efficient solution for covering the production capacity deficit envisioned after 2020, taking into consideration technical and economic constraints as well as the possibility of using existent national resources and infrastructure. The Cernavoda nuclear power project is classified as an investment in low carbon emission technologies, mandatory for Romania in order to reach the ambitious decarbonization targets imposed at European level that are stating a 40 percent reduction in greenhouse gases emissions by the year 2030.

Additionally, nuclear energy has a major strategic contribution in assuring the security of supply and granting energy independence to the country.

Hydropower – the total energy production in hydroelectric power plants in 2013 was 15,012 GWh, approximately 98% being produced by Hidroelectrica, the most important company in the field with 261 hydroelectric power plants and pumping stations, totaling an installed production capacity of 6464 MW. Beginning with the year 2000, more than 1200 MW production capacities were upgraded and brought to the latest standards and by the year 2020 this figure will reach 2400 MW. In the hydropower field there are plans for an ambitious hydro pumping facility at Tarnita – Lapustesti, with an installed capacity of 1000 MW, aiming to provide balancing services to the national energy system.

Thermoelectric – In 2013 the total installed capacity in thermoelectric power plants equaled 10,690 MW, with 6,482 MW coming from condensation plants and 4,208 from cogeneration units. At the same year's level, the thermoelectric energy production added up to 27,021 GWh, composed from coal with 16,897 GWh, natural gas with 9,253 GWh, liquid fuels with 89 GWh and 782 from renewable energy sources. Approximately 80% of the total capacity was installed between 1970 and 1980, thus having already exceeded their nominal lifetime. In addition, the majority of these capacities is oversized and is mostly used for delivering thermal energy to urban communities. Due to the old technology and exceeded lifetime, the overall efficiency of the thermoelectric power plants in the Romanian energy system is between 30 and 33%, far from the current standards in the domain. Introduced in 2011, the support scheme for high efficiency cogeneration encouraged the development of new thermoelectric facilities and between 2011 and 2013 several production facilities totaling 68 MW (and a medium efficiency of 60%) were connected to the system. Most of the thermoelectric facilities in Romania do not comply with the European regulations regarding SO₂ and NO_x emissions and will have to align to the rules in order to stay in operation past 2015. However, drastic measures are difficult to impose since the energetic use of fossil fuels has a strategic role for Romania and thermoelectric power plants ensure the security of supply for the Romanian energy system especially during winter months.

Renewable energy sources – At the end of 2013, the total installed capacity of renewable energy production facilities was 4,418 MW, 63% coming from onshore wind turbines and approximately 23% from photovoltaic plants. The extremely abrupt evolution (from 47 MW in 2008 to 4,418 MW in 2013) finds in explanation in the generous renewable energy support

scheme put in place in order to help Romania achieve the goals imposed by the European 20-20-20 initiative. The Romanian energy system currently hosts the largest onshore wind farm in Europe, with a total installed capacity of 600 MW. Due to changes in the support scheme, the significant developments in wind energy were replaced by investments in photovoltaic plants, their total installed capacity growing in 2013 from 94 MW to approximately 860 MW. However, renewable energy sources are largely defined by intermittency and unpredictability, thus integrating a large share in the energy mix has the potential of impacting the balance of the national energy system.

3.1.3 Transport and Distribution

Transelectrica SA, a company at which the Romanian State holds the major share package (58.7%), is operating the Romanian electric energy transport and interconnection systems, which have an estimated import capacity of 2,000 MW and an export capacity of 1,900 MW, commercially operated at approximately 50% of their capacity.

The energy transport system evolved in correlation with the development of installed production capacities and taking into consideration a higher level of energy consumption than the current one. Therefore, the system is generally well developed and adequate for the current requirements of the national energy system. In 2013, more than 50% of the primary infrastructure was less than 12 years old and was equipped with modern technologies, as a result of the generally significant investments made in this part of the energy system. Some of the most relevant developments of the last years consist of: the deployment of the necessary infrastructure for the centralized electricity market, EMS-SCADA, platforms for the new energy markets, upgrading the majority of electric transport stations and the construction of new interconnection lines with Hungary and Serbia.

Current analyses indicate that the energy transport system will not face issues concerning the continuity of ensuring the energy demand in the near and medium future. There are, however, concerns related to the evolution of the decentralized renewable energy sources production capacities that have shifted the old balance point from the South-Western part of Romania towards the South-Eastern part of the country, leaving the North with a deficit in production facilities. Consequently, the priority will continue on future investments in new 400 kV lines.

Regarding the projects with a strategic component, Romania is part of the third priority corridor “NSI East Electricity” and will have to focus on connection projects with Serbia and Bulgaria.

The current level of consumer connection to the electric distribution grid is relatively high (96.3%) with a total of 8,769,602 connections at the end of 2013. One observation that needs to be made is that the technological energy consumption in the distribution grid is superior to the European Union average.

3.2 NATURAL GAS SECTOR

3.2.1 Overview

The Romanian natural gas sector has a tradition of over one hundred years and is at the moment one of the best developed at Central and Eastern European level in terms of annual production, infrastructure, expertise and available natural gas reserves. In the same time, Romania holds a favorable position regarding the independence from external natural gas sources, most of the consumption being covered by the internal natural gas production.

Romania currently holds the largest natural gas reserves in Central and Eastern Europe with a safe reserve total of 1,600 TWh and geologic resources of 6,500 TWh. A total percentage of 95% of the total conventional natural gas resources, respectively 93% of the safe reserves, are located onshore. However, most of Romania’s natural gas reserves are in an advanced state of exploitation and can only be operated at low pressures and flow.

For an average yearly natural gas production of 11 billion cubic meters, with a constant 5% yearly decline in safe reserves and a reserve replacement rate of 80%, it is estimated that the current natural gas reserves of Romania would be depleted in approximately 14 years. The perspectives of finding new resources are conditioned by the future volume of investments in geological exploration, as well as by the result of the exploration activities. In 2012 new natural gas reserves were discovered in the offshore Neptun perimeter, with resources estimated between 446 and 893 TWh, possibly increasing the national natural gas reserve by 40 to 80%.

The “World Shale Gas and Shale Oil Resource Assessment” issued by [EIA 2013] estimates that Romania holds considerable shale gas resources with approximately 14,882 TWh exploitable resources, being the third most important country in Europe from this point of view.

3.2.2 Demand

Between 2009 and 2013 the yearly natural gas consumption at national level has contracted by 5.4% to a point where the 2013 annual consumption reached 132.5 TWh. Electric and thermal energy producers hold the largest share of the consumption with 26%, followed by home users with 22% and industrial consumers with 16%. The total number of natural gas consumers in 2013 was 3,282,209, 99.9% of them being present on the regulated market and only 0.1% on the competitive market.

Home users have a level of connection to the natural gas grid of only 44.2% and the average natural gas consumption is below the average values of the European Union. The contraction of the industrial sector in the last years and the evolution of the economy led to negative effect on the natural gas consumption in this domain, while the deployment of renewable energy capacities reduced the natural gas consumption in the electric energy production sector.

In Romania, the natural gas demand reaches considerably higher levels during the cold season and the internal natural gas production and underground storage capacities cannot respond to this increase. In the last years, the supply of natural gas to certain sectors of the industry (chemical, petrochemical, energy production and metallurgy) have been limited during peak demand periods in order to ensure the demand from the other consumer categories when the temperature reaches low values.

3.2.3 Production

In 2013 the total natural gas consumption in Romania reached 132,6 TWh, 85% of this total being covered by internal production and the rest from imports. Although in the last years the internal production of natural gas had a decreasing tendency, it is estimated that in the following ten years the direction is going to be changed once the exploitation of shale gas and off shore reserves begin.

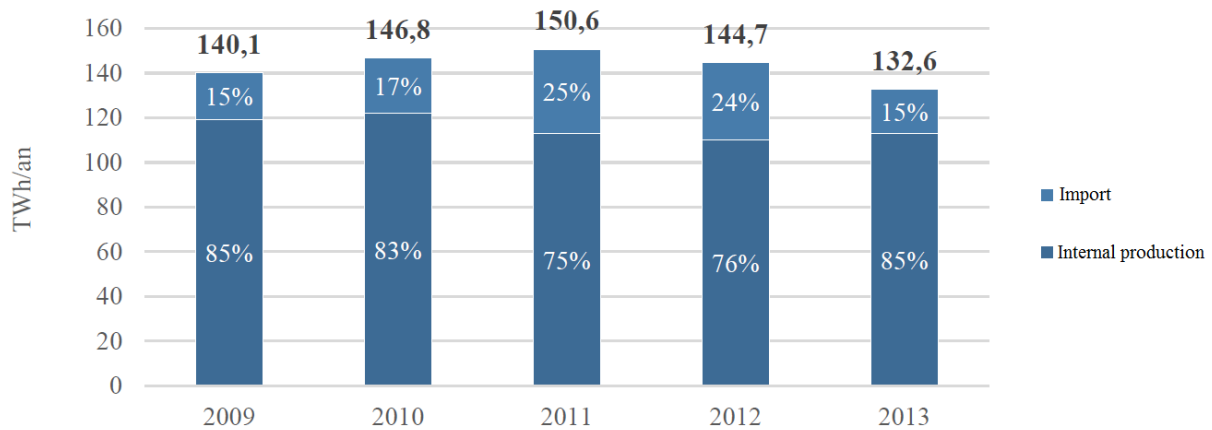

Figure 3.4 Evolution of the Romanian natural gas import and internal production between 2009 and 2013 2013
 [Source: Departamentul pentru Energie 2014]

Being the most important natural gas producer in Central and Eastern Europe Romania has a limited dependency on natural gas imports compared to the other countries from the region, as indicated by Figure 3.4. However, the flexibility of the internal natural gas production is a limiting factor that causes imports to become a necessity especially in the cold season. The main countries from which Romania is importing natural gas are Russia and Hungary.

3.2.4 Transport and Distribution

The Romanian national natural gas transport system operated by Transgaz ensures the transport capacity through a network with a length of approximately 13,000 km, with pressures ranging from 6 to 35 bar. The system currently has four interconnection points with Ukraine, Hungary and Moldavia, with a total annual import capacity of 153.44 TWh and an export capacity of just 1.39 TWh (with Hungary and Moldavia). The current interconnection capacity of Romania will increase with the completion of the interconnection point with Bulgaria (Giurgiu – Ruse) that will increase both the import and export capacities by 5.34 TWh in the first stage and later by 16.02 TWh. Romania also has three transit pipelines with a total length of 553 km that are not connected to the national natural gas transport system and are used for delivering natural gas from Russia to Bulgaria, Turkey and Greece.

Currently more than 70% of the natural gas transport infrastructure has a lifetime close to the nominal one, but pressure restrictions have been applied to certain segments where the lifetime has been already exceeded. The plans for the next period consist in building the interconnection point with Bulgaria, connecting the transit pipelines with the national natural gas transport system, connecting the offshore facilities in the Black Sea with the system, increasing the

export capacities with Hungary and the possibility of connecting with the Trans-Adriatic Pipeline that would allow the import of natural gas from the Caspian Sea area.

The reduced usage factor of the natural gas transport system caused by modifications in demand dynamics and natural gas sources generates technical difficulties regarding the operation and maintenance that generally translate in high operating costs.

The distribution system is composed of approximately 40,300 km of pipelines that deliver natural gas to more than 3.2 million consumers. There are 41 operators on the natural gas distribution market, with the two most important holding approximately 89% of the market share. In certain areas the natural gas distribution system is oversized, caused mainly by numerous disconnections and demand reduction, leading again to high operating costs.

3.2.5 Natural Gas Storage

The Romanian natural gas underground storage capacity has recorded a permanent evolution peaking at the end of 2013 at 47.84 TWh, out of which 32.53 TWh represents the useful volume. Currently Romania has seven underground storage deposits built in depleted fields, six of them being operated by Romgaz and one of them by GDF SUEZ and Romgaz (3.19 TWh useful volume).

Table 3.1 Natural gas storage facilities [Source: Departamentul pentru Energie 2014]

	Storage Capacity	Extraction Capacity	Injection Capacity
UM	TWh	GWh	GWh
Bălăceanca	0,53	4,25	5,41
Bilciurești	13,93	110,55	140,70
Cetatea de Baltă	2,13	17,01	21,65
Ghercești	1,59	12,76	16,23
Sărmășel	8,50	68,03	86,59
Urziceni	2,66	21,26	27,06
Târgu Mureș	3,19	21,26	21,26
Total	32,53	255,12	318,90

The last years' situation indicates a decreasing tendency for storing natural gases in Romania with a storage demand of 21 TWh out of the total capacity of 32.52 TWh. Generally, the availability of natural gas from the underground storage facilities decreases during the winter months, following a peak in demand during this period.

Romania's natural gas storage capacities are used on a seasonal basis and have a reduced flexibility concerning injection/extraction cycles and the daily extraction capacity. Priorities in this domain focus on increasing the level of operational flexibility and extraction capacity, as well as on creating new storage facilities in order to increase the level of security in natural gas supply.

3.3 ENERGY MARKETS

3.3.1 Electricity Market

Starting with the year 2000, the Romanian electricity market began the process of gradually becoming a competitive market, but at the end of 2013, 43% of the final energy consumption is still on the regulated market. According to [ANRE 2015], the regulated electricity market is going to be completely eliminated by the end of 2017. ANRE issued accreditations to the following players on the electricity market:

- Electric energy producers
- Transmission and system operators
- Distribution operators
- Suppliers

The regulated electricity market addresses captive consumers, which are generally home users or users that have not been granted eligibility of changing the electric energy supplier. Electric energy producers, as well as captive consumer suppliers take part in the regulated electricity market as well. On this market, it is ANRE who imposes the regulated energy quantity that is traded between the participants, as well as the regulated electric energy prices for each producer. Currently, the energy mix that is sold on the regulated electricity market is allocated based on the production cost, targeting a minimum impact on the population.

The wholesale electricity market is composed of the following:

- Regulated contracts between producers and suppliers
- Centralized Market for Bilateral Contracts (CMBC) – CMBC Auction (awarded by public auction) and CMBC Forward (continuous negotiation)

- Contracts on the electricity market for large final clients – only clients that have an annual consumption of more than 70,000 MWh can be part of this market. The energy delivery period on this market ranges between one and five years.
- The Day-Ahead Market (DAM) – implemented in June 2005, it allows the players to trade standard products with delivery on the day after the transaction day, offering a secure mechanism for establishing portfolios one day ahead of the delivery day as well as a reference price for the wholesale market that is established in a transparent manner. Any license holder (producer, supplier, network operators) can be part of this market, with OPCOM being the counterpart for every transaction. Every licensed party has to sign an agreement with the TSO in order to assume the balance responsibility or prove that it has been transferred to a tertiary party. The Day-Ahead Market (DAM) is essential for facilitating a competitive, transparent and indiscriminative wholesale electricity market, reducing the trading prices for electricity and establishing a reference electricity price for the other trading markets. [OPCOM n.d.]
- The Intraday Market (IM) – launched in 2011, it represents the part of the wholesale electricity market where trading is made for each interval of the corresponding day, starting with the day before delivery day, after the trading on the Day-Ahead Market has ended and until a specific time step before the delivery hour. It functions as an additional tool for adjusting contracting portfolio and achieving balance between bilateral contracts, load forecast and technical availability of the energy production units on a hourly basis, close to the moment of delivery. [OPCOM n.d.]
- The Balancing Market (BM) – mandatory for all the participants and it aims to bring balance to the deviations between the planned energy production and energy consumption values. Each participant has to allocate a production capacity and a dispatchable load in order to ensure the primary reserve obligations. The Balancing Market has the role of establishing in real-time the balance between the electric energy production and consumption, as well as realizing the commercial management of the national energy system grid restrictions.

In 2012, the authorities introduced the obligation of running all the transactions on the wholesale electricity market in a transparent, public, decentralized and indiscriminative manner, thus the transactions have to take place on the centralized markets administrated by OPCOM (Romanian Gas and Electricity Market Operator). [Romanian Parliament n.d.]

In 2013, the total volume of electric energy traded on the centralized markets administrated by OPCOM was approximately 93.5 TWh, with a share of 188.3% reported to the internal electric energy consumption of Romania. This situation is caused by the multiple buying and selling transactions between the electricity traders present on the market. The numbers indicate that currently OPCOM is among the top ten market operators at European level in terms of market liquidity.

Table 3.2 Evolution of the average annual prices on the Romanian energy markets [Source: Departamentul pentru Energie 2014]

Tranzacții pe piața angro	2006	2007	2008	2009	2010	2011	2012	2013
UM	RON/MWh							
Piața contractelor bilaterale	127	142	148	161	162	174	190	185
Contracte reglementate	154	157	158	164	166	164	152	171
Contracte pe platforme de brokeraj	-	-	-	-	-	-	213	223
Contracte negociate	108	126	146	159	159	178	204	186
Export		141	191	170	171	193	223	180
Piețe centralizate de contracte	128	167	177	193	157	172	215	204
Piața pentru ziua următoare	161	162	189	145	153	221	217	156
Piața intrazilnică	-	-	-	-	-	282	298	194
Piața de echilibrare								
Preț mediu de deficit	249	223	278	243	237	283	292	243
Preț mediu de excedent	53	65	67	74	40	58	49	40

Integrating the Romanian electricity market in the European market represents one of the major national objectives imposed by the strategic European objectives imposed by the European Council in February 2011 and restated in the following reunions. Currently, Romania is implementing a project for coupling the Day-Ahead Market with the markets from Czech Republic, Slovakia and Hungary on the basis of the Price Coupling of Regions solution.

3.3.2 Natural Gas Market

From a legislative point of view, the natural gas market from Romania was liberalized since 2007, every consumer being able to choose the natural gas supplier. In practice, supplying natural gas to the final consumers on a regulated manner continued after the official liberalization and currently this continues to hold a share of 45.8% of the annual natural gas consumption. The total number of consumers that are eligible for the competitive market is 3,128 with a very low growth rate, the main actors being industrial and electric energy

production companies that have left the regulated market looking for opportunities of obtaining a lower natural gas price with the help of their significant negotiation influence.

The Romanian natural gas market has two components:

- Competitive market:
 - Bilateral contracts that are directly negotiated between economic operators – currently both the retail and the wholesale markets are functioning almost exclusively based on bilateral contracts at negotiated prices. Depending on the type of consumer to which the natural gas is addressed, suppliers are allocated certain quantities for which they have the possibility of signing purchase contracts with natural gas producers for bilaterally negotiated prices.
 - Transactions of centralized markets – although there are currently two natural gas trading platforms available, due to the fact that the wholesale market is a closed market in Romania, the interest surrounding them is low.
 - Import contracts – the remaining purchasing portfolio is covered by import contracts.
- Regulated market:
 - Supplying natural gas to final consumers – allocating natural gas from the internal production at regulated prices to the suppliers of the final consumers on the regulated market, as well as final consumers that benefit from framework contracts approved by ANRE.
 - Monopoly activities – natural gas transport, distribution and storage activities.

The current structure of the Romanian natural gas market has the following components:

- One natural gas transport system operator – Transgaz
- 6 producers: Petrom, Romgaz, Amromco, Toreador, Wintershell Medias, Aurelian Oil&Gas
- 3 natural gas underground storage operators: Romgaz, Amgaz, Depomures
- 34 natural gas distributors and suppliers to captive consumers – two large companies: Distrigaz Sud and E.ON Gaz Romania
- 76 suppliers on the wholesale market

In Romania providing home consumers with natural gas from the internal production is a priority, due to the fact that the price of this gas has been significantly lower compared to the average price of imported natural gas, as indicated by Figure 3.5.

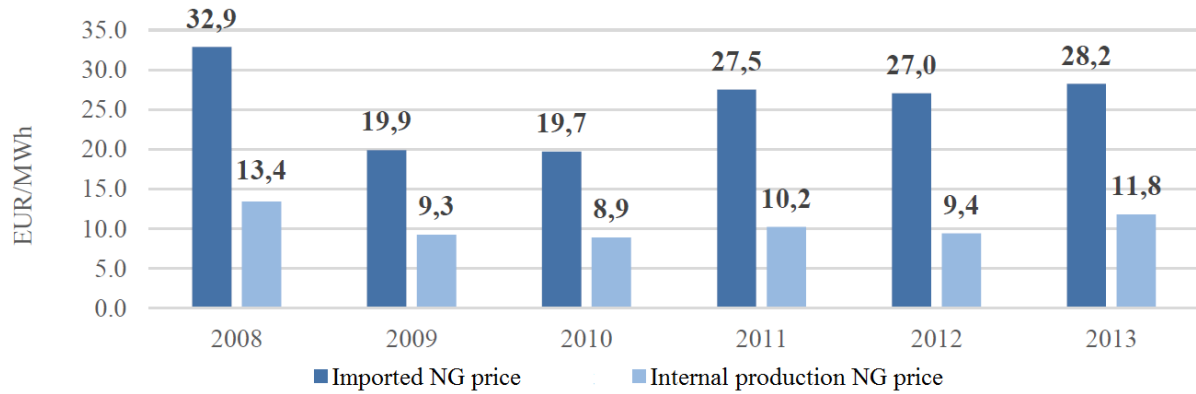

Figure 3.5 Internal vs Import natural gas price in Romania [Source: Departamentul pentru Energie 2014]

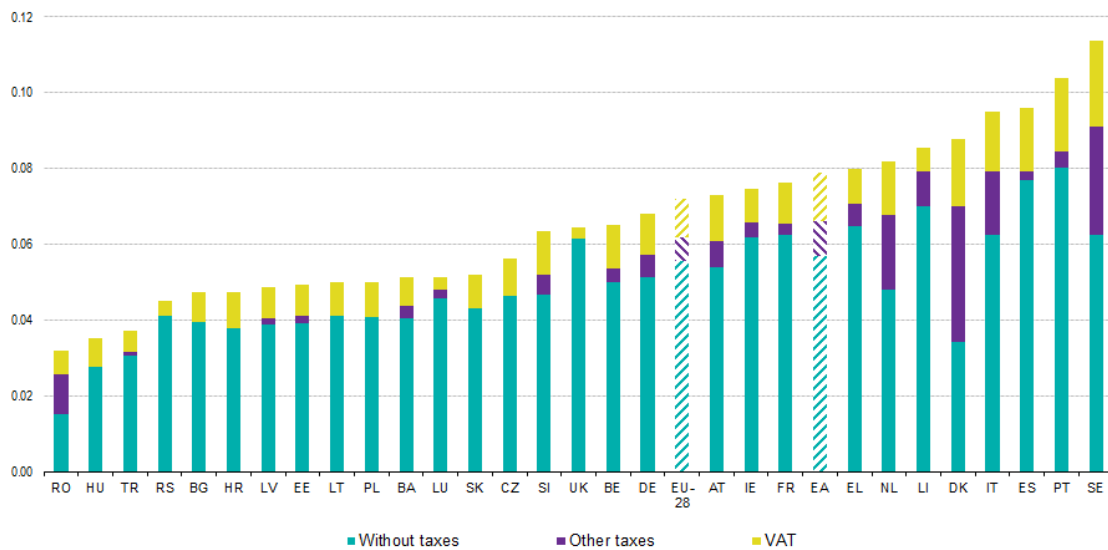

Figure 3.6 Natural gas prices for household consumers expressed in Euro/kWh [Source: Eurostat]



Figure 3.7 Natural gas prices for industrial consumers expressed in Euro/kWh [Source: Eurostat]

Answering the changes in the natural gas demand patterns, strengthening the security of supply of the natural gas system and adding flexibility to the market can be addressed by storing natural gas in the transport and distribution networks. This represents a technically and economically efficient instrument of offering clients a short response time that will increase the level of flexibility of the system, as well as lower the transport costs.

According to [Departamentul pentru Energie 2014] Secondary market mechanisms need to be developed in order to allow the market to work:

- the secondary capacity market.
- storing natural gas in the transport and distribution network.
- introduction of “natural gas certificates” and trading them on the market in order to allow rapid and legal trading.
- introduction of natural gas credit or virtual storage mechanisms.

3.4 ROMANIA AND THE ENERGY TRILEMMA

According to [World Energy Council 2014] there are three dimensions of the energy trilemma:

- Energy security – concerning the effective management of primary energy supply from domestic and external sources, the reliability of energy infrastructure and the ability of energy providers to meet current and future demand.

- Energy equity – concerning the accessibility and affordability of energy supply across the population.
- Environmental sustainability – concerning the achievement of supply and demand side energy efficiencies and the development of energy supply from renewable and other low-carbon sources.

TRILEMMA BALANCE

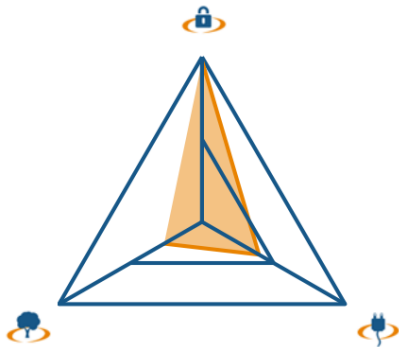

INDEX RANKINGS AND BALANCE SCORE







	2012	2013	2014	Trend	Score
Energy performance	46	53	55	↓	
 Energy security	4	9	4	→	A
 Energy equity	59	70	78	↓	C
 Environmental sustainability	92	88	95	→	C
Contextual performance	72	69	55	↑	
 Political strength	53	56	61	↓	
 Societal strength	65	65	56	↑	
 Economic strength	98	90	58	↑	
Overall rank and balance score	52	52	54	→	ACC

Figure 3.8 Romania's ratings in the World Energy Council's Trilemma Index 2014

[World Energy Council 2014] reveals that Romania is able to hold a stable position in the index concerning the Energy Trilemma in the last several years, although the three indicators are unbalanced.

Figure 3.8 reveals that Romania performs exceptionally well in terms of Energy Security, holding the 4th global position, helped by a solid energy production to consumption ratio and by the fact that it manages to ensure more than 80% of its energy demand with internal means, leading to reduced dependency on imports. On the other hand, in terms of Energy Equity the situation drastically changes and Romania holds the 78th position in the world. The negative evolution of 2014 compared with the previous year can be traced to the increase in the price of gasoline. The country's most negative performance comes from the Environmental Sustainability indicator, where Romania holds a relatively stable position throughout the last several years, being ranked 95th at global level, with carbon emission and emission intensity levels growing.

Regarding the contextual performance indicators, Romania is on an ascending trend in terms of Economic and Societal Strength due to an increased macroeconomic stability, but is faced with deterioration in Political Strength.

An overview on the situation of the Romanian energy system described in the current chapter points towards an interesting context for Power-to-Gas technologies due to the challenges presented, as well as the diversity of the technical means and market mechanisms that can support the deployment of such concept.

4 THE POWER-TO-GAS CONCEPT

Power-to-Gas represents an innovative concept that offers a new and intelligent way of managing energy generation and loads, allowing a significant quantity of fluctuating electricity produced by renewable energy sources to be accommodated in the energy system. Contrary to a public belief, the Power-to-Gas concept is not new, being developed by certain research and development institutes from Europe starting with the early years of the 90s, as presented by [Gahleitner 2013]. However, in the last few years, Power-to-Gas has made a return to the spotlights of the scientific community and potentially interested industrial investors, due to the fact that the expansion of renewable energy on certain markets has caused important changes and potential unbalance in the respective energy systems, as presented in the previous chapter.

As a larger percentage of the energy mix is taken over by renewable energy sources, more periods in which production exceeds consumption occur, posing significant flexibility issues to conventional energy generation and storage capabilities. One potential solution for solving this situation rests in converting and storing the surplus energy into another energy vector. In the case of Power-to-Gas, surplus electricity is converted into chemical energy in the electrolysis process by producing hydrogen. From this moment on, depending on the application, hydrogen can be used in multiple ways:

- As hydrogen, in industrial applications or for fueling fuel cell vehicles
- For re-electrification, using fuel cells
- Injected in the natural gas grid, taking into account concentration limitations
- For producing SNG (Substitute Natural Gas) in the methanation reaction

The two latter possibilities constitute the main pathways of the Power-to-Gas concept, as treated by the Thesis. Therefore, if we consider the two, we can state that Power-to-Gas basically creates a link between the electricity and the natural gas grid, thus extending the

storage capacity of the energy system and increasing its level of flexibility. [Stern 2009] presents the working principle of the Power-to-Gas concept in the following figure:

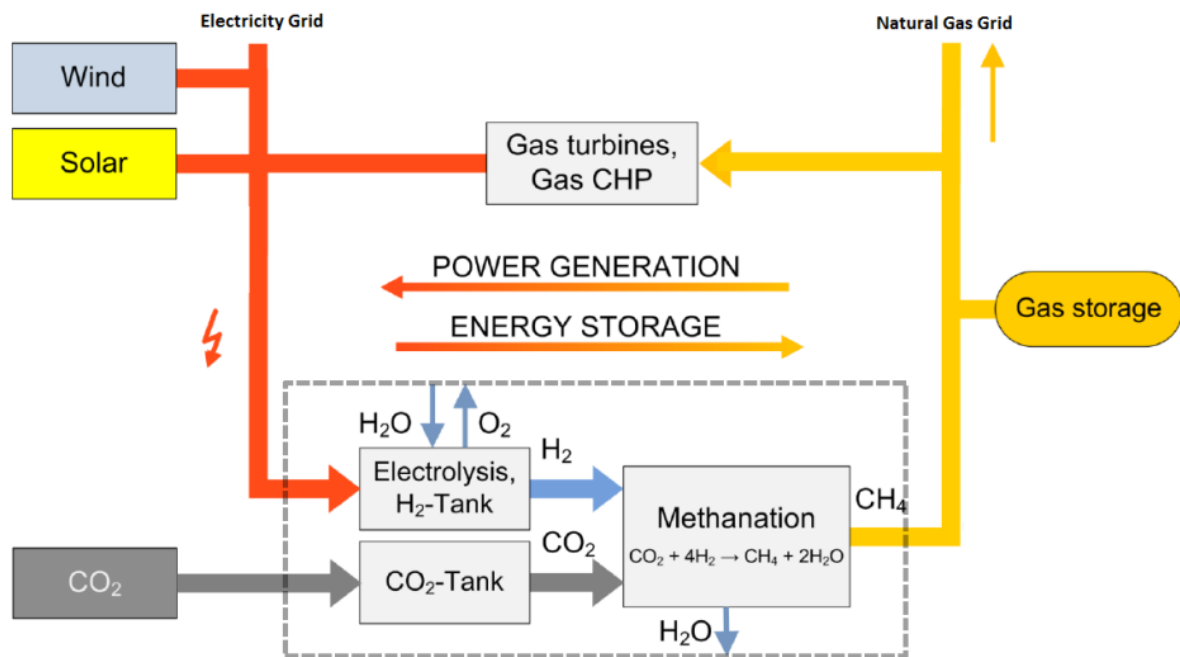

Figure 4.1 The Power-to-Gas concept (source: [Stern 2009])

4.1 FUNCTIONS OF THE POWER-TO-GAS CONCEPT

Power-to-Gas was developed as an answer to the question related to using surplus energy in an energy scenario with a high percentage of renewable energy. However, the concept expands behind this idea and brings several functions to the energy system:

- a. Energy storage

Power-to-Gas offers a solution for storing the otherwise unused surplus electric energy generated by renewable energy sources outside the electricity network, using hydrogen as an intermediate energy carrier. Basically, Power-to-Gas expands the storage capacity of the electricity grid, by granting access to the significant storage capacity of the natural gas grid. As presented by [ADEME 2014], in the particular case of France, the storage capacity of the natural gas grid is approximately 300 times larger than the storage capacity of the electricity grid. In addition, the natural gas infrastructure grants the possibility of seasonal storage, while the storage capabilities of the electricity grid are generally limited to several hours.

Although prediction methods and algorithms for estimating power generated using wind energy have become better and better lately, the output of large wind turbine farms is not consistent with the energy demand and this leads to an unbalanced grid, with significant economic consequences. Traditional methods for storing and reconverting the surplus energy (batteries, compressed air energy storage or hydro pumping) have been used, but the main issue is that, technologically, their storage capacity cannot scale up in order to be helpful for an energy system that relies on a high percentage of renewable energy, or the lack of geographically suitable locations (in the case of PHES). In addition to this, other issues can also be identified, mainly related to the response time of such technologies or the environmental impact they would cause. In terms of energy storage, Power-to-Gas is a very flexible concept in terms of various ways of operating it, being able to offer a short-term energy buffer for grid balancing services and seasonal storage (using the existing storage capacities of the natural gas transport and distribution network), that besides a very important economic advantage, can also bring strategic value, improving indicators such as security in energy supply and energy independency.

b. Energy transport

Unlike some of the more traditional power generation solutions, the positions of renewable energy plants are strongly dependent on meteorological and geographic factors and this often leads to situations when they are concentrated in certain regions of a country. But since the demand for power does not necessarily come from that region, the energy must be transported from the generation site to the point where it is going to be used. In the case of a well-sized electricity transport and distribution grid, this would not raise any issues, but an aggressive growth rate of renewable energy is expected to lead to a situation in which the transport capabilities of the electric grid will be exceeded, or saturated.

Power-to-Gas provides a solution for the taking out the energy from a certain region without the oversaturation of the electricity grid, by using the existent natural gas transport and distribution network, which in the specific cases of certain energy markets, is ready to accept and deliver the energy to the end point of the chain. Using Power-to-Gas for its transport function will help avoid investments in constructing new power lines. In addition, social acceptance also has to be taken into consideration, given the reluctance related to having a high density of power lines in certain areas. Nonetheless, as presented by [ADEME 2014],

transporting gas is approximately 20 times cheaper than transporting electricity on a Euro per kW per 100 km comparison basis.

c. System services

With the whole concept being centered around electrolysis units, Power-to-Gas can play a significant role on the balancing market helped by the large level of flexibility of this specific technology. Electrolysers can increase or decrease their load depending on the requirements of the TSO in a matter of minutes, or even seconds, in order to help maintain the required equilibrium between the electricity demand and production.

d. Energy conversion

Converting electric energy into hydrogen or Substitute Natural Gas (SNG) represents one of the key features of the Power-to-Gas concept, its importance standing in connecting the electricity market with the natural gas market, and possibly markets for thermal energy or fuel for mobility (vehicles using CNG or hydrogen as fuel). The interconnectivity of these energy markets can potentially add a new dynamic to the energy system, increasing its level of flexibility.

e. Environmental function

By offering the possibility of reusing carbon dioxide for at least one additional energy cycle, Power-to-Gas can potentially play a significant environmental role in the future energy system. A large-scale deployment of Power-to-Gas SNG pathway would lead to important macro-economic changes due to the multiple possible synergies and, additionally, it can represent one of the drivers and in the same time beneficiaries of the carbon emission trading system.

4.2 POWER-TO-GAS PATHWAYS

As [Sterner 2009], [Michael Specht 2009] and [Jentsch et al. 2014] present, Power-to-Gas represents a scalable complex technical solution that offers invaluable storage capacity and adds an important degree of flexibility to an energy system. Depending on the location of the project and the particularities of the energy system and the industrial context from the specific deployment region, Power-to-Gas offers two different technological pathways:

4.2.1 Power-to-Gas Hydrogen

Represents the less complex solution that, in terms of current technological availability, is ready to be deployed in real large scale applications at the moment [Gahleitner 2013]. In this pathway, renewable energy is transformed into hydrogen in the electrolysis process and then injected into the natural gas network, taking advantage of its storage capacity and transport capabilities, as indicated by Figure 4.2. However, it must be emphasized that there is a certain limit for the volume of hydrogen that can be injected in the natural gas network without massive changes in infrastructure and the functionality of end of the chain applications. Further considerations related to this aspect will be presented later in the Thesis, in a dedicated subchapter.



Figure 4.2 Schematic representation of the Power-to-Gas Hydrogen pathway

The advantages of leveraging the Power-to-Gas Hydrogen pathway rest in the reduced complexity of the technical approach, at least in comparison with the Methanation pathway. Basically, the electrolysis units (which at the moment can be considered commercially mature, at least when it comes to alkaline electrolysers) are coupled to the renewable energy sources upstream, while downstream an injection station along with the necessary connection are needed to allow hydrogen to be injected in the natural gas grid.

According to [Lehner et al. 2014], the efficiency of the Power-to-Gas Hydrogen pathway is situated between 54 and 72% if high pressure (200 bar) compression is used, 57 and 73% if medium pressure (80 bar) compression is taken into account, or between 64 and 77% if there is no hydrogen compression stage.

4.2.2 Power-to-Gas SNG

The complete technological pathway of the concept brings CO₂ in to the equation, with the aim of offering and even better storage capacity and flexibility, while in the same time

emphasizing the environmental advantages of Power-to-Gas, by trapping CO₂ emissions for at least one cycle inside the technological loop. This pathway represents a solution for the locations where there is not only a large concentration of renewable energy production facilities, but also important CO₂ emitters, such as power plants, steel and cement industry or petrol refineries.

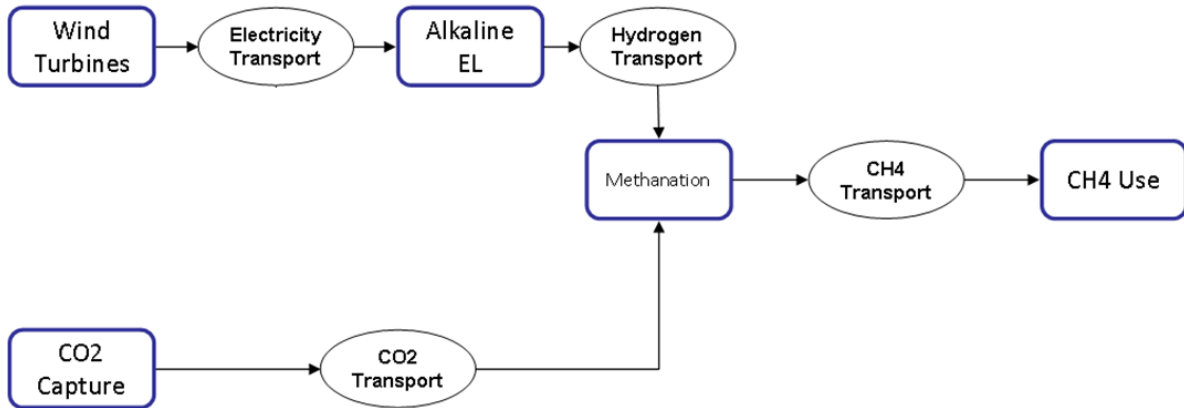

Figure 4.3 Schematic representation of the Power-to-Gas SNG pathway

Compared to the Power-to-Gas Hydrogen pathway, the SNG pathway adds two more complex technological processes (CO₂ capture and methanation), while giving up on the hydrogen injection part, the CO₂ capture process will ensure the necessary high concentration CO₂ gas that will be combined with the hydrogen delivered by the electrolysis process, in the methanation step, as presented by Figure 4.3. The result of this more complex pathway, is SNG (Substitute Natural Gas), which is fully compatible with the natural gas network, without any concerns related to concentration issues, granting full access to the huge storage capacity of the natural gas infrastructure. An additional advantage consists in the fact that SNG can be stored and transported by the natural gas network without any modifications to the infrastructure or to the final user applications.

An important observation consists in the fact that Power-to-Gas SNG can be deployed as a second phase, an evolution, of Power-to-Gas Hydrogen, since one of the central elements remains the electrolysis unit and also at the moment the CO₂ capture process, which is essential to the pathway, is raising specific issues related to economic efficiency aspects.

Concerning efficiency, [Lehner et al. 2014] states that the overall yield of the Power-to-Gas SNG pathway is comprised between 49 and 64% when including high pressure compression (200 bar), between 50 and 64% for medium pressure compression (80 bar) and between 51 and 65% when no compression is used. The overall efficiency drops when compared to Power-to-Gas Hydrogen, mainly due to the additional conversion losses that occur in the methanation stage.

In both Power-to-Gas pathways, hydrogen and SNG, respectively, while being the primary outputs, they are not the only products that can be valued. A significant byproduct of the water electrolysis process is high purity oxygen, which can be valued mainly in industrial and medical applications. In addition to oxygen, electrolysis also produces heat, but at the moment (when considering alkaline and PEM units) it is difficult to value due to the low operating temperature. However, heat integration can be a potential subject of discussion when taking into consideration SOEC units. The methanation process also produces residual heat which can be valued as a byproduct of the Power-to-Gas pathways. The economic value of the byproducts of the Power-to-Gas applications will be further presented, analyzed and discussed in the chapters dealing with the technical and economic evaluation of the technology.

4.3 INTEGRATING HYDROGEN IN THE NATURAL GAS INFRASTRUCTURE

One of the main barriers to moving towards a hydrogen economy is developing a reliable and cost-effective hydrogen delivery system. Compared with trucks and trains, pipeline transportation and distribution systems are considered a safe, environmentally friendly and cost effective way to transport hydrogen from its production location to its end users. However, the cost of building a new widespread infrastructure for hydrogen delivery is huge and it may take decades to complete.

A cost effective transitional hydrogen delivery system would consist in using the existing natural gas infrastructure, which offers several very important advantages:

- widely spread and interconnected
- high transport and storage capacity
- well-developed maintenance and control structure
- well established safety procedures

- well established grid management and operation strategies
- broad public acceptance

The two Power-to-Gas pathways taken into consideration inside the Thesis and presented in the previous section are treated differently when it comes to the aspects related to the integration with the natural gas infrastructure. While Power-to-Gas SNG does not pose significant issues related to injecting SNG in the natural gas grid because it has an almost identical chemical composition with methane (after being treated at the end of the methanation stage), this being one of the main advantages of deploying this specific pathway, Power-to-Gas Hydrogen has to be treated differently.

In the Power-to-Gas Hydrogen pathway, hydrogen is injected directly into the natural gas distribution or transport grid. Since the physical and chemical properties of hydrogen are quite different from natural gas, the existing natural gas infrastructure is not suitable for delivery of pure hydrogen without significant modifications. However, the current natural gas system may be used for co-transporting hydrogen mixed with natural gas (with specific limitations concerning the concentration of the mixture) with no or minor modifications of the pipeline design, operation, and maintenance. This hydrogen/natural gas mixture could then be used in end user's systems, given appropriate modifications of the appliances, or could be used as pure hydrogen by developing devices to extract hydrogen selectively from the mixture.

According to [National Grid and Atlantic Hydrogen Inc. for Gas Industry Executives 2009], "the use of hydrogen enriched natural gas (HENG) enhances combustion and reduces CO₂ emissions from natural gas. It also leads to lower emissions of pollutants such as nitrogen oxide (NO_x), carbon monoxide (CO) and unburned methane and other hydrocarbons. HENG can also improve the fuel efficiency of gas-fired combustion in boilers, engines and turbines, using existing natural gas delivery infrastructure and end-use equipment:

- HENG decreases the carbon intensity of natural gas. For every ton of carbon removed before combustion, approximately 3.7 tons of CO₂ are prevented when HENG is burned.
- HENG increases the efficiency of natural gas conversion into useful energy. Adding small amounts of hydrogen leads to more complete combustion of the fuel, including CO, methane and other hydrocarbons, improving efficiency and lowering emissions of pollutants.

- HENG helps avoid the formation of thermal NO_x, because it allows stable combustion at leaner gas mixtures in order to achieve a lower flame temperatures compared to what is obtained when using conventional natural gas.”
- enables the initial deployment of hydrogen in the energy system without the need for expensive infrastructure investments. This resolves the classic “chicken and egg” problem of hydrogen production and the dedicated storage, transmission and other equipment needed to use it directly as a fuel.

[Tabkhi et al. 2008] claim that hydrogen and methane are two gases that are significantly different, in terms of both physical and chemical properties, meaning that mixing a certain fraction of hydrogen in methane will lead to changes in the behavior of the new SNG, modifying calorific and transport properties, as well as having an impact on safety and reliability issues. Because the volumetric energy density of hydrogen (3.54 kWh/Nm³ HHV) is approximately 3 times lower than the one of natural gas (about 12.8 kWh/Nm³ HHV), the transport and storage capacity must be increased in order to maintain the same level of demand in terms of energy.

The cited study presents the most important impacts mixing hydrogen in the natural gas infrastructure might have:

- Performance of end-user appliances – due to changes in the combustion properties created by the addition of hydrogen.
- Gas quality – the specifications of the SNG delivered to end-users will have to comply with contractual clauses in order to ensure safety and performance, as well as billing accuracy.
- Safety aspects – transport and distribution risks are elevated due to the higher leakage rate of hydrogen compared to methane.
- Pipeline integrity – hydrogen has a negative effect on the mechanical properties of the materials of which pipelines are made of, the effect known as hydrogen embrittlement of steel being the main target of concern.

Taking in to consideration all these aspects, the upper concentration of hydrogen in methane for which major changes in the natural gas infrastructure, end-user appliances and billing aspects are not required, has to be established. In order to evaluate the effects of a certain mixture of hydrogen in methane, it is important to have a look at the Wobbe Index, which is

an indicator of interchangeability of fuel gases and used to compare the combustion energy output of different composition fuel gases in an appliance.

$$W_s = \frac{H_s}{\sqrt{d}}$$

Where:

W_s – Wobbe index

H_s – higher heating value MJ/Nm³

d – relative density compared to air

[Haeseldonckx & Dhaeseleer 2007] present the fact that the Wobbe index has to be situated between 48 and 58 MJ/Nm³ for most common burners that are using rich natural gas and between 41 and 47 MJ/Nm³ for the ones using lean natural gas:

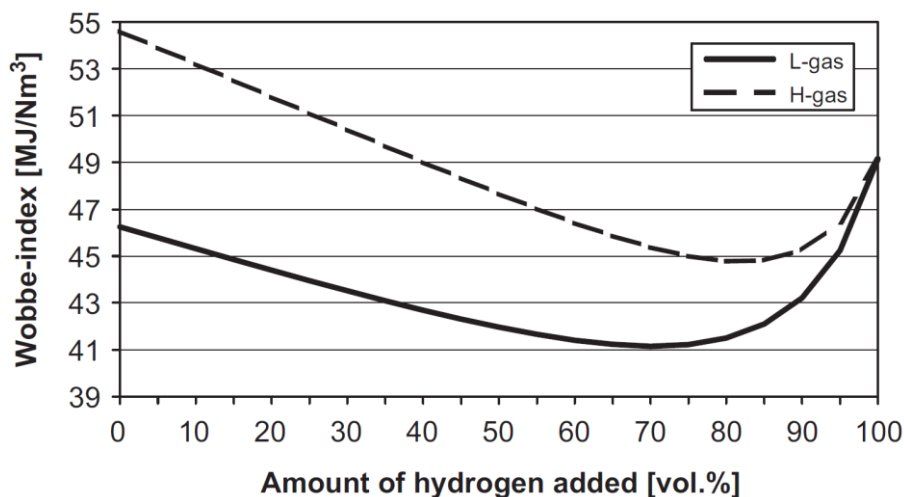

Figure 4.4 Evolution of Wobbe index depending on the concentration of hydrogen

From Figure 4.4, presenting the evolution of the Wobbe index depending on the concentration of hydrogen in the natural gas, we can observe that for lean natural gas burners, up to 98% of hydrogen can be added, while for rich natural gas, the figure goes down to 45%. The worst performances appear when 65-75% of hydrogen is injected. The Wobbe index remains within the admissible range when the hydrogen concentration does not exceed 17% and this is, at least for the moment, the benchmark figure concerning the maximum concentration of hydrogen in natural gas that does not create a negative impact on the burners.

[Melaina et al. 2013] states that although technically the hydrogen injection process itself does not pose significant challenges, there is a strong debate related to the overall feasibility of injecting hydrogen in the natural gas network. The main question is: what is the maximum amount of hydrogen that can be injected in the natural gas network without causing potentially harmful effects on the infrastructure and equipment from this chain?

[Lehner et al. 2014] presents data suggesting that a maximum recommended concentration of hydrogen in the natural gas infrastructure would be around 2% at the moment. On the other hand, [Polman n.d.] investigated the influence of hydrogen injection over the transport capacity of the natural gas infrastructure, which is determined by the pressure loss per transported amount of energy. This is calculated taking in to consideration the density, viscosity and the calorific value, parameters strongly influenced when hydrogen is added. One of the conclusions of the study was that due to lower compressibility of hydrogen compared to methane, the capacity of the transmission infrastructure decreases faster once the pressure is higher. The authors of the study have envisioned a three-stage scenario of hydrogen injection in the natural gas infrastructure:

- First stage – 3% with almost no modifications needed
- 12% - the quality of the mixture will comply with the standards, but certain adaptations will be required
- 25% - technically feasible, but with major adaptations

[ADEME 2014] reports that in the case of France, the hydrogen concentration limit is situated at 6% and quotes ITM Power on the following graph with the situation in the most important European countries:

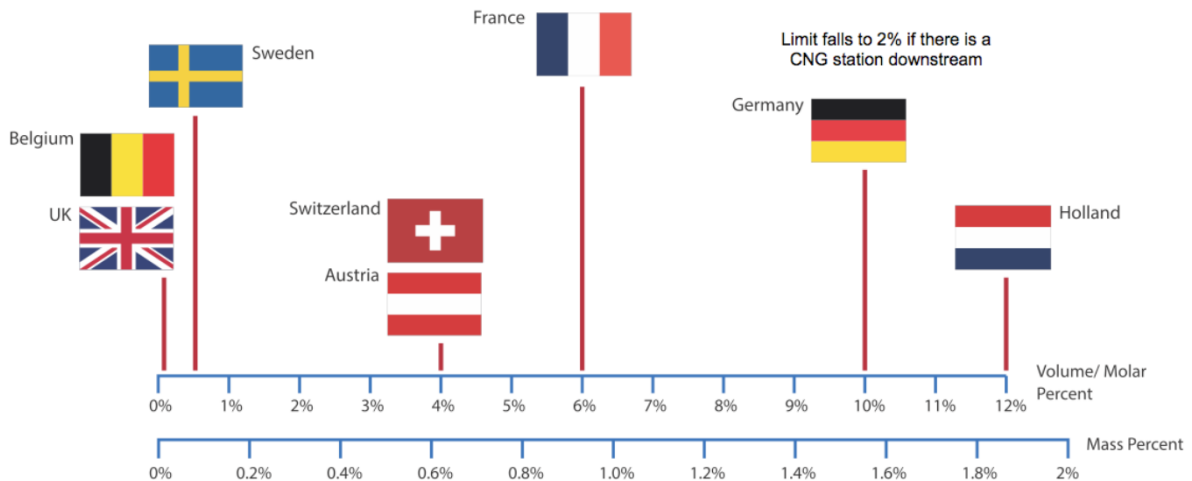

Figure 4.5 Concentration of hydrogen in natural gas limits in European countries (Source: [ADEME 2014], ITM Power)

Another aspect that must be taken into consideration when deciding on the maximum quantity of hydrogen that can be injected is the natural gas flow through the transport or distribution grid. The point of injection has to be carefully chosen so that the natural gas flow is big enough to ensure that the concentration of hydrogen is kept under the imposed limits.

4.4 POLICY AND SUPPORT MECHANISMS

Power-to-Gas is a technology that potentially brings together the electricity and natural gas grids and markets, two sectors that are heavily standardized and regulated. In addition to this, the technical concept also integrates renewable energy and, in certain pathways, carbon dioxide capture, technologies that are or will be, as well, backed by a powerful set of policy and support measures. All these, along with the fact that Power-to-Gas involves significant costs, open the discussion toward the legal framework in which this technology will have to be deployed.

At the moment, legal framework dedicated especially to Power-to-Gas is virtually non-existent at European level, with the exception of Germany. There are certain regulations in specific countries regarding punctual aspects like the gas quality and concentration requirements for hydrogen or synthetic natural gas (discussed in the previous section), as well as regulations regarding price premiums for biogas, which in certain countries covers SNG produced from Power-to-Gas (France), and in others doesn't (Romania), leading to a need for unitary legislation concerning what is considered biogas and what not (standardization). According to

[Lehner et al. 2014], Germany is an example to follow in aspects that concern the definition of biogas, this category covering hydrogen produced by water electrolysis, as well as SNG produced using power that has at least an 80% contribution from renewable energy sources.

The potential legal framework can address several primary directions in order to encourage the development and large scale deployment of Power-to-Gas technologies [SBC Energy Institute 2014]:

- Regulatory framework for hydrogen injection in the natural gas grid and updated safety protocols regarding large scale use of hydrogen.
- Easing the way of energy storage applications to the ancillary services market, mainly by lowering the minimum installed capacity required for a participant, which is also one of the key aspects identified by the [Agora 2014] study.
- Social acceptance and education in order to promote hydrogen-based technologies to gain momentum.

As identified by the same study, there are four primary economically-oriented support mechanisms that can be taken into consideration for easing the way of Power-to-Gas:

- Feed-in tariffs/price premiums for renewable hydrogen or SNG – similarly to the feed-in tariffs applied to the renewable energy sector, this type of pull-measure is already used for SNG in France where 45 to 125 Euro/MWh of SNG are paid.
- Reducing connection and grid fees – for avoiding situations in which Power-to-Gas operators would have to pay twice, once for the energy they receive upstream and second for the hydrogen/SNG injected downstream.
- Tax exemption for renewable hydrogen or SNG.
- Imposing quotas for renewable hydrogen/SNG share in the energy mix or for the mobility sector.

The way carbon capture is going to be treated in the following period at European level is also a factor that can potentially determine the evolution of Power-to-Gas technology, especially when talking about the SNG pathway. Enforcing carbon reduction in certain industries (such as the cement industry or coal/natural gas power plants) will require significant investments in carbon capture technologies which will lead to a rise in the price of CO₂, adding a third market to the Power-to-Gas equation.

5 COMPONENTS OF THE POWER-TO-GAS CONCEPT

5.1 RENEWABLE ENERGY

The working principle of the Power-to-Gas concept consists in storing surplus energy coming from fluctuating renewable energy sources (generally wind turbines and photovoltaic panels) that does not match the demand in the energy system and using it later. However, due to the fact that storing important quantities of electric energy (multi MWh storage) under the form of electricity has limited options, an additional energy vector must be taken in to consideration (in the case of Power-to-Gas, the vector is hydrogen or SNG). Even if Power-to-Gas can use energy coming from conventional generation units, due to the efficiency losses associated with the conversion processes and the fact that these are generally dispatchable, have a higher environmental burden and also a higher degree of predictability, using renewable energy as the input energy source makes more sense.

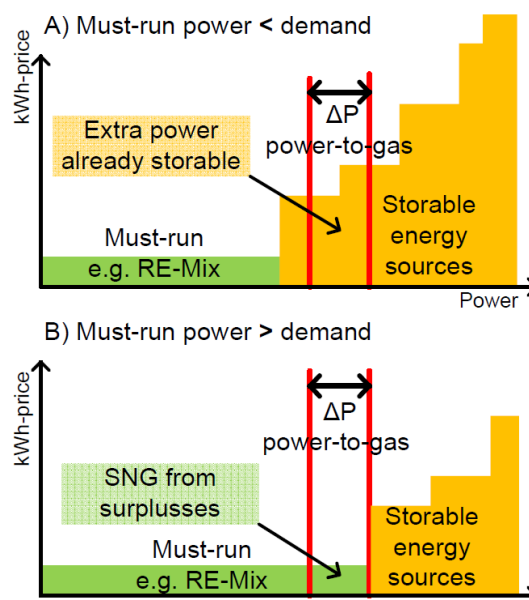

Figure 5.1 Merit order curves in the context of deploying Power-to-Gas [Source: Jentsch et al. 2011]

According to [Jentsch et al. 2011], there are two different scenarios that have to be analyzed when it comes to using surplus energy from renewable energy sources in a large scale Power-to-Gas project, as it can be observed in Figure 5.1:

- a. The must-run power exceeds the energy demand – in case the energy generated by the renewable sources exceeds the energy demand or the transport capabilities of the local or regional grid, this energy must be curtailed, or another energy demand must be found. Therefore, the renewable energy coming from green sources can be lost if no local demand for energy is found. In addition to this, curtailing wind and solar energy does not help save fuel costs or emissions compared to dispatchable and storable power generation from fossil fuel power plants. Therefore, curtailing renewable power brings no financial advantages and can be considered “must-run”, term that can also be used for defining non dispatchable fossil feed-in power or power plants that provide critical services for balancing the energy system. Essentially, the best-case scenario implies avoiding renewable energy curtailment and turning attention towards increasing the energy demand. Power-to-Gas or similar storage facilities in charging mode have the potential of creating this additional extra demand which will be able to offer the necessary energy storage function and contribute to the supply security of the whole energy system. Judging by this point of view, converting surplus renewable energy in to renewable methane becomes a reasonable and attractive solution. At this moment, surplus renewable energy generation takes place for a couple of specific hours, meaning that the full load hours for a Power-to-Gas unit would be uneconomically low. However, the expected fast expansion of wind energy, in the conditions of a slow development of the electricity grid, will lead towards an increase of these full load hours in the medium future.

- b. The must-run power is lower than the energy demand – in spite of the fact that the concept of energy storage focuses on supplying the power-to-gas project with surplus energy, there are certain economic aspects that might prove the efficiency of converting the necessary energy during non-surplus periods. In a situation like this, the extra demand for the Power-to-Gas plant will lead to an additional overall energy demand in the system, one that will have to be covered by other power sources. This case is illustrated in the figure below, using a merit order curve for power plant dispatch in which generation units are sorted by the price per kWh at which they will

feed the energy they produce in the system (marginal costs). Because they have no benefits when not running, wind and photovoltaic power generation units usually operate at low marginal costs and this prioritizes them in the merit order curve. Next, the dispatchable and storable energy generation units (for example hydro plants) follow behind the must-run units. Because the produced renewable energy is quantitatively lower than the demand, the surplus power that will be used by the Power-to-Gas plant will have to come from a storable energy source (gas or coal power plant, hydro plant or nuclear plant), transforming a storable fuel in to another storable fuel even if this implies significant losses caused by the conversion process.

One of the most important aspects related to renewable energy generation in conjunction with a Power-to-Gas plant is carefully tracking the demand curve and “shaving” the right amount of surplus energy, in order to ensure the most efficient operation (technically and economically) both for the wind turbine or photovoltaic plant and for the electrolysis units.

Surplus energy is difficult to define in the particular case in which leveraging Power-to-Gas in conjunction with a specific renewable energy production facility (not in a holistic approach at energy system level). Due to the fact that renewable energy units can be considered must-run units (Romanian case), there is very little surplus associated to this energy production pathway. Instead, cheap or low-value energy is used for feeding the electrolysis units that are part of the Power-to-Gas facility.

5.2 ELECTROLYSIS

5.2.1 General description

While there are various methods of producing hydrogen (steam reforming, thermolysis etc.), one of them stands out due to its huge potential of being linked with renewable energy sources: electrolysis. Compared to steam reforming, obtaining hydrogen from electrolysis is a far more expensive process mainly because of the high quantities of energy required. However, if the electrolysis process is supplied with the surplus energy produced by renewable energy sources, it suddenly becomes a much more attractive technology that has a huge potential to evolve hand in hand with the transition towards a new energy economy.

Water electrolysis is widely regarded as a key component in the transition towards a modern energy system in which energy will cease being a scarce resource and hydrogen will become an alternative energy vector for energy storage, industrial applications or mobility. The electrolysis process is always taken into consideration when discussing about producing hydrogen from renewable energy that is expected to significantly increase its share in the energy mix over the next decades. It is the central component of the Power-to-Gas concept, making the transition between electric energy and chemical energy, or between the electricity grid and the natural gas grid in the context of the Thesis. In a future energy economy, converting electricity in to another energy vector (hydrogen or even synthetic fuels like methanol or methane) is seen as an inevitable step due to the fact that the particularities of a future energy system will require a different type of response that cannot be offered by electricity, as presented by [Ball & Wietschel 2009]. This, coupled with the expansion of renewable energy sources, has the potential of leading towards an accelerated development of all hydrogen related technologies in the near future, starting with the methods of obtaining hydrogen.

Basically, electrolysis is an electrochemical process in which water is decomposed (the Greek word “lysis”) into hydrogen and oxygen using electric energy as the main driver. The positive ions are directed towards the cathode (-), where there is a reduction process, while the negative ion towards the anode (+), where they lose their electrical charge in an oxidation process. Historically the electrolysis reaction has been known for more than two hundred years, becoming at the middle of the 19th century a relatively cheap method for hydrogen production. Michael Faraday is credited with discovering the basic physical law of electrolysis in 1834, as presented by [Lehner et al. 2014], the process becoming widely used on the industrial scale since then. Until the sixth decade of the 20th century, when the first Proton Exchange Membrane (PEM) electrolyzers were developed, Alkaline electrolysis was the solution of choice, with Solid Oxide Electrolyser Cells (SOEC) being introduced in the 70s.

The general equation governing water electrolysis is the following:

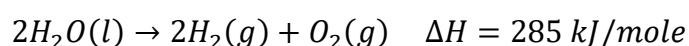

Where ΔH represents the total amount of energy that has to be supplied to the electrolysis process for splitting the water molecule. According to [Lehner et al. 2014], ΔH has two components, the Gibbs free energy (ΔG) which represents the amount of electric energy, and $T\Delta S$ which is the amount of heat, both required for driving the water splitting reaction.

$$\Delta H = \Delta G + T\Delta S$$

In order to activate the water splitting reaction, a minimum applied cell potential is calculated:

$$V_{rev} = \frac{\Delta G}{nF}$$

Where n is the number of transferred electrons, F represents the Faraday constant (96487 C/mol) and ΔG has a value of 237.22 kJ/mol, resulting in value for V_{rev} of 1.23 V in standard conditions (1 bar and 25 degrees Celsius).

The thermo-neutral voltage is calculated using the following equation, in the same conditions:

$$V_{th} = \frac{\Delta H}{nF} = 1.48 \text{ V}$$

Three situations are encountered regarding the voltage applied to the electrolysis cell (E_{cell})

- $V_{rev} < E_{cell} < V_{th}$ - heat is absorbed from the environment and the cell dissipates the heat generated by entropy change
- $E_{cell} = V_{th}$ - no heat is exchanged with the environment as the heat of the electrolysis cell is equal to the heat consumed in the endothermic reaction
- $E_{cell} > V_{th}$ - the electrolysis cell generates surplus heat, which can potentially bring system degradation and therefore it has to be removed by cooling the system [Lehner et al. 2014]

Pressure and temperature have a decisive influence on the water electrolysis process, increasing the pressure leading to an increase of the cell voltage, as well as a decrease in internal cell resistance [University of Denmark 2008], as shown by the Nernst equation [University of Denmark 2008]:

$$\Delta V = -\frac{RT}{nF} \ln \frac{1}{\sqrt{P}}$$

In terms of efficiency, the water electrolysis process is governed by the following formula:

$$\eta = \frac{\text{Energy output}}{\text{Energy input}} = \frac{\text{HHV of Hydrogen}}{\text{Electricity} + \text{Heat} + \text{Losses}}$$

5.2.2 Electrolysis technologies

At the moment, there are three main electrolysis technologies that can be taken into consideration in conjunction with energy storage:

- Alkaline electrolysis
- Proton Exchange Membrane (PEM) electrolysis
- Solid Oxide Electrolyser Cell (SOEC)

a. Alkaline electrolysis

Historically speaking, alkaline electrolyzers were the first ones developed for producing hydrogen using this process, starting with the 1920s. At first, this type of electrolyser was used in facilities that had the goal of maximizing the efficiency of hydro power plants in Scandinavia and are still used today at small, medium and large scale, being the most widespread type of electrolyzers on the market. At the moment, alkaline electrolyzers represent the most mature technology from this field, ready to be deployed at almost any scale (limited by the number of stacked electrolyzers) and currently setting the benchmark for all other electrolyser options, not necessarily in terms of performance or efficiency, but in terms of commercial availability and maturity.

Figure 5.2 presents the working principle of an alkaline electrolysis cell, as described by [Santos et al. 2013]:

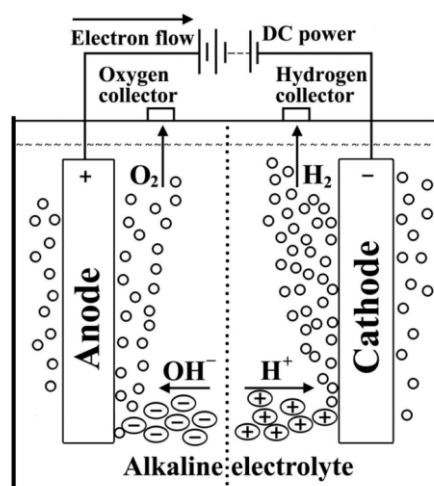
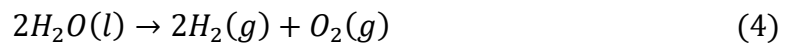
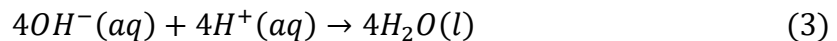
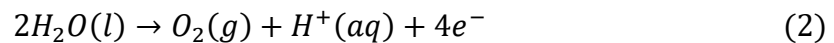
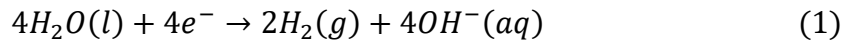

Figure 5.2 Working principle of an Alkaline electrolysis cell (Source: Santos et al. 2013)

According to [University of Denmark 2008] the working principle of alkaline electrolysis is rather uncomplicated, structurally containing anodes and cathodes isolated by a semi-permeable membrane (or separators), all the elements being flooded in electrolyte (KOH solution). Hydrogen is produced at the anode when direct current passes through the electrolysis cell and splits the water molecules, in the same time generating oxygen on the anode side. The role of the separators is to isolate the two gases while letting the electrolyte and the ions that are carrying the charge pass, so that they will not interfere again until they exit the cell.

The chemical reactions that take place inside an alkaline electrolysis cell are described in the following lines:



The basic components of an alkaline electrolysis cell are the electrodes, the electrolyte, the separator and the container or the enclosure of the cell. The electrodes must come with a very good electric conductivity and also a catalytic surface that allows ion discharging. Usually, the electrodes are made of nickel plated steel and covered in catalysts made from platinum or other precious metals in order to obtain the best efficiency, the tradeoff coming from the increase in costs. The layout of the electrodes varies significantly depending on the design of the cell, directly influencing the surface area. The electrolyte provides the necessary conductivity and is usually made of KOH solution (potassium hydroxide) with a concentration around 30%, as this represents the point of maximum conductivity. The key characteristics of the electrolyte are: high ionic conductivity, resistance to chemical decomposition caused by voltage, low volatility and a high resistance to pH changes. The separator has the role of isolating the two electrodes and therefore preventing hydrogen and oxygen from interacting with each other and letting ions pass. Usually it consists out of a porous matrix that allows the flow of electrolyte solution. The separator must allow a low ionic resistance of the cell; therefore, it is usually made of a very thin sheet of asbestos. The enclosure or the container is usually made from a steel tank plated with nickel and can come in various configurations, depending on the structure of the electrolysis stack.

According to [ADEME 2014], water purity is an important element in the alkaline electrolysis process, thus it has to be fed with demineralized water by a water treatment unit. On the output side, impurities coming from the KOH solution need to be filtered during a step in which hydrogen is extracted by separators, before being cleaned for oxygen and dried for any remaining traces of water, resulting in a purity situated between 99.5 and 99.9%.

Most alkaline electrolyzers are operating at atmospheric pressure, however in the last period, more and more models capable of outputting hydrogen at higher pressure (up to 30 bar) have made their way on the market. For Power-to-Gas projects in particular, an alkaline electrolyzer operating at a higher pressure than atmospheric brings a certain advantage since it reduces the additional effort required before injecting the product in the natural gas grid or storing it before being fed to the methanation unit. In terms of temperature, alkaline electrolyzers typically operate between 60 and 90 °C.

A general range of efficiencies for alkaline electrolyzers is comprised between 50 and 73 kWh_{el}/kgH₂, as indicated by [Bertuccioli et al. 2014]. The alkaline technology allows a startup time between 20 minutes and several hours and a ramp up time of up to 15-20% per second, according to the same source. Another flexibility indicator relates to the minimum partial load operation, which for alkaline electrolyzers is currently situated between 16 and 33%. Generally the lifetime of an alkaline electrolysis system is situated between 20 and 30 years, with a stack lifetime between 60,000 and 90,000 hours, with a general availability of more than 8500 hours per year, according to [Bertuccioli et al. 2014] and [ADEME 2014].

At the moment, alkaline electrolysis offers the highest level of technical maturity, translating into the availability of 3-4 MW units that are ready to be deployed in energy storage applications. Compared to the other electrolysis technologies, alkaline electrolysis systems also represent the most affordable option, coming at an investment cost between 700 and 1100 Euro/kW, a cost that includes the power supply, gas purification and control equipment, but leaves out the grid connection and the hydrogen compression and storage phase. The yearly operational costs are size-dependent, generally starting at 4-5% of the initial CAPEX per year for small scale electrolysis facilities and going down to less than 2% of the initial CAPEX for facilities that exceed an installed capacity of 10 MW.

Although alkaline electrolysis is a mature technology, the potential large scale interest surrounding energy storage can bring further development that is expected to lead mainly to severe cost reductions that will bring the CAPEX cost as low as 400 Euro/kW by 2030. In

addition, marginal improvements in efficiency are expected, as well as a higher level of flexibility given by faster ramp up and ramp down times.

b. PEM electrolysis

Proton Exchange Membrane (PEM) electrolyzers were first revealed in 1960s and until several years ago, they have been mostly reserved for small scale applications due their increased complexity and cost compared to alkaline electrolyzers. Lately, with large scale energy storage applications on the horizon, PEM electrolyzers have started to be developed with larger units in mind and multi-MW systems are expected to reach wide commercial availability in the next period. Compared to the more traditional alkaline electrolyzers, PEM models come with certain advantages: better energy efficiency, in some cases higher production rates, better safety, everything packed in a more compact design.

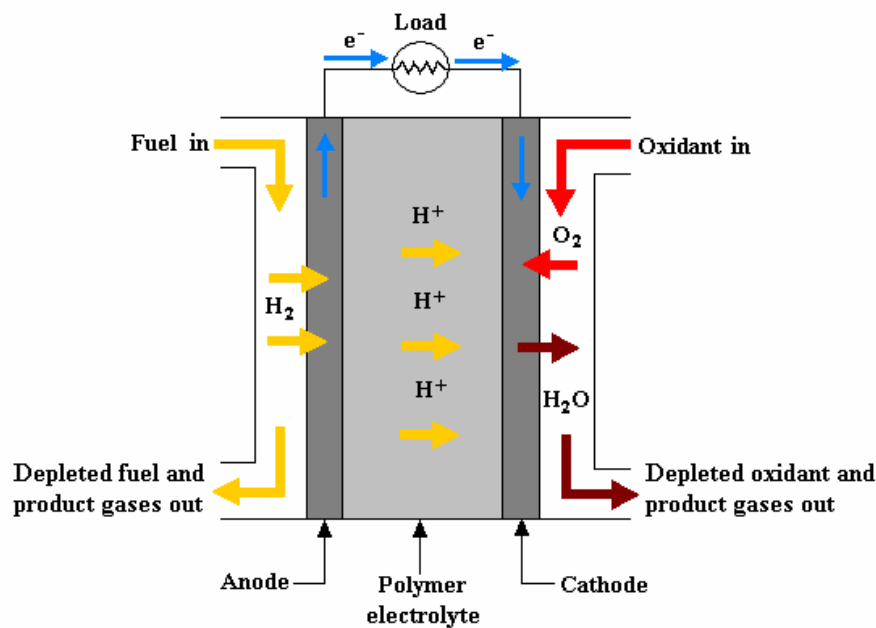
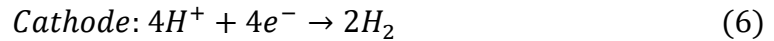
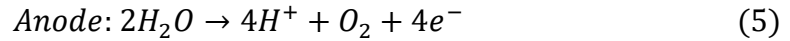

Figure 5.3 Working principle of a PEM electrolyzer (Source: [Electrochemistry Encyclopedia 2011])

Figure 5.3. depicts the working principle of a PEM electrolysis unit in which Hydrogen is produced by supplying ultrapure water to the anode structure, usually made of porous titanium and activated by a mixed noble metal oxide catalyst. The protons are conducted by the membrane (usually Nafion produced by DuPont) to the cathode side, a porous graphite current collector covered in a Pt catalyst. Individual PEM electrolysis cells are stacked together in

bipolar modules with graphite separators plates that provide the necessary manifolds for supplying water and evacuating gas. The water is transported through the membrane from the anode to the cathode with the help of the electro osmotic effect. The following chemical equations describe the working principle of PEM electrolysis:



The operating pressure of a PEM electrolysis unit is generally higher than the one offered by alkaline electrolyzers, current units offering an output pressure between 20 and 80 bar according to [Bertuccioli et al. 2014]. In the same time, the operating temperature is generally situated between 54 and 84 °C according to the same source.

According to [Bertuccioli et al. 2014], PEM electrolysis currently has an efficiency comprised in the 47 to 73 kWh_{el}/kgH₂ that is expected to increase by an additional 10 percent in the following 15 years. The dynamic operation capabilities of PEM electrolyzers are superior to the ones provided by alkaline units, currently offering a minimum partial load between 3 and 8 percent of the full load, as well as an improved startup time between 5 and 15 minutes. Ramping up and down rates of PEM electrolyzers are between 10 and 100% of the full load per second, with an average value around 40% of the full load per second.

Compared to alkaline electrolyzers, PEM units have a higher investment cost, with CAPEX figures currently oscillating between 1200 and 2000 Euro/kW. However, both [Bertuccioli et al. 2014] and [ADEME 2014] indicate massive drops in the CAPEX cost of PEM electrolysis by 2030, to a level of approximately 700 Euro/kW for a complete system excluding grid connection and hydrogen compression and storage. In a similar manner with alkaline electrolyzers, the yearly operational costs are size-dependent, generally starting at 4-5% of the initial CAPEX per year for small scale electrolysis facilities and going down to less than 2% of the initial CAPEX for facilities that exceed an installed capacity of 10 MW.

The lifetime of a PEM electrolysis system is comprised between 20 and 30 years, with a stack lifetime currently situated between 30.000 and 90.000 hours, that is expected to drastically improve in the following period, reaching a minimum stack lifetime of 90.000 hours.

The higher efficiency along with higher hydrogen output pressure that would reduce the downstream requirement for compression, as well as significantly superior flexibility

capabilities compared to alkaline electrolyzers, make PEM units a certain choice for energy storage applications, particularly in Power-to-Gas projects. However, before becoming the go-to technology, improvements are expected in terms of commercial maturity, system sizes and especially capital investment costs.

c. Solid Oxide Electrolyser Cell (SOEC)

Solid Oxide Electrolyser Cell (SOEC) cannot compete at the moment with the other already presented electrolysis technologies in terms of maturity and commercial availability, only making the transition between research phase and product development. However, high temperature electrolysis promises a lot, since it is able to split water into hydrogen and oxygen in an efficient and economical way (reducing the electricity consumption) due to the high operating temperature (700 – 800 °C). SOEC becomes an attractive technology when it can be connected to an external heat source (nuclear, solar or geothermal), using waste steam and increasing the overall efficiency of the whole chain. For future full scale Power-to-Gas applications, SOEC is seen as one of the attractive technologies because it can use the waste heat coming from other processes, like the methanation stage.

According to [ADEME 2014], the governing chemical equations for SOEC electrolysis are the following:

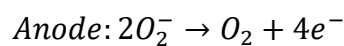
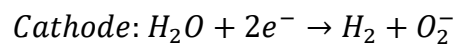

The main components of a Solid Oxide Electrolyser Cell are a dense ionic conducting electrolyte and the porous anode and cathode. Steam is supplied to the cathode site while electric potential is applied to the cell. The water molecules begin to dissociate in order to create hydrogen gas and ions of oxygen. The hydrogen gas diffuses to the surface and gets collected, while the oxygen ions are transported through the dense electrolyte to the porous anode where they are oxidized to oxygen gas and thus release electrons. The working principle is presented in Figure 5.4.

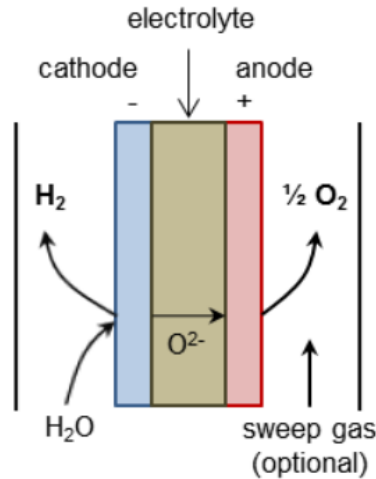

Figure 5.4 Working principle of a SOEC electrolyser (Source: [Petipas 2013])

[ADEME 2014] indicates that one of the most interesting specificities of SOEC electrolysers consists in the fact that they are reversible, being able to function as fuel cells as well. In energy storage applications, this is an important feature, allowing the re-electrification of stored hydrogen without an additional investment in a separate fuel cell unit. The same source indicates that SOEC units can reach 100% efficiency (HHV) if generated heat is taken in to account.

SOEC does not only come with the advantage of increased efficiency, but it also brings some challenges that have to be met: the materials have to withstand these high temperatures (thermal expansion, robustness), the electrolyte needs to be chemically stable and maintain high ionic and low electronic conductivities and the electrodes have to be chemically stable while still offering good electronic conductivity. Since the technology is currently far from commercial availability, estimating the required investment and operational costs would be a difficult task, however [ADEME 2014] states that a target of 1000 Euro/kW has been set by Haldor Topsoe, with yearly OPEX costs around 3 % of the CAPEX.

5.2.2.1 Key performance indicators of electrolysis in energy storage applications and further development paths

The most important performance indicators for Alkaline and PEM electrolysis technologies in energy storage applications have been gathered in Table 5.1. SOEC was not included since the horizon for commercial maturity is still distant.

Table 5.1 Key performance indicators of Alkaline and PEM electrolysis technologies in 2015 and 2030

Category	Alkaline		PEM		Reference
	2015	2030	2015	2030	
Stack size [kW]	200 - 4900	400 - 7800	100 - 1300	1,000 - 10,000	[Bertuccioli et al. 2014]
Electricity input [kWhel/kgH2]	50 - 73	48 - 63	47 - 73	44 - 53	
Availability [hours/year]	8585	8585	8600	8672	
Output pressure [bar]	0.05 - 40	0.05 - 60	20 - 80	30 - 100	
Operating temperature [°C]	60 - 80	60 - 90	54 - 84	60 - 90	
Stack lifetime [hours]	70,000 – 90,000	90,000 - 100,000	30,000 - 90,000	60,000 – 90,000	
System lifetime [years]	22 - 30	30 - 30	14 - 30	30	
Minimum partial load [% of full load]	16 - 33	10 - 20	3 - 8	0 - 5	
Startup time [minutes]	20 minutes minimum	20 minutes minimum	5 - 15	5 - 15	
Ramp up time [% of full load/second]	0.13 - 20	0.13 - 25	10 - 100	10 - 100	
Ramp down time [% of full load/second]	20	25	10 - 100	10 - 100	
Capital investment cost [Euro/kW]	760 - 1100	370 - 800	1200 - 1940	250 - 1270	
Operational cost [% of CAPEX]	1.5 - 5	1.5 - 5	1.5 - 5	1.5 - 5	

Certain developments are envisaged for both Alkaline and PEM electrolyzers in the following 15 years. While technical advancements are expected to be rather marginal than revolutionary, they will more than likely take place and will only bring improvements to the overall efficiency of energy storage applications, in particular Power-to-Gas. On the other hand, economic

developments are expected to be more dramatic, with drastically reduced CAPEX costs for both alkaline and PEM electrolysis, as large scale deployment of energy storage is expected to bring down costs rapidly.

[ADEME 2014] underlines the fact that the envisaged cost reductions will come mainly from three elements:

- Technology improvements, meaning cheaper materials for the components of the electrolysis units; additionally, less materials are expected to go in the manufacturing of the units.
- Improvements in terms of unit sizing, translating in performance gains.
- A rise in the sales volumes, leading to a higher degree of industrialization, allowing an optimization in the cost structure.

5.3 METHANATION

Based on the chemical reaction discovered by the French chemist Paul Sabatier at the beginning of the 20th century, the methanation stage represents the second step in the Power-to-Gas SNG pathway:

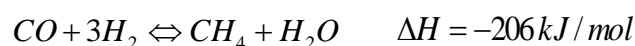
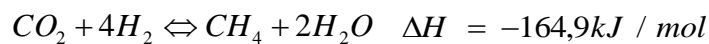

Due to the high thermodynamic stability and the high oxidation state, a powerful reducing agent is necessary for activating CO₂, hydrogen being the most suitable. Reducing CO₂ with hydrogen leads to obtaining methane and water. CO and CO₂ are hydrogenated according to the methanation reactions, both favored by low water content and high pressure. A challenge arises from the high potential adiabatic temperature increase because it needs a catalyst stable at high temperatures that also has a high activity at low temperatures. In case syngas with a minimum methane concentration would be introduced in an adiabatic methanation reactor at 300°C, the reaction might reach temperatures around 900°C. Theoretically, this could be handled by using traditional reforming catalysts, but due to the challenges related to material selection and insufficient catalyst activity, this might not be technically feasible. On the other hand, strong exothermic reactions have been handled by recycling (diluting the inlet gas) in order to keep the temperatures below 450°C according to [Görling 2012]. Low temperatures

favor high conversion of CO and CO₂, therefore in order to reach methane levels of 95-98%, it is necessary to use several methanation steps in adiabatic reactors operating at decreasing temperature levels and split by intermediate cooling. Depending on the required product quality, the final reactor is operated at temperature between 200 and 300°C. The number of reactors is a result of an optimization based on requirements of product gas quality and heat recovery.

[ADEME 2014] and [Alain Bengaouer 2015] indicate that methanation takes place in a reactor in the presence of a catalyst, which can generally be based on nickel, rhodium or ruthenium. Nickel is the most common choice due to its relatively low costs. A different methanation pathway that will not make the point of the Thesis, biologic methanation, is a more recent approach that is still in development stage and is based on the purification of biogas produced by anaerobic fermentation of organic matter.

The Sabatier reaction is exothermic and offers heat at high temperatures, favoring the possibility of heat recovery in order to improve the overall efficiency of the process and open new synergy opportunities for the Power-to-Gas project.

It is important to note that a purification system is required at the output of the methanation reactors in order to bring the output SNG to the injection requirements stated by the operator of the natural gas grid.

According to [ADEME 2014] and [Zuberbühler 2013], the efficiency of the methanation stage is around 79% HHV. However, if the heat produced by the process is recovered (it is estimated that 90% of the heat can be recovered), the overall efficiency can rise to approximately 98% HHV. In terms of dynamic operation, the same sources indicate that a steady state operating regime is ideal, prolonging the life of the catalyst. Due to the fact that the methanation reactors cannot be operated with the same flexibility as the electrolysis units, intercalating a hydrogen storage tank represents the solution for offering the methanation stage continuous operation.

In terms of costs, methanation is still an expensive niche technology, the costs being presented by [DNV KEMA Energy & Sustainability 2013] in the following figure:

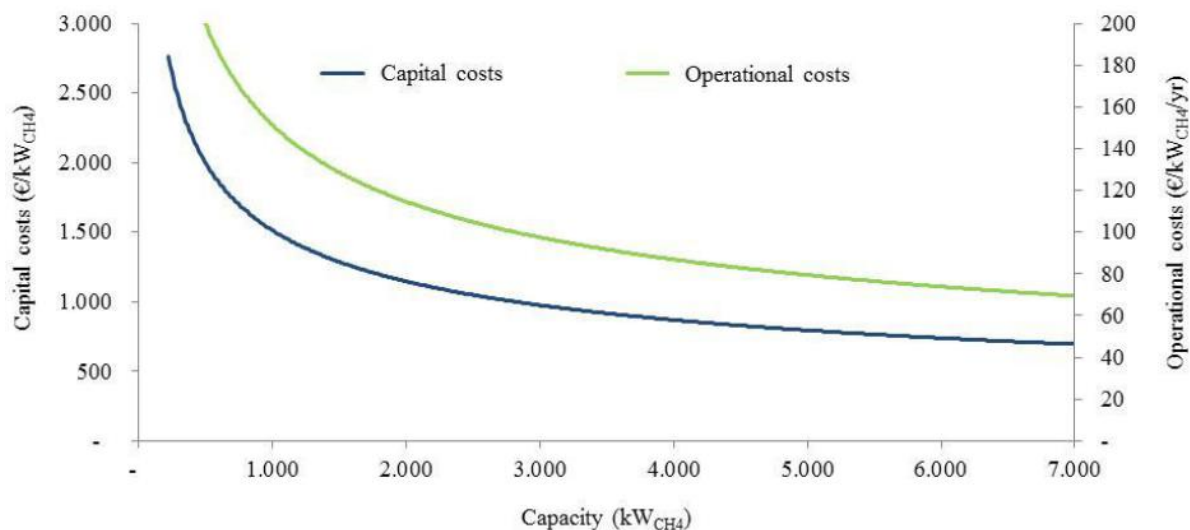

Figure 5.5 Capital and operational costs of methanation (source: [DNV KEMA Energy & Sustainability 2013])

According to [ADEME 2014], costs are expected to decrease over the next 15 years, towards a CAPEX of around 500 Euro/kWh of SNG HHV in 2030 and an OPEX of 10% of the CAPEX per year, while no significant efficiency improvements are expected.

The methanation reaction in the Power-to-Gas context of the Thesis will be further described, analyzed and simulated in the dedicated chapter, and partially in the chapter dedicated to evaluating the environmental impact of leveraging Power-to-Gas.

5.4 CO₂ CAPTURE

A full-scale Power-to-Gas SNG project does not limit itself to converting, storing and transporting energy, it also adds a very important environmental aspect to the equation: capturing and using carbon dioxide. The CO₂ capture and methanation steps add a whole new dimension to a Power-to-Gas project, significantly increasing its complexity, but at the same time offering clear advantages that unleash the full potential of the concept of storing and transporting energy using a different vector than electricity, access to the natural gas infrastructure without limitations related to blending concentration.

Carbon dioxide is the most important of the greenhouse gases released by human activities being the main contributor to climate change because of the quantities released. On a worldwide basis, CO₂ emissions generated from anthropogenic activities are known to be

relatively small and in comparison with the gross carbon fluxes from natural systems, they represent only a fraction (~2%) of total global emissions. However, evidence suggests that they account for most of the observed accumulated CO₂ in the atmosphere. On the basis of global emissions information, the primary sources of CO₂ generated from anthropogenic activities are fossil fuel combustion from industry and industrial processes such as cement production, transportation, space heating, electricity generation and cooking, vegetation changes in natural prairie, woodland and forested ecosystems [Hassan 2005].

While carbon capture in conjunction with Power-to-Gas offers the huge environmental advantage of trapping a certain quantity of CO₂ in the loop for at least one cycle, this comes at a very high energetic cost. Taking the example of a cement plant, equipping it with CO₂ capture capabilities will bring a 30 percent penalization to the total energy consumed according to [International Energy Agency 2008]. This figure remains similar in the case of a power plant or a refinery. CO₂ capture is expected to become a very hot topic as soon as emission regulations will become stricter and large industrial emitters will be forced to drastically reduce them, but in the same time incentivized by the Emission Trading Scheme [EU ETS 2015]. Power-to-Gas projects are generally deployed at large scale, regional or even national, therefore a wide range of CO₂ sources can be taken in to consideration: cement plants, power plants (especially coal and gas turbine power plants), steel plants, refineries and the chemical industry.

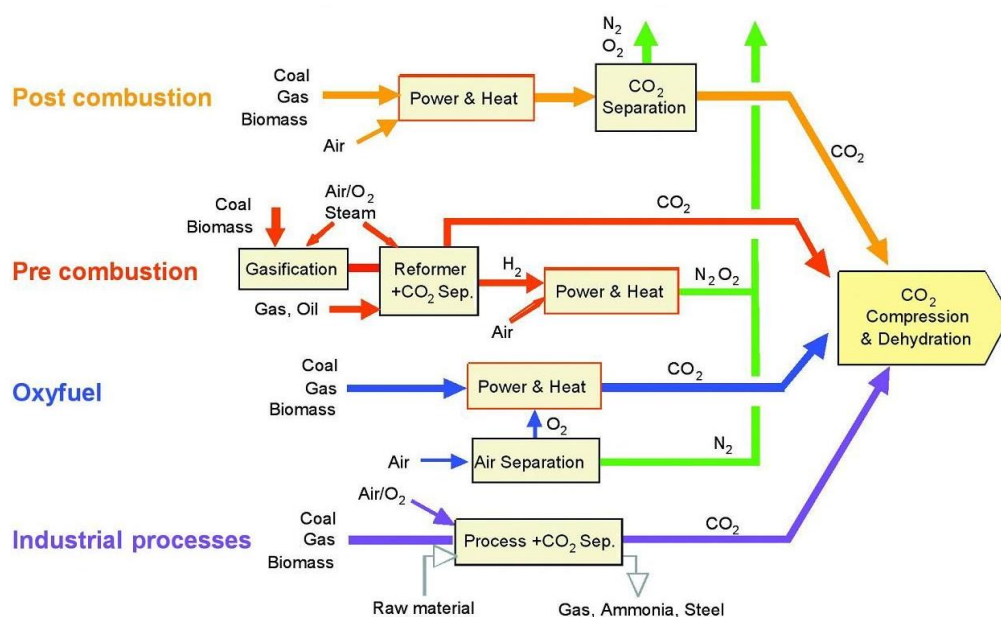

Figure 5.6 Overview on carbon capture technologies (Source: [Intergovernmental Panel on Climate Change 2011])

[UN Industrial Development Association 2010] and [Göttlicher 2004] present that depending on the application and its particularities, there are three main approaches for carbon capture, which are presented in Figure 5.6 and Table 5.2.

Table 5.2 Carbon Capture Technologies

	Post-combustion	Pre-combustion	Oxy-fuel combustion
Applications	<ul style="list-style-type: none"> • Power plants • Cement industry • Chemical industry • Oil and Gas industry 	<ul style="list-style-type: none"> • Power plants • Chemical industry 	<ul style="list-style-type: none"> • Various industrial processes
Retrofitting	Yes	No	Yes
Abatement efficiency	>98%	85 to potentially 100%	Very High
Penalty on energy efficiency	Yes (very high)	Yes	Yes
Other emissions	No	Yes (reduced acids components in flue gas)	Unknown
Production costs	45 €/t CO ₂	50 – 55 €/t CO ₂	Difficult to estimate
Advantages	<ul style="list-style-type: none"> • Already commercially available • Can be retrofitted • Most advanced CCS process at the moment 	<ul style="list-style-type: none"> • High pressure • CO₂ concentration 	<ul style="list-style-type: none"> • Can be retrofitted • CO₂ concentration
Disadvantages	<ul style="list-style-type: none"> • Diluted CO₂ output (<15%) • Low CO₂ pressure • Steam (heat) required • Large size of equipment • High penalty on energy efficiency 	<ul style="list-style-type: none"> • Cannot be retrofitted • Gasification costs and availability • No reduction in process CO₂ 	<ul style="list-style-type: none"> • Cryogenic O₂ is needed • CO₂ cooling is required • Flue gas recirculation is required

5.4.1 Post-combustion

Post-combustion CO₂ capture comes at the end of the combustion chain and adds a carbon dioxide removal stage to the process of flue gas clean up. Instead of being released directly to the atmosphere, the flue gas is passed through equipment that separates the carbon dioxide, while the remains of the process are released to the environment.

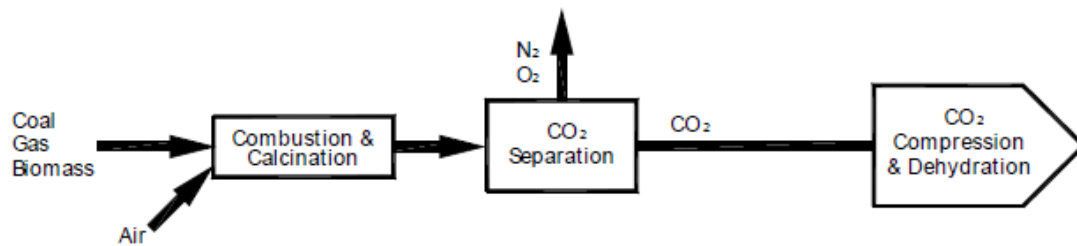

Figure 5.7 Post-combustion carbon capture (Source: [International Energy Agency 2008])

The post-combustion capture of CO₂ from a flue gas can be achieved by a variety of different methods. The leading commercial technologies are using a chemical process that offers a high capture efficiency, selectivity and the lowest energy use and costs when compared with other existing and emerging capture processes. However, important developments are expected in this domain and the emerging capture processes have the potential of becoming the better solutions in the near future.

Post-combustion CO₂ capture is the only technology that has reached commercial maturity at the moment and has the advantage that it offers the possibility of being retrofitted to existing carbon dioxide emitting facilities. Another advantage lays in the fact its overall efficiency is expected to become even better in the near future due to important advancements in equipment and sorbents. The biggest drawbacks lay in the penalty it brings in the efficiency of the industrial process and in the low output pressure of CO₂ [International Energy Agency 2008].

5.4.2 Pre-combustion

Three stages make up the pre-combustion CO₂ capture technology, with the first step consisting of a reaction between the hydrocarbon (coal, natural gas or biomass) with steam or oxygen, resulting in a mixture, known as syngas, that contains hydrogen and carbon monoxide. The process in which the fuel reacts with steam is known as “vapo-reforming”, while the reaction

with oxygen is known as “partial oxidation” when it is applied to gaseous or liquid fuels and gasification when the primary fuel is solid. The second step of the process is the catalytic reaction between carbon monoxide and further steam in order to produce CO₂ and more hydrogen. It is also known as the “water gas shift reaction” and the result is a stream of hydrogen with a high concentration of CO₂ – usually between 15 and 60%. Finally, the CO₂ is removed from the carbon dioxide/hydrogen mixture.

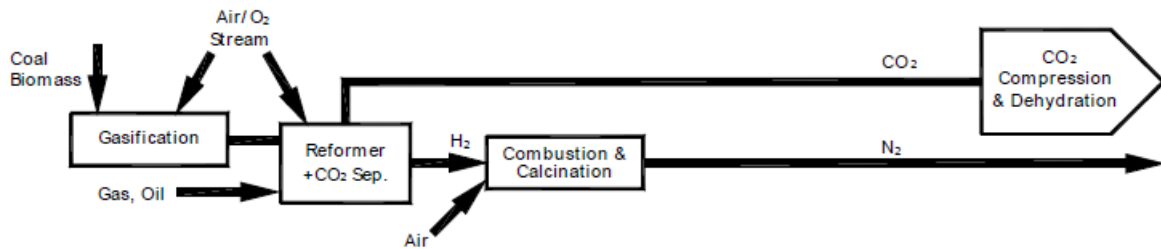

Figure 5.8 Pre-combustion carbon capture (Source: [International Energy Agency 2008])

According to [Hoenig et al. 2007], pre-combustion carbon capture technologies are generally used for producing relatively carbon free fuels, such as hydrogen, or for reducing the carbon content of fuels that contain hydrocarbons. When used for the first case, the fuel does not necessarily have to be one hundred percent pure and can contain a low percentage of methane, CO or CO₂ and in some cases nitrogen. However, the reduction in carbon dioxide emissions is higher if the level of carbon-containing compounds is lower. Hydrogen can be used in different applications (gas turbines, heaters or fuel cells), while the carbon component of the fuel is removed as CO₂ after it is being separated from the hydrogen through membranes or absorption and adsorption procedures.

5.4.3 Oxy-fuel combustion

In the oxy-fuel combustion, oxygen is preferred to ambient air for combustion. As a consequence, the concentration of carbon dioxide in the flue gas increases. In order to keep the combustion temperature at the required levels, recycling flue gas becomes a necessity, with the recycling rate becoming the adjustment parameter for the combustion temperature [Hoenig et al. 2007].

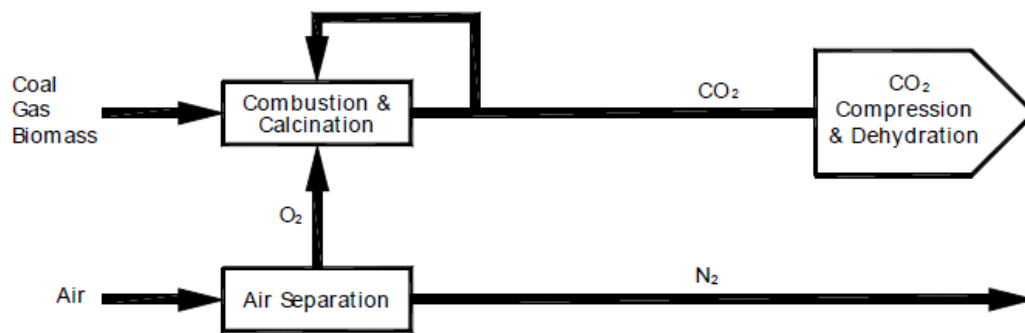

Figure 5.9 Oxy-fuel combustion carbon capture (Source: [International Energy Agency 2008])

[Hoenig et al. 2007] also states that oxy-fuel combustion has a certain advantage in the fact that the concentration of carbon dioxide in the flue gas is around 80%, leading to a less complicated carbon dioxide purification stage. One of the most important stages in oxy-fuel combustion consists in producing oxygen, the go-to technology for the moment being the distillation of oxygen from air at cryogenic temperatures, a well-known process that can reliably produce significant quantities of oxygen suitable for industrial processes. However, the energy requirement of producing oxygen (between 200-240 kWh/t O₂), is considered relatively high for making oxy fuel combustion competitive with post combustion carbon capture technologies. In the case of a full-scale deployment of the Power-to-Gas concept, the necessary oxygen can be obtained from the electrolysis process, transforming oxy-combustion CO₂ capture in a very attractive technology for this type of application.

5.4.4 Economics of CO₂ capture

Capturing carbon dioxide is, for the moment, an expensive technology that brings a significant cost penalty to the industrial emitters:

- In the case of power plants (coal or natural gas) the cost of capturing CO₂ is situated between 35 and 50 Euro/ton
- For the cement industry, the cost is estimated between 30 and 65 Euro/ton of CO₂ [ADEME 2014]

The same source reports on the required resources for CO₂ capture in a power plant in the case post-combustion technology is used:

- 0.03 MWh/ton of CO₂ electricity
- 1.04 MWh/ton of CO₂ heat
- 1.5 m³ of water per ton of CO₂

In addition, an estimated CAPEX of 450,000 Euro/ton CO₂/h is required, along with an OPEX of 14,000 Euro/ton CO₂/h/year.

5.5 HYDROGEN COMPRESSION, STORAGE AND INJECTION

5.5.1 Storage

In certain applications of the Power-to-Gas concept (for example the Power-to-Gas SNG pathway, where a continuous flow of hydrogen is ideally ensured for the input of the methanation reactor), storing hydrogen becomes a requirement. At the moment, the standard technical solution for storing hydrogen at relatively high pressure consist in using hydrogen tanks and an overview of the costs can be seen in Figure 5.10.

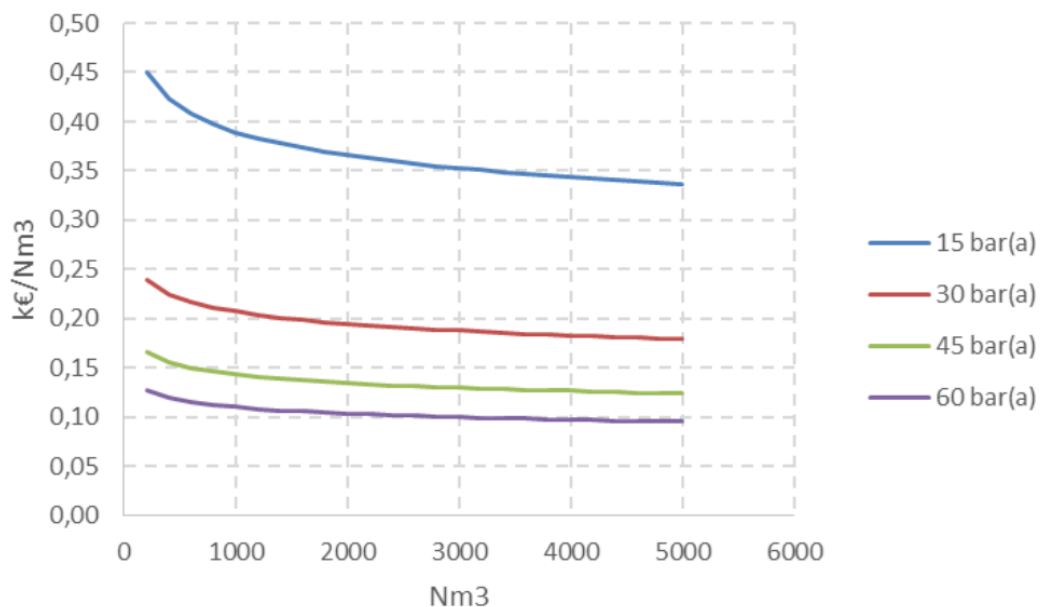

Figure 5.10 Capital costs of hydrogen storage tanks depending on the storage pressure [Source: [ADEME 2014)]

5.5.2 Compression

At the moment, the maximum output pressure of alkaline or PEM electrolyzers considered for Power-to-Gas projects varies between 1 and 30 bar [Bertuccioli et al. 2014], [ADEME 2014]. However, when considering hydrogen storage, in order to keep the capital costs associated to the size of the storage tank to a reasonable level, a compression stage is required between the output of the electrolyzers and the storage tank. Due to the particularities of hydrogen (it has the smallest diameter molecules), hydrogen compressors have a relatively complex construction which translates into higher CAPEX costs compared to compressors dedicated to other gases, as presented by Figure 5.11.

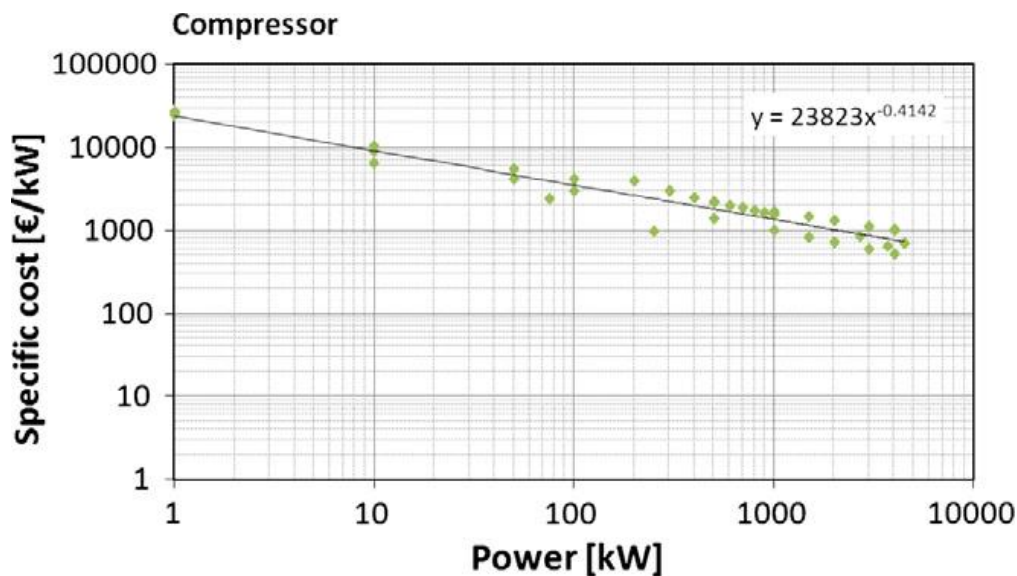

Figure 5.11 Capital costs of hydrogen compressors (Source: [Beccali et al. 2013])

5.5.3 Injection components

For injecting hydrogen or SNG (Substitute Natural Gas) in the natural gas infrastructure (transport or distribution grid), a connection and an injection station are required. The injection station generally contains all the elements related to control, metering, quality control and odorization, while the connection makes the link between the injections station and the natural gas network.

When injecting into the natural gas distribution grid, which has a 5 bar pressure, the CAPEX cost of the injection station is approximately 600,000 Euro, with an OPEX of 8% of the

CAPEX. The capital cost associated to the connection in the same situation is approximately 130,000 Euro, with an operational cost of 2% of the CAPEX.

When the injection is performed directly into the higher pressure distribution grid (30 bar), the CAPEX costs of the injection station rise to 700,000 Euro, while the capital cost of the connection is 410,000 Euro. The OPEX costs associated to the two infrastructure components remain the same. The economic date is valid for France, as presented by [ADEME 2014].

6 DEVELOPING AN ANALYSIS FRAMEWORK FOR POWER-TO-GAS PROJECTS

6.1 THE NEED FOR AN ANALYSIS FRAMEWORK

The following chapter focuses on presenting the development of an analysis framework dedicated to Power-to-Gas projects considered from an individual investor point of view, meaning that rather than taking into account a large scale deployment of Power-to-Gas, at energy system level, this approach is more suitable when regarding the possible investment from an investor's point of view and therefore it will concentrate on pragmatic economic indicators rather than on the technical and environmental advantages brought by the Power-to-Gas technology to the energy system.

At the beginning of the study, several approaches presented in the scientific literature were identified and investigated concerning methods of analyzing and benchmarking Power-to-Gas projects from a technical and economic point of view. However, these studies focus either on small-scale off-grid applications of the Power-to-Gas technology, or on a holistic approach of deploying Power-to-Gas to the whole energy system of a certain country. The methodology presented in these case studies could not be fully adapted to the case study that makes the subject of the thesis, its main characteristic being that it uses only renewable energy from a single wind park, creating the need for developing a new analysis framework.

The definition of the Power-to-Gas concept revolves around the term “surplus renewable energy”, however all the energy produced by the wind park in Romania is sold on the energy market and injected in to the energy system. The fact that wind energy has priority on the merit order curve [OPCOM 2014] means that the curtailment factor for wind energy is very low in Romania. Therefore, instead of “surplus energy”, the study focused on “low-value energy” and

the analysis framework was developed in order to determine the optimum level of energy fed to the Power-to-Gas process that would lead to the best economic indicators.

The only available input data consisted of the annual energy production of a 10 MW wind park situated in the South-Eastern part of Romania and the electricity price on the Romanian day-ahead electricity market (DAM) for the same period. Determining the amount of energy that should be redirected to the electrolysis units represented the essential step in the technical sizing of the Power-to-Gas process and represents the first stage of the approach. Since the technical benefits of the technology can only be quantified at the level of an entire energy system, economic indicators were used for comparing different options. Basically, the new strategy relies on synchronizing the actual energy production of the 50 MW wind park with the energy market prices in order to establish the energy quantity that is fed to the Power-to-Gas process based on not only technical, but economic indicators as well. This provides results on the optimal technical sizing of the plant.

As soon as the optimum size was determined, a second stage of the analysis framework was developed, with the aim of performing a detailed economic analysis that would answer the questions related to a possible investment. This approach is replicated for the different Power-to-Gas pathways taken into consideration throughout the Thesis.

6.2 STAGES OF THE ANALYSIS FRAMEWORK

The stages of the analysis framework are developed gradually with the aim of maintaining a consistent, adaptable and transparent approach that can be used in creating business case studies of Power-to-Gas implementations.

Figure 6.1 presents the schematic representation of the novel analysis framework proposed in the current chapter. Basically, the whole framework can be divided in two parts: the technical sizing and the economic analysis.

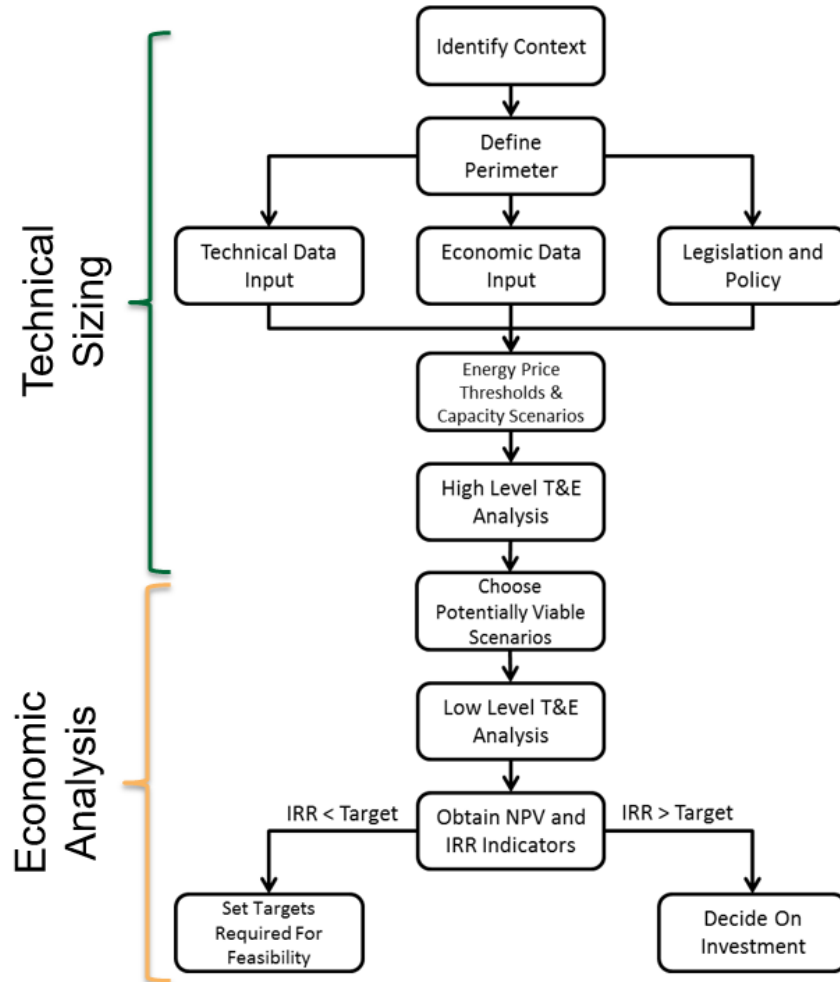

Figure 6.1 The novel analysis framework for Power-to-Gas projects developed as part of the thesis

- a. Context identification – The first step of the approach consists in establishing the project and defining the goal and the scope of the study, with focus on addressing the specific demands of the investor, as well as type of Power-to-Gas project, geographic localization and the desired starting period of the project. Another important part in understanding the context consists in identifying all the available resources (carbon dioxide, water etc.) and transport infrastructure (well-developed natural gas transport or distribution infrastructure, electricity transport lines of various voltage etc.) associated with the Power-to-Gas technology. This can potentially answer questions related to the type of Power-to-Gas projects that can be developed, as well as offer solutions for possible synergies with upstream or downstream processes (giving economic value to oxygen, heat integration, carbon capture etc.).

- b. Perimeter definition – After analyzing the possible application of the Power-to-Gas technology in the given context, the available integration and synergy possibilities offered by the geographic localization, the next step consists in clearly defining the perimeter taken into account in the study. This translates into choosing the type of Power-to-Gas project, establishing the input and output resources along with their sources or destinations and identifying the required transport infrastructure. It is actually the stage in which the project is defined and all the important details are set.
- c. Data input – as soon as the Power-to-Gas project is defined, it is time to start gathering all the information that is necessary for building the complete business case. The current analysis framework takes into account historical (but as recent and as relevant as possible) data related to energy production and prices. We can split this process into three main categories:
- Technical data input - essential input data related to the available renewable energy production (at least an hourly energy production of the renewable energy sources for covering a period of minimum one year). In case the balancing market is considered to be included in the perimeter, data related to the frequency of events and demands on this market should be taken into consideration.
 - Economic data – energy market prices corresponding to the energy production period of the renewable energy sources represent the most important element of this category. Additionally, it is important to consider the prices of all the resources involved, either primary or secondary (price of natural gas, carbon dioxide, oxygen, heat etc.). Transport costs, as well as miscellaneous financial indicators (discount rate, insurance costs, taxes, fees etc.) have to be taken into consideration at this stage.
 - Legislation and policy data – the economic profitability of a Power-to-Gas is potentially influenced by support measures imposed by local policy. At European level, each country has developed its own set of rules and guidelines for supporting renewable energy [document on RE support] and, in some cases, energy storage solutions [France]. In addition, there are also technical legal constraints that have to be acknowledged regarding energy markets, injection in the natural gas or electricity grid.

- d. Energy price threshold & capacity scenarios – the key element of the analysis framework consists in selecting energy price thresholds in conjunction with installed capacity scenarios in order to obtain the optimum technical sizing of the Power-to-Gas project depending on a desired economic indicator. At this stage, it is essential to establish an operational strategy and determine the available energy input from the wind farm that will be fed to the Power-to-Gas chain. In order to do this, several electricity price thresholds on the market are chosen and the operating strategy consists in:
- all the electricity priced below the imposed threshold is redirected to the electrolysis process from the Power-to-Gas chain,
 - the electricity priced above the threshold is sold on the energy market and fed to the grid.

The amount of energy available for Power-to-Gas can be considered surplus energy or low value energy that has the potential of being better put to value by being converted, in the Power-to-Gas chain. In order to establish the operating strategy and choose the most efficient size of the electrolyser and the further components of the technical chain, each energy price threshold scenarios is divided in several other sub scenarios defined by the installed capacity of the electrolysis units.

- e. High-level technical and economic analysis - as a result of the previous step, an array of scenarios based on different energy price thresholds and different electrolyser capacities have to be analyzed and compared. An economic indicator that will represent the comparison basis between the different scenarios is needed. The Levelized Cost of Energy (LCOE) as defined by [Fraunhofer 2013] is the indicator suggested by the current analysis framework for choosing which are the optimum scenarios that will be thoroughly evaluated in the next stages. The objective will thus be to minimize the cost of energy as this will maximize the profit. At this point, only a high level evaluation of the scenarios is performed, therefore the obtained results are only used for comparative reasons, without putting stress on the absolute values. Regarding the current thesis, this approach has been used for evaluating the Romanian case. Alternatively, this step of the strategy can be performed using an optimization software that will allow analyzing a larger number of scenarios and sub scenarios (a wider palette of energy price threshold and electrolyser installed capacities) in order to obtain a more precise indication of the optimum scenario. This alternative approach was used for assessing Power-to-Gas in the European context.

- f. Choosing the potentially viable scenarios – the most favorable scenarios based on the LCOE results of the high-level technical and economic analysis are chosen. If multiple Power-to-Gas pathways are analyzed, the choice will be made for each of them.
- g. Detailed technical and economic analysis – the scenarios selected in the previous step are technically optimized (taking into account more specific data related to equipment and that are used, analyzing all the possible synergies and putting value on secondary resources such as oxygen or heat). At the core of the detailed analysis lays a Discounted Cash Flow [13] model, a valuation method that uses future free cash flow projections discounted to a present value, aiming at calculating widely used economic indicators for an investment made in Power-to-Gas: NPV (Net Present Value) and IRR (Internal Rate of Return). The most important part of the DCF model consists in calculating the initial investment and establishing the profits and losses for each pathway.
- h. Obtaining NPV and IRR indicators and investment decision – the last stage of the proposed analysis framework consists in analyzing the NPV and IRR indicators obtained from the DCF model and comparing them to the targets that are imposed by the investor. If the indicators are above the threshold that suggests an investment is profitable, the Power-to-Gas project can be considered for investment. However, if the indicators are situated below the threshold, the evaluation process continues with setting the targets that are required for reaching economic feasibility. These targets can be:
 - Technical targets – increases in process efficiency and operational strategy efficiency, leverage possible synergies that will impact the overall efficiency.
 - Economic targets – improvements regarding cost of technology, evolution of energy market prices, secondary resource prices or incentives that can support an easier market deployment for the technology.
 - Policy measures – identifying new potential measures meant to ease or speed up the deployment of Power-to-Gas technology (for example a renewable hydrogen or renewable SNG quota or carbon capture incentives) and set their level of incentive at the required threshold for a positive business case for the investors.

The described analysis framework is going to be applied in studying the possibility of leveraging Power-to-Gas in the Romanian and French cases, where it is going to be thoroughly described in a practical step-by-step manner.

Points (e) and (g) are described and performed separately in the Thesis' context due to limitations regarding the modeling process that involved using separate software tools for determining the optimum size of the process, modeling the methanation stage and performing the Discounted Cash Flow analysis. A tool dedicated to the technical and economic analysis of Power-to-Gas projects would allow performing these two in a single, more direct, step. Also, it is important to note that using only the day-ahead market value for electricity price is a particular case of the modeling approach of the Thesis, as other works might also consider additional costs regarding transport, feed-in etc.

7 METHANATION PROCESS

7.1 INTRODUCTION

The current chapter deals with the theoretical background, chemistry and thermodynamics, kinetic of the reactions involved in the methanation process, backed by an overview on the methanation technologies (the design of the Sabatier reactor system) that have been developed for the production of SNG from coal during the sixth and seventh decade of the last century, as well as on the recent developments concerning new processes for SNG production from coal, and treats an integrated design study of the methanation process in order to obtain SNG with a high content of methane following the existing technologies as a starting point. Methane synthesis from carbon dioxide and hydrogen was considered, based on the TREMP-like process (Topsøe's Recycle Energy-efficient Methanation Process) developed by Haldor-Topsøe, process used to obtain substitute natural gas (SNG).

This chapter focuses on the assumptions, the flowsheet and the results of the integrated design of the methanation process. The model of the plant considers three adiabatic equilibrium reactors, placed in series, following the TREMP process, with a recycle loop in order to lower the temperature in the first reactor. Moreover, the operating conditions were determined in such way to maximize the methane selectivity and to ensure that the maximum temperature allowed by the catalyst is not exceeded during adiabatic reactor operation.

Aspen Plus version 8.4 was used as the process simulation software. The procedures for process simulation mainly involve defining chemical components, selecting a thermodynamic model, checking the properties required, choosing proper operating units and setting up input condition (flow rate, temperature, pressure and other condition). Information on most components, such as methane, hydrogen, carbon dioxide, carbon monoxide and water is available in the Aspen Plus component library. The thermodynamic properties were calculated using the Peng-

Robinson thermodynamic model, with the main processing units including reactors, heat exchangers, mixers, separators and compressors.

7.2 CHEMICAL FUNDAMENTALS

Discovered in 1902 by Sabatier and Senderens, the carbon dioxide methanation process converts carbon dioxide to methane. The methanation of carbon oxides over a variety of transition and noble metal-supported catalysts has been extensively investigated in a broad temperature (250 – 650 °C) and pressure (1 – 80 bar) range [Weatherbee & Bartholomew 1982], [Karelovic & Ruiz 2013], [Maatman 1980], [Schlereth & Hinrichsen 2014], [Kopyscinski et al. 2010]. However, nickel is the traditional Sabatier catalyst that has been extensively investigated and is the optimum catalyst choice considering its relatively high activity, good methane selectivity, and low raw material price.

In CO₂ methanation (Sabatier reaction), CO₂ and H₂ react in the presence of catalysts to form methane and water. The stoichiometric ratio is CO₂:H₂ = 1:4 in Eq. (2), but the reaction can be performed with an excess of either reactant. The reaction is highly exothermic:

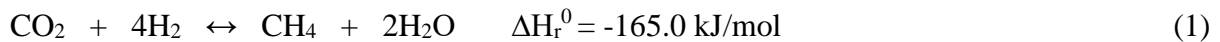

Another reaction, called Water Gas Shift Reaction (RWGS) occurs simultaneously whenever active catalysts are used, Eq. (2):

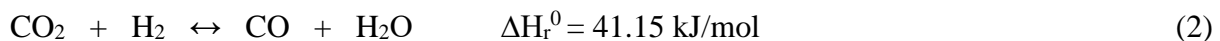

The RWGS reaction is endothermic and favoured by high temperature. However, the formed CO is quickly converted to methane Eq. (3):

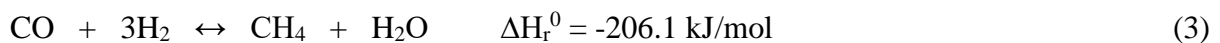

7.3 METHANATION KINETICS

Kinetic expressions are taken from the work of [Xu & Froment 1989], which describe the intrinsic kinetic expressions based on a Langmuir-Hinshelwood mechanism:

$$r_1 = \frac{k_1}{p_{H_2}^{3.5}} \cdot \frac{p_{CH_4} \cdot p_{H_2O}^2 - \frac{p_{H_2}^4 \cdot p_{CO_2}}{K_1}}{DEN^2} \quad (\text{Ec. R1})$$

$$r_2 = \frac{k_2}{p_{H_2}} \cdot \frac{p_{CO} \cdot p_{H_2O} - \frac{p_{H_2} \cdot p_{CO_2}}{K_2}}{DEN^2} \quad (\text{Ec. R2})$$

$$r_3 = \frac{k_3}{p_{H_2}^{2.5}} \cdot \frac{p_{CH_4} \cdot p_{H_2O} - \frac{p_{H_2}^3 \cdot p_{CO}}{K_3}}{DEN^2} \quad (\text{Ec.R3})$$

where $DEN = 1 + K_{CO} \cdot p_{CO} + K_{H_2} \cdot p_{H_2} + p_{CH_4} \cdot K_{CH_4} + \frac{K_{H_2O} \cdot p_{H_2O}}{p_{H_2}}$

The preexponential factors $A(k_i)$ and $A(K_j)$ are calculated from the $k_{i,T}$ and $K_{j,T}$, while E_i and ΔH_j values can be calculated by the Arrhenius equation and van't Hoff equation. The kinetic parameters of the above reaction rates are listed in Table 7.1.

$$k_i = A(k_{i,T}) \cdot \exp\left[-\frac{E_i}{(RT)}\right], i = 1, 2, 3 \quad (4)$$

$$K_i = A(K_{i,T}) \cdot \exp\left[-\frac{\Delta H_i}{(RT)}\right], i = 1, 2, 3 \quad (5)$$

$$K_j = A(K_{j,T}) \cdot \exp\left[-\frac{\Delta H_j}{(RT)}\right], j = CH_4, H_2O, CO, H_2 \quad (6)$$

$$A(k_i) = k_{i,T} \cdot \exp\left(\frac{E_i}{RT}\right) \quad (7)$$

$$A(K_j) = K_{j,T} \cdot \exp\left(\frac{\Delta H_j}{RT}\right) \quad (8)$$

Table 7.1 Kinetic parameters

$A(k_i)$ [$\text{kmol}\cdot\text{bar}^{1/2}\cdot\text{kg}_{\text{cat}}^{-1}\cdot\text{h}^{-1}$]				$A(K_j)$ [bar^{-1}]		
$A(k_1)$	$A(k_2)$	$A(k_3)$	$A(K_{\text{CH}_4})$	$A(K_{\text{H}_2})$	$A(K_{\text{H}_2\text{O}})$	$A(K_{\text{CO}})$
$4.225\cdot 10^{15}$	$1.955\cdot 10^6$	$1.020\cdot 10^{15}$	$6.65\cdot 10^{-4}$	$6.12\cdot 10^{-9}$	$1.77\cdot 10^5$	$8.23\cdot 10^{-5}$
$A(K_i)$ [bar^2]				ΔH_j [kJ/mol]		
$A(K_1)$	$A(K_2)$	$A(K_3)$	ΔH_{CH_4}	ΔH_{H_2}	$\Delta H_{\text{H}_2\text{O}}$	ΔH_{CO}
$4.707\cdot 10^{12}$	$1.142\cdot 10^{-2}$	$5.375\cdot 10^{10}$	-38.28	-82.90	88.68	-70.65
E_i [kJ/mol]				ΔH_i [kJ/mol]		
E_1	E_1	E_1	ΔH_1	ΔH_2	ΔH_3	
240.1	67.13	243.9	-206.1	41.15		-165.0

Nomenclature:

$A(k_i)$ – preexponential factor of the rate coefficient, k_i
 $A(K_j)$ – preexponential factor of adsorption constant, K_j
 E_i – activation energy of reactions 1), 2) and 3), kJ/mol
 ΔH_j – enthalpy change of reaction or adsorption, kJ/mol
 K_1, K_3 – equilibrium constant of reactions 1) and 3), bar^2
 K_2 – equilibrium constant of reaction 2)
 $K_{\text{CH}_4}, K_{\text{CO}}, K_{\text{H}_2}$ – adsorption constants for CH_4 , CO and H_2 , bar^{-1}
 $K_{\text{H}_2\text{O}}$ – dissociative adsorption constant of H_2O
 k_1, k_3 – rate coefficient of reaction 1) and 3), $\text{kmol}\cdot\text{bar}^{1/2}/(\text{kg}_{\text{cat}}\cdot\text{h})$
 k_2 – rate coefficient of reaction 2), $\text{kmol}/(\text{kg}_{\text{cat}}\cdot\text{h}\cdot\text{bar})$
 P – total pressure, bar
 p_j – partial pressure of component j , bar

T – temperature, K

R – gas constant, $kJ/kmol$

r_1, r_2, r_3 – rates of reactions 1), 2), 3), $kmol/(kg_{cat} \cdot h)$

r_{CH_4} – rate of methane disappearance in steam reforming, $kmol_{CH_4}/(kg_{cat} \cdot h)$

r'_{CH_4} – rate of methane formation in the reverse of water-gas-shift and methanation, $kmol_{CH_4}/(kg_{cat} \cdot h)$

r_{CO} – rate of CO formation in steam reforming of methane, $kmol_{CO}/(kg_{cat} \cdot h)$

r'_{CO} – rate of CO formation in the reverse of water-gas-shift and methanation, $kmol_{CO}/(kg_{cat} \cdot h)$

r_{CO_2} – rate of CO_2 formation in steam reforming, $kmol_{CO_2}/(kg_{cat} \cdot h)$

r'_{CO_2} – rate of CO_2 disappearance in the reverse of water-gas-shift and methanation, $kmol_{CO_2}/(kg_{cat} \cdot h)$

7.4 SNG PRODUCTION – METHANATION REACTOR DESIGN

Due to its exothermic aspect, the Sabatier reaction is limited by the thermodynamic equilibrium. Therefore, lower operating temperatures are desirable in order to achieve high reactant conversions and higher methane selectivity as presented by [Sudiro et al. 2010], [Khorsand et al. 2007], [Lefebvre et al. 2015], [Bader et al. 2011], [Brooks et al. 2007] and [Kopyscinski 2010]. A main issue of the carbon dioxide methanation reactor is to prevent a thermodynamic limitation of the carbon dioxide conversion and catalyst sintering. Therefore, the design of the reactor is crucial for thermal control over the system. There are basically two types of reactors that have been considered for SNG production: two-phase fixed bed reactors and fluidized bed reactors [Kopyscinski et al. 2010]. Whatever reactor design is chosen, the generated heat of the methanation reaction has to be continuously removed from the reactor.

Fixed bed methanation reactors are state of the art concept for the SNG production. In this case, several methanation reactors are connected in series with intermediate gas cooling or recycle of product gas. Also, fluidized bed reactors possess good heat and mass transfer characteristics due to the continuous mixing of the catalyst and the reactants within the reactor, and have been implemented for methanation reactors in a few cases.

Table 7.2 offers an overview on methanation processes and Sabatier reactor systems developed from the 1950s to date:

Table 7.2 Selection of methanation process developments (1955-2013)

Process/ Company	Year	Stage of development	Reactor type	Process stages	Operation range		Feed
					T (°C)	P (bar)	
TREMP / Haldor Topsøe	1980	semi- commercial	FB	3	300-700	30	coal, petrol coke, biomass
HICOM / British Gas Corp.	1981	pilot	FB	4	230-640	25-70	coal
RMP / Ralph M. Parson Co.	1974	pilot	FB	4-6	315-780	1-70	coal, heavy fuel
SuperMeth, ConoMeth / Conoco	1979 / 1974	pilot / demo	FB	4/4	n.s.	80	coal
Hygas / Institute of Gas Technology	1955	pilot	FB	2	280-480	70	coal
Lurgi, Sasol / Lurgi GmbH	1974	commercial	FB	2	450	>18	coal
Linde / Linde AG	1979	semi- commercial	FB	2-3	300-750	20	n.s.
Bi-Gas / Bituminous Coal Res. Inc	1965	pilot	FL	1	400-530	86	coal
Comflux / Thysengas GmbH	1980 (2008)	commercial	FL	1	400-500	20-60	coal

FB: fixed bed, FL: fluidized bed, demo: demonstration plant, n.s.: not specified

According to Table 7.2, the well-known technologies for the production of SNG are TREMP™, CONOCO/BGC, HICOM, LINDE, LURGI, RMP and ICI/Koppers [Kopyscinski et al. 2010].

LURGI process, depicted in Figure. 7.1, includes two adiabatic fixed bed reactors with internal recycle. 90% effluent gas from the first reactor is recycled back to the reactor inlet, mixed with the reactants (fresh and recycled) to lower the temperature in the first reactor bed. According to [Kopyscinski et al. 2010], a high methane content of about 77.4% methane was reached.

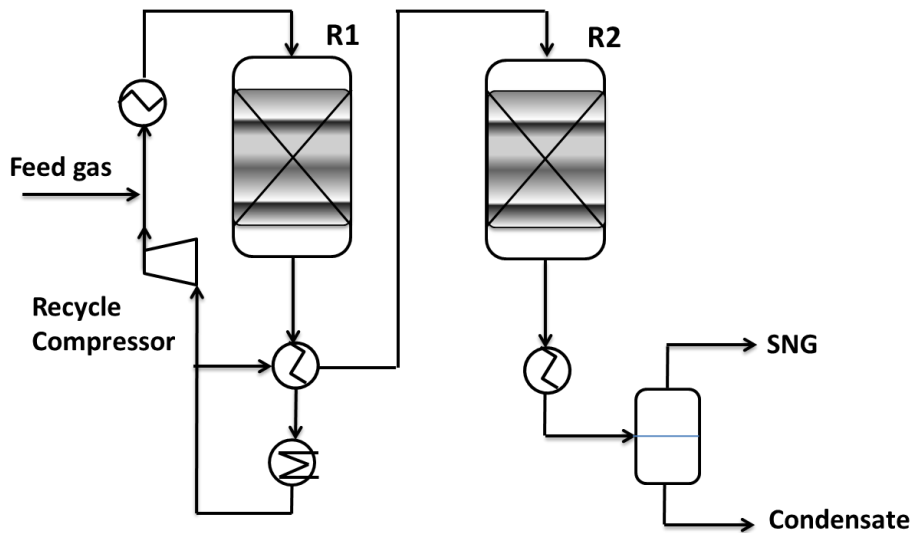

Figure 7.1 Lurgi process, adapted from [Kopyscinski et al. 2010]

An isothermal fixed bed reactor with indirect heat exchange was developed by LINDE in 1970. The proposed reactor is able to produce steam from the exothermic reactions and a part of this steam can be added to the reactor inlet in order to minimize the risk of carbon deposition (see Figure 7.2). However, no information about the temperatures, catalyst and the use of this type of reactor in SNG production are found.

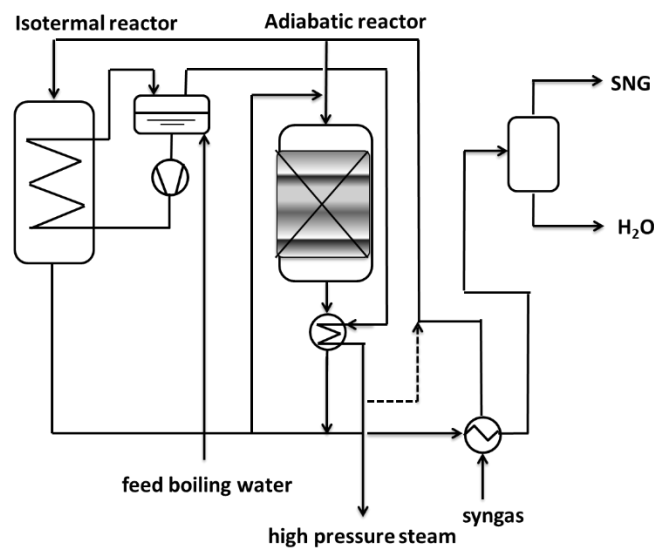

Figure 7.2 Linde process, adapted from [Kopyscinski et al. 2010]

Developed by Haldor Topsoe's laboratory, the TREMP™ process (Topsoe's Recycle Energy-efficient Methanation Process) consists of three adiabatic fixed bed reactors with gas recycling cooling and inter-stage gas cooling. The TREMP process allows reaction heat recovery in the most efficient manner by recovering the heat as high pressure steam (65 bar, 400 °C). 72% effluent gas from the first reactor is recycled back to the reactor inlet, mixed with the reactants (fresh and recycled) to lower the temperature in the first reactor bed. Also, due to the unique MCR-2X methanation catalyst, TREMP process can operate at high temperature. The product gas contains 94.4% methane.

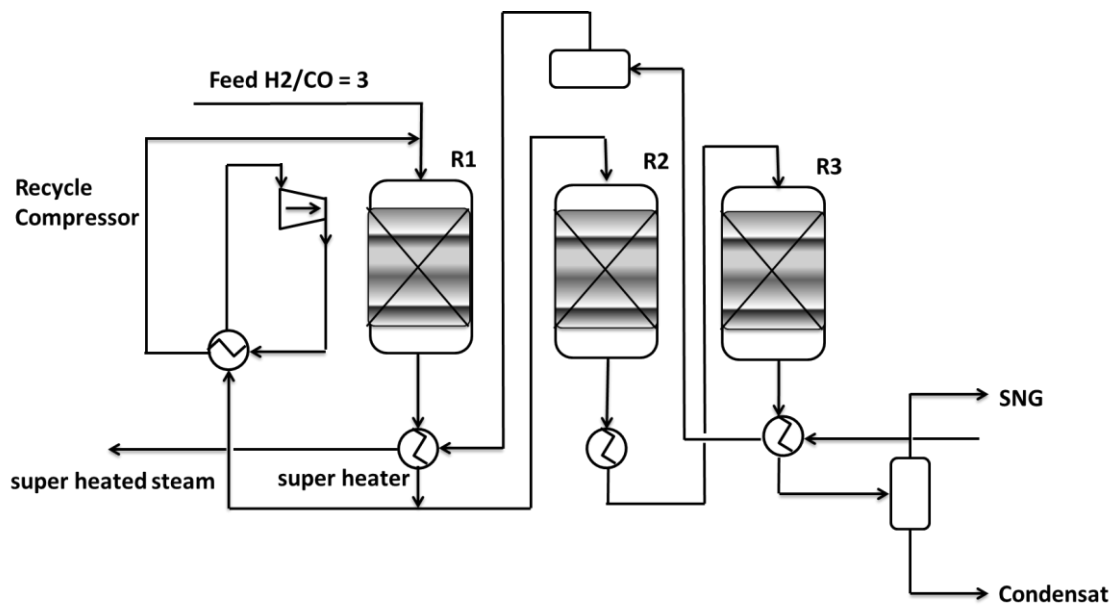

Figure 7.3 TREMP process, adapted from [Kopyscinski et al. 2010]

7.5 METHANATION PROCESS MODELING

Methane synthesis from carbon dioxide and hydrogen was considered, based on the TREMP-like process (Topsoe's Recycle Energy-efficient Methanation Process) developed by Haldor-Topsoe [Topsoe 2009], [Haldor Topsoe 2011]. This process was used to obtain the early substitute natural gas (SNG). Moreover, the operating conditions were determined in such way to maximize the methane selectivity and to ensure that maximum temperature allowed by the catalyst is not exceeded during adiabatic reactor operation. The conceptual design was evaluated by rigorous Aspen Plus simulations in order to predict the effect of the key design

parameters on the reaction temperature and purity of the synthetic natural gas product and to assess the current economic feasibility of the methanation process.

7.5.1 Physical properties

The physical properties (such critical parameters, enthalpy and Gibbs free energy of formation etc.) of all the components are available in the pure component database of Aspen Plus [Aspen Technology 2010]. As the process takes place in gas phase, at high pressure and temperature, only the non-ideal of the gas phase has to be taken into account.

Accordingly, Peng-Robinson equation of state was used as a suitable property model for the system. Note that reactions leading to carbon formation are neglected, as their extent is limited due to catalyst selectivity.

The simplified process flowsheet for carbon dioxide methanation depicted in Figure 7.4 includes one, two or more catalytic reactors, operated adiabatically, in which reactions described in Eq. (1-3) take place. The number of reactors depends on the methane yield. In each reactor, the process approaches the equilibrium conditions. As the process is exothermic, the reaction mixture is cooled after each reactor in order to allow further conversion increase. The stoichiometric ratio is $\text{CO}_2:\text{H}_2 = 1:4$ Eq. (1), but the reaction can be performed with an excess of either reactant.

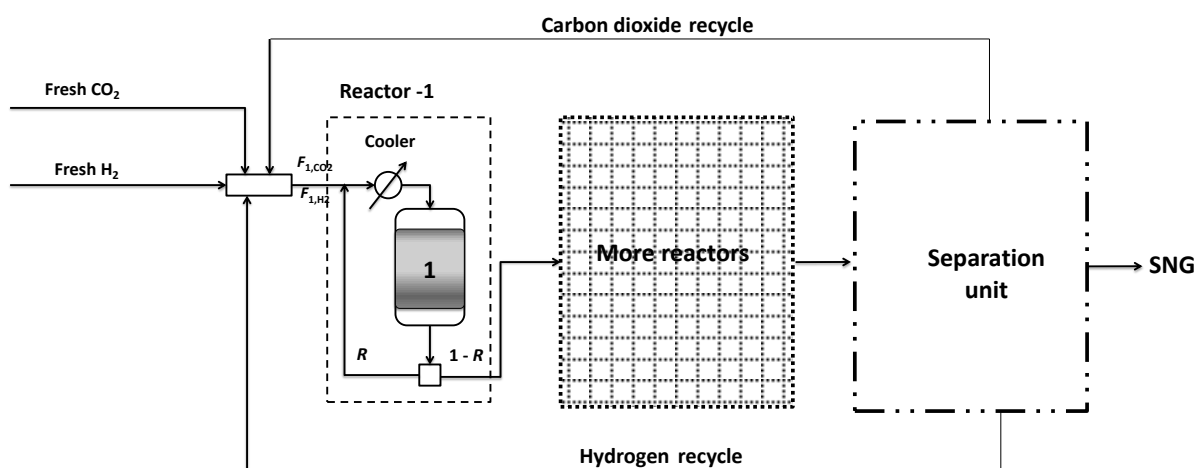

Figure 7.4 Schematic representation of carbon dioxide methanation process

The adiabatic reactors were simulated using Aspen Plus by means of the GIBBS model, which calculate the chemical equilibrium through minimization of the Gibbs free energy of the mixture. Carbon dioxide is mixed with hydrogen and the mixture is fed into first reactor. Due to the highly exothermic reaction, the first reactor has a special design: a part of the reactor effluent is recycled back to the reactor inlet, mixed with the reactants (fresh and recycled) and cooled to a suitable temperature (sufficiently high to initiate the reaction). Thus, this dilution effect leads to a lower temperature increase along the reactor bed. The two most important design parameters are the ratio between reactants at the inlet of the first reactor, $F_{1,CO_2} / F_{1,H_2}$ and the fraction of the reactor effluent that is recycled – R , where F_{1,CO_2} and F_{1,H_2} represents the molar flow rate of CO_2 and H_2 , kmol/h. The recycle ratio – R is defined as molar flow ratio between the recycled gas and the stream leaving the reactor bed.

For the present case, the plant inlet H_2 fresh flow was specified at 30 bar and 303 K, and corresponds to the nominal production of a 10 MW electrolyser unit (54 kmol/h H_2). In order to achieve flowsheet convergence a DESIGN SPECIFICATION unit was used to adjust the fresh CO_2 flow rate necessary to maintain the desired CO_2 / H_2 flow ratio at the inlet of the first reactor. As expected, the corresponding flow rate of fresh carbon dioxide (obtained as a result of simulation), 13 kmol/h (589 kg/h) at 30 bar and 303 K, was very close the stoichiometric value.

The Aspen Plus simulation ends with a sensitivity analysis that uses the reactor model to understand the effect of the reaction temperature, the reactants concentration and the recycle ratio on the maximum reactor temperature. The sensitivity analysis shows that the increase in the recycle ratio R leads to a decrease of the maximum temperature. Figure 7.5 presents the maximum temperature in the first reactor bed versus the reactants ratio $F_{1,CO_2} / F_{1,H_2}$, calculated for an inlet temperature of 573 K and various values of the recycle fraction R . The reaction pressure was set to 30 bar. According to the literature, high temperatures affect the catalyst stability. As expected, the sensitivity analysis (Figure 7.5) shows that the increase in the recycle ratio leads to a decrease of the maximum temperature.

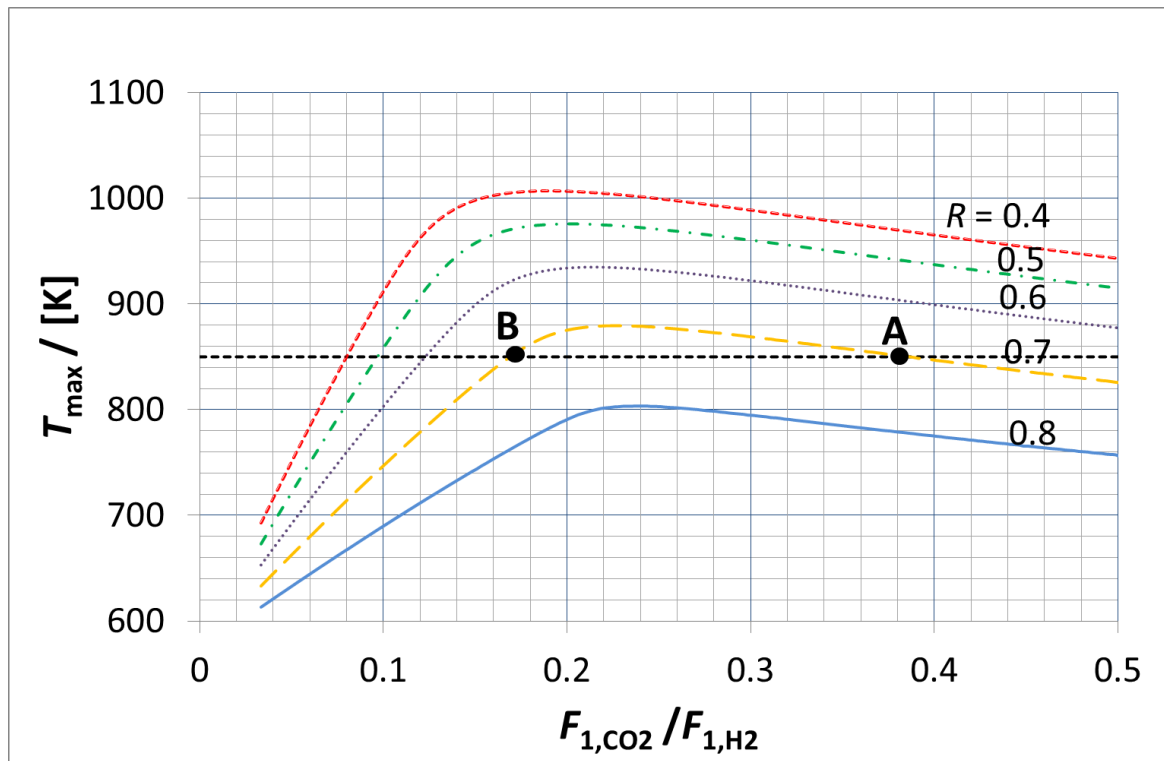

Figure 7.5 Maximum temperature of the first reactor bed versus the reactants ratio $F_{1,CO_2} / F_{1,H_2}$, at various values of the recycle fraction R

In order to obtain a high content of methane it is very important to define the recycle ratio and the carbon dioxide flow rate. Thus, the obtained results, presented in Table 7.3, indicate that at $R = 0.7$, the outlet temperature of the first reactor is 850K. Below this value of R , the high temperature could destroy the catalyst. Higher recycle leads to higher costs (large reactor, recycle compressor).

Moreover, Figure 7.5 shows that the same maximum temperature can be attained in two different ways. These two operating points, denoted by A and B (for $R=0.7$, at 850K) were considered for further investigation:

- Case A: involves a high conversion of hydrogen followed by carbon dioxide separation and recycle (excess of CO_2 - relatively to the stoichiometric ratio $CO_2/H_2 = 0.25$), Figure 4.
- Case B: involves a high conversion of carbon dioxide followed by hydrogen separation and recycle (excess of H_2 - relatively to the stoichiometric ratio $CO_2/H_2 = 0.25$).

Therefore, from an operation and control point of view, the preferred option is to design the system for almost complete conversion of one reactant (for example, hydrogen in case A), which can be achieved by an excess of the other reactant (for example, carbon dioxide in case

A). Case B leads to hydrogen separation and its recycle. H₂ separation membranes represent a potential pathway including high capital and operational costs, while CO₂ removal system using amines (case A) is considered to be a technically viable option.

Table 7.3 Effect of the recycle ratio on the gas composition and operating conditions at the outlet of the first methanation reactor and on the SNG composition

Stream	Recycle ratio				
	0.4	0.5	0.6	0.7	0.8
REACTOR-1 OUTLET					
Total molar flow (kmol/h)	102.067	119.744	145.827	171.106	277.041
Total mass flow (kg/h)	2160.25	2592.41	3240.33	3421.914	6480.63
Temperature (K)	943	915	877	850	756
Pressure (bar)	30	30	30	30	30
Composition (mole%)					
CO₂	22.21248	23.15986	24.11025	16.311	25.19671
H₂	18.01989	15.43705	12.23036	12.154	4.7775
CH₄	16.08042	17.59318	19.37452	22.911	23.0338
H₂O	37.92399	39.49834	41.51724	47.222	46.5317
CO	5.76321	4.31157	2.76762	1.402	0.460278
SNG PRODUCT					
Total molar flow (kmol/h)	14.123	13.957	13.836	13.848	13.728
Total mass flow (kg/h)	215.930	216.072	216.206	216.304	216.375
Temperature (K)	298	298	298	298	298
Pressure (bar)	30	30	30	30	30
Composition (mole%)					
CO₂	0	0	0	0	0
H₂	5.56537	4.128	3.04597	3.096	2.05821
CH₄	94.06404	95.582	96.71027	96.709	97.72919
H₂O	0.180112	0.18126	0.182104	0.189	0.182855
CO	0.190477	0.10873	0.061654	0.032	0.029742

Sensitivity analysis was performed in order to evaluate and predict the behavior of the plant when changing key operating and design variables. Hydrogen and carbon dioxide conversions

and the selectivity of the methane, based on the absolute flow rates of all components were calculated using user-supplied FORTRAN subroutine, as followed:

$$X_{CO_2} = 1 - \frac{CO_{2out}}{CO_{2in}} \quad (9)$$

$$X_{H_2} = 1 - \frac{H_{2out}}{H_{2in}} \quad (10)$$

$$SEL_{CH_4/CO_2} = \frac{CH_{4out}}{(CO_{2in} - CO_{2out})} \quad (11)$$

Typical plots of the CO₂ and H₂ conversions versus the flow rate of CO₂ at the inlet of first reactor ($F_{1,H_2} = 54$ kmol/h) are shown in Figure 7.6 and Figure 7.7. It should be noted that setting the CO₂ flow rate equal to the stoichiometric value $F_{1,CO_2} = 13$ kmol/h leads to conversions below 0.95, for both reactants. This results in CO₂ and H₂ concentrations in SNG which are above the maximum allowed threshold, separation of both reactants being thus necessary. Moreover, maintaining the ratio of fresh H₂:CO₂ flows to the required value 4:1 is difficult in practice, due to measurement and control implementation inaccuracies.

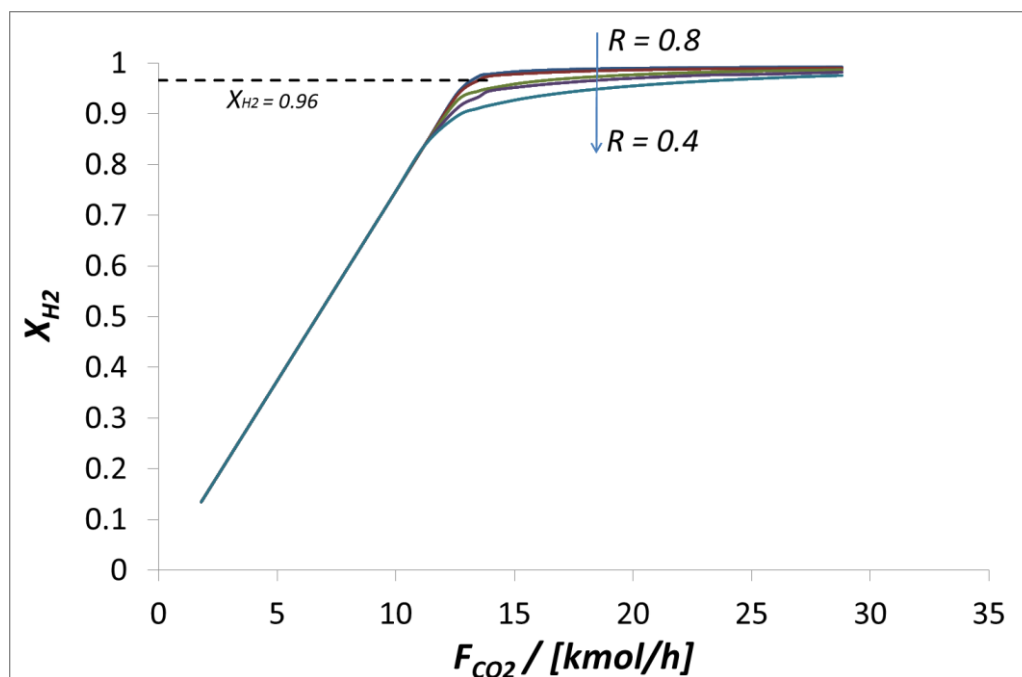

Figure 7.6 H₂ conversion versus first reactor-inlet carbon dioxide flow rate at different recycle ratio. $F_{1,H_2} = 54$ kmol/h (108 kg/h)

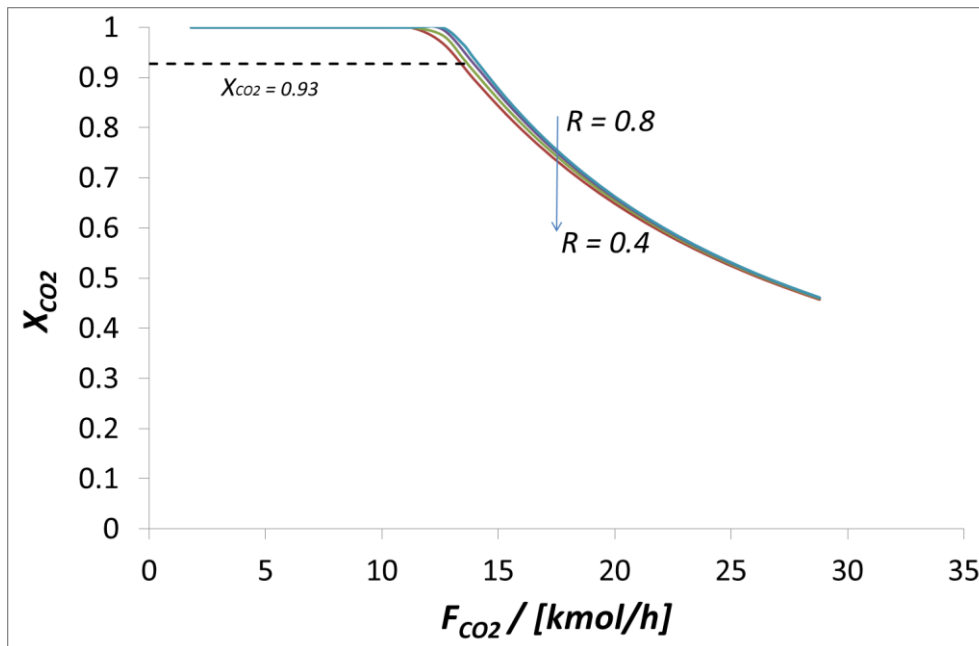

Figure 7.7 CO₂ conversion versus first reactor-inlet carbon dioxide flow rate at different recycle ratio. F₁,H₂ = 54 kmol/h (108 kg/h)

7.5.2 Conceptual design

Working at (or close to) the stoichiometric ratio does not ensure high conversion of both reactants, therefore, two separation units are needed (one for H₂ and one for CO₂). Thus, designing the plant for an excess of carbon dioxide is preferable, as this implies almost complete conversion of hydrogen, with the results of only one separation unit and only one recycle. After the first reactor, the reaction mixture is cooled before being sent to the second reactor (case A and B). The cooling – reaction sequence is repeated at the third reactor (case A). Finally, the reaction mixture is cooled to a temperature that is low enough to allow water condensation and therefore vapour – liquid separation (VL separation). The liquid phase collects water, as well as dissolved gases. The water produced in the process can be collected and reused. The heat exchangers HE-1, HE-2, HE-3, HE-4, HE-4A, HE-4B, provide steam at different pressure levels. The heat-exchangers were modelled as HEATER a unit, which allows estimation of the heat duty. Finally, the compressor model offered the energy required for CO₂ and H₂ pressure increase and recycle.

Figure 7.8 presents the Aspen Plus flowsheet for CO₂ methanation which implies the total separation of carbon dioxide from the products. In the present case, for the almost complete H₂ conversion, three catalytic reactors were used. The CO₂ separation was achieved by absorption

/ desorption using ethanol amine. The excess carbon dioxide is recycled to the first reactor via a compressor. Following CO₂ separation, SNG is obtained.

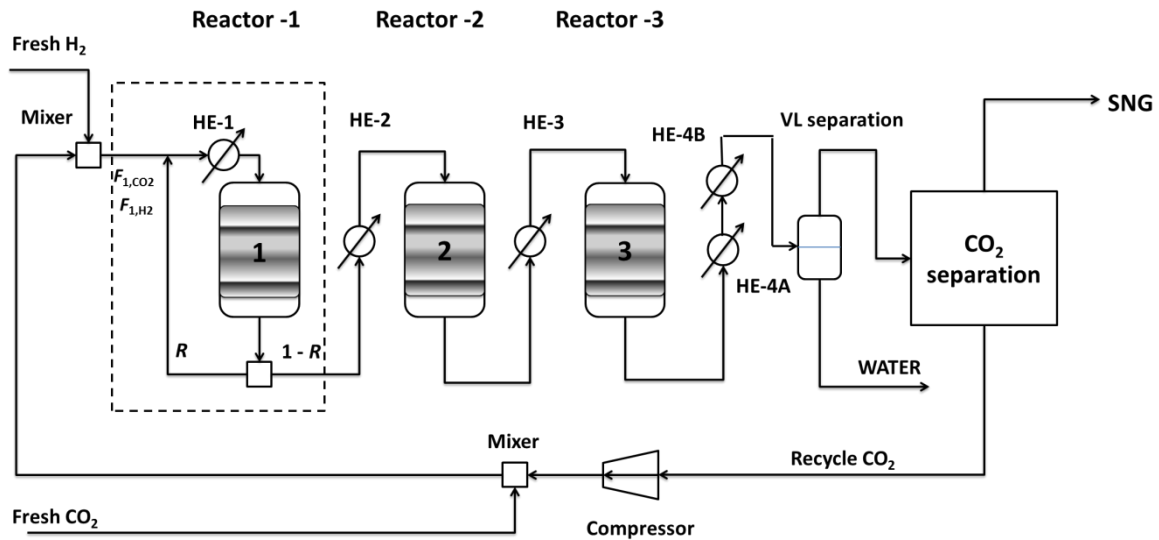

Figure 7.8 Flowsheet of CO₂ methanation process (CO₂ separation – recycle)

In order to obtain an in-depth overview, various simulations were performed using five different scenarios based on different hydrogen flow rates: 110.58 kg/h (55.425 kmol/h); 107.91 kg/h (53.955 kmol/h); 103.4 kg/h (51.7 kmol/h); 99.7 kg/h (49.85 kmol/h) and 77.83 kg/h (38.915 kmol/h) obtained for a 10 MW electrolysis unit, corresponding to the case studies further presented in the technical and economic evaluation of Power-to-Gas. The best results in terms of flow rate and high concentration of methane are provided by the base case (53.95 kmol/h fresh H₂). Tables 7.4 to 7.8 presents stream results for the reaction section obtained for different hydrogen flow rates.

Table 7.4 Stream results for the reaction section for 110.58 kg/h hydrogen (2030 Romanian case Power-to-Gas SNG using PEM electrolysis)

Property	H ₂ fresh	CO ₂ fresh	R1-IN	R1-OUT	R2-IN	R2-OUT	R3-IN	R3-OUT	SNG
Total molar flow (kmol/h)	53.29	13.7695	199.2886	175.1521	52.54563	49.76654	49.76654	49.15828	14.24039
Total mass flow (kmol/h)	110.58	605.858	3480.303	3480.303	1044.091	1044.091	1044.091	1044.091	222.2882
Temperature (K)	303	303	573	850.9427	573	698.2704	573	599.8708	298
Pressure (bar)	30	30	30	30	30	30	30	30	30
Composition (% mole)									
CO ₂	-	100	20.43885	15.94592	15.94592	15.41861	15.41861	15.08383	0
H ₂	100	-	35.45027	12.3555	12.3555	3.2513	3.2513	0.909955	3.14117
CH ₄	-	-	14.13047	22.96785	22.96785	27.04256	27.04256	27.99584	96.63958
H ₂ O	-	-	29.12068	47.33322	47.33322	54.18632	54.18632	56.00103	0.186979
CO	-	-	0.859738	1.39752	1.39752	0.101206	0.101206	0.00934644	0.0322641
CH ₄ molar flow (kmol/h)					13.76185				
CH ₄ mass flow (kg/h)					220.1896				
H _{recovery} (MWh)					0.878285908				

Table 7.5 Stream results for the reaction section for 107.91 kg/h hydrogen (2015 Romanian case Power-to-Gas SNG)

Property	H ₂ fresh	CO ₂ fresh	R1-IN	R1-OUT	R2-IN	R2-OUT	R3-IN	R3-OUT	SNG
Total molar flow (kmol/h)	53.955	13.7695	193.8895	170.4006	51.12019	48.4213	48.42123	47.82745	13.8533
Total mass flow (kmol/h)	107.91	589.51	3386.18	33866.18	1015.854	1015.854	1015.854	1015.854	216.2792
Temperature (K)	303	303	573	850.7939	573	698.3474	573	599.4992	298
Pressure (bar)	30	30	30	30	30	30	30	30	30
Composition (% mole)									
CO ₂	-	100	20.4394	15.94627	15.94627	15.41914	15.41914	15.0832	0
H ₂	100	-	35.44441	12.34293	12.34293	3.25404	3.25404	0.904844	3.12388
CH ₄	-	-	14.13339	22.97384	22.97384	27.04136	27.04136	27.99782	96.6572
H ₂ O	-	-	29.12479	47.34232	47.34232	54.18409	54.18409	56.00489	0.186989
CO	-	-	0.85801	1.39463	1.39463	0.10137	0.10137	0.00925	0.031933
CH ₄ molar flow (kmol/h)					13.39023				
CH ₄ mass flow (kg/h)					241.2437				
H _{recovery} (MWh)					0.854082657				

Table 7.6 Stream results for the reaction section for 103.4 kg/h hydrogen (French case Power-to-Gas SNG with BAM participation)

Property	H ₂ fresh	CO ₂ fresh	R1-IN	R1-OUT	R2-IN	R2-OUT	R3-IN	R3-OUT	SNG
Total molar flow (kmol/h)	49.85	12.9029	187.1722	164.5317	49.35952	46.77212	46.77212	46.20825	13.33715
Total mass flow (kmol/h)	103.4	567.7184	3283.403	3283.403	985.0208	985.0208	985.0208	985.0208	208.2828
Temperature (K)	303	303	573	850.1032	573	697.4596	573	599.0312	298
Pressure (bar)	30	30	30	30	30	30	30	30	30
Composition (% mole)									
CO ₂	-	100	20.64577	16.18721	16.18721	15.69065	15.69065	15.36486	0
H ₂	100	-	35.29813	12.21498	12.21498	3.20079	3.20079	0.892193	3.09109
CH ₄	-	-	14.11207	22.93424	22.93424	26.96891	26.96891	27.90814	96.68833
H ₂ O	-	-	29.08408	47.26603	47.26603	54.03874	54.03874	55.82554	0.188478
CO	-	-	0.859946	1.39754	1.39754	0.100913	0.100913	0.00926436	0.0320975
CH ₄ molar flow (kmol/h)					12.89547				
CH ₄ mass flow (kg/h)					206.32752				
H _{recovery} (MWh)					0.822637118				

Table 7.7 Stream results for the reaction section for 99.7 kg/h hydrogen (French case Power-to-Gas SNG without BAM participation)

Property	H ₂ fresh	CO ₂ fresh	R1-IN	R1-OUT	R2-IN	R2-OUT	R3-IN	R3-OUT	SNG
Total molar flow (kmol/h)	49.85	12.4049	179.5297	157.7824	47.33473	44.83679	44.83679	44.28548	12.83027
Total mass flow (kmol/h)	99.7	545.8156	3135.33	3135.33	940.5989	940.5989	940.5989	940.5989	200.276
Temperature (K)	303	303	573	850.856	573	698.6619	573	599.8862	298
Pressure (bar)	30	30	30	30	30	30	30	30	30
Composition (% mole)									
CO ₂	-	100	20.43953	15.94646	15.94646	15.42095	15.08445	20.43953	0
H ₂	100	-	35.44725	12.34809	12.34809	3.2653	0.910158	35.44725	3.14151
CH ₄	-	-	14.13459	22.97431	22.97431	27.03986	27.99891	14.13459	96.63923
H ₂ O	-	-	29.11978	47.33518	47.33518	54.17184	55.99713	29.11978	0.186974
CO	-	-	0.858858	1.39595	1.39595	0.102047	0.00935135	0.858858	0.0322774
CH ₄ molar flow (kmol/h)					12.39907				
CH ₄ mass flow (kg/h)					198.38512				
H _{recovery} (MWh)					0.791261632				

Table 7.8 Stream results for the reaction section for 77.83 kg/h hydrogen (2030 Romania case Power-to-Gas SNG using alkaline electrolysis)

Property	H ₂ fresh	CO ₂ fresh	R1-IN	R1-OUT	R2-IN	R2-OUT	R3-IN	R3-OUT	SNG
Total molar flow (kmol/h)	38.915	9.767	140.0374	123.0758	36.92274	34.97274	34.97274	34.54269	10.0057
Total mass flow (kmol/h)	77.83	425.744	2445.601	2445.601	733.6803	733.6803	733.6803	733.6803	156.2024
Temperature (K)	303	303	573	850.9014	573	698.5671	573	599.6142	298
Pressure (bar)	30	30	30	30	30	30	30	30	30
Composition (% mole)									
CO ₂	-	100	20.43914	15.94615	15.94615	15.42016	15.42016	15.08348	0
H ₂	100	-	35.4486	12.35197	12.35197	3.26192	3.26192	0.906422	3.12922
CH ₄	-	-	14.13126	22.96947	22.96947	27.03808	27.03808	27.99718	96.65176
H ₂ O	-	-	29.12176	47.33568	47.33568	54.178	54.178	56.00364	0.186986
CO	-	-	0.859239	1.39672	1.39672	0.101837	0.101837	0.0092795	0.0320355
CH ₄ molar flow (kmol/h)					9.670682				
CH ₄ mass flow (kg/h)					154.730912				
H _{recovery} (MWh)					0.617130632				

A preliminary study on the industrial methane production process configuration was carried out in order to obtain the quantity of early synthetic natural gas for further parametric sensitivity study. The chemical equilibrium assumes that the reaction has enough time to reach the equilibrium and it does not take any kinetics into account. The mass balance was calculated based on the input parameters such as temperature, pressure and composition. The end product of the pathway consists in SNG with a concentration, fully compatible with the natural gas grid. The steady state results of the simulation are in agreement with the experimental observations available in literature.

8 LEVERAGING POWER-TO-GAS IN THE ROMANIAN CASE

8.1 CONTEXT IDENTIFICATION

The current context of the Romanian energy system offers the subject for the main business case of the thesis, as the most important motivation behind it was studying the conditions in which Power-to-Gas can be leveraged at national level. As presented in the previous chapters, Romania currently represents a textbook scenario for Power-to-Gas deployment, with huge investments made in renewable energy over the last years that have led to a large share of renewables in the country's energy mix [Departamentul pentru Energie 2014].

Instead of studying the potential of implementing Power-to-Gas from a holistic perspective, at national or regional energy system level, the thesis focuses on an investor's point of view. In our case, the investor in Power-to-Gas is the same entity that operates the wind park responsible for producing the input renewable energy and the investment in the new technology is regarded as a possibility of potentially improving its economic performance. Given this context, this chapter will focus less on the technical benefits of the Power-to-Gas technology, since these are difficult to take into consideration when not deploying the technical concept at the level of the whole energy system, but rather on the economic indicators which are relevant for deciding upon an investment.

8.2 PERIMETER DEFINITION AND DATA INPUT

Two time frames are going to be included in the technical and economic evaluation of the Romanian case: 2015 and 2030. Technology roadmaps indicate that the next 15 years will come with significant changes in terms of technology availability, efficiency and most importantly cost regarding the key components of the Power-to-Gas technological chain. Consequently, the

2015 scenario will feature currently available technology, while 2030 will also analyze technologies that are expected to achieve large scale commercial maturity by then:

- 2015: Power-to-Gas Hydrogen and Power-to-Gas SNG using alkaline electrolyzers
- 2030: Power-to-Gas Hydrogen and Power-to-Gas SNG using alkaline and PEM electrolyzers

The evaluation starts from the energy production of a real wind park situated in Dobrogea, a region in the South-East part of the country. The actual energy production of the wind park between December 2012 and November 2013 was the essential input data for the current study, as shown in Figure 8.1. During this period, the total energy production of the wind park was 122825 MWh. Figure 8.2 presents the energy prices from the Romanian Day-Ahead Market (DAM) for the same period of time. Measured data was only available for one year since the wind park was a new investment.

The lifetime of the studied Power-to-Gas project was set to 20 years, since this is usually the minimum lifetime of the key component, the electrolysis unit [Bertuccioli et al. 2014]. However, measured data was only available for one year since the wind park was a new investment, therefore the input dataset was replicated for 20 years, as well as the DAM prices.

Dobrogea, the region taken into consideration for this study, represents a textbook scenario for the deployment of Power-to-Gas. Significant investments in wind energy production capabilities were made in this region, while investments in the electricity transport infrastructure lagged behind. In the same time, the natural gas grid from this region is well developed and the industrial actors present in the area offer a wide area of synergies and integration options: natural gas power plants, cement and steel industry, a nuclear power plant. The natural gas power plants and the cement industry are considered to be a potential source of carbon dioxide for the Power-to-Gas SNG pathway.

The scope of the current study however focuses only marginally on secondary resource integration, therefore only a brief discussion of the possible synergies is going to be presented.

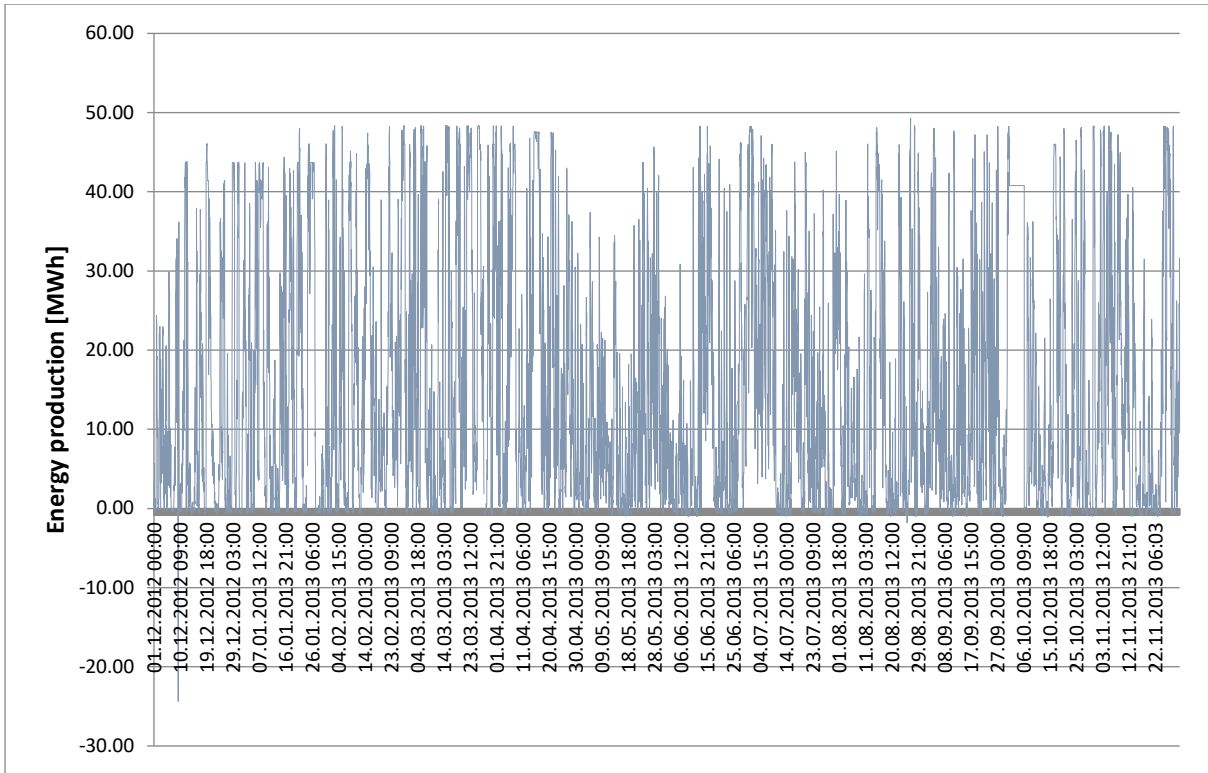

Figure 8.1 Energy production of the wind park (Romanian case)

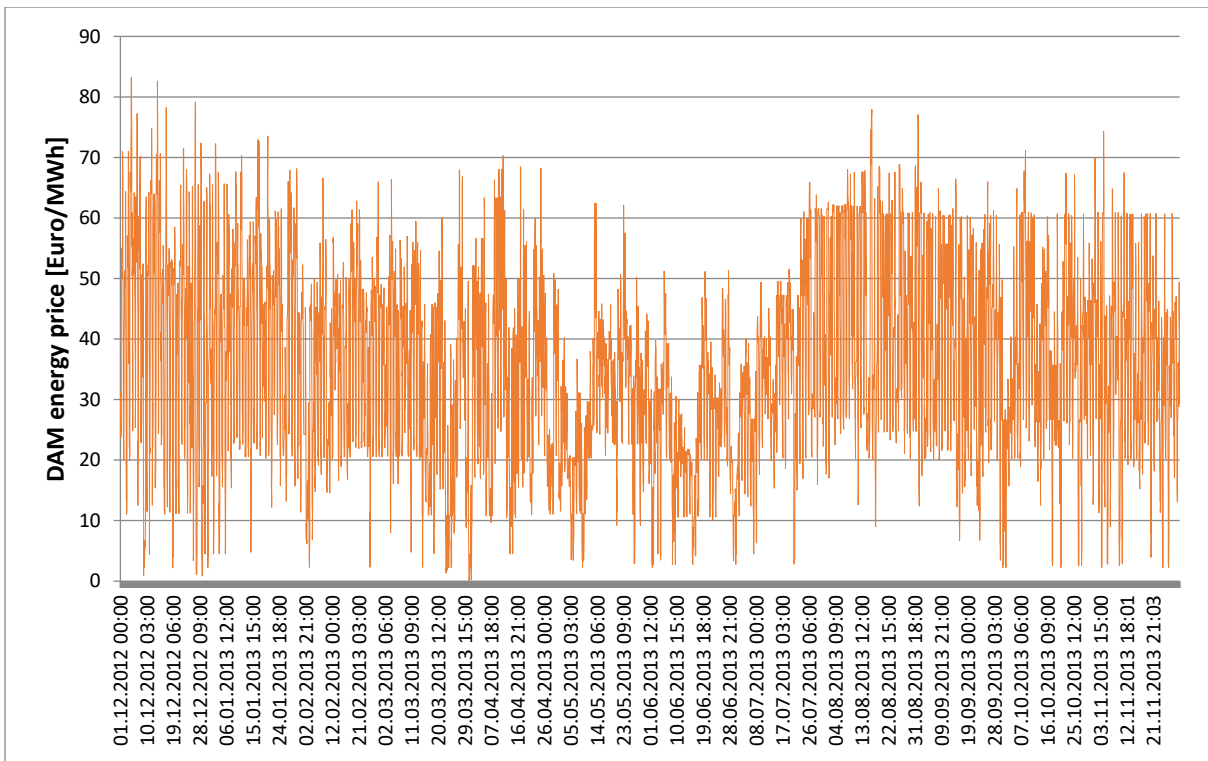

Figure 8.2 Day-Ahead Market (DAM) energy prices (Romanian Case)

Table 8.1 Economic assumptions for the Romanian case

	Value	Unit	Reference
Project lifetime	20	Years	
Discount rate	10	%	[GDF Suez Energy Romania 2015]
Inflation rate	2	%	
Insurance	4% of CAPEX	Euro/year	[Omnicasig 2014]
Contingencies	5	%	[GDF Suez Energy Romania 2013a]
Income tax	16	%	
Natural gas price	19.65	Euro/MWh	[GDF Suez Energy Romania 2013b]
Oxygen price	0.03	Euro/kg	[Agerborg & Lingehed 2013]
Residual heat price	40	Euro/MWh	[RADET 2013]

Table 8.1 presents the relevant input economic indicators for the Romanian case that have been identified. Aspects and costs associated to resource transport are not taken into consideration for the technical and economic assessment of the Romanian case since one of the main assumptions is the co-localization of all the resources, resulting in a “best-case scenario” type of study from this point of view. A similar way of thinking leads to the assumption that electricity and natural gas transport fees are not taken in the scope of the current study.

Concerning policy and legislation, at the moment Romania does not have a support scheme for renewable hydrogen or renewable SNG. In this situation, the study will shift the uncertainties related to this aspect towards the end-point of the analysis, where the required level of incentives for achieving profitability will be established. On the other hand, Romanian authorities have put in place a support scheme for renewable energy that applies to the energy production of the wind park [RES-Legal 2014]. However, we consider that the entity that operates the wind park is the same entity that is investing in Power-to-Gas technology. The price paid for green certificates awarded to the renewable energy producer (wind park) is supported by the renewable energy consumer (Power-to-Gas), thus negating their effect on the current study, considering the fact that trading fees and taxes are ignored.

8.3 TECHNICAL SIZING

In order to establish the sizing of the two Power-to-Gas pathways taken into consideration for the Romanian case, it is important to decide the amount of energy redirected from the wind park's total energy production to the electrolysis units that are part of the Power-to-Gas chain.

Respecting the guidelines of the Power-to-Gas analysis framework presented in the previous chapter, several price thresholds for the electricity sold on the day-ahead market are imposed: 20, 30, 40, 50, 60 and 70 Euro/MWh. The operating strategy is the following:

- All the electricity produced by the wind park and priced below the imposed price threshold is redirected to the Power-to-Gas facilities
- The energy priced above the imposed threshold is sold on the energy market and injected into the grid.

For the Romanian case, additional sub-scenarios are created by analyzing different sizes for the electrolysis units: 10, 20, 30, 40 and 50 MW. In conjunction with the scenarios created by imposing the energy price thresholds, this strategy leads to a total of 30 scenarios that have to be simulated and evaluated for each Power-to-Gas pathway, Hydrogen and SNG in the high-level technical and economic analysis.

The Power-to-Gas projects are modelled in ODYSSEY, a software developed by CEA Liten for evaluating energy storage applications [Guinot et al. 2013], as presented in Figure 8.3. Using ODYSSEY, the amount of energy supplied to the electrolysis units based on the previously presented strategy is calculated, as well as the process parameters of the electrolysis process: input energy and water, output hydrogen and oxygen. In order to simulate the behavior of the electrolysis units, these are modelled in ODYSSEY based on the key performance indicators presented in Table 8.2. Once the hydrogen output of the electrolysis units is calculated, the scenarios have to be compared on the basis of a technical and economic indicator that would indicate the optimum scenario in terms of electrolysis unit sizing and operating strategy.

Table 8.2 Key performance indicators of the electrolysis process used for the high-level technical and economic simulation

	Value	Unit	Reference
Technology	Alkaline		[Bertuccioli et al. 2014]
Electricity input	53	kWh _{el} /kgH ₂	
LHV efficiency	62	%	
Minimum load	20	% of full load	
H₂ output pressure	30	bar	
Operating temperature	70	Celsius	
Availability	8585	Hours/year	
CAPEX	900	Euro/kW	
OPEX	2.2% of CAPEX	Euro/year	

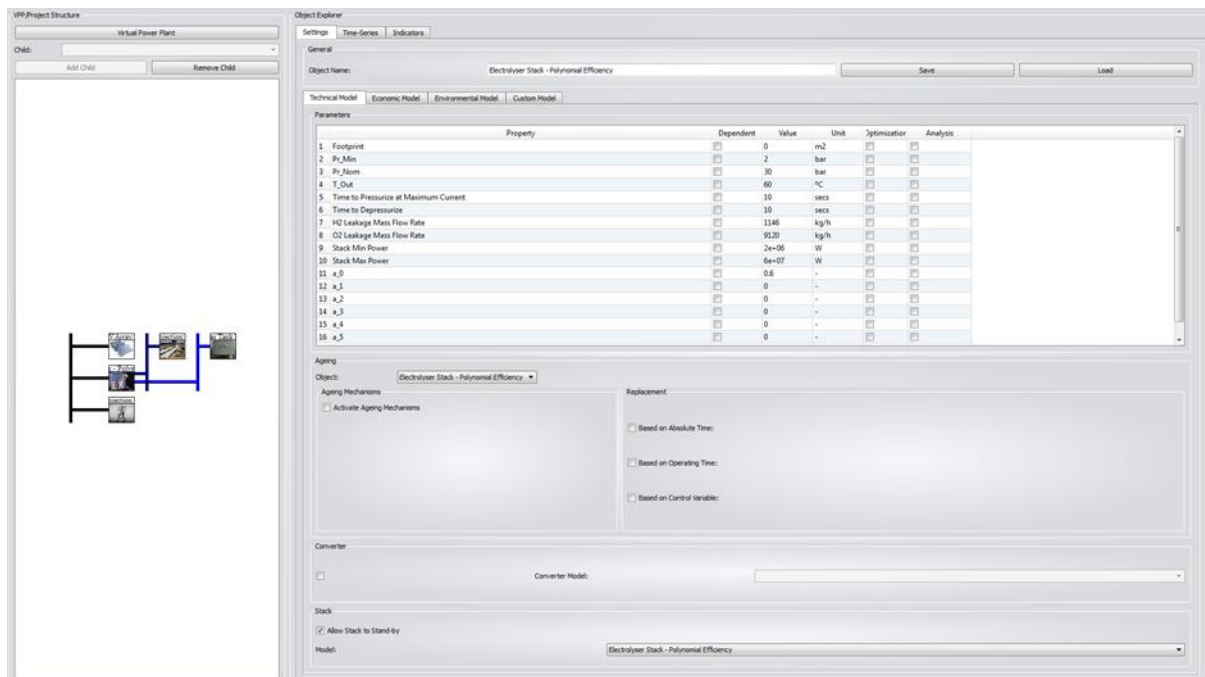

Figure 8.3 Creation of the Power-to-Gas project using ODYSSEY

The indicator that was chosen to represent the basis of comparison between all the previously defined scenarios is the Levelized Cost of Energy (LCOE), as defined by [Kost et al. 2013] and calculated using the following formula:

$$LCOE = \frac{CAPEX + \sum_{t=1}^n \frac{OPEX + Energy\ cost}{(1+i)^t}}{\sum_{t=1}^n \frac{Energy\ quantity}{(1+i)^t}} \text{ [Euro/MWh]}$$

CAPEX represents the sum of all the capital costs of the Power-to-Gas installation, while *OPEX* represents the operational costs, exclusive of the costs of energy. The *Energy cost* represents the annual cost of the energy that is fed to the Power-to-Gas process, *n* is the lifetime of the project, while *i* represents the discount rate taken into consideration. The *Energy quantity* parameter represents the total amount of energy that comes out of the Power-to-Gas process, expressed in MWh and is used by multiplying the output flow of hydrogen with the HHV energy content of hydrogen (39.4 kWh/kg) [Bertuccioli et al. 2014]. For calculating the LCOE indicator and therefore for the high-level analysis/technical sizing, the economic value of secondary resources (oxygen produced by the electrolysis process and residual heat of the methanation process) was not taken into account.

LCOE allows the comparison of different Power-to-Gas sizes and cost structures by putting together the sum of all the accumulated costs for building and operating facility and dividing this figure to the total energy generation on the basis of the net present value method. Using this method, the expenses and incomes over the project's lifetime are calculated based on discounting from the same reference date. The energy generation is as well discounted because it corresponds to the income generated by selling this amount of energy in the future, meaning that farther incomes have lower cash value.

The optimum scenario is the one that provides the lowest LCOE. For calculating the LCOE indicator for Power-to-Gas SNG pathway, the key performance indicators of the hydrogen storage components and of the methanation reactor have to be considered (Table 8.3).

Table 8.3 Key performance indicators for hydrogen storage and methanation reactor

	Value	Unit	Reference
Hydrogen Storage in pressurized steel reservoirs			
Storage capacity	48	hours	
CAPEX	470	Euro/kgH ₂	[ADEME 2014]
Methanation			
Technology	TREMP		[Topsoe 2009]
CAPEX	950	Euro/kW	[DNV KEMA Energy & Sustainability 2013]
OPEX	10% of CAPEX	Euro/year	

The results of the high-level analysis/technical sizing of the Power-to-Gas Hydrogen pathway are presented in Table 8.4 and Figure 8.4:

Table 8.4 LCOE of the Power-to-Gas Hydrogen pathway

		Energy price thresholds [Euro]					
Electrolyser size		20	30	40	50	60	70
LCOE [Euro/MWh]	10 MW	444.36	101.62	86.94	80.80	80.41	79.95
	20 MW	214.94	113.88	96.23	87.85	86.90	86.97
	30 MW	244.69	129.18	107.59	96.51	94.90	94.58
	40 MW	281.04	146.65	120.63	106.51	104.16	103.43
	50 MW	332.06	169.86	137.74	119.60	116.28	115.03

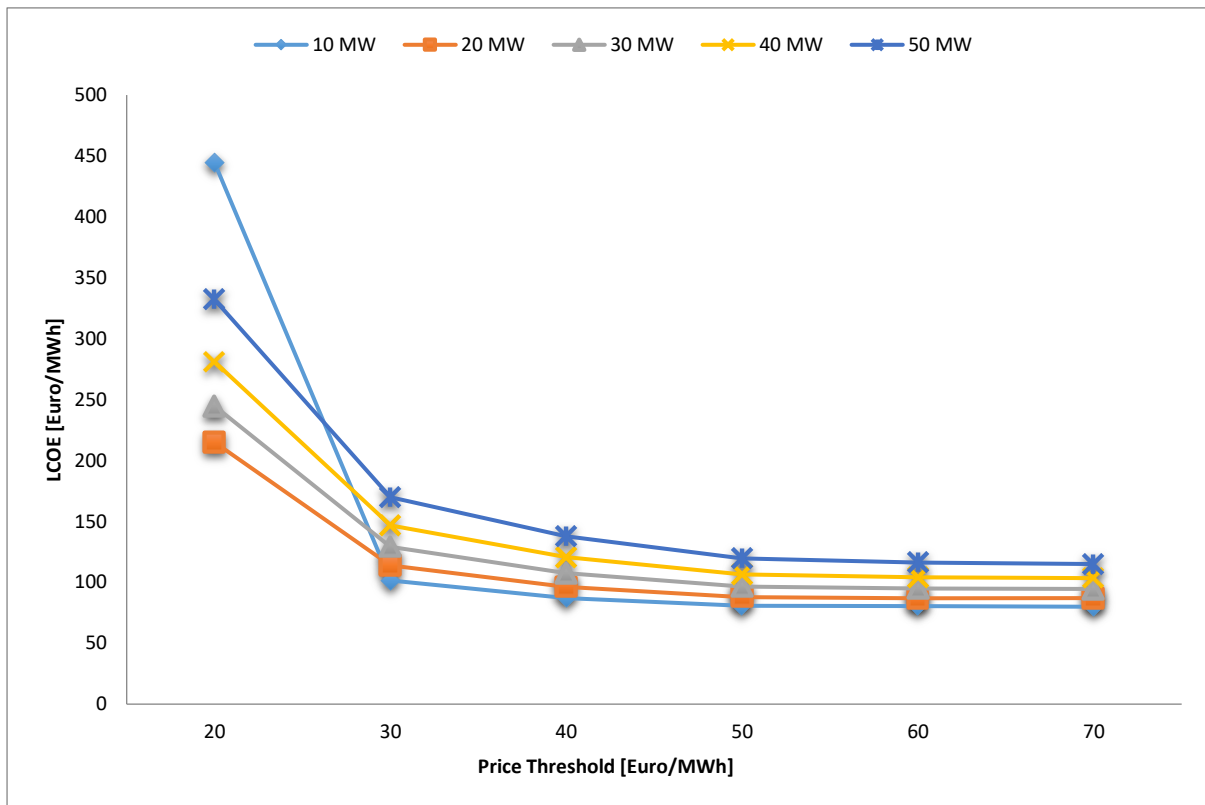

Figure 8.4 Levelized Cost of Energy depending on different energy market price threshold values in the Power-to-Gas Hydrogen pathway

The results of the high-level analysis/technical sizing of the Power-to-Gas SNG pathway are presented in Table 8.5 and Figure 8.5:

Table 8.5 LCOE of the Power-to-Gas SNG pathway

		Energy price thresholds [Euro]					
Electrolyser size		20	30	40	50	60	70
LCOE [Euro/MWh]	10 MW	647.14	163.39	140.53	130.05	129.54	127.71
	20 MW	319.67	173.15	147.67	134.26	133.04	133.13
	30 MW	352.22	193.06	162.46	144.32	142.21	140.55
	40 MW	397.10	214.58	176.96	157.33	153.02	152.07
	50 MW	463.53	244.80	198.00	173.14	168.82	167.19

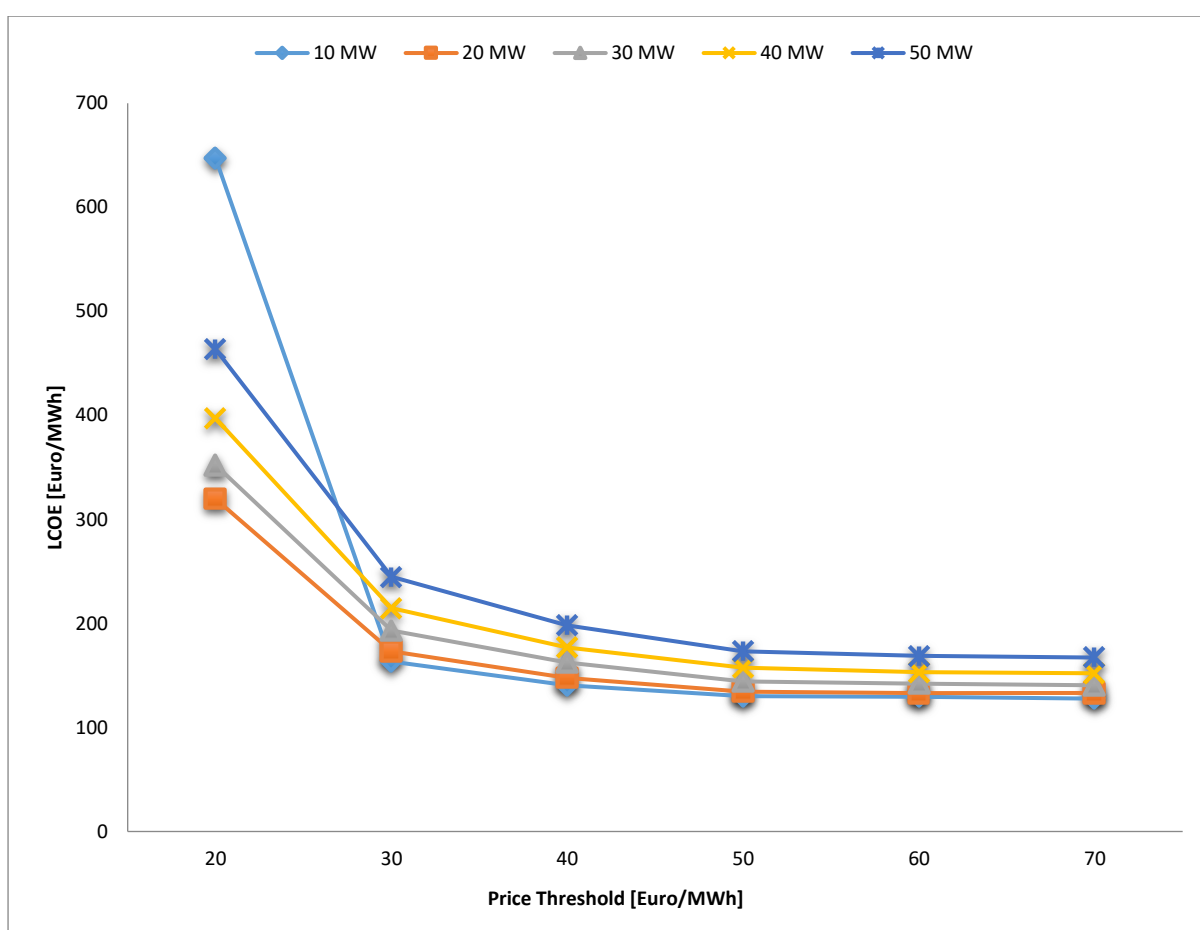

Figure 8.5 Levelized Cost of Energy depending on different energy market price threshold values in the Power-to-Gas SNG pathway

The irregular behavior that can be observed for the 20 Euro/MWh price threshold can be explained by the paradoxical situation when usually the wind park has a significant production but the low installed capacity of the electrolyzers cannot take in all the available energy, while throughout the whole year, the overall load factor is low. In this situation, the renewable

hydrogen or renewable methane production cannot compensate for the high CAPEX and OPEX costs of the Power-to-Gas process.

Table 8.4 and 8.5 along with Figure 8.4 and 8.5 indicate the optimum sizing and operation strategy scenarios:

- Power-to-Gas Hydrogen – out of the considered scenarios, the most economically efficient solution is to have a 10 MW installed capacity electrolysis plant that would operate on a 70 Euro/MWh price threshold, translating into a LCOE of 79.95 Euro/MWh of renewable hydrogen injected into the natural gas grid. This scenario will be used as the reference sizing for the Hydrogen pathway.
- Power-to-Gas SNG – for this pathway the most feasible economic sub scenario is again the 10 MW installed capacity electrolyser and 70 Euro/MWh electric energy price thresholds that results in a LCOE of 127.71 Euro/MWh of renewable SNG. This scenario will be used as the reference sizing for the SNG pathway.

For both of the previously mentioned pathways the optimum scenario consists in using a 10 MW electrolysis unit with a 70 Euro/MWh price threshold, leading to an average hourly hydrogen production of the electrolysis plant of 107.9 kg H₂/h at 30 bar, a figure used for sizing the methanation process in the Power-to-Gas SNG pathway. Going beyond the 70 Euro/MWh price threshold does not lead to a lower LCOE since less than 0.5 % of the wind park's energy production is priced above this value. In the optimum scenario, the capacity factor of the electrolysis units tops up at a level of 70.92%

The results of the technical sizing can be explained by the high initial capital investment costs of the components of the Power-to-Gas technology, especially electrolysis and methanation, and the fact that in order to amortize these costs on a per MWh basis, the production facilities need to operate for as long as possible, meaning that they need to be fed as much energy from renewable sources as possible and in this case they are not running anymore on what it is usually called “surplus” electricity.

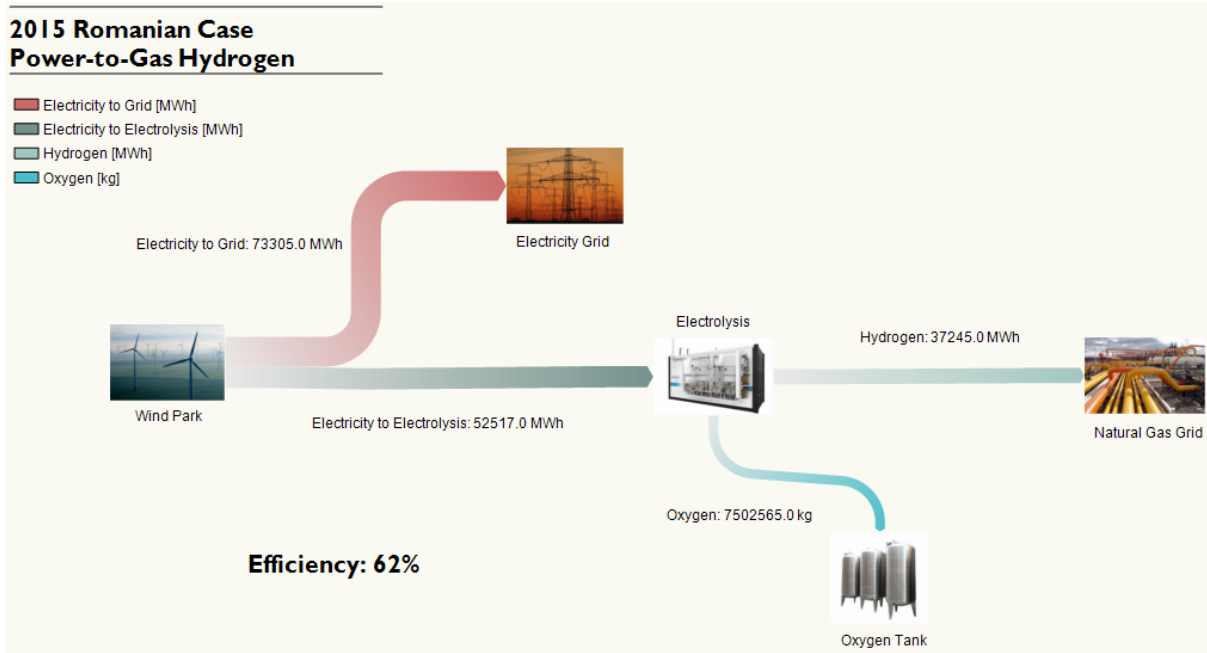

Figure 8.6 Energy balance of Power-to-Gas Hydrogen in the Romanian Case

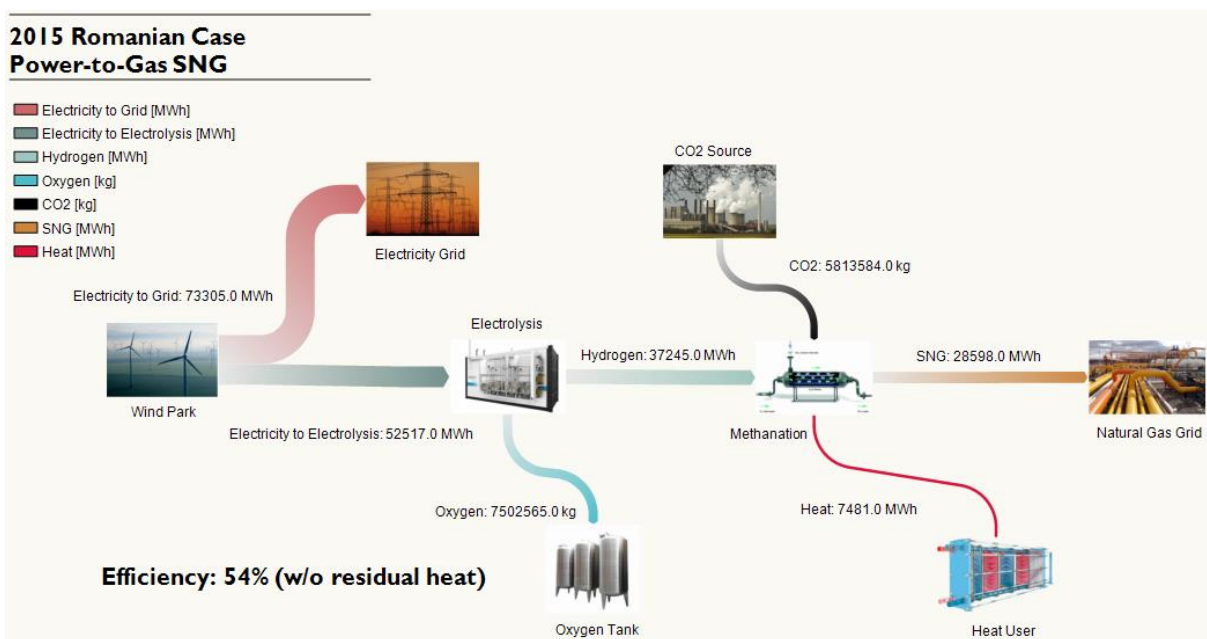

Figure 8.7 Energy balance of Power-to-Gas SNG in the Romanian Case

The figures presented above depict a graphic overview of the energy balance that results from the technical sizing of the two selected Power-to-Gas scenarios for the Romanian Case, revealing the main energy and material flows that are going to be used in the economic analysis. Also, it is important to underline the overall calculated efficiency of the Power-to-Gas Hydrogen scenario of 62% and the lower efficiency (due to additional energy transformations) of Power-to-Gas SNG of 54% if residual heat is not taken into consideration. However, if residual heat from the methanation process is taken into account when calculating efficiency,

Power-to-Gas SNG has a higher efficiency (68%) compared to Power-to-Gas Hydrogen, at least for the perimeter taken into account in the Thesis, where CO₂ capture is not included.

8.4 ECONOMIC ANALYSIS OF THE CURRENT ROMANIAN CASE

According to [Kost et al. 2013], an analysis method relying on LCOE is not suitable for establishing the cost efficiency of a Power-to-Gas project, therefore a thorough economic analysis has to be performed using a Discounted Cash Flow (DCF) valuation model that takes into account all the revenues and expenses streams for the whole duration of the project. Basically, a Discounted Cash Flow analysis is using future free cash flow projections to which a discount rate is applied in order to bring them to a present value. This approach offers information about the investment potential or the attractiveness of an investment opportunity. [Investopedia n.d.]. According to [Damodaran n.d.], the basic formula used for a DCF valuation is the following:

$$Value = \sum_{t=1}^n \frac{CF_t}{(1+r)^t}$$

Where

n – represents the life of the asset

CF_t - represents the cashflow in period t

r – represents the discount rate that reflects the risk (or financial return requirements) associated with the estimated cashflow

Based on a communication with [GDF Suez Energy Romania 2013a], a *simplified* Discounted Cash Flow valuation model was developed in order to perform the economic analysis of the two selected scenarios for leveraging Power-to-Gas in the Romanian case.

8.4.1 Power-to-Gas Hydrogen

The first step of the DCF analysis consists in gathering all the necessary input data for the selected scenario (Table 8.6). Output related data is imported from the ODYSSEY simulation

performed in the high-level analysis/technical sizing stage. Based on the number of hours the electrolyser is used yearly, the total number of operating hours is calculated during the whole lifetime of the project. This amount is divided by the electrolyser stack lifetime in order to obtain the number of required stack replacements and the first year of replacement.

Table 8.6 Romanian Case 2015 Power-to-Gas Hydrogen inputs

Project type		Power-to-Gas Hydrogen Injection	
Year		2015	
Project size		10 MW	
Threshold		70 Euro/MWh	
Project lifetime		20 years	
Category	Value	Unit	Reference
CAPEX			
Electrolysis	900	Euro/kW	[Bertuccioli et al. 2014]
OPEX			
Electrolysis	2.2	% of CAPEX/year	[Bertuccioli et al. 2014]
Outputs			
Hydrogen	107.9	kg/h	
Hydrogen (yearly energy output)	37245.2	MWh/year	
Oxygen	856.4	kg/h	
Oxygen (yearly output)	750256 5	kg/year	
Economic indicators			
Natural gas price	19.65	Euro/MWh	[GDF Suez Energy Romania 2013b]
Oxygen price	0.03	Euro/kg	[Agerborg & Lingehed 2013]
Discount rate	10	%	[GDF Suez Energy Romania 2015]
Inflation rate	2	%	
Insurance	0.4	% of CAPEX/year	[Omniasig 2014]
Income tax	16	%	
Technical indicators			
Electrolyser hours per year	6213	hours	
Electrolysis hour during lifetime	12460	hours	
Electrolyser capacity factor	70.92	%	

Electrolyser stack lifetime	65000	hours	[Bertuccioli et al. 2014]
Stack replacements	1		
First year of replacement	10		
Stack replacement cost	50	% of CAPEX of the electrolysis unit	[Bertuccioli et al. 2014]

The following step consists in establishing the required initial investment, by summing up the CAPEX costs of all the required investments (Table 8.7). Additional equipment is required for injecting the hydrogen that results from the electrolysis units into the existing natural gas distribution infrastructure: an injection station and the connection. The cost of this investment is calculated using information from [ADEME 2014]. The same study indicates that there is an operational cost of 2% (connection) and respectively 8% (injection station) of the CAPEX cost per year associated to this infrastructure.

Table 8.7 2015 Romanian Case Power-to-Gas Hydrogen initial investment

Investment	CAPEX
Electrolysis	
Electrolysis plant	€ 9,000,000
Natural gas grid connection	
Connection	€ 130,000
Injection station	€ 600,000
Total	
Total Investment	€ 9,730,000

After calculating the total investment cost of the project, the total sum is divided by the lifetime of the project in order to calculate the depreciation expense per year (Table 8.8). The Depreciation Expense is constant throughout the project's lifetime, therefore Table 8.8 only covers the first and last two years of the project.

Table 8.8 2015 Romanian Case Power-to-Gas Hydrogen CAPEX & Depreciation

Depreciable Assets	€ 9,730,000	Euro			
Depreciation Period	20	years			
	2016	2017	...	2034	2035
	1	2	...	19	20
Depreciation Expense	€ 486,500	€ 486,500	...	€ 486,500	€ 486,500
CAPEX	€ 9,730,000	Euro			

The following step is the most important part of the DCF model, calculating the Profit & Losses (Table 8.9). Revenue streams are calculated on a yearly basis and in the 2015 Romanian case Hydrogen pathway they consist of the following:

- Injected hydrogen – the hydrogen produced by the electrolysis process is injected in the natural gas grid and valued at the price of natural gas (see Table 8.6).
- Oxygen – oxygen represents a byproduct of the electrolysis process and it can be valued for approximately 0.03 Euro/kg, price that includes all the necessary costs for bottling and transport.

The expense streams are calculated on a similar manner:

- Electric energy – the price paid for the energy fed to the electrolysis units represents the most important expense of the project. It is calculated by multiplying the amount of energy fed to the electrolyzers by the associated DAM energy price.
- Stack replacement – after the electrolysis unit reaches the end of its lifetime, the stack needs to be replaced, incurring a significant cost to the project (Table 8.6).
- OPEX – the operational costs for the electrolysis units (as presented in Table 8.6), as well as the previously mentioned ones for the elements of the Hydrogen Injection components.
- Insurance – insurance related costs are evaluated at 0.4% of CAPEX for every year, covering the electrolysis unit.
- Contingencies – a 5% of the total yearly expenses is assumed to cover unforeseen costs that usually appear during the operation of a project. Since the cost of water for the electrolysis process has not been taken into consideration in a distinct category, we can assume that it is included in this category.

After calculating the total revenues and total expenses, an accounting approach is required to evaluate potential taxes, therefore the EBITDA (Earnings Before Interest, Taxes, Depreciation and Amortization) indicator is calculated by subtracting the total expenses from the total revenues. Next, the Depreciation Expense is subtracted from the EBITDA in order to obtain the EBIT (Earnings Before Interest and Taxes). It is important to mention the assumption that the project is funded with available funds, therefore the Financial Expense category is not taken into consideration in this study, meaning that the EBIT and EBT indicators share the same value. If the EBT indicator is positive, the income tax is applied to it. However, in our specific case, the EBT is negative, therefore there is no income tax, meaning that the Net Profit is equal to the EBT. All these calculations are detailed in Table 8.9 for the whole duration of the project.

Table 8.10 presents the Cash Flow analysis of the project. The Operational Cash Flow is calculated by summing the Net Profit category with the Depreciation Expense. In our case the investment is made in the first year of the project, therefore the Investment Cash Flow is covered at this moment. The Total Cash Flow represents the sum between the Operational Cash Flow and the Investment Cash Flow. Cash at Beginning of the Year (Cash BoY) and Cash at the End of the Year (Cash EoY) are also calculated.

The final stage of the DCF valuation model consists in calculating the NPV of the project. In our case, the procedure is simplified by directly establishing a discount rate of 10% as a result of [GDF Suez Energy Romania 2015]. The FCFE (Free Cash Flow for the Firm) indicator is calculated by subtracting the Income Tax from the EBITDA indicator for each year of the project. Finally, the NPV indicator is calculated taking into account the Investment Cash Flow, the yearly FCFE and the discount rate. In the 2015 Romanian Case Hydrogen pathway, the NPV (Net Present Value) of the project is – 21 146 299 Euro for a discount rate of 10 percent (Table 11).

According to [Finance Formulas n.d.], the formula used for obtaining the NPV is:

$$NPV = -C_0 + \sum_{i=1}^T \frac{C_i}{(1+r)^i}$$

where:

$C_0 = \text{Investment Cash Flow}$

$C = \text{cash flow}$

$r = \text{discount rate}$

$T = \text{lifetime of the project}$

If the NPV is positive, it means that the project can potentially bring value to the investor and the investment might be accepted. If the NPV is negative, the project will incur losses to the company and it will probably be rejected. IF the NPV is zero, the project will bring no financial value to the company and the decision regarding the investment may be taken on the basis of other criteria (strategic, political etc.).

At this stage of the DCF valuation, the IRR (Internal Rate of Return) indicator can be calculated. According to [Investopedia n.d.], the IRR represents the discount rate that is required to bring the NPV to zero, a point where the cash flows of the project are equal to its costs, which is in our analysis the target IRR. Generally, companies impose a hurdle rate for certain type of projects and the project is accepted if the IRR exceeds the hurdle rate. In the case in which two projects have to be compared, the project with the larger IRR is chosen for investment.

In the case of the 2015 Romanian case Hydrogen pathway, the NPV value is too far from zero to allow the calculation of the IRR indicator.

Table 8.9 2015 Romanian Case Power-to-Gas Hydrogen Profits & Losses

Year	2016	2017	2018	2019	2020	2021	2022	2023	2024	2025	2026	2027	2028	2029	2030	2031	2032	2033	2034	2035
	1	2	3	4	5	6	7	8	9	10	11	12	13	14	15	16	17	18	19	20
Revenues																				
Electrolysis																				
Oxygen	€ 225,077	€ 229,578	€ 234,170	€ 238,853	€ 243,631	€ 248,503	€ 253,473	€ 258,543	€ 263,714	€ 268,988	€ 274,368	€ 279,855	€ 285,452	€ 291,161	€ 296,984	€ 302,924	€ 308,982	€ 315,162	€ 321,465	€ 327,895
Hydrogen Injection																				
Injected Hydrogen	€ 731,869	€ 746,506	€ 761,436	€ 776,665	€ 792,198	€ 808,042	€ 824,203	€ 840,687	€ 857,501	€ 874,651	€ 892,144	€ 909,987	€ 928,187	€ 946,750	€ 965,685	€ 984,999	€ 1,004,699	€ 1,024,793	€ 1,045,289	€ 1,066,195
Total Revenues	€ 956,946	€ 976,085	€ 995,606	€ 1,015,518	€ 1,035,829	€ 1,056,545	€ 1,077,676	€ 1,099,230	€ 1,121,214	€ 1,143,639	€ 1,166,511	€ 1,189,842	€ 1,213,639	€ 1,237,911	€ 1,262,670	€ 1,287,923	€ 1,313,681	€ 1,339,955	€ 1,366,754	€ 1,394,089
Expenses																				
Electrolysis																				
Electric Energy	€ 1,713,413	€ 1,747,682	€ 1,782,635	€ 1,818,288	€ 1,854,654	€ 1,891,747	€ 1,929,582	€ 1,968,173	€ 2,007,537	€ 2,047,688	€ 2,088,641	€ 2,130,414	€ 2,173,023	€ 2,216,483	€ 2,260,813	€ 2,306,029	€ 2,352,150	€ 2,399,192	€ 2,447,176	€ 2,496,120
OPEX	€ 198,000	€ 201,960	€ 205,999	€ 210,119	€ 214,322	€ 218,608	€ 222,980	€ 227,440	€ 231,989	€ 236,628	€ 241,361	€ 246,188	€ 251,112	€ 256,134	€ 261,257	€ 266,482	€ 271,812	€ 277,248	€ 282,793	€ 288,449
Insurance	€ 36,000	€ 36,720	€ 37,454	€ 38,203	€ 38,968	€ 39,747	€ 40,542	€ 41,353	€ 42,180	€ 43,023	€ 43,884	€ 44,761	€ 45,657	€ 46,570	€ 47,501	€ 48,451	€ 49,420	€ 50,409	€ 51,417	€ 52,445
Stack Replacement	€ -	€ -	€ -	€ -	€ -	€ -	€ -	€ -	€ -	€ 5,975,463	€ -	€ -	€ -	€ -	€ -	€ -	€ -	€ -	€ -	€ -
Hydrogen Injection																				
Connection	€ 2,600	€ 2,652	€ 2,705	€ 2,759	€ 2,814	€ 2,871	€ 2,928	€ 2,987	€ 3,046	€ 3,107	€ 3,169	€ 3,233	€ 3,297	€ 3,363	€ 3,431	€ 3,499	€ 3,569	€ 3,641	€ 3,713	€ 3,788
Injection station	€ 48,000	€ 48,960	€ 49,939	€ 50,938	€ 51,957	€ 52,996	€ 54,056	€ 55,137	€ 56,240	€ 57,364	€ 58,512	€ 59,682	€ 60,876	€ 62,093	€ 63,335	€ 64,602	€ 65,894	€ 67,212	€ 68,556	€ 69,927
Contingencies	€ 99,901	€ 101,899	€ 103,937	€ 106,015	€ 108,136	€ 110,298	€ 112,504	€ 114,754	€ 117,050	€ 418,164	€ 121,778	€ 124,214	€ 126,698	€ 129,232	€ 131,817	€ 134,453	€ 137,142	€ 139,885	€ 142,683	€ 145,536
Total Expenses	€ 2,097,914	€ 2,139,872	€ 2,182,670	€ 2,226,323	€ 2,270,850	€ 2,316,267	€ 2,362,592	€ 2,409,844	€ 2,458,041	€ 8,781,438	€ 2,557,346	€ 2,608,493	€ 2,660,662	€ 2,713,876	€ 2,768,153	€ 2,823,516	€ 2,879,987	€ 2,937,586	€ 2,996,338	€ 3,056,265
EBITDA	€ (1,140,968)	€ (1,163,788)	€ (1,187,064)	€ (1,210,805)	€ (1,235,021)	€ (1,259,721)	€ (1,284,916)	€ (1,310,614)	€ (1,336,826)	€ (7,637,799)	€ (1,390,834)	€ (1,418,651)	€ (1,447,024)	€ (1,475,964)	€ (1,505,484)	€ (1,535,593)	€ (1,566,305)	€ (1,597,631)	€ (1,629,584)	€ (1,662,176)
Depreciation Expense	€ 486,500	€ 486,500	€ 486,500	€ 486,500	€ 486,500	€ 486,500	€ 486,500	€ 486,500	€ 486,500	€ 486,500	€ 486,500	€ 486,500	€ 486,500	€ 486,500	€ 486,500	€ 486,500	€ 486,500	€ 486,500	€ 486,500	€ 486,500
EBIT	€ (1,627,468)	€ (1,650,288)	€ (1,673,564)	€ (1,697,305)	€ (1,721,521)	€ (1,746,221)	€ (1,771,416)	€ (1,797,114)	€ (1,823,326)	€ (8,124,299)	€ (1,877,334)	€ (1,905,151)	€ (1,933,524)	€ (1,962,464)	€ (1,991,984)	€ (2,022,093)	€ (2,052,805)	€ (2,084,131)	€ (2,116,084)	€ (2,148,676)
Financial Expense	€ -	€ -	€ -	€ -	€ -	€ -	€ -	€ -	€ -	€ -	€ -	€ -	€ -	€ -	€ -	€ -	€ -	€ -	€ -	€ -
EBT	€ (1,627,468)	€ (1,650,288)	€ (1,673,564)	€ (1,697,305)	€ (1,721,521)	€ (1,746,221)	€ (1,771,416)	€ (1,797,114)	€ (1,823,326)	€ (8,124,299)	€ (1,877,334)	€ (1,905,151)	€ (1,933,524)	€ (1,962,464)	€ (1,991,984)	€ (2,022,093)	€ (2,052,805)	€ (2,084,131)	€ (2,116,084)	€ (2,148,676)
Income Tax	€ -	€ -	€ -	€ -	€ -	€ -	€ -	€ -	€ -	€ -	€ -	€ -	€ -	€ -	€ -	€ -	€ -	€ -	€ -	€ -
Net Profit	€ (1,627,468)	€ (1,650,288)	€ (1,673,564)	€ (1,697,305)	€ (1,721,521)	€ (1,746,221)	€ (1,771,416)	€ (1,797,114)	€ (1,823,326)	€ (8,124,299)	€ (1,877,334)	€ (1,905,151)	€ (1,933,524)	€ (1,962,464)	€ (1,991,984)	€ (2,022,093)	€ (2,052,805)	€ (2,084,131)	€ (2,116,084)	€ (2,148,676)

Table 8.10 2015 Romanian Case Power-to-Gas Hydrogen Cash Flow

Year	2016	2017	2018	2019	2020	2021	2022	2023	2024	2025	2026	2027	2028	2029	2030	2031	2032	2033	2034	2035
	1	2	3	4	5	6	7	8	9	10	11	12	13	14	15	16	17	18	19	20
Operational Cash Flow	€ (1,140,968)	€ (1,163,788)	€ (1,187,064)	€ (1,210,805)	€ (1,235,021)	€ (1,259,721)	€ (1,284,916)	€ (1,310,614)	€ (1,336,826)	€ (7,637,799)	€ (1,390,834)	€ (1,418,651)	€ (1,447,024)	€ (1,475,964)	€ (1,505,484)	€ (1,535,593)	€ (1,566,305)	€ (1,597,631)	€ (1,629,584)	€ (1,662,176)
Net Profit	€ (1,627,468)	€ (1,650,288)	€ (1,673,564)	€ (1,697,305)	€ (1,721,521)	€ (1,746,221)	€ (1,771,416)	€ (1,797,114)	€ (1,823,326)	€ (8,124,299)	€ (1,877,334)	€ (1,905,151)	€ (1,933,524)	€ (1,962,464)	€ (1,991,984)	€ (2,022,093)	€ (2,052,805)	€ (2,084,131)	€ (2,116,084)	€ (2,148,676)
Depreciation Expense	€ 486,500	€ 486,500	€ 486,500	€ 486,500	€ 486,500	€ 486,500	€ 486,500	€ 486,500	€ 486,500	€ 486,500	€ 486,500	€ 486,500	€ 486,500	€ 486,500	€ 486,500	€ 486,500	€ 486,500	€ 486,500	€ 486,500	€ 486,500
Investment Cash Flow	€ (9,730,000)																			
CAPEX	€ 9,730,000																			
Financing Cash Flow																				
Total Cash Flow	€ (10,870,968)	€ (1,163,788)	€ (1,187,064)	€ (1,210,805)	€ (1,235,021)	€ (1,259,721)	€ (1,284,916)	€ (1,310,614)	€ (1,336,826)	€ (7,637,799)	€ (1,390,834)	€ (1,418,651)	€ (1,447,024)	€ (1,475,964)	€ (1,505,484)	€ (1,535,593)	€ (1,566,305)	€ (1,597,631)	€ (1,629,584)	€ (1,662,176)
Cash BoY		€ (10,870,968)	€ (12,034,756)	€ (13,221,820)	€ (14,432,625)	€ (15,667,646)	€ (16,927,367)	€ (18,212,283)	€ (19,522,897)	€ (20,859,723)	€ (28,497,522)	€ (29,888,356)	€ (31,307,007)	€ (32,754,031)	€ (34,229,995)	€ (35,735,479)	€ (37,271,072)	€ (38,837,377)	€ (40,435,008)	€ (42,064,592)
Cash EoY	€ (10,870,968)	€ (12,034,756)	€ (13,221,820)	€ (14,432,625)	€ (15,667,646)	€ (16,927,367)	€ (18,212,283)	€ (19,522,897)	€ (20,859,723)	€ (28,497,522)	€ (29,888,356)	€ (31,307,007)	€ (32,754,031)	€ (34,229,995)	€ (35,735,479)	€ (37,271,072)	€ (38,837,377)	€ (40,435,008)	€ (42,064,592)	€ (43,726,768)

Table 8.11 2015 Romanian Case Power-to-Gas Hydrogen NPV Calculation

		2016	2017	2018	2019	2020	2021	2022	2023	2024	2025	2026	2027	2028	2029	2030	2031	2032	2033	2034	2035
		1	2	3	4	5	6	7	8	9	10	11	12	13	14	15	16	17	18	19	20
Initial Investment	€ 9,730,000	Euro																			
FCFF	€ (9,730,000)	€ (1,140,968)	€ (1,163,788)	€ (1,187,064)	€ (1,210,805)	€ (1,235,021)	€ (1,259,721)	€ (1,284,916)	€ (1,310,614)	€ (1,336,826)	€ (7,637,799)	€ (1,390,834)	€ (1,418,651)	€ (1,447,024)	€ (1,475,964)	€ (1,505,484)	€ (1,535,593)	€ (1,566,305)	€ (1,597,631)	€ (1,629,584)	€ (1,662,176)
		€ (10,870,968)	€ (2,304,756)	€ (2,350,851)	€ (2,397,868)	€ (2,445,826)	€ (2,494,742)	€ (2,544,637)	€ (2,595,530)	€ (2,647,440)	€ (8,974,625)	€ (9,028,633)	€ (2,809,485)	€ (2,865,675)	€ (2,922,988)	€ (2,981,448)	€ (3,041,077)	€ (3,101,898)	€ (3,163,936)	€ (3,227,215)	€ (3,291,759)
Payback period	20 years																				
NPV	€ (21,146,299)	Discount Rate	10.00%																		

According to the analysis framework presented in the dedicated chapter of the thesis, if the DCF valuations reveal that the NPV of the project is negative, respectively the IRR is situated below the desired target, the next step consists in establishing the required level of subventions that would create a positive business case. In our context, the subventions can be put in place under the form of price premiums for renewable hydrogen, paid on top of the price of hydrogen that is injected in the natural gas grid. The price premiums are expressed in Euro/MWh of renewable hydrogen and are modelled as a revenue stream in the Profits & Losses section of the DCF model. The results of the sensitivity analysis performed on the impact of the price premiums on the NPV and IRR indicators of the project are presented in Table 8.12. The break-even point, for which the value of the NPV indicator of the project is zero (and the IRR has the same value as the discount rate, 10) is reached for a price premium of 68.1 Euro/MWh of renewable hydrogen. Figure 8.8 is the graphic representation of the influence the price premiums have on the NPV of the project.

Table 8.12 2015 Romanian Case Power-to-Gas Hydrogen price premium sensitivity analysis

Price premium [Euro/MWh]	NPV	IRR
0	€ (21,146,299)	-
20	€ (14,551,156)	-
40	€ (7,956,813)	-8.11
60	€ (2,261,786)	6.07
80	€ 3,328,057	15.14
100	€ 8,917,901	22.88
120	€ 14,507,744	30.07
140	€ 20,097,588	36.96
Break-even point	68.1 Euro/MWh	

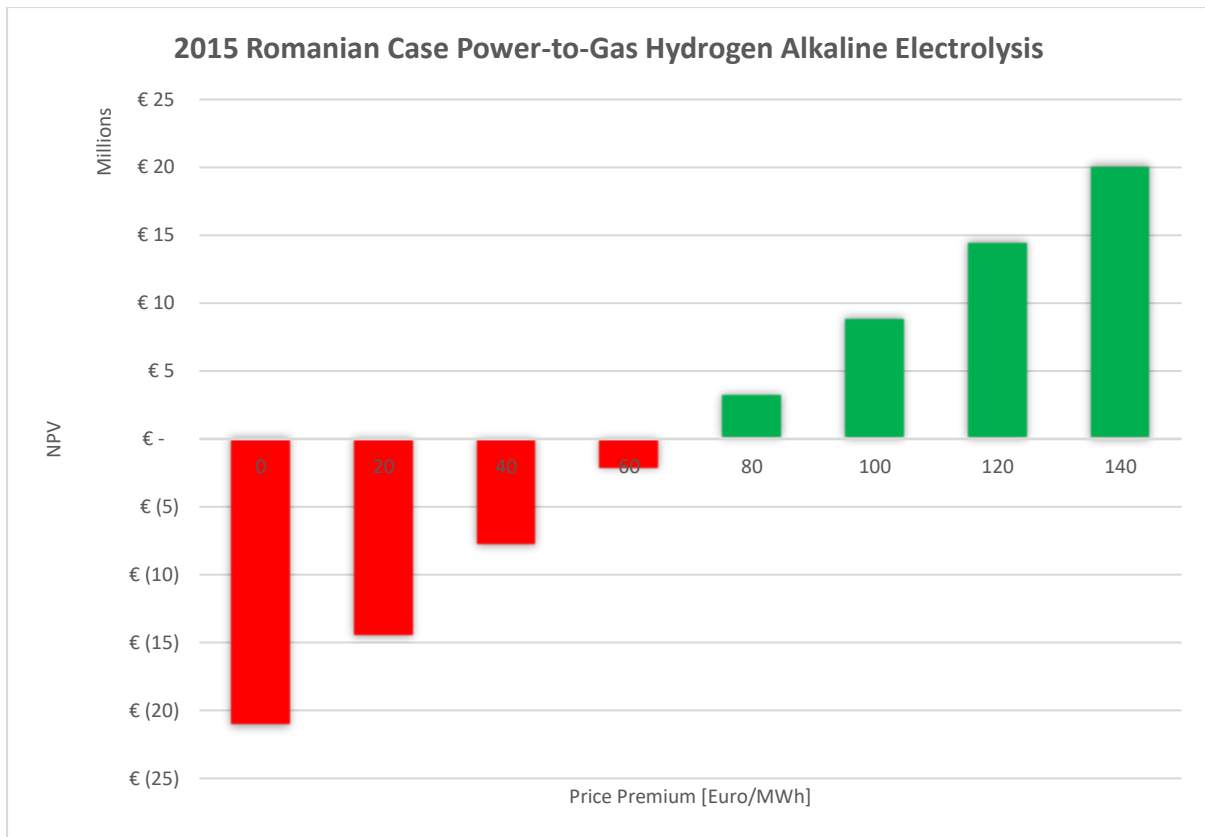

Figure 8.8 2015 Romanian Case Power-to-Gas Hydrogen Influence of price premiums on the NPV of the project

At the end of the economic analysis, it is possible to calculate the Levelized Cost of Energy for 1 MWh of hydrogen injected in the natural gas grid, using the following formula (all values are discounted at the first year of use):

Levelized H₂ production cost

$$= \frac{\sum CAPEX + \sum_l (Electric\ energy - Oxygen) + \sum_l OPEX + \sum_l Insurance + \sum_l Contingencies + \sum_l Stack\ replacement}{\sum_l^{prod} H_2}$$

Therefore, for the 2015 Romanian Case Power-to-Gas Hydrogen pathway, the LCOE (without taking into account potential price premiums) is 95.83 Euro/MWh HHV.

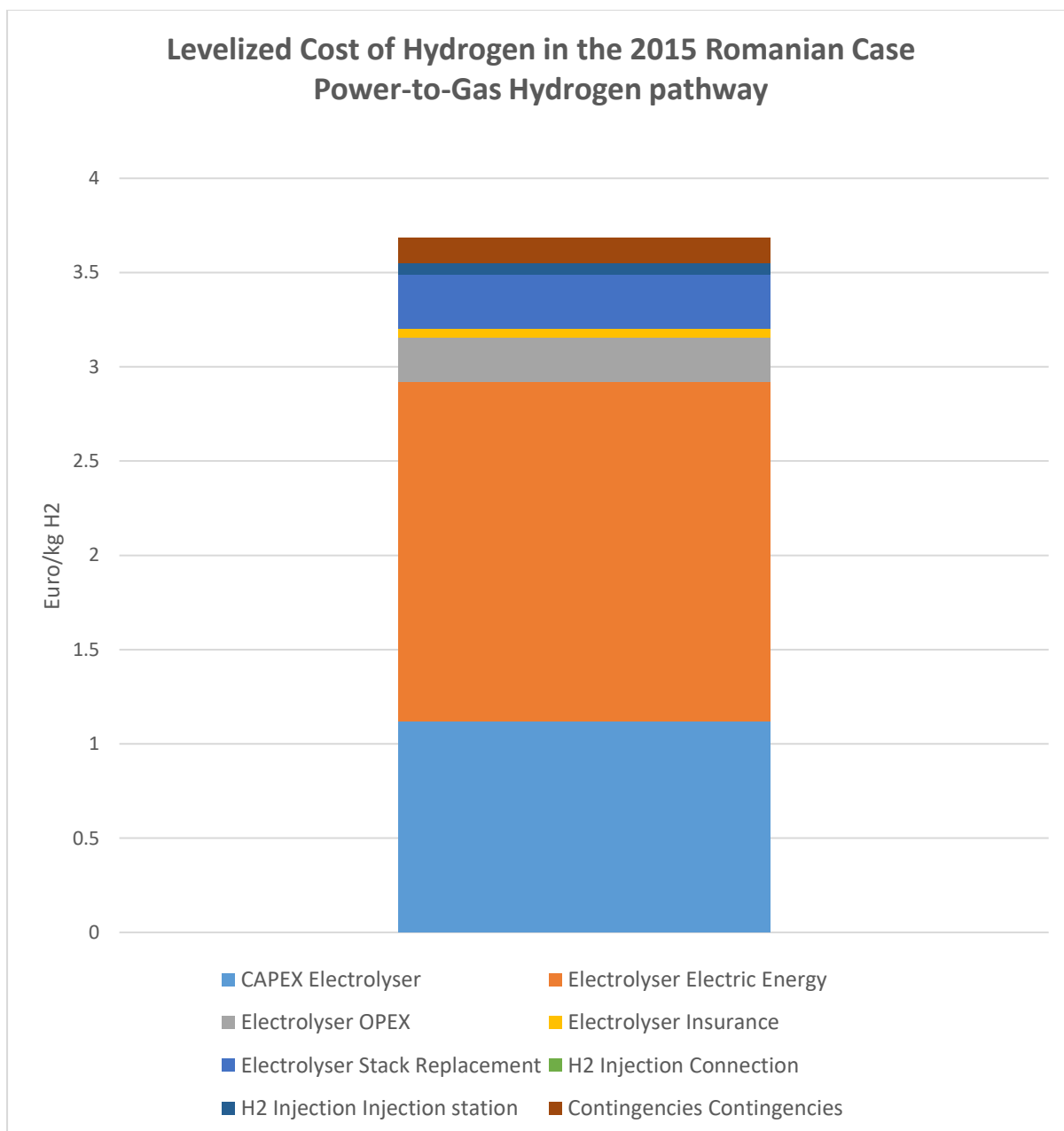

Figure 8.9 Levelized Cost of Energy in the 2015 Romanian Case Power-to-Gas Hydrogen pathway

Figure 8.9 presents the contribution each component has on the levelized cost of hydrogen production (per kilogram of hydrogen), derived from the previous LCOE calculation, taking into consideration the energy HHV density of hydrogen of 39.4 kWh/kg. The total levelized cost of hydrogen production is 3.78 Euro/kg, without taking into account any price premiums, the most important contributions coming from cost of electric energy (minus the cost of sold oxygen) – 47% and the CAPEX of the electrolysis unit – 29%.

8.4.2 Power-to-Gas SNG

The second pathway of the Romanian case focuses on the more complex route of producing SNG (Substitute Natural Gas), an evolution of the previously presented pathway, which adds several components:

- Hydrogen storage – the output of the electrolysis units is not constant, depending on the renewable energy input. Therefore, in order to ensure that the methanation reactor maintains a steady state of operation (preferable if taking into consideration flexibility issues), a pressurized hydrogen storage tank will be used as buffer between the electrolysis and the methanation stages.
- CO₂ capture unit – the methanation process requires hydrogen and carbon dioxide inputs in order to produce SNG. However, the CO₂ capture process will not be modelled in this analysis, assuming that it is handled by an external stakeholder, with no costs for the Power-to-Gas project.
- Methanation plant – responsible for producing SNG, only the economic model will be further discussed in this section. A complete technical simulation of the methanation plant used for simulating this project was presented in the chapter dedicated to this.

Evaluating Power-to-Gas SNG from an economic point of view is performed in a similar manner with the previously considered pathway, using a DCF valuation model. Only the most important differences and significant observations are going to be covered in the next section.

Table 8.13 Romanian Case 2015 Power-to-Gas SNG inputs

Project type	Power-to-Gas SNG		
Year	2015		
Project size	10 MW		
Threshold	70 Euro/MWh		
Project lifetime	20 years		
Category	Value	Unit	Reference
CAPEX			
Electrolysis	900	Euro/kW	[Bertuccioli et al. 2014]
Hydrogen storage	470	Euro/kg	[ADEME 2014]
Methanation plant	950	Euro/kW	[DNV KEMA Energy &

			Sustainability 2013]
OPEX			
Electrolysis	2.2	% of CAPEX/year	[Bertuccioli et al. 2014]
Methanation	10	% of CAPEX/year	[DNV KEMA Energy & Sustainability 2013]
Outputs			
Hydrogen	107.9	kg/h	
Hydrogen (yearly energy output)	37245.2	MWh HHV/year	
Oxygen	856.4	kg/h	
Oxygen (yearly output)	7502565	kg/year	
SNG	28598.67	MWh HHV/year	
Economic indicators			
Natural gas price	19.65	Euro/MWh HHV	[GDF Suez Energy Romania 2013b]
Oxygen price	0.03	Euro/kg	[Agerborg & Lingehed 2013]
Discount rate	10	%	[GDF Suez Energy Romania 2015]
Inflation rate	2	%	
Insurance	0.4	% of CAPEX/year	[Omniasig 2014]
Income tax	16	%	
Technical indicators			
Electrolyser hours per year	6213	hours	
Electrolysis hour during lifetime	12460	hours	
Electrolyser capacity factor	70.92	%	
Electrolyser stack lifetime	65000	hours	[Bertuccioli et al. 2014]
Stack replacements	1		
First year of replacement	10		
Stack replacement cost	50	% of CAPEX of the electrolysis unit	[Bertuccioli et al. 2014]
Capacity of the methanation reactor	3.265	MW HHV of SNG output	

Table 8.13 presents the Inputs used in the DCF valuation model for the 2015 Romanian Case Power-to-Gas SNG pathway. Based on the hydrogen output of the electrolysis process, the calculation of the SNG output of the methanation reactor is performed using the methodology presented in the dedicated chapter. Residual heat is a secondary output of the methanation process, but one that potentially has a significant economic value. The methodology and the calculations required for determining this figure are, as well, presented in the chapter dedicated to the methanation process.

Table 8.14 Romanian Case Power-to-Gas SNG initial investment

Investment	CAPEX
Electrolysis	
Electrolysis plant	€ 9,000,000
Hydrogen Storage	
Hydrogen storage tank	€ 2,434,498
Methanation	
Methanation plant	€ 3,101,750
Natural gas grid connection	
Connection	€ 130,000
Injection station	€ 600,000
Total	
Total Investment	€ 15,266,248

Table 8.14 is covering the calculations for establishing the Initial Investment of the studies scenario. Besides the categories that were covered in the previous subchapter, new investments are required: the hydrogen storage tank and the methanation plant. Calculating the size of the hydrogen storage tank started from the observation we made that a 48-hour buffer storage would ensure a continuous operation for the methanation reactor throughout the year. Consequently, knowing the continuous hydrogen input feed and the SNG output, we were able to calculate the size of the methanation reactor, based on the energy value of the output SNG.

Table 8.15 2015 Romanian Case Power-to-Gas SNG CAPEX & Depreciation

Depreciable Assets	€ 15,266,248	Euro			
Depreciation Period	20	years			
	2016	2017	...	2034	2035
	1	2	...	19	20
Depreciation Expense	€ 763,312	€ 763,312	...	€ 763,312	€ 763,312
CAPEX	€ 15,266,248	Euro			

In a similar manner with the previous pathway, the CAPEX & Depreciation calculation was performed for the SNG pathway (Table 8.15), obtaining the yearly Depreciation Expense figure. Values are equal for the lifetime of the project for simplification purposes.

Table 8.16 2015 Romanian Case Power-to-Gas SNG Profits & Losses

Year	2016	2017	2018	2019	2020	2021	2022	2023	2024	2025	2026	2027	2028	2029	2030	2031	2032	2033	2034	2035
	1	2	3	4	5	6	7	8	9	10	11	12	13	14	15	16	17	18	19	20
Revenues																				
Electrolysis																				
Oxygen	€ 225,077	€ 229,578	€ 234,170	€ 238,853	€ 243,631	€ 248,503	€ 253,473	€ 258,543	€ 263,714	€ 268,988	€ 274,368	€ 279,855	€ 285,452	€ 291,161	€ 296,984	€ 302,924	€ 308,982	€ 315,162	€ 321,465	€ 327,895
Methanation																				
SNG	€ 561,964	€ 573,203	€ 584,667	€ 596,360	€ 608,288	€ 620,453	€ 632,863	€ 645,520	€ 658,430	€ 671,599	€ 685,031	€ 698,731	€ 712,706	€ 726,960	€ 741,499	€ 756,329	€ 771,456	€ 786,885	€ 802,623	€ 818,675
Residual heat	€ 251,000	€ 256,020	€ 261,140	€ 266,363	€ 271,690	€ 277,124	€ 282,667	€ 288,320	€ 294,087	€ 299,968	€ 305,968	€ 312,087	€ 318,329	€ 324,695	€ 331,189	€ 337,813	€ 344,569	€ 351,461	€ 358,490	€ 365,660
Total Revenues	€ 1,038,041	€ 1,058,802	€ 1,079,978	€ 1,101,577	€ 1,123,609	€ 1,146,081	€ 1,169,002	€ 1,192,383	€ 1,216,230	€ 1,240,555	€ 1,265,366	€ 1,290,673	€ 1,316,487	€ 1,342,816	€ 1,369,673	€ 1,397,066	€ 1,425,008	€ 1,453,508	€ 1,482,578	€ 1,512,229
Expenses																				
Electrolysis																				
Electric Energy	€ 1,713,413	€ 1,747,682	€ 1,782,635	€ 1,818,288	€ 1,854,654	€ 1,891,747	€ 1,929,582	€ 1,968,173	€ 2,007,537	€ 2,047,688	€ 2,088,641	€ 2,130,414	€ 2,173,023	€ 2,216,483	€ 2,260,813	€ 2,306,029	€ 2,352,150	€ 2,399,192	€ 2,447,176	€ 2,496,120
OPEX	€ 198,000	€ 201,960	€ 205,999	€ 210,119	€ 214,322	€ 218,608	€ 222,980	€ 227,440	€ 231,989	€ 236,628	€ 241,361	€ 246,188	€ 251,112	€ 256,134	€ 261,257	€ 266,482	€ 271,812	€ 277,248	€ 282,793	€ 288,449
Insurance	€ 36,000	€ 36,720	€ 37,454	€ 38,203	€ 38,968	€ 39,747	€ 40,542	€ 41,353	€ 42,180	€ 43,023	€ 43,884	€ 44,761	€ 45,657	€ 46,570	€ 47,501	€ 48,451	€ 49,420	€ 50,409	€ 51,417	€ 52,445
Stack Replacement	€ -	€ -	€ -	€ -	€ -	€ -	€ -	€ -	€ -	€ 5,975,463	€ -	€ -	€ -	€ -	€ -	€ -	€ -	€ -	€ -	€ -
Hydrogen storage insurance	€ 9,738	€ 9,933	€ 10,131	€ 10,334	€ 10,541	€ 10,752	€ 10,967	€ 11,186	€ 11,410	€ 11,638	€ 11,871	€ 12,108	€ 12,350	€ 12,597	€ 12,849	€ 13,106	€ 13,368	€ 13,636	€ 13,908	€ 14,186
Methanation																				
OPEX	€ 310,175	€ 316,379	€ 322,706	€ 329,160	€ 335,743	€ 342,458	€ 349,307	€ 356,294	€ 363,419	€ 370,688	€ 378,102	€ 385,664	€ 393,377	€ 401,244	€ 409,269	€ 417,455	€ 425,804	€ 434,320	€ 443,006	€ 451,866
Insurance	€ 12,407	€ 12,655	€ 12,908	€ 13,166	€ 13,430	€ 13,698	€ 13,972	€ 14,252	€ 14,537	€ 14,828	€ 15,124	€ 15,427	€ 15,735	€ 16,050	€ 16,371	€ 16,698	€ 17,032	€ 17,373	€ 17,720	€ 18,075
SNG Injection																				
Connection	€ 2,600	€ 2,652	€ 2,705	€ 2,759	€ 2,814	€ 2,871	€ 2,928	€ 2,987	€ 3,046	€ 3,107	€ 3,169	€ 3,233	€ 3,297	€ 3,363	€ 3,431	€ 3,499	€ 3,569	€ 3,641	€ 3,713	€ 3,788
Injection station	€ 48,000	€ 48,960	€ 49,939	€ 50,938	€ 51,957	€ 52,996	€ 54,056	€ 55,137	€ 56,240	€ 57,364	€ 58,512	€ 59,682	€ 60,876	€ 62,093	€ 63,335	€ 64,602	€ 65,894	€ 67,212	€ 68,556	€ 69,927
Contingencies	€ 116,517	€ 118,847	€ 121,224	€ 123,648	€ 126,121	€ 128,644	€ 131,217	€ 133,841	€ 136,518	€ 138,241	€ 142,033	€ 144,874	€ 147,771	€ 150,727	€ 153,741	€ 156,816	€ 159,952	€ 163,151	€ 166,415	€ 169,743
Total Expenses	€ 2,446,850	€ 2,495,787	€ 2,545,703	€ 2,596,617	€ 2,648,549	€ 2,701,520	€ 2,755,551	€ 2,810,662	€ 2,866,875	€ 2,924,448	€ 2,982,697	€ 3,042,351	€ 3,103,198	€ 3,165,262	€ 3,228,567	€ 3,293,138	€ 3,359,001	€ 3,426,181	€ 3,494,705	€ 3,564,599
EBITDA	€ (1,408,809)	€ (1,436,986)	€ (1,465,725)	€ (1,495,040)	€ (1,524,941)	€ (1,555,439)	€ (1,586,548)	€ (1,618,279)	€ (1,650,645)	€ (7,957,894)	€ (1,717,331)	€ (1,751,677)	€ (1,786,711)	€ (1,822,445)	€ (1,858,894)	€ (1,896,072)	€ (1,933,993)	€ (1,972,673)	€ (2,012,127)	€ (2,052,369)
Depreciation Expense	€ 763,312	€ 763,312	€ 763,312	€ 763,312	€ 763,312	€ 763,312	€ 763,312	€ 763,312	€ 763,312	€ 763,312	€ 763,312	€ 763,312	€ 763,312	€ 763,312	€ 763,312	€ 763,312	€ 763,312	€ 763,312	€ 763,312	€ 763,312

EBIT	€	€	€	€	€	€	€	€	€	€	€	€	€	€	€	€	€	€	€	€
	(2,172,122)	(2,200,298)	(2,229,038)	(2,258,352)	(2,288,253)	(2,318,752)	(2,349,861)	(2,381,592)	(2,413,957)	(8,721,206)	(2,480,643)	(2,514,990)	(2,550,023)	(2,585,758)	(2,622,206)	(2,659,384)	(2,697,306)	(2,735,986)	(2,775,439)	(2,815,682)
Financial Expense	€	€	€	€	€	€	€	€	€	€	€	€	€	€	€	€	€	€	€	€
	-	-	-	-	-	-	-	-	-	-	-	-	-	-	-	-	-	-	-	-
EBT	€	€	€	€	€	€	€	€	€	€	€	€	€	€	€	€	€	€	€	€
	(2,172,122)	(2,200,298)	(2,229,038)	(2,258,352)	(2,288,253)	(2,318,752)	(2,349,861)	(2,381,592)	(2,413,957)	(8,721,206)	(2,480,643)	(2,514,990)	(2,550,023)	(2,585,758)	(2,622,206)	(2,659,384)	(2,697,306)	(2,735,986)	(2,775,439)	(2,815,682)
Income Tax	€	€	€	€	€	€	€	€	€	€	€	€	€	€	€	€	€	€	€	€
	-	-	-	-	-	-	-	-	-	-	-	-	-	-	-	-	-	-	-	-
Net Profit	€	€	€	€	€	€	€	€	€	€	€	€	€	€	€	€	€	€	€	€
	(2,172,122)	(2,200,298)	(2,229,038)	(2,258,352)	(2,288,253)	(2,318,752)	(2,349,861)	(2,381,592)	(2,413,957)	(8,721,206)	(2,480,643)	(2,514,990)	(2,550,023)	(2,585,758)	(2,622,206)	(2,659,384)	(2,697,306)	(2,735,986)	(2,775,439)	(2,815,682)

Table 8.17 2015 Romanian Case Power-to-Gas SNG Cash Flow

Year	2016	2017	2018	2019	2020	2021	2022	2023	2024	2025	2026	2027	2028	2029	2030	2031	2032	2033	2034	2035
	1	2	3	4	5	6	7	8	9	10	11	12	13	14	15	16	17	18	19	20
Operational Cash Flow	€	€	€	€	€	€	€	€	€	€	€	€	€	€	€	€	€	€	€	€
	(1,408,809)	(1,436,986)	(1,465,725)	(1,495,040)	(1,524,941)	(1,555,439)	(1,586,548)	(1,618,279)	(1,650,645)	(7,957,894)	(1,717,331)	(1,751,677)	(1,786,711)	(1,822,445)	(1,858,894)	(1,896,072)	(1,933,993)	(1,972,673)	(2,012,127)	(2,052,369)
Net Profit	€	€	€	€	€	€	€	€	€	€	€	€	€	€	€	€	€	€	€	€
	(2,172,122)	(2,200,298)	(2,229,038)	(2,258,352)	(2,288,253)	(2,318,752)	(2,349,861)	(2,381,592)	(2,413,957)	(8,721,206)	(2,480,643)	(2,514,990)	(2,550,023)	(2,585,758)	(2,622,206)	(2,659,384)	(2,697,306)	(2,735,986)	(2,775,439)	(2,815,682)
Depreciation Expense	€	€	€	€	€	€	€	€	€	€	€	€	€	€	€	€	€	€	€	€
	763,312	763,312	763,312	763,312	763,312	763,312	763,312	763,312	763,312	763,312	763,312	763,312	763,312	763,312	763,312	763,312	763,312	763,312	763,312	763,312
Investment Cash Flow	€																			
	(15,266,248)																			
CAPEX	€																			
	15,266,248																			
Financing Cash Flow																				
Total Cash Flow	€	€	€	€	€	€	€	€	€	€	€	€	€	€	€	€	€	€	€	€
	(16,675,057)	(1,436,986)	(1,465,725)	(1,495,040)	(1,524,941)	(1,555,439)	(1,586,548)	(1,618,279)	(1,650,645)	(7,957,894)	(1,717,331)	(1,751,677)	(1,786,711)	(1,822,445)	(1,858,894)	(1,896,072)	(1,933,993)	(1,972,673)	(2,012,127)	(2,052,369)
Cash BoY		€	€	€	€	€	€	€	€	€	€	€	€	€	€	€	€	€	€	€
		(16,675,057)	(18,112,043)	(19,577,768)	(21,072,808)	(22,597,749)	(24,153,188)	(25,739,736)	(27,358,015)	(29,008,660)	(36,966,553)	(38,683,884)	(40,435,562)	(42,222,272)	(44,044,718)	(45,903,612)	(47,799,684)	(49,733,677)	(51,706,350)	(53,718,477)
Cash EoY	€	€	€	€	€	€	€	€	€	€	€	€	€	€	€	€	€	€	€	€
	(16,675,057)	(18,112,043)	(19,577,768)	(21,072,808)	(22,597,749)	(24,153,188)	(25,739,736)	(27,358,015)	(29,008,660)	(36,966,553)	(38,683,884)	(40,435,562)	(42,222,272)	(44,044,718)	(45,903,612)	(47,799,684)	(49,733,677)	(51,706,350)	(53,718,477)	(55,770,846)

Table 8.18 2015 Romanian Case Power-to-Gas SNG NPV Calculation

			2016	2017	2018	2019	2020	2021	2022	2023	2024	2025	2026	2027	2028	2029	2030	2031	2032	2033	2034	2035
			1	2	3	4	5	6	7	8	9	10	11	12	13	14	15	16	17	18	19	20
Initial Investment	€	Euro																				
	15,266,248																					
FCFF	€	€	€	€	€	€	€	€	€	€	€	€	€	€	€	€	€	€	€	€	€	€
	(15,266,248)	(1,408,809)	(1,436,986)	(1,465,725)	(1,495,040)	(1,524,941)	(1,555,439)	(1,586,548)	(1,618,279)	(1,650,645)	(7,957,894)	(1,717,331)	(1,751,677)	(1,786,711)	(1,822,445)	(1,858,894)	(1,896,072)	(1,933,993)	(1,972,673)	(2,012,127)	(2,052,369)	
		(16,675,057)	(18,112,043)	(19,577,768)	(21,072,808)	(22,597,749)	(24,153,188)	(25,739,736)	(27,358,015)	(29,008,660)	(36,966,553)	(38,683,884)	(40,435,562)	(42,222,272)	(44,044,718)	(45,903,612)	(47,799,684)	(49,733,677)	(51,706,350)	(53,718,477)	(55,770,846)	
Payback period	20 years																					
NPV	€	Discount Rate	10.00%																			
	(28,550,629)																					

Table 8.16 is covering the Profits & Losses stage of the 2015 Romanian case SNG pathway, taking into account the following revenue streams:

- SNG – as an output of the Power-to-Gas SNG pathway, SNG is injected in the natural gas grid with no limitations imposed by the concentration limit since the two gases are almost identical in composition. Therefore, when injected, SNG is valued at the price of natural gas as a baseline.
- Oxygen - represents a byproduct of the electrolysis process and it can be valued for approximately 0.03 Euro/kg, price that includes all the necessary costs for bottling and transport.
- Residual heat – residual heat coming out of the methanation process is valued at 30 Euro/MWh [GDF Suez Energy Romania 2013a].

The Expenses stream is composed of the following categories:

- Electric energy – the price paid for the energy fed to the electrolysis units represent the most important expense of the project. It is calculated by multiplying the amount of energy fed to the electrolyzers by the associated DAM energy price.
- Stack replacement – after the electrolysis unit reaches the end of its lifetime, the stack needs to be replaced, incurring a significant cost to the project (Table 8.6).
- OPEX – the operational costs for the electrolysis units, methanation reactor (as presented in Table 8.13), as well as the previously mentioned ones for the elements of the Hydrogen Injection components.
- Insurance – insurance related costs are evaluated at 0.4% of CAPEX for every year, covering the electrolysis unit, the hydrogen storage components and the methanation reactor.
- Contingencies – a 5% of the total yearly expenses is assumed to cover unforeseen costs that usually appear during the operation of a project. Since the cost of water for the electrolysis process has not been taken into consideration in a distinct category, we can assume that it is included in this category.

The EBITDA, EBIT, EBT and Net Profit indicators are calculated in a similar manner with the one presented for the Hydrogen pathway.

The methodology used for Tables 8.17 and 8.18 is consistent with the one detailed for the Power-to-Gas Hydrogen pathway. In the 2015 Romanian Case SNG pathway, the NPV (Net

Present Value) of the project is – 28 550 629 Euro for a discount rate of 10 percent (Table 8.18).

The sensitivity analysis on the influence of SNG price premiums is presented in Table 8.19, while Figure 8.10 covers the graphic depiction of the same investigation, revealing that the break-even point is reached for a 120 Euro/MWh HHV SNG price premium.

Table 8.19 2015 Romanian Case Power-to-Gas SNG price premium sensitivity analysis

Price premium [Euro/MWh]	NPV	IRR
0	€ (28,550,629)	
20	€ (23,486,563)	
40	€ (18,422,497)	
60	€ (13,358,431)	-11.48
80	€ (8,578,317)	-0.64
100	€ (4,286,168)	5.27
120	€ 5,981	10.01
140	€ 4,298,130	14.17
Break-even point	120 Euro/MWh	

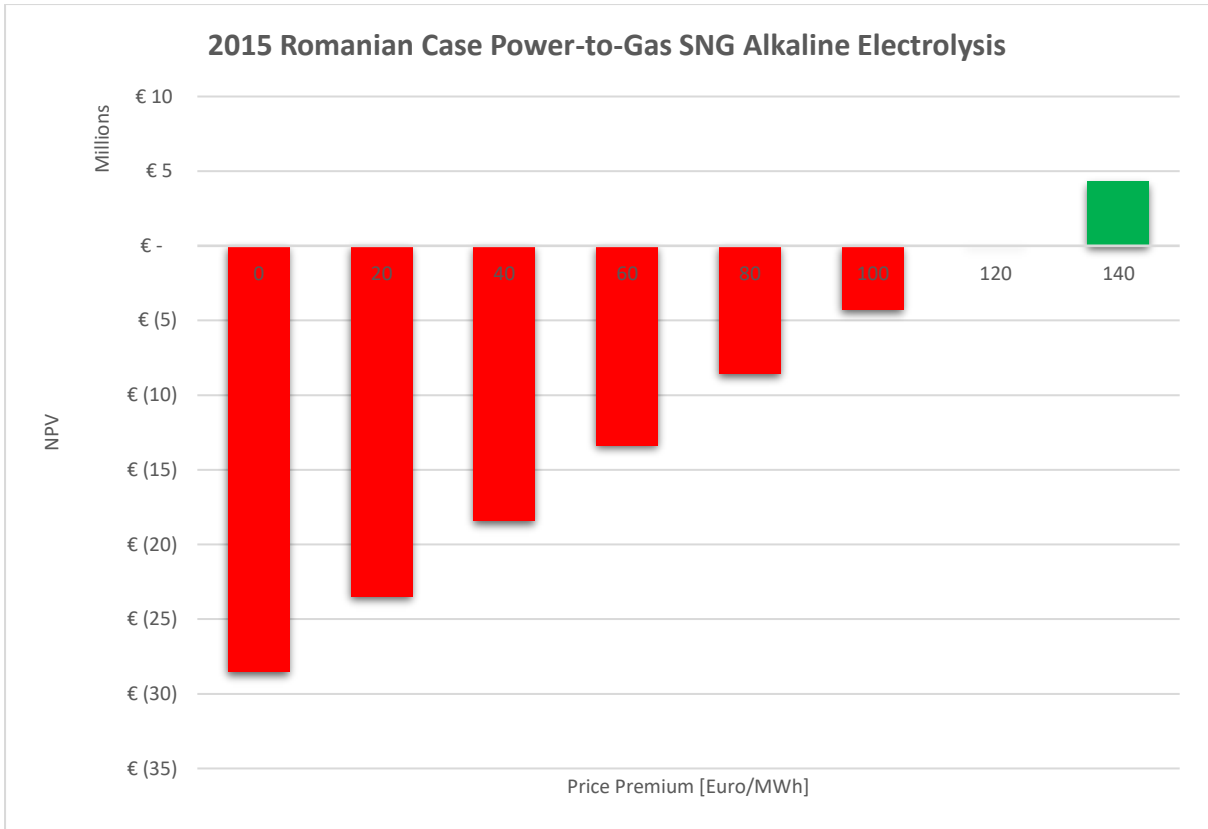

Figure 8.10 2015 Romanian Case Power-to-Gas SNG Influence of price premiums on the NPV of the project

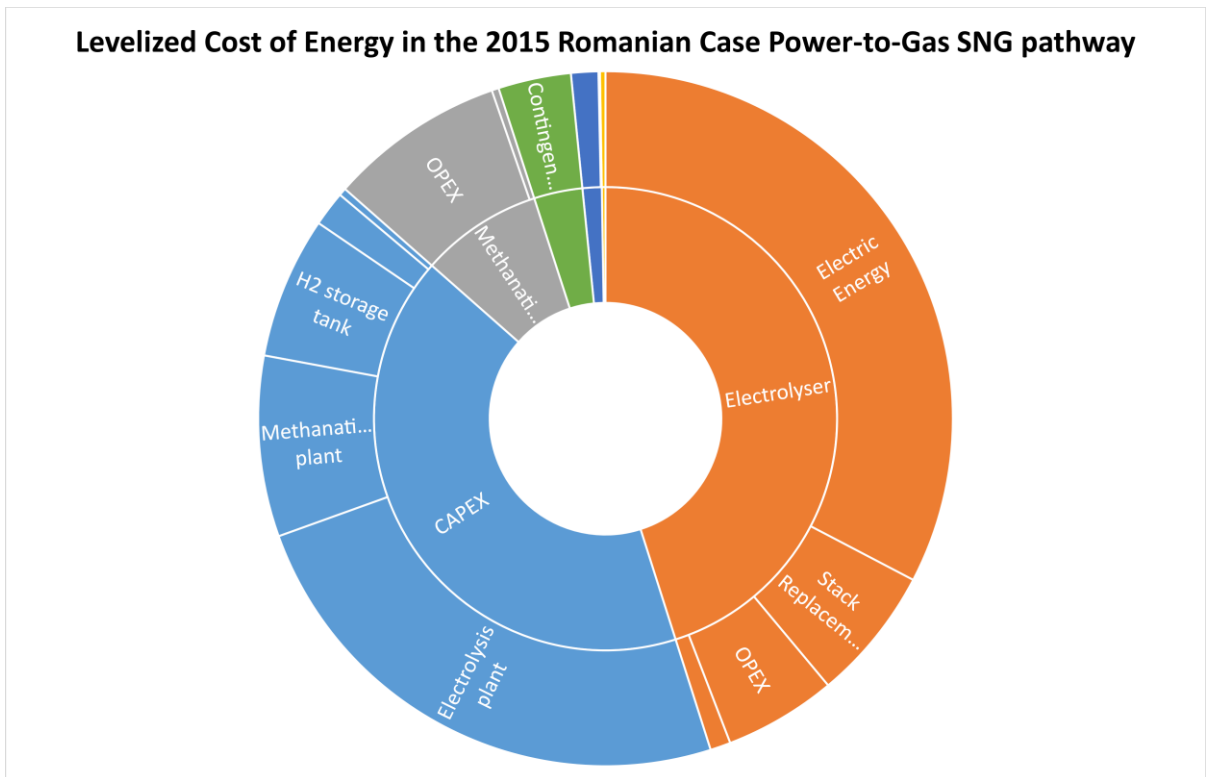

Figure 8.11 Levelized Cost of Energy in the 2015 Romanian Case Power-to-Gas SNG pathway

Figure 8.11 reveals the contribution of the different cost components to the overall LCOE for 1 MWh of SNG injected in the natural gas grid (calculated to be 151.47 Euro/MWh HHV, using the same formula applied in the Power-to-Gas Hydrogen pathway). The most important contributions come from the cost of electric energy (minus the cost of sold oxygen and residual heat) – 32% and the CAPEX of the electrolysis plant – 24%.

8.5 INFLUENCE OF FUTURE T&E DEVELOPMENTS ON THE ROMANIAN CASE

8.5.1 Motivation and methodology

Power-to-Gas is close to reaching technical maturity, making the jump from laboratory scale demonstrators to large scale pilot projects. However, the technical benefits are counterbalanced by capital and operational costs, as well as the overall efficiency of the whole chain. The technology recorded constant improvements in terms of efficiency over the last several years and the trend is expected to continue as new technologies become more mature, especially PEM electrolysis. In addition, recent evolutions indicate that technology costs have entered a downward slope that is expected to continue on short and medium term driven by research and market implementation.

Consequently, the following section will focus on comparing different technology pathways (PEM and alkaline electrolysis at 2030 level) expected to become market ready at very large scale (multi-MW) on medium term, in order to understand the foreseen technical and economic evolution of Power-to-Gas technology.

Concerning the methodology, the basic input data will continue to be the energy production of the 50 MW wind park from South-East Romania, along with the DAM energy market prices, as presented in the 2015 Power-to-Gas pathways. The current evaluation will follow the same analysis framework described in the previous chapter, beginning with a high-level analysis which corresponds to the technical sizing of the process and continuing with the low-level analysis – the economic evaluation of the selected scenarios.

Technically, the standard in Power-to-Gas for 2015 consists in using alkaline electrolysers that are commercially mature and can be scaled up in multi-megawatt projects, as presented in the

previous section. The electricity input that is taken into consideration at this moment is 56 kWh_{el}/kg_{H2}, corresponding to a LHV efficiency of 62%. In 2030 perspective, it is expected that alkaline electrolyzers will reach an electricity input level of 50 kWh_{el}/kg_{H2}, while PEM electrolyzers will even come down to 47 kWh_{el}/kg_{H2}, corresponding to a LHV efficiency of 71%. In addition to improvements related to conversion efficiency, it is expected that electrolyzers will also evolve in terms of operating range, achieving greater flexibility, as well as having an increased operating pressure which has the potential of lowering the costs on the downstream compression and storage equipment. While currently PEM electrolyzers have just started to reach MW scale units and achieve functional lifetimes comparable to their alkaline counterparts, it is expected that their pace of development will accelerate in the near future and units that can be used in large scale Power-to-Gas projects will become available. Regarding methanation, there are no major improvements in terms of efficiency expected for 2030 [8, 9, 10].

Table 8.20 Technical assumptions taken into consideration for the 2015 and 2030 comparative assessment of Power-to-Gas in the Romanian case

	2015 (Alkaline)	2030 (Alkaline)	2030 (PEM)	Reference
Electricity Input [kWh_{el}/kg_{H2}]	56	50	47	[Bertuccioli et al. 2014] [ADEME 2014]
LHV efficiency [%]	62	66	71	
Operating range [%]	20 – 100	5 – 110	5 – 200	
Operating pressure [bar]	30	60	100	

From an economic perspective we can expect more drastic improvements. At the moment, since energy storage in link with the electricity grid has not yet become a financially viable reality, the technologies associated to this concept still have relatively high costs. However, both research & development activities, as well as market integration, are expected to work towards drastic cost reduction in the next period. Regarding electrolysis, from a current CAPEX cost of 900 Euro/kW for alkaline technology the tendency is to lower the cost to a level of 400 Euro/kW, respectively 700 Euro/kW for PEM technology in 2030. The expected decrease in OPEX costs is lower, from a current level of 2.2% of the CAPEX to a level of 2%, but added over the total project duration it can account for an improvement in financial indicators. Concerning methanation, it is expected that the CAPEX costs will drop from 900

Euro/kW towards 500 Euro/kW in the next 15 years, while the OPEX costs will reduce to half, from the current rate of 10% of the CAPEX to a rate of 5% in 2030 [8, 9, 10, 11] (Table 8.21).

The analysis will also take into consideration an increase in the natural gas price from the current level situated around 19 Euro/MWh to 25 Euro/MWh until 2030, in accordance with the energy price increase tendency from other European Union member countries [9]. As part of the analysis we assume that the price of electricity remains stable as this is expected to be one of the consequences of the increased share of renewable energy, after the initial increase needed for encouraging the penetration rate. The revenue structure taken into consideration inside the current analysis includes valorizing the renewable hydrogen or SNG, the oxygen produced by the electrolysis units, as well as the residual heat coming out of the methanation unit.

Table 8.21 Economic assumptions taken into consideration for the 2015 and 2030 comparative assessment of Power-to-Gas

	2015	2030	Reference
Electrolysis			
CAPEX [Euro/kW]	900	400 / 700 (PEM)	[Bertuccioli et al. 2014] [ADEME 2014]
OPEX [% of CAPEX/year]	2,2	2	
Methanation			
CAPEX [Euro/kW]	950	500	[DNV KEMA Energy & Sustainability 2013] [ADEME 2014]
OPEX [% of CAPEX/year]	10	5	

8.5.2 2030 Romanian case using alkaline electrolysis

The high-level analysis/technical sizing of the 2030 alkaline electrolysis scenario of the Romanian case is performed similarly with what was exhaustively presented in the previous section dealing with the 2015 scenario. Using the same methodology, price threshold and electrolyser capacity scenarios were created. The technical and economic parameters concerning the electrolysis and the methanation processes (Table 8.20) were modelled in ODYSSEY in order to compare the scenarios on the basis of the updated KPIs, using LCOE as the comparison indicator. From the methodological point of view, the approach is similar to the one used for the 2015 scenarios, thus only the different assumptions and results will be highlighted in this section.

Table 8.22 LCOE of the 2030 Power-to-Gas Hydrogen pathway using alkaline electrolysis

		Energy price thresholds [Euro]					
		20	30	40	50	60	70
LCOE [Euro/MWh]	Electrolyser size						
	10 MW	189.30	52.80	50.43	51.89	53.30	54.69
	20 MW	92.60	58.09	54.34	54.81	55.93	57.11
	30 MW	104.79	64.22	58.85	58.21	59.04	60.01
	40 MW	119.43	71.21	64.04	62.14	62.64	63.41
	50 MW	140.16	80.65	70.98	67.42	67.51	68.04

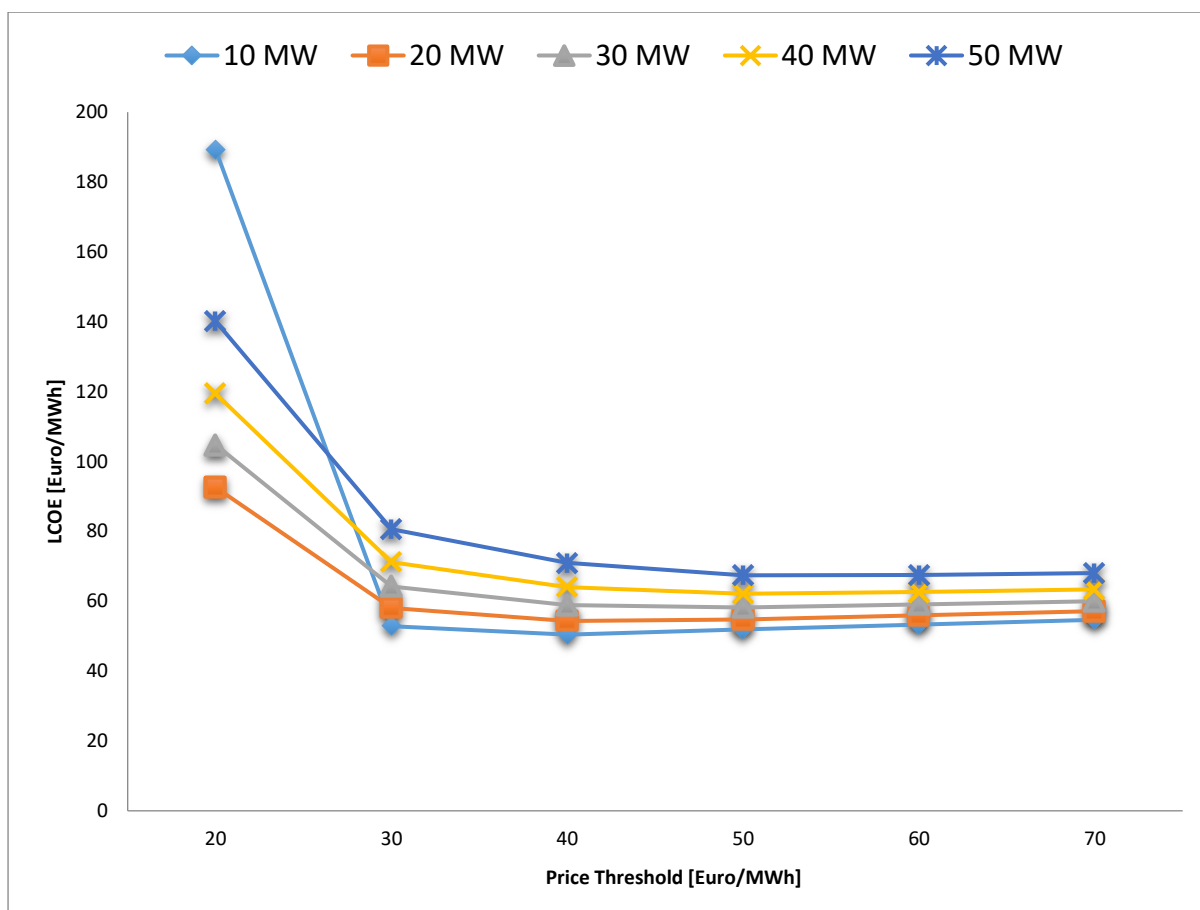

Figure 8.12 Levelized Cost of Energy depending on different energy market price threshold values in the 2030 Power-to-Gas Hydrogen pathway using alkaline electrolysis

Table 8.22 and Figure 8.12 present the results of the technical sizing, indicating that the optimum scenario for the 2030 Power-to-Gas Hydrogen using alkaline electrolysis pathway

consists in using a 10 MW installed capacity electrolysis facility and an operating strategy that imposes a 40 Euro/MWh price threshold.

Table 8.23 LCOE of the 2030 Power-to-Gas SNG pathway using alkaline electrolysis

		Energy price thresholds [Euro]					
Electrolyser size		20	30	40	50	60	70
LCOE [Euro/MWh]	10 MW	286.49	85.98	82.54	84.65	86.69	88.70
	20 MW	143.57	93.62	88.19	88.87	90.49	92.20
	30 MW	161.21	102.49	94.72	93.79	94.99	96.40
	40 MW	182.41	112.61	102.22	99.47	100.21	101.31
	50 MW	212.40	126.26	112.27	107.12	107.26	108.02

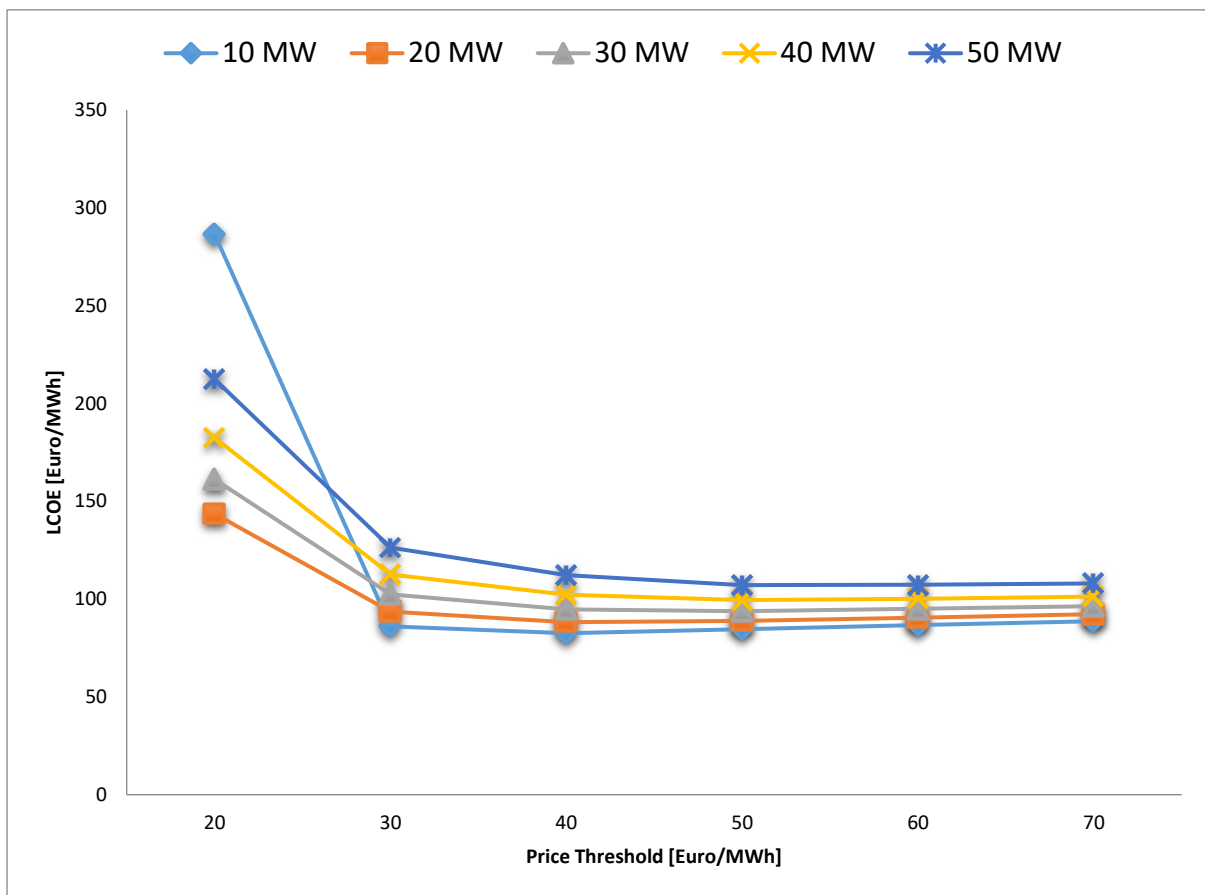

Figure 8.13 Levelized Cost of Energy depending on different energy market price threshold values in the 2030 Power-to-Gas SNG pathway using alkaline electrolysis

Table 8.23 and Figure 8.23 reveal the results of the technical analysis for the Power-to-Gas SNG pathway. The optimum scenario is once again obtained for a 10 MW capacity of the

electrolysis units and an operating strategy that consist in using a 40 Euro/MWh price threshold, scenario that will be further evaluated in the economic analysis.

For the DCF valuation model for the 2030 Power-to-Gas Hydrogen using alkaline electrolysis pathway we updated the assumptions with the ones presented in Table 8.21 and Table 8.22. In addition, the fact that alkaline electrolyzers are expected to reach a lifetime of 90,000 hours [ADEME 2014] [Bertuccioli et al. 2014] before stack replacement is also taken into consideration. In conjunction with an updated capacity factor of the electrolysis units of 45.1% for the 10 MW electrolysis capacity and 40 Euro/MWh energy price threshold optimum scenario, this leads to the conclusion that a stack replacement is not required during the life of the Power-to-Gas project, significantly influencing the economic indicators.

Table 8.24 Romanian Case 2030 Power-to-Gas Hydrogen using alkaline electrolysis Inputs

Project type	Power-to-Gas Hydrogen		
Year	2030		
Project size	10 MW		
Threshold	40 Euro/MWh		
Project lifetime	20 years		
Category	Value	Unit	Reference
CAPEX			
Electrolysis	400	Euro/kW	[ADEME 2014]
OPEX			
Electrolysis	2	% of CAPEX/year	[Bertuccioli et al. 2014]
Outputs			
Hydrogen	77.83	kg/h	
Hydrogen (yearly energy output)	26862.5	MWh/year	
Oxygen	622.64	kg/h	
Oxygen (yearly output)	5454326	kg/year	
Economic indicators			
Natural gas price	25	Euro/MWh	[ADEME 2014]
Oxygen price	0.03	Euro/kg	[Agerborg & Lingehed 2013]
Discount rate	10	%	[GDF Suez Energy Romania 2015]
Inflation rate	2	%	
Insurance	0.4	% of CAPEX/year	[Omniasig 2014]

Income tax	16	%	
Technical indicators			
Electrolyser hours per year	3952	hours	
Electrolysis hour during lifetime	79040	hours	
Electrolyser capacity factor	45.11	%	
Electrolyser stack lifetime	90000	hours	[Bertuccioli et al. 2014]
Stack replacements	0		

Table 8.25 Romanian Case 2030 Power-to-Gas Hydrogen using alkaline electrolysis Initial Investment

Investment	CAPEX
Electrolysis	
Electrolysis plant	€ 4,000,000
Natural gas grid connection	
Connection	€ 130,000
Injection station	€ 600,000
Total	
Total Investment	€ 4,730,000

Table 8.24 and Table 8.25 include the major changes made in the assumptions for the current pathway. Using this data as input for the rest of the DCF valuation model, we are able to calculate a final NPV value of the project of – 5 281 821 Euro over a project lifetime of 20 years, for a 10% discount rate.

Using the previously presented approach for a sensitivity analysis on the influence of price premiums for renewable hydrogen over the general economic indicators of the project, we are able to identify the break-even point at 24.2 Euro/MWh.

Table 8.26 Romanian Case 2030 Power-to-Gas Hydrogen using alkaline electrolysis price premiums sensitivity analysis

Price premium [Euro/MWh]	NPV	IRR
0	€ (5,281,822)	
20	€ (836,280)	7.21
40	€ 3,159,303	19.03
60	€ 7,154,887	29.16
80	€ 11,150,470	38.88
100	€ 15,146,054	48.48

120	€ 19,141,637	58.04
140	€ 23,137,221	67.59
Break-even point	24.2 Euro/MWh	

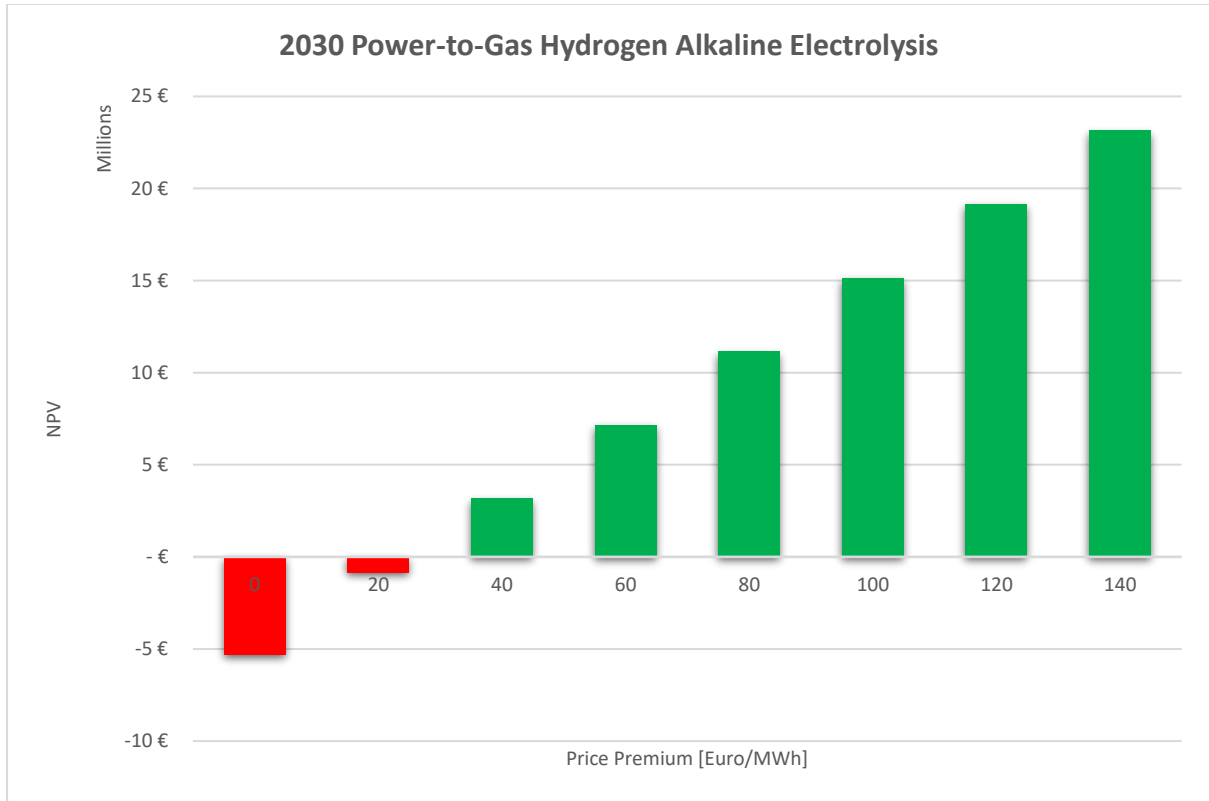

Figure 8.14 Romanian Case 2030 Power-to-Gas Hydrogen using alkaline electrolysis influence of price premiums on the NPV of the project

For the 2030 Power-to-Gas SNG using alkaline electrolysis, the updated parameters regarding the Inputs and the Initial Investment are described by Table 8.27 and Table 8.28.

Table 8.27 Romanian Case 2030 Power-to-Gas SNG using alkaline electrolysis Inputs

Project type	Power-to-Gas SNG		
Year	2030		
Project size	10 MW		
Threshold	40 Euro/MWh		
Project lifetime	20 years		
Category	Value	Unit	Reference
CAPEX			
Electrolysis	400	Euro/kW	[ADEME 2014]

Hydrogen storage	470	Euro/kg	[ADEME 2014]
Methanation plant	500	Euro/kW	[DNV KEMA Energy & Sustainability 2013]
OPEX			
Electrolysis	2	% of CAPEX/year	[Bertuccioli et al. 2014]
Methanation	5	% of CAPEX/year	[ADEME 2014]
Outputs			
Hydrogen	77.83	kg/h	
Hydrogen (yearly energy output)	26862.5	MWh/year	
Oxygen	622.64	kg/h	
Oxygen (yearly output)	5454326	kg/year	
SNG	20872	MWh/year	
Economic indicators			
Natural gas price	25	Euro/MWh	[ADEME 2014]
Oxygen price	0.03	Euro/kg	[Agerborg & Lingehed 2013]
Discount rate	10	%	[GDF Suez Energy Romania 2015]
Inflation rate	2	%	
Insurance	0.4	% of CAPEX/year	[Omniastig 2014]
Income tax	16	%	
Technical indicators			
Electrolyser hours per year	3952	hours	
Electrolysis hour during lifetime	79040	hours	
Electrolyser capacity factor	45.11	%	
Electrolyser stack lifetime	90000	hours	[Bertuccioli et al. 2014]
Capacity of the methanation reactor	2.382	MW	
Required CO ₂	428.06	kg CO ₂ /h	

Table 8.28 Romanian Case 2030 Power-to-Gas SNG using alkaline electrolysis Initial Investment

Investment	CAPEX
Electrolysis	
Electrolysis plant	€ 4,000,000
Hydrogen Storage	

Hydrogen storage tank	€ 1,755,844
Methanation	
Methanation plant	€ 1,191,344
Natural gas grid connection	
Connection	€ 130,000
Injection station	€ 600,000
Total	
Total Investment	€ 7,677,188

The final results of the DCF valuation performed on the 2030 Power-to-Gas SNG using alkaline electrolysis pathway indicate an NPV of – 8 344 864 Euro over a duration of 20 years and for a discount rate of 10%.

Table 8.29 and Figure 8.15 reveal the influence price premiums for SNG might have on the profitability of the project, indicating that the break-even point is reached for a price premium of 49.3 Euro/MWh.

Table 8.29 Romanian Case 2030 Power-to-Gas SNG using alkaline electrolysis price premiums sensitivity analysis

Price premium [Euro/MWh]	NPV	IRR
0	€ (8,344,865)	
20	€ (4,648,925)	-1.59
40	€ (1,441,843)	7.03
60	€ 1,662,746	13.12
80	€ 4,767,335	18.44
100	€ 7,871,924	23.4
120	€ 10,976,514	28.19
140	€ 14,081,103	32.88
Break-even point	49.3 Euro/MWh	

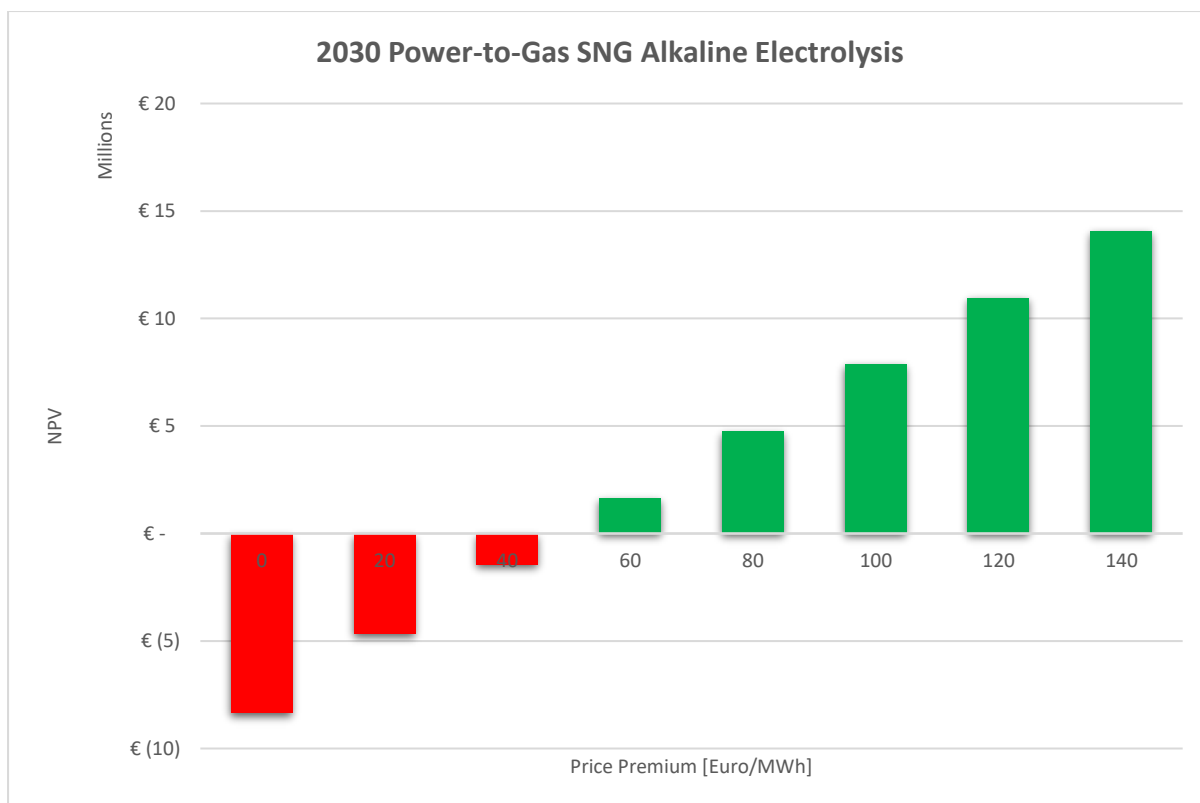

Figure 8.15 Romanian Case 2030 Power-to-Gas SNG using alkaline electrolysis influence of price premiums on the NPV of the project

8.5.3 2030 Romanian case using PEM electrolysis

Using the same previously described methodology, the high-level analysis/technical sizing of the 2030 Romanian case using PEM electrolysis indicates that the optimum scenario involves 10 MW electrolysis units and an operating strategy based on a 50 Euro/MWh energy price threshold for both the Hydrogen and SNG pathway.

Table 8.30 LCOE of the 2030 Power-to-Gas Hydrogen pathway using PEM electrolysis

		Energy price thresholds [Euro]					
		20	30	40	50	60	70
LCOE [Euro/MWh]	Electrolyser size						
	10 MW	292.20	69.69	61.84	59.58	59.99	60.78
	20 MW	141.75	78.69	68.58	64.68	64.66	65.16
	30 MW	161.95	88.97	76.20	70.46	69.99	70.21
	40 MW	186.13	100.56	84.83	77.07	76.09	76.02
50 MW	220.25	116.09	96.27	85.81	84.18	83.75	

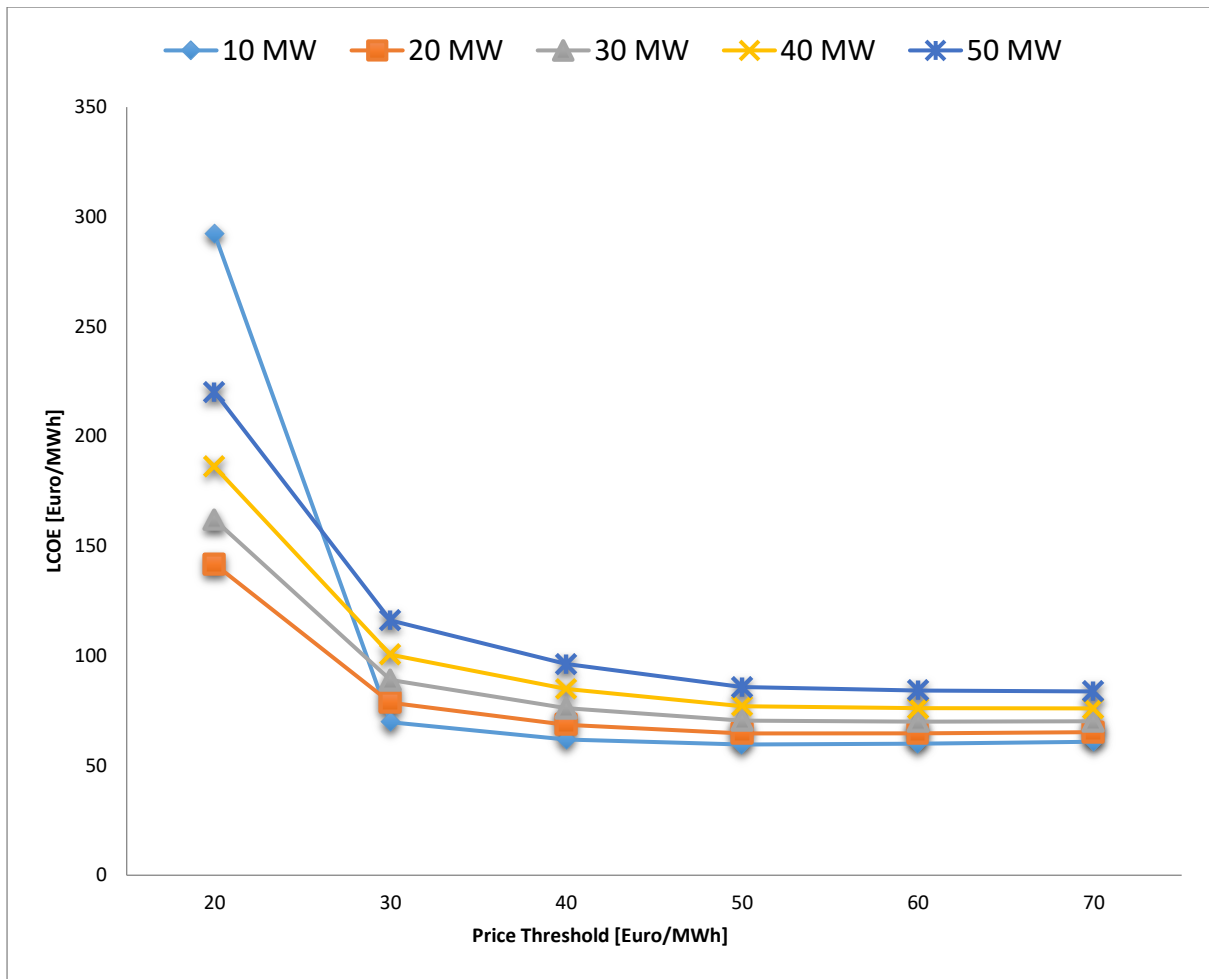

Figure 8.16 Levelized Cost of Energy depending on different energy market price threshold values in the 2030 Power-to-Gas Hydrogen pathway using PEM electrolysis

Table 8.31 LCOE of the 2030 Power-to-Gas SNG pathway using PEM electrolysis

		Energy price thresholds [Euro]					
		20	30	40	50	60	70
LCOE [Euro/MWh]	Electrolyser size						
	10 MW	464.32	116.85	104.75	101.28	101.92	103.12
	20 MW	227.79	130.71	115.14	109.12	109.10	109.88
	30 MW	258.89	146.52	126.86	118.03	117.30	117.64
	40 MW	296.13	164.37	140.15	128.20	126.69	126.58
50 MW	348.66	188.27	157.76	141.65	139.14	138.48	

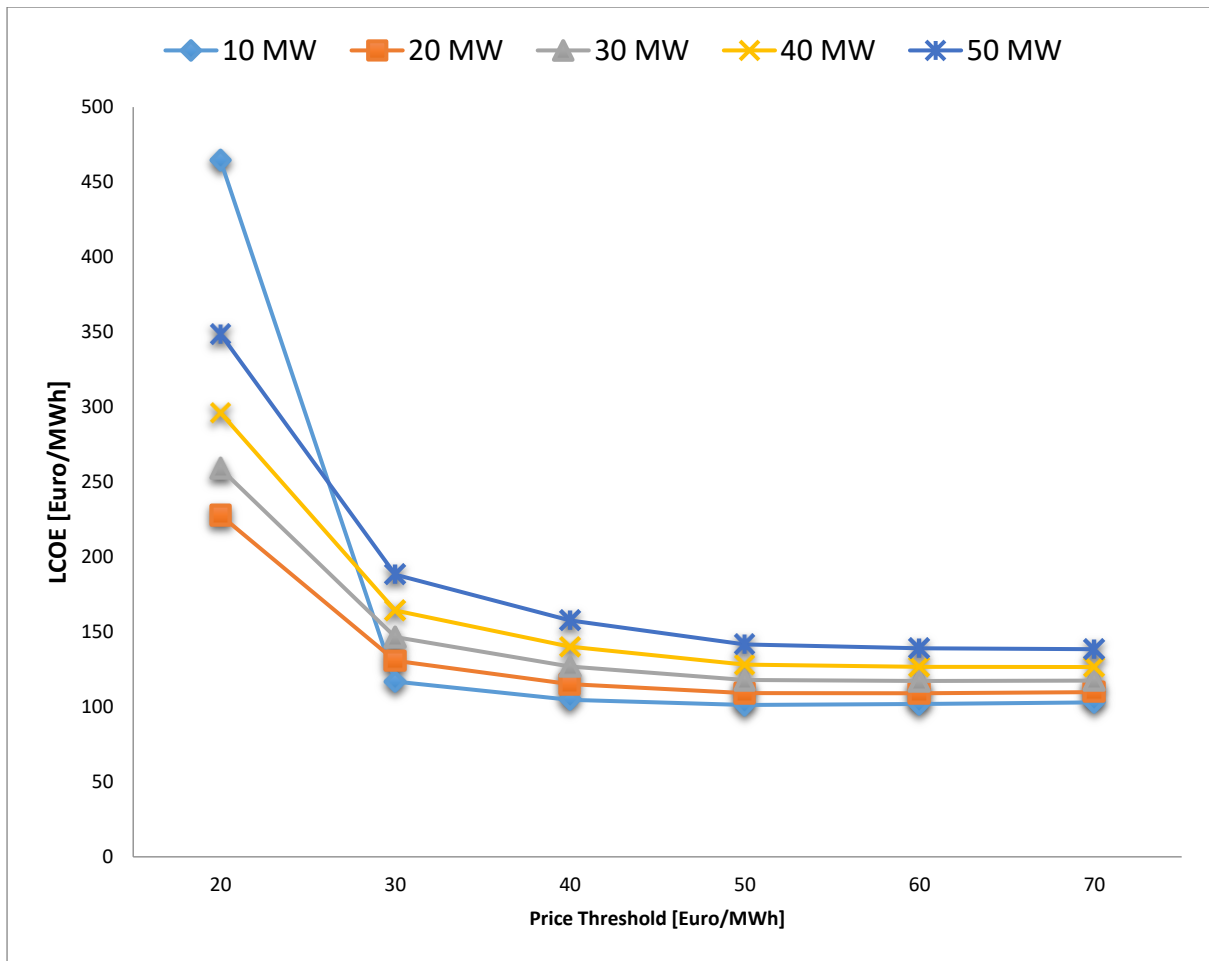

Figure 8.17 Levelized Cost of Energy depending on different energy market price threshold values in the 2030 Power-to-Gas SNG pathway using PEM electrolysis

Table 8.32 and Table 8.33 indicate the Inputs and the Initial Investment taken into consideration for the DCF valuation of the 2030 Power-to-Gas Hydrogen using PEM electrolysis pathway:

Table 8.32 Romanian Case 2030 Power-to-Gas Hydrogen using PEM electrolysis Inputs

Project type	Power-to-Gas Hydrogen		
Year	2030		
Project size	10 MW		
Threshold	50 Euro/MWh		
Project lifetime	20 years		
Category	Value	Unit	Reference
CAPEX			
Electrolysis	700	Euro/kW	[ADEME 2014]
OPEX			

Electrolysis	2	% of CAPEX/year	[Bertuccioli et al. 2014]
Outputs			
Hydrogen	110.58	kg/h	
Hydrogen (yearly energy output)	38167.9	MWh/year	
Oxygen	884.6	kg/h	
Oxygen (yearly output)	7749830	kg/year	
Economic indicators			
Natural gas price	25	Euro/MWh	[ADEME 2014]
Oxygen price	0.03	Euro/kg	[Agerborg & Lingeled 2013]
Discount rate	10	%	[GDF Suez Energy Romania 2015]
Inflation rate	2	%	
Insurance	0.4	% of CAPEX/year	[Omniaisig 2014]
Income tax	16	%	
Technical indicators			
Electrolyser hours per year	5322	hours	
Electrolysis hour during lifetime	106440	hours	
Electrolyser capacity factor	60.75	%	
Electrolyser stack lifetime	80000	hours	[Bertuccioli et al. 2014]
Stack replacements	1		
Year of replacement	15		
Stack replacement cost	50	% of CAPEX	[Bertuccioli et al. 2014]

Note that in the case of using PEM electrolyzers a stack replacement is required due to the higher capacity factor compared to alkaline electrolysis, along with a shorter stack lifetime of just 80000 hours. [ADEME 2014] [Bertuccioli et al. 2014]

Table 8.33 Romanian Case 2030 Power-to-Gas Hydrogen using PEM electrolysis Initial Investment

Investment	CAPEX
Electrolysis	
Electrolysis plant	€ 7,000,000
Natural gas grid connection	
Connection	€ 130,000
Injection station	€ 600,000
Total	
Total Investment	€ 7,730,000

The NPV of the 2030 Power-to-Gas Hydrogen using PEM electrolysis pathway is – 11 650 547 Euro for a discount rate of 10%. Table 8.34 and Figure 8.18 reveal the results of the sensitivity analysis of renewable hydrogen price premiums, indicating that the break-even point is reached for an SNG price premium of 32.7 Euro/MWh.

Table 8.34 Romanian Case 2030 Power-to-Gas Hydrogen using PEM electrolysis price premiums sensitivity analysis

Price premium [Euro/MWh]	NPV	IRR
0	€ (10,278,654)	
20	€ (3,602,654)	1.75
40	€ 2,074,507	13.83
60	€ 7,751,669	23.13
80	€ 13,428,831	31.76
100	€ 19,105,993	40.18
120	€ 24,783,155	48.52
140	€ 30,460,316	56.84
Break-even point	32.7 Euro/MWh	

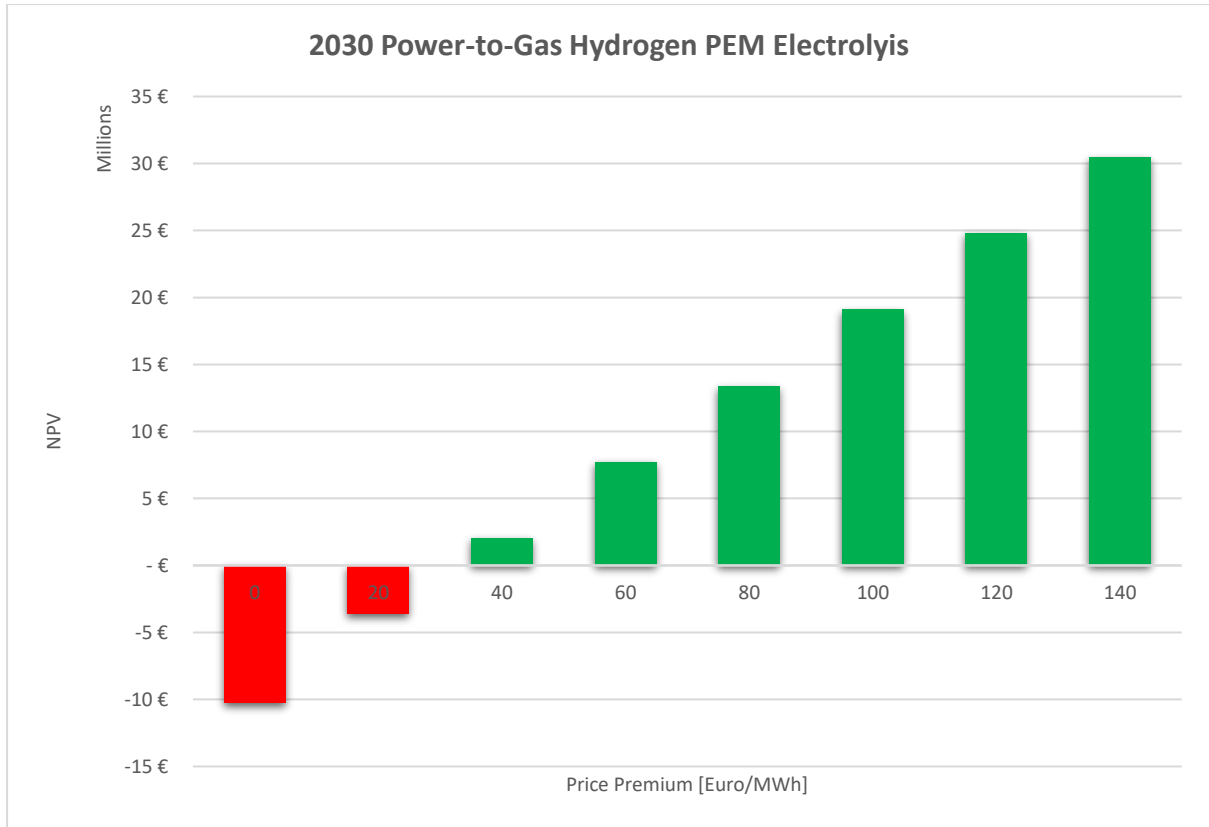

Figure 8.18 Romanian Case 2030 Power-to-Gas Hydrogen using PEM electrolysis influence of price premiums on the NPV of the project

For the 2030 Power-to-Gas SNG using PEM electrolysis, the DCF valuation is using the Inputs and the Initial Investment figures presented by Table 8.35 and 8.36.

Table 8.35 Romanian Case 2030 Power-to-Gas SNG using PEM electrolysis Inputs

Project type	Power-to-Gas SNG		
Year	2030		
Project size	10 MW		
Threshold	50 Euro/MWh		
Project lifetime	20 years		
Category	Value	Unit	Reference
CAPEX			
Electrolysis	700	Euro/kW	[ADEME 2014]
Hydrogen storage	470	Euro/kg	[ADEME 2014]
Methanation plant	500	Euro/kW	[ADEME 2014]
OPEX			

Electrolysis	2	% of CAPEX/year	[Bertuccioli et al. 2014]
Methanation	5	% of CAPEX/year	[ADEME 2014]
Outputs			
Hydrogen	110.58	kg/h	
Hydrogen (yearly energy output)	38167.9	MWh/year	
Oxygen	884.6	kg/h	
Oxygen (yearly output)	7749830	kg/year	
SNG	28070.8	MWh/year	
Economic indicators			
Natural gas price	25	Euro/MWh	[ADEME 2014]
Oxygen price	0.03	Euro/kg	[Agerborg & Lingeled 2013]
Discount rate	10	%	[GDF Suez Energy Romania 2015]
Inflation rate	2	%	
Insurance	0.4	% of CAPEX/year	[Omniastig 2014]
Income tax	16	%	
Technical indicators			
Electrolyser hours per year	5322	hours	
Electrolysis hour during lifetime	106440	hours	
Electrolyser capacity factor	60.75	%	
Electrolyser stack lifetime	80000	hours	[Bertuccioli et al. 2014]
Stack replacements	1		
Year of replacement	15		
Stack replacement cost	50	% of CAPEX	[Bertuccioli et al. 2014]
Capacity of the methanation reactor	3.204	MW	
Required CO ₂	618.19	kg CO ₂ /h	

Table 8.36 Romanian Case 2030 Power-to-Gas SNG using PEM electrolysis Initial Investment

Investment	CAPEX
Electrolysis	
Electrolysis plant	€ 4,000,000
Hydrogen Storage	
Hydrogen storage tank	€ 2,494,684
Methanation	

Methanation plant	€ 1,602,216
Natural gas grid connection	
Connection	€ 130,000
Injection station	€ 600,000
Total	
Total Investment	€ 11,826,900

The NPV of the 2030 Power-to-Gas SNG using PEM electrolysis is – 16 319 956 Euro for a project duration of 20 years and a discount rate of 10%. The sensitivity analysis performed on the SNG price premiums reveals that the break-even point is reached for 71.2 Euro/MWh. (Table 8.37 and Figure 8.19).

Table 8.37 Romanian Case 2030 Power-to-Gas SNG using PEM electrolysis price premiums sensitivity analysis

Price premium [Euro/MWh]	NPV	IRR
0	€ (16,319,956)	
20	€ (11,349,357)	
40	€ (6,556,430)	-3.16
60	€ (2,355,333)	6.38
80	€ 1,845,765	12.51
100	€ 6,046,862	17.61
120	€ 10,247,960	22.24
140	€ 14,449,058	26.61
Break-even point	71.2 Euro/MWh	

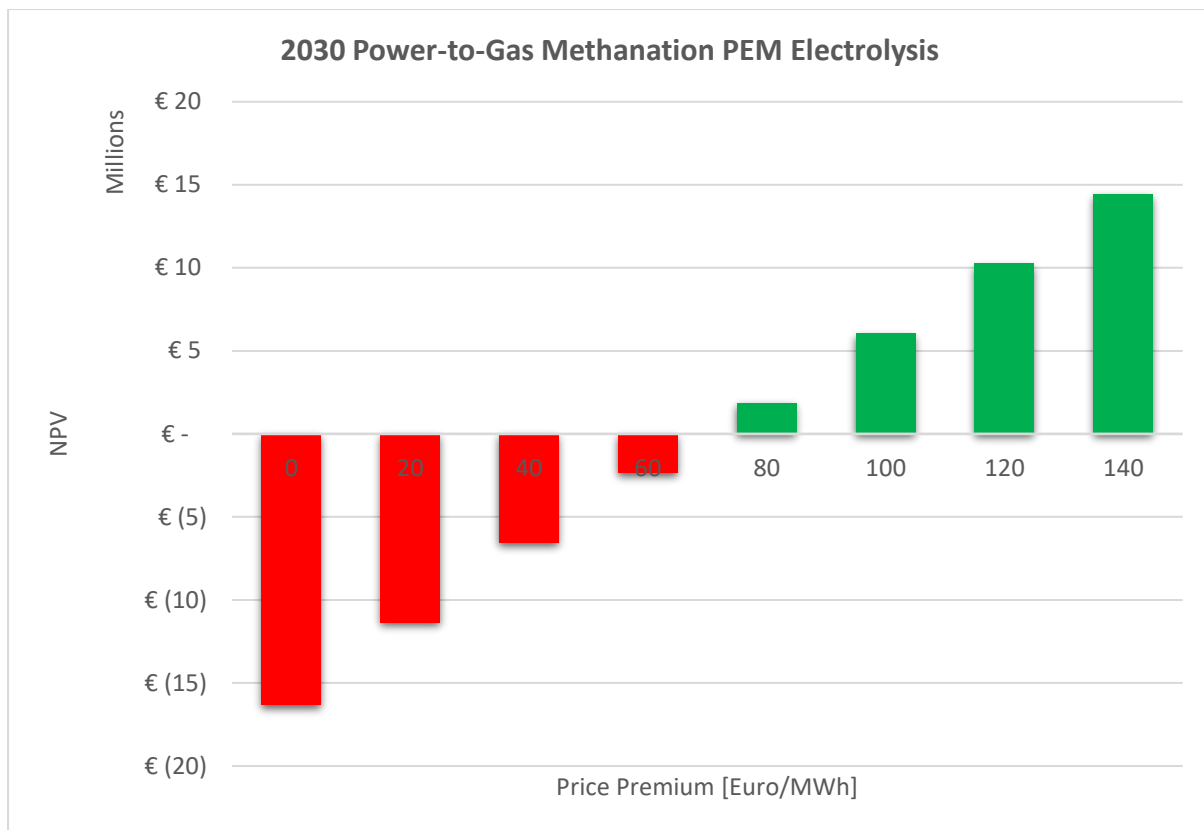

Figure 8.19 Romanian Case 2030 Power-to-Gas SNG using PEM electrolysis influence of price premiums on the NPV of the project

8.6 DISCUSSION

The approach used for the technical and economic evaluation of the Power-to-Gas process proved to be efficient and flexible in terms of understanding the influence that various parameters have on the viability of the process. It focuses on economic parameters since the evaluation was performed from an investor's point of view and it has the potential of being used as an analysis framework for individual Power-to-Gas projects that are not related to a holistic overview of a national or regional energy system.

On account of the results of the primary analysis it is safe to acknowledge that in the described current (2015) Romanian context, the most economically promising solution implies a low installed capacity electrolysis plant (10 MW in our case) and an energy price threshold set at a high value of 70 Euro/MWh, in both of the pathways taken into consideration as part of this article: Power-to-Gas Hydrogen and SNG. This result can be explained by the high initial capital investment costs of the components of the Power-to-Gas technology, especially

electrolysis and methanation, and the fact that in order to amortize these costs on a per MWh basis, the production facilities need to operate for as long as possible, meaning that they need to be fed as much energy from renewable sources as possible.

The results of the economic analysis point towards the fact that in the current context (2015) and without incentives Power-to-Gas is not economically feasible, not even in the conservative scenarios taken into consideration in this article that included co-localization of all the stages of the process (therefore minimum resource transport costs) and zero costs for CO₂. Consequently, the feasibility of a business case surrounding Power-to-Gas is strongly dependent on support policy measures that would create the legal framework of awarding price premiums for renewable hydrogen and renewable methane, which are not currently treated as biogas in the existing Romanian legislation. We can speculate that if the definition of biogas from the current legal framework would extend over renewable hydrogen and methane, then the Power-to-Gas Hydrogen pathway would become profitable [RES-Legal 2014].

From an economic point of view, the Romanian energy context is not specifically favorable for Power-to-Gas. While there certainly is a significant quantity of cheap electric energy, the price of natural gas is among the lowest in the European Union (due to ensuring an important part of the consumption from the internal production) and the market has not been yet completely liberalized [Departamentul pentru Energie 2014].

The more detailed economic analysis focuses on the point of view of an investor in Power-to-Gas, taking into account solely the price arbitrage function of the technology, while leaving aside its energy storage, energy transport and possibly the environmental functions. Their financial value is at the moment difficult to quantify, but unquestionably the latter are of interest for the energy system as a whole, rather than for a private investor. Therefore, in order to encourage investors to leverage such technologies that would bring undoubtable benefits to the energy system, we can underline the need for support policy that would ease the transition through the technological valley of death.

In the 2030 scenario, due to reduced CAPEX and OPEX costs, the operating strategy shifts to using a lower energy price threshold (40 Euro/MWh for alkaline electrolysis and 50 Euro/MWh for PEM electrolysis) for the Hydrogen pathway, as well as for the SNG pathway, which is a more natural choice given that more electricity is supplied to the energy market by the wind turbines in this case. In addition, a lower energy price threshold means less energy fed to the Power-to-Gas process, therefore a lower size for the methanation unit compared to the 2015

scenario. The evolution in terms of economic feasibility is significant in the 2030 scenario. Although price premiums are still required for achieving positive NPVs, their value is much reduced compared to the 2015 scenario, to more acceptable values.

For 2015, PEM is just starting to become a real solution for large Power-to-Gas projects, with the first MW units reaching the market. However, the obvious choice in terms of electrolysis is still the alkaline technology, commercially mature and significantly cheaper for the moment. However, by 2030, PEM electrolysis is expected to reach commercial maturity for MW scale units, as well as offering a lifetime comparable to alkaline units. Both electrolysis technologies are expected to become more efficient in the next 15 years, with PEM developing an edge over alkaline in this domain. However, the results of the simulation revealed that the advantages of PEM electrolysis in terms of efficiency and flexibility will not be able to compensate the significant difference in CAPEX costs that will still exist in 2030 and that the most profitable scenarios will still include alkaline electrolysis. Depending on the evolution the balancing market might have, it is possible that the increased flexibility of PEM electrolysis will bring additional incentives for using this technology in the future. At the 2030 horizon, SOEC (Solid Oxide Electrolysis Cell) technology can also be taken into consideration as it provides an interesting path for the valorization of the excess heat produced by the methanation process, but commercially mature multi-MW scale units are uncertain.

At the moment, the legislation regarding energy storage, including Power-to-Gas, is in the early stages of development at European level and the lack of a regulatory environment limits the deployment of storage technologies for the time being. However, this is expected to change on medium and long term as the new targets in emission reduction [European Climate Foundation 2010] will not be achievable by deploying grid expansion measures which at the moment could represent the cheaper alternative to energy storage, but without offering the same functions.

9 LEVERAGING POWER-TO-GAS IN THE FRENCH CONTEXT WITH PARTICIPATION TO THE BALANCING MARKET

9.1 FRENCH ENERGY CONTEXT

Traditionally, France is a country that has been relying on an energy mix dominated by nuclear power (more than 49% of the installed capacity in 2013, but producing approximately 73 percent of the total energy output). Renewable energy sources, such as wind and solar energy, only managed to generate a total of 4% of the total electricity in 2013, with hydro power delivering the biggest share of “green” energy. Due to its significant nuclear capacities, the French energy mix is very solid when it comes to the base-load portion of the load curve, but the country is a net importer of peak electricity.

For the moment, France fell short of reaching the imposed 2020 ambitious targets regarding renewable energy (a 23% of the final energy consumption), but the level of support for this type of energy is high, thus a constant growth of the sector is expected on short and medium term. Since the future of nuclear energy in Europe is uncertain, meaning that France probably will not develop its capabilities above the current level, and the geographic potential for hydro power plants is limited, France will probably have to adapt to a new energy paradigm that will bring important changes and opportunities to the energy system [Deloitte 2015].

9.2 INTEGRATING POWER-TO-GAS AND THE BALANCING MARKET

9.2.1 Balancing mechanisms

The way the energy system works imposes a permanent equilibrium between electricity consumption and electricity production in order to keep the value of the frequency at the nominal level of 50 Hz (in Europe). Therefore, TSOs (Transmission System Operators) have put in place balancing mechanisms intended to work together for ensuring the required state of equilibrium.

In the case of the French energy system that is the subject of this chapter, the TSO (in this case RTE) is using three mechanisms in order to achieve the previously mentioned equilibrium between production and consumption [RTE 2014] [Guinot et al. 2015] :

- Primary control reserve – in which the power level is adjusted in an automatic manner through bilateral contracts, activated within 30 seconds.
- Secondary control reserve – the power level is adjusted automatically using the corrective signal emitted by RTE, activated between 30 seconds and 15 minutes.
- Tertiary control reserve – manual adjustment imposed by RTE through bilateral contracts or market scheme

9.2.2 Advantages of using Power-to-Gas in conjunction with the balancing market

The central components of a Power-to-Gas system are the electrolysis units that have the role of transforming electricity into hydrogen, allowing energy to be stored as hydrogen, thus creating a buffer between the electricity network and the natural gas network. Energy storage generally translates into an increased degree of flexibility and this is one of the key features that Power-to-Gas can add to the energy system, with potential applications in the balancing market.

According to [Bertuccioli et al. 2014], electrolysis units have a large degree of flexibility, being capable of operating in dynamic conditions, whether we are talking about alkaline or PEM technology. Alkaline, the current “off-the-shelf” electrolysis technology allows a ramp up time from minimum to full load in a matter of several seconds, with an average value of 7-

13% of the full load per second. Ramping down from full load is as well performed in a matter of seconds, with a 10-20% of the full load per second response time, making alkaline electrolysis a good choice for providing balancing services. On the other hand, PEM electrolyzers represent an even better solution for balancing services, with ramp up and ramp down times from full load that translate into 40% of full load per second. In addition to this, the minimum part load operation of PEM electrolyzers is as low as 7-9% of the full load today and it is expected to go down to 4% around 2030. From all the currently available power generation technologies, only pumped-hydro energy storage (PHES) can compete with the figures provided for electrolysis [Eurelectric 2011]. However, the shortcomings of PHES (limited geographic potential, significant environmental impact and limited social acceptance) transform it into a solution only acceptable for certain markets, while Power-to-Gas represents a more versatile, decentralized alternative that is not limited by geographic potential.

9.2.3 Balancing market – a high value market for Power-to-Gas applications?

The analysis of the Romanian context clearly indicated that Power-to-Gas has a hard time achieving economic efficiency without either entering additional high-value markets or receiving price premiums for renewable hydrogen or SNG. Identifying high-value markets is a difficult task that is highly dependent on the particularities of each project, but the balancing market is generally considered one of the potential candidates that can enable Power-to-Gas to deploy its technical benefits to the energy system, while providing additional financial value to the project.

When a Power-to-Gas plant is coupled with a renewable energy generation source, it is not running full time at maximum capacity. As we have presented in the chapter studying the Romanian case, the capacity factor is generally around 65-70% and one of the conclusions of the technical and economic evaluation was that a higher capacity factor would help compensate the high initial CAPEX costs of the electrolysis units, leading to better overall economic indicators of the project. While energy arbitrage between the electricity and the natural gas market can remain the primary function of a Power-to-Gas facility, providing ancillary services on the balancing market potentially represents a secondary function that can increase the capacity factor of the system. The technical and economic viability of such a strategy will be analyzed in the current chapter, choosing the current French energy system as a case study.

9.3 TECHNICAL AND ECONOMIC EVALUATION OF POWER-TO-GAS IN THE FRENCH CONTEXT

9.3.1 Methodology

The case study that will represent the focus of this chapter will consist of a Power-to-Gas facility using alkaline electrolysis that will work in conjunction with a simulated 50 MW wind park. Evaluating the French case will consist of two distinct stages: the high-level analysis/technical sizing of the core Power-to-Gas components, with the aim of establishing the optimum size of the electrolysis units and the operating strategy that will lead to the lowest levelized price of hydrogen and the economic analysis that will evaluate the key financial indicators of the project over its lifetime, in a similar manner with the one presented in the Romanian case.

The technical and economic evaluation of leveraging Power-to-Gas in the current French context will benefit from a slightly different approach than the one used for the Romanian context. Although the analysis framework will remain largely unchanged, there are going to be several major changes regarding the high-level analysis/technical sizing, which will be performed in a more efficient manner that will allow us to consider the potential of using the primary control reserve mechanism as a high-value market for the specific Power-to-Gas application. In our analysis, the main function of the Power-to-Gas facility will continue to be the production of hydrogen from renewable energy, participating to the EPEX spot DAM market. However, when the economic conditions are favorable and providing system services can bring an additional economic advantage, the facility will also operate on the balancing market. An additional simulation will be performed without taking into account the participation to the balancing market, in order to quantify the economic advantage.

Odyssey, the same software tool used for the Romanian case, will enable us to perform the high-level analysis/technical sizing using the same principle of imposing price thresholds for various electrolysis capacity scenarios, but taking into account the participation of the Power-to-Gas facility to the EPEX spot DAM market, as well as to the balancing market. In addition, thresholds for the upward and downward offered prices on the balancing market will be imposed, choosing a set of four variable parameters that are going to be used for creating a

high number of scenarios that will be analyzed using Odyssey on the basis of one indicator: the Levelized Hydrogen Production Cost, as described by [Guinot et al. 2015] (Table 9.1):

$$\text{Levelized } H_2 \text{ production cost} = \frac{\sum \text{CAPEX} + \sum_l \text{OPEX} + \sum_l^{\text{exp}} \text{DAM} + \sum_l^{\text{exp}} \text{BAM} - \sum_l^{\text{rev}} \text{BAM}}{\sum_l^{\text{prod}} H_2}$$

Where:

$\sum \text{CAPEX}$ – represents the investment in the electrolysis unit

$\sum_l \text{OPEX}$ – represents the levelized sum of the O&M costs associated to the electrolyzers

$\sum_l^{\text{exp}} \text{DAM}$ – levelized sum of the expenses for purchasing energy on the EPEX spot DAM

$\sum_l^{\text{exp}} \text{BAM}$ – levelized sum of the expenses for purchasing energy on the BAM

$\sum_l^{\text{rev}} \text{BAM}$ – the levelized sum of the revenues from the BAM

Table 9.1 Parameters taken into account for evaluating the optimum scenario for the French case

Parameter	Minimum	Maximum	Step
Electrolyser capacity [MW]	10	50	1
EPEX spot DAM energy price [Euro/MWh]	20	80	2
BAM upward offered price [Euro/MWh]	20	120	2
BAM downward offered price [Euro/MWh]	20	120	2

The participation of the Power-to-Gas plant to the EPEX spot DAM market is modelled by imposing a constant energy price at which the plant operator is willing to take in renewable energy, which is one of the parameters that will be optimized using Odyssey. The imposed price is confronted to historical EPEX spot DAM market prices for each time interval in order to decide whether or not energy is fed to the Power-to-Gas facility:

- If the historical price is lower than the imposed threshold, the Power-to-Gas facility receives renewable energy
- If the imposed threshold is lower than the historical price, the energy is sold on the EPEX spot DAM market.

When operating on the balancing market, the Power-to-Gas plant has to make two types of offers for a 30 minutes' interval:

- Upward offers – when the plant is proposing to reduce its energy consumption and is compensated by the TSO at the offered price.
- Downward offers - the plant increases its energy consumption and buys that specific energy from the TSO at the offered price.

Figure 9.1 depicts the basic operating principles of the balancing market mechanism, as described by [RTE 2010]. In order to decide the energy contracted for every time interval, the two types of offers are compared to historical weighted average prices and the total contracted energy volume. This results in a power profile for the Power-to-Gas plant associated with the balancing market. This profile is added to the power profile associated to the EPEX spot DAM market and the results is the overall power profile of the Power-to-Gas plant over the desired period, which allows the calculation of the hydrogen output. Since the project will take into consideration a 20-year lifetime for the Power-to-Gas facility, the one-year interval that was simulated will be multiplied for the whole period.

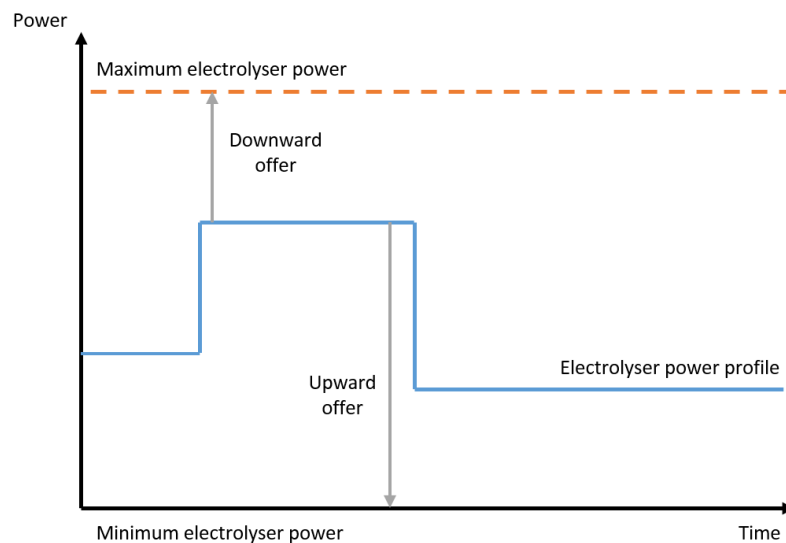

Figure 9.1 Balancing market mechanism (source: RTE)

Along with the electrolyser capacity and the EPEX spot DAM price, the upward and downward offer price will represent parameters that will be optimized in Odyssey in order to obtain the most efficient technical sizing.

Data collection:

For the French scenario, data regarding the energy production of a real-life wind park was not publicly available, therefore a different approach was chosen for obtaining a one-year energy production curve for a simulated 50 MW wind energy park. The total wind energy production on a half-hour time step throughout the territory of France was taken into consideration for the same period used in the Romanian context (December 2012 – November 2013) [Eco2Mix 2015]. The next step consisted in establishing the total wind energy production capacity in France, using the previously cited source. Dividing the total French wind energy installed capacity to 50 MW allowed us to obtain a scaling factor that was applied to the total wind energy production on a half-hour time step, in order to have energy input data similar to the ones used for evaluating Power-to-Gas in the Romanian context. The energy production profile was linked with the EPEX spot DAM market prices in France for the same period (Figure 9.1 and 9.2). As an observation, the energy output of the French 50 MW wind park was similar to the output of the 50 MW wind park studied in the Romanian case, with a difference of less than 5% in the yearly energy production. However, there was a significant difference of 30 percent in the electricity price on the DAM market.

The upward total activated power, upward weighted average price, upward maximum price activated, as well as the downward total activated power, downward weighted average price and downward minimum price activated parameters required for simulating the participation of the Power-to-Gas plant on the balancing market were imported from [Eco2Mix 2015] for the one year period previously mentioned.

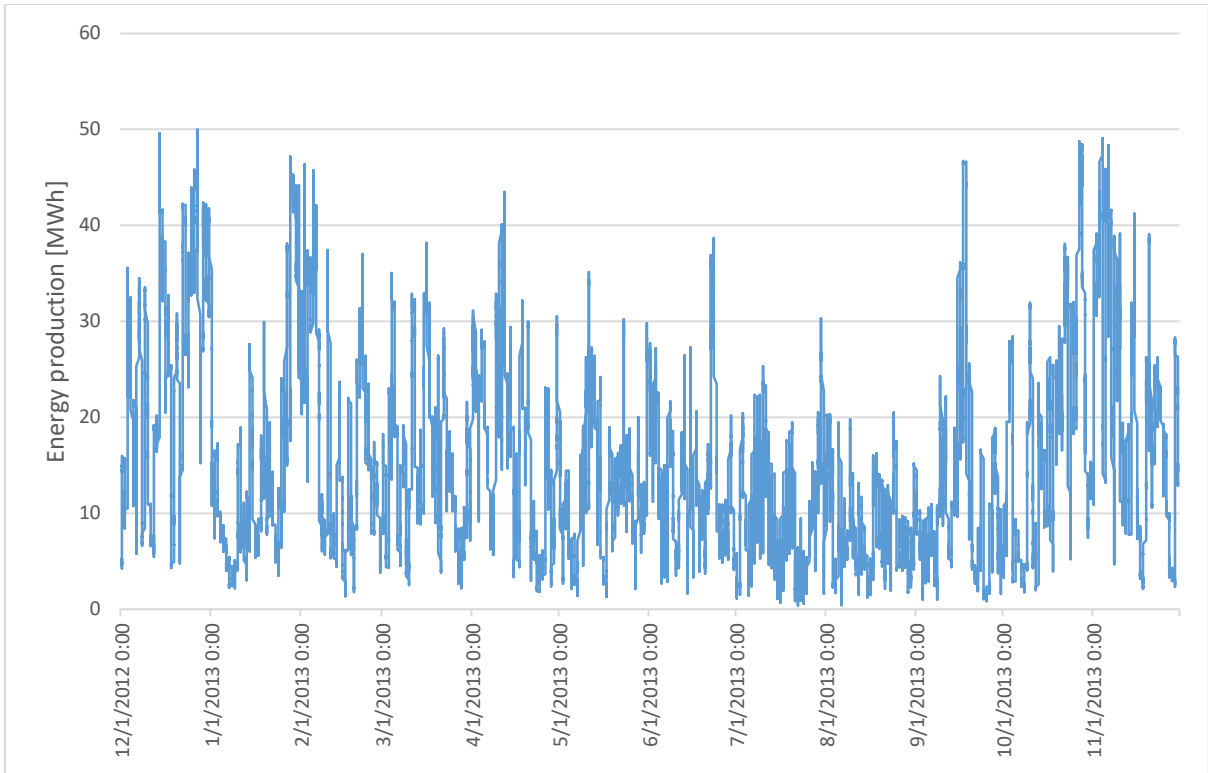

Figure 9.2 Energy production of the simulated wind park in the French context

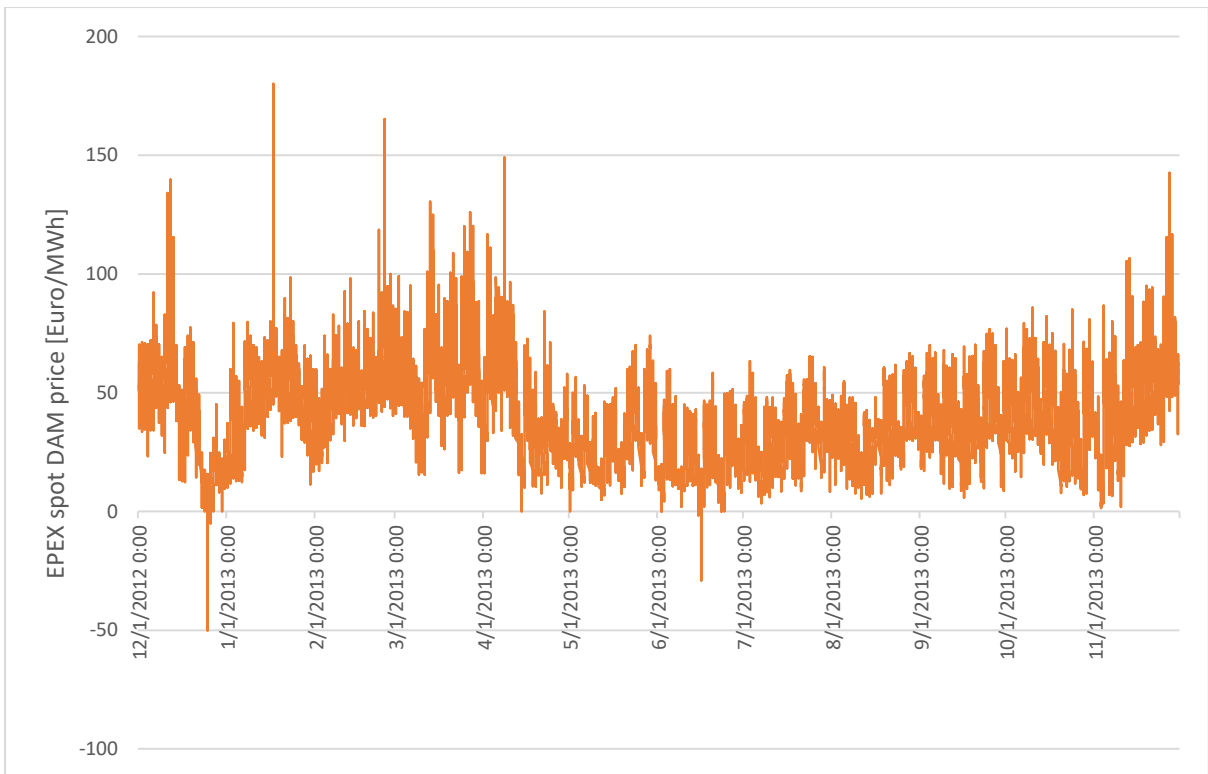

Figure 9.3 EPEX spot DAM prices corresponding to the energy production of the simulated wind park in the French context

9.3.2 Technical sizing

For the first part of the T&E analysis of Power-to-Gas in the French case only the electrolysis stage of the Power-to-Gas process is modeled in Odyssey in order to determine the optimum size of the facility and the optimum operating strategy. Table 9.2 presents the key parameters of modeling Power-to-Gas in the French context, with participation to the balancing market, in Odyssey. Note that for this part of the simulation (high-level analysis/technical sizing) the stack replacement cost was left out of the boundaries of the study, but was later included in the complete economic evaluation of the optimum scenario.

Table 9.2 Key parameters of modeling the French Case in Odyssey

	Value	Unit	Reference
Technology	Alkaline		[Bertuccioli et al. 2014]
Electricity input	53	kWh _{el} /kgH ₂	
LHV efficiency	62	%	
Minimum load	20	% of full load	
H₂ output pressure	30	bar	
Operating temperature	70	Celsius	
Availability	8585	Hours/year	
CAPEX	900	Euro/kW	
OPEX	2.2% of CAPEX	Euro/year	
BAM participation tax	25000	Euro	[Guinot et al. 2015]
BAM participation yearly tax	10000	Euro/year	
BAM trading fees	0.07	Euro/MWh	
Discount rate	8	%	

Instead of manually calculating each scenario, for the case study on which this chapter is focused, we relied on using Odyssey's optimization function on all the scenarios created with the variable parameters presented in Table 9.1. The optimum scenario was the one that offered the lowest levelized cost of hydrogen (the absolute value is not important, being used at this stage in our case for a comparative purpose). The simulation was run using two hypotheses: with and without participating to the balancing market and the results are presented in Table 9.3:

Table 9.3 Results of the optimization process performed in Odyssey

Parameter	Participating on the BAM	Without participating on the BAM
Electrolyser capacity [MW]	10	10
EPEX spot DAM energy price [Euro/MWh]	48	52
BAM upward offered price [Euro/MWh]	70	-
BAM downward offered price [Euro/MWh]	36	-

The two optimum scenarios will be used for the economic analysis of Power-to-Gas in the French context in two pathways: Hydrogen and SNG.

9.4 ECONOMIC ANALYSIS OF POWER-TO-GAS IN THE FRENCH CONTEXT

9.4.1 Power-to-Gas Hydrogen

In this specific pathway the hydrogen produced by the electrolysis units from renewable energy (and in a small percentage from energy bought from the balancing market) is injected in the natural gas grid and valued at the price of natural gas. The economic analysis is going to be performed using a basic Discounted Cash Flow (DCF) valuation tool, with the aim of establishing the most important financial indicators an investor might be interested in – Net Present Value (NPV) and Internal Rate of Return (IRR) – in a similar manner with the one used in the previous chapter dealing with the specific Romanian case, therefore only the main differences are going to be highlighted. Table 9.4 contains all the relevant Input parameters of the DCF valuation tool used for analyzing Power-to-Gas Hydrogen pathway in the French context with participation to the balancing market. There are two parameters that have a high impact: the discount rate for the French case which is set at 8% and the price of natural gas of 26 Euro/MWh. Also, the price of oxygen is lower compared to the value taken into consideration for the Romanian case.

Table 9.4 Key Inputs for the economic analysis of Power-to-Gas Hydrogen in the French case with participation to the balancing market

Project type		Power-to-Gas Hydrogen (French case with BAM participation)	
Year		2015	
Project size		10 MW	
EPEX spot DAM energy price threshold		48 Euro/MWh	
BAM upward offered price threshold		70 Euro/MWh	
BAM downward offered price threshold		36 Euro/MWh	
Project lifetime		20 years	
Category	Value	Unit	Reference
CAPEX			
Electrolysis	900	Euro/kW	[Bertuccioli et al. 2014]
OPEX			
Electrolysis	2.2	% of CAPEX/year	[Bertuccioli et al. 2014]
Outputs			
Wind energy (yearly output)	130635	MWh	
Electrolyser energy (yearly)	50321	MWh	
Energy from the EPEX spot DAM (yearly)	43209	MWh	
BAM upward energy (yearly)	1367.1	MWh	
BAM downward energy (yearly)	8556.3	MWh	
Hydrogen	103.4	kg/h	
Hydrogen (yearly energy output)	35688.3	MWh/year	
EPEX spot DAM Hydrogen (yearly output)	30644	MWh/year	
Oxygen	820.6	kg/h	
Oxygen (yearly output)	718895 0	kg/year	
Economic indicators			
Natural gas price	26	Euro/MWh	[ADEME 2014]
Oxygen price	0.0245	Euro/kg	
Discount rate	8	%	[Guinot et al. 2015]
Inflation rate	2	%	
Insurance	0.4	% of CAPEX/year	[Omniasig 2014]
Income tax	16	%	
Technical indicators			
Electrolyser hours per year	5524	hours	
Electrolysis hour during lifetime	110485	hours	
Electrolyser capacity factor	63	%	
Electrolyser stack lifetime	60000	hours	[Bertuccioli et al. 2014]
Stack replacements	1		
First year of replacement	11		

Stack replacement cost	50	% of CAPEX of the electrolysis unit	[Bertuccioli et al. 2014]
------------------------	----	-------------------------------------	---------------------------

Table 9.5 reveals the required Initial Investment made in the Power-to-Gas project, including the 25000 Euro tax that has to be paid in order to gain access to the French balancing mechanism, while Table 9.6 describes the way CAPEX and Depreciation are handled in the DCF valuation tool.

Table 9.5 Initial Investment for Power-to-Gas Hydrogen in the French case (with participation to the balancing market)

Investment	CAPEX
Electrolysis	
Electrolysis plant	€ 9,000,000
Natural gas grid connection	
Connection	€ 130,000
Injection station	€ 600,000
Balancing market	
Participation tax	€ 25,000
Total	
Total Investment	€ 9,755,000

Table 9.6 Power-to-Gas Hydrogen French Case (with BAM participation) CAPEX & Depreciation

Depreciable Assets	€ 9,755,000	Euro			
Depreciation Period	20	years			
	2016	2017	...	2034	2035
	1	2	...	19	20
Depreciation Expense	€ 487,750	€ 487,750	...	€ 487,750	€ 487,750
CAPEX	€ 9,755,000	Euro			

Table 9.7 is covering the Profits & Losses and includes a new category, the Balancing market:

- BAM expenses – represents the difference between the sum received for settling upward imbalances and the sum paid for settling downward imbalances
- Yearly fee – the yearly tax required for participating on the balancing market
- Trading fees – for each MWh traded on the balancing market, a 0.07 Euro fee has to be paid by the Power-to-Gas plant

Table 9.7 Power-to-Gas Hydrogen French case (with participation to BAM) Profits & Losses

Year	2016	2017	2018	2019	2020	2021	2022	2023	2024	2025	2026	2027	2028	2029	2030	2031	2032	2033	2034	2035
	1	2	3	4	5	6	7	8	9	10	11	12	13	14	15	16	17	18	19	20
Revenues																				
Electrolysis																				
Oxygen	€ 176,310	€ 179,836	€ 183,433	€ 187,102	€ 190,844	€ 194,661	€ 198,554	€ 202,525	€ 206,576	€ 210,707	€ 214,921	€ 219,220	€ 223,604	€ 228,076	€ 232,638	€ 237,290	€ 242,036	€ 246,877	€ 251,814	€ 256,851
Hydrogen Injection																				
Injected Hydrogen	€ 927,897	€ 946,455	€ 965,384	€ 984,692	€ 1,004,386	€ 1,024,473	€ 1,044,963	€ 1,065,862	€ 1,087,179	€ 1,108,923	€ 1,131,101	€ 1,153,723	€ 1,176,798	€ 1,200,334	€ 1,224,341	€ 1,248,827	€ 1,273,804	€ 1,299,280	€ 1,325,266	€ 1,351,771
Total Revenues	€ 1,104,207	€ 1,126,292	€ 1,148,817	€ 1,171,794	€ 1,195,230	€ 1,219,134	€ 1,243,517	€ 1,268,387	€ 1,293,755	€ 1,319,630	€ 1,346,023	€ 1,372,943	€ 1,400,402	€ 1,428,410	€ 1,456,978	€ 1,486,118	€ 1,515,840	€ 1,546,157	€ 1,577,080	€ 1,608,622
Expenses																				
Electrolysis																				
Electric Energy	€ 1,261,667	€ 1,286,900	€ 1,312,638	€ 1,338,891	€ 1,365,668	€ 1,392,982	€ 1,420,841	€ 1,449,258	€ 1,478,243	€ 1,507,808	€ 1,537,965	€ 1,568,724	€ 1,600,098	€ 1,632,100	€ 1,664,742	€ 1,698,037	€ 1,731,998	€ 1,766,638	€ 1,801,971	€ 1,838,010
OPEX	€ 198,000	€ 201,960	€ 205,999	€ 210,119	€ 214,322	€ 218,608	€ 222,980	€ 227,440	€ 231,989	€ 236,628	€ 241,361	€ 246,188	€ 251,112	€ 256,134	€ 261,257	€ 266,482	€ 271,812	€ 277,248	€ 282,793	€ 288,449
Insurance	€ 36,000	€ 36,720	€ 37,454	€ 38,203	€ 38,968	€ 39,747	€ 40,542	€ 41,353	€ 42,180	€ 43,023	€ 43,884	€ 44,761	€ 45,657	€ 46,570	€ 47,501	€ 48,451	€ 49,420	€ 50,409	€ 51,417	€ 52,445
Stack Replacement	€ -	€ -	€ -	€ -	€ -	€ -	€ -	€ -	€ -	€ -	€ 5,485,475	€ -	€ -	€ -	€ -	€ -	€ -	€ -	€ -	€ -
Balancing Market																				
BAM Expenses	€ 212,331	€ 216,578	€ 220,909	€ 225,327	€ 229,834	€ 234,431	€ 239,119	€ 243,902	€ 248,780	€ 253,755	€ 258,830	€ 264,007	€ 269,287	€ 274,673	€ 280,166	€ 285,770	€ 291,485	€ 297,315	€ 303,261	€ 309,326
Yearly Fee	€ 10,000	€ 10,200	€ 10,404	€ 10,612	€ 10,824	€ 11,041	€ 11,262	€ 11,487	€ 11,717	€ 11,951	€ 12,190	€ 12,434	€ 12,682	€ 12,936	€ 13,195	€ 13,459	€ 13,728	€ 14,002	€ 14,282	€ 14,568
Trading Fees	€ 695	€ 709	€ 723	€ 737	€ 752	€ 767	€ 782	€ 798	€ 814	€ 830	€ 847	€ 864	€ 881	€ 899	€ 917	€ 935	€ 954	€ 973	€ 992	€ 1,012
Hydrogen Injection																				
Connection	€ 2,600	€ 2,652	€ 2,705	€ 2,759	€ 2,814	€ 2,871	€ 2,928	€ 2,987	€ 3,046	€ 3,107	€ 3,169	€ 3,233	€ 3,297	€ 3,363	€ 3,431	€ 3,499	€ 3,569	€ 3,641	€ 3,713	€ 3,788
Injection station	€ 48,000	€ 48,960	€ 49,939	€ 50,938	€ 51,957	€ 52,996	€ 54,056	€ 55,137	€ 56,240	€ 57,364	€ 58,512	€ 59,682	€ 60,876	€ 62,093	€ 63,335	€ 64,602	€ 65,894	€ 67,212	€ 68,556	€ 69,927
Contingencies	€ 88,465	€ 90,234	€ 92,039	€ 93,879	€ 95,757	€ 97,672	€ 99,626	€ 101,618	€ 103,650	€ 105,723	€ 107,832	€ 109,995	€ 112,195	€ 114,438	€ 116,727	€ 119,062	€ 121,443	€ 123,872	€ 126,349	€ 128,876
Total Expenses	€ 1,857,757	€ 1,894,912	€ 1,932,810	€ 1,971,467	€ 2,010,896	€ 2,051,114	€ 2,092,136	€ 2,133,979	€ 2,176,658	€ 2,220,192	€ 8,024,344	€ 2,309,887	€ 2,356,085	€ 2,403,207	€ 2,451,271	€ 2,500,296	€ 2,550,302	€ 2,601,308	€ 2,653,334	€ 2,706,401
EBITDA	€ (753,550)	€ (768,621)	€ (783,993)	€ (799,673)	€ (815,666)	€ (831,980)	€ (848,619)	€ (865,592)	€ (882,903)	€ (900,562)	€ (6,678,321)	€ (936,944)	€ (955,683)	€ (974,797)	€ (994,293)	€ (1,014,179)	€ (1,034,462)	€ (1,055,151)	€ (1,076,254)	€ (1,097,779)
Depreciation Expense	€ 487,750	€ 487,750	€ 487,750	€ 487,750	€ 487,750	€ 487,750	€ 487,750	€ 487,750	€ 487,750	€ 487,750	€ 487,750	€ 487,750	€ 487,750	€ 487,750	€ 487,750	€ 487,750	€ 487,750	€ 487,750	€ 487,750	€ 487,750

EBIT	€ (1,241,300)	€ (1,256,371)	€ (1,271,743)	€ (1,287,423)	€ (1,303,416)	€ (1,319,730)	€ (1,336,369)	€ (1,353,342)	€ (1,370,653)	€ (1,388,312)	€ (7,166,071)	€ (1,424,694)	€ (1,443,433)	€ (1,462,547)	€ (1,482,043)	€ (1,501,929)	€ (1,522,212)	€ (1,542,901)	€ (1,564,004)	€ (1,585,529)
Financial Expense	€ -	€ -	€ -	€ -	€ -	€ -	€ -	€ -	€ -	€ -	€ -	€ -	€ -	€ -	€ -	€ -	€ -	€ -	€ -	€ -
EBT	€ (1,241,300)	€ (1,256,371)	€ (1,271,743)	€ (1,287,423)	€ (1,303,416)	€ (1,319,730)	€ (1,336,369)	€ (1,353,342)	€ (1,370,653)	€ (1,388,312)	€ (7,166,071)	€ (1,424,694)	€ (1,443,433)	€ (1,462,547)	€ (1,482,043)	€ (1,501,929)	€ (1,522,212)	€ (1,542,901)	€ (1,564,004)	€ (1,585,529)
Income Tax	€ -	€ -	€ -	€ -	€ -	€ -	€ -	€ -	€ -	€ -	€ -	€ -	€ -	€ -	€ -	€ -	€ -	€ -	€ -	€ -
Net Profit	€ (1,241,300)	€ (1,256,371)	€ (1,271,743)	€ (1,287,423)	€ (1,303,416)	€ (1,319,730)	€ (1,336,369)	€ (1,353,342)	€ (1,370,653)	€ (1,388,312)	€ (7,166,071)	€ (1,424,694)	€ (1,443,433)	€ (1,462,547)	€ (1,482,043)	€ (1,501,929)	€ (1,522,212)	€ (1,542,901)	€ (1,564,004)	€ (1,585,529)

Table 9.8 Power-to-Gas Hydrogen French case (with participation to BAM) Cash Flow

Year	2016	2017	2018	2019	2020	2021	2022	2023	2024	2025	2026	2027	2028	2029	2030	2031	2032	2033	2034	2035
	1	2	3	4	5	6	7	8	9	10	11	12	13	14	15	16	17	18	19	20
Operational Cash Flow	€ (753,550)	€ (768,621)	€ (783,993)	€ (799,673)	€ (815,666)	€ (831,980)	€ (848,619)	€ (865,592)	€ (882,903)	€ (900,562)	€ (6,678,321)	€ (936,944)	€ (955,683)	€ (974,797)	€ (994,293)	€ (1,014,179)	€ (1,034,462)	€ (1,055,151)	€ (1,076,254)	€ (1,097,779)
Net Profit	€ (1,241,300)	€ (1,256,371)	€ (1,271,743)	€ (1,287,423)	€ (1,303,416)	€ (1,319,730)	€ (1,336,369)	€ (1,353,342)	€ (1,370,653)	€ (1,388,312)	€ (7,166,071)	€ (1,424,694)	€ (1,443,433)	€ (1,462,547)	€ (1,482,043)	€ (1,501,929)	€ (1,522,212)	€ (1,542,901)	€ (1,564,004)	€ (1,585,529)
Depreciation Expense	€ 487,750	€ 487,750	€ 487,750	€ 487,750	€ 487,750	€ 487,750	€ 487,750	€ 487,750	€ 487,750	€ 487,750	€ 487,750	€ 487,750	€ 487,750	€ 487,750	€ 487,750	€ 487,750	€ 487,750	€ 487,750	€ 487,750	€ 487,750
Investment Cash Flow	€ (9,755,000)																			
CAPEX	€ 9,755,000																			
Financing Cash Flow																				
Total Cash Flow	€ (10,508,550)	€ (768,621)	€ (783,993)	€ (799,673)	€ (815,666)	€ (831,980)	€ (848,619)	€ (865,592)	€ (882,903)	€ (900,562)	€ (6,678,321)	€ (936,944)	€ (955,683)	€ (974,797)	€ (994,293)	€ (1,014,179)	€ (1,034,462)	€ (1,055,151)	€ (1,076,254)	€ (1,097,779)
Cash BoY	€	€ (10,508,550)	€ (11,277,170)	€ (12,061,163)	€ (12,860,836)	€ (13,676,502)	€ (14,508,482)	€ (15,357,101)	€ (16,222,693)	€ (17,105,596)	€ (18,006,158)	€ (24,684,479)	€ (25,621,424)	€ (26,577,107)	€ (27,551,904)	€ (28,546,196)	€ (29,560,375)	€ (30,594,837)	€ (31,649,988)	€ (32,726,243)
Cash EoY	€ (10,508,550)	€ (11,277,170)	€ (12,061,163)	€ (12,860,836)	€ (13,676,502)	€ (14,508,482)	€ (15,357,101)	€ (16,222,693)	€ (17,105,596)	€ (18,006,158)	€ (24,684,479)	€ (25,621,424)	€ (26,577,107)	€ (27,551,904)	€ (28,546,196)	€ (29,560,375)	€ (30,594,837)	€ (31,649,988)	€ (32,726,243)	€ (33,824,022)

Table 9.9 Power-to-Gas Hydrogen French case (with participation to BAM) NPV calculation

			2016	2017	2018	2019	2020	2021	2022	2023	2024	2025	2026	2027	2028	2029	2030	2031	2032	2033	2034	2035
			1	2	3	4	5	6	7	8	9	10	11	12	13	14	15	16	17	18	19	20
Initial Investment	€ 9,755,000	Euro																				
FCFF	€ (9,755,000)	€	€ (753,550)	€ (768,621)	€ (783,993)	€ (799,673)	€ (815,666)	€ (831,980)	€ (848,619)	€ (865,592)	€ (882,903)	€ (900,562)	€ (6,678,321)	€ (936,944)	€ (955,683)	€ (974,797)	€ (994,293)	€ (1,014,179)	€ (1,034,462)	€ (1,055,151)	€ (1,076,254)	€ (1,097,779)
			€ (10,508,550)	€ (1,522,170)	€ (1,552,614)	€ (1,583,666)	€ (1,615,339)	€ (1,647,646)	€ (1,680,599)	€ (1,714,211)	€ (1,748,495)	€ (1,783,465)	€ (7,578,883)	€ (7,615,266)	€ (1,892,627)	€ (1,930,480)	€ (1,969,089)	€ (2,008,471)	€ (2,048,641)	€ (2,089,614)	€ (2,131,406)	€ (2,174,034)
Payback period	20 years																					
NPV	(€ 19,241,171)	Discount Rate	8.00%																			

As presented by Table 9.9, the NPV of the Power-to-Gas Hydrogen project in the French case (with participation to the balancing market) is – 19 241 171 Euro for a discount rate of 8%. A separate analysis was carried out of the case in which the Power-to-Gas plant does not operate on the balancing market, using the parameters presented by Table 9.3. The final result indicates that the project would record an NPV of – 20 046 763 Euro for a duration of 20 years and using an identical 8 percent discount rate. In conclusion, the balancing market alone is not sufficient as a high-value market that would bring profitability to a Power-to-Gas project in the current French context. However, using the balancing market improves the NPV of the project by approximately 4% and in the same time provides valuable technical services to the grid.

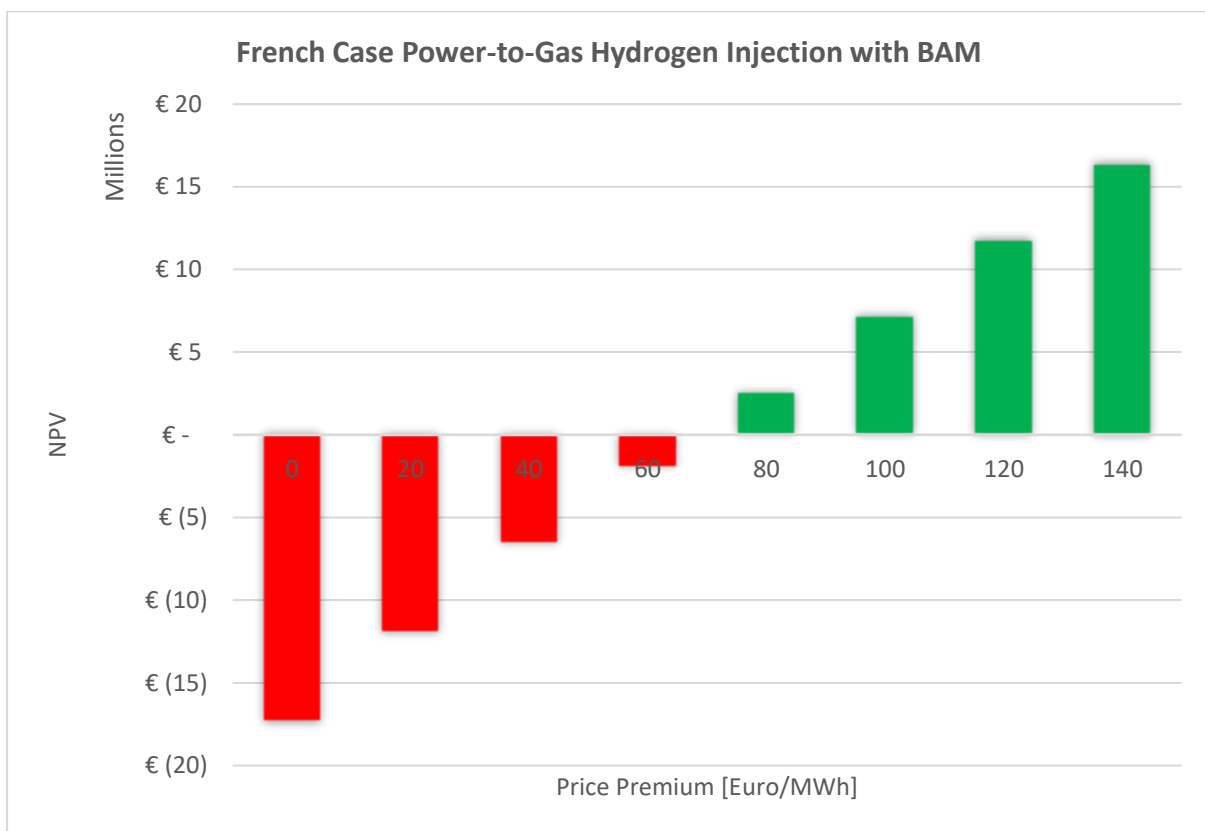

Figure 9.4 Sensitivity analysis on the influence of potential price premiums for renewable hydrogen in the French Case of Power-to-Gas Hydrogen Injection participating on the BAM

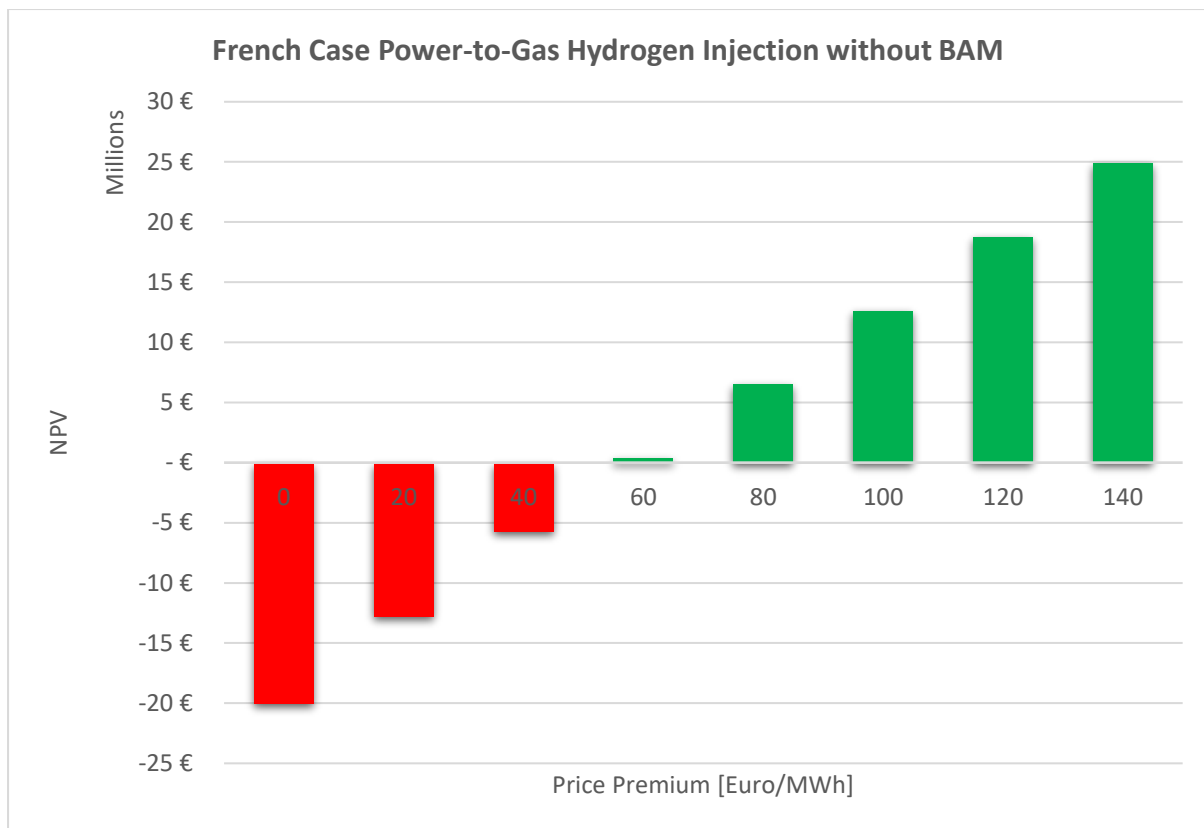

Figure 9.5 Sensitivity analysis on the influence of potential price premiums for renewable hydrogen in the French Case of Power-to-Gas Hydrogen Injection without participating on the BAM

At the moment, in the French legislation, there is no price premium for renewable hydrogen. Performing a similar sensitivity analysis on the influence of price premiums for renewable hydrogen with the one performed in the Romania case leads to interesting results (Figure 4 and Figure 5). The Hydrogen Injection pathway in which the balancing market is not used becomes profitable for a lower price premium compared to the one in which the balancing market is used (break-even point attained for 58.8 Euro/MWh of renewable hydrogen HHV for a discount rate of 8%, compared to a break-even point of 63.6 Euro/MWh). This can be explained by the fact that when no BAM is used, the price premium is applied to the whole hydrogen production (because it is produced only renewable energy), while for the case in which the BAM is taken into consideration, part of the hydrogen production comes from energy bought on the balancing market (which is not guaranteed to be renewable, thus no price premium will be received). Going further with the explanation, this clearly points to a limitation of the sizing stage of the Thesis, that does not take into consideration the possibility of having price premiums. Actually, it leads to the conclusion that if the optimum sizing of a Power-to-Gas project that also participates on the balancing market is established in the current context, the

sizing will not represent the optimum choice if the context is changed by adding various support mechanisms. The incentives will improve the economic parameters, but a different sizing might be considered optimum.

9.4.2 Power-to-Gas SNG

The relevant modeling parameters for the Power-to-Gas SNG in the French case with participation to the balancing market are presented in Table 9.10. The methodology for evaluating the scenario using the DCF valuation tool is similar with the one used in the Romanian case and only the significant differences are going to be highlighted.

Table 9.10 Key Inputs for the economic analysis of Power-to-Gas SNG in the French case with participation to the balancing market

Project type	Power-to-Gas SNG (French case with BAM participation)		
Year	2015		
Project size	10 MW		
Threshold	48 Euro/MWh		
BAM upward offered price threshold	70 Euro/MWh		
BAM downward offered price threshold	36 Euro/MWh		
Project lifetime	20 years		
Category	Value	Unit	Reference
CAPEX			
Electrolysis	900	Euro/kW	[Bertuccioli et al. 2014]
Hydrogen storage	470	Euro/kg	[ADEME 2014]
Methanation plant	950	Euro/kW	[DNV KEMA Energy & Sustainability 2013]
OPEX			
Electrolysis	2.2	% of CAPEX/year	[Bertuccioli et al. 2014]
Methanation	10	% of CAPEX/year	[DNV KEMA Energy & Sustainability 2013]
Outputs			
Hydrogen	103.4	kg/h	

Hydrogen (yearly energy output)	35688.3	MWh/year	
Oxygen	820.7	kg/h	
Oxygen (yearly output)	7196336	kg/year	
SNG	27734.9	MWh/year	
Economic indicators			
Natural gas price	26	Euro/MWh	[ADEME 2014]
Oxygen price	0.0245	Euro/kg	
Discount rate	8	%	[Guinot et al. 2015]
Inflation rate	2	%	
Insurance	0.4	% of CAPEX/year	[Omniasig 2014]
Income tax	16	%	
Technical indicators			
Electrolyser hours per year	5524	hours	
Electrolysis hour during lifetime	110485	hours	
Electrolyser capacity factor	63	%	
Electrolyser stack lifetime	60000	hours	[Bertuccioli et al. 2014]
Stack replacements	1		
First year of replacement	11		
Stack replacement cost	50	% of CAPEX of the electrolysis unit	[Bertuccioli et al. 2014]
Capacity of the methanation reactor	3216	MW	

Table 9.11 and Table 9.12 present the Initial Investment required for the Power-to-Gas project and the CAPEX and Depreciation part of the DCF valuation model. The Profits and Losses are presented in Table 9.13

Table 9.11 Initial Investment for Power-to-Gas SNG in the French case (with participation to the balancing market)

Investment	CAPEX
Electrolysis	
Electrolysis plant	€ 9,000,000
Hydrogen storage	
Hydrogen storage tank	€ 2,332,734
Methanation	
Methanation plant	€ 3,055,200
Natural gas grid connection	
Connection	€ 130,000
Injection station	€ 600,000
Balancing market	
Participation tax	€ 25,000
Total	

Total Investment	€ 15,142,934
-------------------------	---------------------

Table 9.12 Table 6 Power-to-Gas SNG French Case (with BAM participation) CAPEX & Depreciation

Depreciable Assets	€ 15,142,934	Euro			
Depreciation Period	20	years			
	2016	2017	...	2034	2035
	1	2	...	19	20
Depreciation Expense	€ 757,146	€ 757,146	...	€ 757,146	€ 757,146
CAPEX	€ 15,142,934	Euro			

Table 9.13 Power-to-Gas SNG French case (with participation to BAM) Profits & Losses

Year	2016	2017	2018	2019	2020	2021	2022	2023	2024	2025	2026	2027	2028	2029	2030	2031	2032	2033	2034	2035
	1	2	3	4	5	6	7	8	9	10	11	12	13	14	15	16	17	18	19	20
Revenues																				
Electrolysis																				
Oxygen	€ 176,310	€ 179,836	€ 183,433	€ 187,102	€ 190,844	€ 194,661	€ 198,554	€ 202,525	€ 206,576	€ 210,707	€ 214,921	€ 219,220	€ 223,604	€ 228,076	€ 232,638	€ 237,290	€ 242,036	€ 246,877	€ 251,814	€ 256,851
Methanation																				
SNG	€ 721,108	€ 735,530	€ 750,241	€ 765,245	€ 780,550	€ 796,161	€ 812,084	€ 828,326	€ 844,893	€ 861,791	€ 879,026	€ 896,607	€ 914,539	€ 932,830	€ 951,486	€ 970,516	€ 989,926	€ 1,009,725	€ 1,029,919	€ 1,050,518
Residual heat	€ 239,148	€ 243,931	€ 248,810	€ 253,786	€ 258,861	€ 264,039	€ 269,319	€ 274,706	€ 280,200	€ 285,804	€ 291,520	€ 297,350	€ 303,297	€ 309,363	€ 315,551	€ 321,862	€ 328,299	€ 334,865	€ 341,562	€ 348,393
Total Revenues	€ 1,136,566	€ 1,159,297	€ 1,182,483	€ 1,206,133	€ 1,230,256	€ 1,254,861	€ 1,279,958	€ 1,305,557	€ 1,331,668	€ 1,358,302	€ 1,385,468	€ 1,413,177	€ 1,441,440	€ 1,470,269	€ 1,499,675	€ 1,529,668	€ 1,560,262	€ 1,591,467	€ 1,623,296	€ 1,655,762
Expenses																				
Electrolysis																				
Electric Energy	€ 1,261,667	€ 1,286,900	€ 1,312,638	€ 1,338,891	€ 1,365,668	€ 1,392,982	€ 1,420,841	€ 1,449,258	€ 1,478,243	€ 1,507,808	€ 1,537,965	€ 1,568,724	€ 1,600,098	€ 1,632,100	€ 1,664,742	€ 1,698,037	€ 1,731,998	€ 1,766,638	€ 1,801,971	€ 1,838,010
OPEX	€ 198,000	€ 201,960	€ 205,999	€ 210,119	€ 214,322	€ 218,608	€ 222,980	€ 227,440	€ 231,989	€ 236,628	€ 241,361	€ 246,188	€ 251,112	€ 256,134	€ 261,257	€ 266,482	€ 271,812	€ 277,248	€ 282,793	€ 288,449
Insurance	€ 36,000	€ 36,720	€ 37,454	€ 38,203	€ 38,968	€ 39,747	€ 40,542	€ 41,353	€ 42,180	€ 43,023	€ 43,884	€ 44,761	€ 45,657	€ 46,570	€ 47,501	€ 48,451	€ 49,420	€ 50,409	€ 51,417	€ 52,445
Stack Replacement	€ -	€ -	€ -	€ -	€ -	€ -	€ -	€ -	€ -	€ -	€ 5,485,475	€ -	€ -	€ -	€ -	€ -	€ -	€ -	€ -	€ -
Hydrogen storage insurance	€ 9,331	€ 9,518	€ 9,708	€ 9,902	€ 10,100	€ 10,302	€ 10,508	€ 10,718	€ 10,933	€ 11,151	€ 11,374	€ 11,602	€ 11,834	€ 12,071	€ 12,312	€ 12,558	€ 12,809	€ 13,066	€ 13,327	€ 13,593
Balancing Market																				
BAM Expenses	€ 212,331	€ 216,578	€ 220,909	€ 225,327	€ 229,834	€ 234,431	€ 239,119	€ 243,902	€ 248,780	€ 253,755	€ 258,830	€ 264,007	€ 269,287	€ 274,673	€ 280,166	€ 285,770	€ 291,485	€ 297,315	€ 303,261	€ 309,326
Yearly fee	€ 10,000	€ 10,200	€ 10,404	€ 10,612	€ 10,824	€ 11,041	€ 11,262	€ 11,487	€ 11,717	€ 11,951	€ 12,190	€ 12,434	€ 12,682	€ 12,936	€ 13,195	€ 13,459	€ 13,728	€ 14,002	€ 14,282	€ 14,568
Trading fees	€ 695	€ 709	€ 723	€ 737	€ 752	€ 767	€ 782	€ 798	€ 814	€ 830	€ 847	€ 864	€ 881	€ 899	€ 917	€ 935	€ 954	€ 973	€ 992	€ 1,012
Methanation																				
OPEX	€ 305,520	€ 311,630	€ 317,863	€ 324,220	€ 330,705	€ 337,319	€ 344,065	€ 350,946	€ 357,965	€ 365,125	€ 372,427	€ 379,876	€ 387,473	€ 395,223	€ 403,127	€ 411,190	€ 419,413	€ 427,802	€ 436,358	€ 445,085
Insurance	€ 12,221	€ 12,465	€ 12,715	€ 12,969	€ 13,228	€ 13,493	€ 13,763	€ 14,038	€ 14,319	€ 14,605	€ 14,897	€ 15,195	€ 15,499	€ 15,809	€ 16,125	€ 16,448	€ 16,777	€ 17,112	€ 17,454	€ 17,803
SNG Injection																				
Connection	€ 2,600	€ 2,652	€ 2,705	€ 2,759	€ 2,814	€ 2,871	€ 2,928	€ 2,987	€ 3,046	€ 3,107	€ 3,169	€ 3,233	€ 3,297	€ 3,363	€ 3,431	€ 3,499	€ 3,569	€ 3,641	€ 3,713	€ 3,788

Injection station	€ 48,000	€ 48,960	€ 49,939	€ 50,938	€ 51,957	€ 52,996	€ 54,056	€ 55,137	€ 56,240	€ 57,364	€ 58,512	€ 59,682	€ 60,876	€ 62,093	€ 63,335	€ 64,602	€ 65,894	€ 67,212	€ 68,556	€ 69,927
Contingencies	€ 104,818	€ 106,915	€ 109,053	€ 111,234	€ 113,459	€ 115,728	€ 118,042	€ 120,403	€ 122,811	€ 125,267	€ 127,771	€ 130,328	€ 132,935	€ 135,594	€ 138,305	€ 141,072	€ 143,893	€ 146,771	€ 149,706	€ 152,700
Total Expenses	€ 2,201,182	€ 2,245,206	€ 2,290,110	€ 2,335,912	€ 2,382,631	€ 2,430,283	€ 2,478,889	€ 2,528,467	€ 2,579,036	€ 2,630,617	€ 2,683,215	€ 2,736,894	€ 2,791,631	€ 2,847,464	€ 2,904,413	€ 2,962,502	€ 3,021,752	€ 3,082,187	€ 3,143,830	€ 3,206,707
EBITDA	€ (1,064,616)	€ (1,085,909)	€ (1,107,627)	€ (1,129,779)	€ (1,152,375)	€ (1,175,422)	€ (1,198,931)	€ (1,222,910)	€ (1,247,368)	€ (1,272,315)	€ (1,297,771)	€ (1,323,717)	€ (1,350,191)	€ (1,377,195)	€ (1,404,739)	€ (1,432,833)	€ (1,461,490)	€ (1,490,720)	€ (1,520,534)	€ (1,550,945)
Depreciation Expense	€ 757,147	€ 757,147	€ 757,147	€ 757,147	€ 757,147	€ 757,147	€ 757,147	€ 757,147	€ 757,147	€ 757,147	€ 757,147	€ 757,147	€ 757,147	€ 757,147	€ 757,147	€ 757,147	€ 757,147	€ 757,147	€ 757,147	€ 757,147
EBIT	€ (1,821,763)	€ (1,843,055)	€ (1,864,774)	€ (1,886,926)	€ (1,909,522)	€ (1,932,569)	€ (1,956,078)	€ (1,980,056)	€ (2,004,514)	€ (2,029,462)	€ (2,054,410)	€ (2,080,863)	€ (2,107,338)	€ (2,134,341)	€ (2,161,885)	€ (2,189,980)	€ (2,218,637)	€ (2,247,867)	€ (2,277,681)	€ (2,308,092)
Financial Expense	€ -	€ -	€ -	€ -	€ -	€ -	€ -	€ -	€ -	€ -	€ -	€ -	€ -	€ -	€ -	€ -	€ -	€ -	€ -	€ -
EBT	€ (1,821,763)	€ (1,843,055)	€ (1,864,774)	€ (1,886,926)	€ (1,909,522)	€ (1,932,569)	€ (1,956,078)	€ (1,980,056)	€ (2,004,514)	€ (2,029,462)	€ (2,054,410)	€ (2,080,863)	€ (2,107,338)	€ (2,134,341)	€ (2,161,885)	€ (2,189,980)	€ (2,218,637)	€ (2,247,867)	€ (2,277,681)	€ (2,308,092)
Income Tax	€ -	€ -	€ -	€ -	€ -	€ -	€ -	€ -	€ -	€ -	€ -	€ -	€ -	€ -	€ -	€ -	€ -	€ -	€ -	€ -
Net Profit	€ (1,821,763)	€ (1,843,055)	€ (1,864,774)	€ (1,886,926)	€ (1,909,522)	€ (1,932,569)	€ (1,956,078)	€ (1,980,056)	€ (2,004,514)	€ (2,029,462)	€ (2,054,410)	€ (2,080,863)	€ (2,107,338)	€ (2,134,341)	€ (2,161,885)	€ (2,189,980)	€ (2,218,637)	€ (2,247,867)	€ (2,277,681)	€ (2,308,092)

Table 9.14 Power-to-Gas SNG French case (with participation to BAM) Cash Flow

Year	2016	2017	2018	2019	2020	2021	2022	2023	2024	2025	2026	2027	2028	2029	2030	2031	2032	2033	2034	2035
	1	2	3	4	5	6	7	8	9	10	11	12	13	14	15	16	17	18	19	20
Operational Cash Flow	€ (1,064,616)	€ (1,085,909)	€ (1,107,627)	€ (1,129,779)	€ (1,152,375)	€ (1,175,422)	€ (1,198,931)	€ (1,222,910)	€ (1,247,368)	€ (1,272,315)	€ (1,297,771)	€ (1,323,717)	€ (1,350,191)	€ (1,377,195)	€ (1,404,739)	€ (1,432,833)	€ (1,461,490)	€ (1,490,720)	€ (1,520,534)	€ (1,550,945)
Net Profit	€ (1,821,763)	€ (1,843,055)	€ (1,864,774)	€ (1,886,926)	€ (1,909,522)	€ (1,932,569)	€ (1,956,078)	€ (1,980,056)	€ (2,004,514)	€ (2,029,462)	€ (2,054,410)	€ (2,080,863)	€ (2,107,338)	€ (2,134,341)	€ (2,161,885)	€ (2,189,980)	€ (2,218,637)	€ (2,247,867)	€ (2,277,681)	€ (2,308,092)
Depreciation Expense	€ 757,147	€ 757,147	€ 757,147	€ 757,147	€ 757,147	€ 757,147	€ 757,147	€ 757,147	€ 757,147	€ 757,147	€ 757,147	€ 757,147	€ 757,147	€ 757,147	€ 757,147	€ 757,147	€ 757,147	€ 757,147	€ 757,147	€ 757,147
Investment Cash Flow	€ (15,142,934)																			
CAPEX	€ 15,142,934																			
Financing Cash Flow																				
Total Cash Flow	€ (16,207,550)	€ (1,085,909)	€ (1,107,627)	€ (1,129,779)	€ (1,152,375)	€ (1,175,422)	€ (1,198,931)	€ (1,222,910)	€ (1,247,368)	€ (1,272,315)	€ (1,297,771)	€ (1,323,717)	€ (1,350,191)	€ (1,377,195)	€ (1,404,739)	€ (1,432,833)	€ (1,461,490)	€ (1,490,720)	€ (1,520,534)	€ (1,550,945)
Cash BoY		€ (16,207,550)	€ (17,293,459)	€ (18,401,086)	€ (19,530,865)	€ (20,683,240)	€ (21,858,663)	€ (23,057,594)	€ (24,280,503)	€ (25,527,871)	€ (26,800,186)	€ (33,857,696)	€ (35,181,412)	€ (36,531,603)	€ (37,908,798)	€ (39,313,537)	€ (40,746,370)	€ (42,207,860)	€ (43,698,580)	€ (45,219,114)
Cash EoY	€ (16,207,550)	€ (17,293,459)	€ (18,401,086)	€ (19,530,865)	€ (20,683,240)	€ (21,858,663)	€ (23,057,594)	€ (24,280,503)	€ (25,527,871)	€ (26,800,186)	€ (33,857,696)	€ (35,181,412)	€ (36,531,603)	€ (37,908,798)	€ (39,313,537)	€ (40,746,370)	€ (42,207,860)	€ (43,698,580)	€ (45,219,114)	€ (46,770,059)

Table 9.15 Power-to-Gas Hydrogen French case (with participation to BAM) NPV calculation

			2016	2017	2018	2019	2020	2021	2022	2023	2024	2025	2026	2027	2028	2029	2030	2031	2032	2033	2034	2035
			1	2	3	4	5	6	7	8	9	10	11	12	13	14	15	16	17	18	19	20
Initial Investment	€ 15,142,934	Euro																				
FCFF	€ (15,142,934)		€ (1,064,616)	€ (1,085,909)	€ (1,107,627)	€ (1,129,779)	€ (1,152,375)	€ (1,175,422)	€ (1,198,931)	€ (1,222,910)	€ (1,247,368)	€ (1,272,315)	€ (7,057,510)	€ (1,323,717)	€ (1,350,191)	€ (1,377,195)	€ (1,404,739)	€ (1,432,833)	€ (1,461,490)	€ (1,490,720)	€ (1,520,534)	€ (1,550,945)
			€ (16,207,550)	€ (2,150,525)	€ (2,193,535)	€ (2,237,406)	€ (2,282,154)	€ (2,327,797)	€ (2,374,353)	€ (2,421,840)	€ (2,470,277)	€ (2,519,683)	€ (8,329,825)	€ (8,381,227)	€ (2,673,907)	€ (2,727,386)	€ (2,781,933)	€ (2,837,572)	€ (2,894,323)	€ (2,952,210)	€ (3,011,254)	€ (3,071,479)
Payback period	20 years																					
NPV	(€ 27,500,005)	Discount Rate	8.00%																			

As revealed by Table 9.15, the NPV of the French case Power-to-Gas SNG with participation on the balancing market project over a 20-year lifetime is – 27 500 005 Euro for a discount rate of 8%. When not participating on the BAM, the NPV is similar, of -27 448 828 Euro for the same discount rate. This can be again explained by the sizing methodology that focused on the lowest Levelized Cost of Hydrogen, thus not taking into consideration elements related to the Power-to-Gas SNG pathway. This pathway was regarded as a potential evolution of an existing Power-to-Gas project (sized according to the strategy presented in the Thesis).

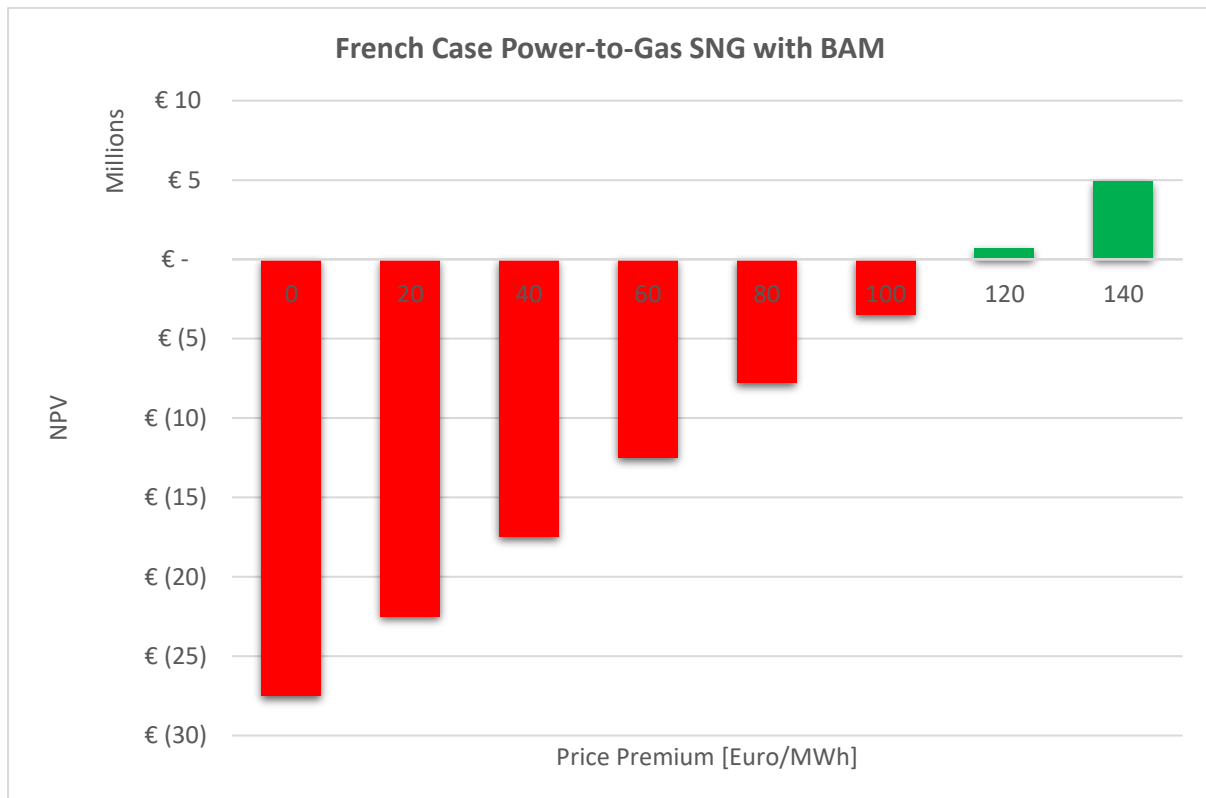

Figure 9.6 Sensitivity analysis on the influence of potential price premiums for renewable hydrogen in the French Case of Power-to-Gas SNG participating on the BAM

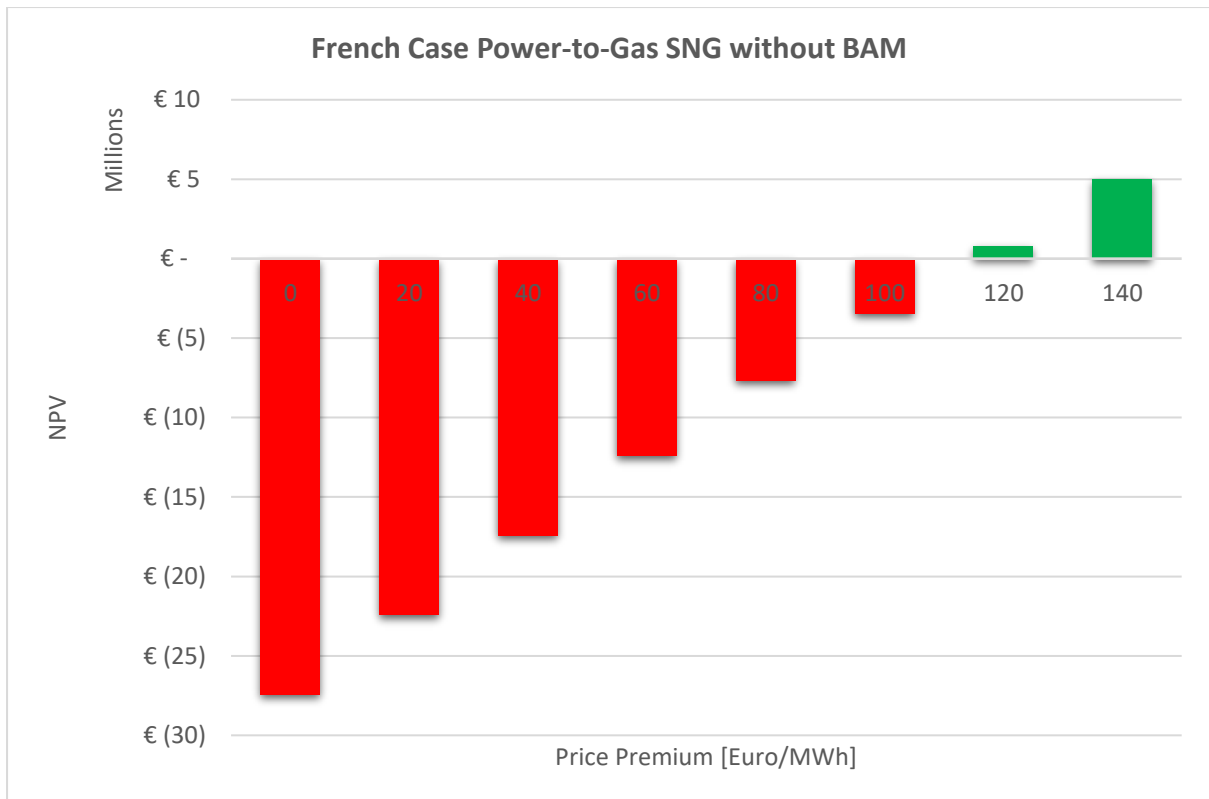

Figure 9.7 Sensitivity analysis on the influence of potential price premiums for renewable hydrogen in the French Case of Power-to-Gas SNG without participating on the BAM

The sensitivity analysis on potential price premiums for renewable SNG indicates similar values for reaching economic feasibility (116.3 Euro/MWh of SNG HHV without using the BAM and 116.6 Euro/MWh of SNG HHV when using the BAM break-even points), as seen in Figure 9.6 and 9.7.

9.5 DISCUSSION

The main conclusions of studying the possibility of using Power-to-Gas in conjunction with the balancing market (as a potential high-value market) in the current French context indicate a 4 percent improvement in the NPV economic indicator when using the BAM compared to the situation in which the BAM is not used, but only if the initial conditions of the sizing stage are not modified: if the final product of the process is hydrogen, (thus only for the Power-to-Gas Hydrogen Injection) and if no support mechanisms are put into place.

This leads to the conclusion that a different strategy for determining the optimum sizing is desirable if the desired result is the optimum scenario. The current sizing strategy can be applied successfully only if we are looking to determine the optimum project size and operating strategy in the current context, and only for the Power-to-Gas Hydrogen Injection pathway.

10 ENVIRONMENTAL EVALUATION OF POWER-TO-GAS

10.1 THEORETICAL CONSIDERATIONS ON LIFE CYCLE ASSESSMENT

Life Cycle Assessment (LCA) is defined as a structured, comprehensive and internationally standardized method that quantifies relevant emissions, resources, impacts and resource depletion issues that are associated with a product's complete life cycle [ILCD 2010]. Over the years, LCA has developed into a valuable decision-support instrument, not only for the industry – in internal evaluations and communications – but also for policy makers looking to assess the impact of certain products or processes. The main reason behind this evolution rests in the fact that governmental decisions started to become driven by environmental constraints (historically, starting with the first oil crisis) and generally take into consideration the fact that the overall impact of a product or process is not generated only by its direct production, but also by its inputs, use, transport and disposal phases. Manufacturers are also interested in using LCA for obtaining specific certifications that can translate into market growth as consumers are more and more interested in products that are accompanied by eco-friendly labels. [GDRC n.d.]

A life cycle assessment study can be separated into four phases, generally interconnected as LCA is an iterative tool, as presented in Figure 10.1 [ISO 14040 2006]:

- Goal and scope definition
- Inventory analysis
- Impact assessment
- Interpretation

The life cycle assessment performed as part of the thesis will follow the standard framework, which will also represent the current's chapter structural backbone.

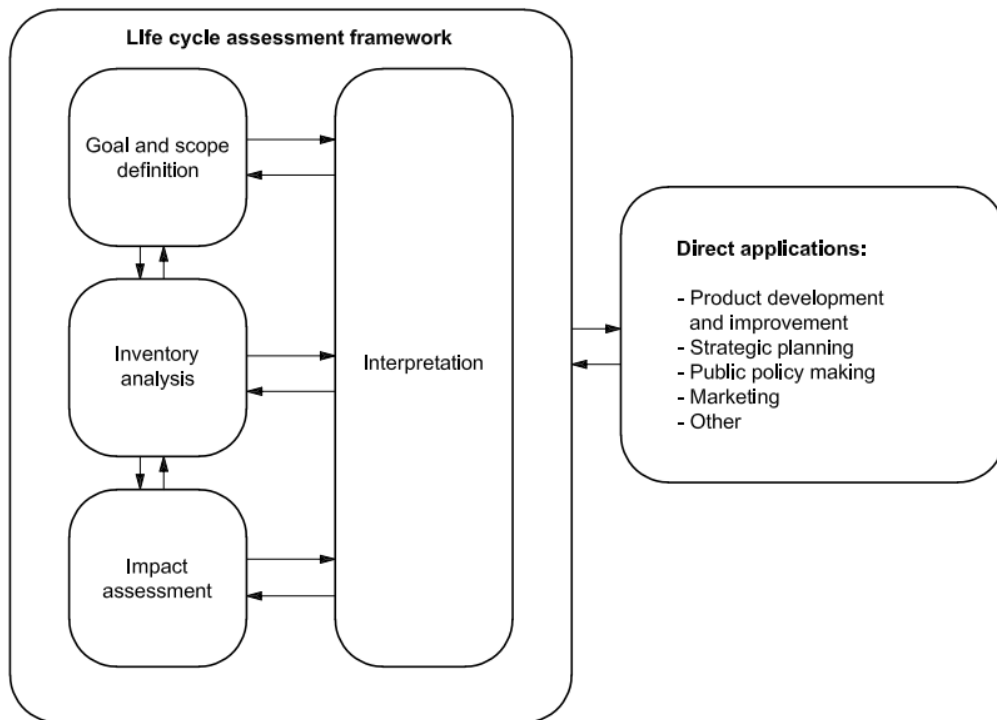

Figure 10.1 Stages of Life Cycle Assessment

10.2 GOAL AND SCOPE

10.2.1 Goal definition

The study is intended to offer an overview of the environmental impacts associated with various Power-to-Gas pathways and scenarios. It is not intended to be exhaustive for each scenario, but rather focuses on providing a broad perspective of the impacts associated to multiple energy related applications of Power-to-Gas technology.

Intended application:

- Calculating the environmental impacts of Power-to-Gas – by assessing relevant indicators for energy related processes, such as GWP and primary energy demand. It is intended to add a third analysis pillar, the environmental one, to the technical and economic evaluations of the technology.
- Policy development – indirectly, the current study can potentially stimulate development of new energy policies that can establish a legal framework for renewable hydrogen and renewable methane thus encouraging the transition towards a

decarbonized energy system through a better understanding of the comparison between Power-to-Gas associated pathways and traditional energy processes.

Goals of the study:

As the previous chapters of the Thesis indicate, Power-to-Gas is technically feasible, but still dependent on price premiums and policy development in order to reach positive economic indicators. As the environmental benefits of using such technology can potentially represent an important drive for these pull measures, a simplified LCA is performed on Power-to-Gas, with focus on the following goals:

- Gain insight on the life cycle environmental impacts associated to Power-to-Gas technology and the contribution each of its individual components has.
- Establish a core life cycle model for Power-to-Gas that can be leveraged in various scenarios, using a modular approach.
- Evaluate and identify suitable scenarios in which Power-to-Gas can be implemented in order to gain environmental value.
- Evaluate the potential CO₂ related added value Power-to-Gas technology can have in the current business case of the thesis, through the impact of the CO₂ savings brought.
- Calculate the potential environmental advantage brought by reusing CO₂ in multiple Power-to-Gas cycles.

Reasons for carrying out the study in link with the thesis:

- Add the environmental component to a study that already contains the technical and economic evaluation, therefore providing a global overview of Power-to-Gas.
- As Power-to-Gas has been identified as one of the solutions for facing the inherent challenges associated with the large scale penetration of renewable energy sources, it is important to evaluate its environmental implications in order to assess the possibility of leveraging them into added economic value, as CO₂ savings can translate into economic savings.
- The findings of the environmental study can lay the foundation for creating a set of recommendations designed to raise awareness and push new regulations concerning how to handle CO₂ emissions and linking them with price premiums applied to renewable hydrogen and renewable methane.

Intended audience: public, technical

- The primary audience of the LCA consists of the parties involved in the PhD thesis: GDF Suez Energy Romania, CEA/Liten, University “Politehnica” of Bucharest, ENSAM ParisTech and ICIT Rm. Valcea.
- Secondary audience consists of energy professionals that are interested in the environmental aspects of Power-to-Gas and their potential interest in creating business cases for the technology.
- Policy and decision makers can potentially represent an indirect audience for the current LCA study.

The result will not be a purely comparative LCA study, as comparisons will only be made between the selected scenarios and the chosen reference scenarios inside the categories that share the same functional unit.

10.2.2 Scope Definition

Since the current LCA study aims to achieve a broad overview of the possible Power-to-Gas applications rather than an in-depth analysis of particular case, three main functional unit categories were created along with subsequent scenarios. The choice of the three functional units covers the whole range of applications for the Power-to-Gas scenarios considered inside the Thesis:

- 1 kg of hydrogen – with applications not only in energy transport and storage in the Power-to-Gas Hydrogen pathway, but also in hydrogen production and mobility sector. Hydrogen production from renewable energy represents the basis for all Power-to-Gas applications and is directly compared to the reference steam reforming scenario.
- 1 kWh of electricity – being the most common energy carrier for the current energy systems, electricity is a natural choice as a functional unit for Power-to-Gas applications.
- 1 MJ of heat – chosen as one of the basic energy outputs from the final user’s perspective.

Three different energy mix scenarios for the source of the electricity used in hydrogen compression are taken into account:

- Romanian mix – conservative approach – carbonated energy mix with a large share of electricity produced in coal and natural gas power plants without carbon capture.
- French mix – dominated by nuclear energy, with a low carbon concentration.
- Renewable mix – a 100% renewable energy mix (wind energy for reference), the scenario in which Power-to-Gas plants are more likely to operate given the principles behind the technology taken into account inside the Thesis (running on surplus/cheap renewable electricity).

Single and double Power-to-Gas cycles are taken into account in order to evaluate the environmental impact of offering multiple energy uses to the same quantity of CO₂ before finally emitting it.

The modular approach chosen inside the Thesis, based on individual bricks that are put together to create various scenarios, offers the possibility of further LCA studies, outside the Thesis, relying on the same bricks, but possibly with other goals, scopes or perimeters.

The following scenarios are going to be analyzed as part of the current LCA study:

Table 10.1 Scenarios considered in the LCA study

Functional Unit	Scenario	Processes	Energy mix [References]
1 kg of hydrogen	Renewable hydrogen	Hydrogen production and storage	Romanian French Renewable
	Steam reforming	Steam reforming	[Cetinkaya et al. 2012]
1 kWh of electricity	Electricity from renewable hydrogen	Hydrogen production and storage Electricity in NGPP from hydrogen	Romanian French Renewable
	Electricity from SNG (with CC)	SNG production Electricity in NGPP (with CC) from SNG	Romanian French Renewable
	Electricity from natural gas (with CC)	Electricity in NGPP (with CC) from NG	
	Electricity from natural gas (w/o CC)		[Spath & Mann 2000]
	Single Power-to-Gas cycle (fossil)	Electricity in NGPP (with CC) from NG	Romanian

		SNG production Electricity in NGPP (w/o CC) from SNG	French Renewable
	Double Power-to-Gas cycle (fossil)	Electricity in NGPP (with CC) from NG SNG production Electricity in NGPP (with CC) from SNG SNG production Electricity in NGPP (w/o CC) from SNG	Romanian French Renewable
		Single Power-to-Gas cycle (cement)	Cement production (with CC) SNG production Electricity in NGPP (w/o CC) from SNG
	Double Power-to-Gas cycle (cement)	Cement production (with CC) SNG production Electricity in NGPP (with CC) from SNG SNG production Electricity in NGPP (w/o CC) from SNG	Romanian French Renewable
1 MJ of heat	Heat from SNG	SNG production SNG burned in boiler	Romanian French Renewable
	Heat from natural gas	Natural gas burned in boiler	

System boundaries and limitations:

The study considers several different scenarios that don't share the same premises. Therefore, achieving the same level of consistency in terms of system boundaries was not always possible.

The scenarios don't always take into account the final use of the product, the exception being the 1 MJ of heat. Therefore, for the ones that analyze the production of 1 kWh_{el} or 1 kg of hydrogen, the final use is outside the boundaries of the system.

In the technical and economic study presented in the previous chapters of the thesis, Power-to-Gas was assessed from a "best-case scenario" point of view regarding resource transport, meaning that the co-localization of all the processes was considered. The LCA study uses the same premise concerning resource transport, therefore the associated inputs and impacts are not included in the study. On the other hand, specific process inventories take into account transport related inputs and impacts associated to building the physical infrastructure (for example electrolyzers).

In the scenarios that take into consideration a cement plant (equipped with a carbon capture unit), carbon dioxide is the resource of interest for the present study. Although cement is the

main product of the study, it is not included in the LCA, but only the CO₂ that is further required in the analyzed scenarios.

Data quality requirements:

Time-related coverage – the study uses data collected in 2014 and 2015. Specific inventories imported from bibliographic sources are older (ecoinvent 2.2 ~ 2010). Whenever possible, the most recent inventories were considered as long as they shared the same level of relevance.

Geography – process-related data is calculated starting from the technical and economic evaluation of the Romanian context. Certain scenarios include a sensitivity analysis of the electricity mix (adding the French case) due to the high-carbon content of the Romanian mix considered in the Ecoinvent database.

Technology coverage – the study covers different energy processes involving different stand-alone technologies. Therefore, most of the technologies are not analyzed in-depth, the focus being rather on obtaining an overview of the impact various Power-to-Gas implementations can have. The boundaries and limitations are covered in the previous section and will be presented when building the inventories for each process.

Representativeness – Due to the methodology used for building the inventory from different sources and process data resulted from the T&E evaluation, the study does not claim accurate representativeness for a general Power-to-Gas LCA, but is rather useful in identifying tendencies.

Consistency and reproducibility of the methods used throughout the LCA – The data collection process was based on available bibliographic data for infrastructures, independently developing the inventory for the methanation process. Therefore, the inventories do not have the same level of consistency in terms of approach and detail. The methods will be described in a transparent manner in the following section so that the reproducibility will be ensured.

Uncertainty of the information – Most of the data used in the LCA study comes from trustworthy bibliographic sources, being already used in previous life cycle projects. The process data is based on modeling and simulation that has been accepted and published in scientific literature and will be referenced throughout the chapter.

Impact categories:

Considering the fact that the LCA is considering energy-related applications, two impact categories were chosen to be specifically relevant for this type of study: global warming potential and primary energy consumption.

Global warming potential – Given the new targets imposed at European level concerning CO₂ reduction, the performance indicators of an energy system also quantify greenhouse gas emissions. In addition, for certain renewable technologies, a reduced carbon impact can potentially bring economic advantages through support measures [European Council 2015]. Therefore, it is essential to establish the GWP impacts associated to different integration options of the Power-to-Gas concept and put them head-to-head with the conventional alternatives that rely on the use of fossil fuels.

Primary energy consumption – One of the main functions of the Power-to-Gas concept is replacing primary energy resources with renewable energy, thus helping to mitigate resource depletion. The primary energy consumption indicator offers a benchmark for this function, essentially revealing how efficient an energy process is in transforming primary energy into a useful resource (the functional unit).

Table 10.2 Impact categories considered in the LCA study

Indicator	Method	Unit
Global warming potential	Global Warming Potential (GWP 100 years) IPCC 2007	kgCO ₂ /kWh _{el}
		kgCO ₂ /MJ
		kgCO ₂ /kg H ₂
Primary energy consumption	Cumulative Energy Demand (CED)	MJ/kWh _{el}
		MJ/kg H ₂
		MJ/MJ

Considerations regarding the origin of CO₂:

Converting hydrogen into final energy does not lead to the emission of greenhouse gases, but the situation changes when it comes to converting SNG into final energy. The Power-to-Gas SNG pathways have to be treated in a different manner in terms of the origin of CO₂ emissions.

Therefore, [Reiter & Lindorfer 2015] identified three potential scenarios when considering the use of CO₂:

- CO₂ is of biogenic origin when it is a waste product or it would be emitted to the atmosphere (Scenario A)
- CO₂ is of biogenic origin when it is a waste product, but there is an energy demand for its capture process (Scenario B)
- CO₂ is of fossil origin when it would be stored in CCS applications, or the emitters would have to pay for emission allowances. (Scenario C)

10.3 LIFE CYCLE INVENTORIES

10.3.1 Methodology

Considering the goal of the LCA study that consisted in providing an environmental overview of multiple scenarios associated with Power-to-Gas, the methodology for building the inventory relied mostly on background data than on foreground data. The most relevant bibliographic information was used for building the inventory for the infrastructure components, while the process data (the material and energy balance) for the core Power-to-Gas model came from the technical and economic evaluations presented in the previous chapters.

A modular approach was chosen for this life cycle study, meaning that each brick was modelled individually, based on inputs and outputs, and then used for creating complete scenarios that can be compared to reference scenarios. Therefore, the next section will cover the individual inventories for each brick used in the scenarios that are taken into consideration in the current study.

The processes were technically and economically described and analyzed in the previous chapters of the thesis, so only relevant aspects are going to be developed in this section.

While modelling the processes, the influence of the energy mix used for the compression step in the hydrogen production brick became critical, therefore a sensitivity analysis using three different electricity inputs for this particular component was considered important:

- The Romanian energy mix (ecoinvent version 2.2 database) – conservative approach dominated by CO₂ intensive electricity generation sources.

- The French energy mix (ecoinvent version 2.2 database) – case used for sensitivity analysis, with much reduced CO₂ emissions compared to the Romanian energy mix due to the high share of nuclear energy.
- Only electricity produced from wind energy (ecoinvent version 2.2 database) – used for illustrating a long term scenario with a 100% renewable energy mix, situation that justifies a large scale deployment of the Power-to-Gas concept due to its capability of bringing balance to a largely intermittent energy system.

The software used for modeling the processes was SimaPro version 7, with access to the ecoinvent version 2.2 database.

List of the bricks necessary for building the scenarios:

- Electricity production from wind energy
- Hydrogen production and storage
- SNG production (methanation)
- Electricity production in a natural gas power plant (with carbon capture)
- Heat production in a condensing boiler
- Electricity production in natural gas power plant with no carbon capture
- Cement plant with carbon capture
- Hydrogen production from steam reforming

10.3.2 Qualitative and quantitative description of the elementary processes

10.3.2.1 Electricity production from wind energy

Creating the inventory of electricity production from wind energy was outside the goal and scope of the present study, therefore the model was imported from the ecoinvent version 2 database [ecoinvent n.d.].

Product	Quantity	Unit
Electricity, at wind power plant/RER U	1	kWh

The output of this process is 1 kWh of electricity produced in a wind power plant, which represents the main energy input for the Hydrogen production and storage brick. Note that

electricity transport is not taken into consideration due to the co-localization of processes assumption.

10.3.2.2 Hydrogen production and storage

The study focuses on the current default technology for hydrogen production in large scale Power-to-Gas systems: alkaline water electrolysis fed with renewable energy (in the case of the current study, electricity produced from wind energy). The functional unit for this brick is 1 kg of hydrogen produced and stored. Although the process also outputs oxygen and heat, these resources were not included in the boundary of the current LCA study, thus considered as non-valorized.

The process is modelled from an inventory developed in the NEEDS Project [NEEDS 2008] for a 60 Nm³ H₂/h alkaline electrolysis unit, corresponding to an installed capacity of 0.3 MW with an yearly output of 47 250 kg H₂ over a lifetime of 15 years, along with its infrastructure consisting of : compressor, storage module, walls and foundation, miscellaneous components and its operation phase. However, our study takes into consideration the electrolysis units studied in the technical and economic evaluation part of the thesis, comprising of 5 electrolysers, each with an installed capacity of 2 MW, with a total production of 18 906 200 kg H₂ in a project with a lifetime of 20 years, assumed for all the components. Therefore a scale factor had to be applied between the reference flux provided the NEEDS Project [NEEDS 2008] and the flux used in the present LCA. The method for determining the scale factor was derived from an Economy of Scale approach [Dysert 2005], while the economy of scale capacity factor was set based on internal communications [Brunot 2015]:

$$Economy\ of\ scale = \left(\frac{Capacity_{electrolyser\ study}}{Capacity_{electrolyser\ reference}} \right)^{capacity\ factor} \cdot n \quad (1)$$

Where:

$$Capacity_{electrolyser\ study} = 2\ MW$$

$$Capacity_{electrolyser\ reference} = 0.3\ MW$$

$$capacity\ factor = 0.8$$

$n = \text{number of electrolyzers} = 5$

The scale factor applied to the reference flux accounts for the differences in total hydrogen production between the lifetimes of the process considered by the reference [NEEDS 2008] and the one of the current study (20 years), calculated to be 0.85, is given by the following formula:

$$\text{Scale factor} = \frac{\text{Reference}_{H_2 \text{ production}} \cdot \text{Economy of scale}}{\text{Study}_{H_2 \text{ production}}} \quad (2)$$

The scale factor is applied only to the inputs associated with the infrastructure of the hydrogen production and storage unit. Since the process related inputs are not dependent on the size of the unit or the lifetime of the project, being calculated on the basis of the T&E evaluation, they don't fall under the same rule.

While this is not the output of the processes, all the inventories are brought to a 1 kg of hydrogen since they reflect the contribution of each resource in producing this quantity of hydrogen.

Due to the way SimaPro is designed to function, the current study is built using a modeling approach that is not process-oriented, but rather depicts the contribution each component has in obtaining the final functional unit.

The inventory for the electrolyser component is presented in Table 10.3:

Table 10.3 Electrolyser Component inventory

Product	Quantity	Unit	Flux
Hydrogen	1	kg	
Output - Emissions			
Input - Energy			
Input - Materials and consumables			
chromium steel 18/8, at plant		kg	5.12E-03
nickel, 99.5%, at plant		kg	6.03E-04
synthetic rubber, at plant		kg	3.02E-05
reinforcing steel, at plant		kg	1.60E-03
copper, at regional storage		kg	4.62E-04

tube insulation, elastomere, at plant	kg	2.05E-04
aluminum, production mix, at plant	kg	1.33E-04
acrylonitrile-butadiene-styrene copolymer, ABS, at plant	kg	4.82E-05
polyethylene, LDPE, granulate, at plant	kg	1.21E-04
glassfiber, at plant	kg	1.21E-04
cast iron, at plant	kg	4.10E-05
nylon 66, glass-filled, at plant	kg	1.50E-05
transport, lorry 32t	tkm	8.47E-04

Note that the electricity and water required in the electrolysis process are accounted in the Operation inventory.

Since the inventory used for the compression and storage steps of the hydrogen production and storage brick is imported from the NEEDS Project, it is not consistent with the hypotheses considered for the previous chapters of the Thesis focusing on the T&E evaluation of Power-to-Gas.

The inventory used for the diaphragm compressor consists of:

Table 10.4 Diaphragm compressor inventory

Product (final or intermediary)	Quantity	Unit	Flux
Hydrogen	1	kg	
Output - Emissions			
Input - Energy			
electricity, production mix UCTE		kWh	6.03E-04
heat, natural gas, at industrial furnace >100kW		MJ	2.17E-03
Input - Materials and consumables			
chromium steel 18/8, at plant		kg	1.15E-03
cast iron, at plant		kg	3.62E-04
ethylene glycol, at plant		kg	4.22E-06
lubricating oil, at plant		kg	1.09E-05
aluminum, production mix, at plant		kg	3.62E-05
tube insulation, elastomere, at plant		kg	9.06E-06
copper, at regional storage		kg	2.71E-05
transport, lorry, 32t		tkm	3.10E-04

The inputs associated with the storage module:

Table 10.5 Storage module inventory

Product (final or intermediary)	Quantity	Unit	Flux
Hydrogen	1	kg	
Output - Emissions			
Input - Energy			
electricity, production mix UCTE		kWh	5.79E-04
diesel, burned in building machine		MJ	5.16E-04
Input - Materials and consumables			
chromium steel, 18/8, at plant		kg	5.07E-02
transport, lorry, 32t		tkm	5.07E-03

The inventory for walls and foundation:

Table 10.6 Walls and foundation inventory

Product (final or intermediary)	Quantity	Unit	Flux
Hydrogen	1	kg	
Output - Emissions			
Input - Energy			
electricity, production mix UCTE		kWh	3.02E-04
diesel, burned in building machine		MJ	2.58E-02
Input - Materials and consumables			
reinforcing steel, at plant		kg	5.43E-03
flat glass, coated, at plant		kg	1.96E-03
gypsum fiber board, at plant		kg	6.03E-05
silica sand, at plant		kg	3.47E-02
concrete, normal, at plant		m3	6.03E-06
concrete, exacting, at plant		m3	7.84E-05
gravel, unspecified, at mine		kg	1.09E+00
lubricating oil, at plant		kg	1.21E-05
transport, lorry, 32t		tkm	1.33E-01
occupation, industrial area		m2a	5.51E-03

Inventory for other components, as referred in the [NEEDS 2008] study:

Table 10.7 Other components inventory

Product (final or intermediary)	Quantity	Unit	Flux
Hydrogen	1	kg	
Output - Emissions			
Input - Energy			
Input - Materials and consumables			
reinforcing steel, at plant		kg	9.92E-04
nitrogen, liquid, at plant		kg	9.41E-05
chromium steel 18/8, at plant		kg	2.44E-04
polypropylene, granulate, at plant		kg	6.03E-06
transport, lorry, 32t		tkm	5.90E-02

Inventory associated to the required maintenance operations:

Table 10.8 Maintenance inventory

Product (final or intermediary)	Quantity	Unit	Flux
Hydrogen	1	kg	
Output - Emissions			
Input - Energy			
electricity, production mix UCTE		kWh	4.23E-02
heat, natural gas, at industrial furnace >100kw		MJ	1.52E-01
Input - Materials and consumables			
chromium steel 18/8, at plant		kg	3.69E-02
nickel, 99.5%, at plant		kg	2.82E-03
synthetic rubber, at plant		kg	1.14E-04
reinforcing steel, at plant		kg	5.50E-02
cast iron, at plant		kg	2.54E-02
ethylene glycol, at plant		kg	2.96E-04
lubricating oil, at plant		kg	7.62E-04
transport, lorry, 32t		tkm	2.20E-01

The inventory of the operation phase of the Hydrogen production and storage brick was created using data from the technical and economic evaluation of the Romanian case, presented in the previous chapters of the Thesis. The first electricity input relates to the energy fed to the electrolysers, while the second is associated with the energy demand of the compression unit.

Due to the significant impact the source of electricity for the compressor (pressure up to 440 bar according to [NEEDS 2008b]) has on the overall results, this inventory was also developed to include the French production mix and energy coming from a wind power plant, besides the default Romanian production mix, three options with a very different carbon emissions.

Table 10.9 Operation inventory

Product (final or intermediary)	Quantity	Unit	Flux
Hydrogen	1	kg	
Output - Emissions			
Input - Energy			
electricity, at wind power plant		kWh	5.56E+01
electricity, medium voltage, production RO, at grid/RO U		kWh	8.00E+00
Input - Materials and consumables			
tap water, at user		kg	1.00E+01

The contribution of all the above mentioned bricks to the Hydrogen production and storage process, as modeled in SimaPro, is presented in the following table:

Table 10.10 Hydrogen production and storage inventory

Hydrogen production and storage		
Product (final or intermediary)	Quantity	Unit
Hydrogen from electrolysis (wind energy)	1	kg
Input - Materials and consumables		
Electrolyser contribution to hydrogen production and storage	1	p
Compressor contribution to hydrogen production and storage	1	p
Storage module contribution to hydrogen production and storage	1	p
Walls and foundation contribution to hydrogen production and storage	1	p
Other components contribution to hydrogen production and storage	1	p
Maintenance contribution to hydrogen production and storage	1	p
Operation contribution to hydrogen production and storage	1	p

10.3.2.3 SNG production (methanation)

The inventory of the methanation process was developed in two parts: the inventory for the physical infrastructure was based on internal communications at CEA LITEN Grenoble [Bengaouer 2015.], while the simulation of the methanation process from the previous technical evaluation chapter was used for the process-related data.

The study takes into consideration a TREMP [Haldor Topsoe 2009] layout consisting of three adiabatic reactors with a recycling loop for the product gases coming from the first reactor. In order to calculate the material flow that goes into the infrastructure, a reference reactor was taken into consideration [ADAM 1980]. In this case, for a nominal feed of 535 Nm³/h of SNG, the length of the first reactor is 2 meters and its diameter is 0.5 meters, which leads to a volume of 0.4 m³. Assuming an apparent catalyst density of 1000 kg/m³, the mass of catalyst is around 400 kg (Nickel-Alumina catalyst with a Nickel loading of 30% weight). The same study indicates that the volume of the second and third reactors is about 0.1 m³.

In the case that makes the object of the study, a 3.3 MW SNG HHV methanation process has an output of 292 m³/h of SNG and, in complete CO₂ conversion conditions, a total inlet flow of 1500 m³/h, which is about three times higher than ADAM I's flowrate. Therefore, a volume of 1.2 m³ for the first reactor will be considered, while the other two will have a volume of 0.3 m³, leading to a total volume of 1.8 m³ and a catalyst mass of 1800 kg. The pressure vessels have to withstand at 30 bar, therefore they will be sized for 45 bar exceptional conditions, leading to a wall thickness of 10 mm for a reactor diameter of 0.8 m [Bengaouer 2015]. The total volume will have to be increased by 25% to take into account the distribution plates. In order to approximate the material requirements for the auxiliary equipment used in the methanation process, the following coefficients were used: 0.15 of the inputs for the core components (reactors including distribution plates) for the utilities and control and 0.15 of the same inputs for the associated buildings and infrastructure [Pедуzzi 2014].

Using cylinder area and volume equations leads to a total volume of material (stainless steel) required for building the reactors of 0.0906 m³. Given a 304/304L stainless steel density of 8030 kg/m³ [AK Steel 2007], a mass of 751.6 kg is required for building the reactors. Applying two 0.15 coefficients for utilities and control and building and infrastructure leads to a total requirement of 977.09 kg of stainless steel (identified as chromium steel in theecoinvent database).

Given a total mass of catalyst of 1800 kg, with a Nickel loading of 30% [Bengaouer 2015], a Nickel requirement of 540 kg and an Alumina requirement of 1260 kg are calculated. We assume that no catalyst is consumed over the lifetime of the methanation reactor [Zuberbühler 2015]. The electricity required in the catalyst fabrication process was calculated using data from [Lavery 2013] for the melting, crushing, grinding and milling stages.

Information from the previous chapter that deals with the technical aspects of the methanation process in the Romanian case is used for process related inputs. Therefore, for producing 1 kg of SNG, which is also the functional unit of this process, a hydrogen input of 0.503 kg is required, along with a fresh carbon dioxide input of 2.751 kg. The unit has a lifetime of 20 years and an annual SNG output of 1 867 056 kg SNG.

Table 10.11 SNG production from methanation inventory

Product (final)	Quantity	Unit	Flux
SNG		1 kg	
Output - Emissions			
Input - Energy			
electricity mix, ac, consumption mix, at consumer, 1kV - 60kV UCTE U (melting)		kWh	3.62E-05
electricity mix, ac, consumption mix, at consumer, 1kV - 60kV UCTE U (crushing)		kWh	4.82E-08
electricity mix, ac, consumption mix, at consumer, 1kV - 60kV UCTE U (grinding)		kWh	4.82E-07
electricity mix, ac, consumption mix, at consumer, 1kV - 60kV UCTE U (milling)		kWh	1.59E-06
Input - Materials and consumables			
chromium steel 18/8, at plant		kg	2.62E-05
nickel, 99.5%, at plant		kg	1.45E-05
aluminum, primary, ingot, plant/RNA		kg	3.37E-05
chromium steel product manufacturing, average metal working/RER U		kg	2.62E-05
hydrogen from electrolysis (wind energy)		kg	5.03E-01
carbon dioxide		kg	2.75E+00

10.3.2.4 Electricity production in a natural gas power plant (with carbon capture)

Building the inventory for electricity production in a natural gas power plant equipped with carbon capture required an indirect approach. Inventories for the whole process or only for the carbon capture unit were not publicly available in literature at the moment of the study. The approach chosen for this study consisted in using the inventory available for electricity

production in a natural gas power plant equipped with carbon capture, transport and storage and subtracting the impact associated with the storage and transport phase.

The inventory for electricity production in a natural gas power plant equipped with carbon capture, transport and storage is imported from [Bauer et al. 2008] for the 2025 realistic-optimistic scenario which is considered to be the most likely. It takes into consideration a 500 MWe natural gas power plant equipped with post-combustion carbon capture, a 400 km pipeline for CO₂ transport and a depleted gas reservoir at a depth of 2500 m for CO₂ storage. For assessing the impact of the CO₂ transport and storage phases, [Bauer et al. 2008] is using an inventory from [Wildbolz 2007], however the categories are not individually described in the inventory. Therefore, as part of the current study, the inventory presented by [Wildbolz 2007] for 400 km CO₂ transport (by onshore pipeline, with recompression) and CO₂ storage in a 2500 m deep depleted gas reservoir was remodeled in SimaPro and the impacts were subtracted from the also remodeled inventory of [Bauer et al. 2008], by introducing them in the avoided emissions category.

When remodeling the inventory for CO₂ transport and storage, corrections from the critical review of [Doka 2007] were taken into consideration. The drilling of the borehole for the storage reservoir was not included in the model due to insufficient data. The quantity of CO₂ that is transported and stored corresponds to the CO₂ emitted for producing 1 kWh of electricity in the referenced power plant [Bauer et al. 2008].

The result is an inventory of electricity production in a natural gas power plant equipped with carbon capture using natural gas as fuel (Table 10.12).

Table 10.12 Electricity production in a natural gas power plant equipped with carbon capture (from natural gas) inventory

Electricity from NGPP with CC (from natural gas)		
Product (final or intermediary)	Quantity	Unit
electricity, natural gas, CC plant, 500 MWe post CCS	1	kWh
Avoided products		
Transport and storage, CO ₂ , depleted gas field, 400 km pipeline	0.325	kg
Output - Emissions to air		
Ammonia	1.49E-06	kg
Arsenic	2.37E-09	kg
Cadmium	1.06E-09	kg
Carbon dioxide, fossil	9.50E-02	kg

Carbon monoxide, fossil	1.09E-04	kg
Carbon-14	4.59E-04	kBq
Chromium	4.61E-08	kg
Chromium VI	1.11E-09	kg
Dinitrogen monoxide	7.94E-06	kg
Iodine-129	3.93E-07	kBq
Lead	1.21E-08	kg
Methane, fossil	8.87E-04	kg
Mercury	2.47E-09	kg
Nickel	1.33E-08	kg
Nitrogen oxides	1.85E-04	kg
NM VOC, non-methane volatile organic compounds, unspecified origin	1.90E+00	kg
Particulates, < 10 um	5.68E-06	kg
Particulates, < 2.5 um	9.77E-06	kg
Dioxins (unspec.)	1.19E-14	kg
Radon-222	7.27E+00	kBq
Sulfur dioxide	1.60E-04	kg
Output - Emissions to water		
Ammonium, ion	1.67E-06	kg
Arsenic, ion	1.84E-08	kg
Cadmium, ion	1.07E-08	kg
Carbon-14	1.58E-04	kBq
Cesium-137	7.35E-05	kBq
Chromium, ion	2.92E-09	kg
Chromium VI	2.66E+00	kg
COD, Chemical Oxygen Demand	9.09E-05	kg
Copper, ion	1.08E-07	kg
Lead	3.82E-08	kg
Mercury	1.62E-09	kg
Nickel, ion	4.49E-07	kg
Nitrate	4.23E-06	kg
Oils, unspecified	1.13E-05	kg
PAH, polycyclic aromatic hydrocarbons	1.65E-09	kg
Phosphate	1.74E-06	kg
Output - Emissions to soil		
Arsenic	4.17E-10	kg
Cadmium	4.65E-12	kg
Chromium	5.31E-09	kg
Chromium VI	9.35E-09	kg
Lead	3.96E-11	kg
Mercury	8.99E-14	kg
Oils, unspecified	5.84E-06	kg

Input - Resources		
Coal, brown, in ground	1.22E-03	kg
Coal, hard, unspecified, in ground	2.41E-03	kg
Gas, natural, in ground	1.99E-01	m3
Oil, crude, in ground	1.95E-03	kg
Uranium, in ground	2.26E-07	kg
Water, fresh	3.52E-03	m3
Occupation, forest	9.39E-04	m2a
Occupation, urban, continuously built	2.71E-04	m2a

As part of the current LCA study, electricity production in a natural gas power plant equipped with carbon capture is an important brick that is intended to be used in different scenarios that also involve fuels other than natural gas. The inventory for electricity production in a natural gas power plant with carbon capture using hydrogen as fuel (blended in natural gas as described in the previous chapters of the thesis, in the Power-to-Gas Hydrogen pathway), obtained by removing the natural gas requirement as a resource and the emissions associated to burning it, is presented in Table 10.13. The required quantity of hydrogen is calculated using the HHV of hydrogen (39.4 kWh/kg) and a 60% efficiency of the combined cycle power plant [Bauer et al. 2008].

Table 10.13 Electricity production in natural gas power plant with carbon capture (using hydrogen as fuel) inventory

Electricity in NGPP with CC (from hydrogen)		
Product (final or intermediary)	Quantity	Unit
electricity, natural gas, CC plant, 500 MWe post CCS, 400 km, 2500 m from NG	1	kWh
Avoided products		
Storage, CO2 depleted gas field, 400 km pipeline	0.325	kg
Output - Emissions to air		
Arsenic	2.37E-09	kg
Cadmium	1.06E-09	kg
Carbon-14	4.59E-04	kBq
Chromium	4.61E-08	kg
Chromium VI	1.11E-09	kg
Iodine-129	3.93E-07	kBq
Lead	1.21E-08	kg
Mercury	2.47E-09	kg
Nickel	1.33E-08	kg
NMVOOC, non-methane volatile organic compounds, unspecified origin	1.90E-04	kg

Particulates, < 10 um	5.68E-06	kg
Particulates, < 2.5 um	9.77E-06	kg
Dioxins (unspec.)	1.19E-14	kg
Radon-222	7.27E+00	kBq
Sulfur dioxide	1.60E-04	kg
Output - Emissions to water		
Ammonium, ion	1.67E-06	kg
Arsenic, ion	1.84E-08	kg
Cadmium, ion	1.07E-08	kg
Carbon-14	1.58E-04	kBq
Cesium-137	7.35E-05	kBq
Chromium, ion	2.92E-09	kg
Chromium VI	2.66E+00	kg
COD, Chemical Oxygen Demand	9.09E-05	kg
Copper, ion	1.08E-07	kg
Lead	3.82E-08	kg
Mercury	1.62E-09	kg
Nickel, ion	4.49E-07	kg
Nitrate	4.23E-06	kg
Oils, unspecified	1.13E-05	kg
PAH, polycyclic aromatic hydrocarbons	1.65E-09	kg
Phosphate	1.74E-06	kg
Output - Emissions to soil		
Arsenic	4.17E-10	kg
Cadmium	4.65E-12	kg
Chromium	5.31E-09	kg
Chromium VI	9.35E-09	kg
Lead	3.96E-11	kg
Mercury	8.99E-14	kg
Oils, unspecified	5.84E-06	kg
Input - Resources/Materials/Fuels		
Coal, brown, in ground	1.22E-03	kg
Coal, hard, unspecified, in ground	2.41E-03	kg
Oil, crude, in ground	1.95E-03	kg
Uranium, in ground	2.26E-07	kg
Water, fresh	3.52E-03	m3
Occupation, forest	9.39E-04	m2a
Occupation, urban, continuously built	2.71E-04	m2a
Hydrogen from electrolysis	4.23E-02	kg

In the case of using SNG as fuel for the natural gas power plant, the required quantity is given by the HHV of SNG, 15.4 kWh/kg, (which in our case is the same as the one of natural gas, as described in the previous chapters that detail the methanation process) and the 60% efficiency of the combined cycle power plant [Bauer et al. 2008]. Since the SNG taken into consideration has approximately the same chemical properties as natural gas, the inventory includes the same level of emissions, but removes natural gas from resources and replaces it with SNG produced in the methanation process (Table 10.14).

Table 10.14 Electricity production in natural gas power plant with carbon capture (using SNG as fuel) inventory

Electricity from NGPP with CC (from SNG)		
Product (final or intermediary)	Quantity	Unit
electricity, natural gas, CC plant, 500 MWe post CCS	1	kWh
Avoided products		
Storage, CO2 depleted gas field, 400 km pipeline	0.325	kg
Output - Emissions to air		
Ammonia	1.49E-06	kg
Arsenic	2.37E-09	kg
Cadmium	1.06E-09	kg
Carbon dioxide, fossil	9.50E-02	kg
Carbon monoxide, fossil	1.09E-04	kg
Carbon-14	4.59E-04	kBq
Chromium	4.61E-08	kg
Chromium VI	1.11E-09	kg
Dinitrogen monoxide	7.94E-06	kg
Iodine-129	3.93E-07	kBq
Lead	1.21E-08	kg
Methane, fossil	8.87E-04	kg
Mercury	2.47E-09	kg
Nickel	1.33E-08	kg
Nitrogen oxides	1.85E-04	kg
NMVOOC, non-methane volatile organic compounds, unspecified origin	1.90E+00	kg
Particulates, < 10 um	5.68E-06	kg
Particulates, < 2.5 um	9.77E-06	kg
Dioxins (unspec.)	1.19E-14	kg
Radon-222	7.27E+00	kBq
Sulfur dioxide	1.60E-04	kg

Output - Emissions to water		
Ammonium, ion	1.67E-06	kg
Arsenic, ion	1.84E-08	kg
Cadmium, ion	1.07E-08	kg
Carbon-14	1.58E-04	kBq
Cesium-137	7.35E-05	kBq
Chromium, ion	2.92E-09	kg
Chromium VI	2.66E+00	kg
COD, Chemical Oxygen Demand	9.09E-05	kg
Copper, ion	1.08E-07	kg
Lead	3.82E-08	kg
Mercury	1.62E-09	kg
Nickel, ion	4.49E-07	kg
Nitrate	4.23E-06	kg
Oils, unspecified	1.13E-05	kg
PAH, polycyclic aromatic hydrocarbons	1.65E-09	kg
Phosphate	1.74E-06	kg
Output - Emissions to soil		
Arsenic	4.17E-10	kg
Cadmium	4.65E-12	kg
Chromium	5.31E-09	kg
Chromium VI	9.35E-09	kg
Lead	3.96E-11	kg
Mercury	8.99E-14	kg
Oils, unspecified	5.84E-06	kg
Input - Resources		
Coal, brown, in ground	1.22E-03	kg
Coal, hard, unspecified, in ground	2.41E-03	kg
Oil, crude, in ground	1.95E-03	kg
Uranium, in ground	2.26E-07	kg
Water, fresh	3.52E-03	m3
Occupation, forest	9.39E-04	m2a
Occupation, urban, continuously built	2.71E-04	m2a
SNG	1.08E-01	kg

10.3.2.5 Heat production in a condensing boiler

Heat is one of the possible end-uses of the Power-to-Gas SNG pathway and in order to evaluate the environmental impacts of producing 1 MJ of heat from SNG burned in a condensing modulating boiler, the following inventories were imported and adapted from the ecoinvent database (Table 10.15 and Table 10.16). The starting point and the reference scenario was the inventory entry for “Natural gas, burned in boiler condensing modulating <100kW/RER U” [ecoinvent n.d.]. For the SNG scenario, the natural gas entry under the Materials/Fuels category was replaced with the equivalent quantity of SNG produced from methanation, using the HHV of SNG (15.4 kWh/kg). Another inventory is necessary for transforming the functional unit of this inventory into useful heat: “Heat, SNG, at boiler condensing modulating <100kW / RER U”, adapted from the “Heat, natural gas, at boiler condensing modulating, 100kW / RER U” inventory [ecoinvent n.d.].

Table 10.15 SNG burned in boiler inventory

SNG burned in boiler		
Product (final or intermediary)	Quantity	Unit
SNG, burned in boiler condensing modulating <100kW/RER U	1	MJ
Output - Emissions to air		
Heat, waste	1.11E+00	MJ
Acetaldehyde	1.00E-09	kg
Benzo(a)pyrene	1.00E-11	kg
Benzene	4.00E-07	kg
Butane	7.00E-07	kg
Methane, fossil	2.00E-06	kg
Carbon monoxide, fossil	5.90E-06	kg
Carbon dioxide, fossil	5.60E-02	kg
Acetic acid	1.50E-07	kg
Formaldehyde	1.00E-07	kg
Mercury	3.00E-11	kg
Dinitrogen monoxide	5.00E-07	kg
Nitrogen oxides	9.90E-06	kg
PAH, polycyclic aromatic hydrocarbons	1.00E-08	kg
Particulates, < 2.5 um	1.00E-07	kg
Pentane	1.20E-06	kg
Propane	2.00E-07	kg
Propionic acid	2.00E-08	kg
Sulfur dioxide	5.00E-07	kg

Dioxin, 2,3,7,8 Tetrachlorodibenzo-p-	3.00E-17	kg
Toluene	2.00E-07	kg
Output - Emissions to water		
Nitrate	1.30E-07	kg
Nitrite	3.00E-09	kg
Sulfate	5.00E-08	kg
Sulfite	5.00E-08	kg
Input - Resources/Materials		
Electricity, low voltage, production UCTE, at grid/UCTE U	2.78E-03	kWh
Gas boiler/RER/I U	6.60E-07	p
SNG	1.80E-02	kg

Table 10.16 Heat produced in boiler using SNG as fuel inventory

Heat from SNG, at boiler		
Product (final or intermediary)	Quantity	Unit
Heat, SNG, at boiler condensing modulating <100kW/RER U	1	MJ
Input - Resources/Materials		
SNG, burned in boiler condensing modulating <100kW/RER U	9.80E-01	MJ

10.3.2.6 Electricity production in natural gas power plant with no carbon capture

For this process the [ecoinvent n.d.] inventory for “Electricity, natural gas, at power plant/UCTE U” was used as a reference case and modified for using SNG instead of natural gas:

Table 10.17 Electricity production in natural gas power plant (no carbon capture) using SNG as fuel inventory

Electricity from NGPP (no CC) from SNG		
Product (final or intermediary)	Quantity	Unit
Electricity, SNG, at power plant/UCTE U	1	kWh
Input - Resources/Materials		
SNG burned in power plant/UCTE U	9.48	MJ

10.3.2.7 Cement plant with carbon capture

Building an inventory for a cement production facility equipped with carbon capture was outside the scope of the current LCA studies. However, integrating the Power-to-Gas process with the cement industry represents an interesting scenario, therefore in order to briefly assess the GWP impact of this particular scenario, the CO₂ emissions associated to cement production were imported from [Volkart et al. 2013].

10.3.2.8 Hydrogen production from steam reforming

Natural gas steam reforming currently represents the benchmark hydrogen production process and the impacts associated to it are imported from [Cetinkaya et al. 2012].

10.3.3 Complex Power-to-Gas processes

The purpose of evaluating complex Power-to-Gas processes consists in establishing the environmental impact of offering multiple energy uses to the same quantity of CO₂ before finally emitting it.

10.3.3.1 Single Power-to-Gas cycle

The single Power-to-Gas cycle scenario is based on the application of the Power-to-Gas SNG pathway (thoroughly described in the previous chapters) in a realistic case that takes into consideration upstream and downstream components in a “cradle-to-gate” approach. In this particular scenario, the CO₂ that is produced and captured at the first natural gas power plant (with CC) is considered to be fossil, according to the considerations regarding the origin of this resource, presented in section 2.2. The carbon dioxide associated with electricity production is trapped and reused for one Power-to-Gas cycle before being emitted in a power plant with no carbon capture capabilities.

The functional unit of the “Single Power-to-Gas cycle” scenario is 1 kWh of electricity produced by a system that includes:

- a natural gas power plant (equipped with carbon capture) fueled with natural gas that produces electricity, as well as CO₂ necessary for the SNG production – (Table 10.12).
- the core Power-to-Gas SNG system (hydrogen production from renewable energy and the methanation unit) – (Table 10.11).
- a natural gas power plant (with no carbon capture) fueled with SNG, producing electricity and emitting fossil CO₂ – (Table 10.17).

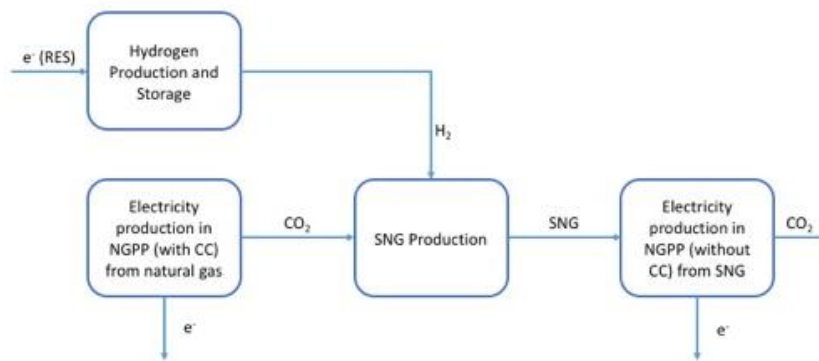

Figure 10.2 Single Power-to-Gas cycle diagram

In order to calculate the contribution each elementary process has, we started with calculating the required SNG quantity for producing 1 kWh of electricity in a natural gas power plant (without CC). Using data from the ecoinvent database, for producing 1 kWh of electricity, 9.48 MJ of SNG are required, corresponding to 0.170 kg of SNG. For this, the methanation process requires an input of 0.470 kg CO₂ (according to calculations detailed in the previous chapters dealing with the technical aspects of the methanation process). This CO₂ quantity is emitted and captured (given a 99% CO₂ capture efficiency) by a natural gas power plant (equipped with CC) for producing 1.447 kWh of electricity. Therefore, the whole “Single Power-to-Gas” cycle produces a total of 2.447 kWh of electricity, but the inventory is normalized to 1 kWh of electricity for comparison purposes (Table 10.18).

Table 10.18 Single Power-to-Gas cycle inventory

Single Power-to-Gas cycle		
Product (final or intermediary)	Quantity	Unit
Electricity	1	kWh
Main process components		
Electricity, natural gas, CC plant, 500 MWe post CCS, 400 km, 2500 m from NG	1.447/2.447=0.591	kWh
SNG	0.170/2.447=0.069	kg
Electricity, SNG, at power plant/UCTE U	1/2.447=0.408	kWh

10.3.3.2 Double Power-to-Gas cycle

This scenario essentially adds a second Power-to-Gas cycle to the previous scenario in order to investigate the environmental benefits of trapping CO₂ for an additional cycle before finally emitting it.

The functional unit used is 1 kWh of electricity produced in a system that includes:

- a natural gas power plant (equipped with carbon capture) fueled with natural gas that produces electricity, as well as CO₂ necessary for the SNG production – (Table 10.12).
- the core Power-to-Gas SNG system (hydrogen production from renewable energy and the methanation unit) – (Table 10.11).
- a natural gas power plant (equipped with carbon capture) fueled with SNG that produces electricity, as well as CO₂ necessary for the SNG production – (Table 10.14).
- the core Power-to-Gas SNG system (hydrogen production from renewable energy and the methanation unit) – (Table 10.11).
- a natural gas power plant (with no carbon capture) fueled with SNG, producing electricity and emitting fossil CO₂ – (Table 10.17).

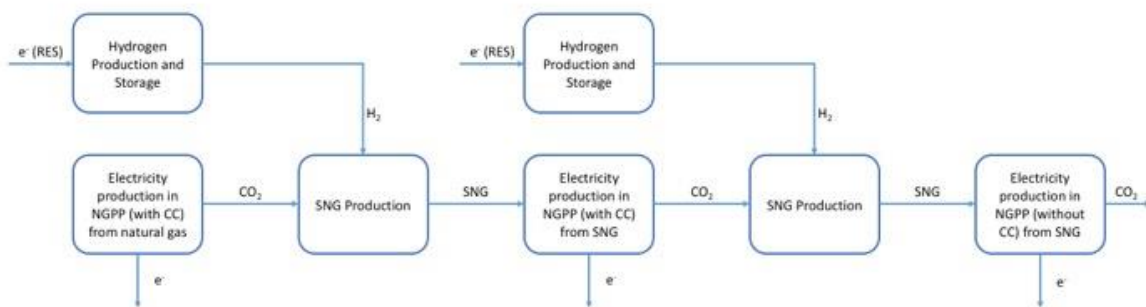

Figure 10.3 Double Power-to-Gas cycle diagram

The calculation for determining the allocation of each elementary process is similar to the one described for the “Single Power-to-Gas cycle”. Therefore, for producing 1 kWh in a natural gas power plant (with CC) from SNG, a quantity of 0.108 kg of SNG is required, given the HHV of SNG and the efficiency of the power plant [Bauer et al. 2008]. Note that the difference in efficiency between the power plant (with CC) and the power plant (without CC) comes from using two different references for these two processes. For producing this SNG quantity, a fresh

CO₂ input of 0.297 kg is required, produced and captured for 0.984 kWh of electricity generated in a natural gas power plant (with CC) fueled by natural gas, corresponding to the efficiencies presented in [Bauer et al. 2008]. Downstream from the second power plant, the CO₂ captured after producing 1 kWh of electricity is used for producing 0.106 kg SNG in the second Power-to-Gas cycle, which is transformed in to 0.621 kWh in the power plant (with no CC) fueled by SNG. In total, the “Double Power-to-Gas cycle” produces 2.605 kWh of electricity. After normalizing the overall inventory to refer to a functional unit of 1 kWh of electricity, the contribution of all the processes is given by Table 10.19.

Table 10.19 Double Power-to-Gas cycle inventory

Double Power-to-Gas cycle		
Product (final or intermediary)	Quantity	Unit
Electricity	1	kWh
Main process components		
Electricity, natural gas, CC plant, 500 MWe post CCS, 400 km, 2500 m from NG	$0.984/2.605=0.377$	kWh
SNG	$0.108/2.605=0.041$	kg
Electricity, natural gas, CC plant, 500 MWe post CCS, 400 km and 2500 m from SNG	$1/2.605=0.383$	kWh
SNG	$0.106/2.605=0.040$	kg
Electricity, SNG, at power plant/UCTE U	$0.621/2.605=0.238$	kWh

10.3.3.3 Single Power-to-Gas cycle linked with the cement industry

Due to the high CO₂ emissions associated with the cement industry and theoretical heat integration capabilities, it represents a good candidate for being part of a Power-to-Gas cycle. This scenario analyzes a technical pathway that includes the following components:

- A cement plant equipped with carbon capture that produces the necessary CO₂ for the Power-to-Gas process.
- the core Power-to-Gas SNG system (hydrogen production from renewable energy and the methanation unit) – (Table 10.11).
- a natural gas power plant (with no carbon capture) fueled with SNG, producing electricity and emitting fossil CO₂ – (Table 10.17).

A full inventory for the cement plant with carbon capture was not taken into consideration, but the overall GWP impact was imported in three different scenarios from [Volkart et al. 2013], the functional unit being 1 kg of cement:

- cement production in a plant that uses steam and electricity produced with energy from the UCTE grid for carbon capture – 4.09E-1 kgCO₂eq/kg of cement
- cement production in a plant that uses steam from waste heat and electricity from the UCTE grid for carbon capture – 1.50E-1 kgCO₂eq/kg of cement
- cement production in a plant that uses steam and electricity from a natural gas CHP for carbon capture – 2.34E-1 kgCO₂eq/kg of cement

The functional unit of the “Single Power-to-Gas cycle applied in the cement industry” remains 1 kWh of electricity. Cement is not taken into consideration as an output product, but it is used for allocating a carbon footprint to the CO₂ associated to its production and used in the Power-to-Gas technology (all the CO₂ associated with the production of cement is allocated to the output CO₂ of the electricity production in the described scenarios). Therefore, in order to produce 1 kWh of electricity in the natural gas power plant with no carbon capture, fueled by SNG, a quantity of 0.170 kg of SNG is required. In order to produce it, a fresh CO₂ input of 0.470 kg is necessary, emitted for producing 0.668 kg of cement [Volkart et al. 2013].

Table 10.20 Single Power-to-Gas cycle applied in the cement industry inventory

Single Power-to-Gas cycle applied in the cement industry		
Product (final)	Quantity	Unit
Electricity	1	kWh
Main process components		
Cement production steam/electricity UCTE grid	0.668	kg
SNG	0.170	kg
Electricity, SNG, at power plant/UCTE U	1	kWh

10.3.3.4 Double Power-to-Gas cycle applied in the cement industry

The purpose of this scenario is to study the effects of trapping the CO₂ produced by the cement industry for two Power-to-Gas loops before finally emitting it in a power plant that is not equipped with carbon capture. In addition to the previously presented scenario, the following processes are added:

- a natural gas power plant (equipped with carbon capture) fueled with SNG that produces electricity, as well as CO₂ necessary for the SNG production – (Table 10.14).
- an additional core Power-to-Gas SNG system (hydrogen production from renewable energy and the methanation unit) – (Table 10.11).

The methodology for allocating the impacts of the processes in the final functional unit (1 kWh of electricity) is similar to the one presented in 3.3.2. The initial CO₂ requirement of 0.297 kg is associated to a production of 0.422 kg of cement [Volkart et al. 2013]. The total electricity produced in this scenario is 1.621 kWh and the inventory will be normalized for 1 kWh.

Table 10.21 Double Power-to-Gas cycle applied in the cement industry inventory

Double Power-to-Gas cycle applied in the cement industry		
Product (final)	Quantity	Unit
Electricity	1	kWh
Main process components		
Cement production steam/electricity UCTE grid	0.422/1.621=0.260	kg
SNG	0.108/1.621=0.066	kg
Electricity, natural gas, CC plant, 500 MWe post CCS, 400 km and 2500 m from SNG	1/1.621=0.616	kWh
SNG	0.106/1.621=0.065	kg
Electricity, SNG, at power plant/UCTE U	0.621/1.621=0.383	kWh

10.4 LIFE CYCLE ASSESSMENT RESULTS

10.4.1 Greenhouse gas emissions

10.4.1.1 Hydrogen production

The results displayed in Figure 10.4 indicate that the most important contribution to the GWP emissions of electrolytic hydrogen production comes from the operation phase (between 48 and 89%, depending on the energy mix scenario), which includes the energy required for splitting the water molecules, as well as the energy needed for compression. Interestingly, it is the energy required in the compression phase that contributes the most to this indicator in the Romanian and French scenarios, since it is coming from the national energy mix. The results in the Romanian case are caused by the high-carbon energy mix taken into account by the ecoinvent database (although the situation improved in the last years with the high penetration of renewable energy sources, as presented in the first chapter of the thesis). In the French case (with a mix dominated by nuclear energy) the situation is drastically improved, while the minimum carbon footprint is obtained when using only renewable energy.

Compared to the reference hydrogen production from steam reforming scenario [Cetinkaya et al. 2012], renewable hydrogen scenarios have significantly lower carbon emissions (1,453 vs. 11.893 kgCO₂/kgH₂) even though they include the burden of the compression and storage phase. The total GWP impact of renewable hydrogen can be even lower if we leave out the compression stage and the functional unit is hydrogen at atmospheric pressure. Figure 10.5 presents a detailed view of the importance the source of electricity used for compression has on the overall GWP impact of the operation phase.

Table 10.22 Double Power-to-Gas cycle applied in the cement industry inventory

Scenario	Functional unit	Energy mix/Reference	Components	GWP [kgCO ₂ /kg H ₂]	Total GWP [kgCO ₂ /kg H ₂]
Renewable hydrogen	1 kg of hydrogen	Romanian	Electrolyser contribution	0.036	6.593
			Compressor contribution	0.006	
			Storage module contribution	0.229	
			Walls and foundation contribution	0.066	
			Other components contribution	0.012	
			Maintenance contribution	0.385	
			Operation contribution	5.859	
		French	Electrolyser contribution	0.036	2.224
			Compressor contribution	0.006	
Storage module contribution	0.229				
Walls and foundation contribution	0.066				
Other components contribution	0.012				
Maintenance contribution	0.385				
Operation contribution	1.489				
Renewable	Electrolyser contribution	0.036	1.453		
	Compressor contribution	0.006			
	Storage module contribution	0.229			
	Walls and foundation contribution	0.066			
	Other components contribution	0.012			
	Maintenance contribution	0.385			
	Operation contribution	0.718			
Steam reforming	1 kg of hydrogen	[Cetinkaya et al. 2012]	Construction and decommissioning of the plant	2.972	11.893
			Natural gas production and transport	0.053	
			Electricity generation (w/o steam export)	0.273	
			Operation	8.595	

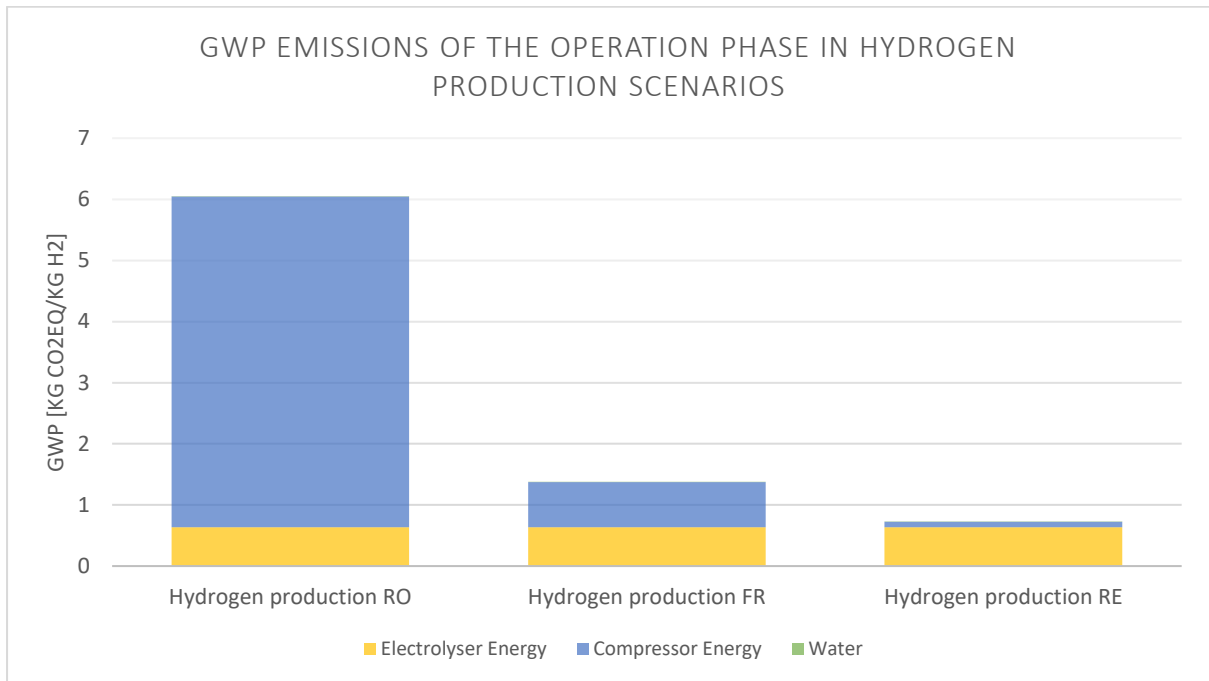

Figure 10.4 GWP emissions of the operation phase in the considered hydrogen production scenarios

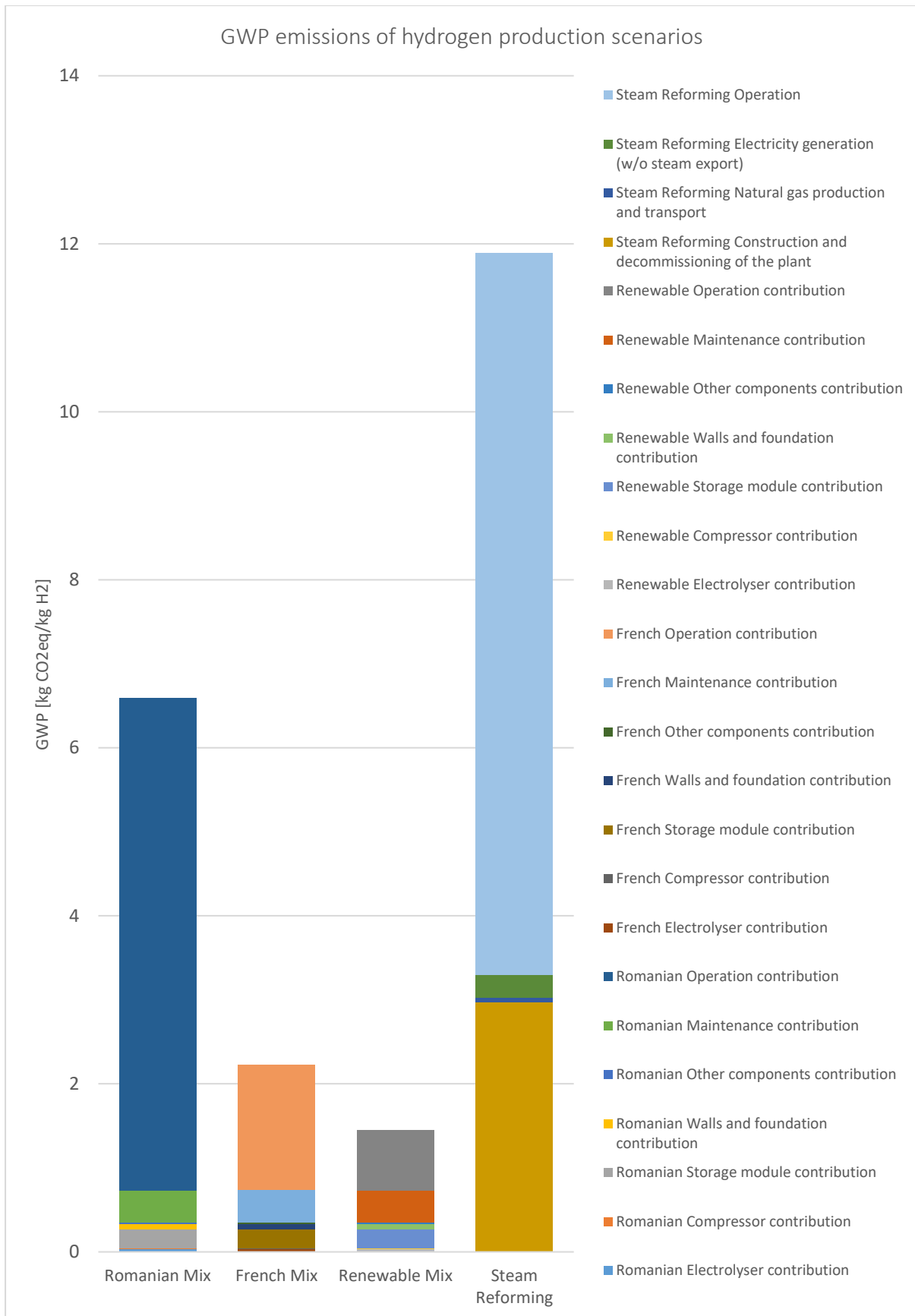

Figure 10.5 GWP emissions of hydrogen production scenarios

Some intermediate conclusions can be drawn: the impact associated to the infrastructure required for producing hydrogen from electrolysis is small compared to the one for steam reforming. In addition, electrolytic hydrogen production proves to be a viable path even in the scenarios with high CO₂ emissions from the energy mix when the overall GWP emissions are still lower compared to the steam reforming path.

10.4.1.2 Electricity production

a. Electricity production in power plants with CC

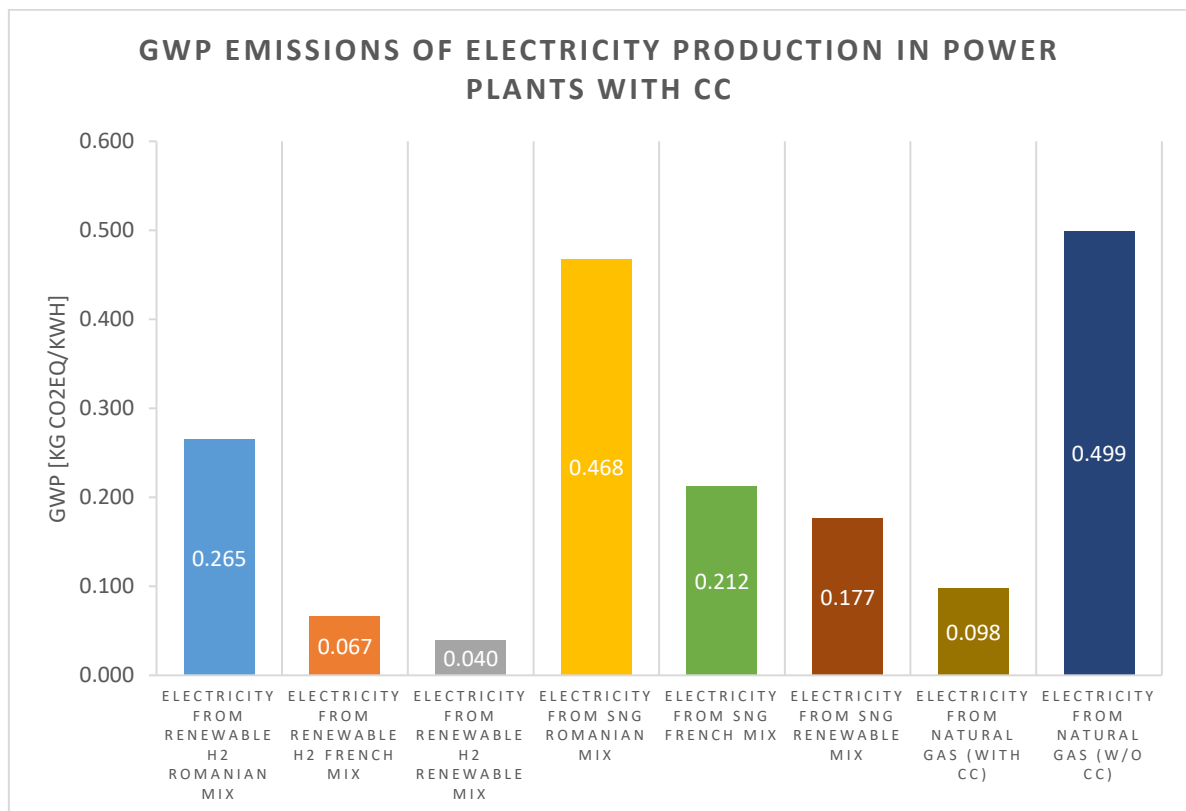

Figure 10.6 GWP emissions of electricity production scenarios

The results of the electricity from renewable hydrogen scenarios (corresponding to hydrogen injection from the previous technical and economic chapters) are similar with the ones for hydrogen production, being strongly influenced by the source of energy used for hydrogen compression. Since there is no CO₂ emitted during the electricity production in the power plant phase, the overall burden of this pathway is the lowest when compared to electricity production from SNG or the reference scenarios in which natural gas is used.

In the electricity from SNG scenario, most of the burden is associated with the SNG production phase, again influenced by the energy used for the compression phase. For this particular scenario, the CO₂ required in the SNG production phase is considered to be biogenic (since it is a waste product of a process outside the perimeter of the study that would otherwise be emitted to the atmosphere – scenario A, as defined in the beginning of the chapter), therefore no burden is associated to it. In spite of this, the CO₂ emissions of this pathway are higher than the ones associated to the reference scenario in which electricity is produced from natural gas (in a power plant equipped with carbon capture) even in the renewable mix scenario.

Table 10.23 GWP emissions of electricity production scenarios

Scenario	Functional unit	Energy mix/Reference	Components	GWP [kgCO ₂ eq]	Total GWP [kgCO ₂ eq]
Electricity from renewable hydrogen (with CC)	1 kWh of electricity	Romanian			0.265
		French			0.067
		Renewable			0.040
Electricity from SNG (with CC)	1 kWh of electricity	Romanian	Electricity from NGPP (with CC)	0.098	0.468
			SNG production	0.367	
		French	Electricity from NGPP (with CC)	0.098	0.212
			SNG production	0.114	
		Renewable	Electricity from NGPP (with CC)	0.098	0.177
			SNG production	0.079	
Electricity from natural gas (with CC)	1 kWh of electricity		Electricity from NGPP (with CC) from NG		0.098
Electricity from natural gas (w/o CC)	1 kWh of electricity	[Spath & Mann 2000]			0.499

Given the type of modeling chosen for this analysis and its inherent limitations, the difference between the electricity from SNG in the Romanian energy mix case and the reference case of producing electricity in a natural gas power plant (without CC) is not significant and the two scenarios can be considered equivalent in terms of GWP emissions.

b. Electricity production in complex Power-to-Gas scenarios

The purpose of these scenarios was to evaluate the GWP impact of the Power-to-Gas concept as a part of a complete technological chain that takes into consideration the upstream processes

related to the source of carbon dioxide, which in these cases is considered to be fossil, as well as the downstream processes where CO₂ is ultimately emitted.

Single and double Power-to-Gas cycles are benchmarked in order to highlight the influence of using the same CO₂ multiple times before finally emitting it.

Fossil carbon from power plants:

Single Power-to-Gas cycle scenarios rely on fossil carbon captured from natural gas power plants, used for producing SNG, which is finally transformed into electricity in a power plant that is not equipped with carbon capture. Double Power-to-Gas cycle scenarios add an additional cycle, using the same carbon dioxide two times before emitting it. In these scenarios, CO₂ is considered fossil taking into account the hypothesis that emitters would have to pay for emission allowances. (Scenario C)

Table 10.24 GWP emissions of electricity production in complex Power-to-Gas scenarios using fossil carbon from power plants

Scenario	Functional unit	Energy mix/Reference	Components	GWP [kgCO ₂ eq]	Total GWP [kgCO ₂ eq]
Single Power-to-Gas cycle	1 kWh of electricity	Romanian	Electricity from NGPP (with CC) from NG	0.058	0.513
			SNG production	0.237	
			Electricity from NGPP (w/o CC) from SNG	0.218	
		French	Electricity from NGPP (with CC) from NG	0.058	0.349
			SNG production	0.073	
			Electricity from NGPP (w/o CC) from SNG	0.218	
Renewable	Electricity from NGPP (with CC) from NG	0.058	0.327		
	SNG production	0.051			
	Electricity from NGPP (w/o CC) from SNG	0.218			
Double Power-to-Gas cycle	1 kWh of electricity	Romanian	Electricity from NGPP (with CC) from NG	0.037	0.482
			SNG production	0.141	
			Electricity from NGPP (with CC) from SNG	0.038	
			SNG production	0.038	
			Electricity from NGPP (w/o CC) from SNG	0.127	

		French	Electricity from NGPP (with CC) from NG	0.037	0.289
			SNG production	0.044	
			Electricity from NGPP (with CC) from SNG	0.038	
			SNG production	0.043	
			Electricity from NGPP (w/o CC) from SNG	0.127	
		Renewable	Electricity from NGPP (with CC) from NG	0.037	0.262
			SNG production	0.030	
			Electricity from NGPP (with CC) from SNG	0.038	
			SNG production	0.030	
			Electricity from NGPP (w/o CC) from SNG	0.127	

The results indicate that there is an environmental gain in terms of GWP impact when trapping CO₂ in multiple Power-to-Gas cycles before finally emitting it.

Compared to the reference electricity production from natural gas scenario (w/o CC), all these scenarios have a lower GWP impact, with the exception of the Single Power-to-Gas cycle Romanian mix scenario, which has a slightly higher CO₂ burden. However, given the type of modeling, the differences are small, thus cannot be considered significant.

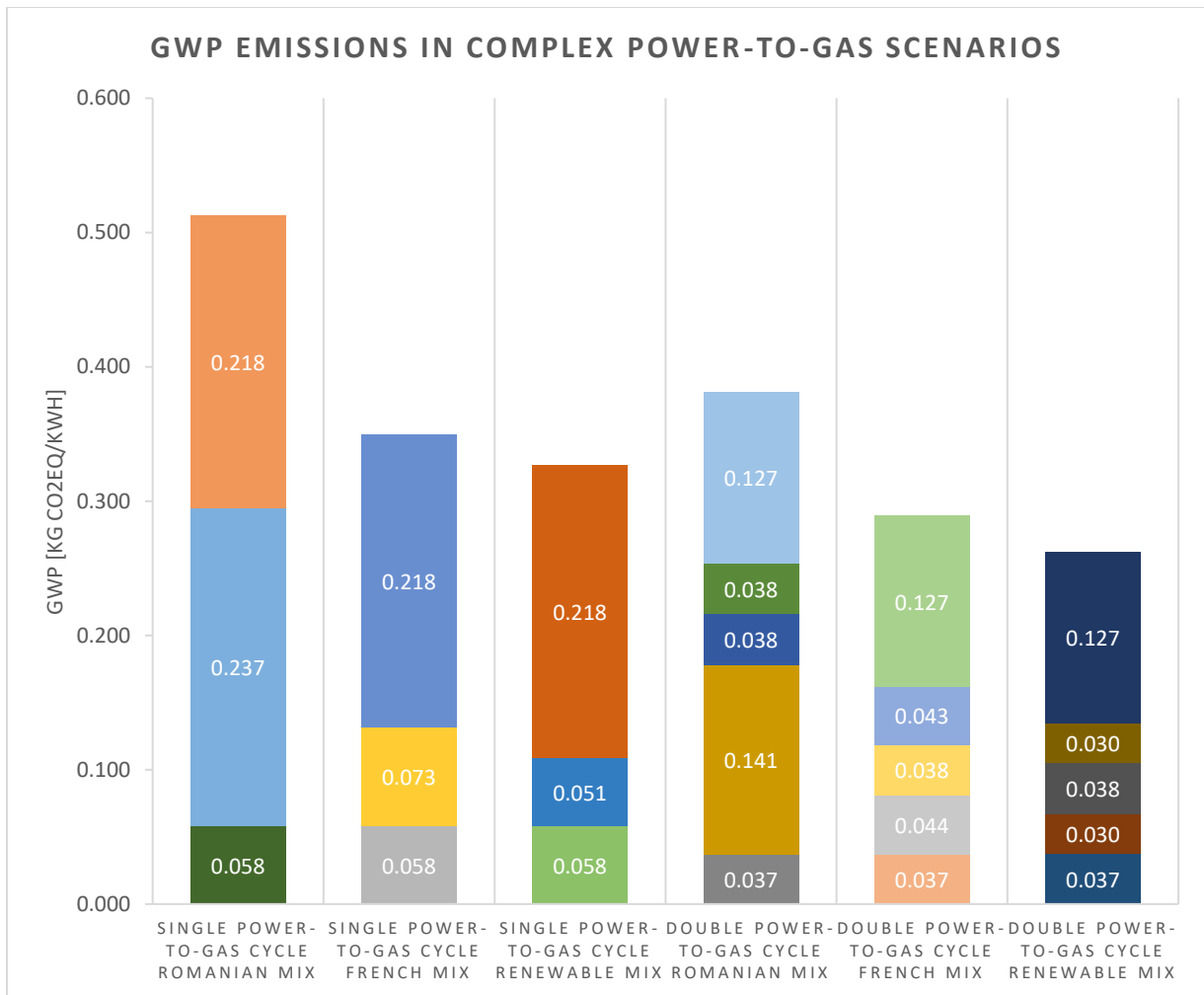

Figure 10.7 GWP emissions of electricity production in complex Power-to-Gas scenarios using fossil carbon from power plants

Fossil carbon from the cement industry:

Fossil carbon captured from the cement production industry is used for one or two cycles before finally being emitted. Like in the previous case, a double Power-to-Gas cycle makes more sense from the GWP impact point of view, offering considerable reductions compared to the single cycle throughout all the analyzed scenarios. The lowest GWP impact is obtained when using steam from waste heat and electricity from the grid for carbon capture in the cement plant (note that these energy inputs are not geographically localized meaning that they don't take into account different country specific energy mixes, as is the case for the SNG production phase).

Table 10.25 GWP emissions of electricity production in complex Power-to-Gas scenarios using fossil carbon from the cement industry

Scenario	Functional unit	Energy mix/Reference	Components	GWP [kgCO ₂ eq]	Total GWP [kgCO ₂ eq]
Single Power-to-Gas cycle (cement)	1 kWh of electricity	Romanian / Steam & Electricity UCTE	Cement production (with CC)	0.273	1.392
			SNG production	0.583	
			Electricity from NGPP (w/o CC) from SNG	0.535	
		Romanian / Steam from waste heat & Electricity UCTE	Cement production (with CC)	0.100	1.219
			SNG production	0.583	
			Electricity from NGPP (w/o CC) from SNG	0.535	
		Romanian / Steam & Electricity NG CHP	Cement production (with CC)	0.156	1.275
			SNG production	0.583	
			Electricity from NGPP (w/o CC) from SNG	0.535	
French/ Steam & Electricity UCTE	Cement production (with CC)	0.273	0.989		
	SNG production	0.181			
	Electricity from NGPP (w/o CC) from SNG	0.535			
French / Steam from waste heat & Electricity UCTE	Cement production (with CC)	0.100	0.816		
	SNG production	0.181			
	Electricity from NGPP (w/o CC) from SNG	0.535			
French / Steam & Electricity NG CHP	Cement production (with CC)	0.156	0.872		
	SNG production	0.181			
	Electricity from NGPP (w/o CC) from SNG	0.535			
Renewable / Steam & Electricity UCTE	Cement production (with CC)	0.273	0.934		
	SNG production	0.125			
	Electricity from NGPP (w/o CC) from SNG	0.535			
Renewable / Steam from waste heat & Electricity UCTE	Cement production (with CC)	0.100	0.760		
	SNG production	0.125			
	Electricity from NGPP (w/o CC) from SNG	0.535			
Renewable / Steam & Electricity NG CHP	Cement production (with CC)	0.156	0.817		
	SNG production	0.125			
	Electricity from NGPP (w/o CC) from SNG	0.535			
Double Power-to-Gas cycle (cement)	1 kWh of electricity	Romanian / Steam & Electricity UCTE	Cement production (with CC)	0.106	0.821
		SNG production	0.226		
		Electricity from NGPP (with CC) from SNG	0.061		

		SNG production	0.223	
		Electricity from NGPP (w/o CC) from SNG	0.205	
	Romanian / Steam from waste heat & Electricity UCTE	Cement production (with CC)	0.039	0.754
		SNG production	0.226	
		Electricity from NGPP (with CC) from SNG	0.061	
		SNG production	0.223	
		Electricity from NGPP (w/o CC) from SNG	0.205	
	Romanian / Steam & Electricity NG CHP	Cement production (with CC)	0.061	0.776
		SNG production	0.226	
		Electricity from NGPP (with CC) from SNG	0.061	
		SNG production	0.223	
		Electricity from NGPP (w/o CC) from SNG	0.205	
	French / Steam & Electricity UCTE	Cement production (with CC)	0.106	0.511
		SNG production	0.070	
		Electricity from NGPP (with CC) from SNG	0.061	
		SNG production	0.069	
		Electricity from NGPP (w/o CC) from SNG	0.205	
	French / Steam from waste heat & Electricity UCTE	Cement production (with CC)	0.039	0.444
		SNG production	0.070	
		Electricity from NGPP (with CC) from SNG	0.061	
		SNG production	0.069	
		Electricity from NGPP (w/o CC) from SNG	0.205	
	French / Steam & Electricity NG CHP	Cement production (with CC)	0.061	0.466
		SNG production	0.070	
		Electricity from NGPP (with CC) from SNG	0.061	
		SNG production	0.069	
		Electricity from NGPP (w/o CC) from SNG	0.205	
	Renewable / Steam & Electricity UCTE	Cement production (with CC)	0.106	0.468
		SNG production	0.049	
		Electricity from NGPP (with CC) from SNG	0.061	
		SNG production	0.048	
		Electricity from NGPP (w/o CC) from SNG	0.205	
		Cement production (with CC)	0.039	0.401

		Renewable / Steam from waste heat & Electricity UCTE	SNG production	0.049	0.423
			Electricity from NGPP (with CC) from SNG	0.061	
			SNG production	0.048	
			Electricity from NGPP (w/o CC) from SNG	0.205	
		Renewable / Steam & Electricity NG CHP	Cement production (with CC)	0.061	
			SNG production	0.049	
			Electricity from NGPP (with CC) from SNG	0.061	
			SNG production	0.048	
			Electricity from NGPP (w/o CC) from SNG	0.205	

The results indicate that the total GWP impacts in this case are higher than the ones calculated in the previous section (Power-to-Gas cycles with carbon dioxide captured from power plants). However, even though not included in the functional unit assumptions, part of this impact should be associated to the production of cement. Due to lack of data on the GWP emission impact of only the CO₂ capture part in cement production, all the emitted CO₂ was allocated to the captured CO₂ needed for SNG production, although obviously part of it is in real life allocated to the production of cement as a resource.

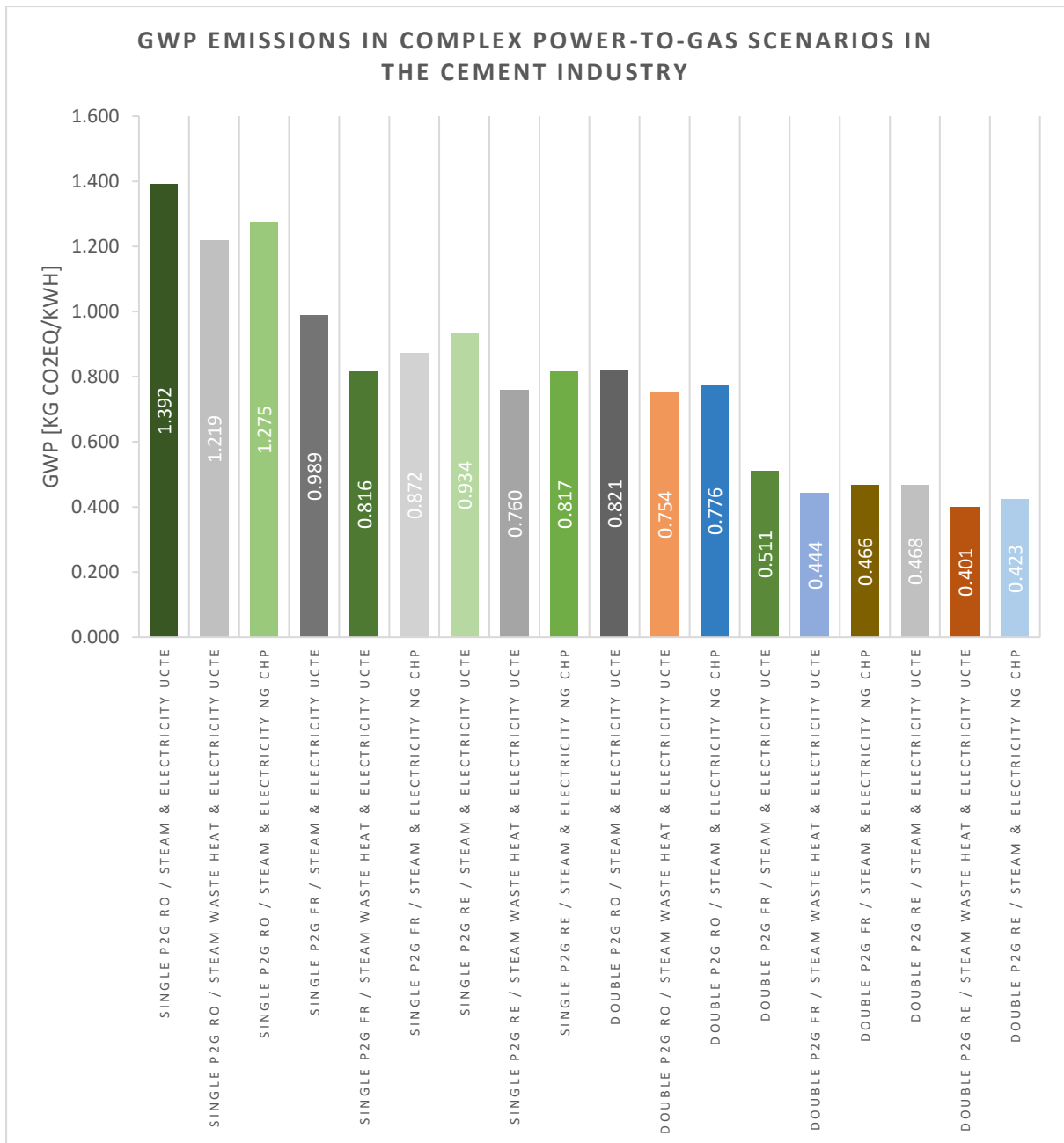

Figure 10.8 GWP emissions of electricity production in complex Power-to-Gas scenarios using fossil carbon from the cement industry

10.4.1.3 Heat production

The GWP impact of heat production from renewable SNG is higher than the reference heat from natural gas scenario when using the Romanian and the French mix and slightly lower when using only renewable energy. However, given the type of modeling used, the differences cannot be considered significant.

Note: Since CO₂ in this scenario is considered to be fossil, it is only counted when emitted.

Table 10.26 GWP emissions of heat production scenarios

Scenario	Functional unit	Energy mix/Reference	Components	Total GWP [kgCO ₂ eq]
Heat from SNG	1 MJ of heat	Romanian	SNG burned in boiler	0.1170
		French	SNG burned in boiler	0.0756
		Renewable	SNG burned in boiler	0.0698
Heat from natural gas			Natural gas burned in boiler	0.0718

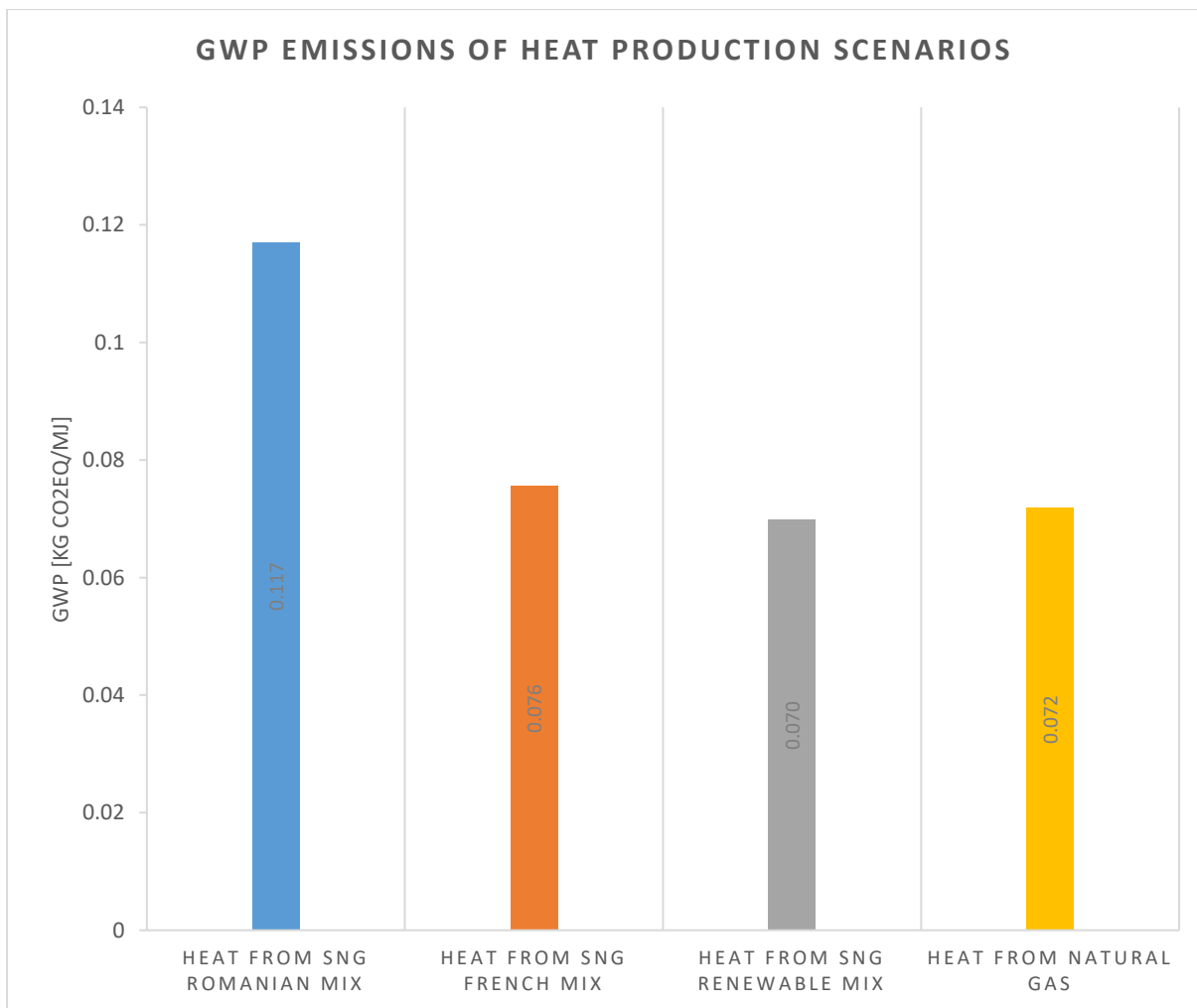

Figure 10.9 GWP emissions of heat production scenarios

10.4.2 Cumulative Energy Demand

10.4.2.1 Hydrogen Production

The total cumulative energy demand of producing renewable hydrogen is significantly higher than the reference steam reforming case. However, a closer look indicates that a large proportion of this energy is renewable, while steam reforming only uses fossil energy. The Romanian mix scenario comes with the highest fossil CED, while the French case relies more on non-renewable energy (due to the high proportion of nuclear power) that is not fossil. If we consider that the renewable energy that goes into renewable hydrogen production is surplus energy that cannot be used for replacing fossil energy in other applications, this pathway is a better alternative to steam reforming in terms of cumulative energy demand and avoiding fossil resource depletion.

Table 10.27 CED of hydrogen production scenarios

Scenario	Functional unit	Energy mix/ Reference	Components	CED [MJ/kg]		Total CED [MJ/kg]
				Non-renewable / Fossil	Renewable	
Renewable hydrogen	1 kg of hydrogen	Romanian		92.725 / 78.931	226.258	318.984
		French		124.493 / 27.314	221.624	346.117
		Renewable		21.841 / 18.749	248.114	269.956
Steam reforming	1 kg of hydrogen	Cetinkaya et al 2012	Construction and decommissioning of the plant	159.6		165.660
			Natural gas production and transport	4.15		
			Electricity generation (w/o steam export)	1.91		
			Operation	0		

The total cumulative energy demand of producing renewable hydrogen is significantly higher than the reference steam reforming case. However, a closer look indicates that a large proportion of this energy is renewable, while steam reforming only uses fossil energy. The

Romanian mix scenario comes with the highest fossil CED, while the French case relies more on non-renewable energy that is not fossil (due to the high proportion of nuclear power). Note: oil, coal and natural gas are considered to be fossil resources, while nuclear energy is considered non-renewable, but not fossil. If we consider that the renewable energy that goes into renewable hydrogen production is surplus energy that cannot be used for replacing fossil energy in other applications, this pathway is a better alternative to steam reforming in terms of non-renewable cumulative energy demand and avoiding fossil resource depletion.

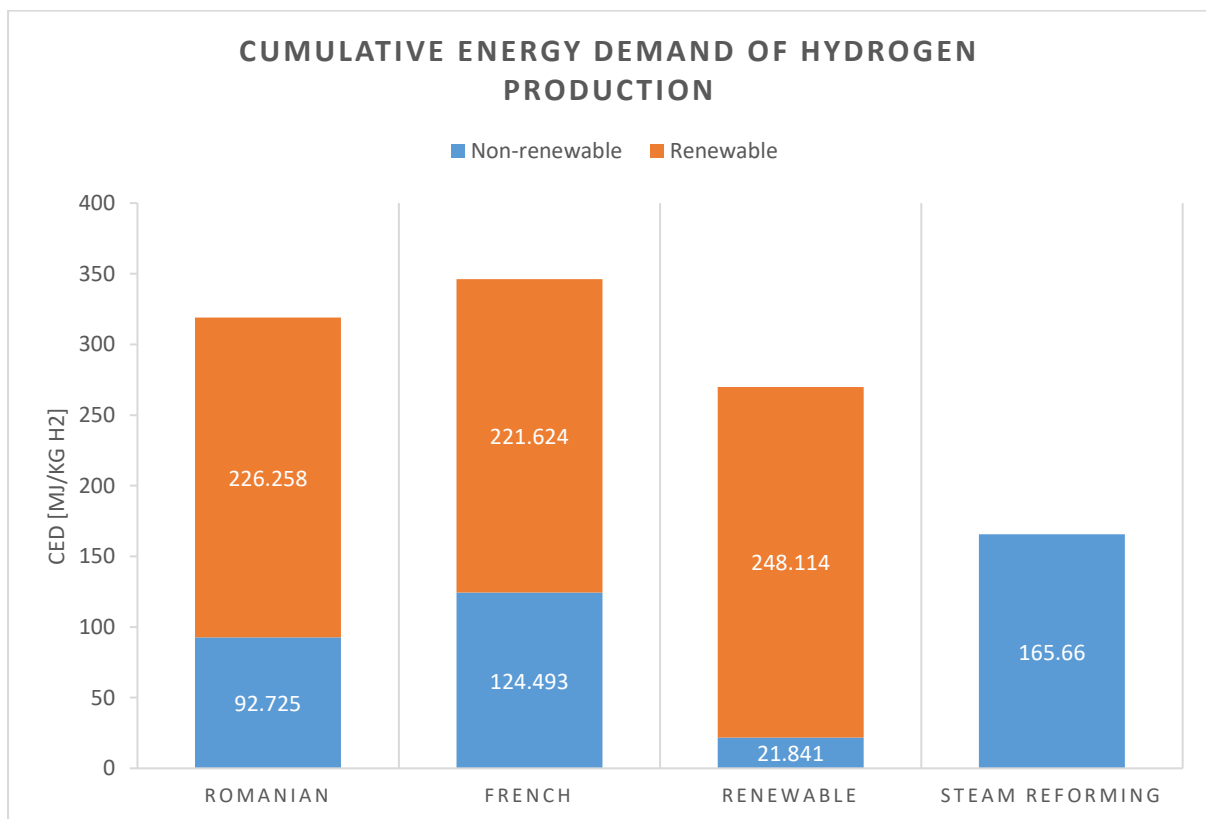

Figure 10.10 CED of hydrogen production scenarios

The French total CED indicator is higher than in the Romanian or renewable cases and the difference rests in the non-renewable, but not fossil, energy. The explanation for this finding consists in the fact that nuclear energy, which is dominant in the French energy mix (considered non-renewable, but not fossil) has a lower efficiency than the Romanian non-renewable energy (mostly gas and coal power plants that have the benefit of cogeneration) and this brings hydrogen production in the French case close the steam reforming in terms of CED.

10.4.2.2 Electricity production

In the case of electricity production, the total CED indicator for renewable hydrogen and SNG, as well as the one for Single and Double Power-to-Gas cycles, again has higher values compared to the reference scenario that consists in producing electricity from natural gas.

Table 10.28 CED of electricity production scenarios

Scenario	Functional unit	Energy mix/Reference	CED [MJ/kWh]		Total CED [MJ/kWh]
			Non-renewable/Fossil	Renewable	Total
Electricity from renewable hydrogen	1 kWh of electricity	Electricity from RE H2 RO	3.385 / 3.307	9.564	13.400
		Electricity from RE H2 FR	4.717 / 0.980	9.321	14.038
		Electricity from RE H2 RE	0.769 / 0.679	10.467	11.237
Electricity from SNG		Electricity from SNG RO	4.970 / 4.280	12.291	17.262
		Electricity from SNG FR	6.103 / 1.291	11.978	18.082
		Electricity from SNG RE	1.033 / 0.906	13.45	14.484
Electricity from natural gas		Electricity from NG	7.895 / 7.769	0	7.895
Single Power-to-Gas cycle (CO ₂ from power plant)		Single P2G cycle RO	7.714 / 7.268	7.908	15.622
		Single P2G cycle FR	8.443 / 5.345	7.707	16.150
		Single P2G cycle RE	5.181 / 5.097	8.654	13.835
Double Power-to-Gas cycle (CO ₂ from power plant)	Double P2G cycle RO	6.660 / 6.136	9.349	16.010	
	Double P2G cycle FR	7.522 / 3.862	9.111	16.634	
	Double P2G cycle RE	3.665 / 3.569	10.231	13.897	

Producing electricity from SNG has a higher total CED, as well as a higher fossil CED, compared to the case in which renewable hydrogen is used, caused by the additional infrastructure and transformation processes that lead to a loss of overall efficiency. However, in all studied scenarios, non-renewable CED is significantly lower compared to the reference electricity from natural gas scenario.

Single and Double Power-to-Gas cycle scenarios are similar in terms of total CED, but the Double Power-to-Gas cycle scenario has a lower equivalent non-renewable CED, suggesting that trapping the same quantity of CO₂ inside multiple cycles leads to a decrease in non-renewable resource consumption.

For significant reductions in the non-renewable CED consumption, the focus should be on producing electricity from renewable hydrogen or SNG, but only if the energy mix is renewable, otherwise the non-renewable CED is similar to the one recorded in the reference scenario of producing electricity from natural gas.

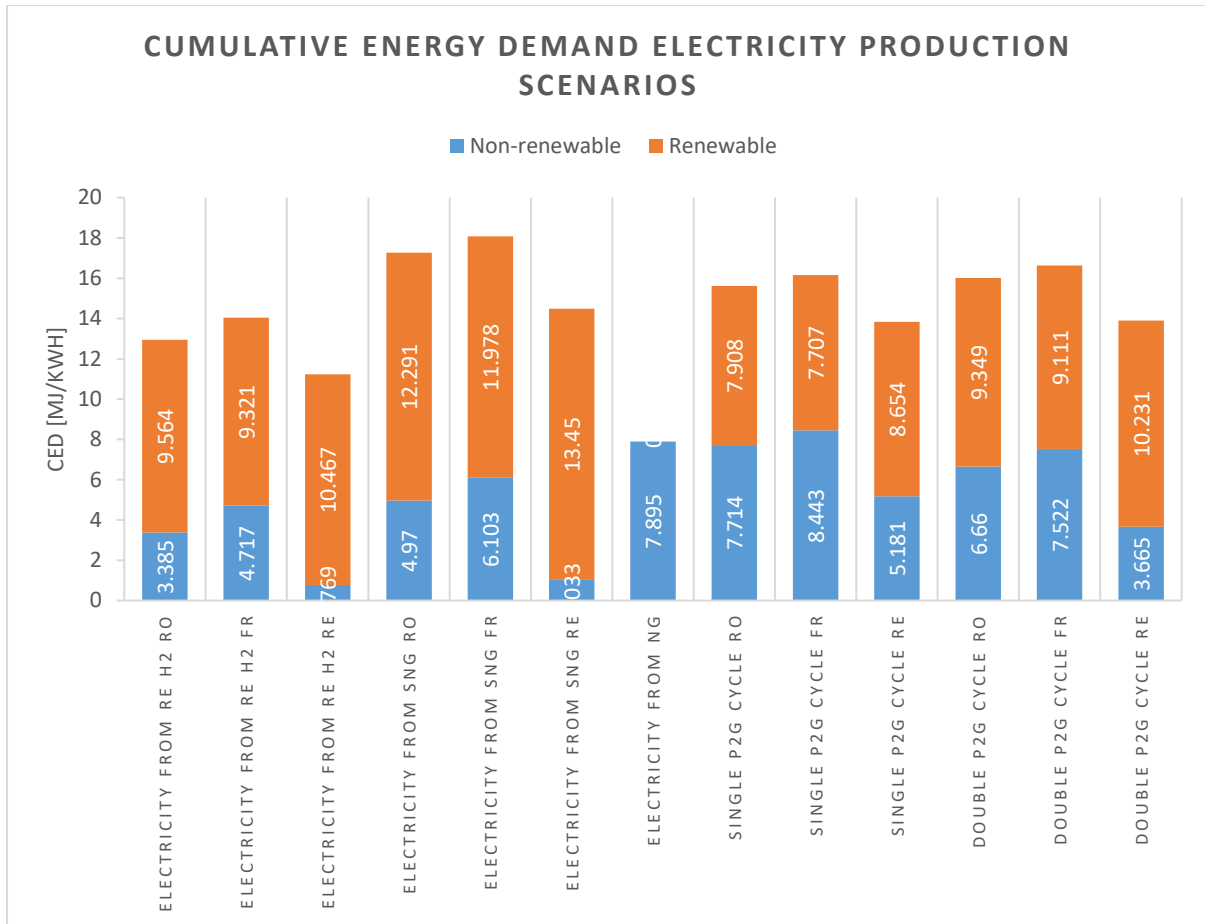

Figure 10.11 CED of electricity production scenarios

10.4.2.3 Heat production

In the case of heat production from SNG, the results are similar with the previously presented cases, having a higher total CED than the reference heat from natural gas scenario and an equivalent non-renewable CED, with the exception of the 100% renewable energy mix, which is the best-case scenario with a five-time reduction of the non-renewable CED compared to the reference case.

Table 10.29 CED of heat production scenarios

Scenario	Functiona l unit	Energy mix/Reference	CED [MJ/MJ]		Total CED [MJ/MJ]
			Non- renewable/Fossil	Renewable	Total
Heat from SNG	1 MJ of heat	Heat from SNG RO	0.873 / 0.740	2.014	2.888
		Heat from SNG FR	1.058 / 0.252	1.963	3.022
		Heat from SNG RE	0.230 / 0.189	2.204	2.434
Heat from natural gas		Heat from NG	1.215 / 1.200	0.004	1.22

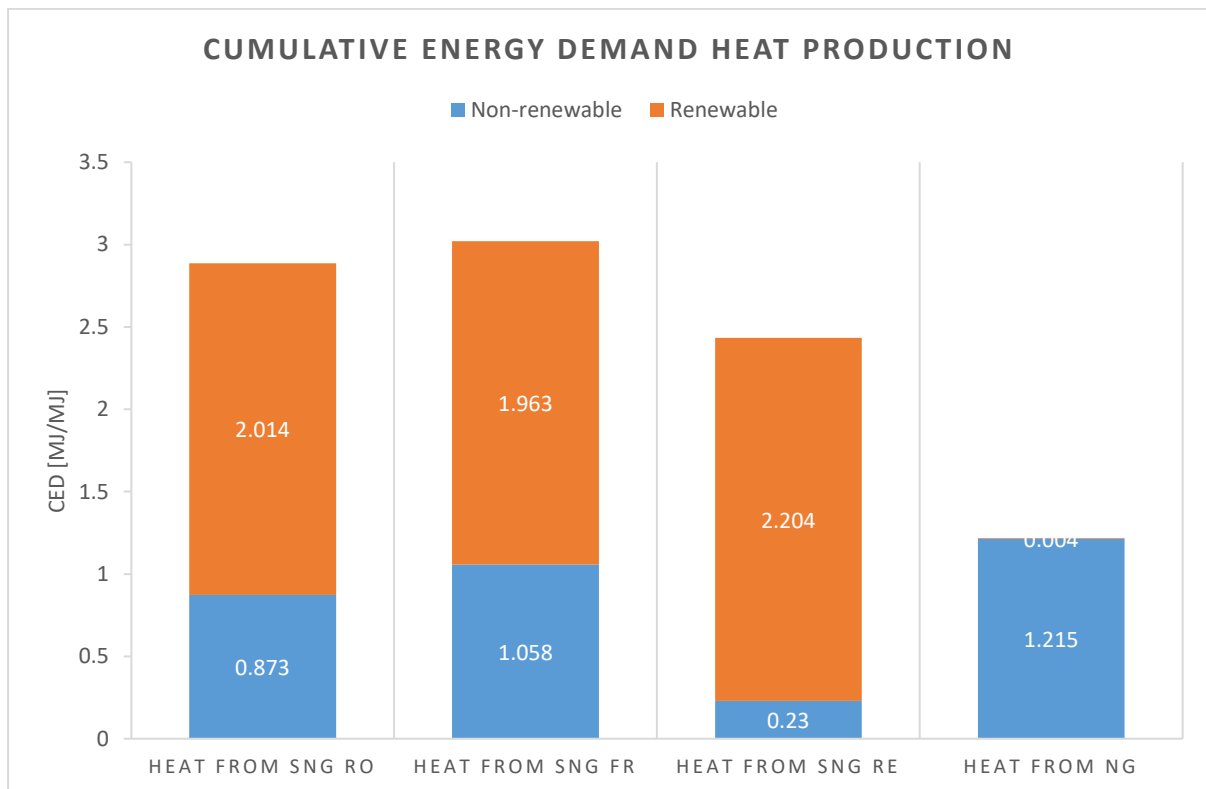

Figure 10.12 CED of heat production scenarios

10.5 DISCUSSION

Lacking foreground data that would have led to a more detailed life cycle assessment of specific Power-to-Gas cases, the objective of the study was to cover a broader range of applications developed around the technological concept. Inventories were generally assembled from

background data from literature, except the methanation stage, while process data was imported from the technical simulation performed in the previous chapters of the thesis.

One of the most interesting findings, that had an impact on the way the study was performed, was the significant influence of the electricity required for the hydrogen compression phase in the operation stage of hydrogen production, a process that is the core of all the scenarios taken into consideration. The initial assumption was that the compressor is fed with grid electricity and the overall GWP impact in the Romanian context was high due to the high-carbon content of the national energy mix (data was imported from the ecoinvent database which is outdated, the situation improved in the last years with an increasing share of renewables in the Romanian energy mix). Seeing this significant influence, the scenarios were also analyzed using a low-carbon energy mix (the French mix which relies mostly on nuclear energy), as well as in the perspective of using renewable energy for the compression stage. This led to having three different perspectives for every scenario, the variations in GWP impact highlighting the importance of the source of energy for the compression stage.

Looking at hydrogen production, it is clearly visible that renewable hydrogen has a lower GWP impact compared to the reference steam reforming scenario. The CED indicator also shows that it is a more favorable pathway to choose in terms of avoiding the use of non-renewable energy, especially in the scenario that uses 100% renewable energy.

Producing electricity from renewable hydrogen is more favorable than using SNG for the same purpose, both in terms of GWP emissions and cumulative energy demand. Hydrogen does not carry a CO₂ burden and requires less transformation processes before its final use, the hydrogen pathway proving to be the one to choose when considering environmental and resource depletion benefits.

When taking into account complete Power-to-Gas cycles that rely on fossil carbon captured from power plants, the results indicate that trapping carbon dioxide inside the loop multiple times results in GWP emission and fossil energy demand reductions, basically incentivizing multiple energetic use of the same quantity of CO₂ before finally emitting it. Compared to the reference electricity from natural gas scenario, both Single and Double Power-to-Gas cycle scenarios provide better results in terms of GWP impact and fossil cumulative energy demand (with the exception of the Single Power-to-Gas cycle using the Romanian mix).

In the case of Single and Double Power-to-Gas cycles that use fossil carbon dioxide captured from the cement industry, a big influence in the GWP and CED indicators comes from the

source of energy used in the carbon capture process. Integrating the waste heat of the SNG production stage with the carbon capture process in the cement industry has the potential to lead towards even lower impacts, but results depend on the allocation choices on CO₂ for cement production.

An interesting observation comes from the fact that the French total CED indicator is always higher than in the Romanian or renewable cases and the difference rests in the non-renewable, but not fossil, energy. The explanation for this finding consists in the fact that nuclear energy, which is dominant in the French energy mix (considered non-renewable, but not fossil) has a lower efficiency than the Romanian non-renewable energy (mostly gas and coal power plants that have the benefit of cogeneration).

The infrastructure and consumables required for the analyzed scenarios have little influence, their associated impact in GWP and CED indicators being low in comparison with the impact of the energy required in different processes.

Overall, it is interesting to observe that the various applications developed around the Power-to-Gas core are generally beneficial compared to their reference counterparts, both in terms of GWP emissions and non-renewable energy use. In the case where it would be possible, it would be useful either to reduce the need for hydrogen compression, or feed compressors with renewable electricity, especially in the case when producing on “surplus” electricity”, as this would lead to much higher benefits. The results can potentially represent the starting point in developing a support scheme that would incentivize the environmental benefits in order to encourage market deployment in spite of the current economic indicators.

11 CONCLUSIONS AND PERSPECTIVE

The aim of the PhD Thesis consisted in conducting a study that would analyze the three main aspects, technical, economic and environmental, of two Power-to-Gas technology pathways: Hydrogen and SNG, as well as the feasibility of deploying the concept in the current and future (2030) context of the Romanian and French energy systems. A background, but nonetheless essential objective also resided in developing a thorough understanding of the current state of the energy sector, its limitations and, as well as the changes that it faces and, more specifically, how Power-to-Gas as a key energy storage technology can play a role in the already ongoing transition towards a more sustainable, flexible and secure energy system.

11.1 MAIN FINDINGS

Romania's renewable energy potential and existent investments, especially in wind energy, are concentrated in a single part of the country, Dobrogea region. This aspect raises some serious issues related to the saturation of the electricity transport and distribution network. The infrastructure is old and was not designed and sized for handling such a massive amount of fluctuating renewable energy. In addition, wind farms produce a significant quantity of energy during off-peak hours, excess energy that cannot be efficiently used, leading to a massive loss of value. The current situation added to the already approved future investments in wind farms, has led renewable energy producers, energy transport and distribution companies, authorities and policy makers to start analyzing the possibility of deploying a new technical solution that would bring balance to the energy system. Leveraging Power-to-Gas in the current Romanian context has the potential of solving all the aforementioned issues. However, from an economic

point of view, the current Romanian energy context is not specifically favorable for Power-to-Gas. While there certainly is a significant quantity of cheap electric energy, a consequence of decreasing demand, new investments in renewable energy facilities that are prioritized on the merit order curves due to their very low marginal costs, the price of natural gas is among the lowest in the European Union (due to ensuring an important part of the consumption from the internal production) [Departamentul pentru Energie 2014] and the market has not been yet completely liberalized. It is also interesting to highlight that such an investment in the Romanian context would be subject to a discount rate of 10%, while a lower discount rate would allow better economic results.

The two-step approach used for the technical and economic evaluation proves to be an efficient analysis tool for an investor interested in sizing, operating and determining the feasibility of Power-to-Gas in a certain context. It focuses on economic indicators and provides a clear image on whether an investment of this type can be profitable over its lifetime and if contrary, the approach allows determining the necessary targets that need to be reached in order to have a positive business case with the use of sensitivity analysis. In case the point of view is shifted to a larger level, an entire energy system, the approach needs to be upgraded to consider elements that are at the moment difficult to be economically valued like security of supply, social acceptance of environmental impact and focus more on the energy storage and energy transport functions of Power-to-Gas, rather than on energy price arbitrage.

On account of the results of the technical and economic analysis of the 2015 Romanian case it is safe to acknowledge that in the described context, the most economically promising solution implies a low installed capacity alkaline electrolysis plant (10 MW in our case) and an energy price threshold set at a high value of 70 Euro/MWh, in both of the pathways taken into consideration as part of this article: Power-to-Gas Hydrogen and SNG. This result can be explained by the high initial capital investment costs of the components of the Power-to-Gas technology, especially electrolysis and methanation, and the fact that in order to amortize these costs on a per MWh basis, the production facilities need to operate for as long as possible, meaning that they need to be fed as much energy from renewable sources as possible.

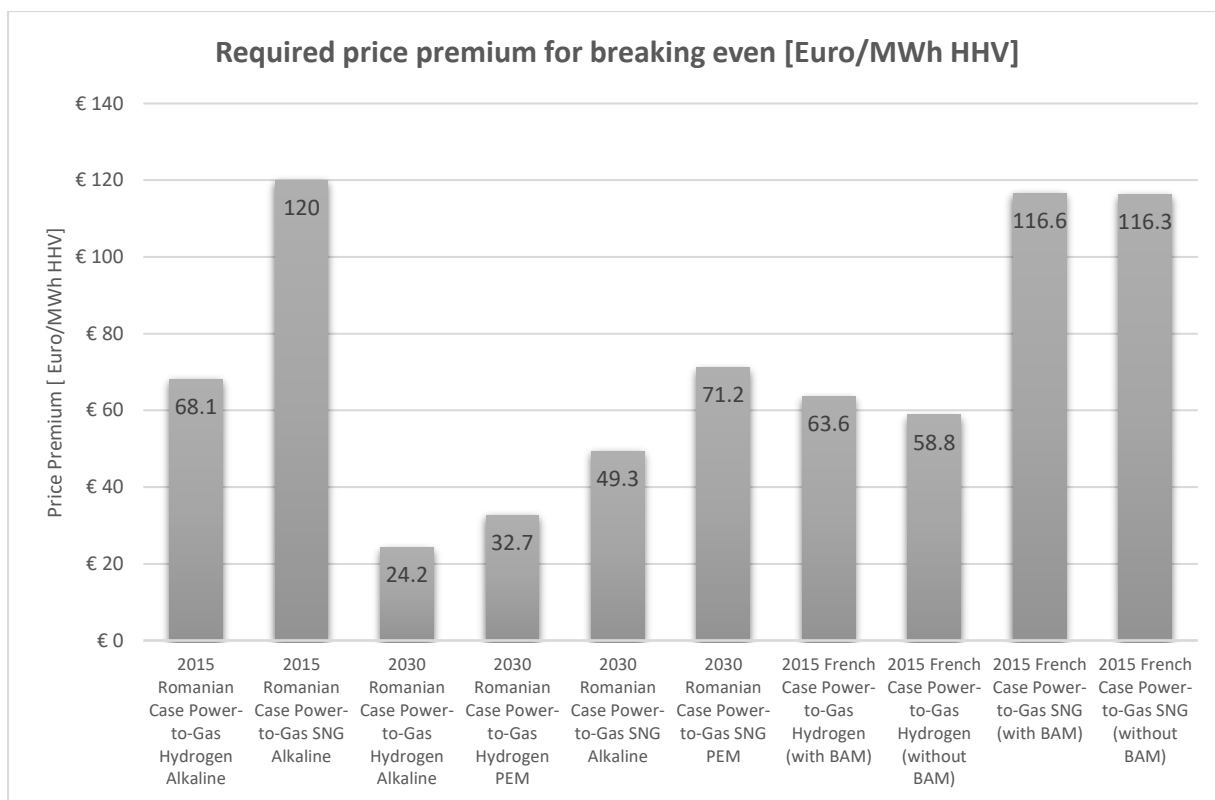

Figure 11.1 Summary of the required price premiums for reaching the breaking even point for all the analyzed scenarios

The business case analysis of the 2015 Romanian case indicates that economic feasibility cannot be reached without incentives and the break-even-point would be reached for price premiums of 68.1 Euro/MWh HHV of renewable hydrogen and 120 Euro/MWh HHV of SNG, for a discount rate of 10% and a project lifetime of 20 years.

The 2030 Romanian case scenario allows a different operating strategy for the same 10 MW electrolysis installed capacity, with a lower energy price threshold of 40 Euro/MWh for alkaline electrolysis and 50 Euro/MWh for PEM electrolysis, as technology costs are expected to drastically reduce. The DCF analysis points towards a reduction in required price premiums for breaking-even: 24.2 Euro/MWh HHV for alkaline electrolysis and 32.7 Euro/MWh HHV for PEM technology for the Power-to-Gas Hydrogen pathway and 49.3 and 71.2 Euro/MWh HHV for alkaline and respectively PEM electrolysis technology when using the Power-to-Gas SNG pathway. This indicates that PEM electrolysis will become a competitor to alkaline technology by 2030, but for the current revenue structure, without a high value market that would benefit from the better level of flexibility of PEM technology, alkaline technology will

continue to represent the solution of choice for the most economically feasible Power-to-Gas implementation, requiring the minimum price premium to reach a positive NPV.

Studying the possibility of using the balancing market as a high-value market for improving the economic feasibility of Power-to-Gas technologies indicates that in the 2015 French context a 4% improvement in the NPV (Net Present Value) indicator would be attained for the Power-to-Gas Hydrogen pathway. However, due to the limitations of the modeling methodology used in the Thesis, it is difficult to put value to the results related to required price premiums in this case.

The environmental analysis performed in the Thesis as a basic Life Cycle Assessment of a broader range of applications that include Power-to-Gas technologies generally indicates reductions in GWP emissions and non-renewable energy use when referring to the reference counterparts, but also highlights the importance of the source of energy, mainly in the hydrogen compression stage. Sitting at the core of the scenarios taken into consideration, renewable hydrogen production comes with a total GWP impact of 6.5 kgCO₂/kgH₂ when using the Romanian energy mix, 2.2 kgCO₂/kgH₂ for the French mix and 1.4 kgCO₂/kgH₂ for a 100% renewable energy mix, significantly lower than the reference hydrogen production scenario involving steam reforming that comes with a GWP impact of 11.8 kgCO₂/kgH₂. When the functional unit is changed to 1 kWh of electricity, producing it from renewable hydrogen in a 100% renewable energy mix has a GWP of 0.04 kgCO₂/kWh, while producing it from SNG in the same scenario has 0.17 kgCO₂/kWh, a significant reduction compared to the reference scenario in which electricity is produced in a natural gas power plant without carbon capture (0.499 kgCO₂/kWh). Studying electricity production in single and double Power-to-Gas scenarios, with various CO₂ sources, leads to the conclusion that offering multiple uses to the same quantity of carbon dioxide before finally releasing it has a certain environmental benefit in terms of GWP impact.

11.2 CONCLUDING STATEMENTS

Energy storage is one of the solutions answering the dilemmas of the energy transition period, having the potential of unlocking an increased share of renewables in the energy mix that will address issues like reducing greenhouse gas emissions, improving energy efficiency, a higher level of flexibility, as well as security in energy security of supply. Power-to-Gas represents a

complex chemical energy storage technology that creates a link between the electricity and the gas network using hydrogen or SNG as additional energy vectors, bringing value and flexibility to the energy system through functions like: energy transport and conversion, system services, as well as a potential environmental function in certain pathways in which captured CO₂ becomes a resource.

The results of the evaluation indicate that Power-to-Gas is not a financially viable investment at the moment without taking into consideration financial incentives, in the current Romanian or French context and given the technology costs that were considered. However, the latest reports [FCH-JU 2015] point towards drastic reductions in CAPEX costs for electrolysis earlier than it was previously expected and the potential of more efficient electrolysis technologies such as high temperature electrolysis leading to more favorable business cases. In addition, the analysis has revealed that high value markets need to be identified for renewable hydrogen and renewable methane in order to reduce the project's feasibility dependency on significant regulation-based price premiums.

In the current context, Power-to-Gas is not economically feasible without support schemes, not even in the conservative scenarios taken into consideration in this article that included co-localization of all the stages of the process (therefore minimum resource transport costs) and zero costs for CO₂. Consequently, the feasibility of a business case surrounding Power-to-Gas is strongly dependent on support policy measures that would create the legal framework of awarding price premiums for renewable hydrogen and renewable methane, which are not currently treated as biogas in the existing Romanian legislation. We can speculate that if the definition of biogas from the current legal framework would extend over renewable hydrogen and methane, then the Power-to-Gas Hydrogen pathway would become profitable, with two (or three in the case of highly-efficient CHP plants) green certificates being awarded for each MWh, generally priced between 30 and 35 Euro/green certificate. The transport sector can potentially represent a high value market for Power-to-Gas fuels, as there are two directives of the European Commission, the Renewable Energy Directive (RED) [European Commission 2009a], stating that renewable energy should hold a 10% share in transport by 2020 and the Fuel Quality Directive (FQD) [European Commission 2009b] that mentions a 6% reduction in GHG intensity in road transport by the same year. Interestingly, double counting of these two directives along with the ILUC amendment [European Parliament 2015] indicates that 0.5% of total fuels should be advanced renewable fuels, that can come from different pathways of the

Power-to-Gas technology as soon as they will be considered eligible from a legal point of view [Hinicio & LBST 2016].

At the moment, the legislation regarding energy storage, including Power-to-Gas, is in the early stages of development at European level and the lack of a regulatory environment limits the deployment of storage technologies for the time being. However, this is expected to change on medium and long term as the new targets in emission reduction will not be achievable by solely deploying grid expansion measures (which at the moment could represent the cheaper alternative to energy storage, but without offering the same functions).

A comparison of the results obtained for the Power-to-Gas SNG pathway with the ones summarized in a recent study [Götz et al. 2016] puts the current work in line with similar evaluations. Our study indicates a cost of 132 Euro/MWh SNG, with oxygen and residual heat utilization, while [Vandewalle et al. 2015] obtains a cost between 100 and 160 Euro/MWh SNG, [ADEME 2014] between 165 and 392 Euro/MWh SNG, for different energy markets, but similar cost assumptions. A study that investigates a similar operating strategy with the current work (high capacity factor for the methanation reactor), almost identical prices for electricity and heat (50 Euro/MWh of electricity and 40 Euro/MWh thermal energy), but a higher oxygen price (0.07 Euro/m³ compared to 0.03 Euro/m³) [Graf et al. 2014] indicates a lower cost of approximately 100 Euro/MWh SNG, still too high compared to the current price of natural gas situated between 20 and 30 Euro/MWh.

Adding the environmental layer to the T&E study of the Romanian case leads towards an interesting contradiction. In order to make the Power-to-Gas unit profitable in the current economic conditions (CAPEX and OPEX costs, electricity and natural gas prices), the capacity factor of the electrolysis unit is situated just under 71%, meaning that not all the used renewable energy can be considered surplus energy. Part of this renewable energy can be used directly as electricity, thus avoiding the situation in which fossil generation (with a more important environmental burden) is used to supplement the wind energy fed to the Power-to-Gas unit. Therefore, from an economic and environmental perspective, the technology development goals should be focused in lower technology costs that would allow reaching economic profitability with a lower capacity factor, feeding the electrolysis units with surplus energy (energy that should not be compensated by fossil generation) as much as possible. This can be achievable mainly through further efforts from the R&D sector, as well as an increased market

adoption that would help boost production figures and bring down procurement costs, and one method of initiating the process consists in putting in place support schemes.

11.3 LIMITATIONS OF THE WORK

Being a Thesis supported by ENGIE (former GDF Suez Energy Romania) granted extremely valuable access to confidential data regarding the energy production of the wind park, as well as insight on the company's perspective on certain aspects regarding renewable energy and energy storage, but also brought one of the main limitations of the technical and economic study that was performed from an investor's point of view using specific energy production data for a small to medium scale project, instead of having a broader, holistic overview on the opportunities for Power-to-Gas.

Considerations regarding policy support for renewable energy (the Romanian renewable energy quota), co-localization of processes and resources and considerations regarding the origin and cost of carbon dioxide, as well as deciding on energy price arbitrage as the main revenue stream for Power-to-Gas technologies, represent important limitations of the used methodology that must be underlined in order to understand the exact value of the Thesis.

Using multiple tools and software, each with its own features, for specific parts of the technical and economic as well as the environmental study can also be considered as part of the limitations of the work, as sometimes this created the need of indirect modeling or excluding certain factors which might have had low individual impact, but if added up, would have influenced the overall absolute values, without changing the observed trends or conclusions.

The origin of data represents another significant limitation of the work performed as bibliographic sources were used for most technical and economic parameters of the modelling, since the industry is reluctant to offer information for this type of studies. The environmental evaluation relied almost entirely on background data that had to be harmonized from various and sometimes inconsistent sources, leading to an approach focusing on covering a broader range of applications that would allow drawing some conclusions based on trends and tendencies instead of a single, more in-depth study that would have put accent on absolute values.

Last, but not least, one aspect that can be classified as a limitation consists in the sometimes inconsistent communication with the large number of stakeholders involved in the Thesis: ENGIE, CEA Liten, the Romanian and French doctoral schools and ICSI Rm. Valcea, which led to an overall perspective on Power-to-Gas derived from analyzing and putting together multiple points of view on the subject passed through a personal filter, instead of a unitary vision that would have been difficult to achieve considering the various domains, backgrounds and interests.

11.4 FUTURE WORK AND PERSPECTIVE

At the moment, Power-to-Gas is a technically feasible technology that can reach economic feasibility only in certain niche applications, where high value markets can be identified and accessed. Like most of the available energy storage technologies, Power-to-Gas needs a legal framework, developed at European and national level, that would create the necessary context for large-scale deployment in the energy, as well as in the mobility sector, unlocking further development of the technology.

Besides monetizing the outputs of the Power-to-Gas process on high value markets, establishing a strategy in which it can provide services to the energy system in terms of capacity and frequency control will also open new opportunities for this technology and will be investigated as part of future work, as system services seem to be a more promising revenue stream for Power-to-Gas than energy price arbitrage.

At the end of 2015, at the COP 21 summit in Paris more than 200 countries established a binding agreement of keeping global warming below 2 °C, creating a window of opportunity not only for carbon-free technologies, but also for development of technologies built around carbon capture, re-use and storage and Power-to-Gas has the potential of being one of the key concepts in bridging the gap between reality and very ambitious targets.

Personally, being involved with Power-to-Gas since the end of 2012 and starting to grow a deeper understanding of the technology throughout the development of the Thesis granted me an invitation to take part in International Energy Agency Hydrogen Implementing Agreement's new Task 38, dedicated specifically to Power-to-Hydrogen and Hydrogen-to-X: System Analysis of the techno-economic, legal and regulatory conditions". The activities of the task

are planned to extend until 2019, with the goal of “developing hydrogen visibility as a key energy carrier for a sustainable and smart energy system, within a 2 or 3 horizon time frame: 2020, 2030 and 2050”, ensuring the ideal context for continuing work on Power-to-Gas.

12 BIBLIOGRAPHY

- ADAM, 1980. ADAM I. *Chem.-Ing.-Tech.* 52, (6), pp.504–515.
- ADEME, 2014. *Etude portant sur l'hydrogène et la méthanation comme procédé de valorisation de l' électricité excédentaire*, ADEME, GRTgaz, GrDF.
- Agerborg, J. & Lingeheg, E., 2013. *Integration of Power-to-Gas in Gasendal and GoBiGas*. Available at: <http://publications.lib.chalmers.se/records/fulltext/182610/182610.pdf>.
- Agora, 2014. *Electricity Storage in the German Energy Transition Electricity Storage in the German Energy Transition*, Berlin.
- Alain Bengaouer, 2015. Communication with Alain Bengaouer on physically sizing a methanation reactor.
- ANRE, 2015. Regulatory Authority for Energy. Available at: <http://www.anre.ro/>.
- Aspen Technology, 2010. Aspen Physical Property System: Physical Property Methods. , pp.1–234.
- Bader, A. et al., 2011. Modelling of a Chemical Reactor for Simulation of a Methanisation Plant. , pp.572–578. Available at: http://www.ep.liu.se/ecp_article/index.en.aspx?issue=63;article=64.
- Ball, M. & Wietschel, M., 2009. *The Hydrogen Economy: Opportunities and Challenges*, Cambridge University Press.
- Bauer, C. et al., 2008. *NEEDS Project Deliverable n ° 7 . 2 - RS 1a. Final report on technical data , costs , and life cycle inventories of advanced fossil power generation systems*,
- Beccali, M. et al., 2013. Method for size optimisation of large wind–hydrogen systems with high penetration on power grids. *Applied Energy*, 102, pp.534–544. Available at: <http://linkinghub.elsevier.com/retrieve/pii/S0306261912006113>.
- Bertuccioli, L. et al., 2014. *Study on development of water electrolysis in the EU*, FCH-JU, Available at: http://www.fch-ju.eu/sites/default/files/study_electrolyser_0-Logos_0.pdf.
- Brooks, K.P. et al., 2007. Methanation of carbon dioxide by hydrogen reduction using the Sabatier process in microchannel reactors. *Chemical Engineering Science*, 62(4), pp.1161–1170. Available at: <http://linkinghub.elsevier.com/retrieve/pii/S0009250906007214>.
- Brunot, A., 2015. Communication with Aymeric Brunot on applying scaling factors in LCA studies.
- Cetinkaya, E., Dincer, I. & Naterer, G.F., 2012. Life cycle assessment of various hydrogen production methods. *International Journal of Hydrogen Energy*, 37(3), pp.2071–2080. Available at: <http://dx.doi.org/10.1016/j.ijhydene.2011.10.064>.
- Damodaran, A., Basics of Discounted Cash Flow Valuation. , pp.1–11. Available at: <http://people.stern.nyu.edu/adamodar/pdfiles/basics.pdf> [Accessed December 1, 2013].
- Deloitte, 2015. *European energy market reform Country profile : France Contents*, Zurich. Available at: <https://www2.deloitte.com/content/dam/Deloitte/global/Documents/Energy-and-Resources/gx-er-market-reform-france.pdf>.
- Departamentul pentru Energie, 2014. *Strategia Energetica a Romaniei,draft*. Available at: <http://energie.gov.ro/>
- DNV KEMA Energy & Sustainability, 2013. *Final Report: Systems Analyses Power to Gas*, part of Part of TKI

- project TKIG01038 , pp.1–70, Groningen.
- Doka, G., 2007. *Critical Review of "Life Cycle Assessment of Selected Technologies for CO2 Transport and Sequestration" Diploma Thesis No. 2007MS05 by C.Wildbolz, DOKA LCA Zurich.*
- Dysert, L., 2005. So you think you're an estimator? In *2005 AACE International Transactions*. pp. 1–6. Available at: <http://eprints.gla.ac.uk/50729/>.
- Eco2Mix, 2015. French Energy Mix. RTE. Available at: <http://www.rte-france.com/en/eco2mix/eco2mix-mix-energetique-en> [Accessed May 1, 2015].
- ecoinvent, ecoinvent version 2 database. Available at: <http://www.ecoinvent.org/database/ecoinvent-version-2/ecoinvent-version-2.html> [Accessed June 1, 2015].
- EIA, 2013. *EIA/ARI World Shale Gas and Shale Oil Resource Assessment*, Available at: http://www.adv-res.com/pdf/A_EIA_ARI_2013_World_Shale_Gas_and_Shale_Oil_Resource_Assessment.pdf.
- Electrochemistry Encyclopedia, 2011. PROTON EXCHANGE MEMBRANE or POLYMER ELECTROLYTE MEMBRANE (PEM) FUEL CELLS. Available at: <http://knowledge.electrochem.org/encycl/art-f04-fuel-cells-pem.htm> [Accessed March 1, 2013].
- EU ETS, 2015. The EU Emissions Trading System (EU ETS). Available at: http://ec.europa.eu/clima/policies/ets/index_en.htm.
- Eurelectric, 2011. Flexible generation: Backing up renewables. , p.52. Available at: http://www.eurelectric.org/media/61388/flexibility_report_final-2011-102-0003-01-e.pdf.
- European Climate Foundation, 2010. Roadmap 2050. *Policy*, Volume 1-(April), pp.1–9. Available at: <http://www.roadmap2050.eu/>.
- European Commission, 2009a. Directive 2009/28/EC of the European Parliament and of the Council of 23 April 2009 on the promotion of the use of energy from renewable sources.
- European Commission, 2009b. Directive 2009/30/EC of the European Parliament and of the Council of 23 April 2009.
- European Commission, 2010. *Energy 2020. A strategy for competitive, sustainable and secure energy.*
- European Commission, 2014. *EU Energy in Figures Statistical Pocketbook.*
- European Commission -- Joint Research Centre -- Institute for Environment and Sustainability, 2010. *International Reference Life Cycle Data System (ILCD) Handbook -- General guide for Life Cycle Assessment -- Detailed guidance.*
- European Commission DG ENER, 2013. *EU Energy, Transport and GHG Emissions Trends to 2050.*
- European Council, 2014. *Conclusions on 2030 Climate and Energy Policy Framework*, Brussels.
- European Parliament, 2015. Directive (EU) 2015/1513 of the European Parliament and of the Council of 9 September 2015 amending Directive 98/70/EC relating to the quality of petrol and diesel fuels and amending Directive 2009/28/EC on the promotion of the use of energy from renewables.
- EWEA, 2014. *Wind in Power: 2013 European Statistics, technical report.*
- Faulstich, M. et al., 2011. Pathways towards a 100 % renewable electricity system. , (January), pp.1–26. Available at: http://www.umweltrat.de/SharedDocs/Downloads/EN/02_Special_Reports/2011_01_Pathways_Chapter10_ProvisionalTranslation.pdf?__blob=publicationFile.
- FCH-JU, 2015. *Commercialisation of energy storage in Europe*, final report.
- Formulas, F., Net Present Value. Available at: http://www.financeformulas.net/Net_Present_Value.html [Accessed January 1, 2014].
- Fraunhofer Institute for Solar Energy Systems, 2015. *The role of power-to-gas in achieving germany's climate policy targets with a special focus on concepts for road based mobility*, Freiburg.
- Gahleitner, G., 2013. Hydrogen from renewable electricity: An international review of power-to-gas pilot plants for stationary applications. *International Journal of Hydrogen Energy*, 38(5), pp.2039–2061. Available at:

<http://dx.doi.org/10.1016/j.ijhydene.2012.12.010>.

- GDF Suez Energy Romania, 2015. Communication with GDF Suez Energy Romania.
- GDF Suez Energy Romania, 2013a. Communication with GDF Suez Energy Romania.
- GDF Suez Energy Romania, 2013b. Natural Gas Prices in Romania. Available at: <https://www.gdfsuez.ro/> [Accessed November 1, 2013].
- GDRC, Defining Life Cycle Assessment, available at: <http://www.gdrc.org/uem/lca/lca-define.html>.
- Görling, M.B., 2012. *Energy system evaluation of thermo-chemical biofuel production Process development by integration of power cycles and sustainable electricity*. KTH Royal Institute of Technology.
- Göttlicher, G., 2004. *The Energetics of Carbon Dioxide Capture in Power Plants*, United States Department of Energy, NETL.
- Götz, M. et al., 2016. Renewable Power-to-Gas: A technological and economic review. *Renewable Energy*, 85, pp.1371–1390.
- Graf, F. et al., 2014. Technoökonomische Studie von Power-to-Gas-Konzepten Teilprojekte B-D Abschlussbericht. Available at: http://www.dvgw-innovation.de/fileadmin/dvgw/angebote/forschung/innovation/pdf/g3_01_12_tp_b_d.pdf.
- Guinot, B. et al., 2013. Economic impact of performances degradation on the competitiveness of energy storage technologies – Part 1: Introduction to the simulation-optimization platform ODYSSEY and elements of validation on a PV-hydrogen hybrid system. *International Journal of Hydrogen Energy*, 38(35), pp.15219–15232. Available at: <http://www.sciencedirect.com/science/article/pii/S0360319913021356> [Accessed September 4, 2015].
- Guinot, B. et al., 2015. Profitability of an electrolysis based hydrogen production plant providing grid balancing services. *International Journal of Hydrogen Energy*, 0. Available at: <http://linkinghub.elsevier.com/retrieve/pii/S0360319915011775>.
- Haeseldonckx, D. & Dhaeseleer, W., 2007. The use of the natural-gas pipeline infrastructure for hydrogen transport in a changing market structure. *International Journal of Hydrogen Energy*, 32(10–11), pp.1381–1386. Available at: <http://www.sciencedirect.com/science/article/pii/S0360319906004940> [Accessed September 24, 2015].
- Haldor Topsoe, 2011. From Coal To Clean Energy, Nitrogen+Syngas 310.
- Hassan, S.M.N., 2005. *Techno-Economic Study of CO2 Capture Process for Cement Plants*. University of Waterloo, Canada.
- Hinicio & LBST, 2016. *Power-to-Gas: Short term and long term opportunities to leverage synergies between the electricity and transport sectors through power-to-hydrogen*, Brussels/Munich. Available at: http://www.lbst.de/download/2016/Hinicio-LBST_2016_PtH2-study_Fondation-Tuck.pdf.
- Hoenig, V., Hoppe, H. & Emberger, B., 2007. Carbon Capture Technology - Options and Potentials for the Cement Industry. *European Cement Research Academy, Tannenstrasse*, (3022), p.96. Available at: [http://stuff.mit.edu/afs/athena/dept/cron/project/concrete-sustainability-hub/Literature Review/Building Energy/Concerte Industry Reports/PCA CD Cement Research Library 2008/reports/SN3022.pdf](http://stuff.mit.edu/afs/athena/dept/cron/project/concrete-sustainability-hub/Literature%20Review/Building%20Energy/Concerte%20Industry%20Reports/PCA%20CD%20Cement%20Research%20Library%202008/reports/SN3022.pdf).
- Hydrogenious, 2015. THE BREAKTHROUGH OF GLOBAL ENERGY STORAGE. Available at: <http://www.hydrogenious.net/en/energy-storage/>.
- HyUnder, 2013. HyUnder Project Deliverable 1. Available online at: www.hyunder.eu
- Intergovernmental Panel on Climate Change, 2011. *IPCC Special Report on Carbon Dioxide Capture and Storage* B. Metz et al., eds., New York: Cambridge University Press.
- International Energy Agency, 2008. *CO2 Capture in the cement industry*, technical study, IEA Greenhouse Gas R&D Programme
- Investopedia, IRR Calculation. Available at: <http://www.investopedia.com/ask/answers/022615/what-formula-calculating-internal-rate-return-irr-excel.asp> [Accessed January 1, 2014].
- Investopedia, Discounted Cash Flow - DCF. Available at: <http://www.investopedia.com/terms/d/dcf.asp>

[Accessed December 1, 2013].

- Jentsch, M., Trost, T. & Sterner, M., 2011. Evaluation of power-to-gas as long-term storage concept regarding electricity and CO₂ sources. *6th International Renewable Energy Storage Conference (IRES 2011)*.
- Jentsch, M., Trost, T. & Sterner, M., 2014. Optimal use of Power-to-Gas energy storage systems in an 85% renewable energy scenario. *Energy Procedia*, 46, pp.254–261. Available at: <http://dx.doi.org/10.1016/j.egypro.2014.01.180>.
- Karelovic, A. & Ruiz, P., 2013. Mechanistic study of low temperature CO₂ methanation over Rh/TiO₂ catalysts. *Journal of Catalysis*, 301, pp.141–153. Available at: <http://dx.doi.org/10.1016/j.jcat.2013.02.009>.
- Khorsand, K. et al., 2007. Modeling and Simulation of Methanation Catalytic Reactor in Ammonia Unit. *Petroleum & Coal*, 49(1), pp.46–53.
- Kopyscinski, J., 2010. *Production of synthetic natural gas in a fluidized bed reactor*. Paul Scherrer Institut, ETH Zurich.
- Kopyscinski, J., Schildhauer, T.J. & Biollaz, S.M.A., 2010. Production of synthetic natural gas (SNG) from coal and dry biomass – A technology review from 1950 to 2009. *Fuel*, 89(8), pp.1763–1783. Available at: <http://linkinghub.elsevier.com/retrieve/pii/S0016236110000359>.
- Kost, C. et al., 2013. *Levelized Cost of Electricity Renewable Energy Technologies*, Fraunhofer ISE, Freiburg.
- Lefebvre, J. et al., 2015. Improvement of three-phase methanation reactor performance for steady-state and transient operation. *Fuel Processing Technology*, 132, pp.83–90. Available at: <http://www.sciencedirect.com/science/article/pii/S0378382014004640>.
- Lehner, M. et al., 2014. *Power-to-Gas: Technology and Business Models*, Springer, Linz.
- Maatman, R., 1980. A kinetic study of the methanation of CO₂ over nickel-alumina. *Journal of Catalysis*, 62(2), pp.349–356. Available at: <http://www.sciencedirect.com/science/article/pii/0021951780904637>.
- Melaina, M.W., Antonia, O. & Penev, M., 2013. *Blending Hydrogen into Natural Gas Pipeline Networks: A Review of Key Issues*. Technical report, NREL, United States Department of Energy.
- National Grid and Atlantic Hydrogen Inc. for Gas Industry Executives, 2009. HENG - Bridge to an ultra-low carbon world, draft.
- NEEDS, 2008a. *Generation, of the energy carrier HYDROGEN in context with electricity buffering generation through fuel cells Deliverable n° 8-5 RS1a Life cycle approaches to assess emerging energy technologies*, Available at: <http://www.needs-project.org/RS1a/RS1a D8.2 Final report on hydrogen.pdf>.
- NEEDS, 2008b. *Generation, of the energy carrier HYDROGEN in context with electricity buffering generation through fuel cells Deliverable n° 8-5 RS1a Life cycle approaches to assess emerging energy technologies*, Available at: <http://www.needs-project.org>.
- Nicholas P. Lavery, David J. Jarvis, Stephen G. R. Brown, Nicholas J. Adkins, B.P.W., 2013. Life cycle assessment of sponge nickel produced by gas atomisation for use in industrial hydrogenation catalysis applications. *The International Journal of Life Cycle Assessment*, 18(2), pp.362–376.
- Omniasig, 2014. Communication with Omniasig.
- OPCOM, Romanian Gas and Electricity Market Operator. Available at: <http://www.opcom.ro/pp/home.php?lang=en> [Accessed January 15, 2014].
- Peduzzi, E., 2014. *Biomass To Liquids Thermo-Economic Analysis and Multi-Objective Optimisation*. EPFL Lausanne.
- Petipas, F., 2013. *Conception et conduite de systemes d'electrolyse a haute temperature alimentes par des energies renouvelables*. Ecole Nationale Superieure des Mines de Paris.
- Polman, E.A., Addition of hydrogen to natural gas , pp.1–18. Gastec Technology BV.
- RADET, 2013. Thermal Energy Price Romania. Available at: http://www.radet.ro/clienti_tarif.php [Accessed November 14, 2013].
- Reiter, G. & Lindorfer, J. *Int J Life Cycle Assess* (2015) 20: 477. doi:10.1007/s11367-015-0848-0

- RES-Legal, 2014. Romanian Quota System. Available at: <http://www.res-legal.eu/search-by-country/romania/single/s/res-e/t/promotion/aid/quota-system-4/lastp/183/> [Accessed April 20, 2014].
- Romanian Parliament, *Energy and Gas Law No. 123/2012*, Available at: <http://www.monitoruljuridic.ro/act/lege-nr-123-din-10-iulie-2012-energiei-electrice-si-a-gazelor-naturale-emitent-parlamentul-publicat-139677.html>.
- RTE, 2010. Balancing Mechanism. , (May). Available at: https://clients.rte-france.com/htm/an/mediatheque/telecharge/balancing_mechanism.pdf.
- RTE, 2014. System Services Rules. , (January), pp.1–149. Available at: <https://clients.rte-france.com/>
- Santos, D., Sequeira, C. & Figueiredo, J., 2013. Hydrogen production by alkaline water electrolysis. *Química Nova*, 36, pp.1176–1193. Available at: http://www.scielo.br/scielo.php?script=sci_arttext&pid=S0100-40422013000800017&nrm=iso.
- SBC Energy Institute, 2014. *Hydrogen-Based Energy Conversion*, factbook, Schlumberger. Available at: <http://www.sbc.slb.com/SBCInstitute.aspx>
- Schlereth, D. & Hinrichsen, O., 2014. A fixed-bed reactor modeling study on the methanation of CO₂. *Chemical Engineering Research and Design*, 92(4), pp.702–712. Available at: <http://linkinghub.elsevier.com/retrieve/pii/S0263876213005054>.
- Spath, P.L. & Mann, M.K., 2000. *Life Cycle Assessment of a Natural Gas Combined-Cycle Power Generation System*, Colorado.
- AK STEEL, 2007. *304 304L Stainless Steel*, Product Data Sheet West Chester.
- Sterner, M., 2009. *Bioenergy and renewable power methane in integrated 100% renewable energy systems. Limiting global warming by transforming energy systems*, PhD Thesis, University of Kassel. Available at: <http://www.upress.uni-kassel.de/katalog/abstract.php?978-3-89958-798-2>.
- stoRE project, 2012. *Facilitating energy storage to allow high penetration of intermittent renewable energy Report summarizing the current Status , Role and Costs of Energy Storage Technologies*, Available at: http://www.store-project.eu/documents/results/en_GB/report-summarizing-the-current-status-role-and-costs-of-energy-storage-technologies.
- Sudiro, M. et al., 2010. Simulation of a structured catalytic reactor for exothermic methanation reactions producing synthetic natural gas. *Computer Aided Chemical Engineering*, 28, pp.691–696.
- Tabkhi, F. et al., 2008. A mathematical framework for modelling and evaluating natural gas pipeline networks under hydrogen injection. *International Journal of Hydrogen Energy*, 33(21), pp.6222–6231. Available at: <http://dx.doi.org/10.1016/j.ijhydene.2008.07.103>.
- The International Standards Organisation, 2006. Environmental management — Life cycle assessment — Principles and framework. *ISO 14040*, 2006, pp.1–28.
- Haldor Topsoe, 2009. *From solid fuels to substitute natural gas (SNG) using TREMP*, technical report. Available at: [http://scholar.google.com/scholar?hl=en&btnG=Search&q=intitle:From+solid+fuels+to+substitute+natural+gas+\(SNG\)+using+TREMPTM#4](http://scholar.google.com/scholar?hl=en&btnG=Search&q=intitle:From+solid+fuels+to+substitute+natural+gas+(SNG)+using+TREMPTM#4).
- U. Zuberbühler, M. Specht, A. Brinner, F. Baumgart. B. Stürmer, B.F., 2015. POWER-TO-GAS – TECHNICAL PROGRESS AND PERSPECTIVES. In *9th IRES: International Renewable Energy Storage Conference*. Dusseldorf.
- UN Industrial Development Association, 2010. *Carbon Capture Applications: and Storage in Industrial Technology*, Technology Synthesis Report
- University of Denmark, 2008. *Preinvestigation of Water Electrolysis, PSO-F&U 2006-1-6287, Department of Chemistry, part of project 6286 "Pre-investigation of Electrolysis", funded by the Danish Public Service Obligation programme*.
- Vandewalle, J., Bruninx, K. & D'haeseleer, W., 2015. Effects of large-scale power to gas conversion on the power, gas and carbon sectors and their interactions. *Energy Conversion and Management*, 94, pp.28–39.
- Volkart, K., Bauer, C. & Boulet, C., 2013. Life cycle assessment of carbon capture and storage in power generation and industry in Europe. *International Journal of Greenhouse Gas Control*, 16, pp.91–106. Available at:

<http://dx.doi.org/10.1016/j.ijggc.2013.03.003>.

Weatherbee, G.D. & Bartholomew, C.H., 1982. Hydrogenation of CO₂ on Group VIII Metals. *Journal of Catalysis*, 77, pp.460–472.

Wildbolz, C., 2007. *Life Cycle Assessment of Selected Technologies for CO₂ Transport and Sequestration*. Swiss Federal Institute of Technology Zurich.

World Energy Council, 2014a. *2014 Energy Trilemma Index Benchmarking the sustainability of national energy systems*, Available at: <https://www.worldenergy.org/wp-content/uploads/2014/11/20141105-Index-report.pdf>.

World Energy Council, 2014b. *World Energy Trilemma Time to get real – the myths and realities of financing energy systems*, London.

Xu, J. & Froment, G.F., 1989. Methane steam reforming, methanation and water-gas shift: I. Intrinsic kinetics. *AIChE Journal*, 35(1), pp.88–96. Available at: <http://dx.doi.org/10.1002/aic.690350109>.

Zuberbühler, U., 2013. Power-to-Gas: experience with demo and pilot plants, up to 99% methane, IRES: International Renewable Energy Storage Conference, Dusseldorf.

Résumé

1. INTRODUCTION

Le contexte général et l'objectif du travail a été antérieurement décrit par ENGIE Roumanie, en tant que financiers de la Thèse, opérateurs du réseau de distribution des gaz naturels et propriétaires d'un parc éolien de 50 MW dans la région de Dobrogea: l'investigation du stockage de l'énergie renouvelable sous la forme de méthane, par l'emploi d'une technologie bien connue comme Power-to-Gas, afin d'optimiser l'opération du parc éolien et offrir une meilleure valeur à l'énergie excédentaire. L'objectif de la Thèse a encore été affinée en coopération avec les partenaires de la Thèse CEA Liten Grenoble, en ce qui concerne l'examen de la faisabilité d'un projet Power-to-Gas en travaillant conjointement avec un parc éolien, alimenté en conséquence seulement par énergie renouvelable, à travers une approche à trois niveaux: technique, économique et environnemental.

En plus d'être la première étude concernant Power-to-Gas dans le contexte actuel du système énergétique roumain, un aspect tout à fait innovant de la présente Thèse réside dans l'approche multidisciplinaire envers cette technologie. Si les évaluations techniques et économiques sont essentiels dans la proposition d'une solution technique appropriée et l'établissement de sa faisabilité économique, l'évaluation environnementale est utile afin d'établir si Power-to-Gas pour apporter de la valeur ou pas en ce qui concerne la réduction des PRP et amélioration de l'efficacité énergétique par la réduction de l'emploi de l'énergie fossile, un pas qui se trouve potentiellement à son début vers l'adoption d'un cadre juridique et des mesures de soutien destinées à de telles technologies de stockage de l'énergie. En jugeant par all les standards du concept, Dobrogea (Roumanie) est un scénario pour mettre à profit Power-to-Gas. Les capacités de stockage de l'énergie renouvelable, les gros émetteurs de CO₂, un réseau saturé de transport et de distribution de l'électricité et un réseau bien développé de gaz naturels coexistent dans une région relativement petite, en offrant bien des possibilités pour la connexion des briques afin d'obtenir la solution la plus efficace.

En élargissant l'horizon de l'étude roumain, Power-to-Gas peut potentiellement être une solution à un paradigme énergétique en changement au niveau européen, où chaque pays a ses propres particularités. France représente l'une des études de cas les plus intéressantes case en termes de solution de stockage de l'énergie suite à son mix énergétique unique dominé par l'énergie nucléaire qui a un avenir controversé dans les années suivantes. Dans un pays où l'énergie maximale est extrêmement précieuse, la technologie Power-to-Gas est regardée

comme un outil potentiellement précieux dans la transition vers un système énergétique futur, tout en prenant en compte ses possibles synergies et l'identification des marchés à forte valeur.

La perspective de la Thèse consiste en une approche multidisciplinaire à Power-to-Gas, plutôt que se concentrer sur un domaine très spécifique du sujet. En conséquence, les objectifs du travail présent peuvent être résumés par les points suivants, qui définissent aussi la colonne vertébrale de la Thèse qui s'étend sur onze chapitres:

- Développer une profonde compréhension du concept Power-to-Gas et son rôle dans le contexte énergétique actuel et futur et établir une connaissance approfondie sur la base des principales technologies représentant les composantes de Power-to-Gas, leur indicateurs clé de performance et leur évolution attendue.
- Réaliser une évaluation techno-économique de la possibilité de mettre à profit la technologie Power-to-Gas (dans les voies Hydrogène et gaz naturel de synthèse (GNS)) dans une implantation non-holistique, des parties prenantes privées en conjonction avec un parc éolien, en prenant en considération le contexte roumain, dans deux perspectives temporelles: 2015 et 2030.
- Analyser la possibilité de fournir des services auxiliaires en tant que marché à haute valeur pour les applications Power-to-Gas dans le contexte énergétique actuel en France.
- Evaluer l'impact environnemental de la mise à profit de Power-to-Gas dans plusieurs scénarios spécifiques d'implantation tout en réalisant une évaluation simplifiée du cycle de vie.

2. DÉVELOPPEMENT DU STOCKAGE DE L'ÉNERGIE EN CONNEXION AVEC L'INTEGRATION DE L'ÉNERGIE RENOUVELABLE

Une croissance importante dans la part de l'énergie renouvelable dans le mix imposera une modification drastique dans la manière de fonctionnement des systèmes énergétiques. Ce type d'énergie ne se concentra pas seulement sur la production d'électricité, mais s'entendra sur des zones de mobilité et production de l'énergie thermique, tout en créant des synergies entre les briques qui fonctionnent en ce moment en tant que des systèmes indépendants.

La plus importante provocation liée à une part plus importante d'énergie renouvelable est provoquée par leur nature intermittente inhérente. Les panneaux photovoltaïques et turbines éoliennes ne peuvent pas produire d'énergie quand cela est nécessaire, mais seulement pendant les heures d'ensoleillement et, respectivement, quand le vent souffle. Pour cette raison, les sources d'énergie renouvelable ne peuvent pas fournir une substituabilité directe pour des installations traditionnelles de la génération de l'énergie, qui ne peuvent pas être mises hors de service et remplacées seulement par leur équivalent en turbines éoliennes ou panneaux PV. Comme l'énergie doit être produite quand-même lors des périodes quand les sources renouvelables ne peuvent pas couvrir la demande, les centrales électriques standard (idéalement des centrales à gaz) devront être maintenues en opération. Cependant, le fait qu'elles opéreront seulement en charge partielle, pendant les heures de demande de pointe, se traduit par une efficacité économique basse et énergie chère ce qui contredit le but d'un gain dans la compétitivité économique. Le facteur de capacité faible des panneaux PV et turbines éoliennes est une mesure de l'intermittence de ces technologies de génération de l'énergie, une qui peut être améliorée seulement par leur association avec d'autres concepts techniques qui assureraient la sécurité de l'approvisionnement [SBC Energy Institute 2014].

Liée en quelque sorte avec l'intermittence des sources d'énergie renouvelable est leur nature largement imprévisible. Il est certain que les systèmes de prévision météo ont évolué au cours des années et on s'attend à ce que bientôt les producteurs d'énergie soient capables de prédire des fluctuations, importantes fluctuations provoquées par les conditions météorologiques sur la base des méthodes plus avancées de prévisions. Cependant, il y aura toujours un certain niveau d'insécurité dans la production de l'énergie renouvelable causée par l'absence de précision dans la prévision météo, obligeant la nécessité pour des technologies d'équilibrage à garder la stabilité du système énergétique.

Une autre provocation bien importante liée à l'énergie renouvelable est l'absence de la flexibilité. En ce moment, des systèmes énergétiques opèrent sur la base d'un équilibre très délicat entre fourniture et demande. La courbe de charge peut prendre des profils très différents et il est presque impossible de prédire son évolution précise lors de la journée, ce qui signifie que dans les systèmes énergétiques actuels la génération doit suivre attentivement la charge. Dans cette entreprise, les générateurs d'énergie distribuables et très flexibles sont employés pour fournir des services qui sont classifiés en fonction du délai: stabilité (contrôle de la fréquence et de la tension lors des secondes jusqu'à une minute), équilibrage (s'occupe de la variation en charge à partir des minutes jusqu'à des jours) et adéquation (concerne la capacité de production d'électricité qui est nécessaire afin de respecter la demande maximale lors des périodes plus longues de temps). Vu que les ressources d'énergie renouvelable sont variables et imprévisibles en ce qui concerne l'approvisionnement, leur intégration dans le système énergétique entraîne des conditions augmentées pour la flexibilité, en réduisant l'efficacité énergétique de l'entier système. En conséquence, une nouvelle demande pour des moyens de réduction et de génération de sauvegarde est créé.

Dans la manière actuelle dont le système énergétique est organisé, des aspects de flexibilité sont abordés en prenant en considération la capacité technique d'une technologie de génération afin de répondre aux demandes et leur coût marginal de production. L'une des questions qui a été identifiée en ce qui concerne l'intégration des sources renouvelables et leur coût marginal, très bas, près de zéro, ce qui signifie qu'elles seront la première option dans le classement par ordre de mérite. Cela va affecter les installations conventionnelles de génération de l'énergie tout en les éloignant de la charge de base et mettant en danger leurs taux d'amortissements (ces installations doivent fonctionner autant qu'il est nécessaire afin de couvrir leurs dépenses en capital et d'opération). En conséquence, si des sources renouvelables sont déployées sans de moyens efficaces de contrôler leur fourniture, ce système aura probablement à affronter une augmentation dans les coûts associée à la production de l'énergie.

En prenant en compte les contraintes mentionnées ci-dessus en ce qui concerne l'énergie renouvelable et les provocations imposées par elle, un consensus a été trouvé en ce qui concerne le fait qu'une part plus importante d'énergie renouvelable ne peut pas être accommodée par le système énergétique sans des technologies supplémentaires qui permettront la transition vers un système évolué.

En ce moment trois solutions techniques ont été identifiées comme possibles options pour l'intégration efficace d'une part importante d'énergie renouvelable: l'expansion du réseau, la Gestion Axée sur la Demande (GAD) et stockage de l'énergie. Pour le moment, des technologies de stockage de l'énergie peuvent seulement atteindre la faisabilité économique dans certains cas spécifiques où elles peuvent profiter pleinement de marchés à haut valeur. Pourtant, afin d'étendre ces solutions à un niveau plus important, il y a un certain besoin pour des mesures d'attrait qui faciliteraient la transition envers un nouveau énergétique. Une actualisation complète sur le cadre actuel de politique afin de comprendre des mesures qui appuieront les technologies de stockage de l'énergie est un sujet fréquent de discussion parmi les spécialistes dans le domaine. Cependant, l'équilibrage de ces mesures s'avérera une tâche extrêmement difficile, en particulier dans la situation actuelle dans laquelle les pays de l'Union Européenne ne partagent pas une politique unifiée concernant les mesures liées à l'énergie. L'objectif est d'offrir des chances équitables à toutes les solutions de stockage de l'énergie qui peuvent être intégrées dans le système, sans réaliser aucun type de discrimination.

Pour le moment les systèmes énergétiques des pays membres de l'Union Européenne n'ont pas besoin de stockage d'énergie avec un petit nombre d'exceptions mineures [ADEME 2014] [SBC Energy Institute 2014]. Dans l'état actuel de développement et intégration des sources d'énergie renouvelable le système peut être équilibré par l'emploi de l'infrastructure existante. Pourtant, les choses changeront avec la part de plus en plus grande d'énergie renouvelable dans le mix d'énergie, une mesure entraînée en particulier par le besoin de réduire les émissions de CO₂. Premièrement, il y aura un besoin pour le stockage de l'énergie dans un délai court avec le but de consolider la flexibilité du système et fournir des services auxiliaires précieux, alors que dans l'avenir plus éloigné il y aura un besoin pour le stockage de l'énergie à long terme (même saisonnier) qui contribuera principalement à l'assurance de la sécurité de l'approvisionnement et l'indépendance de l'énergie de l'Union Européenne.

Du point de vue technique, le problème du stockage de l'énergie a été résolu. Certes, il y aura un progrès supplémentaire en ce qui concerne l'efficacité, la durée de vie améliorée et les gains marginaux inhérents, mais les technologies auront été éprouvées. Bien que nous nous confrontons avec une réduction significative dans les coûts de capital de la plupart des options de stockage de l'énergie dans la dernière période, il y a encore lieu pour l'amélioration et le consensus est que l'outil le plus puissant en ce qui concerne la réduction des coûts est le marché. Par conséquent, on s'attend à ce qu'une implantation graduelle du marché associée avec un

progrès ultérieur en recherche et développement réduisent les coûts rapidement, dans une manière similaire à la réussite du secteur photovoltaïque [Agora 2014][Agora 2014].

3. CONTEXTE ÉNERGÉTIQUE ROUMAIN

Depuis 1990 la demande en énergie électrique a enregistré des variations significatives en Roumanie en corrélation avec les évolutions industrielles, économiques et sociétales. Par conséquent, dans la première décennie, entre les années 1990 et 2000, la demande en énergie électrique s'est diminuée de manière importante suite à la dégradation du secteur industriel. A partir de l'année 2000, la courbe de demandes a commencé à stabiliser et la demande en énergie a enregistré la première évolution positive dans une décennie. Jusqu'en 2008, la demande en énergie électrique en Roumanie a enregistré une croissance constante et a atteint un sommet lors de la même année, en directe corrélation avec la situation économique du pays. Entre les années 2008 et 2013, la demande brute en énergie électrique a subi un effondrement de 6%, étant profondément influencée par la crise économique et la contraction supplémentaire du secteur industriel.

Le charbon et l'hydroélectricité ensemble ont une part de 54.7% de la production d'énergie électrique, alors que l'énergie nucléaire couvre un pourcentage de 20.6% de la part totale. Avec l'expansion des sources d'énergie renouvelable, l'énergie éolienne a atteint 9% du mix de la production de l'énergie au niveau de l'année 2013. En 2013, la Roumanie a importé 0.45 TWh d'énergie électrique et a exporté 2.47 TWh. Le but au niveau national est de garder le rôle du pays en tant qu'un exportateur important d'énergie électrique sur le marché de l'Europe Centrale et d'Est. A la fin de l'année 2013, la capacité installée totale des facilités de production de l'énergie renouvelable était de 4,418 MW, 63% provenant des turbines éoliennes terrestres et approximativement 23% des installations photovoltaïques. L'évolution fortement abrupte (de 47 MW en 2008 à 4,418 MW en 2013) trouve son explication dans le plan généreux de soutien de l'énergie renouvelable mis en place afin d'aider la Roumanie à atteindre les buts imposés par l'initiative européenne 20-20-20. Le système énergétique de la Roumanie héberge en ce moment la plus grande ferme éolienne terrestre de l'Europe, avec une capacité installée totale de 600 MW. Suite aux changements dans le plan de soutien, les développements significatifs dans l'énergie éolienne ont été remplacés par des investissements dans des installations photovoltaïques, leur capacité installée totale augmentant en 2013 de 94 MW à environ 860 MW.

Roumanie possède en ce moment les plus importantes réserves de gaz naturels de l'Europe Centrale et d'Est avec un total sûr de réserves de 1,600 TWh et des ressources géologiques de

6,500 TWh. Un pourcentage total de 95% des ressources conventionnelles totales de gaz naturels, respectivement 93% des réserves sûres, sont terrestres. Pourtant, la plupart des réserves de gaz naturels de la Roumanie se trouvent dans une condition avancée d'exploitation et peuvent être opérées seulement à des pressions et débit bas.

Pour une production moyenne par an de gaz naturels de 11 milliards de mètres cubes, avec une réduction constante de 5% dans les réserves sûres et un taux de remplacement des réserves de 80%, on estime que les réserves actuelles de gaz naturels de la Roumanie seraient épuisées en environ 14 ans. Les perspectives de trouver de nouvelles ressources sont conditionnées par le futur volume des investissements en exploration géologique, aussi bien que par le résultat des activités d'exploration. En 2012 de nouvelles ressources de gaz naturels ont été découvertes dans le périmètre terrestre de Neptun, avec des ressources estimées entre 446 et 893 TWh, augmentant possiblement la réserve nationale de gaz naturels par 40 jusqu'à 80%. En 2013 la consommation totale de gaz naturels en Roumanie a atteint 132,6 TWh, 85% de ce total étant couvert par la production interne et le reste provenant des importations. Bien que lors des dernières années la production interne de gaz naturels ait subi une tendance de réduction, on estime que dans les dix années suivantes la direction changera une fois commencée l'exploitation des gaz de schiste et réserves à la mer.

Une vue d'ensemble sur la situation du système énergétique de Roumanie décrit dans le présent chapitre points montre un contexte intéressant pour les technologies Power-to-Gas suite aux provocations présentées, aussi bien que la diversité des moyens techniques et les mécanismes du marché qui peuvent soutenir le déploiement d'un tel concept.

4. LE CONCEPT POWER-TO-GAS

Dans le cas du Power-to-Gas, l'électricité excédentaire est convertie en énergie chimique dans le cadre du procès d'électrolyse par la production de l'hydrogène. A partir de ce moment, en fonction de l'application, l'hydrogène peut être utilisé de manières multiples:

- Comme hydrogène, en applications industrielles ou pour l'alimentation des d'automobiles à pile à combustible
- Pour la re-électrification, en utilisant des piles à combustible
- Injecté dans le réseau de gaz naturels, en prenant en compte les limitations en matière de concentration limitations
- Pour la production du gaz naturel de synthèse (SNG - Substitute Natural Gas) dans la réaction de méthanisation

Les deux dernières possibilités constituent les principales voies du concept Power-to-Gas, telles que traitées par la Thèse. En conséquence, si l'on analyse les deux, on peut affirmer que Power-to-Gas fait la liaison entre l'électricité et le réseau de gaz naturels, en élargissant par conséquent la capacité de stockage du système énergétique et augmentant son niveau de flexibilité. [Sternier 2009] présente le principe de fonctionnement du concept Power-to-Gas dans la figure suivante:

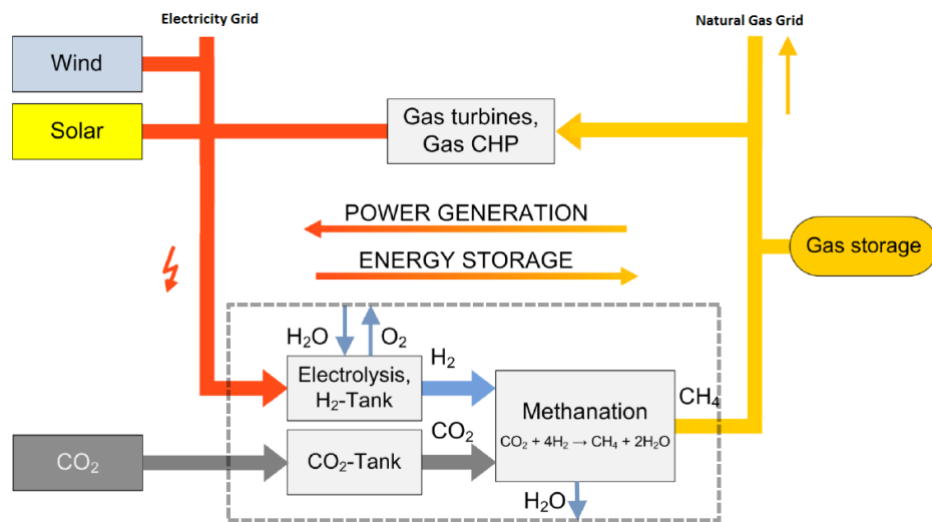

Figure 4.1 Le concept Power-to-Gas (source: [Sternier 2009])

Comme [Sternier 2009], [Michael Specht 2009] et [Jentsch et al. 2014] présentent, Power-to-Gas représente une solution technique complexe modulaire offrant une capacité inestimable de stockage et apporte un important degré de flexibilité à un système énergétique. En fonction de

la location du projet et des particularités du système énergétique et du contexte industriel de la région spécifique de déploiement, Power-to-Gas offre deux voies technologiques différentes:

A. Hydrogène Power-to-Gas

Représente la solution moins complexe qui, en termes de disponibilité technologique courante, est prête à être déployée dans des applications réelles massives en ce moment [Gahleitner 2013]. Dans cette voie, l'énergie renouvelable est transformée en hydrogène dans le processus d'électrolyse et ensuite injecté dans le réseau de gaz naturels, en profitant de sa capacité de stockage et de ses capacités de transport, comme indiqué par Figure 4.2. Pourtant, il faut souligner qu'il y a une certaine limite pour le volume de l'hydrogène qui peut être injecté dans le réseau de gaz naturels sans d'importantes modifications dans l'infrastructure et la fonctionnalité des applications bout de la chaîne. Des considérations supplémentaires concernant cet aspect seront présentées plus tard dans le cadre de la Thèse, dans un sous-chapitre dédié.



Figure 4.2 Représentation schématique de la voie Hydrogène Power-to-Gas

Les avantages de la mise à profit de la voie Hydrogène Power-to-Gas résident dans la complexité réduite de l'approche technique, au moins en comparaison avec la voie Méthanisation. En essence, les unités d'électrolyse (qui peuvent en ce moment être considérées comme matures du point de vue commercial, au moment quand il s'agit d'électrolyseurs alcalins) sont couplées avec les sources d'énergie renouvelable en amont, alors qu'en aval sont nécessaires une station d'injection avec la connexion nécessaire afin de permettre l'injection du hydrogène dans le réseau de gaz naturels. Conformément à [Lehner et al. 2014], l'efficacité de la voie Hydrogène Power-to-Gas est située entre 54 et 72% si une compression à haute pression (200 bar) est employée, 57 et 73% si une compression à pression moyenne (80 bar) est prise en considération, ou entre 64 et 77% s'il n'y a pas de compression de hydrogène à cette étape.

B. Gaz naturel de synthèse (SNG) Power-to-Gas

La voie technologique complète du concept apporte le CO₂ dans l'équation, avec le but d'offrir et même une meilleure capacité et flexibilité de stockage, tout en mettant l'accent sur les avantages environnementaux de Power-to-Gas, en captant les émissions de CO₂ pour au moins

un cycle à l'intérieur de la boucle technologique. Cette voie représente une solution pour les locations où il n'y a pas seulement une large concentration de facilités de production d'énergie renouvelable, mais aussi d'importants émetteurs de CO₂, tels que centrales électriques, industrie de l'acier et du ciment ou raffineries de pétrole.

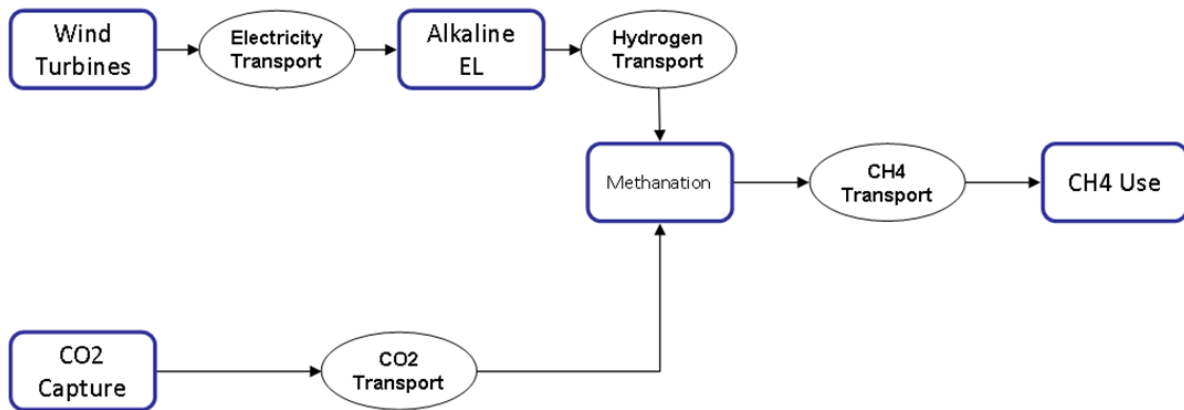

Figure 4.3 Représentation schématique de la voie gaz naturel de synthèse (SNG) Power-to-Gas

En comparaison avec la voie Hydrogène Power-to-Gas, la voie gaz naturel de synthèse (SNG) ajoute deux procédés technologiques encore plus complexes (captage CO₂ et méthanisation), tout en renonçant à la partie d'injection de l'hydrogène, le processus de captation de CO₂ assurera la concentration haute nécessaire de gaz CO₂ qui sera combinée avec l'hydrogène livré par le processus d'électrolyse, dans l'étape de méthanisation, comme présenté par Figure 4.3. Le résultat de cette voie plus complexe avec le réseau de gaz naturels, sans des préoccupations relatives à des questions de concentration, tout en conférant un accès complet à l'énorme capacité de stockage de l'infrastructure de gaz naturels. Un avantage supplémentaire consiste dans le fait que le gaz naturel de synthèse (SNG) peut être stocké et transporté par le réseau de gaz naturels sans apporter des modifications à l'infrastructure ou aux applications d'utilisateur final. Le gaz naturel de synthèse (SNG) Power-to-Gas peut être déployé comme une seconde phase, une évolution de l'Hydrogène Power-to-Gas.

En ce qui concerne l'efficacité, [Lehner et al. 2014] affirme que le rendement global de la voie gaz naturel de synthèse (SNG) est compris entre 49 et 64% au moment de l'inclusion de la compression à haute pression (200 bar), entre 50 et 64% pour la compression à pression moyenne (80 bar) et entre 51 et 65% si aucune pression n'est utilisée. L'efficacité globale baisse en comparaison avec l'Hydrogène Power-to-Gas, en principal suite aux pertes supplémentaires de conversion qui prennent place dans l'étape de méthanisation.

Dans toutes les deux voies Power-to-Gas, hydrogène et respectivement gaz naturel de synthèse (SNG), tout en étant les principaux résultats, ils ne sont pas les seuls produits à apprécier. Un produit secondaire significatif du processus d'électrolyse de l'eau est l'oxygène à haute pureté, qui peut être apprécié en particulier dans les applications industrielles et médicales. À part l'oxygène, l'électrolyse produit aussi de la chaleur, mais en ce moment (lors de la prise en considération des unités alcalines et PEM) il est difficile à apprécier à cause de la température basse d'opération. Pourtant, l'intégration de la chaleur peut être un potentiel sujet de discussion lors de la prise en considération des unités SOEC. Le processus de méthanisation produit aussi de la chaleur résiduelle qui peut être appréciée en tant que produit secondaire des voies Power-to-Gas. La valeur économique des produits secondaires des applications Power-to-Gas sera présentée, analysée et discutée en détail dans les chapitres traitant l'évaluation technique et économique de la technologie.

[Lehner et al. 2014] présente des données suggérant qu'une concentration recommandée maximale de hydrogène dans l'infrastructure des gaz naturels serait environ 2%. D'autre part, [Polman n.d.] a analysé l'influence de l'injection du hydrogène sur la capacité de transport de l'infrastructure de gaz naturels, qui est déterminée par la perte de pression par quantité transport d'énergie. L'une des conclusions de l'étude a été que, suite à la compressibilité inférieure de l'hydrogène par rapport au méthane, la capacité de l'infrastructure de transmission décroît plus rapidement quand la pression est plus haute. Les auteurs de l'étude ont envisagé un scénario à trois étapes de l'injection de l'hydrogène dans l'infrastructure de gaz naturels:

- Première étape – 3% avec presque aucune modification nécessaire
- 12% - la qualité du mélange respectera les standards, mais des adaptations seront nécessaires
- 25% - faisable du point de vue technique, mais avec des adaptations majeures

[ADEME 2014] déclare que dans le cas de la France, la limite de concentration de l'hydrogène est située à 6% et cite ITM Power dans le graphique suivant avec la situation dans les pays les plus importants de l'Europe:

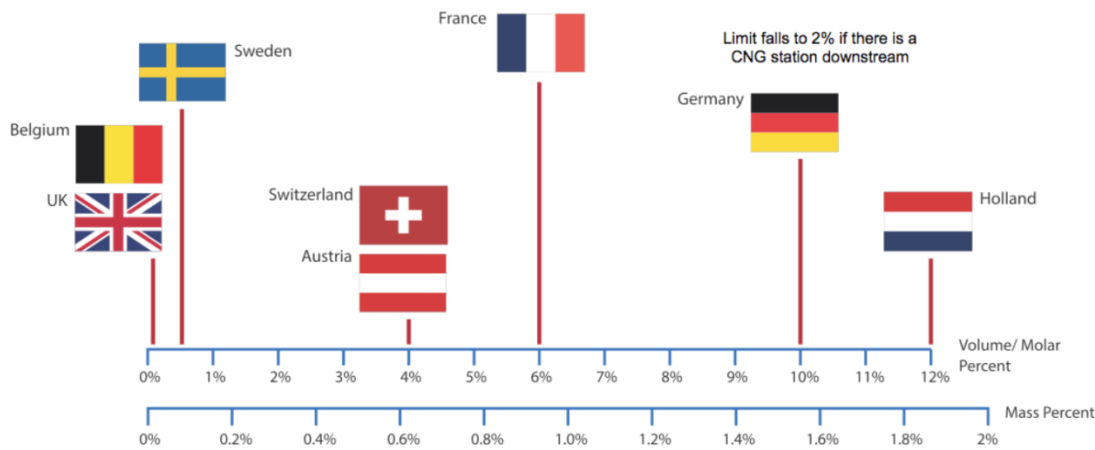

Figure 4.4 Concentration de l'hydrogène dans les limites de gaz naturel dans les pays européens (Source: [ADEME 2014], ITM Power)

Power-to-Gas est une technologie qui peut réunir l'électricité et les réseaux de gaz naturels et les marchés, deux secteurs qui sont fortement standardisés et réglementés. En plus, ce concept technique intègre aussi l'énergie renouvelable et, dans certaines voies, la captation du dioxyde de carbone, des technologies qui sont ou seront, aussi, appuyées par un set puissant de mesures de politique et soutien. Tout cela, en association avec le fait que le Power-to-Gas implique des coûts significatifs, ouvrent la discussion vers le cadre juridique dans lequel cette technologie devrait être déployée.

En ce moment, le cadre juridique dédié en particulier à Power-to-Gas est pratiquement non-existant au niveau européen, à l'exception de l'Allemagne. Il y a certaines réglementations dans des pays spécifiques en ce qui concerne des aspects ponctuels tels que la qualité du gaz et les exigences en matière de concentration pour l'hydrogène ou bien le gaz naturel de synthèse (discutés dans le cadre de la section antérieure), aussi bien que des réglementations au sujet de prix majorés pour le biogaz, qui dans certains pays couvre le gaz naturel de synthèse (SNG) produit par Power-to-Gas (France), et dans autre cas cela n'est pas d'application (Roumanie), ce qui entraîne le besoin pour la législation unitaire en ce qui concerne ce qui est considéré comme biogaz et qui pas (standardisation). Un potentiel cadre juridique peut aborder plusieurs directions principales afin d'encourager le développement et le déploiement à grande échelle des technologies Power-to-Gas [SBC Energy Institute 2014]:

- Cadre de réglementation pour l'injection de l'hydrogène dans le réseau de gaz naturels et protocoles actualisés de sécurité concernant l'emploi à large échelle de l'hydrogène.
- Facilitation de l'accès des applications de stockage de l'énergie au marché des services auxiliaires, en principal en baissant la capacité installée minimale nécessaire pour un

participant, ce qui représente aussi l'un des aspects clé identifiés par l'étude [Agora 2014].

- Acceptation sociale et éducation afin de promouvoir des technologies basées sur l'hydrogène-afin de se développer.

Comme identifiés par la même étude, il y a quatre mécanismes de soutien principalement orientés économiquement qui peuvent être pris en considération pour faciliter l'accès de Power-to-Gas:

- Tarifs de subventionnement/prix majorés pour l'hydrogène renouvelable ou le gaz naturel de synthèse (SNG) – de manière similaire aux tarifs de subventionnement appliqués au secteur de l'énergie renouvelable, ce type de mesure d'attrait est déjà utilisée pour le gaz naturel de synthèse (SNG) en France où 45 - 125 Euro/MWh de gaz naturel de synthèse (SNG) sont payés.
- Réduction des tarifs de connexion et de réseau – afin d'éviter des situations dans lesquelles les opérateurs Power-to-Gas devraient payer deux fois, une fois pour l'énergie qu'ils reçoivent en amont et la deuxième fois pour le hydrogène/le gaz naturel de synthèse (SNG) injecté en aval.
- Exonération fiscale pour l'hydrogène ou le gaz naturel de synthèse (SNG) renouvelable.
- Imposition des quotas pour la part de l'hydrogène/gaz naturel de synthèse (SNG) renouvelable dans le mix d'énergie ou pour le secteur de la mobilité.

La manière dont la captation du carbone va être traitée lors de la période suivante au niveau européen est aussi un facteur qui peut potentiellement déterminer l'évolution de la technologie Power-to-Gas, en particulier au moment où l'on parle de la voie gaz naturel de synthèse (SNG). L'application de la réduction du carbone dans certaines industries (telles que l'industrie du ciment ou les centrales électriques à charbon/gaz naturel) nécessiteront d'importants investissements en technologies de la captation de carbone ce qui va entraîner une croissance du prix du CO₂, en ajoutant un troisième marché à l'équation Power-to-Gas.

5. LES ÉLÉMENTES DU CONCEPT POWER-TO-GAS

ENERGIE RENOUVELABLE

Le principe de fonctionnement du concept Power-to-Gas consiste dans le stockage de l'énergie excédentaire provenant des sources fluctuantes d'énergie renouvelable (en général des turbines éoliennes et panneaux photovoltaïques) qui ne correspondent pas à la demande du système énergétique et son emploi ultérieur. Pourtant, suite au fait que le stockage d'importantes quantités d'énergie électrique (stockage multi MWh) sous la forme d'électricité a des options limitées, un vecteur d'énergie supplémentaire doit être pris en considération (dans le cas du Power-to-Gas, ce vecteur est l'hydrogène ou le gaz naturel de synthèse - SNG). Bien que le Power-to-Gas puisse employer de l'énergie provenant des unités conventionnelles de génération, suite aux pertes d'efficacité associées avec les procédés de conversion et le fait que ceux-ci sont en général distribuables, ils ont une charge environnementale plus importante et aussi un degré plus haut de prédictibilité, l'emploi de l'énergie renouvelable en tant que la source de l'énergie d'entrée est plus logique.

L'un des aspects les plus importants concernant la génération d'énergie renouvelable en conjonction avec une installation Power-to-Gas suit attentivement la courbe des demandes et "shaving" la quantité correcte de l'énergie excédentaire, afin d'assurer l'opération la plus efficace (du point de vue technique et économique) pour la turbine éolienne ou l'installation photovoltaïque aussi bien que pour les unités d'électrolyse.

L'énergie excédentaire est difficile à définir dans le cas particulier dans lequel la mise à profit du Power-to-Gas en conjonction avec une unité spécifique de production de l'énergie renouvelable (mais pas dans une approche holistique au niveau du système énergétique). Vu que des unités d'énergie renouvelable peuvent être considérées comme des unités qui doivent fonctionner (le cas de la Roumanie), il y a un surplus très insignifiant associé à cette voie de production de l'énergie. Plutôt est utilisée une énergie à bas prix de valeur inférieure pour alimenter les unités d'électrolyse faisant partie de l'unité Power-to-Gas.

ÉLECTROLYSE

En ce moment il y a trois technologies principales d'électrolyse qui peuvent être prises en considération en conjonction avec le stockage de l'énergie: Electrolyse alcaline, électrolyse à

Membrane Échangeuse de Protons (Proton Exchange Membrane - PEM) et Cellule d'Électrolyse à Oxyde Solide (SOEC - Solid Oxide Electrolyser Cell).

Les indicateurs les plus importants de performance pour les technologies d'électrolyse Alcalines et PEM dans les applications de stockage de l'énergie ont été fournis dans le Tableau 5.1. La Cellule d'Électrolyse à Oxyde Solide (SOEC) n'a pas été comprise vu que l'horizon pour la maturité commerciale reste encore éloigné.

Tableau 5.1 Indicateurs clé de performance des technologies d'électrolyse Alcaline et PEM en 2015 et 2030

Catégorie	Alcaline		PEM		Référence
	2015	2030	2015	2030	
Dimension de la pile [kW]	200 - 4900	400 - 7800	100 - 1300	1,000 - 10,000	[Bertuccioli et al. 2014]
Entrée électricité [kWhel/kgH2]	50 - 73	48 - 63	47 - 73	44 - 53	
Disponibilité [heures/année]	8585	8585	8600	8672	
Pression de sortie [bar]	0.05 - 40	0.05 - 60	20 - 80	30 - 100	
Température de fonctionnement [°C]	60 - 80	60 - 90	54 - 84	60 - 90	
Durée de vie de la pile [heures]	70,000 – 90,000	90,000 - 100,000	30,000 - 90,000	60,000 – 90,000	
Durée de vie du système [années]	22 - 30	30 - 30	14 - 30	30	
Charge partielle minimale [% de charge pleine]	16 - 33	10 - 20	3 - 8	0 - 5	
Temps de démarrage [minutes]	20 minutes minimum	20 minutes minimum	5 - 15	5 - 15	
Temps de montée de la rampe [% de charge pleine /seconde]	0.13 - 20	0.13 - 25	10 - 100	10 - 100	
Temps de descente de la rampe [% de charge pleine /seconde]	20	25	10 - 100	10 - 100	
Coût d'investissement en capital [Euro/kW]	760 - 1100	370 - 800	1200 - 1940	250 - 1270	
Dépenses d'exploitation [% of CAPEX]	1.5 - 5	1.5 - 5	1.5 - 5	1.5 - 5	

Certains développements sont envisagés pour tous les deux électrolyseurs Alcalin et PEM dans les suivants 15 ans. Si l'on attend à ce que les progrès techniques soient plutôt marginaux que

révolutionnaires, ils auront lieu plus probablement et apporteront seulement des améliorations à l'efficacité per ensemble des applications de stockage de l'énergie. D'autre part, on s'attend à ce que les progrès économiques sont plus dramatiques, avec des coûts d'investissement en capital réduits de manière importante pour l'électrolyse alcaline aussi bien que PEM, vu que l'on s'attend à ce que le déploiement à grande échelle du stockage de l'énergie réduise rapidement les coûts.

[ADEME 2014] souligne le fait que les réductions envisagées des coûts dériveront de trois éléments:

- Amélioration de la technologie, ce qui signifie des matériels à des prix plus bas pour les composantes des unités d'électrolyse; en plus, on s'attend à ce que moins de matériels entrent dans la fabrication des unités.
- Améliorations en matière de dimensionnement des unités, ce qui se traduit par des gains en performance.
- Une augmentation des volumes des ventes, entraînant un degré supérieur d'industrialisation, permettant une optimisation dans la structure des coûts.

MÉTHANISATION

Sur la base de la réaction chimique découverte par le chimiste français Paul Sabatier au début du 20^{ème} siècle, l'étape de méthanisation représente la seconde étape dans la voie gaz naturel de synthèse (SNG) Power-to-Gas:

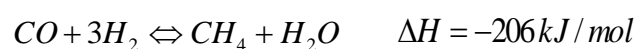
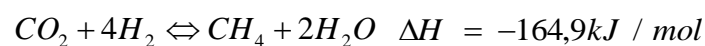

Suite à la stabilité thermodynamique haute et à l'état élevé d'oxydation, est nécessaire un agent réducteur puissant pour l'activation du CO₂, l'hydrogène étant le plus approprié. La réduction du CO₂ avec l'hydrogène entraîne l'obtention du méthane et de l'eau. CO et CO₂ sont hydrogénés conformément aux réactions de méthanisation, tous les deux favorisé par le contenu bas en eau et la pression haute. Une provocation découle de l'augmentation de la température adiabatique à potentiel haut parce qu'elle a besoin d'un catalyseur stable à températures hautes qui a aussi une activité haute à températures basses. Dans le cas où le gaz de synthèse avec une concentration minimale en méthane était introduit dans un réacteur de méthanisation adiabatique à 300°C, la réaction pourrait atteindre des températures autour de 900°C. La réaction de Sabatier est exothermique et offre de la chaleur à des températures hautes, favorisant la possibilité de récupérer de la chaleur afin d'améliorer l'efficacité globale

du procès et ouvrir des nouvelles opportunités de synergie pour le projet Power-to-Gas. Il est important d'observer qu'un système de purification est nécessaire à la sortie des réacteurs de méthanisation afin de mettre la sortie gaz naturel de synthèse (SNG) en ligne avec les exigences en matière d'injection affirmés par l'opérateur du réseau de gaz naturels.

Conformément à [ADEME 2014] et [Zuberbühler 2013], l'efficacité de l'étape de méthanisation est environ 79% HHV. Pourtant, si la chaleur produite par le procès est récupérée (on estime que 90% ode la chaleur peut être récupérée), l'efficacité globale peut augmenter jusqu'à environ 98% HHV. En matière d'opération dynamique, les mêmes sources indiquent le fait qu'un régime d'opération en état stable est idéal, prolongeant la durée de vie du canalisateur. Suite au fait que les réacteurs de méthanisation ne peuvent pas être opérés avec la même flexibilité que les unités d'électrolyse, l'intercalation d'un réservoir de stockage de l'hydrogène représente la solution pour assurer une opération continue à l'étape de méthanisation.

En termes de coûts, la méthanisation reste encore une technologie chère de niche, les coûts étant présentés par [DNV KEMA Energy & Sustainability 2013] dans la figure suivante:

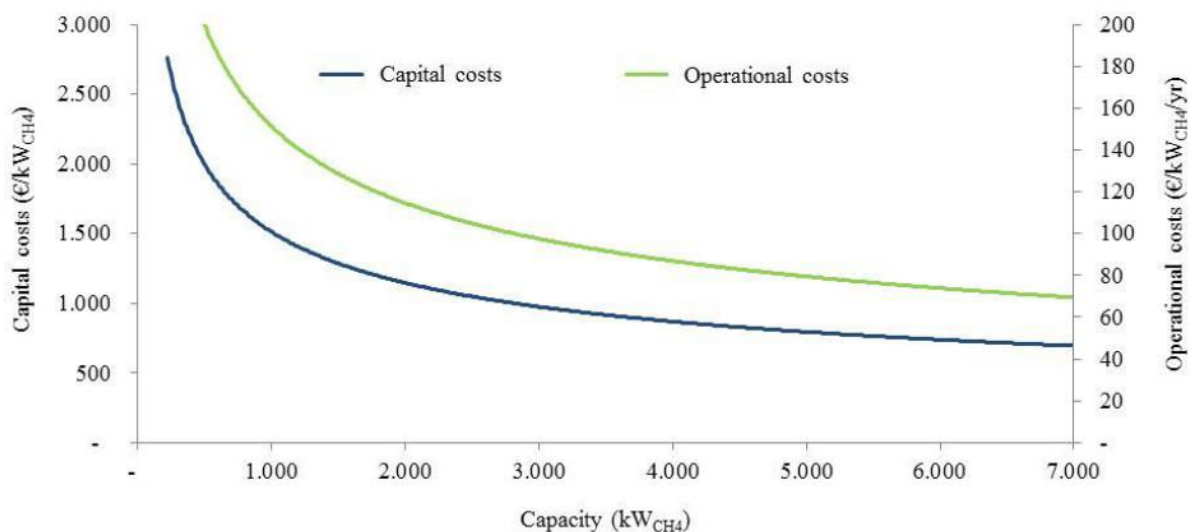

Figure 5.1 Coûts de capital et d'exploitation de la méthanisation (source: [DNV KEMA Energy & Sustainability 2013])

Conformément à [ADEME 2014], on s'attend à ce que les coûts baissent dans les suivantes 15 années, vers des CAPEX d'environ 500 Euro/kWh de gaz naturel de synthèse (SNG) HHV en 2030 et des COPEX de 10% des CAPEX par an, alors qu'aucune amélioration significative de l'efficacité n'a été attendue.

CAPTATION DE CO₂

[UN Industrial Development Association 2010] et [Göttlicher 2004] présentent que, en fonction de l'application et ses particularités, il y a trois approches principales pour la captation de carbone: post-combustion, pré-combustion et l'oxy-combustion. La captation du CO₂ en post-combustion est la seule technologie à atteindre la maturité commerciale en ce moment et présente l'avantage d'offrir la possibilité d'être modernisée aux installations existantes d'émission de dioxyde de carbone. Un autre avantage réside dans le fait que l'on s'attend à ce que son efficacité globale s'améliore encore plus dans l'avenir proche suite aux avancements importants dans l'équipement et les adsorbants. Les plus grands inconvénients résident dans la pénalité qu'elle apporte dans l'efficacité du processus industriel et dans la pression basse de sortie de CO₂ [International Energy Agency 2008].

La captation du dioxyde de carbone est, pour le moment, une technologie chère qui apporte une pénalité significative en matière de coût aux émetteurs industriels: dans le cas des centrales électriques (charbon ou gaz naturel) le coût de la captation du CO₂ est situé entre 35 et 50 Euro/tonne, alors que pour l'industrie du ciment, le coût est estimé entre 30 et 65 Euro/tonne de CO₂ [ADEME 2014]. La même source signale sur les ressources nécessaires pour la captation du CO₂ dans une centrale électrique si une technologie post-combustion est utilisée 0.03 MWh/tonne de CO₂ électricité, 1.04 MWh/tonne de CO₂ chaleur et 1.5 m³ d'eau par tonne de CO₂. En plus, les CAPEX - Dépenses d'Investissement estimées de 450,000 Euro/tonne CO₂/h est nécessaire, avec les OPEX - Dépenses d'Exploitation de 14,000 Euros/tonne CO₂/h/année.

STOCKAGE DE L'HYDROGÈNE

Dans certaines applications du concept Power-to-Gas (par exemple la voie gaz naturel de synthèse (SNG) Power-to-Gas, où un débit constant d'hydrogène est idéalement assuré pour l'entrée du réacteur de méthanisation), le stockage de l'hydrogène devient une exigence. En ce moment, la solution technique standard pour le stockage de l'hydrogène à une pression relativement haute consiste en l'emploi des réservoirs d'hydrogène et une vue d'ensemble des coûts peut être visualisée en Figure 5.10.

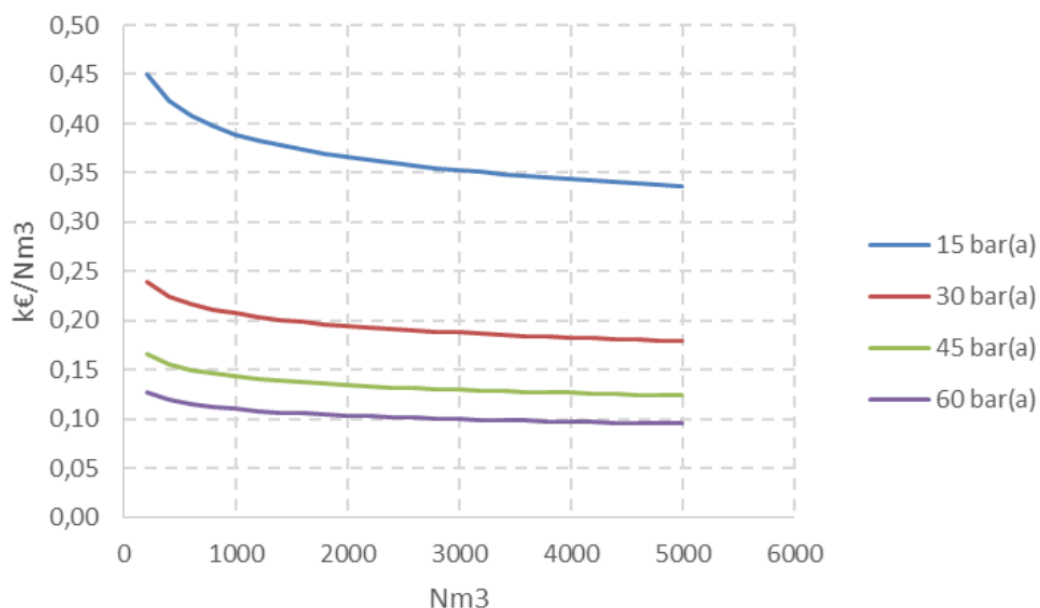

Figure 5.2 Coûts de capital des réservoirs de stockage de l'hydrogène en fonction de la pression de stockage [Source: [ADEME 2014)]

COMPRESSION DE L'HYDROGÈNE

En ce moment, la pression maximale de sortie des électrolyseurs Alcalin ou PEM pour des projets Power-to-Gas varie entre 1 et 30 bar [Bertuccioli et al. 2014], [ADEME 2014]. Pourtant, quand on prend en compte le stockage de l'hydrogène, afin de garder les coûts de capital associés à la dimension du réservoir de stockage à un niveau raisonnable, une étape de compression est nécessaire entre la sortie des électrolyseurs et le réservoir de stockage. Suite aux particularités de l'hydrogène (il a les molécules au plus réduit diamètre), les compresseurs de hydrogène ont une construction relativement complexe qui se traduit par des coûts du CAPEX plus hauts par rapport aux compresseurs dédiés à autres gaz, comme présenté par Figure 5.11.

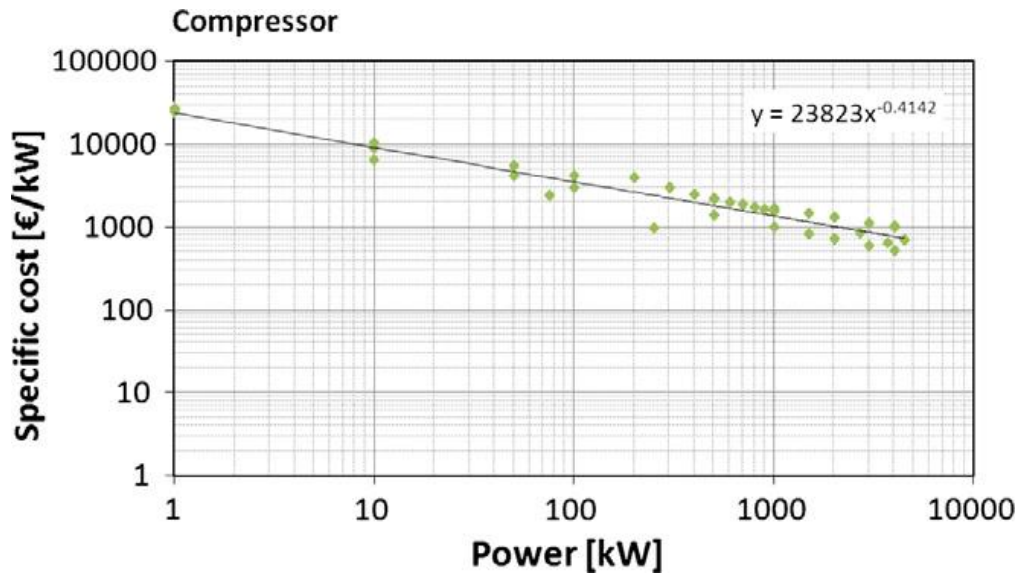

Figure 5.3 Coûts de capital des compresseurs d'hydrogène (Source: [Beccali et al. 2013])

ÉLÉMENTS D'INJECTION

Pour l'injection de l'hydrogène ou du gaz naturel de synthèse (SNG -Substitute Natural Gas) dans l'infrastructure des gaz naturels (réseau de transport ou distribution), sont nécessaires une station de connexion et une station d'injection. La station d'injection station contient en général tous les éléments en ce qui concerne le contrôle, le mesurage, le contrôle de la qualité et l'odorisation, alors que la connexion établit le lien entre la station des injections et le réseau de gaz naturels.

Au moment de l'injection dans le réseau de distribution des gaz naturels, qui a une pression de 5 bars, le CAPEX de la station d'injection est d'environ 600,000 Euros, avec un OPEX de 8% du CAPEX. Le coût de capital associé à la connexion dans la même situation est d'environ 130,000 Euros, avec un OPEX de 2% du CAPEX.

Quand l'injection est réalisée directement dans le réseau de distribution à une pression plus haute (30 bar), les CAPEX de la station d'injection augment à 700,000 Euros, alors que le coût de capital de la connexion est de 410,000 Euros. Les OPEX associés aux deux composantes de l'infrastructure restent les mêmes. La date économique est valable pour la France, comme présenté par [ADEME 2014].

6. DÉVELOPPEMENT D'UN CADRE D'ANALYSE POUR LES PROJETS POWER-TO-GAS

Figure 6.1 présente la représentation schématique du nouveau cadre d'analyse proposé dans le présent chapitre. En essence, l'entier cadre peut être divisé en deux parties: le dimensionnement technique et l'analyse économique.

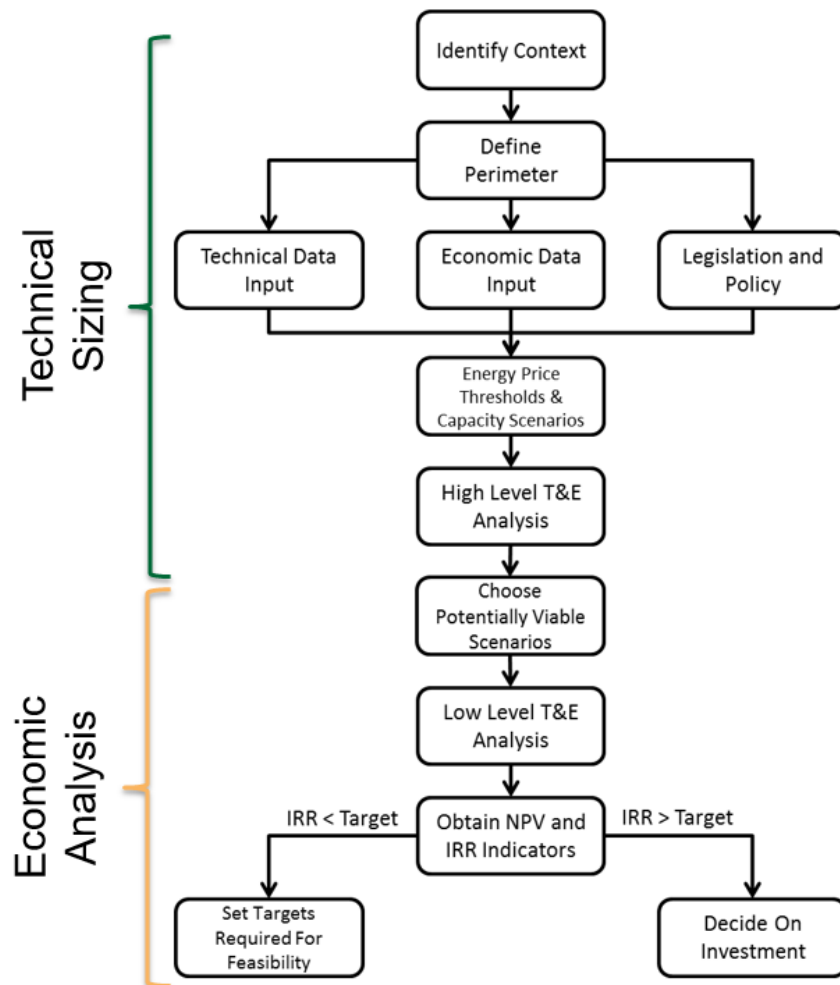

Figure 6.1 Le nouveau cadre d'analyse pour des projets Power-to-Gas développés comme faisant partie de la thèse

- i. Identification du contexte– Le premier pas de l'approche concerne l'établissement du projet et la définition de l'objectif et de la portée de l'étude, avec l'accent mis sur la réponse aux exigences spécifiques de l'investisseur, aussi bien que le type du projet Power-to-Gas, la localisation géographique et la période désirée de début du projet. Une autre partie importante dans la compréhension du contexte consiste à identifier toutes les ressources disponibles (dioxyde de carbone, eau etc.) et l'infrastructure de transport (infrastructure bien développée de transport ou distribution des gaz naturels, lignes de transport d'électricité de diverse tension etc.) associés avec la technologie Power-to-

Gas. Cela peut potentiellement répondre à des questions liées au type de projets Power-to-Gas qui peuvent être développés, aussi bien qu'offrir des solutions pour des possibles synergies avec des procédés en amont ou en aval (en offrant une valeur économique à l'oxygène, l'intégration de la chaleur, la captation de carbone etc.).

- j. Définition du périmètre– Après l'analyse de la possible application de la technologie Power-to-Gas dans le contexte donné, l'intégration disponible et les possibilités de synergie offertes par la localisation géographique, le pas suivant consiste en la définition claire du périmètre pris en compte dans le cadre de l'étude. Cela se traduit par la sélection du type de projet Power-to-Gas, en établissant les ressources d'entrée et de sortie avec leurs sources ou destinations et identifiant l'infrastructure nécessaire de transport. C'est en fait l'étape dans laquelle le projet est défini et tous les détails importants sont fixés.
- k. Entrée de données– dès que le projet Power-to-Gas est défini, il est le moment d'initier la collection de toutes les informations qui sont nécessaires pour la construction de l'argument commercial complet. Le cadre actuel d'analyse prend en compte des données historiques (mais les plus récentes et pertinentes possibles) concernant la production et les prix de l'énergie. On peut diviser ce processus en trois catégories principales:
 - Entrée de données techniques – des données essentielles d'entrée concernant la production de l'énergie renouvelable disponible (au moins une production d'énergie par heure des sources d'énergie renouvelable pour couvrir une période d'au moins une année). Dans le cas où le marché d'équilibrage est considéré comme inclus dans le périmètre, des données relatives à la fréquence d'événements et demandes sur ce marché devraient être pris en considération.
 - Données économiques– des prix du marché d'énergie correspondant à la période de production de l'énergie des sources d'énergie renouvelable représentent l'élément le plus important de cette catégorie. En plus, il est d'important d'analyser les prix de toutes les ressources impliquées, primaires ou secondaires (prix du gaz naturel, dioxyde de carbone, oxygène, chaleur etc.). Les coûts de transport, aussi bien que des indicateurs financiers divers (taux d'escompte, coûts d'assurance, impôts, frais etc.) doivent être pris en considération à cette étape.
 - Données de législation et politique – la rentabilité économique d'un Power-to-Gas est potentiellement influencée par des mesures de soutien imposées par la politique locale. Au niveau européen, chaque pays a développé son propre set de règles et orientations pour appuyer l'énergie renouvelable [document on RE support] et, en quelques cas, des solutions de stockage de l'énergie [France]. En plus, il y a aussi des contraintes juridiques légales qui doivent être confirmées en ce qui concerne les marchés d'énergie, l'injection dans le réseau de gaz naturels ou d'électricité.
- l. Seuil de prix à l'énergie & scénarios de capacité– l'élément clé du cadre d'analyse consiste en la sélection des seuils de prix d'énergie en conjonction avec des scénarios de capacité installée afin d'obtenir le dimensionnement technique optimal du projet Power-to-Gas en fonction de l'indicateur économique désiré. A cette étape, il est essentiel d'établir une stratégie opérationnelle et déterminer l'entrée disponible

d'énergie de la ferme éolienne qui sera alimentée au fluxe Power-to-Gas. Pour faire cela, plusieurs seuils de prix d'électricité sur le marché sont choisis et la stratégie d'opération consiste:

- Toute l'électricité offerte à un prix inférieur au seuil imposé est redirigé vers le procès d'électrolyse du fluxe Power-to-Gas,
- L'électricité offerte à un prix supérieur au seuil est vendue sur le marché d'énergie et alimentée au réseau.

La quantité d'énergie disponible pour Power-to-Gas peut être considérée comme énergie excédentaire ou énergie à valeur basse qui a le potentiel d'être mieux valorisée par sa conversion, dans le fluxe Power-to-Gas. Afin d'établir la stratégie d'opération et choisir la dimension la plus efficace de l'électrolyser et les composantes supplémentaires du fluxe technique, chaque énergie de seuils de prix d'énergie est divisé en plusieurs autres sous scenarios définis par la capacité installée des unités d'électrolyse.

- m. Analyse technique et économique de niveau supérieur - comme résultat du pas antérieur, une gamme de scenarios sur la base des seuils différents de prix d'énergie et capacités différentes d'électrolyseurs doivent être analysées et comparées. Un indicateur économique qui représentera la base de comparaison entre les différents scenarios est nécessaire. Le coût actualisé de l'énergie (Levelized Cost of Energy - LCOE) tel que défini par [Fraunhofer 2013] est l'indicateur suggéré par le cadre actuel d'analyse pour choisir qui sont les scenarios optimales qui seront évalués en détail dans les étapes suivantes. L'objectif sera par conséquent de minimiser le coût de l'énergie parce que cela maximisera le profit. En ce moment, uniquement une évaluation de niveau supérieur des scenarios est réalisée, par conséquent les résultats obtenus sont utilisés seulement dans des buts de comparaison, sans insister sur les valeurs absolues. En ce qui concerne la thèse présente, cette approche a été utilisée pour évaluer le cas de la Roumanie. De manière alternative, ce pas de la stratégie peut être réalisé par l'emploi d'un logiciel d'optimisation qui permettra l'analyse d'un bon nombre de scenarios et sous-scenarios (une palette plus vaste du seuil des prix d'énergie et capacités installées des électrolyseurs) afin d'obtenir une indication plus précise du scenario. Cette approche alternative a été utilisée pour évaluer Power-to-Gas dans le contexte européen.
- n. Choix des scenarios potentiellement viables – les scenarios les plus favorables fondés sur les résultats du LCOE de l'analyse technique et économique de haut niveau sont choisis. En cas de l'analyse des voies multiples Power-to-Gas, le choix sera prix pour chacun d'entre eux.
- o. Analyse technique et économique détaillée – les scenarios sélectionnés dans l'étape antérieure sont optimisés du point de vue technique (en prenant en compte des données plus spécifiques concernant les équipements et qui sont utilisées, en analysant toutes les possibles synergies et accordant une valeur aux ressources secondaires telles que

l'oxygène ou la chaleur). Au centre de l'analyse détaillée se trouve un modèle d'analyses de la valeur actualisée des flux de trésorerie (Discounted Cash Flow) [13], une méthode d'évaluation qui utilise des projections actualisées de flux de trésorerie futurs réduites à une valeur actuelle, ciblant le calcul des indicateurs économiques utilisés à large échelle pour des investissements faits en Power-to-Gas: Valeur Actuelle Nette (NPV - Net Present Value) et Taux de Rendement Interne (IRR - Internal Rate of Return). La partie la plus importante du modèle DCF consiste à calculer les investissements initiaux et établir les profits et pertes pour chaque voie.

p. Obtention des indicateurs NPV et IRR et de la décision en matière d'investissement – la dernière étape du cadre proposé d'analyse consiste à analyser les indicateurs NPV et IRR obtenus du modèle DCF et les comparer avec les cibles imposées par l'investisseur. Si les indicateurs sont au-dessus du seuil qui suggère qu'un investissement est rentable, le projet Power-to-Gas peut être pris en considération pour l'investissement. Pourtant, si les indicateurs se trouvent au-dessous du seuil, le procès d'évaluation continue avec la fixation des cibles qui s'imposent pour atteindre la faisabilité économique. Ces cibles peuvent être:

- Cibles techniques– augmentations dans l'efficience du procès et l'efficience de la stratégie opérationnelle, mise à profit des possibles synergies qui vont affecter l'efficience globale.
- Cibles économiques– améliorations relatives au coût de la technologie, l'évolution des prix du marché de l'énergie, des prix des ressources secondaires ou avantages qui peuvent soutenir un déploiement plus facile du marché pour la technologie.
- Mesures de politique– identifier les nouvelles mesures potentielles destinées à faciliter ou accélérer le déploiement de la technologie Power-to-Gas (par exemple une part de hydrogène renouvelable ou gaz naturel de synthèse (SNG) renouvelable ou avantages en matière de captation de carbone) et établir leur niveau d'avantages au seuil nécessaire pour un argument commercial positif pour les investisseurs.

Le cadre décrit d'analyse sera appliqué dans l'étude de la possibilité de mettre à profit Power-to-Gas dans les cas de la Roumanie et de la France, où il sera décrit en détail dans une manière graduelle pratique.

7. PROCÈS DE MÉTHANISATION

MODÉLISATION DU PROCÈS DE MÉTHANISATION

La synthèse du méthane à partir du dioxyde de carbone et hydrogène a été prise en considération, sur la base du procédé TREMP (Topsoe's Recycle Energy-efficient Methanation Process) développé par Haldor-Topsoe [Topsoe 2009], [Haldor Topsoe 2011]. Ce procédé a été utilisé pour obtenir le gaz naturel de synthèse (SNG). En plus, les conditions d'opération ont été déterminées de telle manière à maximiser la sélectivité du méthane et à assurer que la température maximale permise par le catalyseur n'est pas dépassée lors de la réaction adiabatique du réacteur. Le design conceptuel a été évalué par les simulations rigoureuses Aspen Plus afin de prédire l'effet des paramètres clé de la conception sur la température de la réaction et la pureté du produit gaz naturel de synthèse et évaluer la faisabilité économique actuelle du procès de méthanisation.

Propriétés physiques

Les propriétés physiques (tels que les paramètres critiques, l'enthalpie et l'énergie libre de formation Gibbs etc.) de toutes les composantes sont disponibles dans la base de données de composantes pures component d'Aspen Plus [Aspen Technology 2010]. Comme le processus a lieu dans la phase gazeuse, à pression et température hautes, seulement le comportement non-idéal du mélange doit être pris en considération.

Par conséquent, l'équation d'état de Peng-Robinson a été employée comme modèle de propriétés appropriées pour le système. Observez que les réactions entraînant la formation de carbone sont négligées, parce que leur étendue est limitée suite à la sélectivité du catalyseur.

Le schéma simplifié de procédé pour la méthanisation du dioxyde de carbone décrite en Figure 7.4 comprend un, deux ou plusieurs réacteurs catalytiques, opérés de manière adiabatique, dans lesquels les réactions décrites dans l'Eq. (1-3) ont lieu. Le taux de réaction est influencé par le nombre de réacteurs. Dans chaque réacteur, le procès s'approche des conditions d'équilibre. Comme le procès est exothermique, le mélange de la réaction est refroidi après chaque réacteur afin de permettre l'augmentation supplémentaire de la conversion. Le rapport stœchiométrique est $\text{CO}_2:\text{H}_2 = 1:4$ Eq. (1), mais la réaction peut être réalisée avec un excédent de chaque réactant.

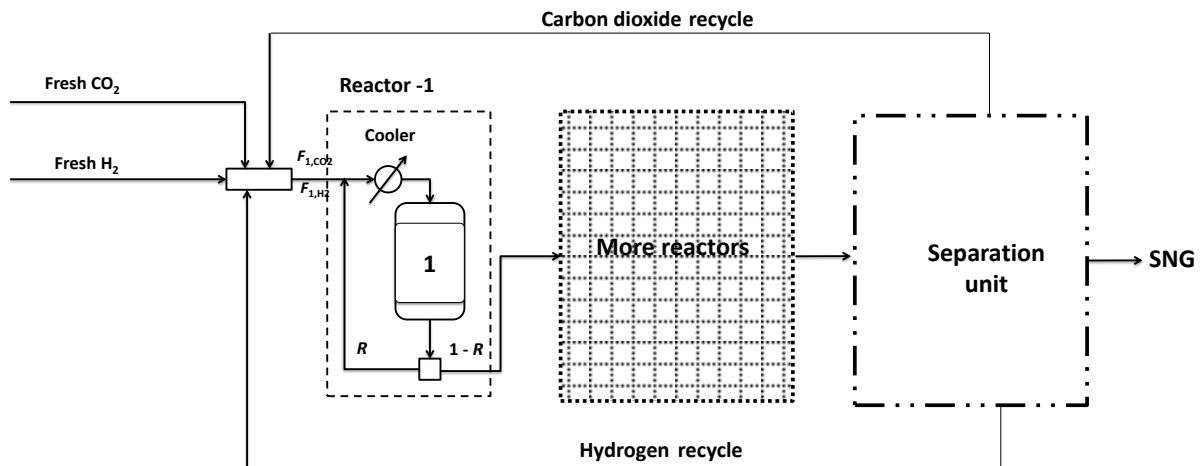

Figure 7.1 Représentation schématique du procédé de méthanisation à partir du dioxyde de carbone et hydrogène

Les réacteurs adiabatiques ont été simulés en employant Aspen Plus par le modèle GIBBS, qui calcule l'équilibre chimique à travers la minimisation de l'énergie libre Gibbs du mélange. Le dioxyde de carbone est mélangé avec hydrogène et après alimenté dans le premier réacteur. Suite à la réaction hautement exothermique, le premier réacteur a une conception spéciale: une partie de l'effluent du réacteur est recyclée de nouveau à l'entrée du réacteur, mélangé avec des réactants (frais et recyclés) et refroidis à une température appropriée (suffisamment haute pour initier la réaction). C'est ainsi que cet effet de la dilution entraîne une augmentation plus basse de la température au long du lit du réacteur. Les plus importants deux paramètres de conception sont le rapport entre les réactants à l'entrée du premier réacteur, $F_{1,CO_2}/F_{1,H_2}$ et la fraction de l'effluent du réacteur qui est recyclé— R , où F_{1,CO_2} et F_{1,H_2} représente le débit molaire de CO₂ et H₂, kmol/h. Le rapport du recycle— R est défini comme le débit molaire entre le gaz recyclé et le courant quittant le lit du réacteur.

Pour le cas présent, le débit frais H₂ d'entrée dans l'installation a été spécifié à 30 bars et 303 K, et correspond à la production nominale d'un électrolyseur de 10 MW (54 kmol/h H₂). Afin d'obtenir la convergence de schéma de procédé, une unité DESIGN SPECIFICATION a été employée afin d'ajuster le débit frais CO₂ nécessaire pour garder le rapport du débit désiré CO₂/H₂ à l'entrée du premier réacteur. Comme attendu, le débit correspondant de dioxyde de carbone frais (obtenu suite à la simulation), 13 kmol/h (589 kg/h) à 30 bar et 303 K, était très proche de la valeur stœchiométrique.

La simulation Aspen Plus finit avec une analyse de la sensibilité qui utilise le modèle réacteur afin de comprendre l'effet de la température de la réaction, la concentration des réactants et le

rapport du recycle sur la température maximale du réacteur. L'analyse de la sensibilité montre que l'augmentation dans le rapport du recycle R entraîne une diminution de la température maximale. Figure 7.5 présente la température maximale dans le lit du premier réacteur versus le rapport des réactants $F_{1,CO_2}/F_{1,H_2}$, calculé pour une température d'entrée de 573 K et diverses valeurs de la fraction du recycle R . La pression de la réaction a été établie à 30 bars. Conformément à la littérature de spécialité, les températures hautes affectent la stabilité du catalyseur. Comme attendu, l'analyse de la sensibilité (Figure 7.5) montre que l'augmentation dans le rapport du recycle entraîne une réduction de la température maximale.

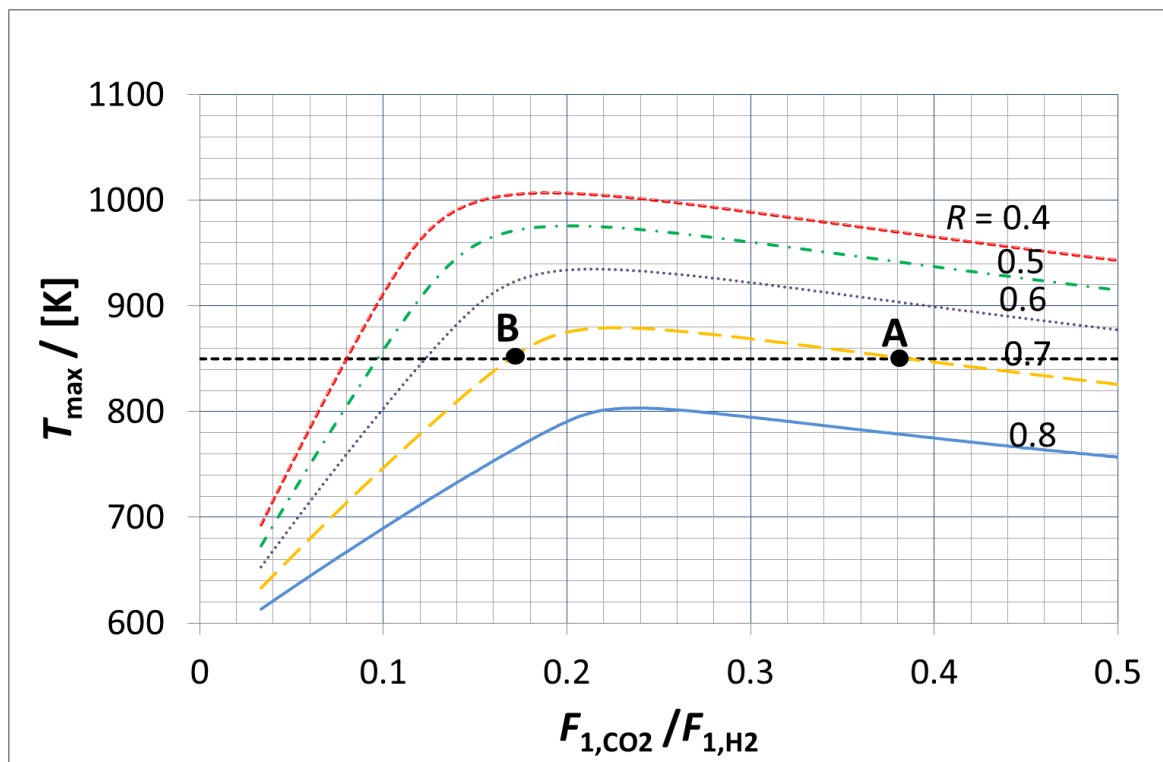

Figure 7.2 Température maximale du lit du premier réacteur versus le rapport des réactants $F_{1,CO_2}/F_{1,H_2}$, à diverses valeurs de la fraction du recycle R

Afin d'obtenir un contenu haut en méthane il est très important de définir le rapport du recycle R et le débit du dioxyde de carbone. En conséquent, les résultats obtenus, présentés en Tableau 7.3, indiquent qu'à $R = 0.7$, la température de sortie du premier réacteur est 850K. Sous cette valeur du R , la température haute pourrait détruire le catalyseur. Un recycle plus haut entraîne des coûts plus élevés (réacteur large, compresseur du recycle).

En plus, Figure 7.5 montre que la même température maximale peut être obtenue dans deux méthodes différentes. Ces deux points d'opération, dénotés par A et B (pour $R=0.7$, à 850K) ont été pris en considération pour une analyse supplémentaire:

- Cas A: implique une haute conversion de l'hydrogène suivie par la séparation du dioxyde de et le recycle (CO_2 excédentaire – en ce qui concerne le rapport stœchiométrique $\text{CO}_2/\text{H}_2 = 0.25$)
- Case B: implique une haute conversion du dioxyde de carbone suivie par la séparation de l'hydrogène et le recycle (H_2 excédentaire - en ce qui concerne le rapport stœchiométrique $\text{CO}_2/\text{H}_2 = 0.25$).

Par conséquent, du point de vue de l'opération et du contrôle, l'option préférée est de concevoir le système pour la conversion presque complète d'un réactant (par exemple, hydrogène en cas A), qui peut être obtenue par un excès de l'autre réactant (par exemple, dioxyde de carbone en cas A). Cas B entraîne la séparation de l'hydrogène et son recycle. Les membranes de séparation H_2 représentent une potentielle voie comprenant les coûts élevés de capital et d'exploitation, alors que le système d'extraction CO_2 en employant des amines (cas A) est une solution viable du point de vue technique.

Tableau 7.1 Effet du rapport du recycle sur la composition du gaz et les conditions d'exploitation à la sortie du premier réacteur de méthanisation et sur la composition gaz naturel de synthèse (SNG)

Courant	Rapport du recycle				
	0.4	0.5	0.6	0.7	0.8
SORTIE RÉACTEUR-1					
Débit molaire total (kmol/h)	102.067	119.744	145.827	171.106	277.041
Débit massique total (kg/h)	2160.25	2592.41	3240.33	3421.914	6480.63
Température (K)	943	915	877	850	756
Pression (bar)	30	30	30	30	30
Composition (mole%)					
CO₂	22.21248	23.15986	24.11025	16.311	25.19671
H₂	18.01989	15.43705	12.23036	12.154	4.7775
CH₄	16.08042	17.59318	19.37452	22.911	23.0338
H₂O	37.92399	39.49834	41.51724	47.222	46.5317
CO	5.76321	4.31157	2.76762	1.402	0.460278
PRODUIT gaz naturel de synthèse (SNG)					
Débit molaire total (kmol/h)	14.123	13.957	13.836	13.848	13.728
Débit massique total (kg/h)	215.930	216.072	216.206	216.304	216.375
Température (K)	298	298	298	298	298
Pression (bar)	30	30	30	30	30

Composition (mole%)					
CO ₂	0	0	0	0	0
H ₂	5.56537	4.128	3.04597	3.096	2.05821
CH ₄	94.06404	95.582	96.71027	96.709	97.72919
H ₂ O	0.180112	0.18126	0.182104	0.189	0.182855
CO	0.190477	0.10873	0.061654	0.032	0.029742

L'analyse de la sensibilité a été réalisée afin d'évaluer et prédire le comportement de l'installation au moment du changement des variables clé d'exploitation et conception. Les conversions de l'hydrogène et du dioxyde de carbone et la sélectivité du méthane, sur la base des débits de toutes les composantes ont été calculées.

Des représentations typiques des conversions CO₂ et H₂ versus le débit du CO₂ à l'entrée du premier réacteur ($F_{1,H_2} = 54$ kmol/h) sont illustrées en Figure 7.6 et Figure 7.7. On devrait remarquer que la fixation du débit du CO₂ égale à la valeur stœchiométrique $F_{1,CO_2} = 13$ kmol/h entraîne des conversions sous la valeur 0.95, pour tous les deux réactants. Cela entraîne des concentrations CO₂ et H₂ dans le gaz naturel de synthèse SNG qui sont au-dessus du seuil maximal permis, la séparation de tous les deux réactants étant en conséquent nécessaire. En plus, maintenir le rapport de débits frais H₂:CO₂ à la valeur nécessaire 4:1 est difficile en pratique, à cause des insurances de mesurage et contrôle.

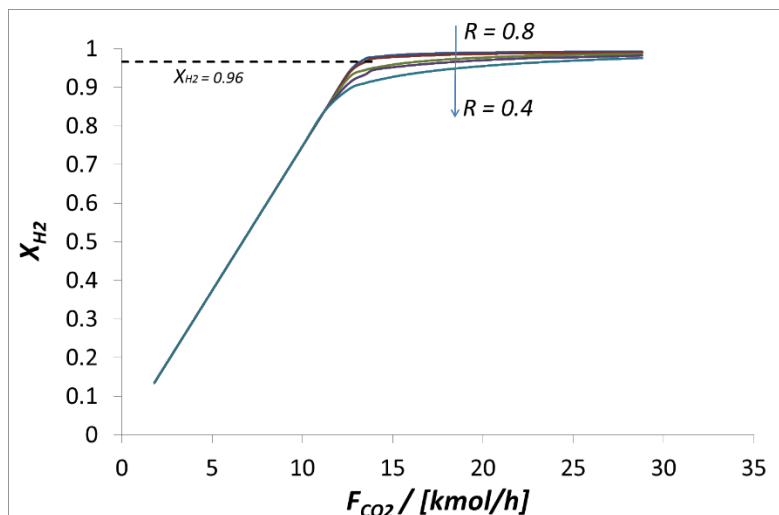

Figure 7.3 Conversion H₂ versus le débit de dioxyde de carbone à l'entrée du premier réacteur-à un rapport différent du recycle. $F_{1,H_2} = 54$ kmol/h (108 kg/h)

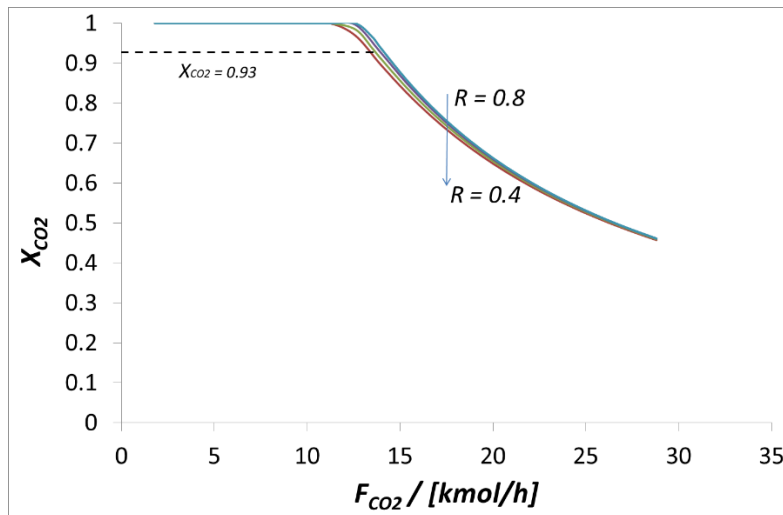

Figure 7.4 Conversion CO_2 versus le débit de dioxyde de carbone à l'entrée du premier réacteur à un rapport différent du recycle. $F_{1,H_2} = 54$ kmol/h (108 kg/h)

Design conceptuel

Le travail au (ou proche du) rapport stœchiométrique n'assure pas la haute conversion de tous les deux réactants, par conséquent, sont nécessaires deux unités de séparation (l'une pour H_2 et l'une pour CO_2). Par conséquent, la conception de l'installation pour un dioxyde de carbone excédentaire est préférable, vu que cela implique la conversion presque complète de l'hydrogène, avec les résultats d'une seule unité de séparation et un seul recycle. Après le premier réacteur, le mélange de la réaction est refroidi avant d'être envoyé au second réacteur (case A et B). La séquence refroidissement – réaction est répétée au troisième réacteur (cas A). Finalement, le mélange de la réaction est refroidi à une température qui est suffisamment basse pour permettre la condensation de l'eau et en conséquence séparation vapeur – liquide (séparation VL). La phase liquide collecte de l'eau, aussi bien que des gaz dissolus. L'eau produite dans le procès peut être collectée et réutilisée. Les échangeurs de chaleur HE-1, HE-2, HE-3, HE-4, HE-4A, HE-4B, fournissant un courant à des niveaux différents de pression. Les échangeurs de chaleur ont été modélés en tant qu'unité HEATER, ce qui permet l'estimation de la charge de la chaleur. Finalement, le modèle de compresseur a offert l'énergie nécessaire pour l'augmentation de la pression CO_2 et H_2 et le recycle.

Figure 7.8 présente le schéma de procédé Aspen Plus pour la méthanisation de CO_2 qui implique la séparation totale du dioxyde de carbone des produits. Dans ce cas, pour la conversion presque complète H_2 , trois réacteurs catalytiques ont été utilisés. La séparation CO_2 a été réalisée par absorption/désorption en utilisant une solution aqueuse d'éthanolamine. Le

dioxyde de carbone excédentaire est recyclé au premier réacteur via un compresseur. Après la séparation du CO₂, est obtenu le gaz naturel de synthèse (SNG).

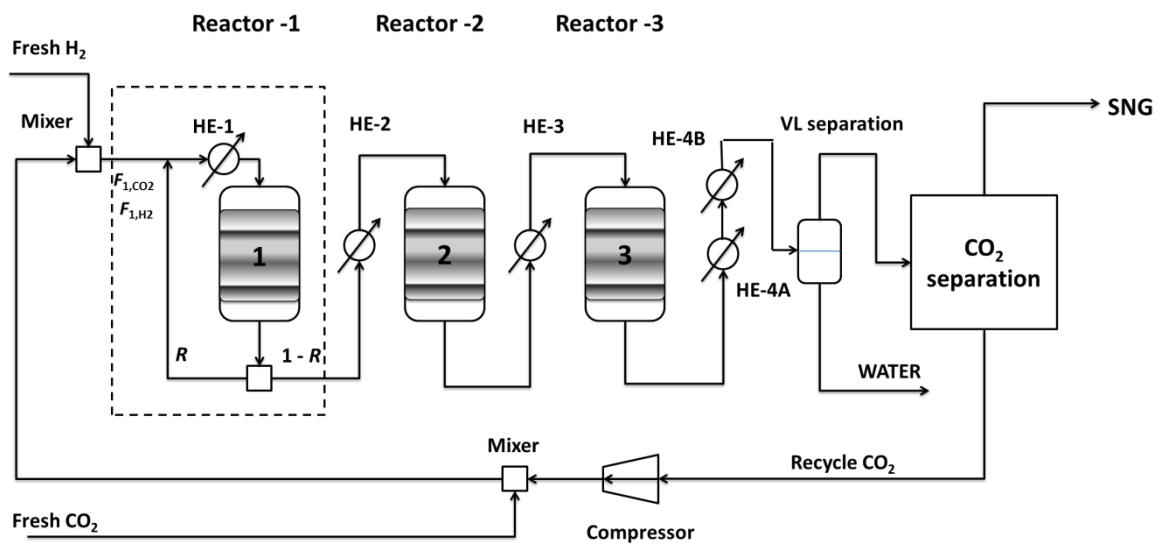

Figure 7.5 Schéma de procédé de méthanisation de CO₂ (séparation CO₂– recycle)

Pour obtenir une vue d'ensemble complète, de diverses simulations ont été réalisées par l'emploi de cinq scénarios différents sur la base de débits différents de hydrogène: 110.58 kg/h (55.425 kmol/h); 107.91 kg/h (53.955 kmol/h); 103.4 kg/h (51.7 kmol/h); 99.7 kg/h (49.85 kmol/h) et 77.83 kg/h (38.915 kmol/h) obtenu pour une unité d'électrolyse 10 MW, qui correspondent aux études de cas présentés en détail dans l'évolution technique et économique de Power-to-Gas.

8. MISE À PROFIT DU POWER-TO-GAS DANS LE CAS DE LA ROUMANIE

Afin d'établir le dimensionnement des deux voies Power-to-Gas prises en considération pour le cas de la Roumanie, il est important de décider la quantité d'énergie redirigée de la production d'énergie totale du parc éolien aux unités d'électrolyse qui font partie de la chaîne Power-to-Gas.

En respectant les orientations du cadre d'analyse Power-to-Gas présentées dans le chapitre antérieur, plusieurs seuils de prix pour l'électricité vendue sur le marché -du lendemain sont imposés: 20, 30, 40, 50, 60 et 70 Euro/MWh. La stratégie d'opération est la suivante:

- Toute l'électricité produite par le parc éolien à un prix inférieur le seul imposé de prix est redirigée aux unités Power-to-Gas
- L'énergie à un prix supérieur au seuil imposé est vendue sur le marché de l'énergie et injectée dans le réseau.

Pour le cas de la Roumanie, plusieurs sous-scenarios sont créés en analysant les différentes dimensions pour les unités d'électrolyse: 10, 20, 30, 40 et 50 MW. En conjonctions avec les scenarios créés en imposant des seuils de prix d'énergie, cette stratégie entraîne un total de 30 qui doivent être simulés et évalués pour chaque voie Power-to-Gas, Hydrogène et gaz naturel de synthèse SNG dans l'analyse technique et économique de haut niveau.

Les projets Power-to-Gas sont modélés en ODYSSEY, un logiciel développé par CEA Liten pour l'évaluation des applications de stockage de l'énergie [Guinot et al. 2013], comme présenté en Figure 8.3. En employant ODYSSEY, la quantité d'énergie fournie aux unités d'électrolyse sur la base de la stratégie présentée antérieurement est calculée, aussi bien que les paramètres de procès du procès d'électrolyse: énergie et eau d'entrée, hydrogène et oxygène de sortie. Afin de simuler le comportement des unités d'électrolyse, celles-ci sont modélées en ODYSSEY sur la base des indicateurs clé de performance présentée en Tableau 8.2. Dès que la sortie hydrogène des unités d'électrolyse est calculée, les scenarios doivent être comparés sur la base d'un indicateur technique et économique qui indiquerait le scenario optimal en matière de dimensionnement de l'unité d'électrolyse et stratégie d'opération.

Tableau 8.1 Indicateurs clé de performance du procès d'électrolyse utilisés pour la simulation technique et économique de haut niveau

	Valeur	Unité	Référence
Technologie	Alcaline		[Bertuccioli et al. 2014]
Entrée électricité	53	kWh _{el} /kgH ₂	
Efficienc e LHV	62	%	
Charge minimale	20	% de charge pleine	
Pression sortie H ₂	30	bar	
Température d'opération	70	Celsius	
Disponibilité	8585	Heures/année	
Dépenses d'investissent (CAPEX)	900	Euro/kW	
Dépenses d'exploitation (OPEX)	2.2% of CAPEX	Euro/année	

L'indicateur qui a été choisi pour représenter la base de comparaison entre tous les scenarios définis antérieurement est le LCOE - Levelized Cost of Energy, tel que défini par [Kost et al. 2013] et calculé par l'emploi de la formule suivante:

$$LCOE = \frac{CAPEX + \sum_{t=1}^n \frac{Coût OPEX + Energie}{(1+i)^t}}{\sum_{t=1}^n \frac{Quantité Energie}{(1+i)^t}} \text{ [Euro/MWh]}$$

Les résultats de l'analyse/dimensionnement technique de haut niveau de la voie Hydrogène Power-to-Gas sont présentés en Tableau 8.4 et Figure 8.4:

Tableau 8.2 LCOE de la voie Hydrogène Power-to-Gas

		Prix de l'énergie [Euro]					
Dimension électrolyseur		20	30	40	50	60	70
LCOE [Euro/MWh]	10 MW	444.36	101.62	86.94	80.80	80.41	79.95
	20 MW	214.94	113.88	96.23	87.85	86.90	86.97
	30 MW	244.69	129.18	107.59	96.51	94.90	94.58
	40 MW	281.04	146.65	120.63	106.51	104.16	103.43
	50 MW	332.06	169.86	137.74	119.60	116.28	115.03

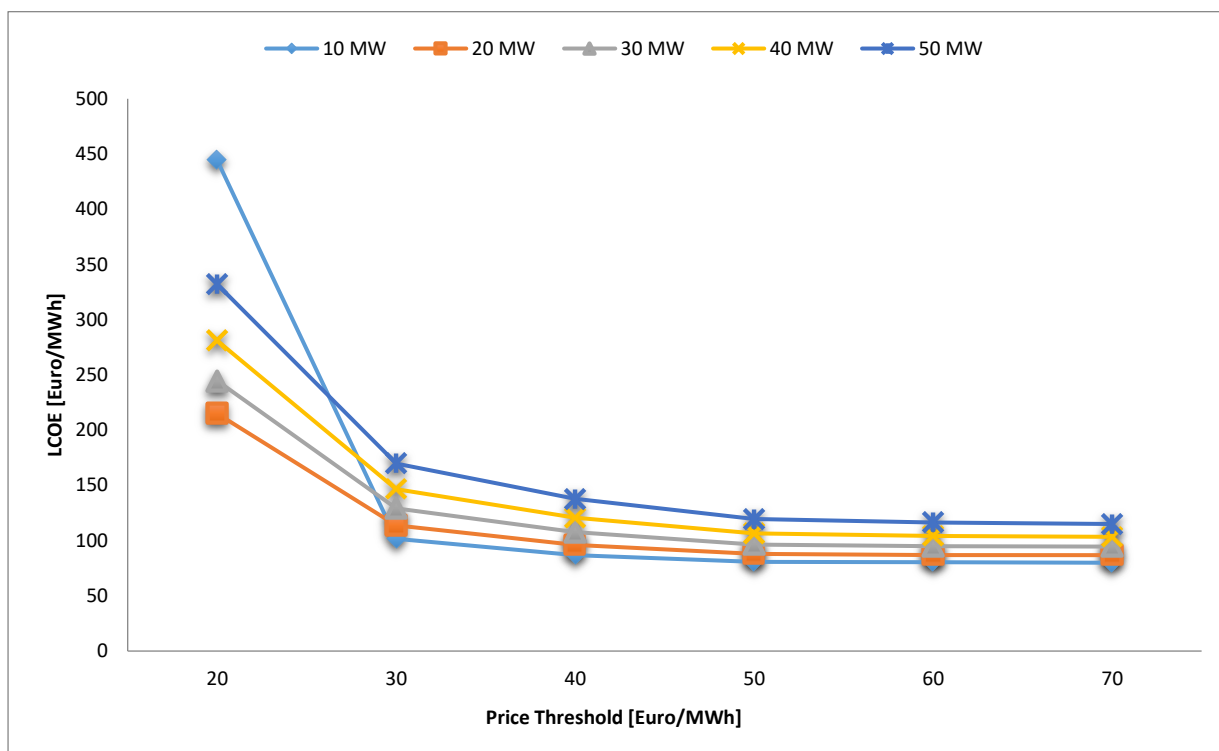

Figure 8.1 Levelized Cost of Energy en fonction des valeurs différentes du seuil de prix sur le marché d'énergie dans la voie Hydrogène Power-to-Gas

Les résultats de l'analyse/dimensionnement technique de haut niveau de la voie gaz naturel de synthèse (SNG) Power-to-Gas sont présentés en Tableau 8.5 et Figure 8.5:

Tableau 8.3 LCOE de la voie gaz naturel de synthèse (SNG) Power-to-Gas

		Prix de l'énergie [Euro]					
		20	30	40	50	60	70
LCOE [Euro/MWh]	Dimension électrolyseur						
	10 MW	647.14	163.39	140.53	130.05	129.54	127.71
	20 MW	319.67	173.15	147.67	134.26	133.04	133.13
	30 MW	352.22	193.06	162.46	144.32	142.21	140.55
	40 MW	397.10	214.58	176.96	157.33	153.02	152.07
50 MW	463.53	244.80	198.00	173.14	168.82	167.19	

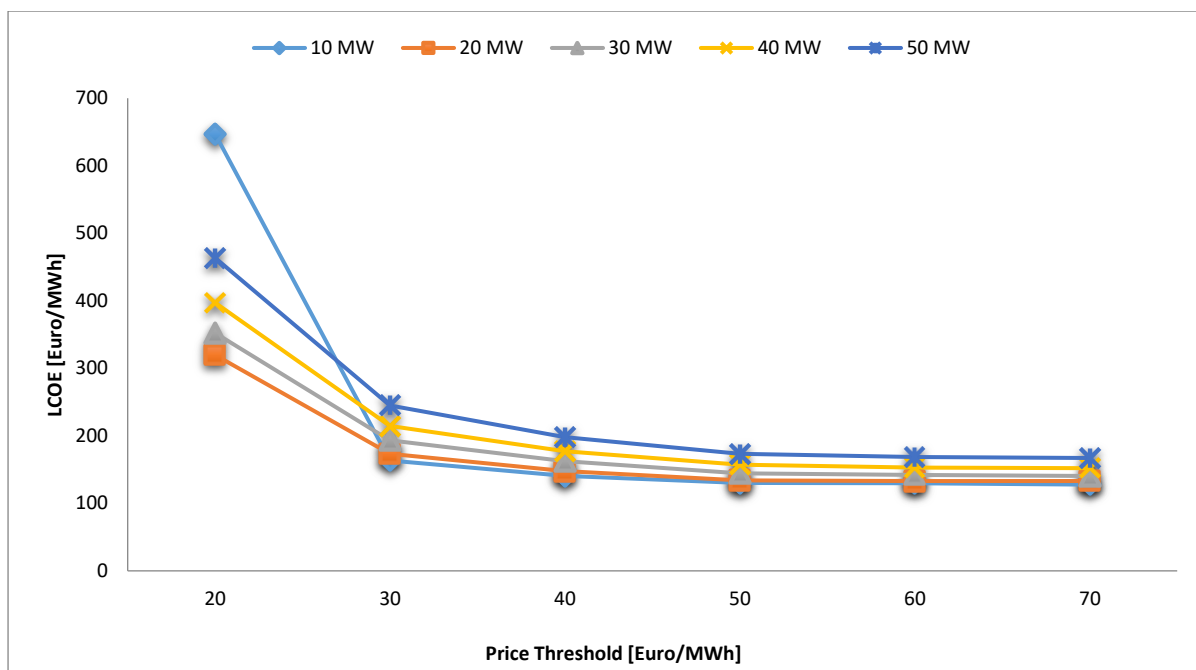

Figure 8.2 Levelized Cost of Energy en fonction des valeurs différentes du seuil de prix sur le marché d'énergie dans la voie gaz naturel de synthèse (SNG) Power-to-Gas

Tableau 8.4 et 8.5 avec Figure 8.4 et 8.5 indiquent le dimensionnement optimal des scénarios de la stratégie d'opération:

- Hydrogène Power-to-Gas– des scénarios pris en considération, la plus efficiente solution du point de vue économique est d'avoir une installation d'électrolyse à capacité installée de 10 MW qui opérerait sur un seuil de prix de 70 Euros/MWh, se traduisant par un LCOE de 79.95 Euros/MWh de hydrogène renouvelable injecté dans le réseau de gaz naturels. Ce scénario sera utilisé en tant que le dimensionnement de référence pour la voie Hydrogène.
- Gaz naturel de synthèse (SNG) Power-to-Gas– pour cette voie le sous scénario le plus faisable du point de vue économique est de nouveau l'électrolyseur à capacité installée de 10 MW et seuils de prix de l'énergie électrique de 70 Euros/MWh qui entraîne un LCOE de 127.71 Euros/MWh de gaz naturel de synthèse (SNG) renouvelable. Ce scénario sera utilisé en tant que dimensionnement de référence pour la voie gaz naturel de synthèse (SNG).

Pour toutes les voies mentionnées antérieurement le scénario optimale consiste à utiliser une unité d'électrolyse de 10 MW avec un seuil des prix de 70 Euros/MWh, entraînant une production moyenne par heure de l'hydrogène de l'installation d'électrolyse de 107.9 kg H₂/h à 30 bar, une figure utilisée pour le dimensionnement du procès de méthanisation dans la voie gaz naturel de synthèse (SNG) Power-to-Gas. Le dépassement du seuil de l'énergie de 70 Euros/MWh n'entraîne pas un LCOE plus bas vu que moins de 0.5 % de la production de

l'énergie du parc éolien est fixé au-dessus de cette valeur. Dans le scénario optimal, le facteur de capacité des unités d'électrolyse augmente à un niveau de 70.92%

Les résultats du dimensionnement technique peuvent être expliqués par les coûts initiaux hauts d'investissement en capital des composantes de la technologie Power-to-Gas, en particulier l'électrolyse et la méthanisation, et le fait qu'afin d'amortir ces coûts sur la base MWh, les unités de doivent opérer aussi longtemps que possible, ce qui signifie qu'elles ont besoin d'être alimentées en plus énergie que possible des sources renouvelables et dans ce cas elles ne fonctionnent plus sur la base de ce l'on appelle d'habitude électricité "excédentaire".

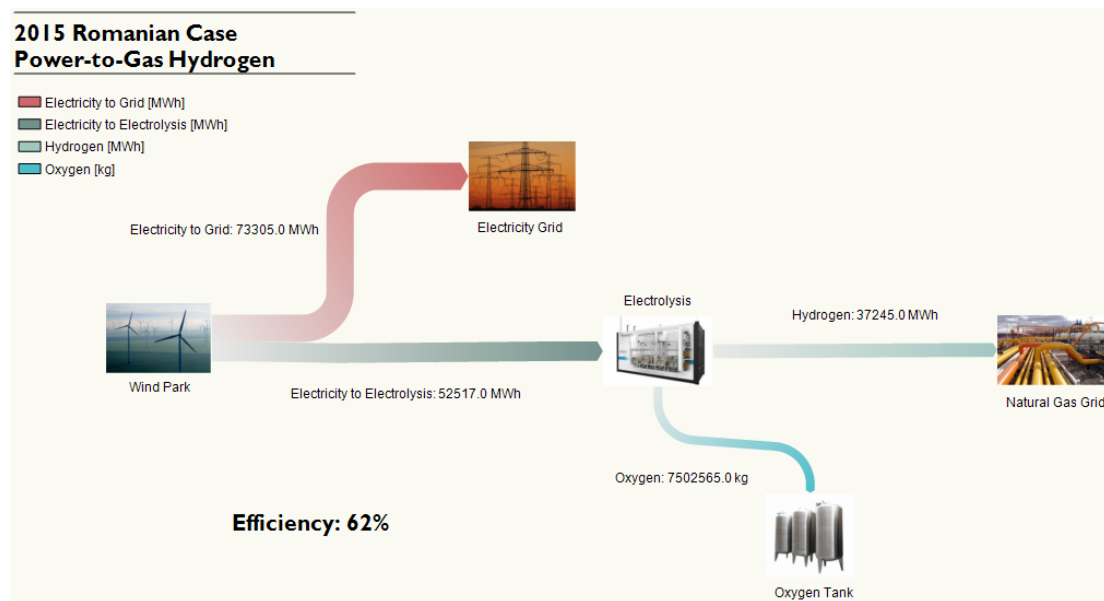

Figure 8.3 Bilan énergétique de l'Hydrogène Power-to-Gas dans le cas de la Roumanie

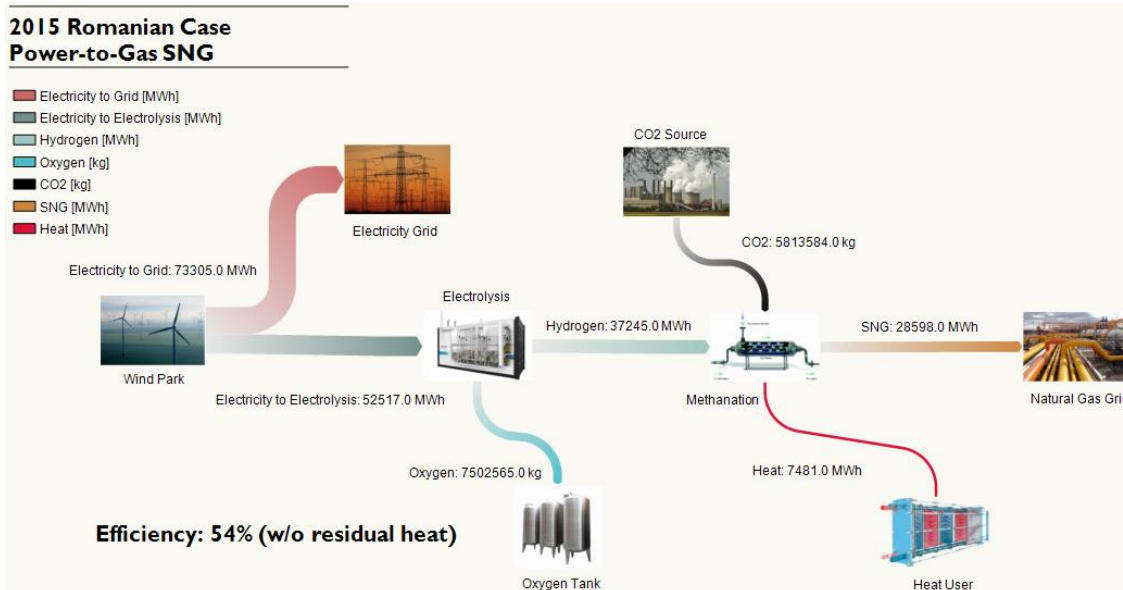

Figure 8.4 Bilan énergétique du gaz naturel de synthèse (SNG) Power-to-Gas dans le cas de la Roumanie

Les figures présentés ci-dessus décrivent une vue graphique d'ensemble du bilan énergétique résultant du dimensionnement technique des deux scénarios sélectionnés Power-to-Gas pour le cas de la Roumanie, en révélant les principaux flux d'énergie et matériel qui seront utilisés dans l'analyse économique. En même temps, il est important de souligner l'efficacité calculée globale du scénario Hydrogène Power-to-Gas de 62% et l'efficacité plus basse (suite aux transformations de l'énergie supplémentaire) du gaz naturel de synthèse (SNG) Power-to-Gas de 54% si la chaleur résiduelle n'est pas prise en considération. Pourtant, si la chaleur résiduelle du procès de méthanisation est prise en considération lors du calcul de l'efficacité, le gaz naturel de synthèse (SNG) Power-to-Gas a une efficacité plus élevée (68%) par rapport à l'Hydrogène Power-to-Gas, au moins pour le périmètre pris en considération dans le cadre de la Thèse, où le captage CO₂ n'est pas compris.

Conformément à [Kost et al. 2013], une méthode d'analyse se fondant sur le LCOE n'est pas approprié pour établir l'efficacité en matière de coûts d'un projet Power-to-Gas, par conséquent une analyse économique complète doit être réalisée par l'emploi d'un modèle d'évaluation actualisé des flux de trésorerie (Discounted Cash Flow - DCF) qui prend en compte tous les courants en matière de revenus et dépenses pour l'entière durée du projet. En essence, une analyse Discounted Cash Flow utilise des projections actualisées de flux de trésorerie futurs réduites auxquelles on applique un taux d'actualisation pour les apporter à une valeur actuelle. Cette approche offre des informations concernant le potentiel d'investissement ou l'attractivité d'une opportunité d'investissement. [Investopedia n.d.]. Conformément à [Damodaran n.d.], la formule de base utilisée pour une évaluation DCF est la suivante:

$$Valeur = \sum_{t=1}^n \frac{CF_t}{(1+r)^t}$$

Où

n – représente la durée de vie de l'actif

CF_t – représente les liquidités pendant la période t

r – représente le taux d'actualisation reflétant le risque (ou exigences en matière de rendement financier) associé avec les flux de trésorerie

Sur la base d'une communication avec [GDF Suez Energy Romania 2013a], un modèle d'évaluation *simplifié* actualisé des flux de trésorerie (Discounted Cash Flow) a été développé afin de réaliser l'analyse économique des deux scénarios sélectionnés pour la mise à profit du Power-to-Gas dans le cas de la Roumanie.

Hydrogène Power-to-Gas

Les sources de revenus sont calculées de manière annuelle et dans la voie Hydrogène du cas de la Roumanie de 2015 elles consistent en:

- Hydrogène injecté – l'hydrogène produit par le procès d'électrolyse est injecté dans le réseau de gaz naturels et évalué au prix du gaz naturel (voir Tableau 8.6).
- Oxygène – l'oxygène représente un produit secondaire du procès d'électrolyse et il peut être évalué pour environ 0.03 Euros/kg, un prix qui comprend tous les coûts nécessaires d'emballage et de transport.

Les sources des dépenses sont calculées de la manière suivante:

- Energie électrique – le prix payé pour l'énergie fournie aux unités d'électrolyse représente la dépense la plus importante du projet. Elle est calculée en multipliant la quantité d'énergie fournie aux électrolyseurs par le prix associé de l'énergie DAM.
- Remplacement de la pile – après l'unité d'électrolyse arrive à la fin de sa durée de vie, la pile doit être remplacée, engageant un coût significatif pour le projet (Tableau 8.6).
- OPEX – les dépenses d'exploitation pour les unités d'électrolyse (comme présenté en Tableau 8.6), aussi bien que ceux mentionnés antérieurement pour les éléments des composantes de l'Injection de l'Hydrogène.
- Assurance – les coûts liés à l'assurance sont évalués à 0.4% des CAPEX pour chaque année, en couvrant l'unité d'électrolyse.
- Contingences – on assume qu'un pourcent de 5% des dépenses totales par année couvrent des coûts inattendus qui apparaissent normalement lors de l'opération d'un

projet. Comme le coût de l'eau pour le procès d'électrolyse n'a pas été pris en considération dans une catégorie bien distincte, on peut supposer qu'il est compris dans cette catégorie.

L'étape finale du modèle d'évaluation DCF consiste dans le calcul de la valeur actuelle nette (NPV) du projet. Dans notre cas, la procédure est simplifiée par l'établissement direct d'un taux d'actualisation de 10% suite à [GDF Suez Energy Romania 2015]. L'indicateur (FCFF - Free Cash Flow for the Firm) est calculé par la soustraction de l'Impôt sur le revenu de l'indicateur EBITDA pour chaque année du projet. Finalement, l'indicateur valeur actuelle nette (NPV) est calculée en prenant en compte le flux de trésorerie en investissement (Investment Cash Flow), le FCFF annuel et le taux d'actualisation. Dans la voie Hydrogène cas de la Roumanie en 2015, la valeur actuelle nette (NPV -Net Present Value) of du projet est – 21 146 299 Euros pour un taux d'actualisation de 10 pourcents (Tableau 11).

Conformément à [Finance Formulas n.d.], la formule utilisée pour l'obtention de la valeur actuelle nette (NPV) est:

$$NPV = -C_0 + \sum_{i=1}^T \frac{C_i}{(1+r)^i}$$

où:

$C_0 =$ Fluxe de trésorerie en investissement

$C =$ fluxe de trésorerie

$r =$ taux d'actualisation

$T =$ durée de vie du projet

Si la valeur actuelle nette (NPV) est positive, cela signifie que le projet peut potentiellement apporter de la valeur à l'investisseur et l'investissement pourrait être accepté. Si la valeur actuelle nette (NPV) est négative, le projet entraînera des pertes pour la société et sera probablement rejeté. SI la valeur actuelle nette (NPV) est zéro, le projet n'apportera aucune valeur financière pour la société et la décision concernant l'investissement pourrait être prise sur la base d'autres critères (stratégiques, politiques etc.).

Le seuil de rentabilité, pour lequel la valeur de l'indicateur valeur actuelle nette (NPV) du projet est zéro (et le taux de rendement interne - IRR a la même valeur que le taux

d'actualisation, 10) est atteint pour un prix majoré de 68.1 Euros/MWh hydrogène renouvelable.

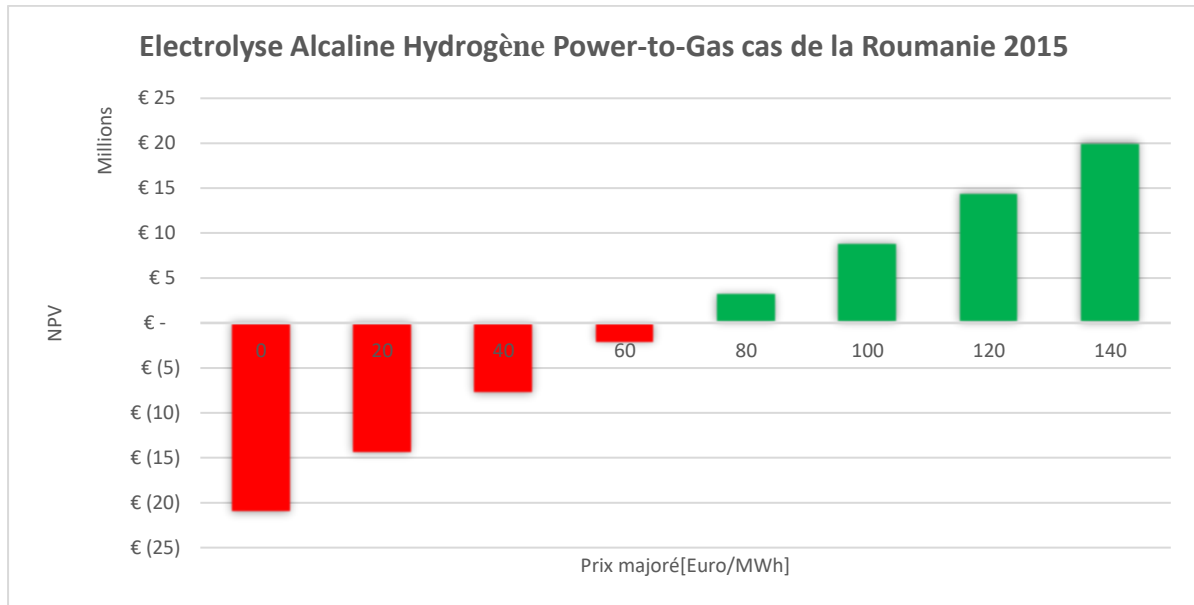

Figure 8.5 Influence Hydrogène Power-to-Gas des prix majorés sur la valeur actuelle nette (NPV) du projet cas de la Roumanie 2015

Le coût uniformisé total de la production de l'hydrogène est 3.78 Euros/kg, sans prendre en considération de prix majorés, les coûts les plus importants dérivant du coût de l'énergie électrique (moins le coût de l'oxygène vendu) – 47% et le CAPEX de l'unité d'électrolyse– 29%.

Gaz naturel de synthèse (SNG) Power-to-Gas

La seconde voie du cas de la Roumanie se concentre sur la route plus complexe de la production du gaz naturel de synthèse (SNG), une évolution de la voie présentée antérieurement, qui ajoute plusieurs composantes:

- Stockage de l'hydrogène– la sortie des unités d'électrolyse n'est pas constante, en fonction de l'entrée de l'énergie renouvelable. Par conséquent, afin d'assurer que le réacteur de la méthanisation garde un état constant d'opération (ce qui est préférable si l'on prend en considération des aspects de flexibilité), un réservoir pressurisé de stockage de l'hydrogène sera utilisé comme tampon entre l'étape d'électrolyse et celle de méthanisation.
- Unité de captage CO₂– le procès de méthanisation a besoin d'entrées d'hydrogène et dioxyde de carbone afin de produire le gaz naturel de synthèse (SNG). Pourtant, le procès de captage de CO₂ ne sera pas modelé dans cette analyse, en supposant qu'il est manipulé par une partie prenante externe, sans coûts pour le projet Power-to-Gas.

- Installation de méthanisation – responsable pour la production du gaz naturel de synthèse (SNG), seulement le modèle économique sera discutée en détail dans cette section. Une simulation technique complète de l’installation de méthanisation utilisée pour la simulation de ce projet a été présentée dans le chapitre dédié à cela.

L’étape Profits et Pertes de la voie gaz naturel de synthèse (SNG) cas de la Roumanie 2015 prend en compte les suivantes sources de revenus:

- Gaz naturel de synthèse (SNG) – comme sortie de la voie gaz naturel de synthèse (SNG) Power-to-Gas, le gaz naturel de synthèse (SNG) est injecté dans le réseau de gaz naturels sans limitations imposées par la limite de la concentration vu que les deux gaz sont presque identiques dans la composition. Par conséquent, au moment de l’injection, le gaz naturel de synthèse (SNG) est apprécié au prix du gaz naturel en tant que point de départ.
- Oxygène – représente un produit secondaire du procès d’électrolyse et il peut être évalué pour environ 0.03 Euros/kg, a prix comprenant tous les coûts nécessaires d’emballage et transport.
- Chaleur résiduelle– chaleur résiduelle provenant du procès de méthanisation est évalué à 30 Euros/MWh [GDF Suez Energy Romania 2013a].

La source des Dépenses est composée des catégories suivantes:

- Energie électrique– le prix payé pour l’énergie fournie aux unités d’électrolyse représente la dépense la plus importante du projet. Elle est calculée en multipliant la quantité d’énergie fournie aux électrolyseurs par le prix associé de l’énergie DAM.
- Remplacement de la pile– après l’unité d’électrolyse arrive à la fin de sa durée de vie, la pile doit être remplacée, engageant un coût significatif pour le projet (Tableau 8.6).
- OPEX – les coûts d’exploitation pour les unités d’électrolyse (comme présenté en Tableau 8.13), aussi bien que ceux mentionnés antérieurement pour les éléments des composantes de l’Injection de l’Hydrogène.
- Assurance – les coûts liés à l’assurance sont évalués à 0.4% des CAPEX pour chaque année, en couvrant l’unité d’électrolyse, les composantes du stockage de l’hydrogène et le réacteur de méthanisation.
- Contingences –on assume qu’un pourcent de 5% des dépenses totales par année couvrent des coûts inattendus qui apparaissent normalement lors de l’opération d’un projet. Comme le coût de l’eau pour le procès d’électrolyse n’a pas été pris en considération dans une catégorie bien distincte, on peut supposer qu’il est compris dans cette catégorie.

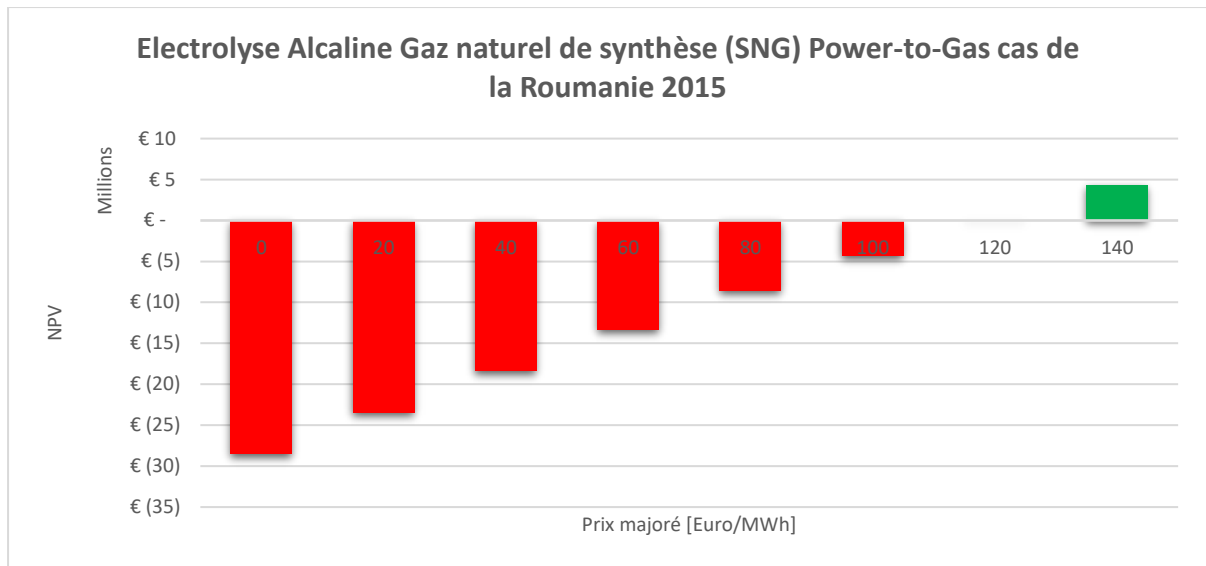

Figure 8.6 Influence gaz naturel de synthèse (SNG) Power-to-Gas des prix majorés sur la valeur actuelle nette (NPV) du projet cas de la Roumanie 2015

Le seuil de rendement est atteint pour un prix majoré gaz naturel de synthèse (SNG) 120 Euros/MWh HHV.

INFLUENCE DES FUTURS DÉVELOPPEMENTS TECHNIQUES ET ÉCONOMIQUES SUR LE CAS DE LA ROUMANIE

Power-to-Gas est près d'atteindre la maturité technique, en faisant le saut des démonstrateurs à échelle de laboratoire à projets pilot à large échelle. Pourtant, les avantages techniques sont contrebalancés par des coûts de capital et d'exploitation, aussi bien que par la efficacité globale de la chaîne entière. La technologie a enregistré des améliorations constantes en matière d'efficacité dans les dernières quelques années et on s'attend à ce que la tendance vu que de nouvelles technologies deviennent plus matures, en particulier l'électrolyse PEM. En outre, les évolutions récentes indiquent que les coûts de la technologie qui se sont inscrites sur une pente descendante qui devrait continuer à court et moyen terme actionnée par la recherche et l'implantation sur le marché.

Tableau 8.4 Hypothèses techniques prises en considération pour l'évaluation comparative de 2015 et 2030 du Power-to-Gas dans le cas de la Roumanie

	2015 (Alcaline)	2030 (Alcaline)	2030 (PEM)	Référence
Entrée électricité [kWh _{el} /kg _{H2}]	56	50	47	[Bertuccioli et al. 2014] [ADEME 2014]
Efficienc e LHV [%]	62	66	71	
Champ de fonctionnement [%]	20 – 100	5 – 110	5 – 200	
Pression d'opération [bar]	30	60	100	

Tableau 8.5 Hypothèses économiques prises en considération pour l'évaluation comparative de 2015 et 2030 du Power-to-Gas

	2015	2030	Référence
Electrolyse			
CAPEX [Euro/kW]	900	400 / 700 (PEM)	[Bertuccioli et al. 2014] [ADEME 2014]
OPEX [% de CAPEX/an]	2,2	2	
Méthanisation			
CAPEX [Euro/kW]	950	500	[DNV KEMA Energy & Sustainability 2013] [ADEME 2014]
OPEX [% de CAPEX/an]	10	5	

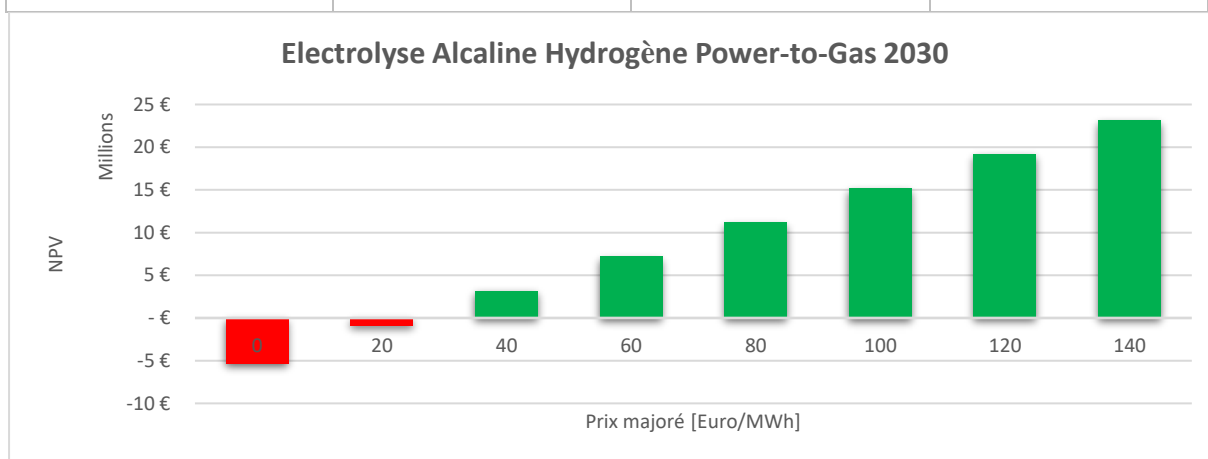

Figure 8.7 Hydrogène Power-to-Gas en utilisant l'influence de l'électrolyse alcaline des prix majorés sur la valeur actuelle nette (NPV) du projet cas de la Roumanie 2030

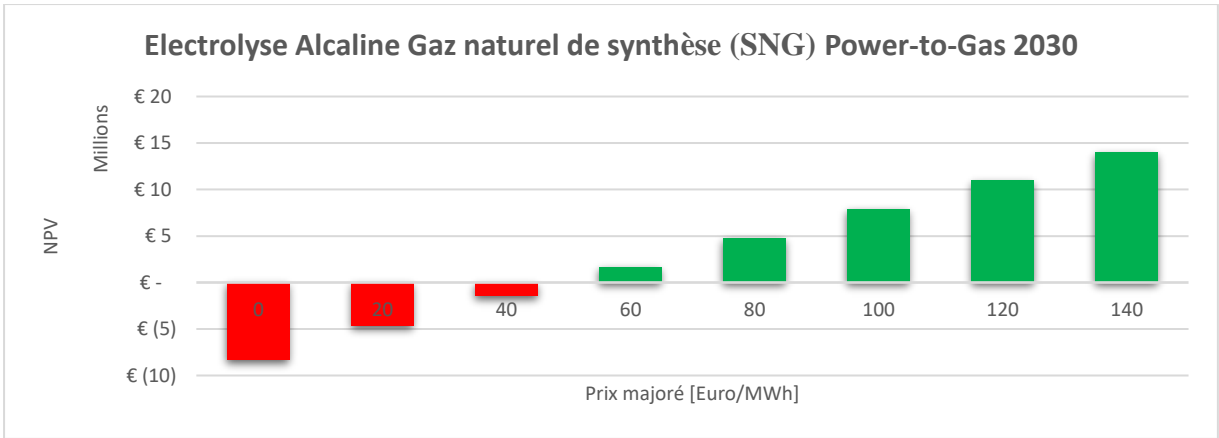

Figure 8.8 Gaz naturel de synthèse (SNG) Power-to-Gas en utilisant l'influence de l'électrolyse alcaline des prix majorés sur la valeur actuelle nette (NPV) du projet cas de la Roumanie 2030

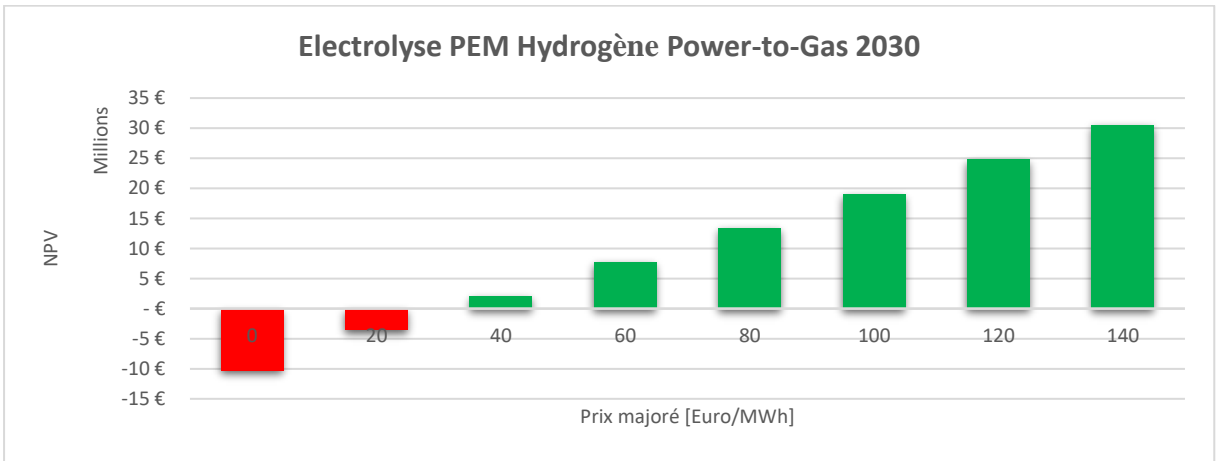

Figure 8.9 Hydrogène Power-to-Gas en utilisant l'influence de l'électrolyse PEM des prix majorés sur la valeur actuelle nette (NPV) du projet cas de la Roumanie 2030

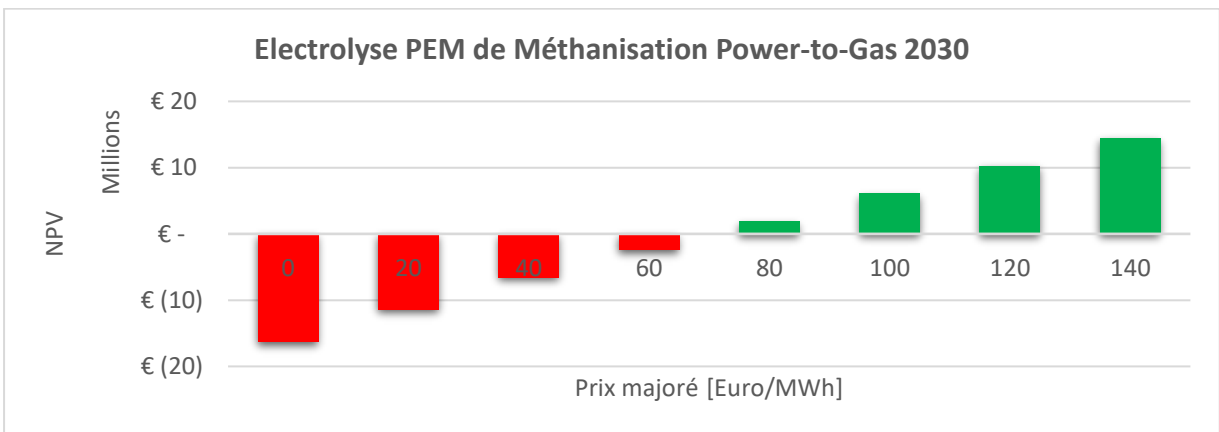

Figure 8.10 Gaz naturel de synthèse (SNG) Power-to-Gas en utilisant l'influence de l'électrolyse PEM des prix majorés sur la valeur actuelle nette (NPV) du projet cas de la Roumanie 2030

Dans le scénario de 2030, suite aux coûts réduits CAPEX et OPEX, la stratégie d'opération se dirige vers l'emploi d'un seuil de prix plus bas de l'énergie (40 Euros/MWh pour l'électrolyse alcaline et 50 Euros/MWh pour l'électrolyse PEM) pour la voie Hydrogène, aussi bien que pour la voie gaz naturel de synthèse (SNG), qui est un choix plus naturel vu que plus d'électricité est fournie sur le marché de l'énergie par les turbines éoliennes dans ce cas. En plus, un seuil de prix plus bas de l'énergie signifie moins d'énergie fournie au processus Power-to-Gas, par conséquent une dimension plus basse pour l'unité de méthanisation par rapport au scénario de 2015. L'évolution en matière de faisabilité économique est importante dans le scénario de 2030. Bien que des prix majorés soient encore nécessaires pour l'obtention des valeurs actuelles nettes (NPVs) positives, leur valeur est beaucoup réduite en comparaison avec le scénario de 2015, à des valeurs plus acceptables.

Pour 2015, PEM est justement en train de devenir une solution réelle pour des projets vastes Power-to-Gas, avec les premières unités MW entrant sur le marché. Pourtant, le choix évident en matière d'électrolyse est encore la technologie alcaline, mature du point de vue commercial et significativement à un prix plus bas pour le moment. Cependant, jusqu'en 2030, on s'attend à ce que l'électrolyse PEM atteigne la maturité commerciale pour les unités d'échelle MW, tout en offrant une durée de vie comparable aux unités alcalines. On s'attend à ce que toutes les deux technologies d'électrolyse deviennent plus efficaces dans les suivantes 15 années, avec le PEM développant un avantage sur l'alcaline dans ce domaine. Pourtant, les résultats de la simulation ont relevé que les avantages de l'électrolyse PEM en matière d'efficacité et flexibilité ne seront pas à même de compenser la différence significative dans les CAPEX qui continueront à exister en 2030 et que les scénarios les plus profitables incluront toujours l'électrolyse alcaline. En fonction de l'évolution que pourrait avoir le marché d'équilibrage, il est possible que la flexibilité augmentée de l'électrolyse PEM apporte des bénéfices supplémentaires pour l'emploi de cette technologie dans l'avenir. A l'horizon de 2030, la technologie Cellule d'Électrolyse à Oxyde Solide (SOEC -Solid Oxide Electrolysis Cell) peut être prise en considération aussi parce qu'elle assure une voie intéressante pour la valorisation de la chaleur excédentaire produite par le processus de méthanisation, mais les unités d'échelle multi-MW matures du point de vue commercial sont incertaines.

9. MISE À PROFIT DU POWER-TO-GAS DANS LE CONTEXTE FRANÇAIS AVEC LA PARTICIPATION AU MARCHÉ D'ÉQUILIBRAGE

Alors que l'arbitrage de l'énergie entre l'électricité et le marché de gaz naturels peut rester la principale fonction d'une unité Power-to-Gas, tout en fournissant des services auxiliaires sur le marché d'équilibrage représenté potentiellement une fonction secondaire qui peut augmenter le facteur de capacité du système. La viabilité technique et économique d'une telle stratégie sera analysée dans le présent chapitre, en choisissant le système énergétique actuel en France en tant qu'étude de cas. L'évaluation technique et économique de la mise à profit du Power-to-Gas dans le contexte français actuel profitera d'une approche un peu différente de celle employée pour le contexte de la Roumanie. Bien que le cadre d'analyse reste en grande partie sans des modifications, il y aura plusieurs modifications majeures concernant l'analyse de haut niveau /le dimensionnement technique, qui seront réalisés d'une manière plus efficace qui nous permettra d'analyser le potentiel de l'emploi d'un mécanisme principal de réserve du contrôle en tant que marché de valeur supérieure pour l'application spécifique Power-to-Gas. Dans notre analyse, la principale fonction de l'unité Power-to-Gas sera toujours la production de l'hydrogène de l'énergie renouvelable, participant au marché DAM EPEX spot. Pourtant, quand les conditions économiques sont favorables et la fourniture de services de système peut apporter un avantage économiques supplémentaire, l'unité opérera aussi sur le marché d'équilibrage. Une simulation supplémentaire sera réalisée sans prendre en considération la participation au marché d'équilibrage, afin de quantifier l'avantage économique.

Odysey, le même outil logiciel utilisé pour le cas de la Roumanie, ne permettra de réaliser l'analyse de haut niveau /le dimensionnement technique en utilisant le même principe d'imposition des seuils de prix pour divers scénarios de capacité de l'électrolyse, mais en prenant en compte la participation de l'unité Power-to-Gas au marché DAM EPEX spot, aussi bien qu'au marché d'équilibrage. En plus, des seuils pour les prix offerts en amont et en aval sur le marché d'équilibrage seront imposés, en choisissant un set de quatre paramètres variables qui seront utilisés pour la création d'un nombre élevé de scénarios qui seront analysés en employant Odysey sur la base d'un indicateur unique: Levelized Hydrogen Production Cost, tel que décrit par [Guinot et al. 2015]:

$$\text{Levelized } H_2 \text{ production cost} = \frac{\sum CAPEX + \sum_l OPEX + \sum_l^{exp} DAM + \sum_l^{exp} BAM - \sum_l^{rev} BAM}{\sum_l^{prod} H_2}$$

Pour le scénario français, des données concernant la production d'énergie d'un parc éolien en situation réelle n'étaient point disponibles au public, par conséquent une approche différente a été choisie pour obtenir une courbe de production de l'énergie pour une année pour un parc d'énergie éolienne simulée de 50 MW. La production totale de l'énergie éolienne dans un pas de demi-heure à travers le territoire de la France a été prise en considération pour la même période utilisée dans le contexte de la Roumanie (Décembre 2012 – Novembre 2013) [Eco2Mix 2015]. Le pas suivant a concerné l'établissement de la capacité totale de production de l'énergie éolienne en France, en utilisant la source mentionnée antérieurement. La division de la capacité installée totale de l'énergie éolienne en France à 50 MW nous a permis d'obtenir un facteur d'échelle qui a été appliqué à la production totale d'énergie éolienne dans un pas de demi-heure, afin d'avoir des données d'entrée de l'énergie similaires à celles utilisées pour l'évaluation du Power-to-Gas dans le contexte de la Roumanie. Le profil de la production de l'énergie a été lié avec les prix du marché DAM EPEX spot en France pour la même période (Figure 9.1 et 9.2). Les paramètres activés pouvoir activé total en amont, le prix moyen mesuré en amont, le prix maximal activé en amont, aussi bien que le pouvoir activé total en aval, le prix moyen mesuré en aval et le prix minimal en aval nécessaires pour la simulation de la participation de l'installation Power-to-Gas sur le marché d'équilibrage ont été importés de [Eco2Mix 2015] pour la période d'une année mentionnée antérieurement.

Tableau 9.1 Résultats du procès d'optimisation réalisé en Odyssey

Paramètre	Participation sur le BAM	Sans participer sur le BAM
Capacité de l'électrolyseur [MW]	10	10
Prix de l'énergie DAM EPEX spot [Euros/MWh]	48	52
Prix offert en amont BAM [Euro/MWh]	70	-
Prix offert en aval BAM [Euro/MWh]	36	-

Hydrogène Power-to-Gas

La valeur actuelle nette (NPV) du projet Hydrogène Power-to-Gas dans le cas de la France (avec participation au marché d'équilibrage) est – 19 241 171 Euros pour un taux d'actualisation de 8%. Une analyse séparée a été réalisée en ce qui concerne le cas où l'installation Power-to-Gas n'opère pas sur le marché d'équilibrage, en utilisant les paramètres présentés par Tableau 9.3. Le résultat final indique fait que le projet enregistrerait une valeur actuelle nette (NPV) de – 20 046 763 Euros pour une durée de 20 années et utilisant un taux d'actualisation identique de 8 pourcents. En conclusion, le marché d'équilibrage seul ne suffit

pas en tant que marché de valeur supérieure qui apporterait une profitabilité à un projet Power-to-Gas dans le contexte français actuel. Pourtant, l'emploi du marché d'équilibrage améliore la valeur actuelle nette (NPV) du projet d'environ 4% et assure en même temps des services techniques précieux au réseau.

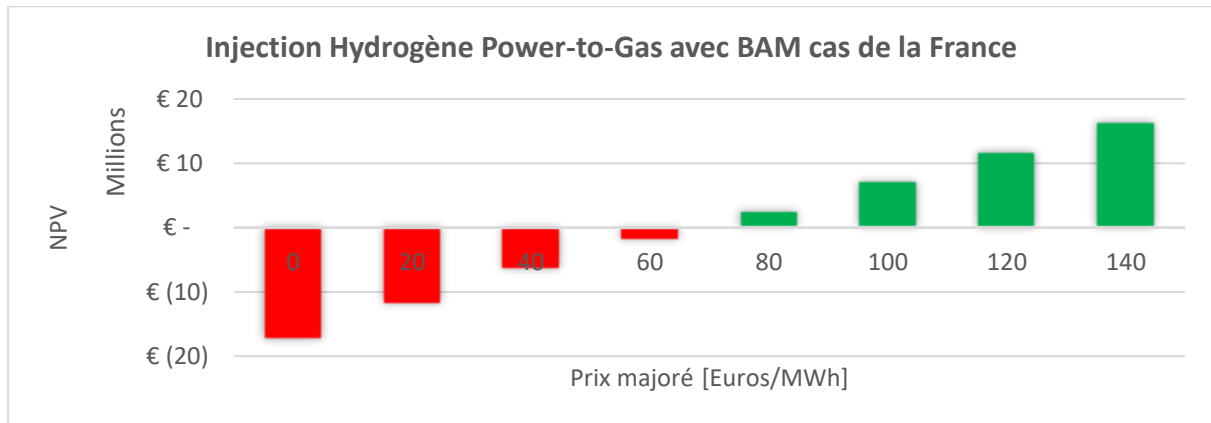

Figure 9.1 Analyse de la sensibilité sur l'influence des prix potentiels majorés pour hydrogène renouvelable dans l'Injection Hydrogène Power-to-Gas participant sur le BAM cas de la France

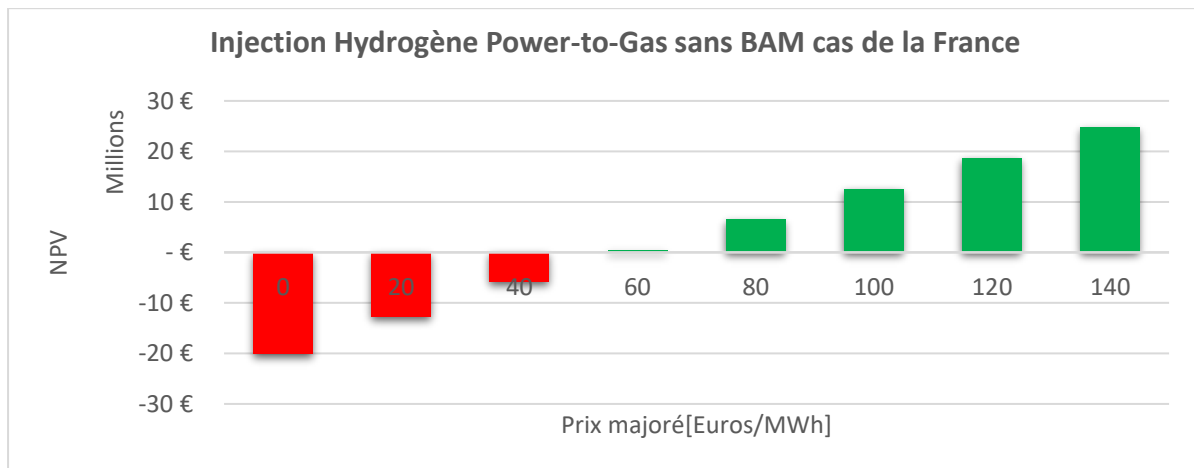

Figure 9.2 Analyse de la sensibilité sur l'influence des prix potentiels majorés pour hydrogène renouvelable dans l'Injection Hydrogène Power-to-Gas sans participer sur le BAM cas de la France

La voie Injection Hydrogène dans laquelle le marché d'équilibrage n'est pas utilisé devient profitable pour un prix majoré inférieur par rapport à celui dans lequel est utilisé le marché d'équilibrage (seuil de rendement atteint pour 58.8 Euros/MWh de hydrogène renouvelable HHV pour un taux d'actualisation de 8%, par rapport à un seuil de rendement de 63.6 Euros/MWh). Cela peut être expliqué par le fait que dans la situation où aucun BAM n'est pas utilisé, le prix majoré est appliqué à l'entière production de l'hydrogène (parce que seulement énergie renouvelable est produite), alors que pour le cas où le BAM est pris en considération, une partie de la production de l'hydrogène dérive de la branche de l'énergie sur le marché d'équilibrage (qui n'est pas garantie comme être renouvelable, en conséquent aucun prix

majoré ne sera reçu). En allant plus loin avec l'explication, cela indique clairement une limitation de l'étape de dimensionnement de la Thèse, qui ne prend pas en compte la possibilité d'avoir des prix majorés. En fait, cela entraîne la conclusion que si le dimensionnement optimal d'un projet Power-to-Gas qui participe aussi sur le marché d'équilibrage est établi dans le contexte actuel, le dimensionnement ne représentera pas le choix optimal si le contexte est modifié en ajoutant divers mécanismes de soutien. Les bénéficiaires amélioreront les paramètres économiques, mais un dimensionnement différent pourrait être considéré comme optimal.

Gaz naturel de synthèse (SNG) Power-to-Gas

La valeur actuelle nette (NPV) du projet gaz naturel de synthèse (SNG) Power-to-Gas cas de la France avec la participation sur le marché d'équilibrage pendant une période de vie de 20 ans est -27 500 005 Euros pour un taux d'actualisation de 8%. En cas de non-participation sur le BAM, la valeur actuelle nette (NPV) est similaire, de -27 448 828 Euros pour le même taux d'actualisation. Cela peut être expliqué de nouveau par la méthodologie de dimensionnement qui s'est concentré sur le Levelized Cost of Hydrogen, ignorant ainsi les éléments concernant la voie gaz naturel de synthèse (SNG) Power-to-Gas. L'analyse de la sensibilité concernant les potentiels prix majorés pour le gaz naturel de synthèse (SNG) renouvelable indique des valeurs similaires pour obtenir la faisabilité économiques (116.3 Euros/MWh de gaz naturel de synthèse (SNG) HHV sans utiliser le BAM et 116.6 Euros/MWh de gaz naturel de synthèse (SNG) HHV au moment de l'emploi des seuils de rendement BAM).

Les principales conclusions de l'étude de la possibilité de l'emploi du Power-to-Gas en conjonction avec le marché d'équilibrage (en tant que potentiel marché à valeur supérieure) dans le contexte actuel de la France indique une amélioration de 4 pourcents dans l'indicateur économique valeur actuelle nette (NPV) au moment de l'emploi du BAM par rapport à la situation où le BAM n'est pas utilisé, mais seulement si les conditions initiales de l'étape de dimensionnement ne sont pas modifiées: si le produit final du procès est l'hydrogène, (en conséquent seulement pour Injection Hydrogène Power-to-Gas) et si aucun mécanisme de soutien n'est mis en place.

Cela entraîne la conclusion qu'une stratégie différente pour l'établissement du dimensionnement optimal est désirable si le résultat désiré est le scénario optimal. La stratégie actuelle de dimensionnement peut être appliquée avec succès seulement si nous cherchons à établir la dimension optimale du projet et la stratégie d'opération dans le contexte actuel et seulement pour la voie Injection Hydrogène Power-to-Gas.

10.ÉVALUATION ENVIRONNEMENTALE DU POWER-TO-GAS

L'étude a l'intention d'offrir une vue d'ensemble des impacts environnementaux associés avec divers voies et scénarios Power-to-Gas. Elle n'a pas l'intention d'être exhaustive pour chaque scénario, mais se concentre plutôt sur la fourniture d'une perspective étendue des impacts associés aux multiples applications en relation avec l'énergie de la technologie Power-to-Gas.

Application attendue:

- Calcul des impacts environnementaux du Power-to-Gas – en évaluant les indicateurs pertinents pour des procès liés à l'énergie, tels que le PRP et la demande principale d'énergie. Il a l'intention d'ajouter un troisième pilier d'analyse, celui environnemental, aux évaluations techniques et économiques de la technologie.
- Développement de la politique– indirectement, l'actuelle étude peut potentiellement stimuler le développement de nouvelles politiques énergétiques qui peuvent établir un cadre légal pour l'hydrogène renouvelable et le méthane renouvelable encourageant ainsi la transition vers un système énergétique décarbonaté via une meilleure compréhension de la comparaison entre les voies associées Power-to-Gas et les procès énergétiques traditionnels.

Le choix des trois unités fonctionnelles couvre la gamme entière d'applications pour les scénarios Power-to-Gas pris en considération dans le cadre de la Thèse:

- 1 kg d'hydrogène – avec applications pas seulement dans le transport et le stockage de l'énergie dans la voie Hydrogène Power-to-Gas, mais aussi dans le secteur de la production et de la mobilité de l'hydrogène. La production de l'hydrogène de l'énergie renouvelable représente la base pour toutes les applications Power-to-Gas et est comparée directement au scénario de référence - de reformage à la vapeur.
- 1 kWh d'électricité – étant le plus usuel transporteur d'énergie pour les systèmes énergétiques actuels, l'électricité est un choix naturel en tant qu'unité fonctionnelle pour les applications Power-to-Gas.
- 1 MJ de chaleur – choisie comme l'une des sorties de l'énergie de base de la perspective de l'utilisateur final.

Trois scénarios différents concernant le mélange d'énergie pour la source de l'électricité utilisée dans la compression de l'hydrogène sont pris en compte:

- Mélange roumain– approche conservatrice – mélange d'énergie carbonaté avec une part grande d'électricité produite dans des centrales électriques de charbon et gaz naturels sans captage de carbone.

- Mélange français – dominé par l'énergie nucléaire, avec une concentration réduite en carbone.
- Mélange renouvelable– un mélange 100% énergie renouvelable (énergie éolienne pour référence), le scénario dans lequel les installations Power-to-Gas ont plus de chance à opérer vu les principes derrière la technologie prise en considération à l'intérieur de la Thèse (fonctionnant sur la base d'électricité renouvelable excédentaire/à prix bas).

Les cycles Power-to-Gas unique et double sont pris en compte afin d'évaluer l'impact environnemental impact de la fourniture des emplois énergétiques multiples à la même quantité de CO₂ avant de son émission finale.

Considérant le fait que LCA analyse des applications liées à l'énergie, deux catégories d'impact ont été choisies d'être spécifiquement pertinentes pour ce type d'étude: potentielles de réchauffement planétaire et consommation d'énergie primaire.

Considérant l'objectif de l'étude LCA qui a concerné l'assurance d'une vue environnementale d'ensemble des scénarios multiples associés avec Power-to-Gas, la méthodologie pour la construction d'un inventaire s'est fondé en principal sur des données de base plutôt que sur des données de premier plan. Les informations bibliographiques les plus pertinentes ont été utilisées pour construire l'inventaire pour les composantes de l'infrastructure, alors que les données du procès (le bilan matériel et énergétique) pour le modèle principal Power-to-Gas sont dérivées des évaluations techniques et économiques présentées dans les chapitres antérieurs.

Par rapport à la production de référence de l'hydrogène du scénario de reformage à la vapeur [Cetinkaya et al. 2012], des scénarios d'hydrogène renouvelable ont des émissions de carbone significativement inférieures (1,453 vs. 11.893 kgCO₂/kgH₂) bien qu'ils comprennent la charge e la phase de compression et stockage. L'impact total PRP de l'hydrogène renouvelable peut être même plus bas si l'on quitte l'étape de compression et l'unité fonctionnelle est hydrogène à la pression atmosphérique.

Emissions PRP des scenarios de production de l'hydrogène

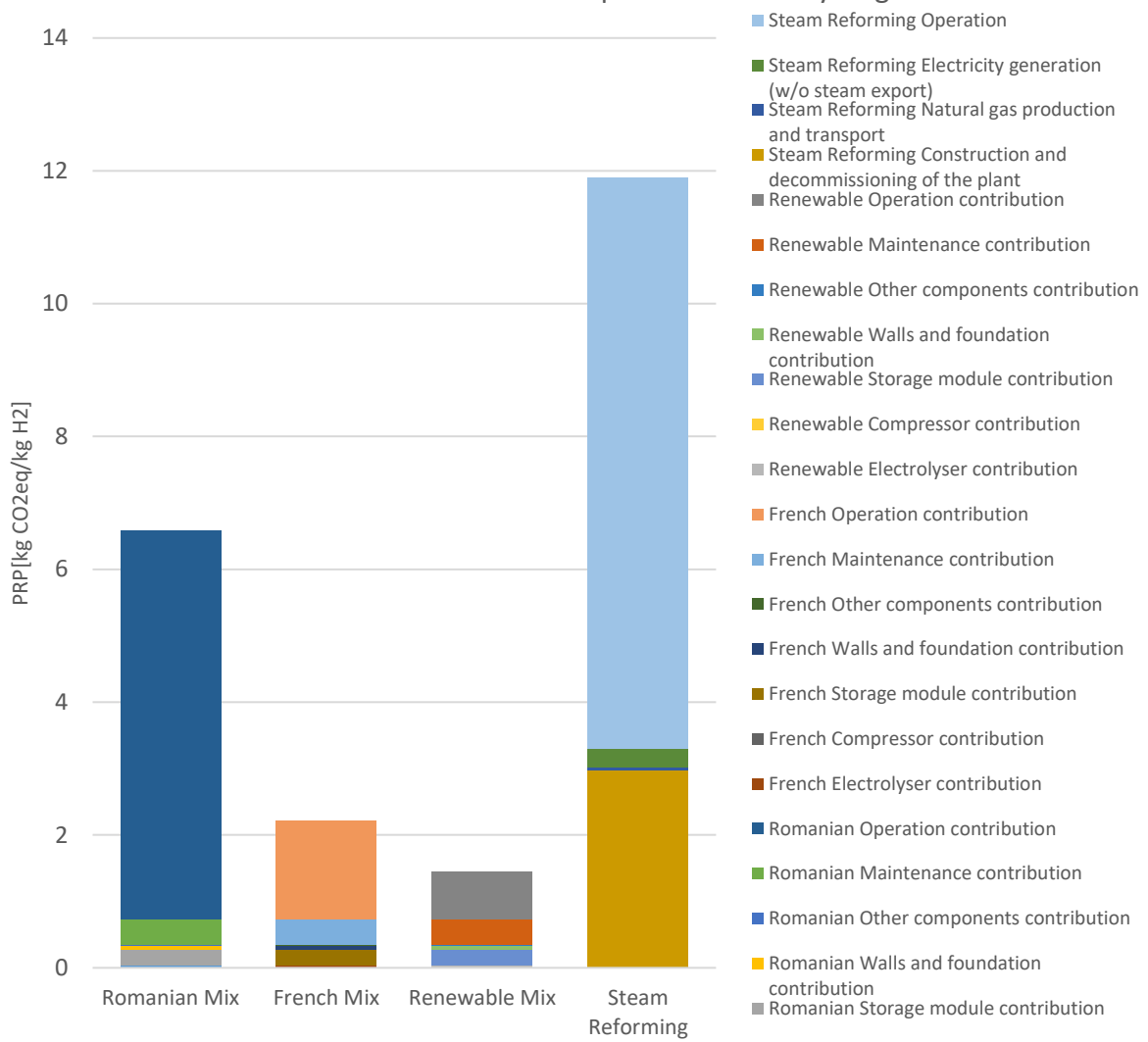

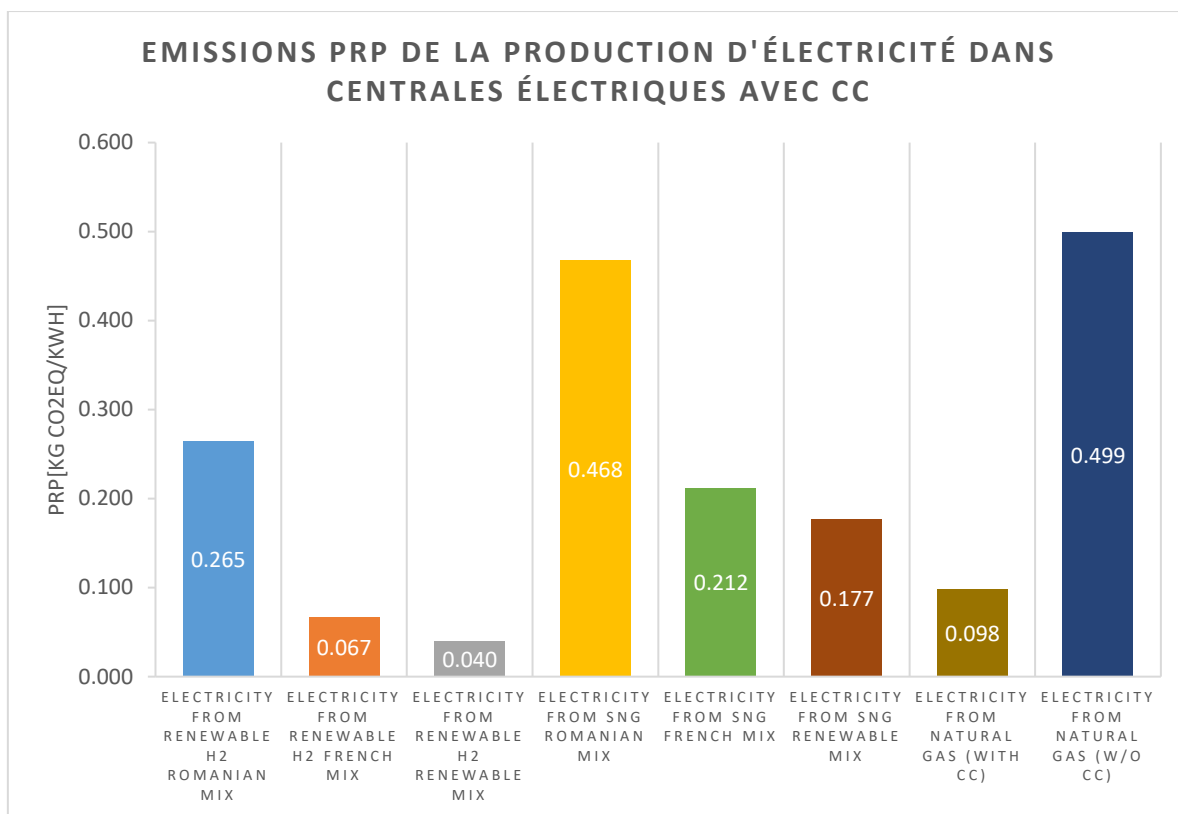

Figure 10.1 Emissions PRP des scenarios de production de l'électricité

Les résultats de l'électricité dérivant des scenarios d'hydrogène renouvelable (correspondant à l'injection de l'hydrogène des chapitres techniques et économiques antérieurs) sont similaires avec ceux pour la production de l'hydrogène, étant fort influencés par la source d'énergie utilisée pour la compression de l'hydrogène. Comme il n'y a pas d'émissions de CO₂ lors de la production d'électricité dans la phase de centrale électrique, la charge globale de cette voie est la plus basse par rapport à la production d'électricité à partir du gaz naturel de synthèse (SNG) ou les scenarios de référence dans lesquels est utilisé le gaz naturel.

Dans l'électricité du scenario gaz naturel de synthèse (SNG), la plus grande partie de la charge est associée avec la phase de production gaz naturel de synthèse (SNG), influencé de nouveau par l'énergie utilisée pour la phase de compression. Pour ce scenario spécial, le CO₂ nécessaire dans la phase de production gaz naturel de synthèse (SNG) est considéré entre biogénique (vu qu'il est un produit déchet d'un procès à l'extérieur du périmètre de l'étude qui serait autrement émis dans l'atmosphère – scenario A, comme défini au début du chapitre), par conséquent aucune charge n'est associée avec lui. Malgré cela, les émissions CO₂ de cette voie sont plus hautes que celles associées avec le scenario de référence dans lequel l'électricité est produite à partir du gaz naturel (dans une centrale électrique équipée avec captage de carbone) même dans le scenario de mélange renouvelable.

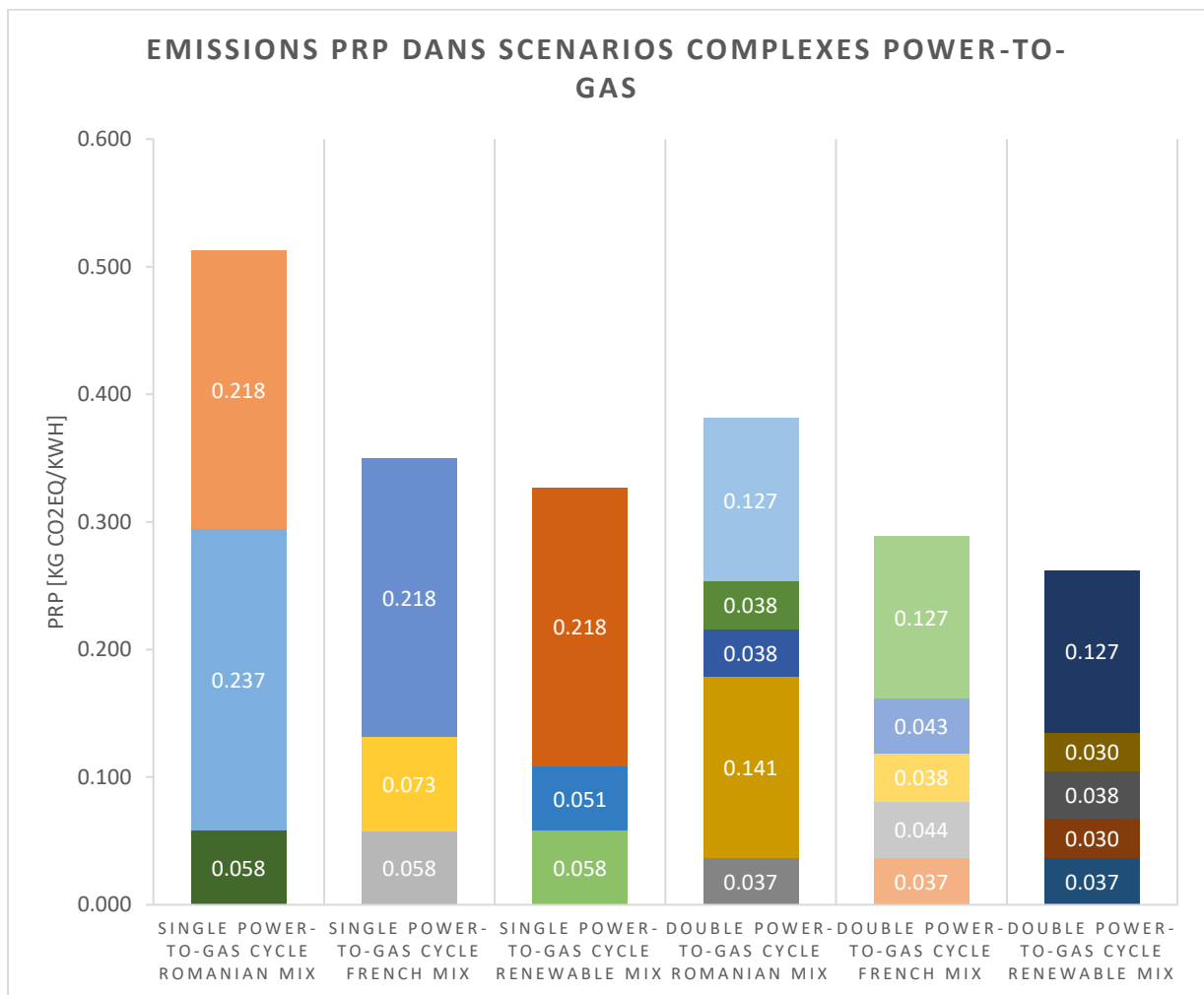

Figure 10.2 Emissions PRP de la production d'électricité dans scénarios complexes Power-to-Gas en employant le carbone fossile des centrales électriques

Les résultats indiquent qu'il y a un gain environnemental en matière d'impact PRP au moment du captage du CO₂ dans cycles multiples Power-to-Gas avant son émission finale.

L'impact PRP de la production de la chaleur du gaz naturel de synthèse (SNG) renouvelable est plus haut que la chaleur de référence du scénario de gaz naturels au moment de l'utilisation du mélange roumain et français et un plus inférieur quand seulement l'énergie renouvelable est utilisée. Pourtant, étant donné le type de modelage utilisé, les différences ne peuvent pas être considérées comme importantes.

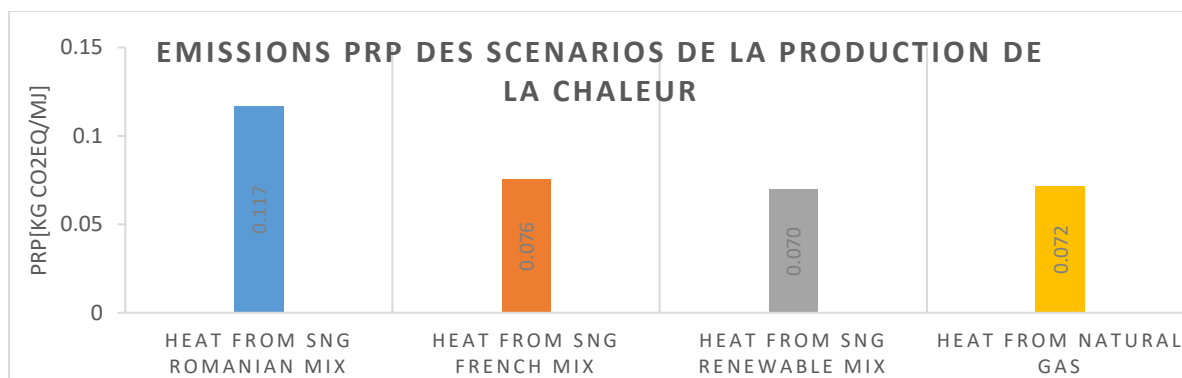

Figure 10.3 Emissions PRP des scenarios de production de la chaleur

La demande totale d'énergie cumulative en ce qui concerne la production de l'hydrogène renouvelable est significativement plus haute que le cas de référence - reformage à la vapeur. Pourtant, une analyse plus attentive indique le fait qu'une large proportion de cette énergie est renouvelable, alors que la reformage à la vapeur utilise seulement énergie fossile. Le scénario concernant le mélange roumain vient avec la plus haute DEC fossile, alors que le cas français dépend plutôt de l'énergie non-renouvelable (suite à la haute proportion de puissance nucléaire) qui n'est pas fossile. Si l'on considère que l'énergie renouvelable qui entre dans la production d'hydrogène renouvelable est énergie excédentaire qui ne peut pas être utilisée pour remplacer l'énergie fossile dans autres applications, cette voie est une meilleure alternative à reformage à la vapeur en matière de demande d'énergie cumulative et évitant l'épuisement des ressources fossiles.

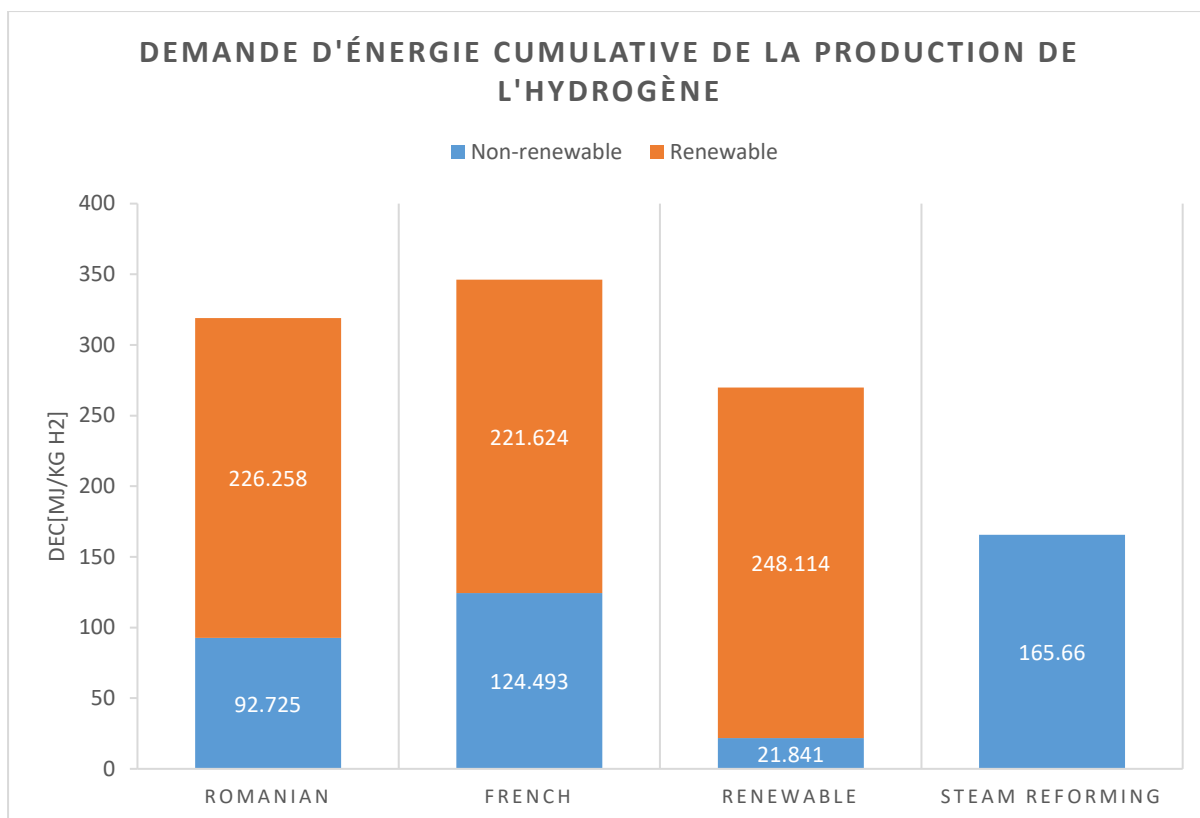

Figure 10.4 DEC des scenarios de production de l'hydrogène

La production de l'électricité d'un gaz naturel de synthèse (SNG) a une DEC totale plus haute, aussi bien qu'une DEC fossile plus haute, par rapport au cas dans lequel est utilisé l'hydrogène renouvelable, causé par l'infrastructure supplémentaire et les procès de transformation qui entraînent une perte de l'efficacité globale. Pourtant, dans tous les scénarios étudiés, la DEC non-renouvelable est significativement plus basse en comparaison avec l'électricité de référence de scénario de gaz naturels.

Les scénarios des cycles Power-to-Gas Unique et Double sont similaires en termes de DEC totale, mais le scénario du cycle Power-to-Gas Double a une DEC non-renouvelable équivalente plus basse, ce qui suggère que le captage de la même quantité de CO₂ à l'intérieur des cycles multiples entraîne une consommation de ressources non-renouvelables.

Dans le cas de la production de la chaleur du gaz naturel de synthèse (SNG), les résultats sont similaires avec les cas présentés antérieurement, ayant un DEC totale plus haute que la chaleur de référence du scénario de gaz naturels et un DEC non-renouvelable équivalente, à l'exception du mélange d'énergie renouvelable 100%, qui est le meilleur scénario avec une réduction cinq fois de la DEC non-renouvelable par rapport au cas de référence.

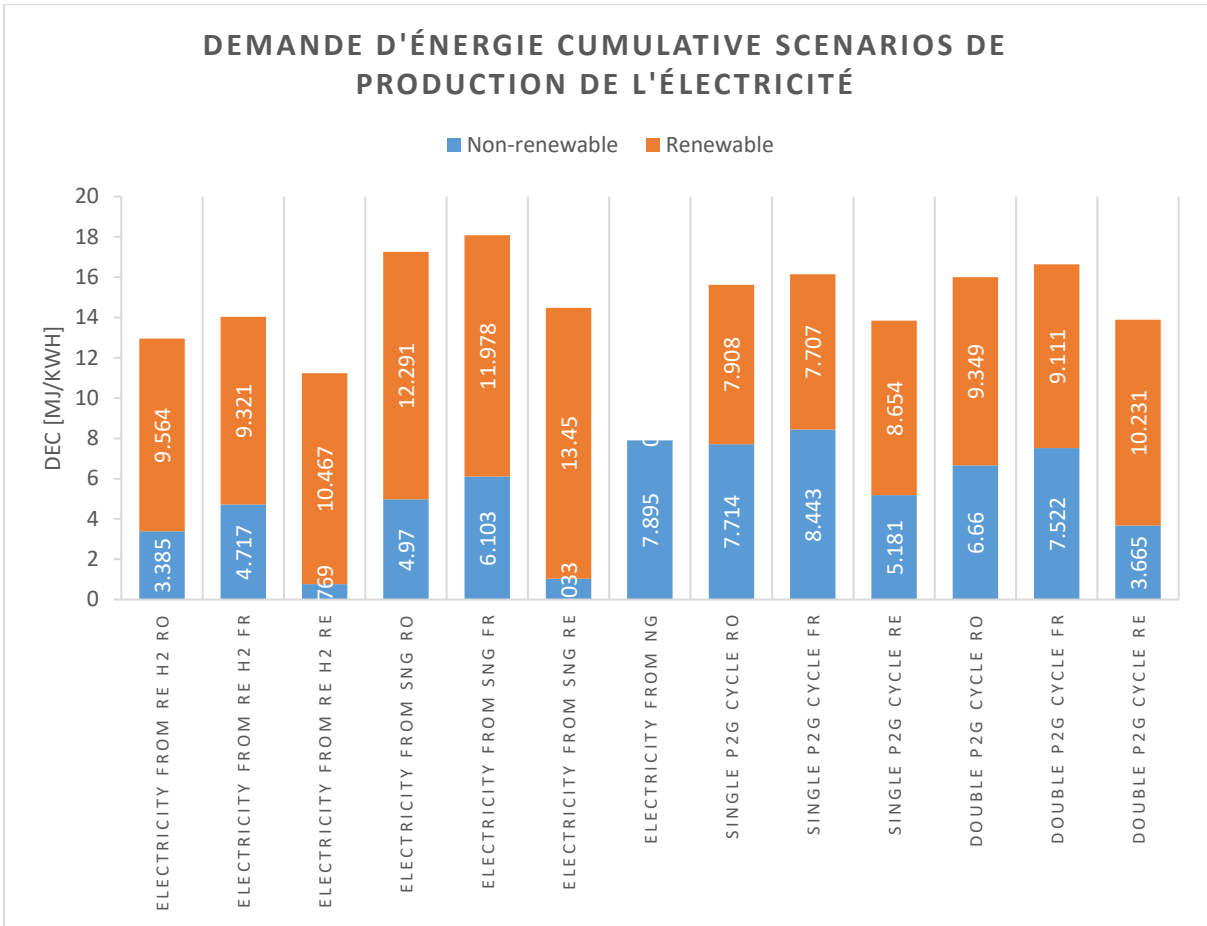

Figure 10.5 DEC des scenarios de production de l'électricité

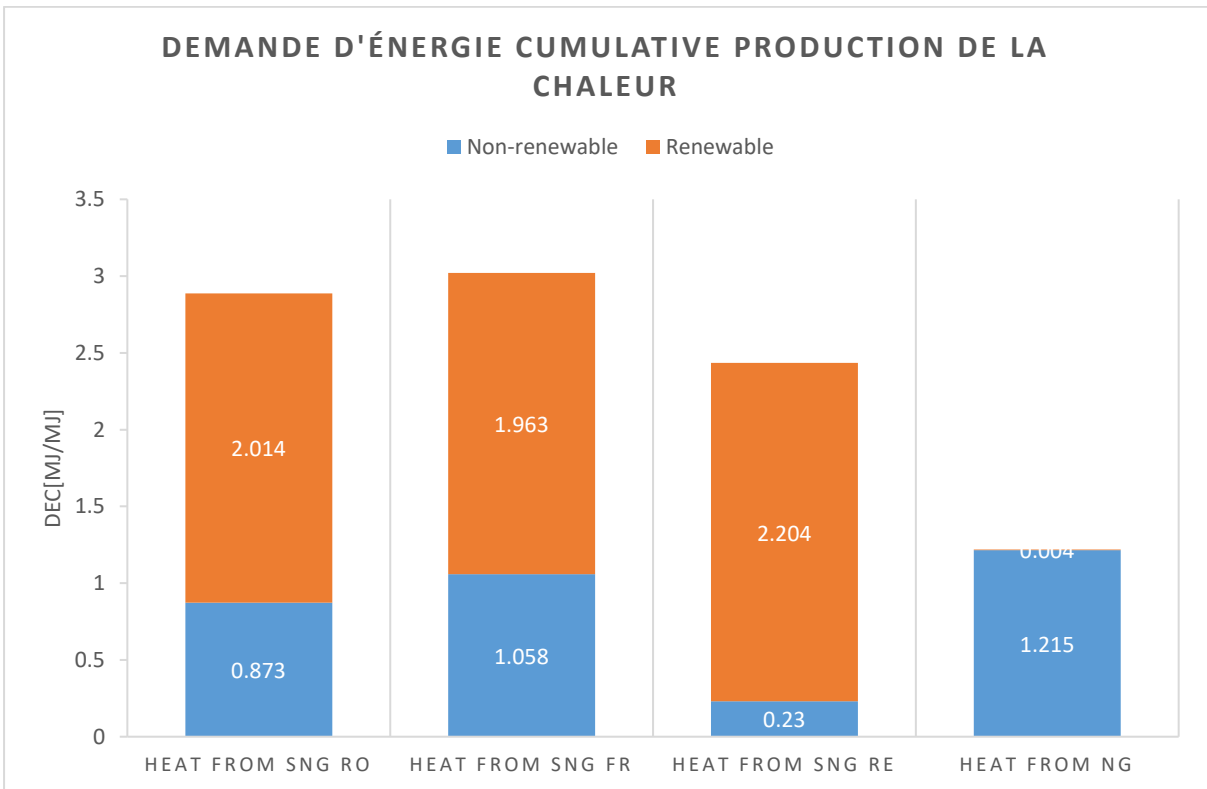

Figure 10.6 DEC des scenarios de production de la chaleur

11. CONCLUSIONS ET PERSPECTIVE

Le stockage de l'énergie est l'une des solutions qui répond aux dilemmes de la période de la transition de l'énergie, ayant le potentiel de débloquer une part augmentée des renouvelables dans le mélange de l'énergie qui traitera des questions telles que la réduction des émissions des gaz à effet de serre, tout en améliorant l'efficacité énergétique, un degré plus haut de flexibilité, aussi bien que la sécurité dans la sécurité de fourniture de l'énergie. Power-to-Gas représente un technologie complexe de stockage de l'énergie chimique qui crée un lien entre l'électricité et le réseau de gaz en utilisant hydrogène ou gaz naturel de synthèse (SNG) en tant que vecteurs d'énergie supplémentaire, en apportant de la valeur et flexibilité au système énergétique à travers des fonctions telles que: transport et conversion de l'énergie, services du système, aussi bien qu'une potentielle fonction environnementale dans certaines voies dans lesquelles le CO₂ capturé devient une ressource.

Les résultats de l'évaluation indiquent le fait que Power-to-Gas ne constitue pas un investissement viable du point de vue financier en ce moment sans prendre en compte des bénéfices financiers dans le contexte actuel de la Roumanie ou de la France et étant donné les coûts de la technologie qui ont pris en compte. Pourtant, les derniers rapports [FCH-JU 2015] indiquent des réductions drastiques dans les CAPEX pour l'électrolyse plus tôt que l'on s'y était attendu et le potentiel de technologies d'électrolyse plus efficaces telles que l'électrolyse à température haute ce qui entraîne des arguments commerciaux plus favorables. En plus, l'analyse a révélé que des marchés de valeur supérieure doivent être identifiés pour hydrogène renouvelable et méthane renouvelable afin de réduire la dépendance de la faisabilité du projet des prix majorés basés sur des règlements significatifs.

Dans le contexte actuel Power-to-Gas n'est pas faisable du point de vue économique sans des plans de soutien, même pas dans les scénarios conservatoires pris en considération dans cet article qui ont compris la co-localisation de toutes les étapes du processus (par conséquent des coûts minimaux de transport des ressources) et coûts zéro pour CO₂. Par conséquent, la faisabilité d'un argument commercial autour du Power-to-Gas dépend fortement des mesures de la politique de soutien qui créeraient le cadre légal pour accorder des prix majorés pour hydrogène renouvelable et méthane renouvelable, qui ne sont pas traités en ce moment comme biogaz dans la législation existante en Roumanie. On peut spéculer que si la définition de biogaz du cadre légal actuel s'étendait aux hydrogène et méthane régénérables, alors la voie

Hydrogène Power-to-Gas deviendrait profitable, avec deux (ou trois dans le cas des installations CHP très efficaces) cartes vertes accordées pour chaque MWh, en général à des prix entre 30 et 35 Euros/carte verte. Le secteur du transport peut potentiellement représenter un marché à valeur supérieure pour des combustibles Power-to-Gas, vu qu'il y a deux directives de la Commission Européenne, la Directive relative aux énergies renouvelables (RED - Renewable Energy Directive) [European Commission 2009a], stipulant qu'une énergie renouvelable devrait avoir une part de 10% dans le transport jusqu'en 2020 et la Directive relative à la qualité du combustible (Fuel Quality Directive - FQD) [European Commission 2009b] qui mentionne une réduction de 6% dans l'intensité GES dans le transport routier jusque dans la même année. Une chose intéressante est que la double comptabilisation de ces deux directives avec l'amendement ILUC [European Parliament 2015] indique que 0.5% des combustibles totaux devraient être avancés combustibles renouvelables, qui peuvent dériver de voies différentes de la technologie Power-to-Gas aussitôt qu'elles seront considérées comme éligibles d'un point de vue légal [Hinicio & LBST 2016].

En ce moment, la législation concernant le stockage de l'énergie, y compris Power-to-Gas, se trouve dans les premières étapes de développement au niveau européen et l'absence d'un environnement de réglementation limite le déploiement des technologies de stockage for le moment. Pourtant, on s'attend à ce que cette situation change à moyen et long terme vu que les nouvelles cibles en matière de réduction des émissions ne pourront pas être réalisées par le seul déploiement des mesures de l'expansion du réseau (qui pourraient représenter l'alternative moins chère au stockage de l'énergie, mais sans offrir les mêmes fonctions).

Une comparaison des résultats obtenus pour la voie gaz naturel de synthèse (SNG) Power-to-Gas avec ceux résumés dans le cadre d'une étude récente [Götz et al. 2016] rend le présent travail conforme avec des évaluations similaires. Notre étude indique un coût de 132 Euros/MWh gaz naturel de synthèse (SNG), avec l'utilisation de l'oxygène et de la chaleur résiduelle, alors que [Vandewalle et al. 2015] obtient un coût entre 100 et 160 Euros/MWh gaz naturel de synthèse (SNG), [ADEME 2014] entre 165 et 392 Euros/MWh gaz naturel de synthèse (SNG), pour des marchés différents de l'énergie, mais des hypothèses similaires de coût. Une étude qui analyse une stratégie d'opération similaire avec le présent travail (facteur de capacité haute pour le réacteur de méthanisation), des prix presque identiques pour l'électricité et la chaleur (50 Euros/MWh d'électricité et 40 Euros/MWh énergie thermique), mais un prix plus haut de l'oxygène (0.07 Euro/m³ par rapport à 0.03 Euro/m³) [Graf et al.

2014] indique un coût inférieur d'environ 100 Euros/MWh gaz naturel de synthèse (SNG), toujours trop haut par rapport au prix actuel du gaz naturel situé entre 20 et 30 Euros/MWh.

L'ajout de la couche environnementale à l'étude T&E du cas de la Roumanie entraîne une contradiction intéressante. Afin de rendre l'unité Power-to-Gas profitable dans les conditions économiques actuelles (CAPEX et OPEX, prix de l'électricité et des gaz naturels), le facteur de capacité de l'unité d'électrolyse est situé justement sous 71%, ce qui signifie que toute l'énergie renouvelable utilisée ne peut pas être considérée comme énergie excédentaire. Une partie de cette énergie renouvelable peut être utilisée directement en tant qu'électricité, mais en évitant la situation dans laquelle la génération fossile (avec une charge environnementale encore plus importante) est utilisée pour compléter l'énergie éolienne fournie à l'unité Power-to-Gas. Par conséquent, d'une perspective économique et environnementale, les objectifs de développement de la technologie devraient se concentrer sur les coûts plus bas de technologie qui permettraient d'atteindre la rentabilité économique avec un facteur de capacité réduite, alimentant les unités d'électrolyse en énergie excédentaire (énergie qui ne devrait pas être compensée par la génération fossile) autant que possible. Cela peut être réalisé en principal par des efforts supplémentaires du secteur R&D, aussi bien qu'une adoption augmentée du marché qui aiderait à stimuler les chiffres de la production et réduire les coûts d'acquisition, et une méthode d'initier le processus concerne la mise en place des plans de soutien.

BIBLIOGRAPHIE

- ADEME, 2014. *Etude portant sur l'hydrogène et la méthanation comme procédé de valorisation de l'électricité excédentaire*, ADEME, GRTgaz, GrDF.
- Agora, 2014. *Electricity Storage in the German Energy Transition Electricity Storage in the German Energy Transition*, Berlin.
- Aspen Technology, 2010. Aspen Physical Property System: Physical Property Methods. , pp.1–234.
- Bertuccioli, L. et al., 2014. *Study on development of water electrolysis in the EU*, FCH-JU, Available at: http://www.fch-ju.eu/sites/default/files/study_electrolyser_0-Logos_0.pdf.
- Cetinkaya, E., Dincer, I. & Naterer, G.F., 2012. Life cycle assessment of various hydrogen production methods. *International Journal of Hydrogen Energy*, 37(3), pp.2071–2080. Available at: <http://dx.doi.org/10.1016/j.ijhydene.2011.10.064>
- Damodaran, A., Basics of Discounted Cash Flow Valuation. , pp.1–11. Available at: <http://people.stern.nyu.edu/adamodar/pdfiles/basics.pdf> [Accessed December 1, 2013].
- Departamentul pentru Energie, 2014. *Strategia Energetica a Romaniei*, draft. Available at: <http://energie.gov.ro/>
- DNV KEMA Energy & Sustainability, 2013. *Final Report: Systems Analyses Power to Gas*, part of Part of TKI project TKIG01038 , pp.1–70, Groningen.
- European Commission, 2009a. Directive 2009/28/EC of the European Parliament and of the Council of 23 April 2009 on the promotion of the use of energy from renewable sources.
- European Commission, 2009b. Directive 2009/30/EC of the European Parliament and of the Council of 23 April 2009
- European Parliament, 2015. Directive (EU) 2015/1513 of the European Parliament and of the Council of 9 September 2015 amending Directive 98/70/EC relating to the quality of petrol and diesel fuels and amending Directive 2009/28/EC on the promotion of the use of energy from renewabl.
- FCH-JU, 2015. *Commercialisation of energy storage in Europe*, final report.
- Gahleitner, G., 2013. Hydrogen from renewable electricity: An international review of power-to-gas pilot plants for stationary applications. *International Journal of Hydrogen Energy*, 38(5), pp.2039–2061. Available at: <http://dx.doi.org/10.1016/j.ijhydene.2012.12.010>
- GDF Suez Energy Romania, 2013a. Communication with GDF Suez Energy Romania
- Göttlicher, G., 2004. *The Energetics of Carbon Dioxide Capture in Power Plants*, United States Department of Energy, NETL.
- Götz, M. et al., 2016. Renewable Power-to-Gas: A technological and economic review. *Renewable Energy*, 85, pp.1371–1390.
- Guinot, B. et al., 2015. Profitability of an electrolysis based hydrogen production plant providing grid balancing services. *International Journal of Hydrogen Energy*, 0. Available at: <http://linkinghub.elsevier.com/retrieve/pii/S0360319915011775>
- Haldor Topsoe, 2011. From Coal To Clean Energy, Nitrogen+Syngas 310.
- Hinicio & LBST, 2016. *Power-to-Gas: Short term and long term opportunities to leverage synergies between the electricity and transport sectors through power-to-hydrogen*, Brussels/Munich. Available at: http://www.lbst.de/download/2016/Hinicio-LBST_2016_PtH2-study_Fondation-Tuck.pdf
- International Energy Agency, 2008. *CO2 Capture in the cement industry*, technical study, IEA Greenhouse Gas R&D Programme
- Investopedia, IRR Calculation. Available at: <http://www.investopedia.com/ask/answers/022615/what-formula-calculating-internal-rate-return-irr-excel.asp> [Accessed January 1, 2014a].

- Jentsch, M., Trost, T. & Sterner, M., 2014. Optimal use of Power-to-Gas energy storage systems in an 85% renewable energy scenario. *Energy Procedia*, 46, pp.254–261. Available at: <http://dx.doi.org/10.1016/j.egypro.2014.01.180>
- Kost, C. et al., 2013. *Levelized Cost of Electricity Renewable Energy Technologies*, Fraunhofer ISE, Freiburg.
- Lehner, M. et al., 2014. *Power-to-Gas: Technology and Business Models*, Springer, Linz.
- SBC Energy Institute, 2014. *Hydrogen-Based Energy Conversion*, factbook, Schlumberger. Available at: <http://www.sbc.slb.com/SBCInstitute.aspx>
- Sterner, M., 2009. *Bioenergy and renewable power methane in integrated 100% renewable energy systems. Limiting global warming by transforming energy systems*, PhD Thesis, University of Kassel. Available at: <http://www.upress.uni-kassel.de/katalog/abstract.php?978-3-89958-798-2>
- Haldor Topsoe, 2009. *From solid fuels to substitute natural gas (SNG) using TREMP*, technical report. Available at: [http://scholar.google.com/scholar?hl=en&btnG=Search&q=intitle:From+solid+fuels+to+substitute+natural+gas+\(SNG\)+using+TREMP™#4](http://scholar.google.com/scholar?hl=en&btnG=Search&q=intitle:From+solid+fuels+to+substitute+natural+gas+(SNG)+using+TREMP™#4).
- UN Industrial Development Association, 2010. *Carbon Capture Applications: and Storage in Industrial Technology*, Technology Synthesis Report
- Vandewalle, J., Bruninx, K. & D'haeseleer, W., 2015. Effects of large-scale power to gas conversion on the power, gas and carbon sectors and their interactions. *Energy Conversion and Management*, 94, pp.28–39.
- Zuberbühler, U., 2013. Power-to-Gas: experience with demo and pilot plants, up to 99% methane, IRES: International Renewable Energy Storage Conference, Dusseldorf

EVALUATION TECHNICO-ECONOMIQUE ET ENVIRONNEMENTALE DU STOCKAGE PAR METHANE DES ENERGIES RENOUVELABLES, DANS LES CONDITIONS SPECIFIQUES DE LA ROUMANIE ET DANS UN CAS GNERIQUE EUROPEEN

RESUME :

Dans le contexte de la transition énergétique, les grandes technologies de stockage d'énergie à grande échelle sont considérées comme l'une des options qui peut faciliter une pénétration élevée des sources d'énergie renouvelables. La thèse est concentrée sur l'évaluation de la mise en œuvre le Power-to-Gas sur le marché énergétique roumain, qui a enregistré une croissance significative des énergies renouvelables et les enjeux auxquels devra faire face. Après avoir établi l'approche générale, les deux voies techniques du Power-to-Gas, l'Hydrogène et SNG, sont techniquement dimensionnés et économiquement évalués du point de vue des investisseurs dans deux scénarios temporels (2015 et 2030), afin d'évaluer la situation économique actuelle et les prix appliqués pour atteindre une rentabilité positive. Les résultats indiquent que des facteurs de grande capacité sont nécessaires afin de compenser les coûts d'investissement élevés, mais même dans cette situation un prix élevé est nécessaire pour la faisabilité économique, 68,1 Euro / MWh pour la voie Hydrogène et 112 Euro/MWh pour Power-to Gas SNG. Le marché d'équilibrage est également étudié comme un marché à haute valeur ajoutée dans le contexte français, avec des résultats indiquant une amélioration de 4% de la NPV, mais soulignant également les limites dans le cadre de l'analyse. Un avantage significatif, en termes d'impact GWP et utilisation de l'énergie fossile, a été identifié dans l'évaluation du cycle de vie de base de plusieurs scénarios d'alimentation au gaz, qui a également révélé l'importance de la source d'électricité utilisée pour la compression d'hydrogène.

Mots clés : stockage d'énergie, Power-to-Gas, hydrogène, SNG

TECHNICAL, ECONOMIC AND ENVIRONMENTAL EVALUATION OF RENEWABLE ENERGY STORAGE AS METHANE IN THE CURRENT SPECIFIC ROMANIAN CONTEXT AND IN A GENERIC EUROPEAN CASE

ABSTRACT :

In the energy transition context, large scale energy storage technologies are considered as one of the options that can facilitate a high penetration of renewable energy sources. The Thesis focuses on evaluating the implementation of Power-to-Gas in the Romanian energy market that recorded a significant growth in the share of renewables and will potentially face the related issues. After establishing a general approach, the two technical pathways of Power-to-Gas, Hydrogen and SNG, are technically sized and economically evaluated from an investor's point of view in two temporal scenarios (2015 and 2030), in order to assess the current economic feasibility and the required price premiums that have to be put in place in order to reach a positive business case. Results indicate that high capacity factors are needed to compensate for the high capital costs, but even in this situation price premiums are required for economic feasibility, 68.1 Euro/MWh for the Hydrogen pathway and 112 Euro/MWh for Power-to-Gas SNG. The balancing market is also investigated as a high-value market in the French context, with results indicating a 4% improvement in NPV, but also highlighting the limitations of the proposed analysis framework. A significant benefit in terms of GWP impact and fossil energy use has been identified in the basic life cycle assessment of multiple Power-to-Gas scenarios that also revealed the importance of the source of electricity used for hydrogen compression.

Keywords : energy storage, Power-to-Gas, hydrogen, SNG