



EDITE - ED 130

Doctorat ParisTech

THÈSE

pour obtenir le grade de docteur délivré par

TELECOM ParisTech

présentée et soutenue publiquement par

Wiem SAMOUD

le 11 Octobre 2016

Analyse de Performance d'un Commutateur de Paquets Hybride Opto-Electronique Performance Analysis of Hybrid Opto-Electronic Packet Switch

Directeurs de thèse : **Cédric Ware** et **Mounia Lourdiane**

Jury

Mme Catherine LEPERS , Professeure, Télécom SudParis, Évry, France	Présidente
Mme Annie GRAVEY , Directrice d'étude, Télécom Bretagne, Brest, France	Rapporteuse
Mme Christine TREMBLAY , Professeure, École de Technologie Supérieure, Montréal, Canada	Rapporteuse
M. Nicola CALABRETTA , Maître de conférences, Technische Universiteit Eindhoven, Pays-Bas	Examineur
M. Dominique CHIARONI , Ingénieur de recherche, Nokia Bell Labs, France	Invité
Mme Esther LE ROUZIC , Ingénieure de recherche, Orange Labs, Lannion, France	Invitée
M. Cédric WARE , Maître de conférences - HDR, Télécom ParisTech, Paris, France	Directeur de thèse
Mme Mounia LOURDIANE , Maître de conférences, Télécom SudParis, Évry, France	Co-Directrice de thèse

TELECOM ParisTech

école de l'Institut Mines-Télécom - membre de ParisTech
46 rue Barrault 75013 Paris - (+33) 1 45 81 77 77 - www.telecom-paristech.fr

Résumé

La fibre optique demeure le support de transmission le plus utilisé, portant le trafic à une énergie par bit relativement faible. Cependant, à cause de l'absence de mémoire tout-optique pratique, la commutation de paquets est toujours exécutée électriquement. Les conversions Optiques Électriques Optiques (O-E-O) nécessaires font de la commutation l'un des domaines les plus consommateurs d'énergie. Ce problème est de plus en plus important spécialement avec la croissance exponentielle du trafic dans les réseaux optiques. Un défi majeur à prendre en considération dans la conception de futurs réseaux optiques est la restriction de leur consommation énergétique. De ce fait, dans le cadre de cette thèse, nous étudions un commutateur hybride opto-électronique qui consiste en une matrice de commutation optique complétée par une mémoire électronique partagée.

L'analyse de performance prenant en compte différentes classes de service, distributions de paquets et méthodes de connectivité du commutateur (canaux WDM et/ou SDM), montre que, grâce aux stratégies de commutation établies, le commutateur hybride répond aux besoins de toutes les classes de service en termes de taux de perte de paquets, la charge durable du système et la latence. De plus, il réduit significativement les conversions O-E-O par rapport aux commutateurs électriques commercialisés, puisqu'ils n'auront lieu que pour les paquets mis en mémoire d'attente. Nous défendons que le commutateur de paquets hybride opto-électronique satisfait les exigences en qualité de service et pourrait être une solution prometteuse pour réduire la consommation d'énergie des réseaux optiques.

Mots-clefs : commutation de paquets, gestion de contention, composants opto-électronique, réseaux optiques, consommation énergétique.

Abstract

Most transmission systems are based on optical fibers, carrying the traffic at a relatively low energy per bit. However, due to the lack of mature optical buffers, packet switching is still performed electrically. The required Optical-Electrical-Optical (O-E-O) conversions make the switching one of the areas with the fastest-growing energy consumption. A major challenge that must be met in designing future optical networks is curbing their energy consumption. Therefore, within this thesis, we investigate a hybrid optoelectronic switch which consists of an optical switching matrix supplemented with a shared electronic buffer.

Performance analysis taking into account different classes of service, packet classifications and switch connectivity methods (WDM and/or SDM channels), shows that, thanks to the established switching strategies, the hybrid switch satisfies the requirements of all the different classes of service in terms of Packet Loss Rate, sustainable system load and latency. Moreover, it significantly reduces the O-E-O conversions compared to commercial off-the-shelf electrical switches, since they occur only for buffered packets. We defend that the hybrid opto-electronic packet switch meets the requirements on quality of service and could be a promising solution to reduce the energy consumption of optical networks.

Key words: packet switching, contention resolution, opto-electronic components, optical networks, energy consumption.

To my Land
To my parents

Acknowledgments

I would like to express my sincere gratitude to my supervisors, Dr. Cédric Ware and Dr. Mounia Lourdiane for their guidance, wise advices and their great skills. The door of Cédric's office was always open whenever I had questions or need to discuss with him. His passion and enthusiasm for scientific research are contagious and very inspiring. Thanks for having believed in me and giving me the opportunity of an international collaboration within my stay at Columbia University. Mounia assisted me with her knowledge and stimulating regular discussions. I really appreciate her skills of structuring ideas and papers. Her guidance and motivation helped me a lot. Besides their complementary knowledges in the fields of optical components, networks, simulations, performance analysis..., Cédric and Mounia are very kind persons and it was a great pleasure to work with both of them. Thank you for letting my Ph.D. be an enjoyable and productive experience!

I would also like to thank my committee members, Prof. Catherine Lepers for agreeing to chair the jury, Prof. Annie Gravey for the devoted time and the very valuable comments, Prof. Christine Tremblay, who patiently read my thesis, for the brilliant suggestions that served to ameliorate the quality of my redaction, Dr. Nicola Calabretta and our industrial guests Mr. Dominique Chiaroni and Ms. Esther Le Rouzic for the inspiring questions and the relevant comments and suggestions.

My Ph.D. studies were principally financed by the Tunisian Ministry of Higher Education and Scientific Research. I would like to thank the scholarships' committee who believed in me and selected my application. I thank the Tunisian consulate and the academic mission of Tunisia in Paris for their assistance.

I address my gratitude to our group "Groupe de Télécommunications Optiques" researchers: Prof. Didier Erasme, Prof. Yves Jaouen, Dr. Renaud Gabet, Prof. Philippe Gallion and Dr. Frédéric Grillot for their encouragement and advices on research, scientific presentations and teaching. I thank the head of our department, Prof. Bruno Thedrez, the head of the doctoral school, Prof. Alain Sibille and the administrative staff Chantal Cadiat, Yvonne Bansimba, Zouina Sahnoune, Hamidou Kone, Florence Besnard and Marianna Baziz for their availability and help.

I would like to thank Prof. Keren Bergman, head of the Electrical Engineering department at Columbia University in New York, for the opportunity to work with her group in the Lightwave Research Laboratory. I thank Dr. Payman Samadi for the opportunity to contribute to his project, Dr. Sébastien Rumley for the inspiring discussions, and all the LRL members for their kind welcome.

My gratitude goes also to the supervisors of my internship in Télécom SudParis, Dr. Yann Frignac and Dr. Petros Ramantanis, and to my teachers in Sup'Com Tunis, Dr. Mourad Menif and Prof. Mourad Zghal. They gave me motivation and enthusiasm to go forward in the field of optical communication.

Contents

Résumé	ii
Abstract	iii
Acknowledgments	v
Contents	vii
List of Figures	ix
List of Tables	xii
Glossary	xiii
General Introduction	1
Commercial Off-The-Shelf Packet Switches: energy consumption issue	1
All-Optical Packet Switches: lack of mature optical buffers	2
Hybrid Opto-Electronic Switch	3
Outline	3
Framework	4
1 Introduction to optical networks	7
1.1 Introduction	7
1.2 Description of optical networks	7
1.3 Evolution of optical networks	11
1.4 Vision on packet switching in optical networks	29
1.5 Conclusion	30
2 Performance analysis of hybrid opto-electronic packet switch connected through interchangeable channels	31
2.1 Introduction	31
2.2 Architecture of our hybrid switch	32
2.3 Switching performance criteria	33
2.4 Simulation conditions and setup	34
2.5 Performance achieved	38
2.6 Conclusion	47
3 Performance analysis of hybrid opto-electronic packet switch supporting wavelength-specific packets	51

3.1	Introduction	51
3.2	Switch performance when connected through WDM channels	52
3.3	Performance improvements using Space Division Multiplexing (SDM) in addition to WDM	58
3.4	Supporting specific traffic profile	63
3.5	Conclusion	66
4	Minimizing EDFA power excursions through a machine learning approach	69
4.1	Introduction	69
4.2	An overview of EDFAs	70
4.3	EDFA power excursions	71
4.4	Laboratory experiment: collecting data of power excursions	72
4.5	Machine learning approach: minimizing power excursions	74
4.6	Conclusion	78
	General conclusions and perspectives	79
A	List of publications	83
B	Buffer input ports access management	85
C	Distribution of the delays	87
D	Synthèse en Français	91
	Bibliography	97

List of Figures

0.1	Electrical switch architecture	2
0.2	All-optical switch architecture	2
1.1	Telecommunication network architecture: core, metro and access networks	9
1.2	Evolution of “capacity x distance” of optical transmission systems, inspired from: “EDFA, principe et application” E. Desurvire, Wiley 2002	12
1.3	Evolution of the transmission technology in 1 st generation optical networks	13
1.4	Layered architecture in optical networks, inspired from [1]	14
1.5	An Optical Add/Drop Multiplexer	15
1.6	A 3-port optical circulator	16
1.7	2 × 2 coupler	17
1.8	4 × 4 star coupler	17
1.9	3 × 3 passive wavelength router	18
1.10	MPLS operating mode, 1.a: Routing protocols exchange reachability to destination networks; 1.b: LDP establishes label mappings to destination network; 2: Ingress LER receives packets and adds labels; 3: LSR forwards packets using label swapping; 4: Egress LER removes labels and delivers packets. Adapted from [2]	20
1.11	Evolution of protocols in optical networks	21
1.12	Basic OCS architecture, inspired from [3]	22
1.13	Basic Store-and-Forward asynchronous OPS architecture, inspired from [3]	23
1.14	Reamplifying, reshaping and retiming functions	24
1.15	OBS architecture, inspired from [3]	25
1.16	SDN based unified control plane architecture	28
2.1	Hybrid switch architecture	32
2.2	Classification of services based on different granularity levels, inspired from [4]	35
2.3	Switching strategy, hybrid switch connected via interchangeable channels	36
2.4	PLR _D vs system load, $n_a = 8$, $n_c = 8$ interchangeable channels	39
2.5	PLR _F vs system load, $n_a = 8$, $n_c = 8$ interchangeable channels	39
2.6	Sustainable system load vs $n_e/(n_a \times n_c)$ at PLR _D = 10^{-4} , $n_a = 8$	40
2.7	Sustainable system load vs $n_e/(n_a \times n_c)$ at PLR _F = 10^{-4} , $n_a = 8$	40
2.8	histogram - occurrence’s percentage of the number of packets buffered and being buffered, $n_a = 8$, $n_c = 8$, $n_e = 12$, Left: $\rho = 1$, Right: $\rho = 0.8$	42
2.9	histogram - occurrence’s percentage of the number of packets buffered and being buffered, $n_a = 8$, $n_c = 8$, $n_e = 20$, Left: $\rho = 1$, Right: $\rho = 0.8$	42

2.10	Delays of R, F and D packets vs system load, (a): $n_a = 8, n_c = 8$; (b): $n_a = 10, n_c = 10$; (c): $n_a = 10, n_c = 20$	43
2.11	Nbr of packets successfully sent to their destinations, directly or after bufferization, vs system load, $n_a = 8, n_c = 8, n_e = 12$	44
2.12	Delay vs system load, Technique of re-emission: re-emission prioritization (thin curves) vs FIFO (bold curves), $n_a = 8, n_c = 8$	45
2.13	Reduction of O-E-O conversions vs system load, $n_a = 8, n_c = 8$	46
2.14	Comparison between different packet classes distributions in terms of PLR, $n_a = 8, n_c = 8, n_e = 12$	48
2.15	Comparison between different packet classes distributions in terms of latency, $n_a = 8, n_c = 8, n_e = 12$	48
2.16	Comparison between different packet classes distributions in terms of O-E-O reduction, $n_a = 8, n_c = 8, n_e = 12$	49
3.1	Sustainable system load at $PLR_D = 10^{-4}$ (Left) and $PLR_F = 10^{-4}$ (Right) vs $n_e/(n_a \times n_c)$, $n_a = 8, n_c \in \{1, 4, 8, 20, 30\}$ WDM channels	53
3.2	The switching policy in WDM systems	54
3.3	Sustainable system load at $PLR_D = 10^{-4}$ (Left) and $PLR_F = 10^{-4}$ (Right) vs $n_e/(n_a \times n_c)$, $n_a = 8$ and $n_c = 8$ interchangeable or WDM channels, $n_{wvcv} \in \{0, 1, 2, 3\}$	55
3.4	Delays of R, F and D packets vs system load, $(n_a, n_c, n_e) = (8, 8, 30)$	56
3.5	Minimum reduction of O-E-O conversions vs $n_e/(n_a \times n_c)$, $n_a = 8, n_c = 4$ (Left) or $n_c = 8$ (Right)	57
3.6	Rate of wavelength conversions vs system load, $n_a = 8, n_c = 4$ (Left) or $n_c = 8$ (Right)	57
3.7	Architecture of (a) SMF, (b) MMF and (c) 7-core fibers	59
3.8	Architecture of hybrid switch connected to SDM-WDM channels	59
3.9	Sustainable ρ vs $n_e/(n_a \times n_c \times n_\lambda)$ at $PLR_F = 10^{-4}$, $n_a = 8, n_c = 8$ for interchangeable or WDM-only channels, $n_c = 4$ and $n_\lambda = 2$ for SDM-WDM links	60
3.10	Sustainable ρ vs $n_e/(n_a \times n_c \times n_\lambda)$ at $PLR_F = 10^{-4}$, $n_a = 4$, SDM+WDM links, $n_c = 2$ (like 2-mode WMMF fibers)	61
3.11	Sustainable ρ vs $n_e/(n_a \times n_c \times n_\lambda)$ at $PLR_D = 10^{-4}$, $n_a = 8, n_c = 1, 2$ or 7 (like 7-core fibers)	62
3.12	Sustainable ρ vs $n_e/(n_a \times n_c \times n_\lambda)$ at $PLR_F = 10^{-4}$, $n_a = 8, n_c = 1, 2$ or 7	62
3.13	Switching delay vs system load ρ , $n_a = 8, n_c = 2$ and $n_\lambda = 4$ for SDM-WDM channels, $n'_c = 8$ for interchangeable or only-WDM channels, and $n_e = 30$	63
3.14	O-E-O reduction vs $\rho, n_a = 4, n_c = 2$ SDM channels	64
3.15	λ conversions rate vs $\rho, n_a = 4, n_c = 2$ SDM channels	64
3.16	Sustainable ρ vs $n_e/(n_a \times n_c \times n_\lambda)$ at $PLR_D = 10^{-4}$, $n_a = 8, n_c = 7, n_\lambda = 4$, for C_{general} and C_{specific} packet classifications	65
3.17	Sustainable ρ vs $n_e/(n_a \times n_c \times n_\lambda)$ at $PLR_F = 10^{-4}$, $n_a = 8, n_c = 7, n_\lambda = 4$, for C_{general} and C_{specific} packet classifications	65
3.18	Sustainable ρ vs $n_e/(n_a \times n_c \times n_\lambda)$ at PLR_R null, $n_a = 8, n_c = 7, n_\lambda = 4$, for C_{general} and C_{specific} packet classifications	66
3.19	Delays vs $\rho, n_a = 8, n_c = 7, n_\lambda = 4, n_e = 100$, for C_{general} and C_{specific} packet classifications	67

4.1	One-pumping-laser EDFA principle, schematic figure	70
4.2	Schematic figure: AGC amplifier output spectrum, adding a channel with (A) high or (B) low gain	71
4.3	Setup of the lab experiment, WDM multi-span EDFA network	73
4.4	Screen capture of the OPM software, 24 wavelengths are ON	74
4.5	STD prediction MSE for LR and KBR models, 2-span and 3-span EDFA networks	76
4.6	Comparison between predictions and measurements for single channel add (left) or drop (right) in 2-span EDFA network	77
4.7	Comparison between predictions and measurements for single channel add (left) or drop (right) in 3-span EDFA network	77
B.1	Packet Loss Rates of H, M and L classes vs system load ($n_a = 10$, $n_c = 10$, $n_e = 30$) (a): FIFO and Preempt Trans. (b): Sharing and Preempt Trans. (c): FIFO and Preempt Trans. then Preempt Buff. (d): FIFO and Preempt Buff. then Preempt Trans.	86
C.1	nbr of buffered then switched R packets vs system load, $n_a = 8$, $n_c = 8$, $n_e = 12$	88
C.2	nbr of buffered then switched F packets vs system load, $n_a = 8$, $n_c = 8$, $n_e = 12$	88
C.3	nbr of buffered then switched D packets vs system load, $n_a = 8$, $n_c = 8$, $n_e = 12$	88
C.4	nbr of buffered then switched R packets vs system load, $n_a = 8$, $n_c = 8$, $n_e = 20$	88
C.5	nbr of buffered then switched F packets vs system load, $n_a = 8$, $n_c = 8$, $n_e = 20$	88
C.6	nbr of buffered then switched D packets vs system load, $n_a = 8$, $n_c = 8$, $n_e = 20$	89
D.1	Architecture d'un commutateur électrique	91
D.2	Architecture d'un commutateur tout-optique	92
D.3	Architecture du commutateur hybride opto-électronique	93
D.4	Architecture du commutateur hybride opto-électronique avec des connexions optiques SDM-WDM	94

List of Tables

1.1	Comparison between OCS, OPS and OBS	26
4.1	Training and testing sets sizes	76

Glossary

ATM	Asynchronous Transfer Mode
CAPEX	Capital expenditures
CD	Chromatic Dispersion
CMA	Constant Modulus Algorithm
CoS	Class of services
DCF	Dispersion Compensation Fiber
DSP	Digital Signal Processing
DWDM	Dense Wavelength Division Multiplexing
EDFA	Erbium-Doped Fiber Amplifier
FWM	Four Wave Mixing
FTTX	Fiber To The X
GMPLS	Generalized Multi-Protocol Label Switching
GPRS	General Packet Radio Service
LED	Light-Emitting Diode
LO	Local Oscillator
ML	Machine Learning
MPLS	Multi-Protocol Label Switching
MSE	Mean Square Error
MZI	Mach-Zehnder Interferometer
OADM	Optical Add Drop Multiplexer
OBS	Optical Burst Switching
OC	Optical Carrier
OCS	Optical Circuit Switching
O-E-O	Optical-Electrical-Optical
OFDM	Orthogonal Frequency Division Multiplexing
OPEX	Operational expenditure
OPS	Optical Packet Switching
OSNR	Optical Signal to Noise Ratio
OTN	Optical Transport Network
PDM	Polarization Division Multiplexing
PLR	Packet Loss Rate
QoS	Quality of Service
ROADM	Reconfigurable Optical Add Drop Multiplexer
SAP	Service Access Point
SDH	Synchronous Digital Hierarchy
SDM	Spacial Division Multiplexing
SDN	Software Defined Network
SONET	Synchronous Optical Network

STD	Standard Deviation
STS	Synchronous Transport Signals
TCP	Transmission Control Protocol
TDM	Time Division Multiplexing
UMTS	Universal Mobile Terrestrial System
VoIP	Voice over IP
WDM	Wavelength Division Multiplexing
WSS	Wavelength Selective Switch

General Introduction

Telecommunication networks have evolved in order to fulfil the growing demand of bandwidth, long transmission distances and good quality of service. Nowadays, optical fibers are the main data carrier for ultra high bit rate transmission, in core, metro and even in access networks. Telecommunication networks based on optical fibers are also called optical networks, even though other technologies (electronics, radio) may be involved too.

Optical networks are far more reliable and faster, consume less energy, and offer greater transmission capacity than conventional copper-wire or radio networks. They experienced up to five generations marked by several evolutions of optical components, technologies and protocols. However, point to point transmissions don't involve traffic routing across all the network. In fact, current optical networks still include several electronic equipments, especially in the intermediate nodes such as switches and routers.

For the past few years, all traffic has been transported as packets, mostly as IP packets. These packets may carry control information, digital data (file transfer), voice (voice over IP), streaming video, on-demand video... Packet switching has its benefits and drawbacks compared to circuit and burst switching. Yet, nodes should ideally exploit packet switching since the packet is the most common form of transporting data. In current optical networks, off-the-shelf packet switches are electrical ones.

Commercial Off-The-Shelf Packet Switches: energy consumption issue

Although most traffic is carried as optical signals, at a relatively low energy per bit, packet switching cannot currently be performed in the optical domain. All traffic transmitted on optical fibers over a great number of channels per fiber, must be demultiplexed, converted to the electrical domain at switches level, processed separately, and then re-converted to optical signals for further transmission. Reamplifying, reshaping and retiming (3R) functions are done electronically. Consequently, numerous optical-electrical-optical (O-E-O) conversions are required. The schematic architecture of an electrical switch is presented in Figure 0.1.

The O-E-O conversions required for packet switching are energetically costly. Therefore, switching remains one of the areas with the fastest-growing power consumption [5]. We note that Internet's infrastructure consumes approximately 1% of a developed nation's total electricity consumption [6], besides, networks electricity consumption is growing at a rate of 10% per year [7].

With the exponential increase of traffic and the need to support new services, the power consumption is becoming one of the largest budget items. Thus, a major challenge

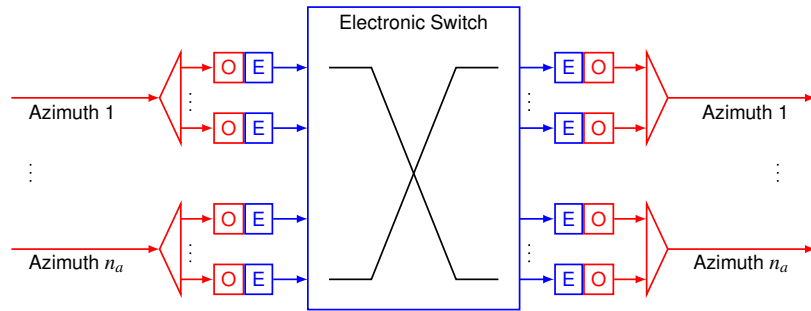

Figure 0.1: *Electrical switch architecture*

that must be met in designing future optical networks is curbing their energy consumption [8]. A way to address this problem is to study different switching technologies that may provide economical energy consumption.

All-Optical Packet Switches: lack of mature optical buffers

Some researchers look ahead to "all-optical" networks, where switching is done optically from one end-user to another. All-optical packet switches (OPS) would do away with O-E-O conversions and reduce energy consumption. Generally, optics lead to lower energy cost per bit transmitted and some studies arguments that OPS would be a great way to achieve energy efficiency in the fiber-optics realm [9, 10]. The architecture of an all-optical bufferless switch is presented in Figure 0.2.

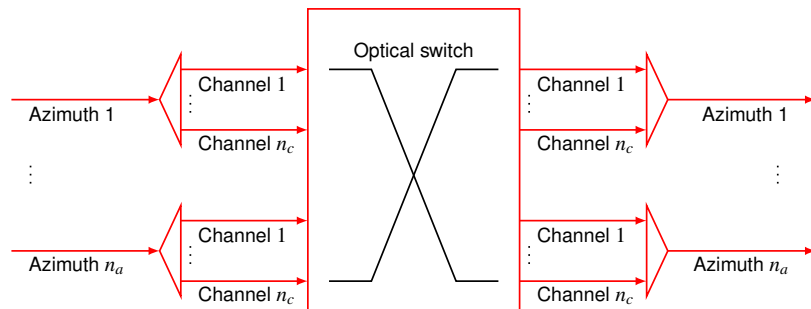

Figure 0.2: *All-optical switch architecture*

Since the years 2000's, several studies have been done on optical packet label conception [11], recognition and swapping [12, 13]. 3R regeneration is possible in the optical domain [14]. Besides, the clock extraction and synchronisation in all-optical switches has been evolved [15]. However, all-optical switching solutions have not yet been commercialized. The main problem met using all-optical packet switches in optical networks is

the lack of mature optical buffers. In fact, the storage of optical signals remains an almost impossible and expensive operation.

Without practical and mature optical buffers, all-optical packet switches are extremely vulnerable to contention. We remind that contention takes place when two (or more) coincident packets are to be forwarded to the same output port. To resolve the contention, one of the packets must be buffered, or routed to another destination depending on a strategy of deflection routing. For IP traffic, the proper contention solution is buffering. If it is not possible to resolve the contention, at least one of the packets in contention will be dropped.

Because of the difficulty of resolving packet contention, all-optical packet switches lead to notable Packet Loss Rates (PLR) even at unrealistically low loads [16, 17, 18]. Thus, they haven't been deployed operationally yet.

Hybrid Opto-Electronic Switch

Instead of trying to completely replace electrical packets switches by optical ones, a smarter approach could be combining the benefits of the two fields, electronics and optics. Roles are assigned according to abilities: electronics perform complex processing, while optics transmit packets rapidly and at a lower energy cost.

Therefore, a hybrid optoelectronic switch was proposed [19] and demonstrated [20, 21]. It consists of an optical switching matrix supplemented with a shared electronic buffer. Packets are switched optically through the switching matrix whenever it is possible, otherwise, in case of contention, they will be stored into the buffer. The hybrid switch doesn't do away with all O-E-O conversions, but limits them to the cases where contention would have resulted in packet loss.

Compared to all-electrical switches, energy consumption could be reduced since O-E-O conversions will take place only for buffered packets. Moreover, previous performance analyses show that, compared to all-optical switches, the hybrid switch leads to better performance since it could better resolve packet contention thanks to its electronic buffer [22]. The architecture of our hybrid switch will be presented in Figure 2.1.

Outline

Our work falls within the context of non-conventional network architectures, able to coexist with existing applications while making the most of optical technologies. Optics would not only be used for information transmission, reduced to the physical layer of conventional networks, but also would be integrated in the higher functionality of packet switching. Moreover, our target is not to avoid completely electronic technologies, that are perfect for data processing and storing, but to use them alongside with, and at the service of optics. Therefore, we aimed in particular to investigate the performance of the hybrid opto-electronic packet switch that could be a potential solution to reduce networks' energy consumption.

In chapter 1 of this manuscript, we present an overview of optical networks: their structure, their challenges, and the benefits and drawbacks of optical transmission. We depict the evolution of optical networks and technologies from their first to the fifth

generation. We present also the state of the art in studies related to hybrid optoelectronic packet switches. The next chapters are dedicated to our contributions.

In chapter 2, we analyse the performance of the hybrid switch taking into account different classes of service. This implies the establishment of switching, buffer access and buffered-packet re-emission strategies that permit to meet the requirements of each class in terms of the quality of service (QoS). We first assume that our hybrid switch is connected to other nodes through interchangeable Space Division Multiplexed (SDM) channels. We consider as performance criteria the Packet Loss Rate (PLR), the sustainable system load [23, 24], and also the switching latency [25, 26].

We extend our investigation in chapter 3 by simulating our switch connected to other nodes via Wavelength Division Multiplexed (WDM) channels. Adding the wavelength constraint, we expect a degradation of switching performance compared to the case of interchangeable channels [27]. Thus, we propose two solutions to offer some interchangeability while using the switch in a WDM context. The first solution is supplementing the hybrid switch with shared wavelength converters [28]. We will discuss if the energy consumption of those converters may negate the energy savings achieved by the hybrid switch compared to electrical switches. The second solution is combining SDM and WDM at the level of the connected optical ports: connecting the switch to SDM (multimode or multicore) fibers supporting WDM on each mode or core [29, 30]. We will show that high sustainable system load, low switching latency and a significant reduction of O-E-O conversions are achieved.

The quality of service could be associated with the quality of transmission, for instance, a higher-priority packet should be switched via a higher-power channel. We remind that adding (or dropping) a channel to (or from) a WDM system based on multi-span EDFA transmission may lead to power excursions. So, a potential wavelength conversion of a packet should take into consideration its class of service, the existing wavelengths in the system, and the classes of service of other switched packets at that time. Therefore, we propose in chapter 4 a Machine Learning (ML) approach that could give the best recommendation of which wavelength to add (or drop) to (or from) a WDM system with minimal power excursions. Laboratory experimental work is done to train and test our ML approach. The application of our ML approach is not reduced to the choice of a wavelength to which a packet should be converted in order to minimise power excursions and achieve best switching performance considering the different classes of service, but it is applicable to different architectures of WDM multi-span EDFA networks [31, 32].

Finally, we summarize the lessons learned in this manuscript and conclude on the benefits of the hybrid optoelectronic switch that could be a promising solution to curb networks energy consumption. Further studies are recommended as perspectives of this work.

Framework

Within the Ph.D. program of doctoral school "École Doctorale en Informatique, Télécommunication et Électronique (EDITE)" of Paris, research works are done in Télécom ParisTech, Université Paris-Saclay under the supervision of Dr. Cédric Ware, associate

professor-HDR in Télécom ParisTech and Dr. Mounia Lourdiane, associate professor in Télécom SudParis.

Part of this work (chapter 4) was achieved during my 4-month stay in the Lighthwave Research Laboratory of Columbia University in New York, within the initiation of an exchange program between our institution Télécom ParisTech, Université Paris-Saclay and Columbia University.

This thesis is mainly financed by a 3-year scholarship grant provided by the Tunisian Ministry of Higher Education and Scientific Research based on academic excellence criteria.

The work presented in this manuscript has led to publications presented in appendix A.

Chapter 1

Introduction to optical networks

1.1 Introduction

The incorporation of optical fiber in telecommunication networks has significantly improved their performance and impacted our society: high data rates, long intercontinental reaches, low latency, reliable networks are achieved.

In fact, the exponential traffic growth in “big data” generation and cloud-based services couldn’t be managed without the use of optical components and technologies. Besides, studies on optical communications must continue to address the key requirements of future networks, which are the increasing demand on high data rate transmission and the reduction of their cost and energy consumption.

In section 1.2, we begin with a description of telecommunication networks: composition, challenges and classifications. Then, we focus specifically on optical networks. We depict the advantages and the limitations of optical transmission, on which optical networks are based.

Since their use in 1980’s, optical networks have known important and steady evolution, experienced several generations which we present in section 1.3. A particular attention is given to the 4th generation marked by optical switching.

In section 1.4, we present our vision on packet switching in optical networks: instead of commercial off-the-shelf electrical switches that are energetically costly, and all-optical switches that are not practical and vulnerable to contention, hybrid opto-electronic switches could be a good compromise and a key solution to reduce the energy consumption with a proper management of packet contentions.

1.2 Description of optical networks

An optical network is a high-capacity telecommunication network in which information is transmitted mostly through optical fibers. We begin with generalities on telecommunication networks.

1.2.1 Telecommunication networks

A telecommunication network is a collection of nodes and links to enable communication at a distance according to protocols. This definition seems to be obvious thanks to the impact of telecommunication networks in our daily lives. For examples, the tele-

phone network, the radio broadcasting system, computer networks and the Internet are all telecommunication networks. The nodes in the network are the devices used to enable the information transmission and processing, such as repeaters, routers or data centers. The links are the transmission medium which carry the information from a device (emitter) to another (receiver). They may be wired links, such as twisted pairs, coaxial cables and optical fibers, or wireless links through electromagnetic waves.

1.2.1.1 Telecommunication networks challenges

The "classical" challenge in designing telecommunication networks is to provide a big **transmission capacity**, i.e. an important transmission rate, through long distances. Telecommunication networks have been remarkably developed to provide several services (e-mail, e-administration, e-commerce, e-health, e-education...) at a good quality and with high transmission capacity. For instance, Alcatel-Lucent launched in 2015 a 1-port 400 Gb/s Internet Protocol (IP) line card for IP networks that connects routers at speeds of 400 Gb/s line rate over hundreds of kilometers [33]. However, since the amount of data circulating on networks is exponentially increasing, responding to the need of networks customers in terms of transmission capacity is and will always be a challenge.

A second important challenge is to reduce and achieve reasonable **cost**, which is composed by:

- Capital expenditures (CAPEX) that are calculated based on equipment costs such as : network links, intermediate nodes... The reference [34] presents the CAPEX's evolution of different competitive telecommunication operators. For example, the CAPEX of the telecommunication operator Zayo has risen by 10% from 2013 to 2015.
- Operational expenditures (OPEX) that include the costs generated during network lifetime such as energy consumption, network supervision and maintenance.

The audit firm EY presents the evolution of these expenditures in European telecommunications operators and the keys to optimize them [35]. Recent studies are done on flexible networks that assume the use of tunable transponders (also called bandwidth variable transponders BVT) and a flexible spectrum grid [36]. These elastic networks may reduce both capital and operational expenditures [37].

Energy consumption has been increasingly an issue of telecommunication networks. It is growing at a rate of 10% per year [7]. Its reduction is a relatively new, but important challenge. For instance, Internet's infrastructure consumes approximately 1% of a developed nation's total electricity consumption [6]. The network energy consumption includes the power supply of nodes and command systems, but switching function is the most energy consuming field [5]. Considering optical networks, the Optical-Electrical-Optical conversions at the level of switches and routers are energetically costly [8].

1.2.1.2 Telecommunication networks structure

Three main categories of telecommunication networks can be distinguished from the point of view of their geographical scope: access, metro and core network. This general classification is depicted in Figure 1.1.

Access network is the part of a telecommunication network, which connects the subscribers to the network operator (or service provider) over a distance of a few (≤ 10) kilometers. Based on the operator point of view, the access network is also called the

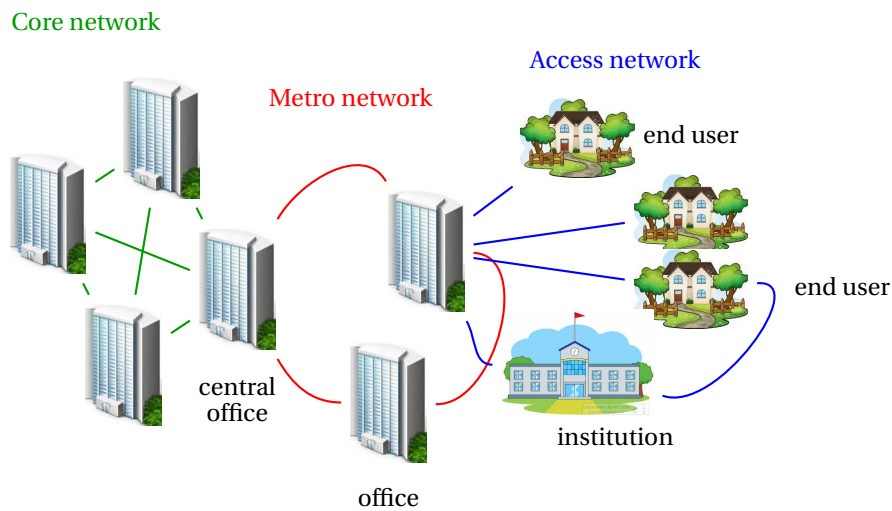

Figure 1.1: *Telecommunication network architecture: core, metro and access networks*

last-mile network. Different kinds of links have been proposed to access networks, namely copper wires, such as twisted pair and xDSL technologies, wireless links, such as WiFi and WiMax, and optical fibers. Among them, optical technologies are emerging as promising solutions for last mile access, because of the potential of optical transmission (low loss, large bandwidth, noise isolation...) [38, 39]. Fiber access networks are also referred to as Fiber-To-The-x (FTTx) system, where "x" can be "home", "building", "curb"... depending on how deep in the field fiber is deployed or how close it is to the end user. In a fiber-to-the-home (FTTH) system, fiber is connected all the way from the service provider to household users. Local routers transport the traffic from the access network to the metro network. The local routers are also called access routers. Their capacity is relatively low. For example, Cisco 3850 local switch permits to connect up to 48 Ethernet ports with a rate of 1 Gb/s per subscriber and up to 40 Gb/s of wireless capacity [40].

Metro (metropolitan) or regional network covers typically large metropolitan areas (up to 200 km [41]). It is also called distribution or aggregation network since it is the intermediate network between core (metro-core) and access networks (metro-access). In general, metro networks are publicly owned, allowing all telecommunication operators open access to the networks.

Metro networks were based largely on Synchronous Optical Networking (SONET) and Synchronous Digital Hierarchy (SDH) [42] which are usually constructed as a series of protected rings that allow fast fail-over to the alternate "rotation" if a fiber is cut. Rings are connected via optical add/drop multiplexers (OADMs). Nowadays, metro networks are based on wavelength division multiplexing (WDM) systems which increase greatly the transmission capacity.

Information of different types (voice, digital data, video...) is transmitted as IP packets. The balance is being changed between electrical and optical components in metro networks for transmission function. It is almost entirely carried on optical fibers and other electrical functionalities are progressively being replaced by optical technologies (amplification, coherent detection, bypass, circuit switching...). Several research and industrial works are done in this context [43]. However, optics do not yet perform high functionalities such as

packet switching and routing, that are still assured with electronics. Optical-Electrical-Optical conversions are thus required.

The routers of the metro network have to add and drop traffic to and from the metro network, solve the potential issue of link failures, serve as a pass-through hub for core network traffic, manage different services... The routers used in metro-core part have higher capacity than those of metro-access part, in the order of 100 Gb/s and higher for metro-core routers debit, compared to 10 to 40 Gb/s for metro-access routers [44, 45, 46].

Core networks, also called backbone or long-haul networks, are used between long distance nodes such as continents. The core network is the central part of a telecommunication network. It provides interconnectivity of metro and access networks, high capacity and reliable backbone infrastructure. Information from metro networks is aggregated [47]. The core network may also provide the gateway to other networks. The transmission in core network is generally based on optical fibers using WDM, in which case, the telecommunication network may be called as an **optical network**.

1.2.2 Advantages and Limitations of optical transmission

An optical (photonic, or light-wave) network is a high-capacity telecommunication network in which information is transmitted as optical signals, through optical fibers. We note that the first ITU-T handbook related to optical fibers was published in 1984. Its title is "Optical Fibres for Telecommunications". Since optical fibers are the unrivaled carriers of data traffic over the world in core, metro and access networks, most telecommunication networks are considered as optical ones.

Optical network is based on optical technologies and components, but it does not necessarily imply a "purely optical network", it includes also electronic devices namely electronic switches and routers.

1.2.2.1 Advantages

A few of the most important reasons for migrating to optical networks (rather than electrical and wireless ones) are:

- **Large optical bandwidth** permits high data rate transmission, which also supports the aggregation of voice, video, and data. In addition, with the use of WDM, Polarization Division Multiplexing (PDM) and/or in the near future Space Division Multiplexing (SDM), many signals could be sent simultaneously on one fiber, the capacity of transmission is thus higher.
- Optical fiber has **low attenuation**, the signal power goes down by only 0.2 dB/km or lower. This means that the transmission distance (**reach**) may be extended and that the number of optical amplifiers needed is relatively small (1 amplifier per 80 km in transmission systems).
- **Immunity** to electromagnetic interference (EMI), radio-frequency interference (RFI), crosstalk, impedance problems... This immunity reduces the bit error rate (BER) and eliminates the need for shielding within or outside a building.
- Light as a transmission medium provides the ability for the use of optical fiber in **dangerous environments**. Fiber is less susceptible to temperature fluctuations and fires than copper and can be submerged in water.
- Optical fiber is difficult to tap since it doesn't radiate signals, thus it provides a higher degree of **security** than possible with copper wire.

- **Light weight** and **small diameter** of fiber permit high capacity through existing conduits.
 - Optical fibers are relatively **cheap** compared to copper lines.
- We note that in case of a fiber cut or physical security attack, it is possible to determine the place of damage with precision thanks to the **reflectometry**.

1.2.2.2 Limitations

Optical networks have also some drawbacks, such as:

- The optical fiber **installation cost** is quite high, much more important than the cost of the fiber itself. According to [48], civil works cost is the major share of FTTx deployment, while the fiber cost is only 6%. Moreover, expensive precision splicing and measurement equipment are required. The U.S. Department of Transportation, Research and Innovative Technology Administration (RITA) offers fiber optic cable installation costs for various projects [49].
- Copper cables can carry data as well as power, a last-mile switch or a terminal (for instance a phone) needs just to be branched to the network extremity, the power comes from the distribution central. This is not the case of optical fiber cables which carry only data. An Optical Network Terminal (ONT) must be connected to the optical fiber which carries the data, but also to the power source or outlet.
- Although most wired traffic is transmitted through optical fibers, especially in core and metro networks, packet switching and routing are still performed with electronics, except for quasi-static routing. Thus, packets must be converted to the electronic field at the level of the switch or router and then reconverted to the optical field for further transmission. These required **Optical-Electrical-Optical (O-E-O) conversions are energetically costly**. Despite several researches on all-optical switches that could do away with O-E-O conversions, **all-optical buffering solutions** (such as Fiber Delay Lines FDL) are still **not practical** or not mature enough to store packets. Without them, all-optical switches are vulnerable to contention and lead to high Packet Loss Rates (PLR) [16, 18]. My thesis deals with this context (see section 1.4). We investigated a hybrid switch that consists of an optical switching matrix supplemented with a shared electronic buffer that collects packets in case of contention. The goal of using this hybrid switch is to reduce the O-E-O conversions (just to the number of buffered packets) compared to electronic switches, while maintaining acceptable switching quality, namely acceptable PLR thanks to the possibility of contention resolution.

1.3 Evolution of optical networks

Figure 1.2 presents the evolution over the years of the product of transmission capacity (Gb/s) and distance (km). It outlines also the major technologies that permitted the evolution of optical networks from a generation to another. An important step in the evolution of optical systems is the development of Erbium Doped Fiber Amplifier (EDFA) in the 90's which permits to achieve higher propagation distances [50]. Wavelength Division Multiplexing (WDM), invented in 1992, offers a multiplication of the transmission system capacity since it permits to carry multiple communication channels over one physical optical fiber with each channel operating on a different wavelength. It is noted that EDFA amplifiers may amplify several wavelengths simultaneously. Over the last

decade, optical fiber communication systems have been intensively used thanks to the advancement in the field of digital signal processing, which permits to use coherent detection and advanced modulation formats.

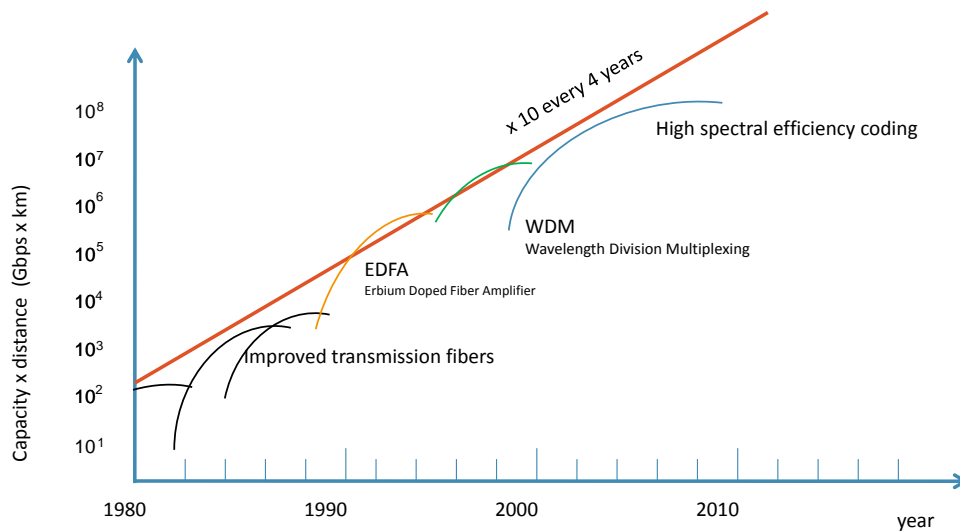

Figure 1.2: Evolution of “capacity x distance” of optical transmission systems, inspired from: “EDFA, principe et application” E. Desurvire, Wiley 2002

This evolution in the optical transmission implementations has reinforced the use of optics in telecommunication networks [51]. Besides, the use of optics has exceeded the transmission functionality. Until now, optical networks have reached 5 generations presented as follow:

1.3.1 First-generation optical networks: Point to Point transmission

First-generation optical networks were composed of optical fiber point-to-point (P2P) transmission links, substituting copper-based lines maintaining the terminating electronic equipment.

The emission was first assumed by Light Emitting Diode (LED), then Multi-Longitudinal Mode (MLM) lasers and then Single-Longitudinal Mode (SLM) lasers [52]. Compared to LED, an MLM laser permits to send light with higher power, reach longer distances (up to 10 km [53]) and thus reduce the number of required regenerators. MLM, also referred to as a Fabry Perot laser diode (FP), can be used for $\lambda = 1310$ nm but not for $\lambda = 1550$ nm due to the higher chromatic dispersion of this window. For $\lambda = 1550$ nm, SLM lasers are used since they have an additional frequency selective item [52]. SLM emission may reach up to 20 km [53].

Figure 1.3 presents the evolution of signal P2P transmission in the 1st generation optical networks. Since 1990’s, WDM systems are widely used. Different signals (channels) are generated at different wavelengths, combined and coupled into an optical fiber using WDM multiplexer. Optical amplifiers can be used in the transmission chain. At the

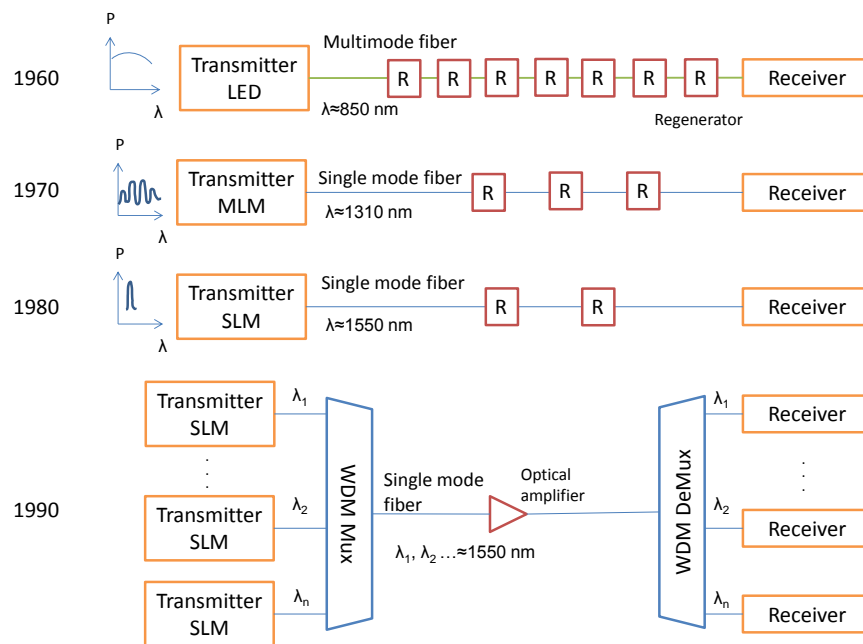

Figure 1.3: Evolution of the transmission technology in 1st generation optical networks

reception side, a demultiplexer separates the different channels. Each one is collected by its wavelength-specific receiver. Dense wavelength division multiplexing (DWDM), employed since mid 90's, uses the same transmission window but with denser channel spacing. By 2000 and so, DWDM systems use L-band (centered at 1625 nm) besides to C-band (centered at 1550 nm). Channel plans vary [54], but a typical nowadays system would use 40 channels at 100 GHz spacing or 80 channels with 50 GHz spacing or more than 160 channels at 12.5 GHz spacing.

First generation optical networks were based on the protocols Synchronous Optical NETWORKing (**SONET**, in USA) and Synchronous Digital Hierarchy (**SDH**, in Europe and Japan). SONET defines Optical Carrier (OC) levels and electronically equivalent Synchronous Transport Signals (STS). The standard STS-192, OC-192 operates at 10 Gb/s, while the standard STS-768, OC-768 operates at 40 Gb/s. Circuit switching, traffic separation, routing functions are handled with electronics. Thus, optical to electrical (O-E) and electrical to optical (E-O) converters are required.

Respecting the principle of encapsulation in the OSI layered model, IP packets were sent over Asynchronous Transfer Mode (ATM) over SONET. The ATM protocol (layer 2 of OSI model) was designed to unify telecommunication and computer networks. It was responsible for traffic engineering and quality of service, handling non-tolerant packet loss, such as file transfers, and low-latency packets such as voice and (less restrictive) video packets. ATM uses a connection-oriented model in which a virtual circuit must be established between two terminals before the actual data exchange begins.

Optical networks evolved, IP dominated ATM and became sent over SONET in the form of Point to Point Protocol (PPP) [55]. This technique, called Packet over SONET (POS), combines the simplicity of IP and the high reliability of SONET/SDH. It is used in the connection between gigabytes routers, in the core network.

However, point to point transmissions don't involve traffic routing across all the network. The first generation suffers from a bottlenecks of excessive electronic processing at each intermediate node. Thus, additional functions must be held in the optical domain.

1.3.2 Second-generation optical networks: optical layer

Unlike 1st generation networks, second-generation optical networks were intended to perform additional functions of point to point transmission in the optical domain. Several switching and routing functions are handled optically, but with electronic controls.

The emergence of second generation networks considers the introduction of a new level in a layered network model which is the optical layer. Figure 1.4 presents the layered architecture in 2nd generation optical networks. The optical (physical) layer contains optical components executing linear operations on optical signal and provides basic communication services to a number of independent Logical Networks (LNs). LNs are residing in the electronic (logical) layer which contains electronic components executing nonlinear operations on electrical signal.

The optical layer means:

- A reduction of "bottlenecks": In the first generation of networks, the increase of the line speed complicates the header processing in the electronic domain.
- It is a service layer that provides "lightpaths" to its users (other client layers: SDH, ATM, Ethernet ...) through Service Access Points (SAP).

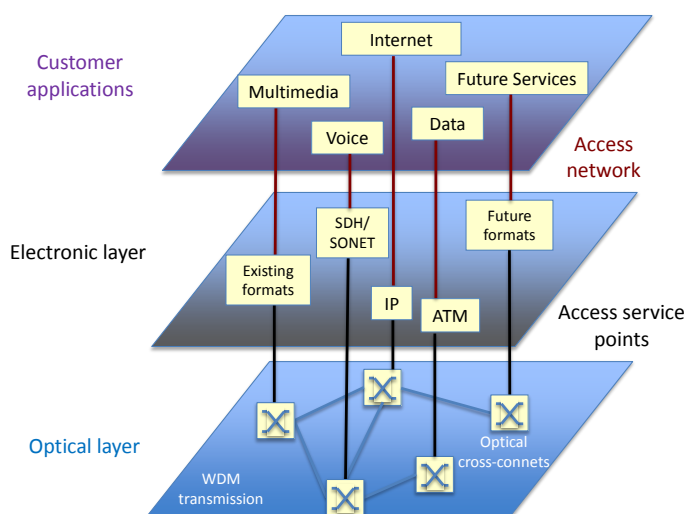

Figure 1.4: Layered architecture in optical networks, inspired from [1]

A lightpath is an end-to-end optical connection, which takes place in the optical layer by using a specific wavelength along several optical links and through different intermediate nodes. There is a wavelength continuity constraint. Different lightpaths can use the same wavelength unless they do not share the same optical fiber link. Lightpaths are multiplexed and demultiplexed in the optical layer.

The key devices that have marked the 2nd generation are:

- **Optical Add-Drop Multiplexer (OADM)**: it takes a WDM signal from its input port and selectively drops some wavelengths locally while letting others pass through,

and also selectively adds wavelengths to the WDM signal, as presented in Figure 1.5. It may incorporate wavelength conversion capabilities.

All the lightpaths that directly pass an OADM are termed cut-through lightpaths, while those that are added or dropped at the OADM node are termed added/dropped lightpaths [56].

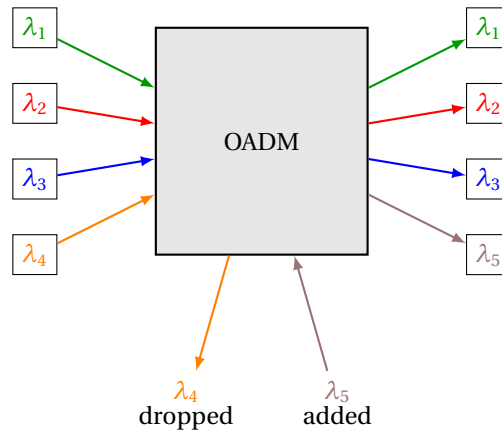

Figure 1.5: An Optical Add/Drop Multiplexer

- **Reconfigurable Optical Add-Drop Multiplexer (ROADM):** it is an OADM that allows the service providers to define and to re-configure remotely the wavelengths while adding the flexibility which characterizes the network infrastructure mode any-wavelength-to-anywhere (directionless) using any available port on the network node (colorless) [57]. ROADMs allow the optimisation of the operating costs and the reduction of the travels to update and assure the maintenance of the networks, namely the metro and long haul networks where they are used. Since their invention, ROADM have seen several developments and improvements [58, 59]
- **Optical circulator:** it is a 3 (or 4)-port device that separates optical signals that travel in opposite directions in an optical fiber [60]. An operation diagram of a 3-port optical circulator is presented in Figure 1.6. It may be used to achieve bi-directional transmission over a single fiber: a circulator is located at both ends of the fiber. Each circulator functions to add a signal in one direction while removing the signal in the other. Because of its high isolation, reflected optical powers and its low insertion loss, optical circulators are widely used in advanced communication systems, add-drop multiplexers, bi-directional pumps, and chromatic dispersion compensation devices.
- **Ultrawide-band EDFA:** The 2nd generation experienced some improvements in EDFA amplification such as proposing different architectures of amplifiers [61] or using EDFA amplifiers in a building block [51]. This permits to optimize the dispersion compensation, ensure larger bandwidth and cover more channels in WDM and DWDM systems.
- **Optical Cross-Connect (OXC):** called also Photonic Cross-Connect (PXC), interconnects high-speed optical signals between multiple input fibers and multiple output fibers. It was first used in circuit-switching systems. It may be wavelength-specific (switches the optical signal on incoming wavelength λ_i of an input fiber to the

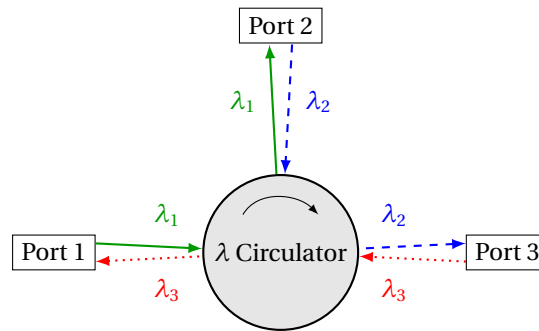

Figure 1.6: A 3-port optical circulator

outgoing wavelength λ_i of another output fiber) or equipped with wavelength converters (switches the optical signal of the incoming wavelength λ_i of an input fiber to another outgoing wavelength λ_j of another output fiber). In addition to wavelength switching, OXCs are involved in wavelength routing with the use of multiplexers and demultiplexers. An OXC supports network reconfiguration and permits to restore broken optical paths in optical networks [62]. It may also include additional optical functions such as chromatic dispersion compensation and Polarization Mode Dispersion (PMD) compensation. Various OXC architectures are explored in [63]. An OXC should provide low switching time, low insertion loss (which is the power lost caused by the OXC), low crosstalk (which is the power ratio of the power at an output from an input to the power from all other inputs), and low polarization-dependent loss. For instance, the OXC-TM-400 of Enablence has an insertion loss of 3 dB, a crosstalk of 45 dB and a switching response of 3 ms [64].

The notion of Optical Transport Network (**OTN**) has been defined since the 2nd-generation optical networks. Its ITU recommendation is G.709. OTN provides a network-wide framework that adds SONET/SDH-like features to WDM equipment. It creates a transparent, hierarchical network designed for use on both WDM and Time Division Multiplexing (TDM) devices. Two switching layers are formed: TDM and Wavelength Switched Optical Network (WSO). Functions of transport, multiplexing, routing, management, supervision, and survivability are defined.

The evolution of optical networks in the second-generation was noteworthy but, higher transmission rates and lower latencies were required. Thus all-optical interconnection devices (third generation), that may reduce the electrical control and the opto-electrical conversions, are required.

With the use of reconfigurable devices, such as ROADMs and OXC, the concept of Automatically Switched Optical Network (ASON) has been introduced. ASON was based on Multi-Protocol Label Switching (MPLS), then, Generalized Multi-Protocol Label Switching (GMPLS). Both ASON and GMPLS support the second-generation optical networks by defining the optical control plane separately from the data plane in order to set up and release lightpaths [65]. However, these concept/protocol have been evolved coinciding with the development of all-optical interconnection devices that marked the third-generation optical networks. We would rather present them in the next section.

1.3.3 Third-generation optical networks: all-optical interconnection devices

In order to have a network of multi-wavelength fiber links, appropriate fiber interconnection devices are needed [51]. These devices may be classified on three categories:

- **Star coupler:** it is a passive broadcast device that takes in input signals and splits each of them into all of the output signals. It is formed by cascading 2×2 couplers (named also 3 dB couplers, or splitters); thus, the number of ports is usually a power of 2. An input signal will have its power equally divided among all output ports of the star coupler.

Figure 1.7 presents one 3 dB coupler, while Figure 1.8 presents the architecture of 4×4 star coupler. It is composed by 4 (3 dB) couplers. An $N \times N$ star coupler, where $\{N = 2^n; n \geq 1\}$, needs $n \times 2^{n-1}$ (3 dB) couplers.

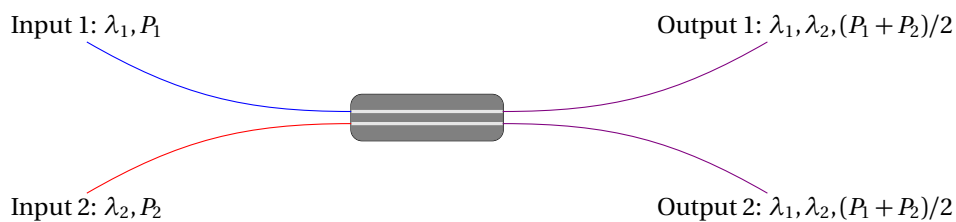

Figure 1.7: 2×2 coupler

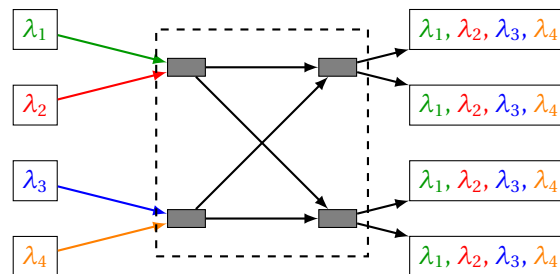

Figure 1.8: 4×4 star coupler

We remind that a passive component is a module that does not require energy to operate and cannot supply energy itself.

A typical application of star couplers is broadcasting systems, the powerful signal from one transmitter is sent through optical fiber into a star coupler, which distributes the power over a large number of output fibers for different customers [66, 67].

A limitation of star couplers is the constraint on the number of ports: if an extra node needs to be added to a fully connected $N \times N$ network, the $N \times N$ star coupler must be replaced by $2N \times 2N$ one, leaving $2 \times (N - 1)$ ports being unused.

- **Passive optical router:** also called Latin router, it is an $N \times N$ device used in WDM systems [68, 69]. It is connected to N input fibers, as well as N output fibers, each one supporting up to N wavelengths, permitting thus to route up to N^2 signals simultaneously. It is composed by N demultiplexers and N multiplexers assuming the

optical paths between the inputs and the outputs. Figure 1.9 shows the architecture of a 3×3 passive wavelength router.

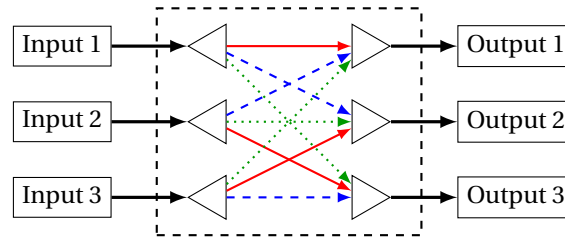

Figure 1.9: 3×3 passive wavelength router

Latin routers are called passive since they don't need to be supplied with power. They have a stable (static) routing table: when receiving a signal, depending on its input port and its wavelength, the output fiber and the optical path is determined. The signal wavelength doesn't change in the router.

The wavelength on which an input port gets routed to an output port depends on the internal connections between the demultiplexers and the multiplexers inside the passive optical router. These internal connections define the static routing matrix. Usually, for an $N \times N$ Latin router supporting N wavelengths, the wavelength λ_k carrying signals from the input fiber i to the output fiber j is determined as [68]:

$$k = \begin{cases} i + j - 1 & \text{si } i + j \leq N + 1 \\ i + j - N - 1 & \text{si } i + j \geq N + 2 \end{cases} \quad (1.1)$$

- **Wavelength Selective Cross-Connect (WSXC)** [70]: also called as Wavelength Routing Switch (WRS) or active switch. In fact, it is active since its switching matrix can be reconfigured on demand under electronic control. So, the WSXC offers more freedom in rearrangement. Unlike passive star coupler and passive router, the WSXC needs to be supplied with power.

The architecture of a WSXC may be based on micro-mirrors, or OADM, or fiber Bragg gratings... The article [71] describes different architectures of WSXCs and makes comparison between them.

With the use of these devices, O-E-O conversions are not required at each node in the WDM optical system, thereby 3rd-generation optical networks were aimed to reduce costs at each node. Such type of network is called “**transparent**” network because signals undergo O-E-O conversions only at their respective source and destination, unlike “opaque” network where a signal undergoes O-E-O conversion at every intermediary node from its source until its destination.

Transparent networks avoid intermediary opto-electronic components and lead thus to a reduction of cost, energy consumption and transmission latency. Nodes would become oblivious to signal specifications such as the modulation formats, the bandwidth, the channel spacing... However, transparent networks have some limits: the wavelength continuity constraint and the limited transmission distances due to the accumulation of signal loss and deformations [72, 73]. Some possibilities to overcome these limits are [74, 75]: increasing the number of transponders per connection, adding more complex post-processing to compensate for the filtering impact, implementing super-channels, using advanced Forward Error Correction (FEC) codes... These solutions increase the

cost or the implementation complexity of the network. A key solution could be “translucent” networks that are a compromise between opaque and transparent networks. In translucent networks, regenerators can be used but their number is limited, and they must be carefully placed at strategic locations. The wavelength continuity constraint can be managed; there is no limitations on the transmission distance; and O-E-O conversions are reduced compared to opaque networks but not totally avoided as in transparent networks [76].

The ASON has been more developed within the 3rd-generation optical networks. An **ASON** (ITU G.807) is an “intelligent” optical network that can automatically manage the signalling and routing through the network. Configuring cross-connections in the network elements is automated: these elements have the necessary processing functions built in to configure a new traffic path, given a customer requirement of the path’s start and end point, the bandwidth, the Quality of Service... (but not the path itself). This traffic path will be changed if the network is changed.

ASON is based on the protocol GMPLS. However, other protocols preceded the GMPLS, which are MPLS and MP λ S. The hierarchical classification previously used in IP over ATM over SONET, or in IP over SONET, leads to significant latencies of connections and communications between the different layers. Some management tasks (security, error correcting codes...) and transport protocols were duplicated. MPLS, and following it MP λ S and GMPLS, are the alternatives to simplify the network control and management and overcome the scalability issues.

Multi-Protocol Label Switching (MPLS) was developed in the late 1990s and standardized by the Internet Engineering Task Force (IETF) in order to provide faster packet forwarding for IP routers.

Traditionally, IP routing is connectionless (and not circuit-switched). At the reception of the packet, a router determines the next hop using the destination IP address on the packet alongside information from its own routing table. Routing tables contain information on the network topology configured statically and synchronized with the network modifications, or obtained via an IP routing protocol, such as Open Shortest Path First (OSPF), Intermediate system to intermediate system (IS-IS), Routing Information Protocol (RIP)... In an ASON network, Internet protocols cannot be used directly. IP routers route packets based on the information extracted from their headers, while OXC switch on the basis of wavelengths or optical paths.

MPLS adds labels that fill in the IP packet header. Thus, it eliminates the IP header interrogating on each packet at every intermediate router, which is a waste of resources especially for packets sent from the same source to the same destination. As presented in Figure 1.10, MPLS works as following:

- Ingress Label Edge Router (LER) pushes a label in front of the IP header.
- Label Switch Router (LSR) does label swapping. Inside the network, each LSR uses labels to determine the Label Switched Path (LSP) and forward the packet to the next hop, until the egress router.
- Egress LER removes the label.

Besides the forwarding function, MPLS assumes control function. It permits the routing tables establishing by forwarding tables and network topology information for path selection (OSPF, IS-IS, RIP...). It supports also signaling and Label Distribution Protocols (LDP) by setting up the LSPs. Control and data planes are separated: path is set up using control plane, while data is forwarded via the data plane.

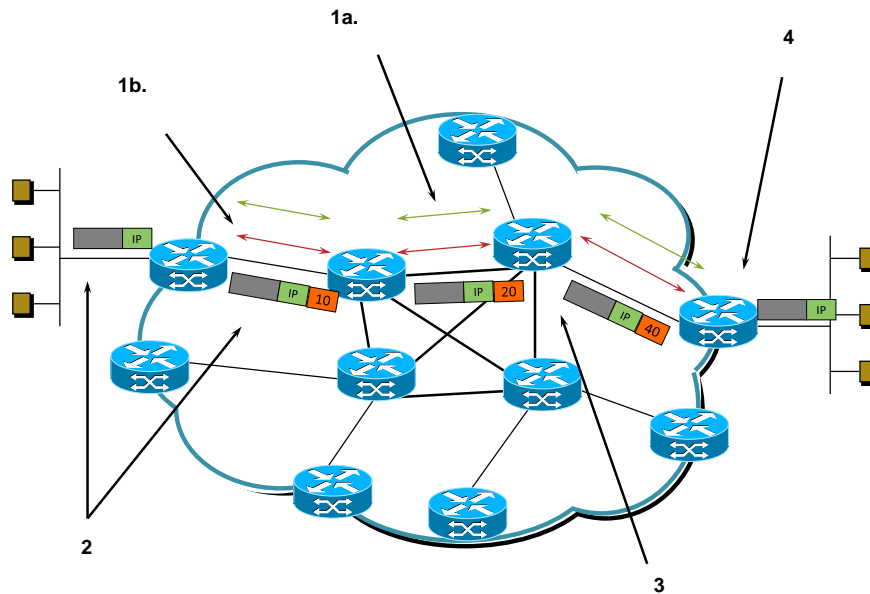

Figure 1.10: *MPLS operating mode, 1.a: Routing protocols exchange reachability to destination networks; 1.b: LDP establishes label mappings to destination network; 2: Ingress LER receives packets and adds labels; 3: LSR forwards packets using label swapping; 4: Egress LER removes labels and delivers packets. Adapted from [2]*

MPLS is compatible and easily integrated with traditional IP networks. However, unlike traditional IP, its flows are connection-oriented and packets are routed along pre-configured LSPs.

Since MPLS uses only the label to forward packets, it is protocol-independent, that's why it is called "Multi-Protocol". Its protocol-independence permits to use MPLS to carry any content over any link technology. It supports not only IP, but also ATM and frame-relay layer 2 protocols.

MPLS capabilities have expanded massively, it supports traffic engineering and fast re-routing, increasing thus the scalability. Besides, it allows the construction of Virtual Private Networks (VPNs). In addition, it provides an opportunity for mapping different classes of service onto MPLS labels. Last but not least, MPLS facilitates the elimination of multiple layers.

Multi-protocol Lambda Switching (MP λ S) was designed in 1999 for smarter usage of optical resources. It is also called MP Wavelength Switching, or MP Photonic Switching. It is extended from MPLS, combines MPLS traffic engineering control with OXC [77]. Instead of labels, specific wavelengths serve as unique identifiers. The specified wavelengths, like the labels, permit to switch and route packets automatically, without having to extract instructions packets headers, such as IP addresses or other packet information. Control plane has a fixed topology, and it is strictly separated from the data plane. The control plane is common for IP and optical domains [78]. The use of MP λ S was quickly replaced by GMPLS. Some papers refer MP λ S as a first version of GMPLS.

Generalized Multi-protocol Lambda Switching (GMPLS) is conceptually similar to MPLS, but instead of using an explicit label to distinguish an LSP path at each LSR router, some physical property of the received data stream is used to deduce which LSP it belongs to. Besides IP switching, GMPLS supports multiple types of switching, hence the name of "Generalized" MPLS [79]. LSPs are implicitly labeled depending on the type of switching:

- Time Division Multiplexed (TDM), with the use of the timeslot to identify the LSP.
- Wavelength Division Multiplexed (WDM), with the use of the wavelength to identify the LSP.
- Fiber or port on which a packet is received.

GMPLS includes support for LSRs that can't recognize (IP) packet boundaries in their forwarding plane, such as ATM routers or Ethernet switches. LSPs can be established for circuit traffic in addition to packet traffic. Using the TDM and WDM examples, the LSP traffic is switched based on a continuous, constant property of the data stream, that may switch several packets together.

Other than this, GMPLS permits to define bidirectional LSPs, where traditional MPLS performs only one-directional paths [80].

Figure 1.11 resumes the evolution of protocols in optical networks, from its 1st generation, until the implication of GMPLS. The use of GMPLS has continued to next (fourth) generation and after.

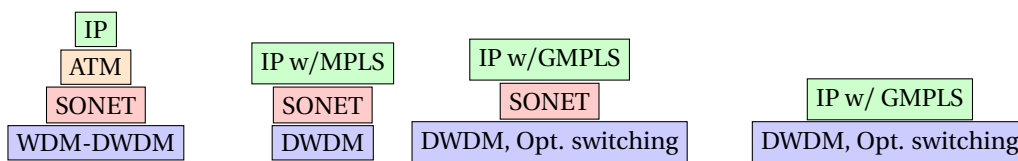

Figure 1.11: *Evolution of protocols in optical networks*

However, a true IP-over-WDM architecture requires the possibility of switching and forwarding IP packets over the all-optical WDM network without excessive electronic processing in the data plane. This was the mission of the 4th generation.

1.3.4 Fourth-generation optical networks: Optical Packet/Burst Switching (OPS/OBS)

In order to reduce O-E-O conversions, and thus the energy consumption of optical networks, researchers have focused on all-optical systems. Light paths, or Optical Circuit-Switched (OCS) connections were provided between the optical core network routers. The establishment of a light path between two nodes involves the topology and resource discovery (thanks to routing protocols such as OSPF, or the maintenance of static network information), the wavelength assignment and routing, the signaling and the resource reservation during the data forwarding, and at the end the resources releasing. A basic OCS switch architecture is presented in Figure 1.12.

OCS suffers from all the disadvantages known to circuit switching: the latencies to set up and to destroy light paths, and the inefficient occupation of resources while a circuit is established. These disadvantages make the OCS not adaptable with the unpredictable nature of network traffic, especially, it does not fit with the IP bursty nature. Also, OCS are not adaptable to the changing nature of (dynamic) networks such as changing the wave-

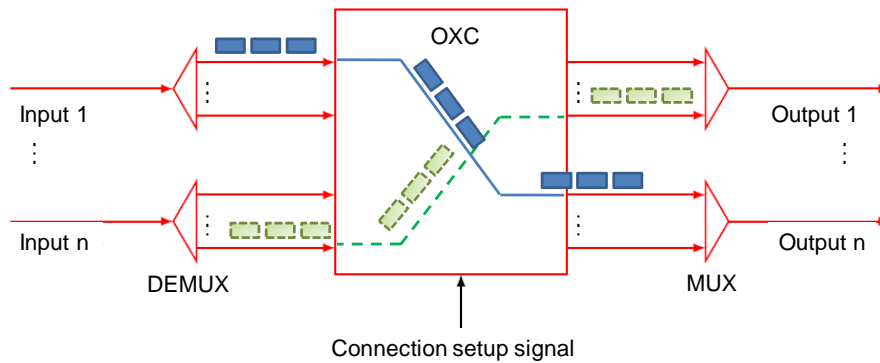

Figure 1.12: Basic OCS architecture, inspired from [3]

length configuration (for maintenance for example), optical paths, number of emitters or receivers... OCS use is thus limited to static routing.

Ideally, nodes should exploit packet switching at the optical level.

OCS may be classed with the third generation because it assumes static routing, as it may be classed with the fourth generation because it switches packets (even collected in a circuit) over the WDM optical network.

1.3.4.1 Optical Packet Switching (OPS)

OPS promises high switching speed, flexibility, fine granularity of transmission and switching, leading to economical and efficient use of the bandwidth [81]. Moreover, OPS switches have evolved significantly in the last years [10, 82]. A basic OPS architecture is presented in Figure 1.13. Data and control planes are separated. The label processing and switching decisions are performed by the control unit. The switch is reconfigured based on the information extracted from the packet label.

Optical packet-switched networks can be synchronous or asynchronous. In synchronous OPS network [83], called also slotted network, all packets have the same size [84]. Each packet is assembled with its header and a guard time into a time slot. Arriving packets must be synchronized and aligned with the OPS time slots. Synchronizers (not presented in Figure 1.13) are needed at the switch entrance, after the demultiplexing stage. Packet switching and OPS reconfiguration can take place only at the beginning of a slot. The packets will have new headers, generated by the control unit, when exiting the switch. Asynchronous (unslotted) OPS networks [85, 86] support packets with variable sizes. Switching can take place at any point in time. Asynchronous switching is thus more flexible and robust. Packet contentions are more likely occurring, but this is normal due to the great variety of IP packets (different sizes, asynchronous unpredictable arrivals, various paths...). A packet contention occurs when two or more packets that have the same destination arrive at the same time, so they contend for the same output port simultaneously.

Due to packets headers, the bandwidth is more occupied and the percentage of control overhead is higher in a synchronous OPS network than in an asynchronous one. For these reasons, asynchronous OPS switches are more used than synchronous ones.

There are two modes of switching: cut-through mode and store-and-forward mode. In

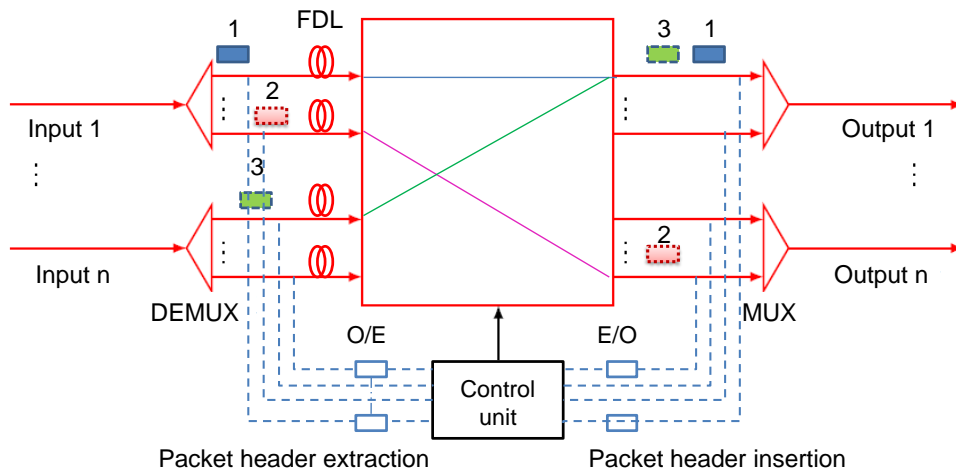

Figure 1.13: *Basic Store-and-Forward asynchronous OPS architecture, inspired from [3]*

cut-through mode, the switch starts forwarding the packet to its destination as it is being received. Labels are processed quickly at the level of each node. In store-and-forward mode, packet buffering is provided at each node, as presented in Figure 1.13, in order to reduce the risk of contention and eventually packet loss. However, store-and-forward mode leads to higher packet latencies.

OPS was first demonstrated in 2000's [87, 11, 12, 13]. However, *it has not yet succeeded outside research laboratories*. Different challenges are facing the realization of the OPS vision. These challenges are related to several areas:

- Optical packet header (label) conception, recognition and swapping [88, 89].
- Wavelength conversion.
- 3R functions [14, 90, 91]: An optical signal faces dispersion and non linear effects through its transmission. Its power level decreases and its shape may be modified. Reamplifying, called also 1R regeneration, increases the signal power but, besides the "useful" signal, it increases also the noise power. So, the Signal to Noise Ratio (SNR) can be decreased and the shape deformation of the original signal will be clearer. Reamplifying and reshaping function, called 2R regeneration, adds a level estimator to the 1R regeneration. It can clean up the signal by removing the amplitude noise. However, 2R regeneration is not able to solve the timing jitter, which is simply the deviation from true periodicity of the original signal. 3R regeneration adds the retiming function to obtain a signal with the same power level and shape as the original signal. These functions are presented in Figure 1.14.
- Packet switching strategies, that may involve the case of different service classes and different packet types [85].
- Packet buffering: it may be done with a Fiber Delay Line (FDL), which slows down the transmission of packets. For instance, MDL series FDLs of the company "new port" provide an optical delay range from 0 to 330 ps [92]. Some researches, like [93], defend that it could be possible to use FDL buffers in core networks. However, this solution has a memory lifetime issue.

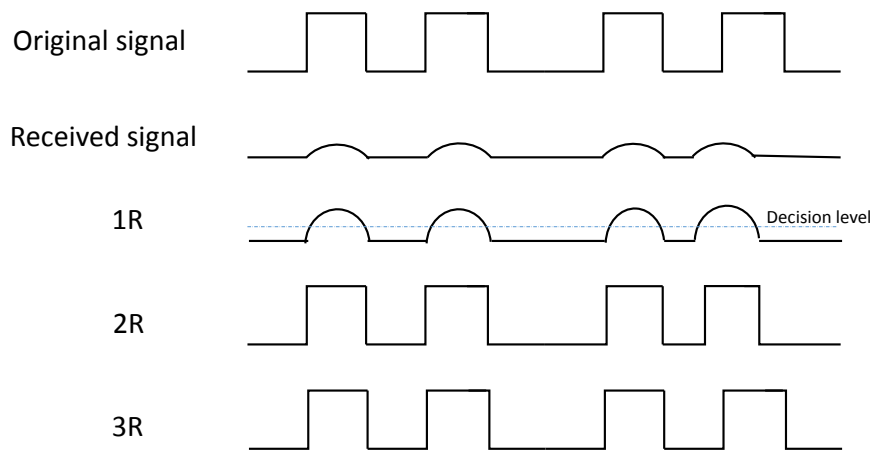

Figure 1.14: *Reamplifying, reshaping and retiming functions*

Another possibility is to use recirculating-loop, where buffered packets will be circulated locally in a loop during the buffering time. This leads to a signal power dispersion, and will need optical amplifiers which consume power. This solution is also not practical and costly.

- Optical packet contention resolution [94]. It may involve packet switching strategy, packet buffering, wavelength conversion [95], deflection routing (sending the packet to another destination if the original one is not available)...
- Clock extraction and synchronization [15].

Among these challenges, the significant one that prevents the application of OPS in the industrial world is the lack of practical, cost-effective, and scalable implementations of *optical buffering solutions*.

1.3.4.2 Optical Burst Switching (OBS)

OBS has been proposed as a compromise between OCS and OPS [96]. A burst consists of one or many IP packets assembled together [97]. A control packet, containing information about the burst, such as its length and the number of the included packets, is sent first, followed by the data burst on a separate wavelength. Data and control planes are separated. An offset time is required between the emission of the control packet and the data burst. It permits to process the control packet and set up the switches at the intermediate nodes, before the burst arrives. Thus, by choosing the offset time at the source to be larger than the total processing time of the control packet along the path, unlike OPS, no buffers are needed while processing the control packet. Besides, the burst duration known from its control packet permits the switches to be ready (reconfigured) for the reception of the next burst. Figure 1.15 presents the architecture of an OBS.

In the case of an OBS supporting different classes of services, an additional offset-time may be assigned to high priority bursts, which results in an earlier reservation, in order to favor them over low priority bursts in terms of resources reservation [98]. The concept of using an offset time at the source is applied for the signaling protocol Just-Enough-Time (JET).

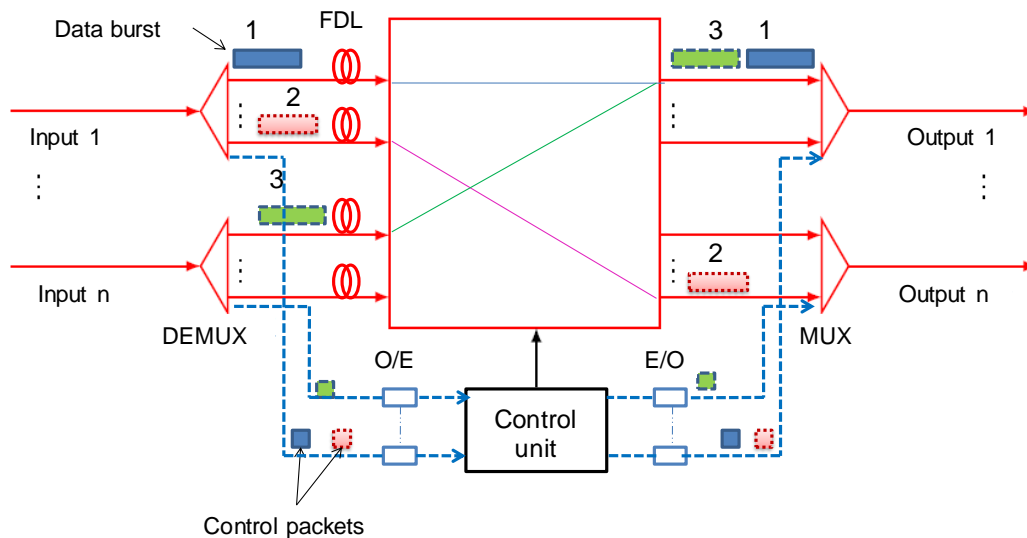

Figure 1.15: OBS architecture, inspired from [3]

Another possibility is to make the burst wait for a fixed delay at each intermediate node. The delay is not shorter than the maximal time needed to process the control packet. This is the concept of the signaling protocol Tag And Go (TAG).

Both JET and TAG protocols do not require resources reservation acknowledgement before a source sends a burst. So burst contention may occur, and leads to burst loss if it couldn't be resolved. Methods of burst contention resolution are similar to packet contention resolution: buffering, wavelength conversion, deflection routing... In addition, it is possible to opt for burst segmentation [99, 100]: only the part of a burst that overlap with another burst will be dropped.

OBS offers more efficient bandwidth utilization compared to an OCS system. Compared to OPS, OBS results in a lower control overhead per data unit since it assembles the control of several packets, which form a burst, in one control packet. In addition, optical buffers are not mandatory for the functionality of an OBS [101]. Table 1.1 summarises the different optical switching paradigms: OCS, OPS and OBS.

As OPS, OBS are still in the experimental stage, even though they seem more appropriate for commercial use. This is due to the lack of efficient and fast contention resolution solutions, mainly the lack of mature optical buffers that permit to have acceptable Quality of Service (QoS) and transmission reliability. Thus, the use of OBS and OPS is still restricted to quasi-static switching.

Hybrid solutions combining the use of OPS/OCS [102, 103], OBS/OCS [104, 105], and OBS/OPS [106] are also investigated. These solutions are proposed in order to combine the benefits of the different optical switching paradigms.

1.3.4.3 Other technological advancements

In addition to these new information transport formats, the 4th generation optical network experienced several evolutions in **digital coding** that uses the speed of electronic

Table 1.1: Comparison between OCS, OPS and OBS

Optical switching paradigm	OCS	OPS	OBS
Bandwidth use efficiency	low	high	high
Loss type	set-up request rejection	packet loss	burst loss
Transfer guarantee	yes	no	no
Misordering	no	possible	no
Latency given by	propagation and set-up	propagation	burst assembly and propagation
Setup latency	high	low	low
Switching speed request	slow	fast	medium
Control	out-of-band	in-band	out-of-band
Control overhead	connection set-up	packet header	control packet corresponding to the burst
Overhead synchronization	low	high	low
Buffering	no	typically	no

processing at the service of optical networks. For example, digital coherent detection, which incorporates speed digital signal processing (DSP) into coherent detection, contributes to the compensation of the chromatic dispersion by the mean of FIR filters, contributes to the compensation of the Group Velocity Dispersion (GVD) and Differential Group Delay (DGD) by equalization and source separation using algorithms like the Constant Modulus Algorithm (CMA), recovers the digital clock, demultiplexes signals sent together on orthogonal polarizations, and permits the estimation of the carrier phase.

Besides the wavelength (WDM), numerous degrees of freedom in a standard single mode fiber have been explored, mainly the phase and the polarization (Polarization Division Multiplexing PDM). Thus, high-level modulation formats have been investigated and implemented in the industrial world [107, 108, 109].

This evolution permits to increase the transmission distance and the information spectral density. The submarine cable “Bay of Bengal Gateway” installed by Alcatel-Lucent Submarine Networks in 2014 provides a rate of 100 Gb/s per wavelength. It has a system distance of 8000 km relating Singapore, Malaysia, Sri Lanka, India, Oman and UAE. Alcatel-Lucent installed also the “Pacific-Caribbean Cable System” connecting Florida, Tortola, Colombia and Ecuador with a reach of 6000 km. This cable provides a rate of 100 Gb/s per wavelength and a maximum capacity of 80 Tb/s [110].

1.3.4.4 Limitations

The contribution of the fourth generation is not sufficient to meet the actual and future needs of customers in terms of transmission reliability, latency, energy efficiency... In addition to the technological limitations of OPS and OBS presented in section 1.3.4.1 and 1.3.4.2 respectively, GMPLS has also its drawbacks.

The main problem of GMPLS is its control plane complexity. There is no Unified Control Plane (UCP) for both transport and IP networks. On the one hand, if transport and IP networks share all states (peer architectural model), the load on the routing protocols will increase. They will be charged not only by IP information, but also transport network information. Besides, the peer model doesn't fit with organizational boundaries where the information sharing between two networks is prohibited. On the other hand, if there is no states sharing between the IP and transport networks (overlay model), User Network Interfaces (UNIs) are required for service requests, and GMPLS must be layered on the top of other solutions. This model is not used commercially because of the hardware compatibility issue (the implementation of GMPLS in all devices on the top). In addition, IP doesn't need transport services dynamically since routing protocols can't converge when network changes occur very often or/and very fast.

1.3.5 Fifth-generation optical networks: Software Defined Network (SDN)

In our age of technology, we are moving to the fifth-generation optical networks. GMPLS protocol will be progressively joint with or replaced by Software Defined Network (SDN) protocols [111].

SDN is proposed as a solution to simplify the control plane [112]. Both packets and circuits will be considered as flows [113]. OPS, OCS and also OBS data switches will be abstracted and presented as switch Application Programming Interfaces (APIs) in a common map abstraction. A Network Operating System (netOS) will manage all the software controllers corresponding to the APIs and transfer the map manipulations from the common map abstraction to the switch APIs and modify their flow tables. The flow tables are composed by:

- matching rules, such as IP, MAC and transport sources and destinations, VLAN information...
- actions to be taken when the flow matches the rules, such as forwarding a flow to a port, or to the controller, dropping a flow, modifying header fields...
- counters for collecting flow statistics, such as rates of flow dropping (like PLR), switching latencies...

All network control logic is implemented as applications on top of the netOS. Figure 1.16 presents the architecture of SDN based unified control plane.

OpenFlow is the first SDN standard communications interface defined between the control and forwarding (data) planes, led by the Open Networking Foundation (ONF) [114]. OpenFlow permits to control the traffic flows of multiple switches from a centralized controller. OpenFlow 1.1 and 1.0 specifications are available [115].

Comparative studies between GMPLS and SDN via simulations [116] and testbed implementations [117] show the advantages of SDN over GMPLS.

The SDN architecture is:

- Directly programmable: the separation of control and data planes allows the direct programming of the control plane.

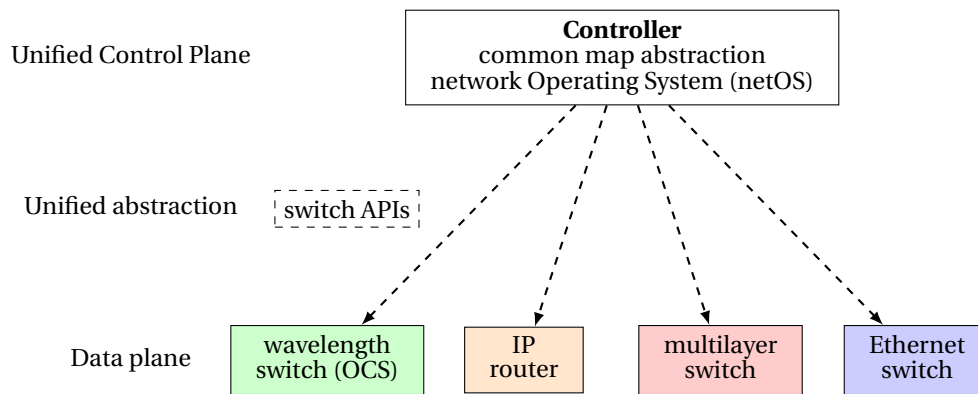

Figure 1.16: *SDN based unified control plane architecture*

- Agile and flexible: the abstraction lets the network administrators dynamically adjust network traffic flow and fit the demands of high (application) layers.
- Centrally managed: SDN has a common map abstraction. The network intelligence is logically centralized in the software-based SDN controllers.
- Programmatically configured: SDN lets network managers configure, manage, secure, and optimize network resources via open and available SDN programs.
- Open standards-based and vendor-neutral: SDN and its standard OpenFlow are led by the Open Networking Foundation, which provides an open collaborative development process. Instead of multiple vendor-specific devices and protocols, instructions are provided by SDN controllers where the different network physical nodes are abstracted.

We cite as an example of SDN solutions' vendor, the information and communications technology (ICT) solutions provider Huawei. It has revealed 5th generation flexible optical network architecture based on SDN in June 2014 [118]. It is reported that the improvement of the optical network's bandwidth and efficiency will meet the requirements of new services like cloud computing, streaming media, and mobile broadband.

SDN approach is proposed jointly with the **cross-layer design**, called also multi-layer design. Cross-layer design is an alternative to the OSI strictly layered model, where no direct communication between non-adjacent layers are permitted, and only procedure calls and responses between adjacent ones are possible. As defined in [119], the core idea of cross-layer design is to maintain the functionalities associated with the original OSI layers but to allow coordination, interaction and joint optimization of protocols crossing different layers.

A cross-layer optical switching node was implemented and tested [120]. It uses packet-scale measurement and performance monitoring subsystems to analyze the health of the optical channel and make higher routing layers aware of physical-layer impairments. In their turn, the higher network layers may set the parameters, such as quality-of-service (QoS) metrics and energy constraints.

In addition to the wavelength (WDM), phase (high-level modulation formats) and polarization (PDM), many researchers are currently interested in the space as another degree of freedom which is not yet used in the fiber for multiplexing. **Space division multiplexing (SDM)** may significantly increase the transmission capacity [121, 122].

SDM can be implemented either in multi-mode fibers (MMFs), or in multi-core

fibers (MCFs). MMF fibers, unlike single mode fibers (SMFs), have a large core diameter, allowing the propagation of more than one mode simultaneously. MCF fibers have more than one core (usually 7 cores [123]) in the same cladding. The available spatial modes in MMF fibers or cores in MCF fibers form an orthogonal set of channels over which independent data symbols can be multiplexed. SDM is still under investigation [124, 125] and not yet deployed in industry, to the best of our knowledge.

1.4 Vision on packet switching in optical networks

Nowadays, commercial off-the-shelf packet switches used in optical networks are all-electrical. They provide a large switching capacity. For instance, Cisco Nexus 7000 Series Switches may connect up to 768 ports (copper or fiber) with a rate of 10 Gb/s, 192 ports at 40 Gb/s and 32 ports at 100 Gb/s [126]. Switches involve O-E converters at the level of their input ports in order to process and switch packets electrically, and E-O converters at the level of the output ports in order to send packets for further transmission on optical fibers. These required O-E-O conversions make the switching one of the top energy-consumer functionalities [7].

Within the advancement of optical components and especially optical switching matrix, many opinions are directed to all-optical packet switches. The article [127] details different technologies of optical switches fabrication such as switches based on 3-D Micro-Electro-Mechanical Systems (MEMS), Semiconductor Optical Amplifiers (SOA), Interferometric switches... Optical packet switching may be considered as an “ideal” concept where data is transmitted on packets, O-E-O conversions are totally avoided, energy consumption is thus impressively curbed, switching latency is reduced compared to electrical switches (by the time of electrical processing, memory writing and reading)... However, due to technological limitations we discussed in section 1.3.4.1, OPS has not yet succeeded outside research laboratories. The main obstacle is the lack of practical optical buffers. Only OCS are used in current optical networks because there is no need of buffers in circuit switching (but their use is limited to quasi-static states, see section 1.3.4). Ideally, nodes should exploit optical packet switching, as it is the case for wireless communication [128]. In the absence of practical optical buffering solutions, OPS are vulnerable to contention and lead to notable packet loss rates [16, 17, 18].

Our vision is to use an electrical buffer at the service of an optical switching matrix and having thus a hybrid opto-electronic switch [19]. We think that hybrid switches could gain the benefits of the two fields, electronics and optics. Packets are switched optically at high speed and low energy cost per bit; and in case of contention, one of the contended packets would be buffered. O-E-O conversions occur only for buffered packets. Hybrid switches may be thus an adequate solution to reduce networks energy consumption.

In the article [20], the authors demonstrated a hybrid optoelectronic router which connects two packet-optical add drop multiplexer (P-OADM) rings, forming a new metro network architecture. Unicast and multicast transport of Ethernet encapsulated packets at 10 Gb/s were achieved. The experiments results show that the labeling scheme implemented can dynamically reconfigure the path.

A second research group worked on an analytical model of a hybrid switch [129]. Their packet switch is connected to WDM channels but it is supplemented by a wavelength converter for each optical port. The hybrid switch seems to be with no interest compared

to electrical switches since the number of O-E-O conversions would not be significantly reduced if the λ conversions are based on O-E-O conversions.

Another group presented a prototype of a hybrid optoelectronic router [21]. Multi cast routing, multi-hop transmission, and an interconnection experiment of two packet ring networks were demonstrated. In their study [130], they integrate a hybrid switch in intra-data center network but with a different switching strategy than the previously cited reference [20]; it employs deflection routing and fiber delay lines (FDL) in addition to the electrical buffer. Considering the PLR as performance criterion, the use of FDL is discussed depending on the system load.

Before I started my PhD, our group analyzed the performance of a hybrid optical-electronic switch [22], consisting of an optical switching matrix supplemented with a shared electronic buffer. No all-optical buffering solutions neither deflection routing are considered, electrical buffers are more practical and mature and better assume this role. Simulations and an Engset-type analytical model show performance improvements in terms of PLR and sustainable load compared to the all-optical case, with relatively few buffer ports. The switch is connected to its azimuths through interchangeable Space Division Multiplexed (SDM) channels, such as different cores of a multicore fiber or different fibers collected on the same cable.

Within my PhD, we aimed to investigate the hybrid switch performance when it manages different classes of service. The connectivity of the hybrid switch could be ensured with interchangeable channels, as well as WDM channels, or combined WDM-SDM channels. Our contributions are presented by the following chapters.

1.5 Conclusion

In just the past three decades, optical components and technologies have been widely incorporated in telecommunication networks, wherever in access, metropolitan and long-haul terrestrial and transoceanic networks. Current high data rate transmissions couldn't be possible without optical networks.

Optical networks experienced several generations, going from point-to-point transmissions, to WDM systems and optical amplification, to optical switching, to SDN networks... and the wheel will go on.

The ever-growing number of networks' users, the emergence of new services (such as cloud computing, streaming media, and mobile broadband) and the increasing amount of circulated data call for higher-capacity and smarter optical networks. A second thought is that future optical networks must reduce the energy consumption, which remains one of the largest budget items.

In the next chapters, we will present our vision on how to contribute in optical networks evolution, reducing their energy consumption while offering a good quality of transmission. We are specifically interested in opto-electronic packet switching, since switching is the main field consuming energy, and most data is carried as IP packets through optical paths.

Chapter 2

Performance analysis of hybrid opto-electronic packet switch connected through interchangeable channels

2.1 Introduction

As we mentioned in chapter 1, even though OPS and OBS switching techniques are different, their nodes have the same functional architecture: a switching fabric with a control module that is reconfigured depending on the destination of the ingress packets or bursts. The investigation of OPS and OBS in a functional point of view is quite similar. Here we consider packet switching. Yet, nodes should ideally exploit packet switching since the packet is the most common form of transporting data.

In this chapter, we analyze by simulations the performance of our hybrid opto-electronic switch. It is supposed to be connected to its azimuths through interchangeable channels: any ingress packet can use any available channel of its egress azimuth. This assumption works with parallel optical fibers in the same cable or different cores in a multi-core fiber.

This chapter is not aimed at wavelength-division-multiplexed (WDM) channels because they are not interchangeable. A hybrid switch supporting WDM channels would require frequent uses of numerous wavelength converters in order to ensure the wavelength continuity (i.e. to be able to convert packets from any wavelength to any other wavelength). Wavelength converters, themselves, consume power and may negate the energy savings achieved by the hybrid switch compared to an electrical one. The investigation of WDM channels case will be presented in chapter 3.

The architecture of our hybrid switch connected to interchangeable channels is presented in section 2.2. Compared to former performance analyses [130, 22], our hybrid switch supports different priorities for packets. Also, besides the PLR and the sustainable system load, we take into account the latency as performance criteria. The combination of these criteria, that are presented in section 2.3, makes the packet classification fairly realistic. Section 2.4 depicts our simulations: the different packet classes representing different classes of service, the switching policy that we established to satisfy the requirements of all packet classes, and the simulations setup.

Our simulation results are presented in section 2.5. We show that the hybrid switch makes a better solution than an all-optical bufferless switch as it significantly improves both the PLR and the sustainable system load, and meets the requirements of the different packet classes. Besides, compared to electrical switches, the hybrid switch reduces the switching latency and significantly decreases the O-E-O conversions. The need on the buffer capacity is limited and reasonable. Finally, we show that changing the percentages of packet classes while keeping a telecommunication use cases has no significant impact on the performance analysis when the connected channels are interchangeable.

2.2 Architecture of our hybrid switch

The hybrid switch architecture is presented in Figure 2.1. It is composed of an optical switching matrix supplemented with an electronic shared buffer that stores packets in case of contention. A comparison with other hybrid switch architectures and the justification of our choice of architecture was presented in section 1.4. The main parameters to dimension our hybrid switch are: the degree of the switch, in other words the number of connected azimuths (n_a) that are assumed to be bidirectional; the number of supported channels per azimuth in each direction (n_c); and the number of electronic input ports as well as output ports (n_e). We suppose that the channels are independent; an azimuth may receive up to n_c packets simultaneously. Channels are also supposed to be interchangeable: an ingress packet can use any available channel of its egress azimuth. This assumption works with Space Division Multiplexing (SDM) non-wavelength-specific channels, such as parallel optical fibers in the same cable or different cores in a multi-core fiber.

The required packet label processing and control unit for the switching matrix is supposed to be generic and is not presented in Figure 2.1; our study assumes that label processing does not require O-E-O conversion of the whole packet, e.g. by sending labels out-of-band [131], or as a reduced-bit-rate header.

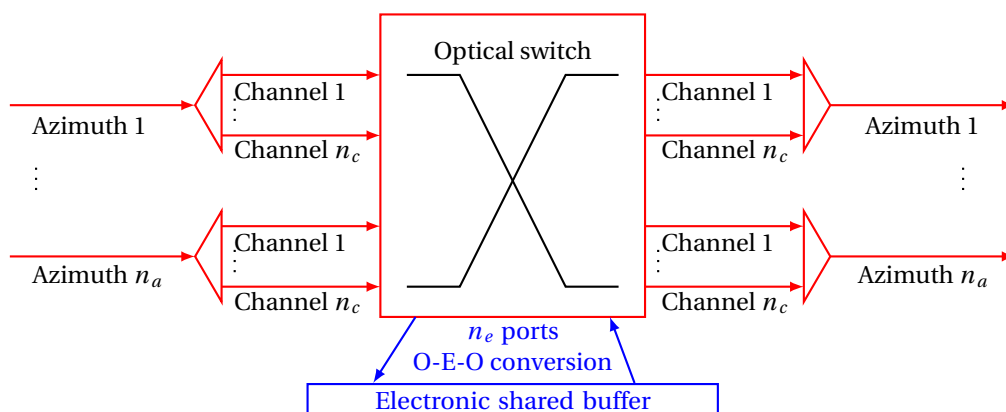

Figure 2.1: Hybrid switch architecture

Basically, the hybrid switch operates in the following way: when a packet arrives, the switch reads its egress azimuth. If a channel to its azimuth is available, the packet is directly sent on its way over this available channel. Otherwise, if an electronic input port is available, the packet is buffered. Whenever a channel is released and an output electronic

port is available, the packet will be re-emitted from the buffer to its egress azimuth. In the worst case, if neither a channel nor an electronic port is free, the packet is dropped. This is the basic method of operation; however, depending on packet classes, we investigated different buffer input port access managements, different sorts of lower-priority packet preemption to send higher-priority ones preferentially, and different buffer output port access for the re-emission. All these switching decision possibilities and the switching policy that we opt for are presented in section 2.4.2.

2.3 Switching performance criteria

The main switching performance criteria, defined below, are the Packet Loss Rate (PLR), the sustainable system load and the latency (also called the switching delay). The different types of packets, referring to several classes of service, have different requirements on these criteria.

2.3.1 Packet Loss Rate (PLR)

The PLR is the ratio between the number of packets lost due to contention, and the number of all circulated packets. It is calculated at a certain system load (ρ).

The **system load** depends on the mean idle time per source (τ), which is simply the average time interval separating two consecutive packets arriving from the same channel of a given azimuth, and the packet duration (σ). The system load is expressed as:

$$\rho = \frac{\sigma}{\tau + \sigma} \quad (2.1)$$

The system is called “fully loaded” ($\rho = 1$) when packets are sent one after another unceasingly ($\tau = 0$). This is the most critical operating case.

2.3.2 Sustainable system Load

The sustainable system load at a given value of PLR_{ref} is the maximum system load (ρ) for which PLR is equal or lower than PLR_{ref} .

We will choose a system load of 60% ($\rho = 0.6$) as a minimum acceptable operating point, which is a widespread reference value taken into account in several articles [22, 132]. Other references consider that the system is heavily loaded when $\rho > 0.7$ [130].

2.3.3 Latency (delay)

Another important performance criterion is the latency, also called the delay. It has different definitions. The definition that we considered is the additional time it takes for a packet to arrive at its destination if it couldn't be switched directly to its egress, in the optical domain, because of contention.

We note that the times of an O-E or E-O conversion are neglected because they are upper-bound estimated to the order of ns (10^{-9} s) while, as we will see in the results' section 2.5.4.1, the buffered packets' delays are in the order of μ s (10^{-6} s). In the reference [133], the authors show that attosecond (10^{-18} s) timing stability can be preserved across the opto-electronic interface of a photodiode.

The transit time through the optical switching matrix is also upper-bound estimated to the order of ns and it is neglected compared to the delay spent in the buffer. In fact, the

propagation distance inside the optical switching matrix should not exceed few meters. The prototype of a degree-4 hybrid switch presented in [21] is housed in a $100 \times 60 \times 100$ cm³ chassis, the latency is lower than 380 ns for packets switched optically without contention while it is higher or equal to 1.4 μ s for buffered packets.

By this definition of latency (additional time), the latency of a packet switched directly in the optical domain is null. As for packets that transit through the buffer, the three delays to consider are: the duration of the packet's reception into the buffer, equal to its duration σ ; the time spent in the buffer; and the packet's reemission time out of the buffer, also σ . Out of these delays, the first one doesn't count since, assuming that the packet is directly committed to memory as it comes, it is equal to the transit time through the optical switching matrix and we defined latency to be the additional time. Thus:

$$\text{mean latency} = \frac{\sum_{\text{packets}} (t_{\text{in the buffer}} + \sigma)}{\text{nbr of buffered then re-emitted packets}} \quad (2.2)$$

Opting for this definition of latency, we will compare the performance of our hybrid switch with those of commercial switches working in a cut-through mode, where the latency is assumed to be null for non buffered packets.

2.4 Simulation conditions and setup

2.4.1 Packet classes

There are different packet classes that refer to different services. Each CoS (class of service) has specific requirements in terms of PLR, latency, jitter, packetization interval, bandwidth... The switching strategy must take into consideration these requirements, ensure that certain types of packets have the priority to be switched directly to their egress, or to access the buffer, or to be reemitted first from the buffer, etc. Among the different service classes, we may cite [134, 4]: call signaling, bulk data (such as database synchronization, transactional data, mission critical data, IP Routing traffic, network management traffic...), voice, interactive video, streaming video, best-effort data (such as HTTP web browsing)... Figure 2.2 taken from [4] presents the classification of services according to different CoS models that have different granularity levels.

We may group these packets classes into three main categories: Reliable (R), Fast (F) and Default (D) packets.

- Reliable packets (R) – that may refer to digital data and file transfer packets – must reach their destinations without loss, but they are the lowest priority packets in terms of the delay.
- Fast packets (F) – that could refer to voice, interactive and streaming video packets – have the highest priority regarding the latency, but they are more tolerant than R packets regard to the PLR. They require 150 ms one-way, end-to-end delay [134, 4] or lower. We note that for voice and interactive video packets, it is recommended that PLR must be lower than 10^{-2} across the network [134, 4]. The PLR of streaming video packets must be lower than 5×10^{-2} across the network [4].
- Default packets (D) – that represent other types of packets (Best effort) – are least restrictive with respect to both PLR and latency.

Reliable (R), Fast (F) and Default (D) packets respectively make up 10, 40 and 50% of the global traffic. These percentages are adapted from real data of circulated packets on

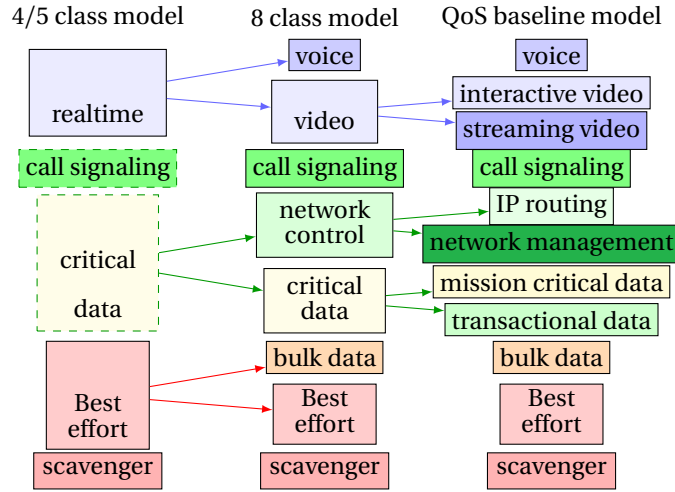

Figure 2.2: Classification of services based on different granularity levels, inspired from [4]

core and metro networks of a French telecommunications operator [135]. We relied on these percentages in our investigation of the hybrid switch performance.

In section 2.5.6, we show by simulations that a slight change of the percentages, for instance R 15%, F 35% and D 50%, to stay in a telecommunication use case, should not significantly alter the results of the performance analysis. It may be different in "special" use cases. For example, the R percentage may be much higher at the level of specific data centers where specific switching algorithms should be deployed.

2.4.2 Switching policy

In our simulations, we considered a fixed packet duration of $\sigma = 10 \mu\text{s}$, which represents about 100 kbit for standard 10 Gb/s systems. It may correspond to a jumbo Ethernet frame or an aggregation of several IP packets [22]. Thus, the system load ρ will depend only on the mean idle time per source τ . τ is the mean of randomly-generated intervals separating two consecutive packets arriving from a same source. The hybrid switch works in asynchronous mode: packets can arrive at any instant.

Figure 2.3 describes the switching strategy. At the reception of a packet, the switch checks whether there is an available channel to its egress azimuth. If yes, the packet is directly sent on its way over this channel. Otherwise, if an electronic input port is available, the packet is buffered and then re-emitted whenever a channel is released and an output electronic port is available. The First In First Out (FIFO) technique is applied at the level of the buffer output ports: the first buffered packet is the first one to be re-emitted; The reemission of buffered packets has priority over incoming packets for a given destination. Otherwise, depending on the packet class, there is a preemption policy: if the newly-arrived packet is of type R, the switch may interrupt the transmission through the optical switching matrix of the last (preferably D, or F) packet being sent to the buffer or the last (preferably D, or F) packet being sent to the same egress azimuth and send the R packet preferentially. Otherwise, if the newly-arrived packet is of type F, the switch checks if there is a D packet being sent to the same egress azimuth to preempt it and send the F one instead. The preempted packet, which was still being transmitted through the optical switching matrix to its destination port or to the buffer input port when receiving the new

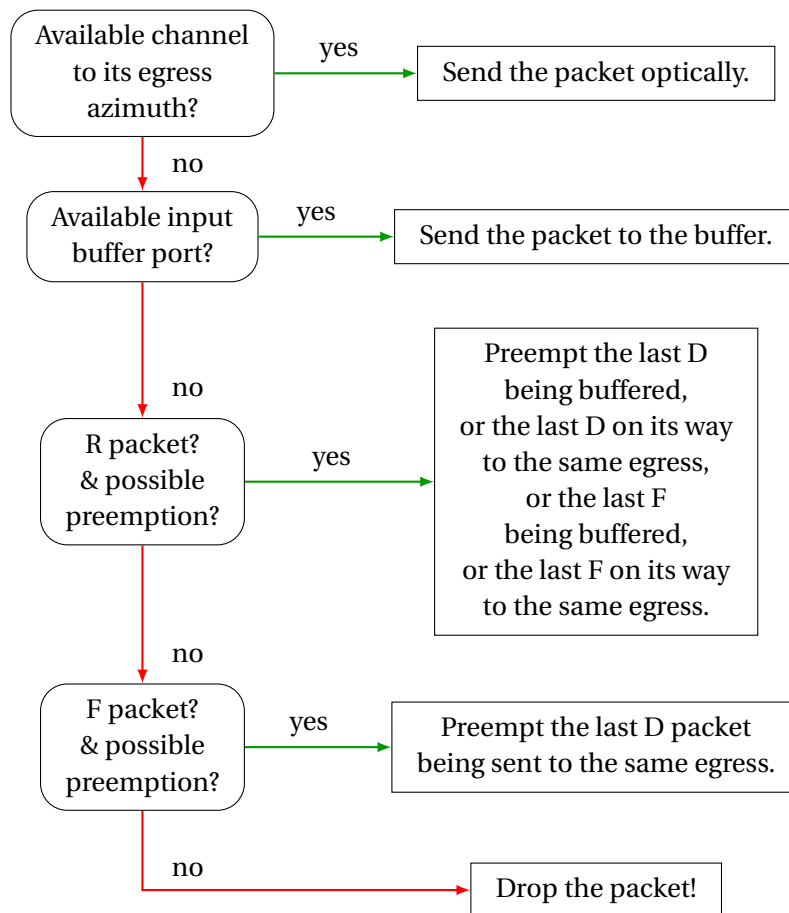

Figure 2.3: Switching strategy, hybrid switch connected via interchangeable channels

higher-priority packet, is dropped and taken into account in calculating the PLRs. In the worst case, in the absence of any of the possibilities listed above, the incoming packet is dropped.

This switching strategy has been chosen in order to meet the constraints of each class of service concerning both PLR and latency. In fact, we simulated other switching strategies that are different in regards to: the access to the buffer input ports (presented in section 2.4.2.1); the preemption policy (section 2.4.2.2); and the reemission from the buffer (section 2.4.2.3).

2.4.2.1 Buffer input ports access management

We simulated three different methods to manage access to the buffer ports. The first one is called *First In First Out* (FIFO), where all packets, regardless of their priorities, can access any available buffer port. The second management method is *partitioning* where a specific number of ports are exclusively dedicated to a certain priority class. In other words, packets of a certain priority class can only access their dedicated (and available) ports, as though we had three distinct buffers for R, F and D packets. The third method is *sharing*, where in addition to the partitioning, a higher-priority packet can access the ports that are dedicated to the lower-priority class or classes; it even has the right of way

to access these ports if it comes simultaneously with a lower-priority packet. Considering the performance obtained by each of these techniques, especially in terms of PLR, we opted for the FIFO buffer input ports access (see appendix B). In fact, the partitioning method is not optimum because it is possible to drop packets while there are available ports but not allocated to the same class of the dropped packets. Sharing method is complicated and needs an accurate adjustment of the number of ports allocated for each packet class. Moreover, even though higher-priority classes would have lower PLR with the sharing method than FIFO method, the performance of lower-priority classes is much more degraded, and thus the reason we choose the FIFO method.

2.4.2.2 Preemption management

We investigated different scenarios of lower-priority packet preemption in favor of the higher-priority ones if they don't have a free channel or an available electronic port. What differs from a scenario to another is the choice of which packet to preempt: the switch may check first if there is a lower-priority packet being sent to the same egress, or it can start by checking if there is a lower-priority packet on its way to the buffer. Particularly, R packets may start by preempting D packets and if there are none preempt F packets; or they can start by preempting F then D packets. We opted for the preemption policy described in Figure 2.3 since it leads to the best compromise between the PLR and the latency for R, F and D packets.

2.4.2.3 Reemission management

We tried another buffer output ports access technique. Rather than the FIFO technique, we respect the latency constraints: we give F packets the priority to be re-emitted first. D packets are re-emitted secondly, and at last R packets. We call this technique "re-emission prioritization". We opted for the FIFO technique because it has less constraints on the control plane, all packets are treated equally regardless to their classes. Besides, as it will be presented in part in section 2.5.4, the reemission policy has an impact in terms of latency only for an over-sized buffer, i.e. the number of buffer electronic ports (n_e) is high compared to the number of optical ports ($n_a \times n_c$); in this case numerous O-E-O will occur and the hybrid switch is not of interest.

2.4.3 Simulations setup

We implemented a dedicated simulator in C++. It takes as input parameters the hybrid switch dimensions: n_a , n_c and n_e . Given these parameters, we start by simulating a fully-loaded system ($\rho = 1$), launch packets and calculate the PLR and the latency for each service class. The packets' destinations are chosen randomly. For reasons of simplification, the traffic is symmetric: ρ is equal for all the channels of the connected azimuths. A perspective of this investigation is considering an asymmetric traffic.

We run successive simulations varying the system load (ρ) by decreasing it by 5% on each step and calculate the PLRs and the latencies. If the mean PLR is less than 10^{-4} , we decrease ρ with just 1.25% instead of 5% to be more accurate. In fact, we remarked that the speed of PLR decrease within the decrease of ρ is more significant for lower PLR ($\leq 10^{-4}$); the slope of curves presenting PLR as a function of ρ becomes more straight for lower PLR. For a given ρ , we start counting the PLRs and the latencies after the first drop of a packet. Each simulation ends if either:

- The average PLR of all classes is less than or equal to 10^{-7} ;
- 100 Reliable packets are dropped, ensuring the accuracy of the resulting calculated PLR to 10 %;
- or when the number of all switched packets is $n_p \geq 4 \times 10^8$, corresponding to $n_p(R) = 4 \times 10^7$ Reliable packets, which is a large enough value to measure PLR_R down to about 10^{-7} with a 95 % confidence.

This lower bound stems from the fact that, at a given $PLR = p$, the probability of transmitting N packets without dropping any is $(1 - p)^N \simeq \exp(-N \times p)$; therefore, if we lose no Reliable packet at all (which is indeed the case in most of our simulations) after transmitting $n_p(R)$ of them, there is a less than 5 % chance of PLR_R being actually higher than $-\ln(5\%) / n_p(R) \simeq 0.75 \times 10^{-7}$ [136].

We will present the simulation results for a degree-8 switch ($n_a = 8$). n_c takes the values of 1, 4, 8, 20 and 30 channels per azimuth; while n_e takes different values from 0 (which corresponds to an all-optical bufferless switch) to the number of optical links $n_a \times n_c$ (that corresponds to an all-electrical switch). This permits to know when the hybrid switch is of interest and to determine the minimum value of n_e which is sufficient to have acceptable performance.

Especially, we will focus on the case of $n_a = 8$ and $n_c = 8$ because we want to compare the performance of the hybrid switch with the commercial Cisco Nexus® 3064PQ electrical switch that has 64 ports [137]. For this example, n_e takes the values of 0, 3, 5, 10, 20, 30, 40 and 64 electronic ports.

We note that our simulations results are entirely consistent with those of an Engset-type analytical model for a bufferless switch [22]. For a hybrid switch ($n_e > 0$), our results perfectly match those of [22] obtained by another simulator.

2.5 Performance achieved

We analyze the switch performance considering as criteria the *PLR*, the *sustainable system load* and the *latency*. We show, in section 2.5.1, that the hybrid switch resolves packet contention much better than all-optical switches and satisfies the PLR condition even for reliable packets. In section 2.5.2 we give a dimensioning map taking into account the compromise between the low PLR achievement and the reduction of electrical ports, through the results in terms of the sustainable system load. The need on the buffer capacity is quantified in section 2.5.3. In section 2.5.4, our hybrid switch performance in terms of latency is quantified and compared to off-the-shelf electrical switch. The comparison with electrical switches is extended in section 2.5.5 to the reduction of the O-E-O conversions which may curb the energy consumption. In the last section 2.5.6, we show that changing the percentages of packet classes slightly while keeping a realistic use case according to telecommunication networks has no significant impact on the performance analysis when the channels are interchangeable.

2.5.1 Contention resolution: performance in terms of the PLR

Figures 2.4 and 2.5 show respectively the evolution of PLR_D and PLR_F as functions of the system load for 8 azimuths, 8 channels per azimuth and different values of n_e . We considered the widespread reference of $\rho = 0.6$ as a minimum acceptable operating point.

We note that with the inclusion of just a few electronic ports (n_e) compared to the optical ports ($n_{opt} = n_a \times n_c$), PLRs decrease significantly compared to an all-optical

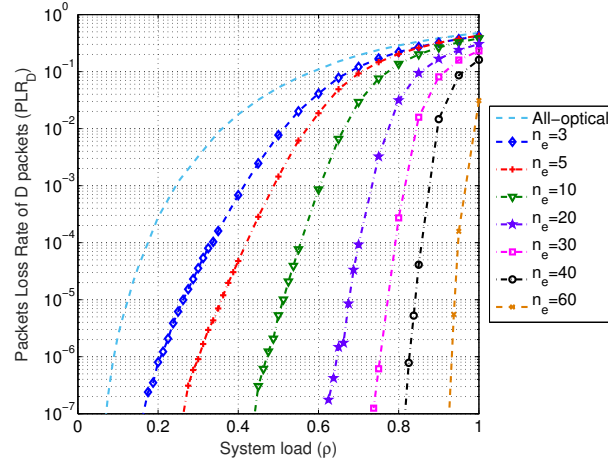

Figure 2.4: PLR_D vs system load, $n_a = 8$, $n_c = 8$ interchangeable channels

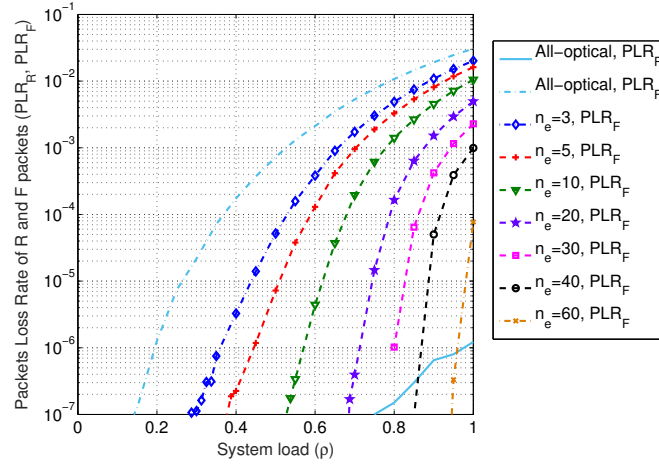

Figure 2.5: PLR_F vs system load, $n_a = 8$, $n_c = 8$ interchangeable channels

switch. For example, at $\rho = 0.6$, PLR_D is reduced by a factor 5 from 10^{-1} for an all-optical switch to 2×10^{-2} for a hybrid switch with $n_e = 5 = 0.078 \times n_{opt}$; while PLR_F is reduced from 2×10^{-3} to 1.4×10^{-4} for the same example, which means a reduction by a better than an order of magnitude. The more ports the buffer has, the greater the decrease of PLR_D and PLR_F are. For a 60% loaded system ($\rho = 0.6$), and with only 20 ($0.31 n_{opt}$) electronic ports, PLR_D is around 10^{-7} , while PLR_F is around 10^{-8} . In our simulations, thanks to the proposed switching strategy, no R packets were lost using the hybrid switch. In fact, R packets make up only 10% of the global traffic and have the advantage of preemption at the level of the buffer access and also at the level of the optical ports. Thus the PLR constraint of the Reliable class service is satisfied. We may say that PLR_R is under the sensitivity of our simulations, or at least it is always less than $-\ln(5\%)/n_p(R) \simeq 10^{-7}$, where $n_p(R)$ is the number of all switched R packets.

Thus, thanks to our switching strategy, our hybrid switch satisfies all the service classes' requests in terms of PLR, especially the R packets. In addition, it makes a great

improvement compared to an all-optical switch and it is therefore a good solution for the contention issue.

2.5.2 Switch dimensioning: performance in terms of sustainable system load

For a degree-8 switch, we plot in Figures 2.6 and 2.7 the evolution of the sustainable system load respectively at $PLR_D = 10^{-4}$ and at $PLR_F = 10^{-4}$ as a function of the ratio between the number of electronic ports and the optical links ($n_e/[n_a \times n_c]$). This ratio refers to the reduction of the number of electronic ports by the hybrid switch (n_e ports) compared to an electrical switch ($n_a \times n_c$ ports). The reduction of the electronic ports could reduce the energy consumption as it will be detailed in section 2.5.5. We note that for interactive video packets (F packets), it is recommended that PLR must be lower than 10^{-2} across the network [134, 4]. Assuming paths can cross up to 100 nodes, we take as a reference a single node $PLR_F = 10^{-4}$, a simple division of 10^{-2} (PLR across the network) by 100 (nodes). We also impose the same constraint to PLR_D even though D packets are more tolerant to the PLR.

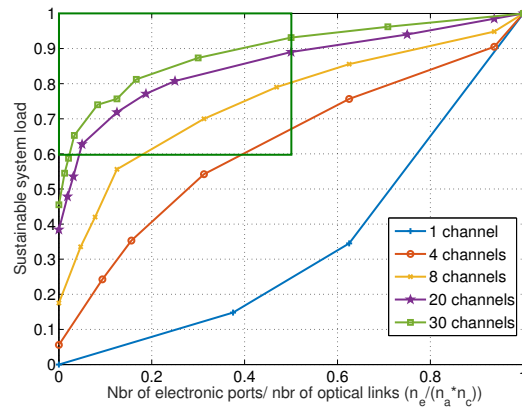

Figure 2.6: Sustainable system load vs $n_e/(n_a \times n_c)$ at $PLR_D = 10^{-4}$, $n_a = 8$

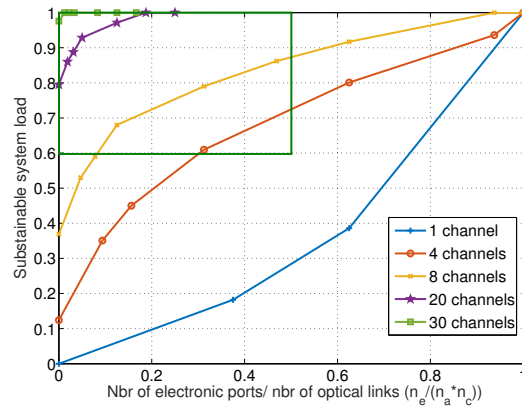

Figure 2.7: Sustainable system load vs $n_e/(n_a \times n_c)$ at $PLR_F = 10^{-4}$, $n_a = 8$

The hybrid switch is considered of interest when it satisfies two conditions:

- First, since we considered a system load of 60% as a minimum acceptable operating point, the sustainable system load must be ≥ 0.6 .
- Second, the buffer must incur significantly less O-E-O conversions than an all-electrical switch of the same size, which we choose to express as the condition: $n_e \leq (n_a \times n_c)/2$.

The area where these two conditions are fulfilled is presented by the rectangles in Figures 2.6 and 2.7 and permits us to find a trade-off between the performance improvement and the energy savings.

The sustainable load increases with n_e and reaches 1 for $n_e = n_a \times n_c$, where an ingress packet can always be collected by the buffer if it cannot be directly switched. Figures 2.6 and 2.7 show whenever the degree-8 hybrid switch is of interest, n_c and n_e have to be chosen among the values located inside the rectangles.

For a 60% loaded system, with 4 or more channels per azimuth, just $(0.4 \times n_a \times n_c)$ electronic ports are sufficient to have $\text{PLR}_D \leq 10^{-4}$, while PLR_F is less or equal to 10^{-4} for $(0.3 \times n_a \times n_c)$ electronic ports. Thus, the hybrid switch leads to an acceptable sustainable system load with the number of electrical ports lower than half that of optical links, or even fewer. Therefore, subject to a proper dimensioning of its parameters n_a , n_c and n_e , the hybrid switch is a good solution for both packet contention and O-E-O conversions.

2.5.3 About the buffer capacity

In our investigation, we didn't focus on sizing the shared buffer capacity, which we assumed to be infinite. However, to ensure that the memory requirements remain reasonable, we performed sampling simulations where we observe the number of packets that are currently in the buffer or being sent to the buffer (n_{buff}). Our simulations show that this number is always of the same order of magnitude as $2 \times n_e$ even for a fully-loaded system.

For example, Figure 2.8 (respectively Figure 2.9) presents the histogram of the percentage of occurrences of each value of n_{buff} , where $n_a = 8$, $n_c = 8$, $n_e = 12$ (respectively $n_e = 20$). We present the results for $\rho = 1$ and for $\rho = 0.8$. We choose the value of $\rho = 0.8$ because the latency, the number of buffered packets and the number of O-E-O conversions are in their maximum values at this load; and the value of $\rho = 1$ since it corresponds to a fully-loaded system. We think that these two cases are the most demanding ones where there is a strongest need of packet buffering. Sampling is performed after every 10^6 circulated packets. For a fully-loaded system, n_{buff} is respectively around 24 and 40 when $n_e = 12$ and 20. Other simulations with different values of the switch dimensions n_a , n_c and n_e show the same result: the demand on the buffer capacity remains reasonably limited.

2.5.4 Switching latency reduction

In this section, we compare our hybrid switch with commercial off-the-shelf switches, that rely on all-electronic technologies. We present the hybrid switch performance in terms of the delay (section 2.5.4.1) and compare it to a commercial Cisco switch (section 2.5.4.2).

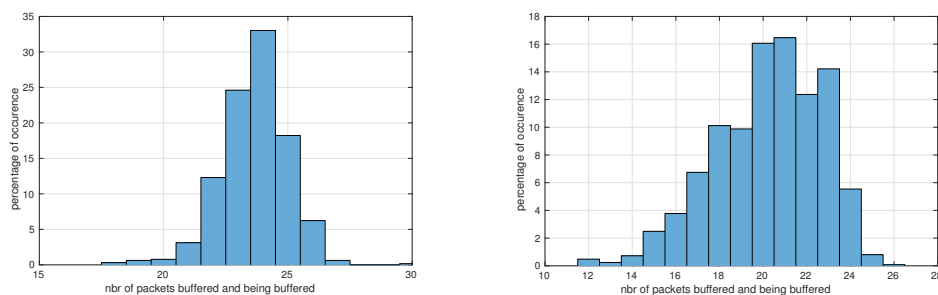

Figure 2.8: histogram - occurrence's percentage of the number of packets buffered and being buffered, $n_a = 8, n_c = 8, n_e = 12$, Left: $\rho = 1$, Right: $\rho = 0.8$

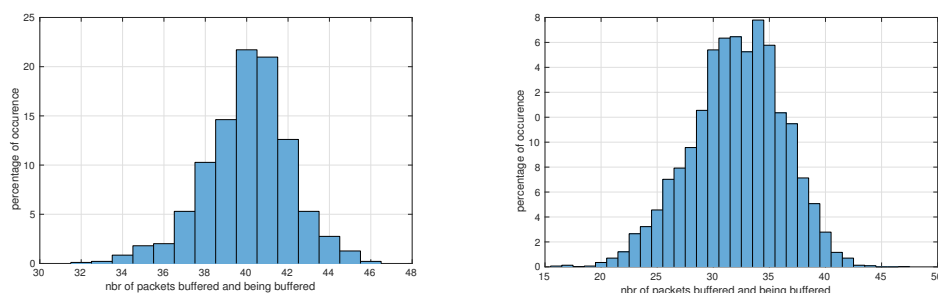

Figure 2.9: histogram - occurrence's percentage of the number of packets buffered and being buffered, $n_a = 8, n_c = 8, n_e = 20$, Left: $\rho = 1$, Right: $\rho = 0.8$

2.5.4.1 Performance in terms of the delay

Figure 2.10 shows the evolution of the average delay for each class of service versus the system load, for different values of n_a, n_c and n_e . Curves presenting Delay_F and Delay_D as functions of the system load are increasing then decreasing curves. Delays have non-zero values for a fully-loaded system ($\rho = 1$). Considering for example $(n_a, n_c, n_e) = (8, 8, 10)$, in Figure 2.10-(a), $\text{Delay}_D = 1.4 \mu\text{s}$. Then, delays increase as ρ decreases; for the same example, Delay_D has its maximum value ($1.68 \mu\text{s}$) at $\rho = 0.8$. But after that, delays decrease until reaching a null value at lower ρ . In fact, for a heavily-loaded system, F and D packets are often preempted by R packets when they are being transmitted to the buffer. They are less-commonly preempted when they are being sent directly to their destinations or during their retransmissions. So, F and D packets have little chance to be buffered; if they arrive at their destinations, in the majority of cases, they were sent directly. When ρ decreases, R packets have more chance to have free channels to their destinations or available buffer input ports, and so F and D packets are more likely to reach the buffer without being preempted. Therefore Delay_F and Delay_D increase (and of course their PLRs decrease). If ρ decreases more, it is even more common that F and D packets are sent directly to their destinations, and thus their delays decrease.

To further support interpretations, we present as an example for $(n_a, n_c, n_e) = (8, 8, 12)$, in Figure 2.11, the evolution of the number of packets sent directly in the optical field to their destinations, and the number of packets that were buffered before being successfully sent to their final egress, as functions of ρ . Indeed, the curves presenting the “buffered

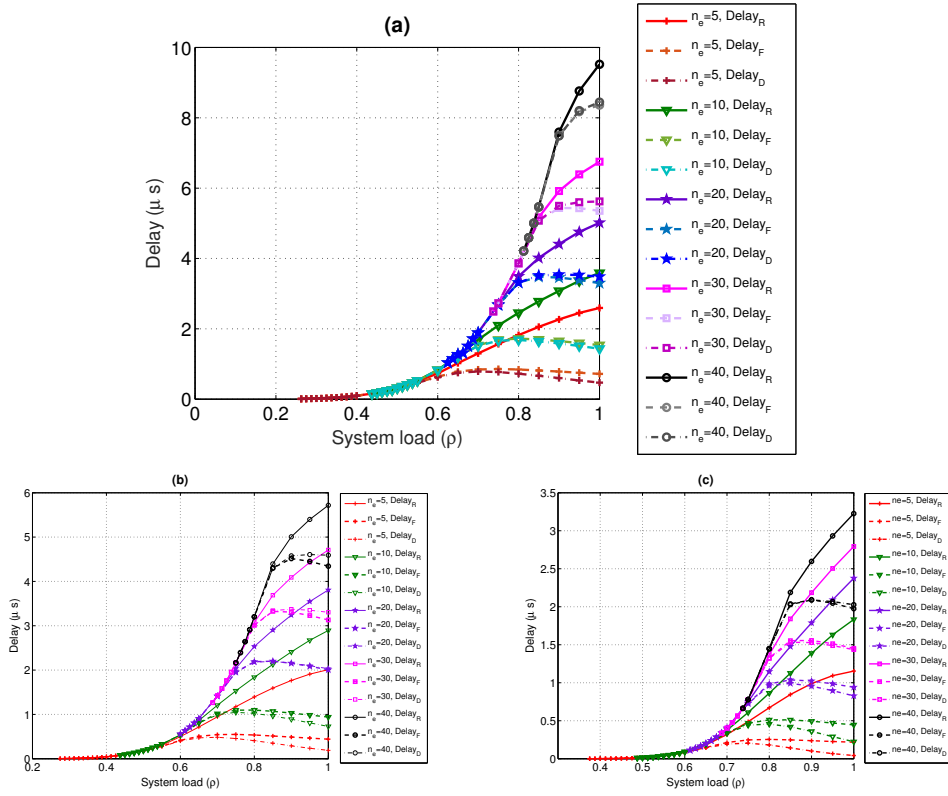

Figure 2.10: *Delays of R, F and D packets vs system load, (a): $n_a = 8, n_c = 8$; (b): $n_a = 10, n_c = 10$; (c): $n_a = 10, n_c = 20$*

then successfully sent” F and D packets have the same shape as those of Delay_F and Delay_D.

Besides, as seen in Figure 2.10-(a), for a low number of electronic ports ($n_e \leq 10$), Delay_D is lower than Delay_F. This is due to the numerous preemptions of D packets that are, consequently, rarely buffered. We remind that the delay is null for optically switched packets but countable for buffered then reemitted packets (see equation 2.2.) However, for a higher number of electronic ports ($n_e \geq 10$), Delay_F is lower than Delay_D; there are more available ports to the buffer, more D packets can be buffered, PLR_D decreases but at the expense of Delay_D increase.

When $n_a = 8$ and $n_c = 8$, even with 40 electronic ports, switching delays are less than 10 μs. Considering other switch dimensions, we present in Figure 2.10-(b) and (c) the evolution of the delays as a function of ρ for $n_a = 10$ and $n_c = 10$ or 20 as examples. Delays are respectively less than 6 μs and 3.5 μs when ($n_c = 10$ and $n_e = 40 = 0.4 \times n_a \times n_c$) and when ($n_c = 20$ and $n_e = 40 = 0.2 \times n_a \times n_c$).

In practice, voice and interactive video (Fast packets) require 150 ms one-way, end-to-end delay, while streaming-video has much laxer requirements because of a high amount of buffering that has been built into the applications [4]. Our simulation results show that switching delays are less than 10 μs, with 4 orders of magnitude below acceptable limits. Therefore, the hybrid switch satisfies the delay condition even for Fast packets.

Considering the buffer output ports access technique, Figure 2.12 shows the comparison between the two techniques “FIFO” and “re-emission prioritization” for $n_a = 8$

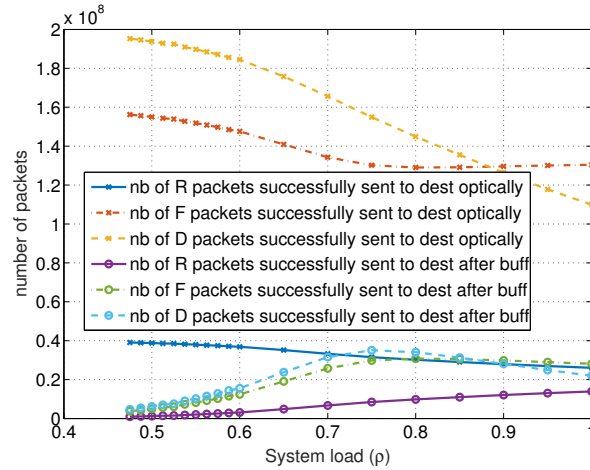

Figure 2.11: *Nbr of packets successfully sent to their destinations, directly or after bufferization, vs system load, $n_a = 8, n_c = 8, n_e = 12$*

and $n_c = 8$. The difference appears only if $n_e > 12$: when the buffer consists of only a few ports, R packets with no available channel or buffer port can preempt F packets (as a second preference after D packets) that are being stored into the buffer, so there will not be many buffered F packets and the technique used for the re-emission won't have influence. Otherwise, when the buffer has more electrical ports, there will be less preempted packets and therefore more F stored packets. Delay_F decreases when F packets have the priority to be re-emitted before R and D packets. Taking the example of $n_e = 40$, Delay_F decreases by $\sim 2 \mu\text{s}$, at the expense of an increase of Delay_R by $\sim 7 \mu\text{s}$. Considering the percentages of each class relative to the global traffic, the average delay of all the packets doesn't change.

In all cases, the switching delays are in the order of magnitude of some μs , thus the delay constraint is satisfied even for Fast packets.

Since we are considering the mean delay for each class of packets, another aspect that we investigated is the verification whether all the delays of all the buffered then switched packets are in the same order of magnitude of some μs , or there are some packets which spend significant delays in the buffer. Indeed, a Fast packet should be considered as lost if its delay isn't lower than the acceptable limit of 150 ms one-way, end-to-end delay. Moreover, when using the Transmission Control Protocol (TCP, the most predominant transport layer protocol in Internet over IP for reliability [138]), if an emitter Tx sends a packet to a receiver Rx and doesn't receive back an acknowledgment of reception after a certain delay, called Retransmission TimeOut (RTO), it assumes that its packet is lost and retransmit it again. Significant switching delays (\geq RTO) result thus in redundant packet transmissions and TCP packet ordering deficiency. It is recommended to set the RTO value at 1 second. In [139], the authors show that in Ethernet-based access network, lower minimum RTO settings than the recommended 1-second minimum (about a few hundred ms) will work when there is moderate background traffic, but the 1-second minimum is best when there are higher levels of congestion.

We count the number of packets having delays inside different intervals. In the appendix C, we present the distribution of packets arrived at their destinations after bufferization according to their delays. The results of these simulations show that the quasi-totality of the delays are in the same order of magnitude: some μs , acceptable

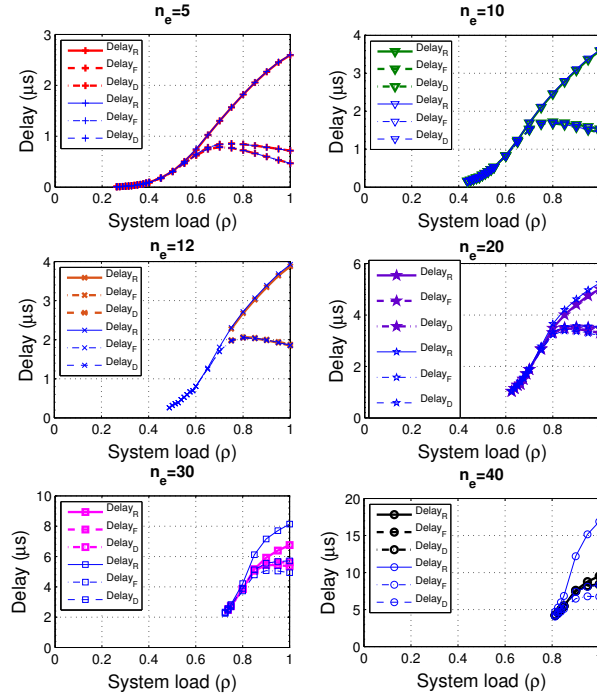

Figure 2.12: *Delay vs system load, Technique of re-emission: re-emission prioritization (thin curves) vs FIFO (bold curves), $n_a = 8$, $n_c = 8$*

delays for TCP packets ordering. Considering especially the most restrictive packets to the latency, no F packets have delays higher than 10^{-4} s (or 2×10^{-4} s) for a hybrid switch dimensioned as $n_a = 8$, $n_c = 8$ and $n_e = 12$ (or respectively $n_e = 20$).

2.5.4.2 Comparison of delays with a commercial switch

In order to compare the hybrid switch performance in terms of delay with electrical switches currently existing on the market, we considered for example the Cisco Nexus® 3064PQ Switch with sixty-four 10 Gigabit Ethernet ports [137]. We fixed the parameters of our hybrid switch to $n_a = 8$ and $n_c = 8$, thus to have 64 packets emitters. The LIFO (Last In Last Out) latency for the Cisco Cut-Through switch is equal to $1.34 \mu\text{s}$, while we consider that the latency of our switch is null for packets switched directly on the optical field since they are not buffered and they are not subject to the scheduling algorithms, memory writing and reading operations.

The LIFO latency for the Cisco Store and Forward switch is about $11 \mu\text{s}$ for a 100 kbit packet. For a fully-loaded system, our hybrid switch leads to an average delay of $1.7 \mu\text{s}$ for buffered packets when $n_e = 10 = 0.15 \times n_{opt}$ and $8.5 \mu\text{s}$ when $n_e = 40 = 0.62 \times n_{opt}$. So, the delays obtained with the hybrid switch are in the same order of magnitude or even lower than those obtained with the commercial electrical one. The latency reduction may be explained by the reduction of O-E-O conversions that depends linearly on the number of buffered packets and is quantified in the following section.

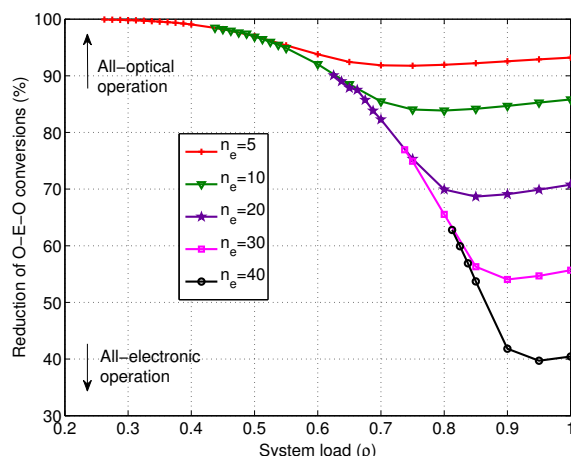

Figure 2.13: Reduction of O-E-O conversions vs system load, $n_a = 8$, $n_c = 8$

2.5.5 Reduction of O-E-O conversions

Here, we focus on the reduction of O-E-O conversions achieved by the hybrid switch compared to an electrical switch, which is another indicator of reduced energy consumption. More precisely, assuming that electrical switches consume energy mostly through O-E-O conversions, energy savings are between the $n_e/[n_a \times n_c]$ ratio that we presented earlier (assuming that the n_e electronic ports are always on) and the actual reduction in O-E-O converted packets (best case, with electronic ports capable of sleep mode when not in use).

We present in Figure 2.13 the evolution of the O-E-O conversions' reduction as a function of the system load for degree-8 switch with 8 channels per azimuth and for different values of n_e . The reduction in percentage is equal to:

$$\text{O-E-O reduction} = 100\% \times \left(1 - \frac{\text{nbr of buffered packets}}{\text{nbr of all switched packets}} \right) \quad (2.3)$$

As expected, the curves have the same shape as those presenting the evolution of the number of buffered packets (Figure 2.11). For a highly-loaded system, the more electronic ports the hybrid switch has, the less important the O-E-O conversions reduction is. In this case the buffer is used often.

We note that the curves become superimposed when the system load decreases. For example, at a system load of 0.65, having 10 or more electronic ports leads to the same percentage of O-E-O reduction which is 87%. However, having the same O-E-O decrease regardless of n_e doesn't mean having the same PLRs. Indeed, for a given value of n_e , a certain proportion of packets are sent to the buffer and O-E-O conversions take place, but some D and F packets are then preempted when they are being sent to the buffer by R packets. If the switch has more electronic ports, the same number of O-E-O conversions will take place but fewer packets will be preempted, and thus PLRs will decrease.

The reduction of O-E-O conversions is higher than 40% even with 40 electronic ports and for a considerably loaded system ($\rho = 0.95$). At a system load of 0.75, the hybrid switch does away with more than 75% of O-E-O conversions compared to an all-electrical switch, whatever the number of buffer ports. Thus, compared to an all-electrical switch,

the reduction of O-E-O conversions by the hybrid switch is important and leads to the reduction of power consumption especially if the electronic ports are capable of sleep mode while not in use. We note that within the context of dynamic networks, the telecommunication operator should find a trade off between the energy savings and the network dynamicity (the system load) in order to decide to operate the sleep mode or not.

2.5.6 Distribution of packet classes

We aim to investigate the switch performance when the traffic profile is different from the typical distribution in metro and core networks, where R, F and D packets make up respectively 10, 40 and 50% of the global traffic [135]. We change the distribution of R, F and D packets but slightly in order to stay in a telecommunication use case. We note that, according to the article [138] based on the Conviva dataset, 26% of the network traffic consists of live video streaming (F) packets and 44% consists of Video on demand (VoD) (Default) packets.

Instead of the distribution of R: 10%, F: 40% and D: 50%, we considered the following percentages:

- R: 5%, F: 40% and D: 55%.
- R: 10%, F: 35% and D: 55%.
- R: 15%, F: 35% and D: 50%.
- R: 15%, F: 40% and D: 45%.

We considered a hybrid switch having the dimensions: $n_a = 8$, $n_c = 8$ and $n_e = 12$. Figures 2.14, 2.15 and 2.16 present respectively the performance in terms of the PLR, latency and O-E-O reduction for the different distributions.

The results are quite similar for all the studied packet distributions. PLR_F is slightly higher in the distribution (R: 15%, F: 40% and D: 45%) than the other distributions because the percentage of R packets is relatively high, they preempt more F packets and increase the competition on preempting D packets; besides the percentage of D packets is relatively low, so there is no many preemption possibilities. However the difference is small, $PLR_F = 2 \times 10^{-3}$ at $\rho = 0.8$ for the distribution (R: 15%, F: 40% and D: 45%) compared to $PLR_F = 10^{-3}$ for other distributions. Thus, slightly changing the distribution of packet classes while keeping a realistic use case quite similar to the traffic profile in metro and core networks [135] doesn't affect the performance analysis of our hybrid switch.

2.6 Conclusion

Our investigation shows that the proposed hybrid switch, connected to interchangeable channels, is a good compromise between all-optical bufferless switches and off-the-shelf electrical switches. In fact, it leads to much better performance in terms of PLR and sustainable system load compared to all-optical switches, and meets the requirements of the different packet classes (especially for reliable data packets) for a relatively low number of electronic ports to/from the shared buffer. In addition, compared to electrical switches, the hybrid switch reduces the switching latency, which is acceptable even for fast voice and interactive video packets.

To dimension the hybrid switch, we tried to find a trade-off between the performance improvements, notably in terms of PLR and sustainable load, and the energy savings. Indeed, compared to an all-electrical switch, the hybrid switch reduces the number of electronic ports from $(n_a \times n_c)$ to only (n_e) ports. Furthermore, it significantly decreases

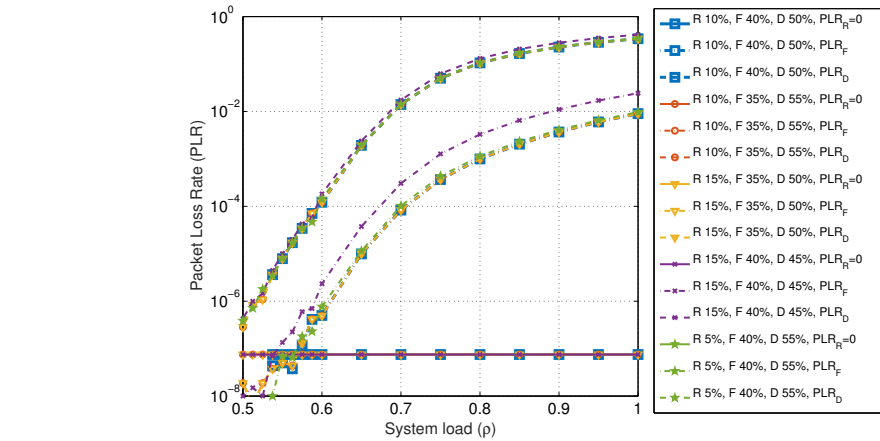

Figure 2.14: Comparison between different packet classes distributions in terms of PLR, $n_a = 8, n_c = 8, n_e = 12$

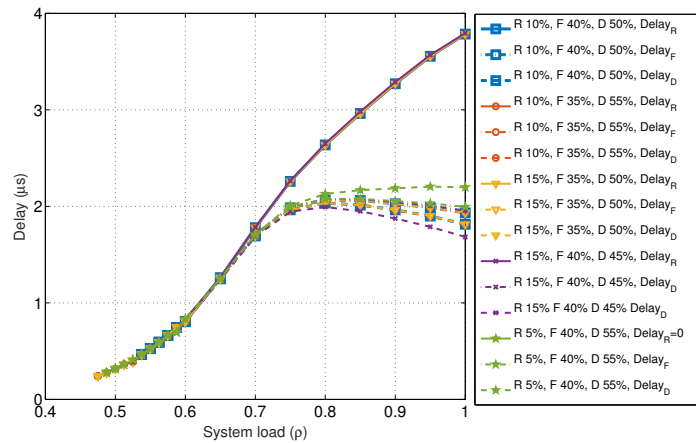

Figure 2.15: Comparison between different packet classes distributions in terms of latency, $n_a = 8, n_c = 8, n_e = 12$

the O-E-O conversions, which may reduce the energy consumption still further if the buffer ports are capable of sleep mode when not in use. Thus, the hybrid switch is a promising solution to reduce power consumption. This is a great advantage since the power consumption is becoming an important issue due to the increasing amount of circulated data on networks.

In chapter 3, we will consider WDM channels, which do not satisfy the interchangeability condition, but are the most widely used in optical networks for multiplexing channels on a single fiber.

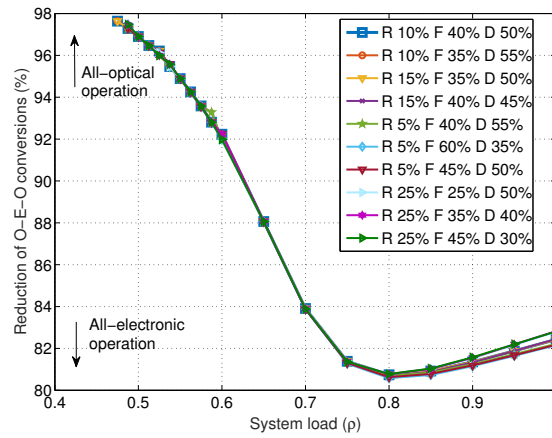

Figure 2.16: Comparison between different packet classes distributions in terms of O-E-O reduction, $n_a = 8$, $n_c = 8$, $n_e = 12$

Chapter 3

Performance analysis of hybrid opto-electronic packet switch supporting wavelength-specific packets

3.1 Introduction

Telecommunication networks are expanding, services and applications are multiplying and the number of users is exponentially increasing. The number of Internet users was 1.7 billion at the end of 2009, according to ITU's World Telecommunication/ICT Development Reports [140], and reached 3.2 billions in 2015. Mobile-cellular subscriptions reached 7.1 billions worldwide in 2015.

A challenge of telecommunication networks, always relevant, is to increase their transmission capacity. Increasing the transmission capacity of the infrastructure already employed and using it efficiently is generally more beneficial than adding new fibers and expanding the number of equipments in terms of cost [141]. Typically, the most used solution in optical networks is Wavelength Division Multiplexing (WDM). This technique permits to send several optical carrier signals onto a single optical fiber, each signal at a certain wavelength. It also enables bidirectional communications over one fiber and leads thus to a significant increase on the transmission capacity of single fibers.

In this chapter, we extend our performance investigation of the proposed hybrid switch in the context of WDM networks. We assume that our hybrid switch is connected to its azimuths through wavelength-specific channels. WDM channels do not satisfy the interchangeability condition, so we need to process them differently: a packet transmitted at a certain wavelength must be switched to its destination through the channel supporting that same wavelength. Packets are distributed as Reliable (R), Fast (F) and Default (D) packets.

In section 3.2, our switch is connected to its azimuths through WDM channels only. In this case, wavelength converters would be required [27] to offer some possibilities of channels interchangeability and ameliorate the results in terms of PLR and sustainable system load. However, since they are energetically costly, we opt for using shared converters. We will investigate if the shared buffer or the shared wavelength converters make a better compromise between the switching performance and the energy consumption

reduction [28].

In section 3.3, we will pursue our investigation by importing the benefits of channels interchangeability, via combining Space Division Multiplexing (SDM) and WDM techniques. The switch will be connected to SDM fibers, such as multi-mode or multi-core fibers, supporting WDM on each mode or core [29]. SDM increases the transmission capacity and offers channels interchangeability. Thus, the switch performance would be improved by the SDM-WDM combination.

In addition, in section 3.4, within the hybrid switch architecture of combined SDM and WDM, we will study its performance supporting specific traffic profile, where R packets have higher percentage such as in computing data centers. We will compare the results with those of the general traffic profile case [142].

3.2 Switch performance when connected through WDM channels

Assuming that our hybrid switch is connected to wavelength-specific channels, we followed the same simulations steps as in the case of interchangeable channels (see section 2.4 of chapter 2). We assume that the electronic buffer can receive and especially send packets having any wavelength on any port. In practice, this requires fast tunable or selective lasers [143] in the level of the buffer output ports. In the case of using tunable lasers, their emission time should be considered to count the latencies. For example, the maximum tuning speed of TLB-6718 tunable laser of the company Newport is equal to 10 nm/s, i.e. it can deviate the wavelength by 10 nm in one second [144]. PICO D laser of the company ThorLabs has a tuning speed of 10 nm per 100 ms [145]. R, F and D packets respectively make up 10, 40 and 50% of the global traffic [135].

3.2.1 Results in terms of the sustainable system load

Figure 3.1 shows the evolution of the sustainable system load ρ at $PLR_D = 10^{-4}$ and $PLR_F = 10^{-4}$ as a function of the ratio between the number of electronic ports and the optical links ($n_e/[n_a \times n_c]$) for a hybrid switch connected to its azimuths through WDM channels.

More channels the switch has, higher the sustainable load is. For instance, the sustainable ρ at $PLR_D = 10^{-4}$ is equal to 0.2 when $n_c = 4$ compared to 0.33 when $n_c = 30$, both for $n_e = 0.2 \times n_a \times n_c$. However the increase of the sustainable ρ as a function of n_c is not linear; the curves relative to $n_c = 20$ and $n_c = 30$ are almost superimposed. In fact, at a system load ρ , when all the packets circulated in the switch are stowed (i.e. either being transmitted through the optical channels or being buffered), if a new packet should be sent to its destination through a wavelength λ_i while the corresponding channel is unavailable and there is no possibility to access the buffer, the packet is dropped. Increasing the number of channels n_c would not solve the problem because the channels added don't correspond to that wavelength λ_i . We observe that the degree-8 switch would be over-sized if $n_c \geq 20$ WDM channels. In current practical networks, it is common to multiplex $n_c = 80$ or 100 WDM channels, but since there is no improvement achieved when n_c increased from 20 to 30 channels, and due to the long simulation times, we didn't exceed the value of $n_c = 30$.

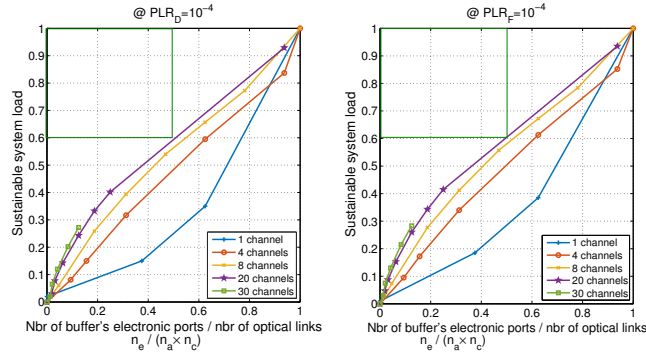

Figure 3.1: Sustainable system load at $PLR_D = 10^{-4}$ (Left) and $PLR_F = 10^{-4}$ (Right) vs $n_e/(n_a \times n_c)$, $n_a = 8$, $n_c \in \{1, 4, 8, 20, 30\}$ WDM channels

Although the hybrid switch with WDM channels improves the performance in terms of PLR compared to an all-optical bufferless switch, we remark that it is not possible to have an acceptable sustainable ρ while the buffer incurs significantly less O-E-O conversions than an all-electrical switch of the same size: the two conditions of (sustainable $\rho \geq 0.6$) and ($n_e \leq (n_a \times n_c)/2$) are not fulfilled simultaneously. A way to fulfil both conditions would be to use wavelength converters, which basically make WDM channels interchangeable. If each optical link has its own λ converter, the performance will be equivalent to those of interchangeable channels case. However, we have to limit the use of λ converters because they are energetically costly [132]. In addition, if the λ converters are based on O-E-O conversions, supplementing the hybrid switch with as many wavelength converters as n_{opt} would make it with no interest compared to electrical switches in terms of reducing the O-E-O conversions and eventually the energy consumption. Thus, we opt for *shared* λ converters.

3.2.2 Use of wavelength converters

We supplement the switch with n_{wvcv} shared wavelength converters. All-optical wavelength converters are based on wavelength interferences and non linear effects such as Four Wave Mixing (FWM) that occurs between the signal wavelength and the pumping wavelength of the converter. Wavelength conversions are not possible from any λ_i to any λ_j but depend on existing wavelengths in the system and the pumping wavelength. Due to this constraint and to the difficulty of adjusting the pumping wavelength, they are not used in practice [146, 147]. Electrical wavelength converters are based on O-E-O conversions and work as a set of receivers and emitters. The optical signal transmitted at a wavelength λ_i is converted to the electrical field, then the extracted data is re-converted to the optical field at a new wavelength λ_j . Fast tunable lasers at the re-emission level make wavelength conversions possible from any λ_i to any λ_j . In this case, the λ converter is considered as "ideal". Opto-electrical λ converters have this advantage of wavelength independance compared to all-optical converters, however they are not widely used because they are expensive and consume energy. Basically, in optical networks design stage, λ conversions are avoided, but in case of need, electrical converters are applied.

In our simulations, we assume that the shared λ converters are "ideal" opto-electrical ones. In fact we want to compare the use of λ converters to the employment of more

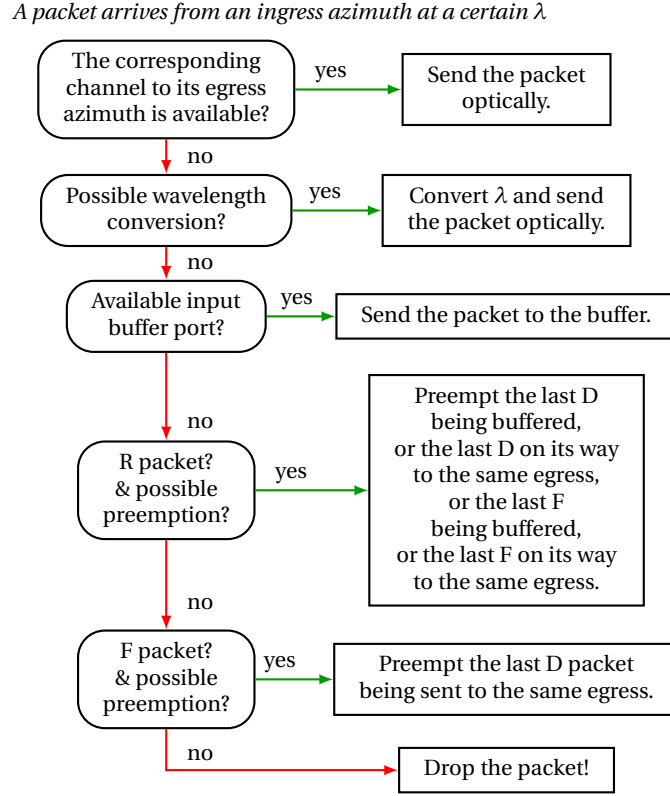

Figure 3.2: *The switching policy in WDM systems*

electronic buffer ports in terms of the switching performance (notably the PLR) but also in terms of the requirement of O-E-O conversions. This comparison could show which solution leads to a better compromise between the contention resolution and the energy saving.

Each shared converter has n_c input ports, as well as n_c output ports and may convert up to n_c wavelengths simultaneously. Any wavelength can be converted to any other wavelength if its correspondent output port is free. We also assume that they work in cut-through mode: a wavelength conversion starts before the whole packet has been received by the converter. So, during a wavelength conversion, the correspondent input and output ports are both occupied. Moreover, giving the “cut-through” assumption, converting a packet’s wavelength will not lead to an additional latency. The propagation distance inside the optical switching matrix is no longer than very few meters [21], the delay of the optical transmission (ingress switch port- λ converter-egress port) is thus neglected, in the order of ns. In our simulations, n_{wvcv} takes the values of 0, 1, 2 or 3 converters.

The new switching strategy is presented in Figure 3.2. Both converting a packet’s wavelength or sending it to the buffer require O-E-O conversion, however to reduce the switching latency, trying to convert a packet wavelength comes before trying to send it to the buffer.

We consider in Figure 3.3 that $n_c = 8$ WDM channels per azimuth. The sustainable ρ is given at $PLR_D = 10^{-4}$ (Left) and $PLR_F = 10^{-4}$ (Right). We plot the curves corresponding to WDM channels and also to interchangeable channels. We observe that supplementing

the WDM-channel hybrid switch with wavelength converters permits to have acceptable sustainable ρ , that is greater than 0.6 while the number of electronic ports is lower than half the number of optical links. For example, with just one converter, the sustainable ρ is around 60% at $PLR_F = 10^{-4}$ when $n_e = 30 \simeq (n_a \times n_c)/2$.

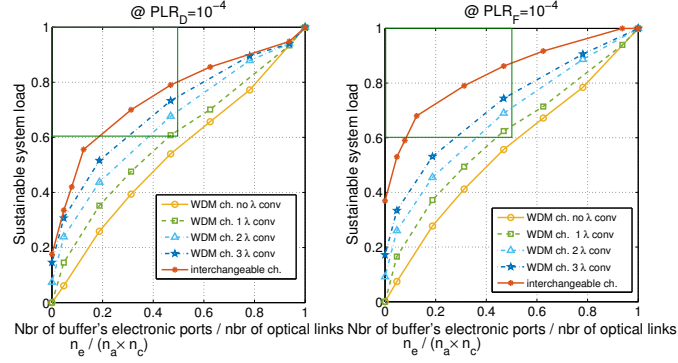

Figure 3.3: Sustainable system load at $PLR_D = 10^{-4}$ (Left) and $PLR_F = 10^{-4}$ (Right) vs $n_e/(n_a \times n_c)$, $n_a = 8$ and $n_c = 8$ interchangeable or WDM channels, $n_{wvcv} \in \{0, 1, 2, 3\}$

We remark that the increase of the sustainable ρ when we add just one converter to the switch is higher than the additional increase achieved when we add another converter. For example, when $n_e = 0.18 \times n_a \times n_c = 12$ electronic ports, supplementing the hybrid switch with one wavelength converter increases the sustainable ρ at $PLR_F = 10^{-4}$ by 9.43%. Adding a second converter makes an additional increase of 8.3% for the same n_e , and adding a third converter increases ρ with 7.6% more, because the sustainable ρ becomes closer to its maximum in the best case: when channels are interchangeable.

Moreover, *having additional electronic ports is more beneficial than having additional wavelength converter ports*. Considering the same example ($n_a = 8, n_c = 8, n_e = 12$), adding a wavelength converter with 8 ports increased the sustainable system load at $PLR_F = 10^{-4}$ by 9.43%, while having 8 more electronic ports to the buffer leads to an increase of 12.2%.

Considering the delay criterion, Figure 3.4 shows the evolution of the average delay for each class of service versus the system load for the example of a degree-8 hybrid switch with 8 WDM channels per azimuth and 30 electronic ports. We present also the delays in the case of interchangeable channels. The shape of the delays' curves is explained in section 2.5.4 of chapter 2.

The delays in the case of WDM channels are greater (6 μ s at a system load of 70%) than the ones in interchangeable channels case (2 μ s) since more packets need to be buffered. However, all the delays are less than ~ 10 μ s, 4 orders of magnitude below acceptable limits for Fast packets, that are the most restrictive packets in terms of the delay. In addition, thanks to the switching strategy, supplementing the hybrid switch with wavelength converters decreases the delays: if a packet doesn't have an available channel to its destination, the switch first tries to convert its wavelength, only then does it try to send it to the buffer.

We note that the choice of a packet's new wavelength is made arbitrary among the available wavelengths to the packet destination. However, in a network context, when a wavelength is added to (or dropped from) a WDM network, the transmission quality on other wavelengths may be affected. Thus, in chapter 4, we will focus on the choice of the

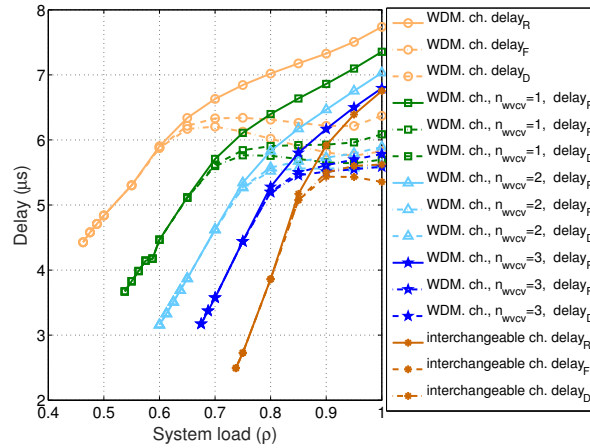

Figure 3.4: Delays of R , F and D packets vs system load, $(n_a, n_c, n_e) = (8, 8, 30)$

wavelength to add (or drop) in order to minimize its impact on existing wavelengths in the system.

3.2.3 Still saves energy?

Supplementing the WDM-channel hybrid switch with wavelength converters reduces the PLRs and the delays. However, wavelength converters themselves consume power [148] and may negate the energy savings achieved by the hybrid switch compared to electrical switches. Since the wavelength converters are considered as “ideal” (see definition in the beginning of section 3.2.2), a wavelength conversion consumes as much power as an O-E-O conversion. So, we will compare the percentage of O-E-O reduction with the percentage of wavelength conversions. In fact, since evaluating the number of O-E and E-O conversions gives an estimation of relative power consumption, this comparison may indicate if shared λ converters make a good compromise between the performance improvement and the energy savings. We will consider the example of a degree-8 hybrid switch with 4 or 8 WDM channels per azimuth.

3.2.3.1 Reduction of O-E-O conversions

We compare the hybrid switch to an electrical switch, through the reduction of O-E-O conversions (equation 2.3). This gives an idea about the reduction of energy consumption, especially if the electronic ports may be in a sleep-mode while not being used. For a specific switch dimensions (fixed n_a , n_c , n_e and n_{wvcv}), the reduction of O-E-O conversions depends on the system load ρ . We will consider the worst case, the minimum reduction that could be achieved. We present in Figure 3.5 the evolution of the minimum O-E-O conversions’ reduction as a function of n_e .

When the number of buffer ports is equal to the half of optical links ($n_e = 0.5 \times n_a \times n_c$), compared to an all-electrical switch, the hybrid switch having up to 3 wavelength converters does away with at least 45% of O-E-O conversions when $n_c = 4$ and with at least 40% when $n_c = 8$ WDM channels. These percentages seem to be important, it remains to compare them to the percentages of wavelength conversions.

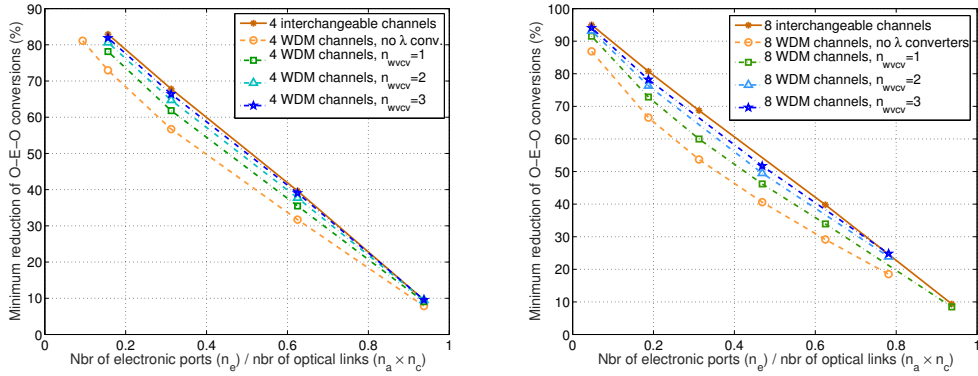

Figure 3.5: Minimum reduction of O-E-O conversions vs $n_e/(n_a \times n_c)$, $n_a = 8$, $n_c = 4$ (Left) or $n_c = 8$ (Right)

3.2.3.2 Wavelength conversions rate

Figure 3.6 presents the evolution of the wavelength conversions rate as a function of ρ . The wavelength conversions rate is the ratio between the number of packets sent directly to their egress azimuths at converted wavelengths, without being buffered, and the number of all switched packets. We consider only the conversions carried out by the n_{wvcv} λ converters, potential wavelength conversions after a storage in the buffer are excluded because we the latter are counted among the O-E-O conversions due to the use of the buffer.

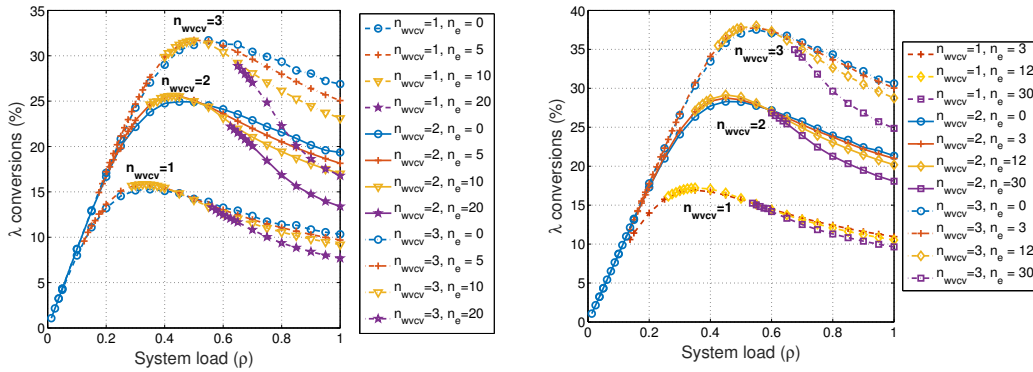

Figure 3.6: Rate of wavelength conversions vs system load, $n_a = 8$, $n_c = 4$ (Left) or $n_c = 8$ (Right)

The rate of wavelength conversions for a given number of converters (n_{wvcv}) has almost the same maximum value regardless of n_e . Moreover, the additional increase of the conversions rate is more important when n_{wvcv} passes from 1 to 2, than when it passes from 2 to 3 converters... This result is coherent with the sustainable system load increase as a function of the number of additional wavelength converters (Figure 3.3). For example, for $n_c = 4$ WDM channels per azimuth, no more than 15% of the packets are wavelength-converted when the switch has one converter. The maximum rate is 25% when the switch has 2 converters, means with additional 10% of λ conversions. If the

switch has 3 converters, the maximum conversions rate is equal to 32% with an additional rate of just 7%.

When the switch has 8 channels per azimuth and 3 wavelength converters, at a system load of $\rho = 0.5$, up to 37% of the switched packets are wavelength-converted, which is a considerable rate. However, even for this "poor" example, the hybrid switch makes away with 50% of the O-E-O conversions compared to an electrical one.

Thus, considering that a wavelength conversion consumes as much power as an O-E-O conversion, the energy consumption caused by the use of wavelength converters is much lower than the energy savings of the hybrid switch compared to electrical ones.

Regarding the improvement of the WDM-channel hybrid switch performance, it is worthy to use shared wavelength converters when no more buffer ports could be added, especially since their energy consumption is far from negating the hybrid switch energy savings.

3.3 Performance improvements using Space Division Multiplexing (SDM) in addition to WDM

3.3.1 Reasons for using SDM

To respond to users demands (described in section 3.1) and transmit their information over networks infrastructure, researchers have explored and attempted to optimize multiplexing in time (TDM), wavelength (WDM), polarization (PDM) and phase (XPM). Another dimension, still under-investigation for commercial use, is the space. Information can be sent as independent signals through parallel channels, such as the different modes of multi-mode fibers or cores of multi-core fibers.

Multi-mode fibers (MMF) have larger core than single mode fibers (SMF), with a diameter of (common size) 62.5 or 50 μm compared to 9 μm for SMFs. MMF can carry several light rays, each one follows a route depending on the angle of refraction. The rays are reflected on the core-cladding surface, leading to higher signal dispersion compared to SMFs where the single light ray is transmitted straightly. Particularly, a 2-mode MMF fiber is considered as a "Weakly MMF (WMMF)" fiber or Few Mode Fiber (FMF) because the number of modes is relatively small. Multi-core fibers have different adjacent cores, commonly 7 cores [123], covered together by the same cladding. Each core may be considered as an SMF fiber. Multi-core fibers lead thus to lower signal dispersion than MMF fibers when the number of cores and modes are equal. Both kind of fibers are manufactured. The architectures of SMF, MMF and 7-core fibers are presented in Figure 3.7. Compared to WDM, SDM has the advantage of channel interchangeability. The SDM channels are non-wavelength-specific ones; an optical signal is sent through any available channel, independently of other signals.

In order to improve the switching performance over WDM-only links, we combine SDM and WDM at the level of the switch connectivity. The switch may be connected to its azimuths through SDM multi-mode or multi-core fibers supporting WDM on each mode or core. In this case, the switch may be integrated in a WDM network while offering some interchangeability and thus less contention thanks to SDM. Our assumption of SDM-WDM switch connectivity is closer to the case of transmitting WDM signals on multi-core fibers since the different cores are simply parallel interchangeable channels

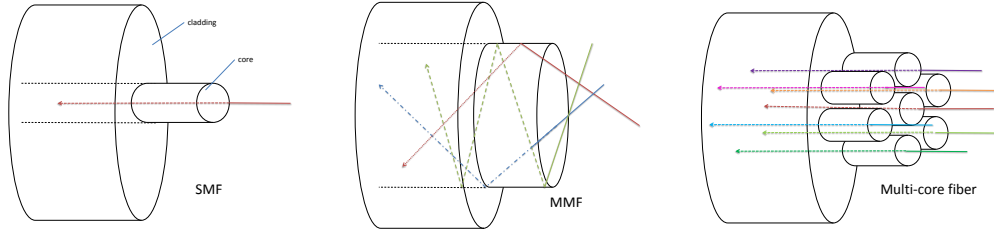

Figure 3.7: Architecture of (a) SMF, (b) MMF and (c) 7-core fibers

(like parallel SMF fibers) and there is less constraints on the signal injections to the fibers compared to MMF fibers. The new architecture is presented by the following.

3.3.2 The hybrid switch architecture

Our hybrid switch, presented in Figure 3.8, is connected to n_a bidirectional azimuths. Each azimuth supports n_c interchangeable channels in each direction. n_λ wavelengths are supported by each channel. The shared electronic buffer has n_e input as well as n_e output ports. The switch can also have n_{wvcv} shared wavelength converters working in a cut-through mode. Figure 3.8 presents the case of $n_{wvcv} = 1$.

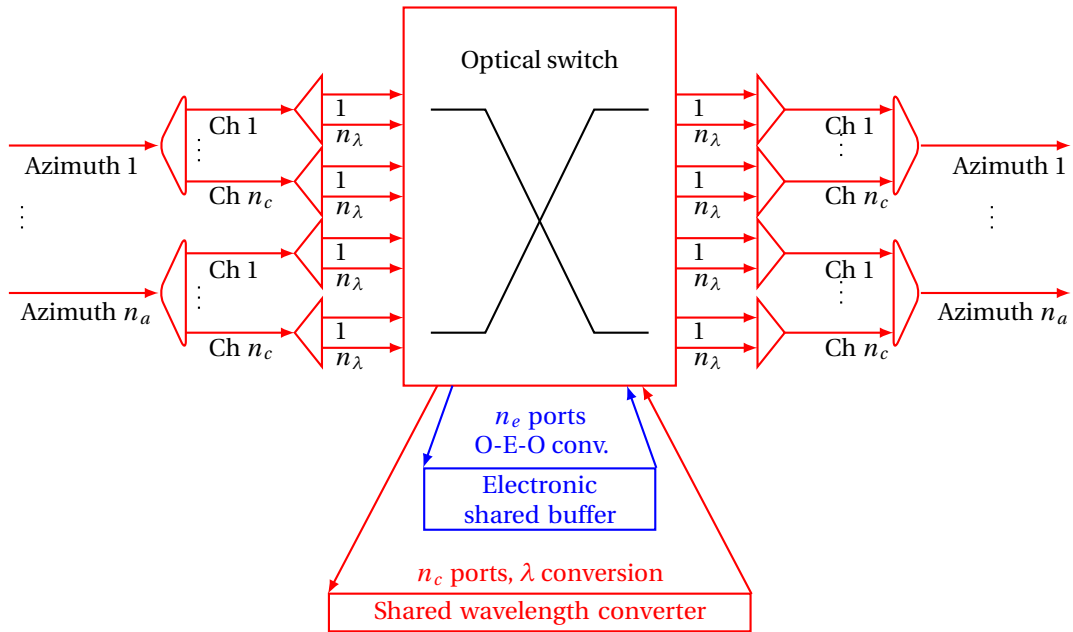

Figure 3.8: Architecture of hybrid switch connected to SDM-WDM channels

Each wavelength converter has n_c input as well as n_c output ports and may convert up to n_c wavelengths simultaneously. We suppose that conversions are possible from any λ_i to any available λ_j . Given that all-optical wavelength converters usually can't satisfy this requirement, we shall consider that each wavelength conversion is based on O-E-O conversion and consumes as much energy as an O-E-O conversion.

The switching strategy is the same as in the case of WDM-only channels, and was presented in Figure 3.2. The switch supports Reliable (R), Fast (F) and Default (D) packets. We remind that they respectively make up 10, 40 and 50% of the global traffic [135]. We follow the same simulation steps as previously.

3.3.3 Improvement of the sustainable system load

3.3.3.1 Comparison between SDM-WDM and WDM-only links

We compare the case of SDM-WDM to WDM-only and interchangeable links. Figure 3.9 presents the sustainable ρ at $\text{PLR}_F \leq 10^{-4}$ as a function of the ratio (n_e/n_{opt}) . This ratio refers to the reduction of the number of electronic ports by the hybrid switch (just n_e) compared to an electrical one which needs $(n_{opt} = n_a \times n_c \times n_\lambda)$ ports. We remind that it is recommended to have $\text{PLR}_F \leq 10^{-2}$ across the network [134]. Assuming paths can cross up to 100 nodes, we take as a reference a single-node $\text{PLR}_F = 10^{-2}$: a simple division of 10^{-2} (PLR across the network) by 100 (nodes). We consider as an example a

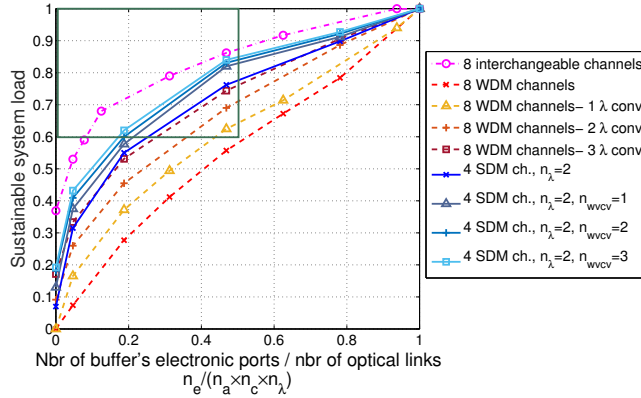

Figure 3.9: Sustainable ρ vs $n_e/(n_a \times n_c \times n_\lambda)$ at $\text{PLR}_F = 10^{-4}$, $n_a = 8$, $n_c = 8$ for interchangeable or WDM-only channels, $n_c = 4$ and $n_\lambda = 2$ for SDM-WDM links

degree-8 switch with 8 channels per azimuth for WDM-only and interchangeable links, and $(n_c, n_\lambda) = (4, 2)$ for SDM-WDM links. In this way, the number of optical links is the same and the switch has exactly the same dimensions. Thanks to SDM, the sustainable ρ improvement over WDM-only links is significant and close to the best case where channels are interchangeable, especially if λ converters are used. For instance, when $n_e = 0.2 \times n_{opt}$, the sustainable $\rho = 60\%$ for a switch with SDM-WDM links and 2 λ converters, compared to 40% for WDM-only links also with 2 λ converters, and 72% for interchangeable channels.

3.3.3.2 Simulation of connection via $n_c = 2$ SDM channels (like 2-mode WMMF)

We simulate the hybrid switch connected to $n_c = 2$ SDM channels, each one supporting n_λ wavelengths. This simulation may present a connection between the hybrid switch and its azimuths through n_a Weakly Multi-Mode Fibers (WMMF) with 2 modes per fiber. Figure 3.10 presents the sustainable ρ at $\text{PLR}_F \leq 10^{-4}$ as a function of the ratio (n_e/n_{opt}) for a degree-4 switch ($n_a = 4$) and $n_c = 2$ such as 2-mode fiber.

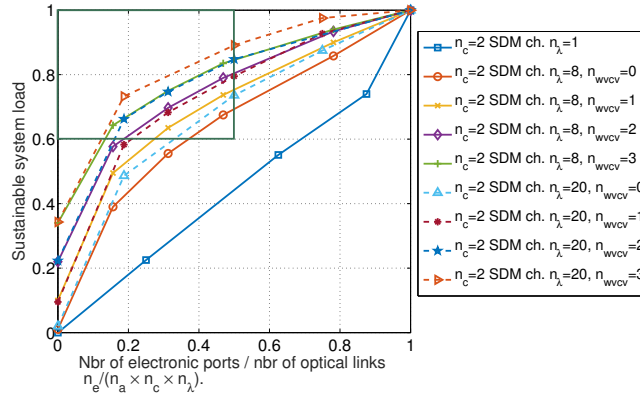

Figure 3.10: Sustainable ρ vs $n_e/(n_a \times n_c \times n_\lambda)$ at $PLR_F = 10^{-4}$, $n_a = 4$, SDM+WDM links, $n_c = 2$ (like 2-mode WMMF fibers)

The hybrid switch leads to an acceptable sustainable system load ($\geq 60\%$) with a number of buffer ports lower than half that of optical links, even when supporting 20 wavelengths. It increases the sustainable load significantly compared to an all-optical bufferless switch ($n_e = 0$). When $n_\lambda = 8$ for example, just $(0.35 \times n_{opt})$ ports are sufficient to have a sustainable $\rho = 60\%$ while it is null for optical switch. Adding some λ converters ameliorates the results. For $n_c = 2, n_\lambda = 20$ and $n_e = 0.5 \times n_{opt}$ ports, the sustainable ρ increases from 73% to 90% when we add 3 shared λ converters. We note that in our simulations, no R packets were lost with these switch dimensions. Thus the R class requirement is satisfied.

3.3.3.3 Simulation of connection via $n_c = 7$ SDM channels (like 7-core fibers)

We consolidate our investigation by simulating a switch connected to 7-SDM-channels, in line with currently-manufactured 7-core fibers [123], supporting numerous wavelengths on each core. Figure 3.11 and Figure 3.12 present respectively the evolution of the sustainable system load at the reference $PLR_D = 10^{-4}$ and $PLR_F = 10^{-4}$ as a function of the ratio (n_e/n_{opt}) for a degree-8 switch.

Connecting the switch to 7-core fibers increases the interchangeability degree and ameliorates thus the performance compared to WMMF or single-mode fibers. For 4- λ system, the sustainable load at $PLR_D = 10^{-4}$ reaches 85% for 7-core fibers, compared to 65% for 2-mode WMMF fibers and 48% for single mode fibers, when $n_e = 0.5 \times n_{opt}$. The sustainable load is significantly increased compared to an all-optical bufferless switch. For instance, with 20 wavelengths per core, just $(0.1 \times n_{opt})$ electronic ports to the buffer are sufficient to have a sustainable $\rho = 65\%$ at $PLR_F = 10^{-4}$ while it is equal to only 15% for an all-optical switch. Supplementing the hybrid switch with a few shared λ converters slightly increases the sustainable load. For example, when $n_\lambda = 4$ and $n_e = 0.1 \times n_{opt}$, the sustainable load increases by 2% with the use of one converter. The performance amelioration by using λ converters is less significant in the case of 7-core fibers than 2-mode WMMF fibers because more interchangeability is given thanks to the additional SDM channels.

To conclude, our simulations show that combining WDM with SDM interchangeable channels, as it could be for a connection through WMMF or 7-core fibers, markedly

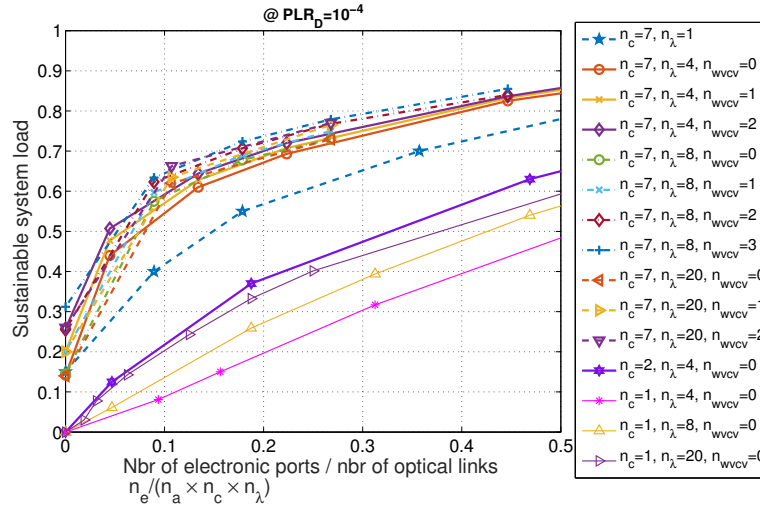

Figure 3.11: Sustainable ρ vs $n_e/(n_a \times n_c \times n_\lambda)$ at $PLR_D = 10^{-4}$, $n_a = 8$, $n_c = 1, 2$ or 7 (like 7-core fibers)

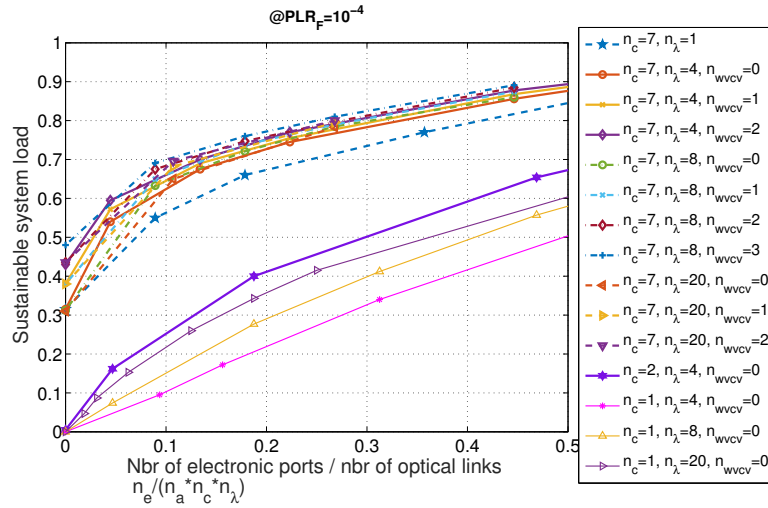

Figure 3.12: Sustainable ρ vs $n_e/(n_a \times n_c \times n_\lambda)$ at $PLR_F = 10^{-4}$, $n_a = 8$, $n_c = 1, 2$ or 7

improves switching performance in terms of sustainable load over WDM-only links.

3.3.4 Low switching latency

We considered the latency to be null for packets switched optically. The latency of a packet that has passed through the buffer before reaching its final egress consists of the time spent in the buffer and the time of re-emission.

For degree-4 or degree-8 switch with $n_c = 2$, delays don't exceed $15 \mu s$. For example, the switching delays for an SDM-WDM-channel hybrid switch where $n_a = 8$, $n_c = 2$, $n_\lambda = 4$ and $n_e = 30$, presented in Figure 3.13, are less than $7.5 \mu s$, higher than those of an interchangeable-channel switch but lower than the delays of an only-WDM-channel switch. Delays are lower when $n_c = 7$ SDM channels. Reminding that voice and interactive

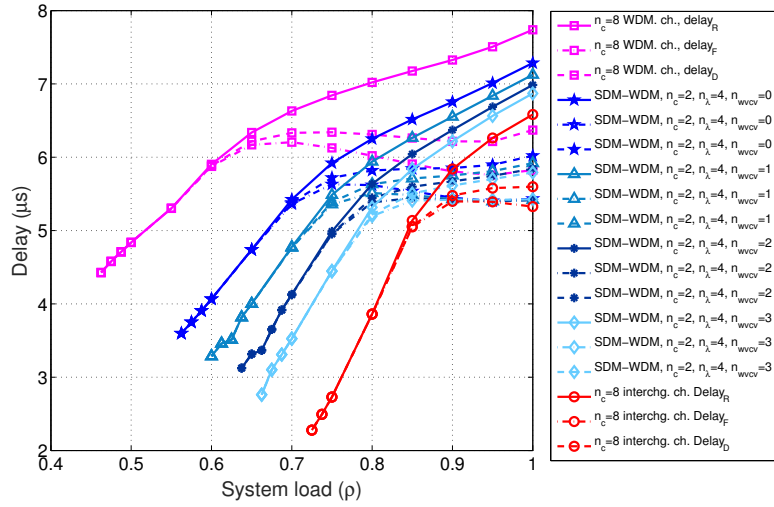

Figure 3.13: *Switching delay vs system load ρ , $n_a = 8$, $n_c = 2$ and $n_\lambda = 4$ for SDM-WDM channels, $n'_c = 8$ for interchangeable or only-WDM channels, and $n_e = 30$*

video (F packets) require 150 ms one-way end-to-end delay, the SDM-WDM-channel switch satisfies the delay condition with 4 orders of magnitude below acceptable limits even for F packets.

3.3.5 Energy savings compared to all-electrical switch

In order to compare our hybrid switch with an all-electrical one, we present in Figure 3.14 the reduction of the O-E-O conversions evolution as a function of ρ for a degree-4 hybrid switch, where $n_c = 2$, ($n_\lambda = 8$, $n_e = 10$ or 30) and ($n_\lambda = 20$, $n_e = 30$ or 80).

The reduction of O-E-O conversions is higher than 42% even with 20 wavelengths and 80 electronic ports. Thus, the reduction of energy consumption that could be achieved by the hybrid switch may be very important.

Having some shared λ converters further reduces the O-E-O conversions since it reduces the number of buffered packets. For example, when $n_\lambda = 20$ and $n_e = 30$, the hybrid switch does away with at least 80% of O-E-O conversions when $n_{wvcv} = 3$ compared to 72% with no λ converters. However, since λ conversions themselves consume power, we present in Figure 3.15 the evolution of their percentage as a function of ρ , to compare it with the O-E-O reduction.

When $n_\lambda = 20$, $n_e = 30$ and $n_{wvcv} = 3$, at a system load of $\rho = 0.75$, up to 35% of the switched packets are wavelength-converted. However, even for this example, 80% of the O-E-O conversions are done away with. Thus, considering that a λ conversion consumes power as an O-E-O conversion, the λ converters consumption is so low to negate the energy savings of the hybrid switch compared to electrical ones, it makes away with 80-35 = 45% of O-E-O conversions.

3.4 Supporting specific traffic profile

In a general traffic profile, R, F and D packets respectively make up 10, 40 and 50% of the global traffic in metro and core networks [135]. However, we considered other

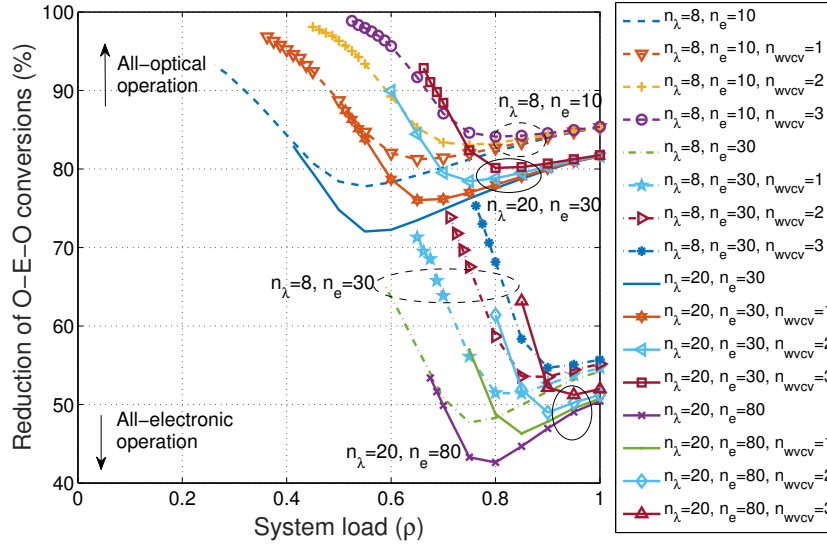

Figure 3.14: $O-E-O$ reduction vs $\rho, n_a = 4, n_c = 2$ SDM channels

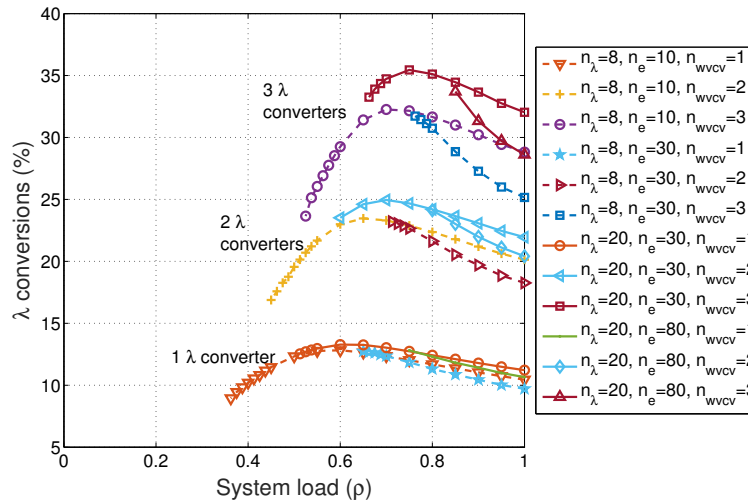

Figure 3.15: λ conversions rate vs $\rho, n_a = 4, n_c = 2$ SDM channels

partitioning schemes as well in order to investigate our switch performance in stressful configurations where the percentages of higher priority (R and F) packets are greater. This may occur in specific use cases, such as at the level of data centers where R packets are more common, or at the level of some on-line video games servers where F packets' percentage may be greater. We will present the results for two partitioning schemes where R, F and D packets make up respectively 10, 40 and 50% (referred as classification $C_{general}$) and 25, 45 and 30% (referred as classification $C_{specific}$). In the second case, the percentages of R and F packets are considerably high, but it is still a realistic case.

3.4.1 Comparison in terms of the sustainable system load

Figures 3.16, 3.17 and 3.18 present the evolution of the sustainable system load respectively at $PLR_D = 10^{-4}$, $PLR_F = 10^{-4}$ and null PLR_R as a function of the ratio n_e/n_{opt} for a degree-8 switch connected to 7-core fibers and supporting 4 wavelengths per core.

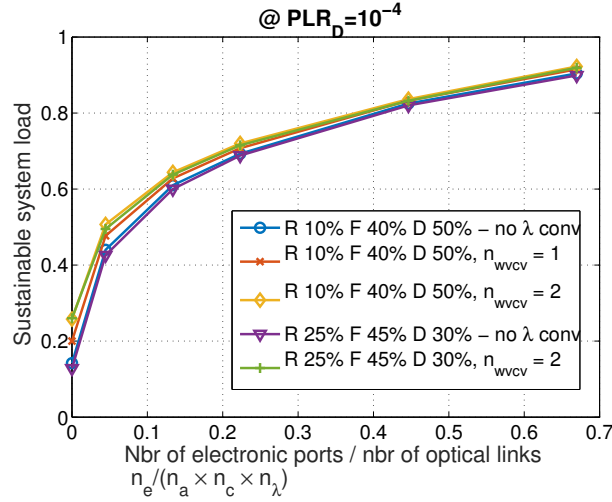

Figure 3.16: Sustainable ρ vs $n_e / (n_a \times n_c \times n_\lambda)$ at $PLR_D = 10^{-4}$, $n_a = 8$, $n_c = 7$, $n_\lambda = 4$, for $C_{general}$ and $C_{specific}$ packet classifications

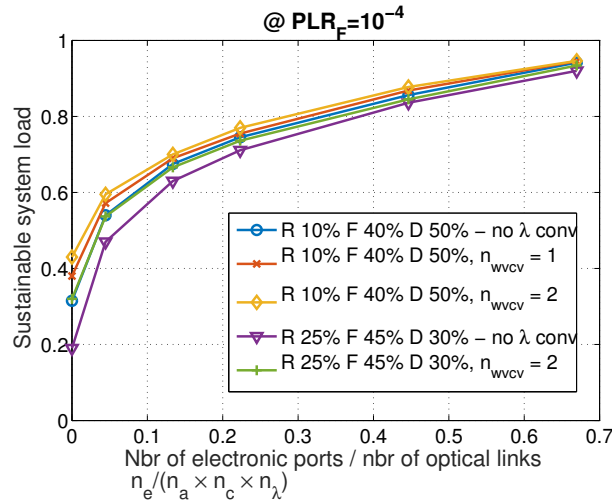

Figure 3.17: Sustainable ρ vs $n_e / (n_a \times n_c \times n_\lambda)$ at $PLR_F = 10^{-4}$, $n_a = 8$, $n_c = 7$, $n_\lambda = 4$, for $C_{general}$ and $C_{specific}$ packet classifications

The sustainable ρ at $PLR_D = 10^{-4}$ and at $PLR_F = 10^{-4}$ are slightly lower with the classification $C_{specific}$ than the classification $C_{general}$. However, it is still good and greater than 60% while $n_e \leq 0.5 \times n_{opt}$, even though the percentages of R and F packets are relatively high. For instance, with no λ converters and at $PLR_F = 10^{-4}$, the sustainable $\rho \geq 60\%$ when $n_e = 0.8 \times n_{opt}$ for the classification $C_{specific}$ compared to $n_e = 1.2 \times n_{opt}$ for the classification $C_{general}$.

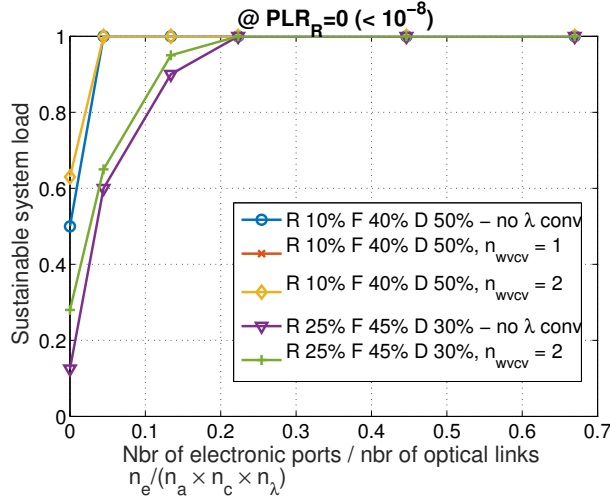

Figure 3.18: Sustainable ρ vs $n_e / (n_a \times n_c \times n_\lambda)$ at PLR_R null, $n_a = 8$, $n_c = 7$, $n_\lambda = 4$, for $C_{general}$ and $C_{specific}$ packet classifications

Considering R packets that are the most restrictive regarding the PLR, their constraint is satisfied when $n_e = 0.04 \times n_{opt}$ for the classification $C_{general}$ and $n_e = 0.2 \times n_{opt}$ for the classification $C_{specific}$ where the switch doesn't have any wavelength converter. In these cases, the sustainable load is full ($= 1$) at null PLR_R .

The hybrid switch should be sized in such a way that the ratio n_e / n_{opt} doesn't lead to any dropped R packet and permits to have sustainable load $\rho \geq 60\%$ at $PLR_D = 10^{-4}$ and $PLR_F = 10^{-4}$. Besides this ratio must be ≤ 0.5 in order to reduce significantly the O-E-O conversions compared to an all-electrical switch that has the same size.

Our simulations show the strong possibility of such sizing while responding to the requirements of all the different packet classes whether their percentages are common (classification $C_{general}$) or more constraining (classification $C_{specific}$).

3.4.2 Comparison in terms of the switching latency

Considering the switching latency, for all the simulated hybrid switch dimensions, delays are in the order of magnitude of some μs , which satisfies even the Fast packets constraint. For example, Figure 3.19 presents the evolution of the delays of R, F and D packets as a function of ρ for a hybrid switch sized as $n_a = 8$, $n_c = 7$, $n_\lambda = 4$, $n_e = 100$, $n_{wvcv} = 0$ or 2. All the delays are $\leq 6 \mu s$ for both classifications $C_{general}$ and $C_{specific}$.

3.5 Conclusion

The investigation of WDM-channel hybrid switch shows that the obtained PLRs and sustainable system load are, as expected, worse than those of interchangeable channels but mostly not acceptable. Increasing the number of buffer ports could solve packet contention but the buffer mustn't be oversized comparing to the switch dimensions.

Shared wavelength converters offer the possibility of channels interchangeability and ameliorate the switching performance. We assume that the λ converters are based on O-E-O conversions and may convert any λ_i to any available other λ_j . Although these con-

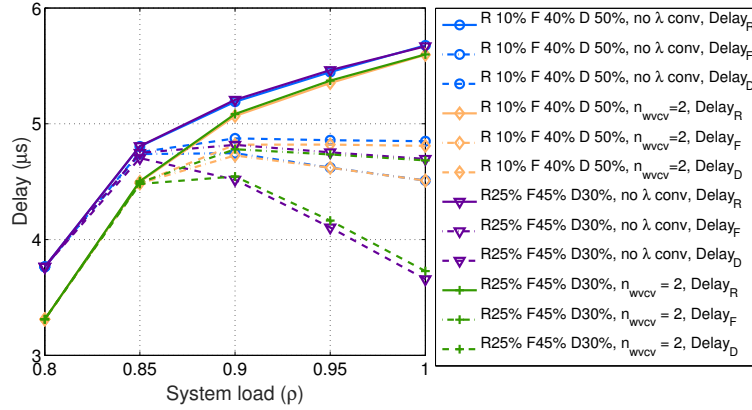

Figure 3.19: *Delays vs ρ , $n_a = 8$, $n_c = 7$, $n_\lambda = 4$, $n_e = 100$, for $C_{general}$ and $C_{specific}$ packet classifications*

verters are energetically costly, their power consumption doesn't negate the energy savings achieved by the hybrid switch compared to electrical ones. However, our simulations show that having additional electronic ports to the buffer is more beneficial than having more wavelength converters ports. Considering the latency criterion, switching delays are still acceptable in the case of WDM channels and satisfy current network requirements even for Fast packets.

Another key to solve packet contention for our hybrid switch used in WDM systems is to combine SDM with WDM at the level of the switch connectivity. In addition, SDM increases the transmission capacity. This could present connections through SDM multi-mode or multi-core fibers supporting WDM on each mode or core. Notable performance improvement in terms of sustainable load, switching latency and energy savings are achieved thanks to the offered interchangeability. For instance, for a degree-8 switch connected to its azimuths through 7 SDM channels, the sustainable system loads at PLR_D and $PLR_F = 10^{-4}$ are around 70% where each SDM channel supports 4 or more wavelengths and the electronic buffer has just $n_e = 0.2 \times n_{opt}$ ports.

Subject to the hybrid switch sizing and thanks to the switching strategy we established, the requirements of Reliable, Fast and Default packets are satisfied whether their percentages correspond to a general traffic profile in metro and core networks (respectively 10, 40 and 50%) or when higher priority packets present greater percentages. This is possible while reducing the O-E-O conversions significantly compared to off-the-shelf all-electrical switches.

Ideally, packets are switched through their initial wavelengths. λ converters are assumed to be used as a last resort. However, in case of use, a packet's new wavelength should be chosen in such a way that its impact on the transmission quality of other packets is minimized. In fact, in a multi-span Erbium Doped Fiber Amplifier (EDFA) network, adding or dropping a wavelength may affect the existing wavelengths by the effect of EDFAs power excursions. Since the quality of service may be associated with the quality of transmission, we will focus in chapter 4 on a machine learning approach that determines accurate recommendations for wavelength add/drop with minimal excursions in a WDM multi-span EDFA network.

Chapter 4

Minimizing EDFA power excursions through a machine learning approach

4.1 Introduction

Chapter 3 shows that supplementing our WDM-channel hybrid switch with shared wavelength converters makes better performance in terms of PLRs and sustainable system load. We assumed that the λ converters can convert packets from any wavelength λ_i to any other wavelength λ_j , and choose the new wavelength λ_j arbitrary from the available wavelengths on the azimuth to the packet destination. However, in practice, due to the effect of EDFA power excursions, an added/dropped wavelength to/from a WDM system may affect the quality of transmission through other wavelengths present in the system in question. Thus a packet's new converted wavelength λ_j should be chosen carefully among the available wavelengths in order to minimize the impact of EDFA power excursions, especially that our hybrid switch manages different classes of service: Reliable, Fast and Default packets. In fact, the quality of service may be associated with the quality of transmission; for instance, channels (wavelengths) with higher power or better immunity to transmission quality degradation should be attributed to Reliable packets.

In section 4.2, we describe briefly the state of the art related to EDFAs. In section 4.3, we explain the effect of EDFA channel-dependent power excursions and present a summary of methods used to minimize this effect as well as their limitations. Instead, we propose a Machine Learning (ML) approach. In section 4.4 we present our laboratory experiment that collects data of the powers and OSNRs of WDM channels when a channel is added or dropped. The data collected is used to train and test our Machine Learning (ML) approach. The latter, presented in section 4.5, predicts the impact of adding/dropping a channel to/for a WDM system based on multi-span EDFAs. The obtained accurate results give the best recommendation for which wavelength to add/drop while minimizing the power excursions.

The proposed ML approach may be used in particular to determine to which λ the hybrid switch should convert a packet taking into account its class of service and the effect of EDFAs power excursions, but it is a general ML approach that could be applicable to different network designs based on multi-span EDFAs and can determine accurate

recommendations for channel add/drop with minimal power excursions.

4.2 An overview of EDFAs

The invention of optical amplifier in the early 1980s was a major step forward in the evolution of optical networks [50] as it can increase a WDM or DWDM signal power optically without any O-E-O conversion. The Erbium-Doped Fibre Amplifier (EDFA) is the most deployed optical amplifier as its amplification window coincides with the Conventional C-band (1525–1565 nm) and the Long L-band (1570–1610 nm). However, it is common to use two sorts of EDFAs, each optimized for one of the bands: C or L. In our current age of technology, EDFA is an important constituent of signal repeaters in long-distance optical networks. EDFAs extend the reach of optical communication beyond the confines of cities and continents. Their amplification is generally in the range of 20 to 40 dB.

The principle of EDFA functioning is that a relatively high-powered beam of light, called the excitation light and having a wavelength of 980 or 1480 nm, is mixed with the input signal, having a different wavelength from the excitation light. Both are mixed using a Wavelength Selective Coupler (WSC). The mixed light is guided into a section of fiber with Erbium ions included in the core. Erbium can absorb light at one frequency and emit light at another frequency. The Erbium ions will be excited by the high-powered beam and give up its energy as additional photons which are exactly in the same phase and direction as the input signal [149]. Thus, the output signal will be like the input signal but with an increased power. Figure 4.1 presents the functioning of an EDFA with one pumping laser.

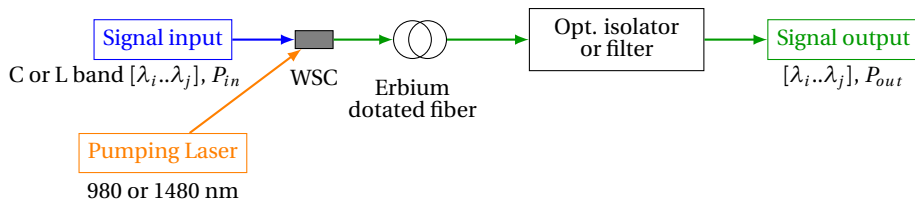

Figure 4.1: *One-pumping-laser EDFA principle, schematic figure*

There are other types of optical amplifiers: Semiconductor Optical Amplifier (SOA) and Raman amplifiers [150, 151]. An SOA amplifier uses a semiconductor to provide the gain medium. It is pumped electrically, via a directly applied current, and doesn't need a separate pump laser as an EDFA (or Raman) amplifier. Compared to an EDFA, an SOA has smaller size. It is also cheaper and can be integrated with other semiconductor devices such as semiconductor lasers and modulators [152]. However, SOA has higher noise, lower gain, moderate polarization dependence and high nonlinearity with fast transient time.

Unlike the EDFA and SOA, Raman amplification is based on the non-linear effect Raman scattering which is caused by the interaction between the input signal and a pump laser within an optical fiber. Raman amplifiers are mainly used to amplify the optical signal band 1300–1600 nm [153]. They allow a distributed amplification over length of several tens of km which is significantly larger than the distribution length of EDFA amplifiers. Raman amplifiers allow thus smaller magnitude excursion of the signal level,

lower crosstalk and lower noise than EDFA amplifiers [154]. However, they require higher pump signal than EDFA amplifiers [153].

Since EDFA are the most widely used amplifiers, we oriented our investigation towards WDM multi-span EDFA systems.

4.3 EDFA power excursions

EDFA uses Automatic Gain Control (AGC) algorithm to maintain the output power levels within a tolerant regime [155]. AGC algorithms maintain constant gain by monitoring the *total* input and output optical powers, but the gain on each wavelength is not maintained constant. Thus, a change in the configuration of an EDFA-based network, such as adding or dropping a channel, will affect the gain of other channels even though each one of those channels has constant input power. This phenomenon is called "power excursions".

Figure 4.2 illustrates the power excursions effect for an EDFA-amplified WDM signal. It presents an AGC EDFA output spectrum. Initially there are two channels carried on λ_1 and λ_2 . The gain spectrum (dB) is presented by the solid curve. Its mean across all channels is presented by the dashed curve. The two channels have the same input power. They have also the same output power since the gains corresponding to their wavelengths are equal. If a new channel having the same input power but with high gain is added on λ_H , AGC responds to an increase in mean gain by reducing the gain on the initial channels λ_1 and λ_2 . This leads to the high-gain channel effectively stealing power from lower-gain channels. Conversely, adding a low-gain channel λ_L feeds power to higher-gain channels. In both cases, the power excursion increases the disparity among channel powers.

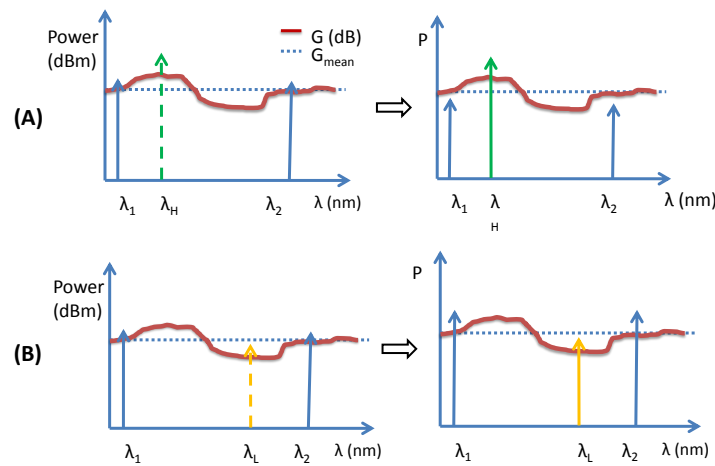

Figure 4.2: Schematic figure: AGC amplifier output spectrum, adding a channel with (A) high or (B) low gain

Power excursions change the Optical Signal-to-Noise Ratios (OSNRs) of the system channels which might become very different from the required OSNRs. Also, power excursions may cause cross-talk between channels with different power levels in addition to non linear transmission effects. Therefore, the wavelength-dependent power excursions

is an undesirable effect and must be avoided. It is a difficult and still unsolved challenge especially in multi-span EDFA networks where the total gain shape of the cascaded EDFAs as a function of the wavelength is unknown. This challenge must be met for future networks, intended to be dynamic and fast auto-reconfigurable.

General analytical modeling and resolution are not possible because the power excursions depend on many parameters such as the type of the amplifiers, the gain-control mechanisms, the number of EDFA spans, the transmission lines, the channels wavelengths and power ranges... Therefore, previous proposed solutions are based on characterizing a specific EDFA system and reducing its power excursions. This could be possible by:

- optimizing input power levels [156]: lower input powers for higher-gain wavelengths and higher input powers for lower-gain wavelengths.
- balancing input channels [157]: distributing the optical power of a single signal over multiple wavelengths such that the individual gain excursions cancel one another. If it is not possible to have a balanced set of wavelengths that cause equal and opposite excursions, input powers are adjusted by varying the dwell time on some wavelengths.
- adjusting the pumping level of the amplifier [158]: acting on the EDFA gain profile.
- applying preventative algorithms to optimize the wavelength assignment [159], but at the expense of spectral efficiency.
- case-based reasoning (CBR) [160]: making heuristic guesses on EDFA tuning based on the records of a data base. CBR is limited in its prediction capability for unknown network scenarios, so a large number of past records is needed to be effective.
- applying gain flattening filters (GFF) which restore all wavelengths to approximately the same intensity [161, 162]. However, these filters introduce noise and impact the amplification gain [161]. In addition, this solution fits more circuit switching (than packet switching) where the wavelength configuration is more stable in time.

These solutions are related to the specific analyzed systems and are not necessarily applicable to other systems. In addition, they assume that the gain profile is deterministic which is not true for live-network equipment, where the gain profile could change over time.

Therefore, we propose a ML approach based on collecting data of the system response, notably power excursions, due to changes in the system input such as adding or dropping some channels. The ML engine trained with that data will be able to prevent the system response to other changes and give the best recommendation of which wavelength to add/drop with minimal power excursions. The proposed approach is shown to be efficient and with a low-overhead ML engine. It could be used for different multi-span EDFA network designs.

4.4 Laboratory experiment: collecting data of power excursions

We built two different multi-span EDFA networks. One with 2 spans and the other with 3 spans. Both are presented in Figure 4.3 where the components in dashed box are included for the 3-EDFA link. The network has 24 sources transmitting 24 DWDM channels from ITUT grid Ch. 21 to Ch. 44 with 100 GHz spacing [163]. These channels are multiplexed via a wavelength-selective switch (WSS). At any given time, we maintain 10 to 20 of these channels ON in order to have an adequate number of available channels

for add or drop, which corresponds to a rate of 42% to 83% of used (ON) channels. The signals are transmitted on 2 or 3 spans, each span is composed by an SMF fiber, a variable optical attenuator (VOA) and an EDFA. The maximum length of the SMF fibers used is 20 meters. The variable attenuators are added on the transmission chain to emulate the transmission, and so the power decrease, in long distance fibers. We adjusted the VOA and the EDFA pumping to achieve a realistic gain ripple with a maximum disparity of 6 dB between the highest and lowest gains for the total multi-span network [164, 165]. For this purpose, the values of the attenuations or amplifications are experimentally adjusted as the following:

- for the 2-span EDFA network:
 - span 1: attenuation of 20 dB and EDFA pumping current of 180 mA. The EDFA model is Amonics C-25B-B.
 - span 2: attenuation of 10 dB and 2-laser EDFA pumping currents of 280 mA and 277 mA. The EDFA model is Amonics C-PA-35.
 - attenuation of 15 dB.
- for the 3-span EDFA network:
 - span 1: attenuation of 20 dB and EDFA (Amonics C-25B-B) pumping current of 180 mA.
 - span 2: attenuation of 10 dB and 2-laser EDFA (Amonics C-PA-35) pumping currents of 280 mA and 277 mA.
 - span 3: attenuation of 10 dB and EDFA pumping current of 10 dB. The EDFA model is Oclaro PureGain 2800.
 - attenuation of 10 dB.

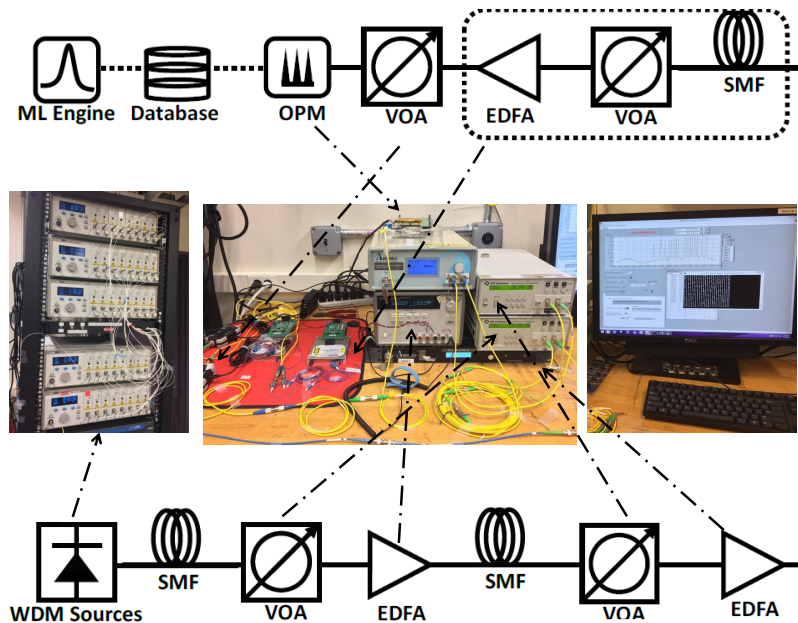

Figure 4.3: Setup of the lab experiment, WDM multi-span EDFA network

The WDM signal is received by an Optical Performance Monitor (OPM) [166]. The OPM is a component that serves as an optical spectrum analyzer, measures the channel powers and OSNRs at a given time or continuously and saves the data on a computer file. The OPM has an optical input port connected to the end of our transmission chain and a

5-pin UART connector connected for one side to the power supply and for the second side to a computer via an UART cable with an USB end. A screen capture of the OPM software is presented in Figure 4.4.

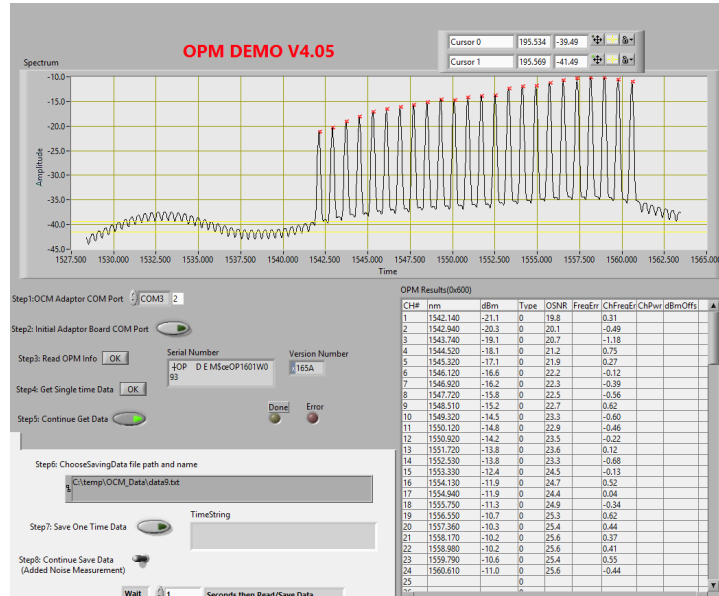

Figure 4.4: Screen capture of the OPM software, 24 wavelengths are ON

We developed a script that randomly generates a set of 24 "zeros" and "ones" which represent respectively the "ON" and "OFF" states of the 24 channels. The number of "ones" in a given set is between 10 and 20 as explained previously. Following the result of the script execution, we turn ON or OFF the corresponding channels. For the two described networks, we took measurements for 100 random states generated by the script. In addition, we generate 10 other random states and for each state, we add a new channel on one among of the available wavelengths, we save the power measurements and we try another available wavelength... We took also similar measurements for 5 other random states but with dropping a channel per iteration. For the 2-span EDFA network, we took more measurements after 3 days and after one week. In fact, as in real networks situation, slight variations may occur to components' adjustment and channels powers. We aimed to test our ML engine trained with the initial measurements and check its accuracy of prediction.

4.5 Machine learning approach: minimizing power excursions

4.5.1 Statistical modelling

In order to model statistically the channel-dependent EDFA power excursions, we define a regression problem. The problem input is an array of 24 bits presenting the states of the 24 channels of our experimental setup. Bits "1" correspond to the ON channels and bits "0" correspond to the OFF channels. For other network designs, the problem input could be scaled up to 40-bit or 80-bit to cover the full DWDM C-band. The problem output is the power Standard Deviation (STD) of the ON channels measured at the reception level (by the OPM) after a change on the multi-span EDFA system. The regression model

is trained with a part of the collected data and tested on the second part. We considered as accuracy criteria:

- the Mean Square Error (*MSE*) between the predicted and the real STD.
- the correctness of recommendation of the best channel provisioning identified based on the predictions, such as the prediction of the channel with minimal STD.

In order to simplify the calculation and reduce its time, a preprocessing of the input and output values is done: we remove the DC bias from each dimensions of the input and the output; in addition, the input dimensions are standardized with an STD of unity. The preprocessing of the input and output values is presented by Eq. 4.1 and Eq. 4.2 respectively.

$$x_{ij}^{proc} = \frac{x_{ij} - \bar{x}_j}{\sigma_j}; \quad 1 \leq i \leq n; \quad 1 \leq j \leq d_{in} \quad (4.1)$$

$$y_{ij}^{proc} = y_{ij} - \bar{y}_j; \quad 1 \leq i \leq n; \quad 1 \leq j \leq d_{out} \quad (4.2)$$

where x_{ij}^{proc} and y_{ij}^{proc} are the preprocessed values for the input x_{ij} and the output y_{ij} respectively; $1 \leq i \leq n$ for n total data points measured for ML training and testing; d_{in} is the input dimension, in our case $d_{in} = 24$ ON/OFF states of 24 channels; d_{out} is the output dimension, in our case $d_{out} = 1$ which is the power STD of the ON channels; σ_j is the per-dimension STD of the input x_{ij} ; and \bar{x}_j and \bar{y}_j are the respective per-dimension means.

Since two network states with similar ON/OFF channels are assumed to occur the same result of power excursions [160], we built a Kernelized Bayesian Regression (KBR) model. The input kernel can efficiently replace the need for a database. Given a new network state having as input x' , we can infer its predicted power STD from how similar it is to a known network state having as input x . Specifically, we construct a kernel called the Radial Basis Function (RBF) expressed by Eq. 4.3. The value of the kernel function decreases exponentially with the L2 distance between the two inputs x and x' .

$$K(x', x) = a \cdot \exp \left\{ -\frac{1}{b} \|x' - x\|^2 \right\} \quad (4.3)$$

where a and b are arbitrary factors to adjust the strength of the kernel. In our case, we set a and b respectively to the values 10^{-4} and 3.5 . It is an arbitrary decision, we did cross-validation tests to try a range of numbers and these a and b values show the least MSE. The predictions are obtained from the linear combinations of the training outputs weighted by the kernel function values.

4.5.2 Results in terms of STD prediction MSE

We present in Figure 4.5 the STD prediction MSE as a function of the number of training samples for two models: KBR and Linear Regression (LR), and for the two experimental setups: 2-span and 3-span EDFA systems. In all cases, the MSE decreases and the models' predictions improve with increasing size of the training data set. However, the improvement is no longer significant after 400 training data points. This shows that the training data does not need to grow much beyond a certain size (in our case 400 measurements) to leverage the ML engine. We note that for larger systems with more EDFA spans and/or more channels, the size of the training set (amount of training data points) should be higher. As best cases shown in Figure 4.5, STD prediction MSE obtained

in our experiment are 7.6×10^{-3} for the 2-span EDFA network with 459 training data, and 1.9×10^{-2} for the 3-span EDFA network with 468 training measurements.

Moreover, the constructed kernel makes the predictions more accurate. For instance, the KBR model applied on the 3-span EDFA network and trained with 400 points leads to an MSE of 2×10^{-2} , compared with 4×10^{-2} for the LR model having the same training set size. Thus, compared to the LR model, the KBR model reduces the MSE to the half for this example.

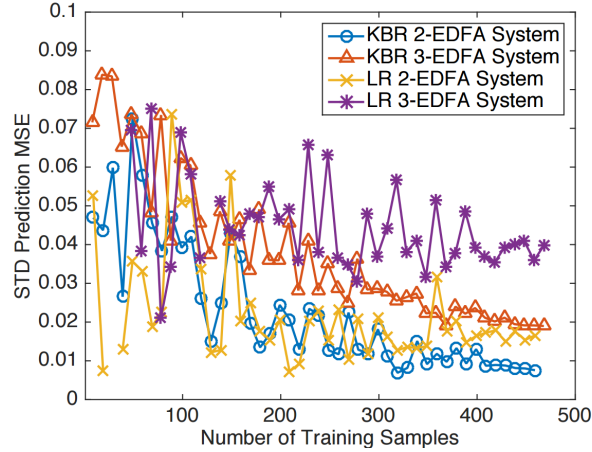

Figure 4.5: STD prediction MSE for LR and KBR models, 2-span and 3-span EDFA networks

4.5.3 Results in terms of recommendation's correctness

As a second accuracy criteria, we check if our KBR model's predictions of best channel to add or drop with minimal power excursions are correct. We considered the two setups, with 2 or 3 EDFA spans. For a randomly given state of the setup, we want to know on which wavelength among the OFF channels we can add a new channel with minimal power excursions. Similarly, we want to know which ON channel we can turn OFF with minimal impact on other ON channels of the system. The sizes of training and testing sets are presented in Table 4.1.

Table 4.1: Training and testing sets sizes

	2-span network		3-span network	
	Add a channel	Drop a channel	Add a channel	Drop a channel
Training set size	400	521	501	545
Testing set size	8	14	9	15

Figures 4.6 and 4.7 present the power STD for different possibilities of an added or dropped channel, for the 2-span and the 3-span network respectively. The "o"-marked curves present our ML model predictions, while the "+"-marked curves present the measured values of the power STD. For adding a channel, the model predicts the power STD after a hypothetical channel is added to one of the available slots (i.e. the OFF channels). Then the model recommends the best slots to add a channel that will result in the lowest power STD and therefore the least undesired power excursions. In Figures 4.6

and 4.7, we circle the three best recommended slots. In fact, recommending multiple slots provides educated guesses with flexibility for network operators. We redo the same test for a channel dropping.

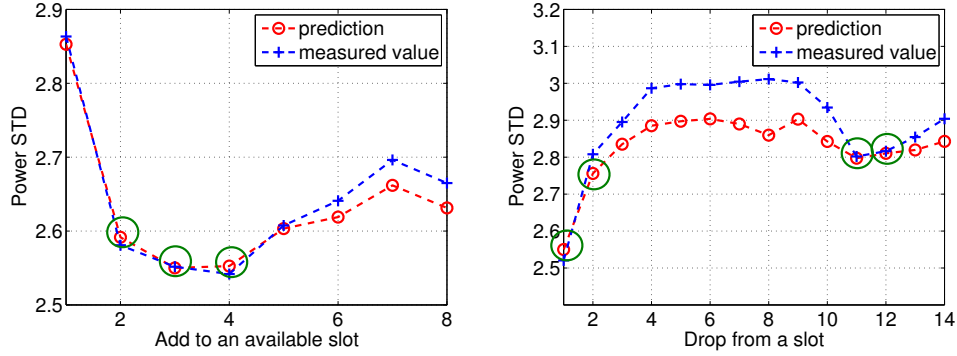

Figure 4.6: Comparison between predictions and measurements for single channel add (left) or drop (right) in 2-span EDFA network

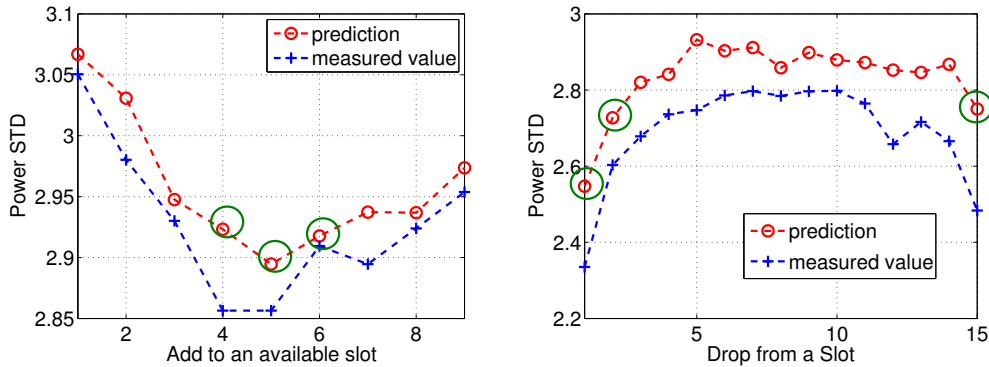

Figure 4.7: Comparison between predictions and measurements for single channel add (left) or drop (right) in 3-span EDFA network

Figures 4.6 and 4.7 show that the predictions of the channel provisioning with minimal power excursions are correct, the recommended slots are aligned with the best slots from the actual measurements. The add-channel predictions seem to be more accurate than the drop-channel predictions because we took more training measurements where adding a channel than dropping one.

Moreover, since the recommendations are based on the relative STD ranking, they are robust under insignificant deviations of the exact STD values predicted. We remind that, for the 2-span EDFA network, we took the measurements on 3 different days – the initial measurements, after 3 days and after one week – because we aimed to simulate a real network situation where slight changes on the signals powers may occur (few 0.1 dB). Our ML model is trained with the data collected on the two first sets and tested with the data collected on the last day. We verified that our model's predictions are accurate and tolerant to system variations over that time (one week).

4.6 Conclusion

We established a Machine Learning approach based on a Kernelized Bayesian Regression (KBR) model in order to predict on which wavelength we can add a channel to a WDM multi-span EDFA system with minimal power excursions. Our model is also applicable for dropping a channel from a multi-span EDFA system.

This model could be used for our hybrid switch when it is integrated on a WDM system. The model will recommend to which wavelength the switch should send a packet according to its class of service and the system configuration at the packet's arrival time. But our proposed model is generic and also applicable to different designs of WDM multi-span EDFA networks.

Our experimental work shows that the proposed KBR model facilitates channel provisioning to reduce undesired power excursions. It leads to accurate recommendations even if the training data is collected one week before the test.

General conclusions and perspectives

We have been interested by hybrid opto-electronic packet switch that could be a compromise between off-the-shelf all-electrical switches (energetically costly due to the required O-E-O conversions), and all-optical switches (vulnerable to packet contention due to the lack of mature optical buffers). Our hybrid switch consists of an optical switching matrix supplemented with a shared electronic buffer.

Taking into account different classes of service, Reliable, Fast and Default packets, we established a switching strategy that permits to meet the requirements of each class in terms of PLR, sustainable system load and switching latency. We simulated the switch connected to its azimuths via interchangeable SDM channels. Our results show that the hybrid switch satisfies the performance requirements of all the different packet classes: no Reliable packets are dropped, switching delays are around $10\ \mu\text{s}$ with 4 orders of magnitude below acceptable limits even for Fast packets, and the sustainable system load at $\text{PLR}_D = 10^{-4}$ and $\text{PLR}_F = 10^{-4}$ exceeds 60% where the number of electronic ports to the buffer are less than half the number of optical ports. The required buffer capacity is limited. Moreover, the hybrid switch significantly reduces the O-E-O conversions compared to commercial off-the-shelf electrical switches. For example, a switch with 8 azimuths, 8 SDM channels per azimuth and 30 electrical ports to the buffer, does away with at least 55% of the O-E-O conversions compared to an all-electrical switch. The hybrid switch could thus be a promising solution to reduce the energy consumption, especially if the buffer ports are capable of sleep mode while not used.

We extended our investigation by simulating our switch connected to WDM channels. As expected, compared to the case of interchangeable channels, switching performance decrease because of the wavelength constraint. It is not possible to have an acceptable sustainable system load ($\geq 60\%$) without an over-sized buffer. Switching delays considerably increase compared to those obtained for SDM channels but still with 4 orders of magnitude below acceptable limits. Yet, supplementing the hybrid switch with shared wavelength converters achieves notable performance improvements. Our analysis of the energy savings shows that the reduction of O-E-O conversions achieved by the hybrid switch compared to electrical switches is still impressive, even with the use of wavelength converters based on O-E-O conversions. For instance, at a system load $\rho = 0.5$, for a switch with 8 azimuths, 8 WDM channels per azimuth, 30 ports to the electronic buffer and 3 shared (8×8)-wavelength converters, up to 37% of the switched packets are λ -converted, which is a considerable rate. However, even for this “poor” example, 50% of the O-E-O conversions are done away with compared to an electrical switch. Thus the

energy consumption of wavelength converters is far from negating the energy savings achieved by the hybrid switch.

Another alternative to improve the performance of our hybrid switch when used in WDM systems is to combine SDM and WDM at the level of the connected optical ports: connecting the switch to SDM (multimode or multicore) fibers supporting WDM on each mode or core. SDM increases the transmission capacity, offers channels interchangeability and thus improves the performance compared to WDM-only channels. We simulated the switch connected to 2 SDM channels, like a WMMF fiber, and to 7 SDM channels, like a 7-core fiber, supporting various wavelengths on each SDM channel. High sustainable system load is achieved; for example a switch connected to 8 azimuths through 7 SDM channels per azimuth and supporting 20 wavelengths per SDM channel permits to have a sustainable system load of 70% while the number of electrical ports to the buffer is equal to $0.2 \times$ the number of optical links. The SDM-WDM-link hybrid switch leads to low switching delays (around 10 μ s) and to a significant reduction of O-E-O conversions (more than 30% compared to electrical switches). Optionally, wavelength converters may be used for better performance improvement.

Associating the quality of service with the quality of transmission, we built a Machine Learning (ML) approach that could give the best recommendation of which wavelength a packet should be converted to and switched with minimal power excursions on other packets present in our switch system. Those predictions and recommendations lead to achieve best switching performance considering the different classes of service. The application of our ML approach is not reduced to the case of our hybrid switch but it is applicable to different architectures of WDM multi-span EDFA networks. Laboratory experimental work was done to train and test our ML approach. The prediction MSE of the power standard deviation is lower than 10^{-2} when we train our model with just 400 measurements. The recommendation of the best channel to add/drop with minimal power excursions are accurate, even when we trained the system with data collected a week before the tested scenario.

A perspective of this work is to propose an **analytical model** for an easier dimensioning of the hybrid switch. In a previous investigation of the hybrid switch connected to interchangeable channels [22], the authors propose an Engset-type analytical model. This model suits perfectly the simulation results where the buffer is not used, which would present an all-optical packet switch, but not in the case of using the shared buffer. In fact, for reasons of simplification and modelling ease, the secondary traffic produced by the packet reemission from the buffer was assumed to be independent from the primary traffic generated by the azimuths. This assumption is not correct and could be the reason of the non accurateness of the model. Thus, a revision and amelioration of the model is required.

Another analytical model of an opto-electronic switch was proposed by [129]. Their packet switch is connected to WDM channels but it is supplemented by a wavelength converter for each optical channel. In this case, the hybrid switch seems to be without interest compared to electrical switches since the number of O-E-O conversions is not reduced. Anyway, the performance should be equivalent to the case of interchangeable channels. The proposed analytical model leads to accurate results, consistent with the simulation results but it is based on a recursive computing method which is not efficient in terms of time and even longer than simulations for some switch dimensions.

A new analytical model should be proposed for an easier dimensioning of the hybrid switch, it should be accurate, efficient with respect to the computing time, and also taking into consideration the different classes of service, the packet distribution (percentage of each class of service), the connectivity possibilities (interchangeable, WDM or WDM and SDM channels)...

In our investigation, we quantified the reduction of O-E-O conversions achieved by the hybrid switch compared to off-the-shelf electrical switch. We also investigated the performance in terms of the sustainable system load as a function of the ratio (n_e/n_{opt}) which presents the reduction of the number of electrical ports compared to electrical switches. These two points could reflect the **energy savings** of the hybrid switch, especially if the electrical ports can be turned on a sleep mode when not used. However, it is interesting to have a more accurate quantitative investigation of the energy savings. It should take into account the fabrication technology of the optical matrix, the technology used for the control module and the energy consumption of each component.

Another perspective is to investigate the switch performance for **asymmetric traffic**. The asymmetry could occur in different ways; for example a part x of the azimuths sends packets having destinations only among that part x , and other azimuths y can send packets to all the azimuths (x and y). Another example could be having different loads on the packet sources. The asymmetry will degrade the performance because it creates an instability of the system. Our primary simulations confirm this result, but the requirement of the different packet classes are still satisfied in terms of PLR and latency. However, it is worth to make this investigation and check if our hybrid switch is still of interest especially that this kind of asymmetric traffic is the most common mode in telecommunication networks [167, 168].

Appendix A

List of publications

The work presented in this manuscript has led to the following publications:

Journals

- Y. Huang, C. L. Gutterman, P. Samadi, P. B. Cho¹, **W. Samoud**, C. Ware, M. Lourdiane, G. Zussman, and K. Bergman, “Dynamic mitigation of EDFA power excursions with machine learning,” *OSA Optics Express*, vol. 25, no. 3, pp. 2245–2258, Feb. 2017.
- **W. Samoud**, C. Ware, and M. Lourdiane, “Performance Analysis of a Hybrid Optical Electronic Packet Switch Supporting Different Service Classes,” *IEEE/OSA Journal of Optical Communications and Networks (JOCN)*, vol. 7, no. 9, pp. 952–959, Sep 2015.

International Conferences

- Y. Huang, **W. Samoud**, C. Gutterman, C. Ware, M. Lourdiane, G. Zussman, P. Samadi, and K. Bergman, “A Machine Learning Approach for Dynamic Optical Channel Add/Drop Strategies that Minimize EDFA Power Excursions,” in *European Conf. on Opt. Comm (ECOC)*, no. Tu.2.B.3, Düsseldorf, Germany: IEEE, Sep. 2016.
- **W. Samoud**, C. Ware, and M. Lourdiane, “Investigation of hybrid opto-electronic packet switch connected to SDM fibers considering various traffic distributions,” in *Int. Conf. on Transparent Optical Networks (ICTON)*, no. Tu.D3.6, Trento, Italy: IEEE, Jul. 2016.
- C. Ware, **W. Samoud**, P. Gravey, and M. Lourdiane, “Recent advances in optical and hybrid packet switching,” in *Int. Conf. on Transparent Optical Networks (ICTON)*, no. Tu.D3.4, Trento, Italy: IEEE, Jul. 2016, invited paper.
- **W. Samoud**, M. Lourdiane, and C. Ware, “Performance Improvements of Hybrid Opto-Electronic Packet Switch Using SDM in Addition to WDM,” in *European Conf. on Opt. Comm (ECOC)*, no. 0489, Valencia, Spain: IEEE, Sep. 2015, poster.
- **W. Samoud**, C. Ware, and M. Lourdiane, “Performance Analysis of a Hybrid Opto-Electronic Packet Switch using WDM Technology,” in *Photonics in Switching (PS)*. Firenze, Italy: IEEE, Sep. 2015, pp. 348–350.
- **W. Samoud**, M. Lourdiane, and C. Ware, “Comparison between Interchangeable and WDM Channels for Hybrid OptoElectronic Switch,” in *Photonics North*, Ottawa, Canada, Jun. 2015.

- C. Ware, M. Lourdiane, and **W. Samoud**, “Can software-defined networks turn impractical optical functionalities into network-savers?” in *Int. Conf. on Transp. Opt. Networks (ICTON)*, no. We.C1.3, Graz, Austria: IEEE, Jul. 2014, invited paper.
- **W. Samoud**, C. Ware, and M. Lourdiane, “Investigation of a hybrid optical-electronic switch supporting different service classes,” in *Photonics North*, no. 9288-38, Montreal, Canada, May 2014.

National French Conference

- **W. Samoud**, M. Lourdiane, and C. Ware, “Etude d’un commutateur hybride optoélectronique gérant différentes classes de service,” in *Journées nationales d’optique guidée (JNOG)*, Nice, France, Oct. 2014, poster.

Students Conferences and workshops

- **W. Samoud**, M. Lourdiane, and C. Ware, “Hybrid Opto-Electronic Packet Switch: A Promising Solution to Reduce the Energy Consumption,” in *International OSA Network of Students (IONS)*. Naples, Italy: OSA, Jul. 2016.
- **W. Samoud**, M. Lourdiane, and C. Ware, “Hybrid Opto-Electronic Packet Switch Connected to Interchangeable Channels,” in *International OSA Network of Students/ Federation of Optics College and University Students (IONS/FOCUS)*. Tunis, Tunisia: OSA/SPIE, Sep. 2015.

Seminar

- W. Samoud “Hybrid Opto-Electronic Packet Switch: A Promising Solution to Reduce the Energy Consumption,” in *IEEE Photonics Society, McGill University*. Montreal, Canada, Apr. 2016.

Appendix B

Buffer input ports access management

We want to determine the “best” buffer ports access management method and a matching preemption management method: FIFO, sharing or partitioning?

Obviously, partitioning does not use the electronic ports optimally since it is possible to have available ports while a packet must be dropped because these free ports are not allocated to its priority class.

We consider a degree-10 hybrid switch ($n_a = 10$), connected to interchangeable channels, where $n_c = 10, n_e = 30$. Taking into account only the PLR as performance criteria, the packets are classed as high (H), medium (M) and low (L) priority packets. In figure B.1, we plotted the PLRs of H, M and L classes as functions of the system load for four different cases.

Curves (a) correspond to the FIFO buffer ports management method. In this case, it is possible to preempt the last lower priority packets being transmitted to send the higher priority packets instead (Preempt Trans.). Curves (b) correspond to the sharing method, reserving respectively 1, 10 and 19 ports to H, M and L packets, with the same preemption method (Preempt Trans.).

We observe that PLR_L is lower with FIFO than with sharing. In fact L packets may use all the available ports with FIFO while they are restricted only to their allocated ports with the sharing. However, PLR_H and PLR_M increase a little with FIFO compared to sharing because H and M packets are in competition with L packets (which represent 50% of all the traffic) to access the buffer.

Nevertheless, on the one hand, the choice of the number of ports allocated to each priority class in the sharing method is quite tricky, and on the other hand the increase of PLR_H and PLR_M with FIFO compared to the sharing is limited and may be overcome by allowing higher priority packets to preempt the last lower priority packets on their way to the buffer (Preempt Buff.).

Thus, we present in curves (c) the PLRs as a function of the system load for the FIFO buffer ports access management, with the possibility of preempting the last lower-priority packet being sent to the same egress, or, if none are being sent, preempting the last lower-priority packet being buffered. We change the preemption order in case (d): a higher priority packet may preempt the last lower priority one on its way to the buffer if there is one, otherwise it may preempt the last one being transmitted to the same egress port.

Both curves (c) and (d) show that adding the possibility to preempt packets on their

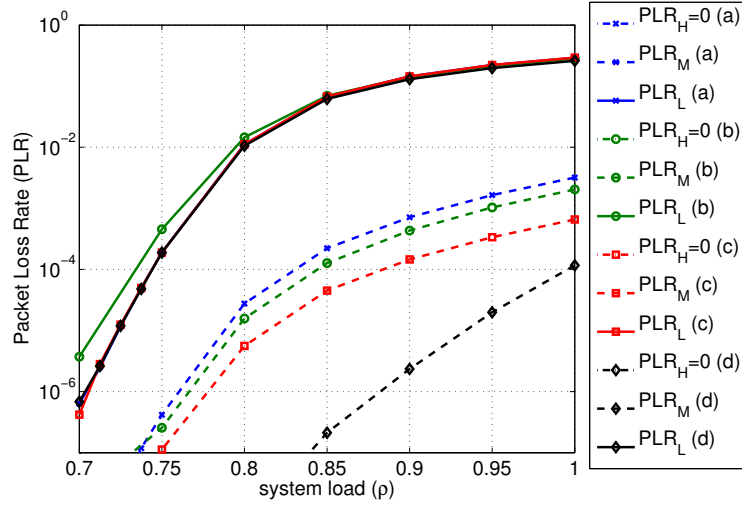

Figure B.1: Packet Loss Rates of H, M and L classes vs system load ($n_a = 10$, $n_c = 10$, $n_e = 30$) (a): FIFO and Preempt Trans. (b): Sharing and Preempt Trans. (c): FIFO and Preempt Trans. then Preempt Buff. (d): FIFO and Preempt Buff. then Preempt Trans.

way to the buffer decreases PLR_H and PLR_M without degrading PLR_L . In addition, resorting to preempting the last lower priority packets being buffered, if it is possible, before preempting those being sent to the same egress (curves (c)), reduces significantly PLR_H and PLR_M compared to an inverse order of preemption (curves (d)).

We conclude that lower PLR values are obtained when we opt for FIFO buffer ports access method coupled with the following preemption management: an H packet (respectively M packet), with neither a free channel to its destination nor a free electronic input port, steals one from the last L or M packet (respectively L packet) being buffered—if there is one—, or otherwise, the last one being transmitted to the same destination.

Appendix C

Distribution of the delays

In our simulations, we are considering the mean delay for each class of packets. However, we wanted to check whether all the delays of all the buffered then switched packets are in the same order of magnitude of some μ s. Indeed, a Fast packet should be considered as lost if its delay isn't lower than the acceptable limit of 150 ms one-way, end-to-end delay [134]. To make sure that we are on the right track regarding the interpretations of our switch performance, we count the number of packets having delays inside the following different intervals:

- Interval 1: $Delay \leq 8 \times 10^{-6} s$
- Interval 2: $8 \times 10^{-6} s < Delay \leq 10^{-5} s$
- Interval 3: $10^{-5} s < Delay \leq 2.5 \times 10^{-5} s$
- Interval 4: $2.5 \times 10^{-5} s < Delay \leq 5 \times 10^{-5} s$
- Interval 5: $5 \times 10^{-5} s < Delay \leq 7.5 \times 10^{-5} s$
- Interval 6: $7.5 \times 10^{-5} s < Delay \leq 10^{-4} s$
- Interval 7: $10^{-4} s < Delay \leq 2.5 \times 10^{-4} s$
- Interval 8: $Delay > 2.5 \times 10^{-4} s$

We present the distribution of the delays of R, F and D packets switched by a hybrid switch connected to $n_a = 8$ azimuths via $n_c = 8$ interchangeable channels per azimuth. The number of electrical ports is $n_e = 12$ (Figures C.1, C.2 and C.3) or $n_e = 20$ (Figures C.4, C.5 and C.6). The access technique for the buffer input and output ports is FIFO.

Considering the most restrictive packets to the latency, no F packets have delays higher than $10^{-4} s$ (or $2 \times 10^{-4} s$) where $n_e = 12$ (respectively $n_e = 20$). The quasi-totality of the buffered then delivered F packets have delays inside the interval 3 meaning between $10^{-5} s$ and $2.5 \times 10^{-5} s$: in the order of 10^7 packets have delays inside the interval 3 compared to few thousand packets having delays in the intervals 4 to 6. It is also the case for R and D packets. All the delays are in the same order of magnitude, there is no packets that should be considered as lost because of “excessive” delay. This indicates the absence of outliers (packets remained blocked in the buffer); the mean latency is thus a sufficient indicator.

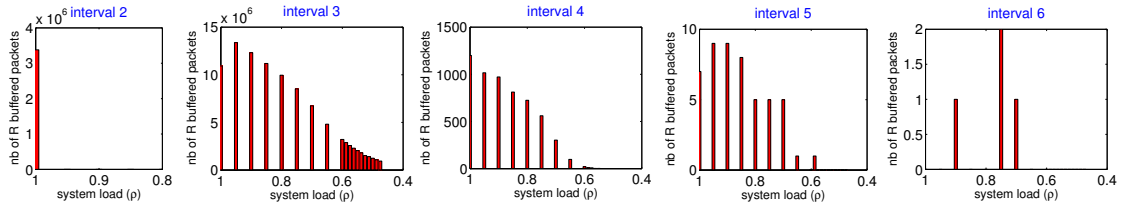

Figure C.1: *nbr of buffered then switched R packets vs system load, $n_a = 8, n_c = 8, n_e = 12$*

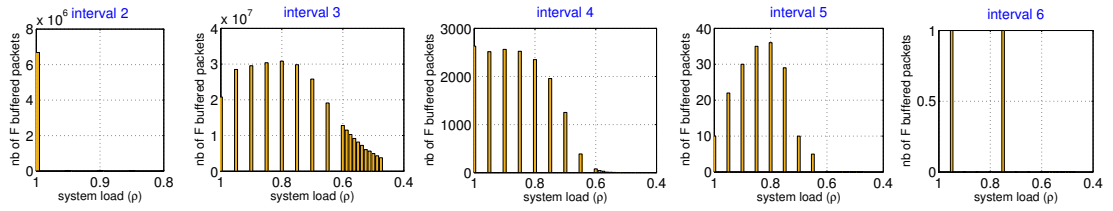

Figure C.2: *nbr of buffered then switched F packets vs system load, $n_a = 8, n_c = 8, n_e = 12$*

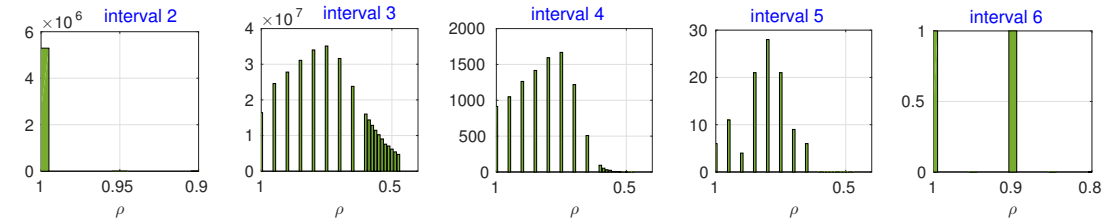

Figure C.3: *nbr of buffered then switched D packets vs system load, $n_a = 8, n_c = 8, n_e = 12$*

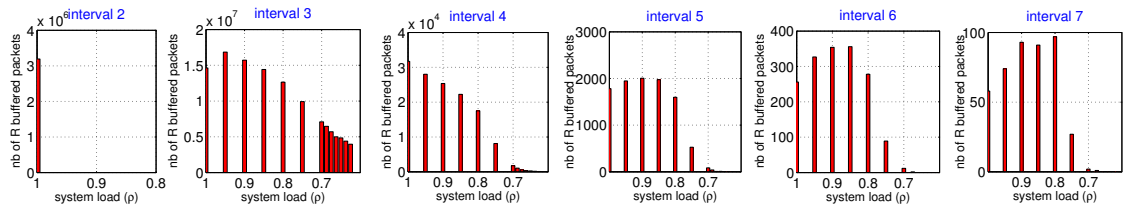

Figure C.4: *nbr of buffered then switched R packets vs system load, $n_a = 8, n_c = 8, n_e = 20$*

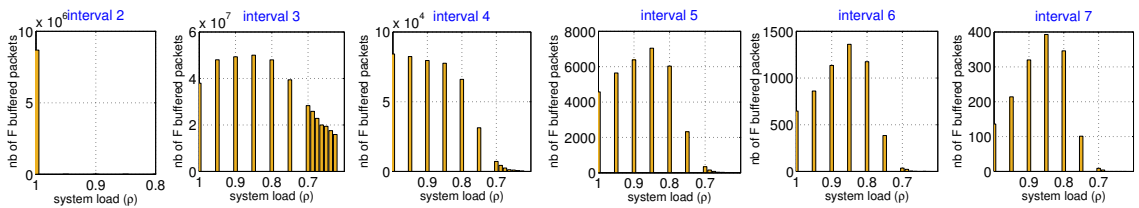

Figure C.5: *nbr of buffered then switched F packets vs system load, $n_a = 8, n_c = 8, n_e = 20$*

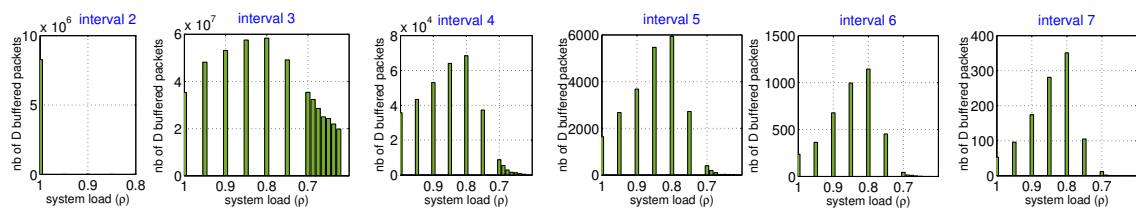

Figure C.6: *nbr of buffered then switched D packets vs system load, $n_a = 8, n_c = 8, n_e = 20$*

Appendix D

Synthèse en Français

Thématique

Les réseaux de télécommunications ont évolué afin de répondre au besoin croissant en bande passante, longues distances de transmission et bonne qualité de service. De nos jours, la fibre optique est le support de transmission le plus déployé pour des débits élevés dans les réseaux cœurs, métropolitains et même dans les réseaux d'accès. Les réseaux de télécommunications qui se basent sur la transmission sur fibre optique sont appelés "réseaux optiques", même s'ils intègrent aussi d'autres technologies électroniques ou radios. Ces réseaux optiques ont connus cinq générations jusqu'à maintenant, marquant par des évolutions de technologies et composants optiques et de protocoles. Une description de cette évolution est présentée au chapitre 1. La 4^{ème} et 5^{ème} génération sont encore en phase d'étude et recherche.

Malgré l'évolution des technologies optiques, la commutation de paquets se fait toujours en électronique. Tous les paquets transmis sur fibre optique doivent être convertis au domaine électrique au niveau des commutateurs, puis retransmis au domaine optique pour la continuité de transmission sur fibre vers leurs destinations. La figure D.1 présente l'architecture d'un commutateur électrique. On rappelle que la quasi-totalité du trafic est transmise sous forme de paquets, de ce fait, nous nous sommes intéressés à la commutation de paquets. Les conversions Optique-Électrique-Optique (O-E-O) requises font de la commutation un des domaines les plus coûteux en énergie, surtout avec la croissance exponentielle du trafic [5]. Sachant que la consommation électrique des réseaux de télécommunications croît de 10% chaque année [7], un défi important est la réduction de cette consommation.

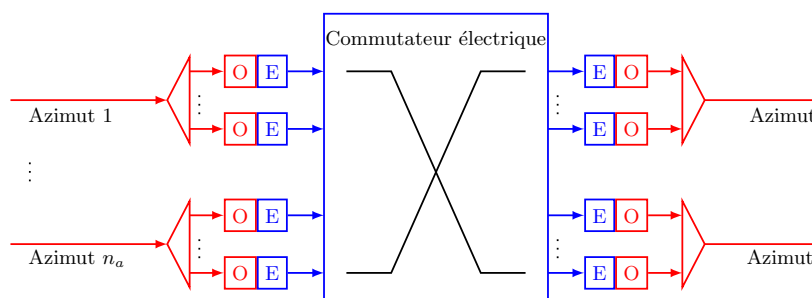

Figure D.1: Architecture d'un commutateur électrique

Plusieurs chercheurs se sont investis dans l'étude des commutateurs de paquets tout-optiques [14, 15]. Les conversions O-E-O ne seront plus requises (voir l'architecture d'un commutateur tout-optique à la Figure D.2) et la consommation énergétique diminuera. Cependant, par manque de solutions matures et fiables de mise en mémoire optique, les commutateurs tout-optiques sont vulnérables à la contention de paquets: si 2 paquets ou plus destinés à la même adresse arrivent au commutateur simultanément, le commutateur ne peut passer qu'un seul paquet et les autres seront mis en mémoire d'attente, ou envoyés vers d'autres destinations suivant une politique de routage en déflexion, ou au pire perdus. De ce fait, les commutateurs de paquets tout-optiques provoquent des taux de pertes de paquets assez élevés et inacceptables même à des faibles charges de système [16]. Alors, leur utilisation n'a pas dépassé le stade du laboratoire de recherche.

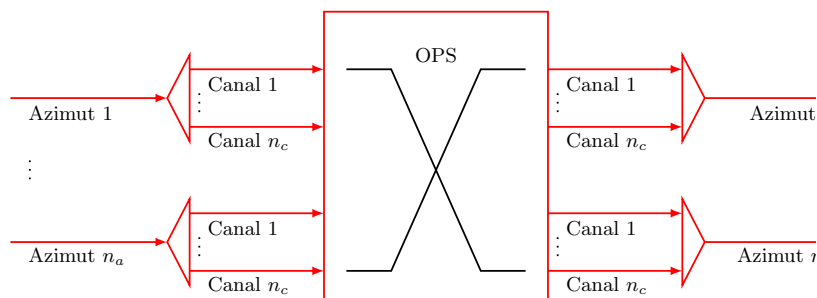

Figure D.2: Architecture d'un commutateur tout-optique

La solution à laquelle nous croyons est la commutation hybride opto-électronique [19, 20, 21, 22]. Un commutateur hybride consiste en une matrice de commutation optique complétée par une mémoire électronique. Son architecture est présentée par la Figure D.3. Les paquets sont commutés optiquement, rapidement et à une faible consommation énergétique, et seulement en cas de contention, un paquet sera converti au domaine électrique et mis en mémoire d'attente. Le mariage des technologies optique et électronique pourrait apporter les avantages des deux domaines. D'une part, le commutateur hybride fait face à la contention de paquets puisqu'il dispose d'une mémoire électronique. D'autre part, comparé à un commutateur électrique, les conversions O-E-O seront réduites juste au nombre des paquets mis en mémoire. Ainsi, le commutateur de paquets hybride pourrait être une solution pour réduire la consommation énergétique des réseaux de communication optique.

Performance du commutateur hybride connecté via des canaux interchangeables SDM

En prenant en compte différentes classes de service, paquets "fiables", "rapides" et "par défaut", nous avons établi une stratégie de commutation qui permet de répondre aux exigences de chaque classe en termes de taux de perte de paquets (PLR), de la charge soutenable de système et de la latence de commutation. Nous avons simulé le commutateur connecté à ses azimuts via des canaux interchangeables multiplexés en espace (SDM). Nos résultats montrent que le commutateur hybride satisfait les exigences de performance de toutes les classes de paquets: aucun paquet Fiable n'est perdu, les délais de commutation sont autour de 10 μ s avec 4 ordres de grandeur au-dessous des lim-

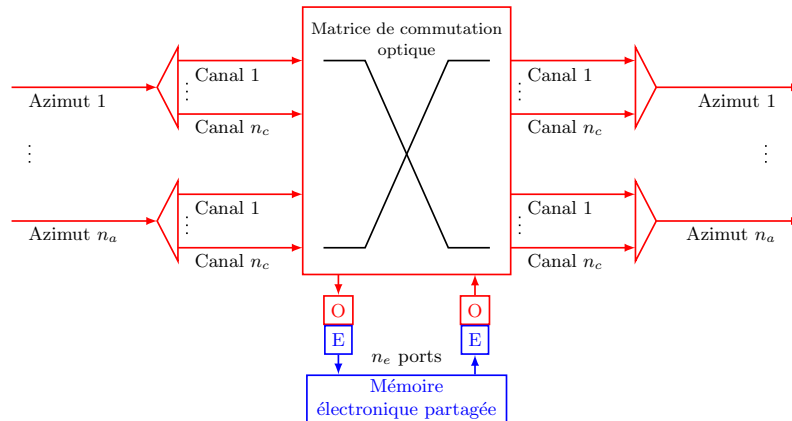

Figure D.3: Architecture du commutateur hybride opto-électronique

ites acceptables même pour les paquets Rapides, et la charge soutenable de système à $PLR_{\text{par Défaut}} = 10^{-4}$ et $PLR_{\text{Rapides}} = 10^{-4}$ excède 60 %, où le nombre de ports de la mémoire électroniques est moins que la moitié de celui de ports optiques. Une comparaison des délais de commutation est faite avec un commutateur de la marque Cisco. La capacité de mémoire requise est limitée et raisonnable.

De plus, comparé aux commutateurs électriques, le commutateur de paquets hybride réduit significativement les conversions O-E-O. Par exemple, un commutateur connecté à 8 azimuts via 8 canaux SDM par azimuth et ayant 30 ports électroniques pour la mémoire, évite au moins 55% des conversions O-E-O par rapport à un commutateur tout-électrique. Le commutateur hybride pourrait ainsi être une solution prometteuse pour réduire la consommation d'énergie, particulièrement si les ports de la mémoire électronique sont capables du mode en veille en cas de non utilisation. Ces résultats sont détaillés au chapitre 2.

Performance du commutateur hybride utilisé dans un contexte WDM

Nous avons étendu notre enquête en simulant notre commutateur connecté à ses azimuts via des canaux multiplexés en longueur d'onde (WDM). Comme prévu, comparé au cas de canaux interchangeable, les performances se dégradent à cause de la contrainte de la continuité de longueur d'onde. Il n'est pas possible d'avoir une charge soutenable acceptable ($\geq 60\%$) sans avoir une mémoire électronique sur-dimensionnée par rapport au nombre des ports optiques. Les délais de commutation augmentent considérablement comparés à ceux obtenus pour des canaux SDM, mais toujours avec 4 ordres de grandeur au-dessous des limites acceptables pour les paquets Rapides. Nous avons alors proposé deux solutions qui permettent d'avoir quelques degrés d'interchangeabilité des canaux tout en restant dans le contexte des réseaux WDM.

La première consiste à compléter le commutateur avec des convertisseurs partagés de longueurs d'onde. Ces convertisseurs ont permis de baisser les PLRs sans autant affecter l'économie d'énergie offerte par le commutateur hybride par rapport aux commutateurs électriques commercialisés. La seconde consiste à combiner les techniques

SDM et WDM au niveau de la connectivité du commutateur: une connection à des fibres SDm multi-modes ou multi-coeurs, supportant des signaux WDM en chaque mode ou coeur. L'architecture de ce commutateur est présentée par la Figure D.4.

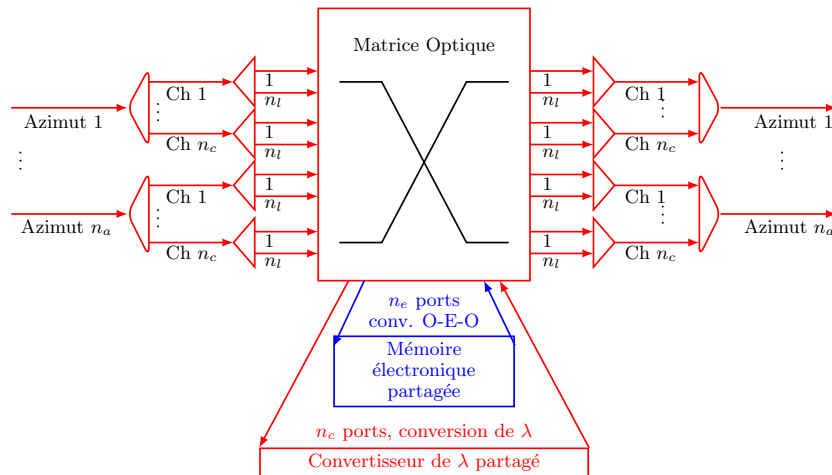

Figure D.4: Architecture du commutateur hybride opto-électronique avec des connections optiques SDM-WDM

Nos simulations montrent que la combinaison des techniques SDM et WDM est un bon compromis entre les performances de commutation et l'intégration du commutateur hybride dans des réseaux WDM. Notre commutateur hybride répond aux exigences des différentes classes de paquets en termes de PLR et de la latence, et pourrait réduire la consommation énergétique par rapport aux commutateurs électriques. Ces résultats sont détaillés au chapitre 3.

Apprentissage machine pour minimiser les excursions de puissance

Nous avons élaboré un modèle de Machine Learning qui permet de recommander les bonnes pratiques à suivre d'ajout ou de suppression de canaux d'un système WDM tout en minimisant les excursions de puissance des amplificateurs optiques EDFA. Ce modèle permet de prévoir à quelle longueur d'onde on commute un paquet en tenant compte de sa classe de service et de celles des autres paquets présents au commutateur. L'application de ce modèle n'est pas limitée à l'exemple de notre commutateur de paquets mais il est applicable pour tout système WDM où la transmission se fait sur plusieurs blocs utilisant des amplificateurs EDFA. Ces résultats sont détaillés au chapitre 4.

Cadre du travail

Dans le cadre du programme doctoral de l'EDITE, Ecole Doctorale en Informatique, Télécommunication et Électronique de Paris, les travaux de cette thèse se sont déroulés au sein de Télécom ParisTech, Université Paris-Saclay sous la direction de Dr. Cédric Ware,

maître de conférences-HDR à Télécom ParisTech et Dr. Mounia Lourdiane, maître de conférences à Télécom SudParis.

Une partie de ce travail (chapitre 4) a été réalisée au cours de mon séjour de 4 mois à Lighthwave Research Laboratory, Columbia University à New York, dans le cadre de l'initiation d'un programme d'échange entre notre institution Télécom ParisTech et Columbia University.

Cette thèse est principalement financée par une bourse nationale délivrée par le Ministère de l'Enseignement Supérieur et de la Recherche Scientifique - Tunisie et basée sur des critères de mérite.

Le travail présenté dans ce manuscrit a mené aux publications présentées dans l'annexe A.

Bibliography

- [1] A. J. T. Fuentes, "Introduction to Optical Networks," Spain, 2012. [Online]. Available: http://ocw.umh.es/ingenieria-y-arquitectura/optical_communication/learning-materials/theory/lecture-5.-intro-optical-networks.pdf
- [2] S. Goyal, "MPLS Basics." [Online]. Available: <http://mplstutorial.com/mpls-basics>
- [3] Y. Chen, C. Qiao, and X. Yu, "Optical burst switching: a new area in optical networking research," *IEEE/ACM Transactions on Networking*, vol. 18, no. 3, pp. 16–23, May 2004.
- [4] T. Szigeti, C. Hattingh, R. Barton, and K. Briley, "Quality of Service Design Overview," *CISCO Press*, Nov. 2013. [Online]. Available: http://www.cisco.com/c/en/us/td/docs/solutions/Enterprise/WAN_and_MAN/QoS_SRND/QoS-SRND-Book/QoSIntro.html
- [5] D. C. Kilper, G. Atkinson, S. K. Korotky, S. Goyal, P. Vetter, D. Suvakovic, and O. Blume, "Power trends in communication networks," *IEEE Journal of Selected Topics in Quantum Electronics*, vol. 17, no. 2, pp. 275–284, Mar./Apr. 2011.
- [6] J. Giles, "Internet responsible for 2 per cent of global energy usage," Oct. 2011. [Online]. Available: <https://www.newscientist.com/blogs/onepercent/2011/10/307-gw-the-maximum-energy-the.html>
- [7] S. Lambert, W. V. Heddeghem, W. Vereecken, L. Bart, D. Colle, and M. Pickavet, "Worldwide electricity consumption of communication networks," *Optics Express*, vol. 20, no. 26, pp. B513–B524, 2012.
- [8] D. Kilper, K. Guan, K. Hinton, and R. Ayre, "Energy Challenges in Current and Future Optical Transmission Networks," *Proceedings of the IEEE*, vol. 100, no. 5, pp. 1168–1187, May 2012.
- [9] S. Yoo, "Energy Efficiency in the Future Internet: The Role of Optical Packet Switching and Optical-Label Switching," *IEEE Journal of Selected Topics in Quantum Electronics*, vol. 17, no. 2, pp. 406–418, Mar. 2011.
- [10] T. Segawa, S. Ibrahim, T. Nakahara, Y. Muranaka, and R. Takahashi, "Low-Power Optical Packet Switching for 100-Gb/s Burst Optical Packets With a Label Processor and 8×8 Optical Switch," *IEEE/OSA Journal of Lightwave Technology*, vol. 34, no. 8, pp. 1844–1850, Apr. 2016.

- [11] I. White, K. Shrikhande, M. Rogge, S. Gemelos, D. Wonglumsom, G. Desa, Y. Fukushima, and L. Kazovsky, "Architecture and protocols for HORNET: a novel packet-over-WDM multiple-access MAN," in *IEEE Global Telecommunications Conference (GLOBECOM)*, vol. 2, 2000, pp. 1298–1302 vol.2.
- [12] B. Meagher, G. Chang, G. Ellinas, Y. Lin, W. Xin, T. Chen, X. Yang, A. Chowdhury, J. Young, S. Yoo, C. Lee, M. Iqbal, T. Robe, H. Dai, Y. Chen, and W. Way, "Design and implementation of ultra-low latency optical label switching for packet-switched WDM networks," *IEEE/OSA Journal of Lightwave Technology*, vol. 18, no. 12, pp. 1978–1987, Dec. 2000.
- [13] D. Blumenthal, B. Olsson, G. Rossi, T. Dimmick, L. Rau, M. Masanović, O. Lavrova, R. Doshi, O. Jerphagnon, J. Bowers, V. Kaman, L. Coldren, and J. Barton, "All-optical label swapping networks and technologies," *IEEE/OSA Journal of Lightwave Technology*, vol. 18, no. 12, pp. 2058–2075, Dec. 2000.
- [14] Y. Leem, D. Yee, E. Sim, D. Kim, and K. Park, "Optical signal retiming, reshaping, and reamplifying (3R) regeneration system having monolithically integrated Mach Zehnder interferometer and self-pulsating laser diode," Feb. 2009, uS Patent 7,489,873. [Online]. Available: <http://www.google.com/patents/US7489873>
- [15] J. Li, T. Huang, and L. Chen, "Detailed Analysis of All-Optical Clock Recovery at 10 Gb/s Based on a Fiber Optical Parametric Oscillator," *IEEE Journal of Selected Topics in Quantum Electronics*, vol. 18, no. 2, pp. 701–708, Mar. 2012.
- [16] Z. Rosberg, H. Le Vu, M. Zukerman, and J. White, "Performance analyses of optical burst-switching networks," *IEEE Journal on Selected Areas in Communications*, vol. 21, no. 7, pp. 1187–1197, 2003.
- [17] S. Yang and N. Stol, "Packet loss bounds for asynchronous bufferless optical packet switches with limited range wavelength converters," in *IEEE Global Telecommunications Conference (GLOBECOM)*, Dec. 2012, pp. 1692–1697.
- [18] H. Meyer, J. Sancho, W. Miao, H. Dorren, N. Calabretta, and M. Farreras, "Performance evaluation of Optical Packet Switches on high performance applications," in *Int. Conf. on High Performance Computing Simulation (HPCS)*, Jul. 2015, pp. 356–363.
- [19] R. Takahashi, T. Nakahara, K. Takahata, H. Takenouchi, T. Yasui, N. Kondo, and H. Suzuki, "Ultrafast optoelectronic packet processing for asynchronous, optical-packet-switched networks," *Journal of Optical Networking*, vol. 3, no. 12, pp. 914–930, 2004, invited paper.
- [20] D. Chiaroni, R. Urata, J. Gripp, J. Simsarian, G. Austin, S. Etienne, T. Segawa, Y. Pointurier, C. Simonneau, Y. Suzaki, T. Nakahara, M. Thottan, A. Adamiecki, D. Neilson, J.-C. Antona, S. Bigo, R. Takahashi, and V. Radoaca, "Demonstration of the interconnection of two optical packet rings with a hybrid optoelectronic packet router," in *Eur. Conf. on Opt. Comm. (ECOC)*. IEEE, Sep. 2010.
- [21] R. Takahashi, T. Nakahara, Y. Suzaki, T. Segawa, H. Ishikawa, and S. Ibrahim, "Recent Progress on the Hybrid Optoelectronic Router," in *Photonics in Switching (PS)*, Ajaccio, Corsica Island, France, Sep. 2012.

- [22] P. Delesques, T. Bonald, G. Froc, P. Ciblat, and C. Ware, "Enhancement of an Optical Burst Switch with Shared Electronic Buffers," in *International Conference on Optical Networking Design and Modeling (ONDM)*, Brest, France, Apr. 2013, pp. 136–141, poster.
- [23] W. Samoud, C. Ware, and M. Lourdiane, "Investigation of a hybrid optical-electronic switch supporting different service classes," in *Photonics North*, no. 9288-38, Montreal, Canada, May 2014.
- [24] W. Samoud, M. Lourdiane, and C. Ware, "Etude d'un commutateur hybride optoélectronique gérant différentes classes de service," in *JNOG*, Nice, France, Oct. 2014, poster.
- [25] W. Samoud, C. Ware, and M. Lourdiane, "Performance Analysis of a Hybrid Optical Electronic Packet Switch Supporting Different Service Classes," *IEEE/OSA Journal of Optical Communications and Networks (JOCN)*, vol. 7, no. 9, pp. 952–959, Sep. 2015.
- [26] W. Samoud, M. Lourdiane, and C. Ware, "Hybrid Opto-Electronic Packet Switch Connected to Interchangeable Channels," in *International OSA Network of Students/ Federation of Optics College and University Students (IONS/FOCUS)*. Tunis, Tunisia: OSA/SPIE, Sep. 2015.
- [27] W. Samoud, C. Ware, and M. Lourdiane, "Comparison between interchangeable and WDM channels for hybrid optoelectronic switch," in *Photonics North*, no. 7569209, Ottawa, Canada, Jun. 2015.
- [28] —, "Performance Analysis of a Hybrid Opto-Electronic Packet Switch using WDM Technology," in *Photonics in Switching (PS)*. Firenze, Italy: IEEE, Sep. 2015, pp. 348–350.
- [29] W. Samoud, M. Lourdiane, and C. Ware, "Performance Improvements of Hybrid Opto-Electronic Packet Switch Using SDM in Addition to WDM," in *Eur. Conf. on Opt. Comm. (ECOC)*, no. 0489. Valencia, Spain: IEEE, Sep. 2015, poster.
- [30] —, "Hybrid Opto-Electronic Packet Switch: A Promising Solution to Reduce the Energy Consumption," in *International OSA Network of Students (IONS)*. Naples, Italy: OSA, Jul. 2016.
- [31] Y. Huang, W. Samoud, C. Gutterman, C. Ware, M. Lourdiane, G. Zussman, P. Samadi, and K. Bergman, "A Machine Learning Approach for Dynamic Optical Channel Add/Drop Strategies that Minimize EDFA Power Excursions," in *Eur. Conf. on Opt. Comm. (ECOC)*, no. Tu.2.B.3. Dusseldorf, Germany: IEEE, Sep. 2016.
- [32] Y. Huang, C. L. Gutterman, P. Samadi, P. B. Cho, W. Samoud, C. Ware, M. Lourdiane, G. Zussman, and K. Bergman, "Dynamic mitigation of edfa power excursions with machine learning," *Optics Express*, vol. 25, no. 3, pp. 2245–2258, Feb. 2017.
- [33] "Alcatel-Lucent boosts operator capacity to deliver big data and video over existing networks with launch of 400G IP router interface," Paris, France, Feb. 2015. [Online]. Available: <https://www.alcatel-lucent.com/press/2015/alcatel-lucent-boosts-operator-capacity-deliver-big-data-and-video-over-existing-networks-launch>

- [34] R. Powell, "2015 Capex Trends for Competitive Network Operators," Telecom Ramblings, Tech. Rep., Dec. 2015. [Online]. Available: <http://www.telecomramblings.com/2015/12/2015-capex-trends-for-competitive-network-operators>
- [35] N. Clinckx and Y. Buffalio, "Optimize network OPEX and CAPEX while enhancing the quality of service," Ernst & Young (EY), Tech. Rep., Jan. 2014.
- [36] A. Kretsis, P. Kokkinos, K. Christodoulopoulos, T. Varvarigou, and E. Varvarigos, "Mantis: Cloud-based optical network planning and operation tool," *Computer Networks*, vol. 77, pp. 153–168, Feb. 2015.
- [37] P. Papanikolaou, K. Christodoulopoulos, and E. Varvarigos, "Multilayer flex-grid network planning," in *International Conference on Optical Networking Design and Modeling (ONDM)*. Pisa, Italy: IEEE, May 2015, pp. 151–156.
- [38] M. Gharaei, "Nouveaux concepts pour les réseaux d'accès optiques," Ph.D. dissertation, Télécom ParisTech, Jul. 2010.
- [39] E. Harstead and R. Sharpe, "Forecasting of Access Network Bandwidth Demands for Aggregated Subscribers Using Monte Carlo Methods," *IEEE Communications Magazine*, vol. 53, no. 3, pp. 199–207, Mar. 2015.
- [40] "Cisco Catalyst 3850 Switches datasheet, c78-720918," Cisco®, Tech. Rep., Mar. 2016.
- [41] K. N. Oikonomou, R. K. Sinha, B. J. Kim, and R. D. Doverspike, "Performability analysis of a metropolitan area cellular network," in *Int. Conf. on Design of Reliable Communication Networks (DRCN)*, Mar. 2015, pp. 141–148.
- [42] H. Teimoori, "Commutation de paquets dans les réseaux optiques transparents à partir de fonctions logiques tout-optiques," Ph.D. dissertation, Télécom ParisTech, Sep. 2007.
- [43] "Alcatel-Lucent expands optical networking portfolio to meet enterprise and operator demand for video, cloud and data center traffic in metro networks," Paris, France, Mar. 2015.
- [44] S. Pato, N. Borges, and J. Pedro, "Capacity prospects of future high density metro-access networks," in *Int. Conf. on Transp. Opt. Networks (ICTON)*, Jun. 2013.
- [45] P. Mahajan and G. Bennett, "Transforming metro-network economics," *Lightwave Online*, Mar. 2015. [Online]. Available: <http://www.lightwaveonline.com/articles/print/volume-32/issue-2/features/transforming-metro-network-economics.html>
- [46] S. Adhikari, C. Marheine, S. Krueger, B. Coles, G. Cardona, M. Ding, M. Bussman, F. Muya, J. Cai, J. Szeto, S. Elahmadi, and S. Elahmadi, "Passive 100 Gb/s Metro Migration," in *ITG Symposium of Photonic Networks*, May 2015, pp. 1–6.

- [47] W. Zhang, B. G. Bathula, R. K. Sinha, R. Doverspike, P. Magill, A. Raghuram, and G. Choudhury, "Evolution of the IP-over-Optical Core Network," in *International Conference on Design of Reliable Communication Networks*, Kansas City, USA, Mar. 2015.
- [48] "Cost to Install Fiber Cement Siding," Jun. 2016. [Online]. Available: http://www.homewyse.com/services/cost_to_install_fiber_cement_siding.html
- [49] "Unit Cost Entries for Fiber Optic Cable Installation," Feb. 2015. [Online]. Available: <http://www.itscosts.its.dot.gov/its/benecost.nsf/DisplayRUCByUnitCostElementUnadjusted?ReadForm&UnitCostElement=Fiber+Optic+Cable+Installation+&Subsystem=Roadside+Telecommunications+%28RS-TC%29>
- [50] R. J. Mears, L. Reekie, S. B. Poole, and D. N. Payne, "Low-threshold tunable CW and Q-switched fibre laser operating at 1.55 μm ," *Electronics Letters*, vol. 22, no. 3, pp. 159–160, Jan. 1986.
- [51] B. Mukherjee, "WDM Optical Communication Network; Progress and Challenges," *IEEE Journal on Selected Areas in Communications*, vol. 18, no. 10, pp. 1810–1824, Oct. 2000. [Online]. Available: http://cecs.wright.edu/~bwang/course/ceg790/jsac_oct00.pdf
- [52] R. S. Quimby, *Photonics and Lasers: An Introduction*. John Wiley and sons, 2006, ch. 24, p. 453.
- [53] E. Effenberger, R. Ivry, H. Valencia, G. Papandrea, Y. Ota, T. Anderson, and W. Soto, "PMD Optical Specifications," Sep. 2001. [Online]. Available: http://www.ieee802.org/3/efm/public/sep01/effenberger_2_0901.pdf
- [54] "G.694.1 : Spectral grids for WDM applications: DWDM frequency grid," International Telecommunications Unit, Tech. Rep., 2012. [Online]. Available: <http://www.itu.int/rec/T-REC-G.694.1-201202-1/en>
- [55] R. Jain, "IP Over SONET." [Online]. Available: http://www.cse.wustl.edu/~jain/cis788-99/ftp/h_bipsn.pdf
- [56] L. Eldada, "Optical add/drop multiplexing architecture for metro area networks," in *SPIE Newsroom*. SPIE, Jan. 2008.
- [57] —, "ROADM architectures and technologies for agile optical networks," in *Optoelectronic Integrated Circuits IX*, vol. 6476, no. 647605. SPIE, Feb. 2007.
- [58] D. Ge, J. Li, Z. Wu, F. Ren, P. Zhu, Q. Mo, Z. Li, Z. Chen, and Y. He, "Experimental demonstration of ROADM functionalities for hybrid MDM-WDM optical networks," in *Opt. Fiber Comm. Conf. (OFC)*, Mar. 2016.
- [59] K. Suzuki, K. Seno, and Y. Ikuma, "Application of waveguide/free-space optics hybrid to ROADM device," *IEEE/OSA Journal of Lightwave Technology*, Aug. 2016.

- [60] J. H. Chen, K. H. Chen, C. H. Yeh, and W. P. Huang, "Simplified Design of Multiport Optical Circulator With Parallel Connection of Mirror-Image Arranged Spatial- and Polarization-Modules," *IEEE Photonics Technology Letters*, vol. 23, no. 23, pp. 1766–1768, Dec. 2011.
- [61] Y. Sun, J. Sulhoff, A. Srivastava, A. Abramov, T. Strasser, P. Wysocki, J. Pedrazzani, J. Judkins, R. Espindola, C. Wolf, J. Zyskind, A. Vengsarkar, and J. Zhou, "A gain-flattened ultra wide band EDFA for high capacity WDM optical communications systems," in *Eur. Conf. on Opt. Comm. (ECOC)*, vol. 1, Sep. 1998, pp. 53–54.
- [62] T. Shiragaki, N. Henmi, T. Kato, M. F. Fujiwara, M. Misono, T. Shiozawa, and S. Suzuki, "Optical Cross-Connect System Incorporated with Newly Developed Operation and Management System," *IEEE Journal on Selected Areas in Communications*, vol. 16, no. 7, pp. 1179–930, Sep. 1998.
- [63] J. Neil A., P. Sunita H., M. Benny P., and K. Steven K., "Optical Cross Connects for Optical Networking," *Bell Labs Technical Journal*, pp. 262–281, 1999. [Online]. Available: http://net.infocom.uniroma1.it/corsi/ro/materiale/25_paper14.pdf
- [64] "iOXC™ NxN switch with power monitoring and automatic channel balancing," Enablence, Tech. Rep. [Online]. Available: <http://www.enablence.com/media/mediamanager/pdf/22-enablence-datasheet-ocsd-oxc-ioxc-nxn.pdf>
- [65] S. B. Yoo, "Optical burst and packet switching," in *Optical Fiber Telecommunications*, fifth edition ed., ser. Optics and Photonics, I. P. Kaminow, T. Li, and A. E. Willner, Eds. Burlington: Academic Press, 2008, pp. 641–693. [Online]. Available: <http://www.sciencedirect.com/science/article/pii/B9780123741721000163>
- [66] Q. Li, S. Rumley, M. Glick, J. Chan, H. Wang, K. Bergman, and R. Dutt, "Scaling star-coupler-based optical networks for avionics applications," *IEEE/OSA Journal of Optical Communications and Networks (JOCN)*, vol. 5, no. 9, pp. 945–956, Sep. 2013.
- [67] M. Tan, P. Rosenberg, G. Panotopoulos, M. McLaren, W. Sorin, S. Mathai, L. Kiyama, J. Straznicky, and D. Warren, "OPTOPUS: Optical backplane for data center switches," in *Opt. Fiber Comm. Conf. (OFC)*, Mar. 2014.
- [68] J.-P. Laude, "6.7: Passive Wavelength Router," in *DWDM Fundamentals, Components, and Applications*. Artech House, 2002, pp. 169–172.
- [69] B. Mukherjee, "WDM networking evolution," in *Optical WDM Networks*, ser. Optical Networks. Springer US, 2006, pp. 23–29.
- [70] M. T. Fatehi and W. H. Knox, "Wavelength-selective optical cross-connect," May 2000, uS Patent 6,067,389. [Online]. Available: <https://www.google.com/patents/US6067389>
- [71] V. Kaman, S. Yuan, O. Jerphagnon, R. Helkey, and J. Bowers, "Comparison of Wavelength-Selective Cross-Connect Architectures for Reconfigurable All-Optical Networks," in *Photonics in Switching (PS)*, Oct. 2006.

- [72] C. V. Saradhi and S. Subramaniam, "Physical layer impairment aware routing (PLIAR) in WDM optical networks: issues and challenges," *IEEE Communications Surveys and Tutorials*, vol. 11, no. 4, pp. 109–130, Apr. 2009.
- [73] A. Morea, J. Renaudier, A. Ghazisaeidi, O. Bertran-Pardo, and T. Zami, "Impact of reducing channel spacing from 50GHz to 37.5GHz in fully transparent meshed networks," in *Opt. Fiber Comm. Conf. (OFC)*, Mar. 2014.
- [74] A. Morea, J. Renaudier, T. Zami, A. Ghazisaeidi, and O. Bertran-Pardo, "Throughput comparison between 50-GHz and 37.5-GHz grid transparent networks [Invited]," *IEEE/OSA Journal of Optical Communications and Networks (JOCN)*, vol. 7, no. 2, pp. A293–A300, Feb. 2015.
- [75] H. D. Thanh, M. Morvan, P. Gravey, F. Cugini, and I. Cerutti, "On the spectrum-efficiency of transparent optical transport network design with variable-rate forward error correction codes," in *16th Int. Conf. on Advanced Communication Technology*, Feb. 2014, pp. 1173–1177.
- [76] A. Morea, N. Brogard, F. Leplingard, J.-C. Antona, T. Zami, B. Lavigne, and D. Bayart, "QoT function and A* routing: an optimized combination for connection search in translucent networks," *J. Opt. Netw.*, vol. 7, no. 1, pp. 42–61, Jan. 2008.
- [77] D. Awduche and Y. Rekhter, "Multiprotocol lambda switching: combining MPLS traffic engineering control with optical crossconnects," *IEEE Communications Magazine*, vol. 39, no. 3, pp. 111–116, Mar. 2001.
- [78] T. M. Chen and W. Wu, "Multiprotocol lambda switching for IP over optical networks," in *SPIE 4211, Internet Quality and Performance and Control of Network Systems*, vol. 4211. Boston, Massachusetts, USA: SPIE, Feb. 2001, pp. 165–172. [Online]. Available: https://lyle.smu.edu/~tchen/papers/SPIE_Nov2000.pdf
- [79] L. Berger, "Generalized Multi-Protocol Label Switching (GMPLS) Signaling Functional Description," Network Working Group, Tech. Rep. RFC 3471, Jan. 2003. [Online]. Available: <http://tools.ietf.org/html/rfc3471>
- [80] A. Banerjee, J. Drake, J. Lang, B. Turner, D. Awduche, L. Berger, K. Kompella, and Y. Rekhter, "Generalized multiprotocol label switching: an overview of signaling enhancements and recovery techniques," *IEEE Communications Magazine*, vol. 39, no. 7, pp. 144–151, Jul. 2001.
- [81] G. N. Rouskas and L. Xu, *Optical Packet Switching*. North Carolina, US: Springer US, 2005, pp. 111–127. [Online]. Available: <http://rouskas.csc.ncsu.edu/Publications/Books/Kluwer-Rouskas-2004.pdf>
- [82] J. Wang, C. McArdle, and L. P. Barry, "Retransmission Schemes for Lossless Transparent Optical Packet Switching in Large-Scale Datacentre Networks," in *Int. Conf. on Future Internet of Things and Cloud (FiCloud)*, Aug. 2016, pp. 207–212.
- [83] H. Overby, "Performance modelling of synchronous bufferless OPS networks," in *Int. Conf. on Transp. Opt. Networks (ICTON)*, vol. 1, Jul. 2004, pp. 22–28.

- [84] N. Benzaoui, Y. Pointurier, T. Bonald, B. Uscumlic, Q. Wei, and S. Bigo, "Mobility support in optical slot switching-based next-generation mobile backhaul networks," in *Eur. Conf. on Opt. Comm. (ECOC)*, Valencia, Spain, Sep. 2015.
- [85] H. Overby, N. Stol, and M. Nord, "Evaluation of QoS differentiation mechanisms in asynchronous bufferless optical packet-switched networks," *IEEE Communications Magazine*, vol. 44, no. 8, pp. 52–57, Aug. 2006.
- [86] E. Sharma, R. Goyal, and S. Debnath, "Absolute service guarantee in asynchronous Optical Packet Switched (OPS) network for Bernoulli traffic," in *Int. Conf. on Electromagnetics in Advanced Applications (ICEAA)*, Sep. 2013, pp. 1378–1381.
- [87] D. Blumenthal, A. Carena, L. Rau, V. Curri, and S. Humphries, "WDM optical IP tag switching with packet-rate wavelength conversion and subcarrier multiplexed addressing," in *Opt. Fiber Comm. Conf. (OFC)*, vol. 3, Feb. 1999, pp. 162–164 vol.3.
- [88] M. Scaffardi, E. Lazzeri, H. Furukawa, N. Wada, T. Miyazaki, L. Poti, and A. Bogoni, "160 Gb/s/Port 2 * 2 OPS Node Test-Bed Performing 50 Gchip/s All-Optical Active Label Processing With Contention Detection," *IEEE/OSA Journal of Lightwave Technology*, vol. 28, no. 6, pp. 922–930, Mar. 2010.
- [89] K. S. Chen, C. C. Yang, and J. F. Huang, "Using Stuffed Quadratic Congruence Codes for SAC Labels in Optical Packet Switching Network," *IEEE Communications Letters*, vol. 19, no. 7, pp. 1093–1096, Jul. 2015.
- [90] F. Wen, B.-J. Wu, X.-Y. Zhou, H. Yuan, and K. Qiu, "Magneto-optic nonlinear optical loop mirror for all-optical 3R signal regeneration," in *Opt. Fiber Comm. Conf. (OFC)*, Mar. 2014.
- [91] X. Chen, L. Huo, Q. Wang, and C. Lou, "100-Gb/s 3R Regeneration with Cross Gain Compression in Semiconductor Optical Amplifiers," vol. PP, no. 99, 2016.
- [92] "Optical Fiber Delay Lines, Motorized," Newport, Tech. Rep. [Online]. Available: <http://www.newport.com/MDL-Series-Optical-Fiber-Delay-Lines-Motorized/835799/1033/info.aspx>
- [93] N. Beheshti, E. Burmeister, Y. Ganjali, J. Bowers, D. Blumenthal, and N. McKeown, "Optical Packet Buffers for Backbone Internet Routers," *IEEE/ACM Transactions on Networking*, vol. 18, no. 5, pp. 1599–1609, Oct. 2010.
- [94] A. G. Rahbar, *Contention Avoidance in OPS Networks*. Wiley-IEEE Press, 2015, pp. 452–.
- [95] M. Zheng and S. Ji, "Performance Evaluation of OPS Contention Resolution Scheme Based on SPC Wavelength Conversion," in *Int. Conf. on Computational and Information Sciences (ICCIS)*, Dec. 2010, pp. 917–919.
- [96] M. Yoo, C. Qiao, and S. Dixit, "Optical burst switching for service differentiation in the next-generation optical Internet," *IEEE Communications Magazine*, vol. 39, no. 2, pp. 98–104, Feb. 2001.

- [97] J. D. P. López, J. C. B. Flórez, and J. G. L. Perafán, "HMCNA as a new algorithm for burst assembly on an OBS distributed network," in *SAI Computing Conference*, Jul. 2016, pp. 906–912.
- [98] S. Tang and L. Tan, "Analysis of Blocking Probability of Multi-class OBS with General Burst Size Distribution," *IEEE Communications Letters*, vol. PP, no. 99, 2016.
- [99] V. Vokkarane, J. Jue, and S. Sitaraman, "Burst segmentation: an approach for reducing packet loss in optical burst switched networks," in *IEEE Int. Conf. on Communications (ICC)*, vol. 5, May 2002, pp. 2673–2677 vol.5.
- [100] V. Casares-Giner, "Some teletraffic issues in optical burst switching with burst segmentation," *Electronics Letters*, vol. 52, no. 11, pp. 941–943, 2016.
- [101] P. Pavon-Marino and F. Neri, "On the Myths of Optical Burst Switching," *IEEE Transactions on Communications*, vol. 59, no. 9, pp. 2574–2584, Sep. 2011.
- [102] M. Takagi, H. Li, K. Watabe, H. Imaizumi, T. Tanemura, Y. Nakano, and H. Morikawa, "400Gb/s Hybrid Optical Switching Demonstration Combining Multi-Wavelength OPS and OCS with Dynamic Resource Allocation," in *Optical Fiber Communication Conference and National Fiber Optic Engineers Conference*, no. OTuA6. San diego, California, USA: Optical Society of America, 2009.
- [103] M. Imran and K. Aziz, "Performance evaluation of hybrid optical switching with quality of service," in *Signals and Systems Conference (ISSC)*, Carlow, Ireland, Jun. 2015.
- [104] C. Xin, C. Qiao, Y. Ye, and S. Dixit, "A hybrid optical switching approach," in *IEEE Global Telecommunications Conference (GLOBECOM)*, vol. 7, Dec. 2003, pp. 3808–3812.
- [105] P. Khodashenas, J. Perello, S. Spadaro, J. Comellas, and G. Junyent, "A feedback-based hybrid OBS/OCS architecture with fast-over-slow capability," in *International Conference on Optical Networking Design and Modeling (ONDM)*, Bologna, Italy, Feb. 2011.
- [106] S. Li, M. Wang, H. Overby, E. Wong, and M. Zukerman, "Performance evaluation of a bufferless OBS/OPS network with 1+1 path protection," *IEEE Photonics Technology Letters*, vol. PP, no. 99, 2015.
- [107] X. Yi, W. Shieh, and Y. Ma, "Phase Noise Effects on High Spectral Efficiency Coherent Optical OFDM Transmission," *IEEE/OSA Journal of Lightwave Technology*, vol. 26, no. 10, pp. 1309–1316, May 2008.
- [108] A. Seck, J. Vuong, P. Ramantanis, D. Bendimerad, Y. Frignac, C. Lepers, and B.-E. Benkelfat, "Numerical Investigation of Performance Variability for WDM Transmission Systems using PDM-QPSK channels," in *National Fiber Optic Engineers Conference*, no. JW2A.51. Optical Society of America, 2012.
- [109] J. Renaudier, R. Rios-Müller, P. Tran, P. L. Schmalen, and G. Charlet, "Spectrally Efficient 1-Tb/s Transceivers for Long-Haul Optical Systems," *IEEE/OSA Journal of Lightwave Technology*, vol. 33, no. 7, pp. 1452–1458, Apr. 2015.

- [110] B. Glover, "History of the Atlantic Cable & Undersea Communications." [Online]. Available: <http://atlantic-cable.com/Cables/CableTimeLine/index2001.htm>
- [111] S. Das, G. Parulkar, and N. McKeown, "Why OpenFlow/SDN can succeed where GMPLS failed," in *Eur. Conf. on Opt. Comm. (ECOC)*, Amsterdam, Netherlands, Sep. 2012.
- [112] B. Nunes, M. Mendonca, X.-N. Nguyen, K. Obraczka, and T. Turletti, "A Survey of Software-Defined Networking: Past, Present, and Future of Programmable Networks," *IEEE Communications Surveys and Tutorials*, vol. 16, no. 3, pp. 1617–1634, Third 2014.
- [113] M. Ruffini, D. O'Mahony, and L. Doyle, "Optical IP Switching: A Flow-Based Approach to Distributed Cross-Layer Provisioning," *IEEE/OSA Journal of Optical Communications and Networks (JOCN)*, vol. 2, no. 8, pp. 609–624, Aug. 2010.
- [114] "ONF Overview." [Online]. Available: <https://www.opennetworking.org/about/onf-overview>
- [115] "OpenFlow, Specification." [Online]. Available: <http://archive.openflow.org/wp/documents>
- [116] A. Giorgetti, F. Cugini, F. Paolucci, and P. Castoldi, "OpenFlow and PCE architectures in Wavelength Switched Optical Networks," in *International Conference on Optical Networking Design and Modeling (ONDM)*, Apr. 2012.
- [117] M. Bahnasy, K. Idoudi, and H. Elbiaze, "OpenFlow and GMPLS unified control planes: Testbed implementation and comparative study," *IEEE/OSA Journal of Optical Communications and Networks (JOCN)*, vol. 7, no. 4, pp. 301–313, Apr. 2015.
- [118] "Huawei Unveils Fifth-Generation Optical Network Architecture," Nice, France, Jun. 2014. [Online]. Available: <http://pr.huawei.com/en/news/hw-346641-sdn.htm#.VcHrtvkVfL0>
- [119] D. Kliazovich and F. Granelli, *Introduction: Why Cross-layer? its advantages and disadvantages*. Troubador Publishing Ltd, 2010, pp. 1–32. [Online]. Available: <http://orbilu.uni.lu/handle/10993/9848>
- [120] C. Lai, D. Brunina, B. Buckley, C. Ware, W. Zhang, A. Garg, B. Jalali, and K. Bergman, "First Demonstration of a Cross-Layer Enabled Network Node," *IEEE/OSA Journal of Lightwave Technology*, vol. 31, no. 9, pp. 1512–1525, May 2013.
- [121] J. Sakaguchi, B. Puttnam, W. Klaus, Y. Awaji, N. Wada, A. Kanno, T. Kawanishi, K. Imamura, H. Inaba, K. Mukasa, R. Sugizaki, T. Kobayashi, and M. Watanabe, "305 Tb/s Space Division Multiplexed Transmission Using Homogeneous 19-Core Fiber," *IEEE/OSA Journal of Lightwave Technology*, vol. 31, no. 4, pp. 554–562, Feb. 2013.
- [122] K. Shibahara, D. Lee, T. Kobayashi, T. Mizuno, H. Takara, A. Sano, H. Kawakami, Y. Miyamoto, H. Ono, M. Oguma, Y. Abe, T. Matsui, R. Fukumoto, Y. Amma, T. Hosokawa, S. Matsuo, K. Saitoh, M. Yamada, and T. Morioka, "Dense SDM (12-core 3-mode) Transmission over 527 km with 33.2-ns Mode-Dispersion Employing Low-Complexity Parallel MIMO Frequency-Domain Equalization," *IEEE/OSA Journal of Lightwave Technology*, vol. PP, no. 99, Jul. 2015.

- [123] J. Wallace, "Seven-core optical fiber transmits 255 Tbit/s over 1 km," *Laser Focus World*, Oct. 2014. [Online]. Available: <http://www.laserfocusworld.com/articles/2014/10/seven-core-optical-fiber-transmits-255-tbit-s-over-1-km.html>
- [124] E. Amhoud, E. Awwad, G. Ben-Othman, and Y. Jaouen, "Mode selection and larger set equalization for mode-multiplexed fiber transmission systems," in *Opt. Fiber Comm. Conf. (OFC)*. Los Angeles, CA, USA: IEEE, Mar. 2015.
- [125] D. Siracusa, F. Pederzoli, D. Klondisz, V. Lopezy, and E. Salvadori, "Resource allocation policies in SDM optical networks (Invited paper)," in *International Conference on Optical Networking Design and Modeling (ONDM)*, Pisa, Italy, May 2015, pp. 168–173.
- [126] "Cisco Nexus® 7000 Series Switches combine high levels of scalability with operational flexibility. Data Sheet C78-437762," Cisco®, Tech. Rep., Apr. 2016.
- [127] G. I. Papadimitriou, C. Papazoglou, and A. S. Pomportsis, "Optical switching: switch fabrics, techniques, and architectures," *IEEE/OSA Journal of Lightwave Technology*, vol. 21, no. 2, pp. 384–405, Feb. 2003.
- [128] A. Gupta and R. K. Jha, "A Survey of 5G Network: Architecture and Emerging Technologies," *IEEE Access*, vol. 3, pp. 1206–1232, Aug. 2015.
- [129] Z. Zhang and Y. Yang, "Performance analysis of Optical Packet Switches enhanced with electronic buffering," in *IEEE International Symposium on Parallel Distributed Processing (IPDPS)*, May 2009, pp. 1–9.
- [130] K.-i. Kitayama, Y.-c. Huang, Y. Yoshida, R. Takahashi, and M. Hayashitani, "Optical Packet and Path Switching Intra-Data Center Network: Enabling Technologies and Network Performance with Intelligent Flow Control," in *Eur. Conf. on Opt. Comm. (ECOC)*, Cannes, France, Sep. 2014.
- [131] Z. Pan, H. Yang, J. Yang, J. Hu, Z. Zhu, J. Cao, K. Okamoto, S. Yamano, V. Akella, and S.-J. Ben Yoo, "Advanced Optical-Label Routing System Supporting Multicast, Optical TTL, and Multimedia Applications," *IEEE/OSA Journal of Lightwave Technology*, vol. 23, no. 10, pp. 3270–3281, Oct. 2005.
- [132] C. Okonkwo, C. Almeida Jr, and E. Martin R., "Performance analysis of an Optical Packet Switch with shared Parametric Wavelength Converters," *IEEE Communications Letters*, vol. 12, no. 8, pp. 596–598, Aug. 2008.
- [133] F. N. Baynes, F. Quinlan, T. M. Fortier, Q. Zhou, A. Beling, J. C. Campbell, and S. A. Diddams, "Attosecond timing in optical-to-electrical conversion," *Optica*, vol. 2, no. 2, pp. 141–146, Feb. 2015.
- [134] T. Szigeti and C. Hattingh, "Quality of Service Design Overview," *CISCO Press*, Dec. 2004. [Online]. Available: <http://www.ciscopress.com/articles/article.asp?p=357102>
- [135] M. Gharaei, H. Castel, and M. Lourdiane, "100Gb/s Réseau Internet Adaptative (100GRIA) FUI9 project," Institut Mines Télécom - Télécom SudParis, Tech. Rep., Dec. 2012.

- [136] M. Justin Redd, "Calculating statistical confidence levels for error-probability estimates," *Lightwave Magazine*, vol. 21, no. 5, pp. 110–114, Apr. 2000.
- [137] Y. Yang, "Understanding Switch Latency, nexus-3000-series-switches, white paper c11-661939," Cisco®, Tech. Rep.
- [138] M. Claeys, N. Bouten, D. D. Vleeschauwer, K. D. Schepper, W. V. Leekwijck, S. Latré, and F. D. Turck, "Deadline-aware TCP congestion control for video streaming services," in *Int. Conf. on Network and Service Management (CNSM)*, Oct. 2016, pp. 100–108.
- [139] A. Loukili, A. L. Wijesinha, R. K. Karne, and A. K. Tsetse, "TCP's Retransmission Timer and the Minimum RTO," in *Int. Conf. on Computer Communications and Networks (ICCCN)*, Jul. 2012.
- [140] "Measuring the Information Society Report, 2007-2015," International Telecommunication Union, Tech. Rep., 2015. [Online]. Available: <http://www.itu.int/en/ITU-D/Statistics/Pages/publications/mis2015.aspx>
- [141] M. Pioro and D. Medhi, *Network Management Cycle*, ser. The Morgan Kaufmann Series in Networking. Elsevier Science, 2004, pp. 27–31.
- [142] W. Samoud, C. Ware, and M. Lourdiane, "Investigation of hybrid opto-electronic packet switch connected to SDM fibers considering various traffic distributions," in *Int. Conf. on Transp. Opt. Networks (ICTON)*, no. Tu.D3.6. Trento, Italy: IEEE, Jul. 2016.
- [143] R. Poprawe, I. Kelbassa, and Y. Hagedorn, "Laser Additive Manufacturing LAM - Fundamentals of Selective Laser Melting SLM and Laser Material Deposition LMD," in *Conf. on Lasers and Electro-Optics (CLEO)*, Jun. 2014.
- [144] "Tunable Diode Lasers, Simply Better™ Photonics," Newport, Tech. Rep. [Online]. Available: https://assets.newport.com/webDocuments-EN/images/BR_NF_Tunable_Diode_Lasers.pdf
- [145] "Tunable lasers: overview," ThORLABS, Tech. Rep. [Online]. Available: <https://www.thorlabs.com/catalogpages/540.pdf>
- [146] J. A. Summers, M. L. Masanovic, V. Lal, and D. J. Blumenthal, "Design and Operation of a Monolithically Integrated Two-Stage Tunable All-Optical Wavelength Converter," *IEEE Photonics Technology Letters*, vol. 19, no. 16, pp. 1248–1250, Aug. 2007.
- [147] L. Chen, Y. Liu, S. Zhang, P. Duan, Z. Peng, and Y. Liu, "40 Gb/s optical wavelength converter converting the same wavelength using a single semiconductor optical amplifier," in *Asia-Pacific Conference on Communications*, Oct. 2009, pp. 537–540.
- [148] G. Konstantinos and T. Anna, "The impact of optical wavelength conversion on the energy efficiency of resilient WDM optical networks," in *Int. Conf. on Transp. Opt. Networks (ICTON)*, Jun. 2011.

- [149] "Introduction to EDFA Technology," Finisar Corporation, Sunnyvale, CA, USA, Tech. Rep., Jun. 2009. [Online]. Available: <https://www.finisar.com/sites/default/files/resources/Introduction%20to%20EDFA%20technology.pdf>
- [150] R. Kaur, R. Randhawa, and R. Kaler, "Performance evaluation of optical amplifier for 16×10 , 32×10 and 64×10 Gbps {WDM} system," *Optik - International Journal for Light and Electron Optics*, vol. 124, no. 8, pp. 693–700, 2013.
- [151] N. M. Ibrahim and A. Abubake, "A comparison of optical amplifiers in optical communication systems EDFA, SOA and Raman," *International Journal of Current Research*, vol. 6, no. 9, pp. 8738–8741, Sep. 2014. [Online]. Available: <http://www.journalcra.com/sites/default/files/6286.pdf>
- [152] L. Schares, T. N. Huynh, M. G. Wood, R. Budd, F. Doany, D. Kuchta, N. Dupuis, B. G. Lee, C. L. Schow, M. Moehrle, A. Sigmund, W. Rehbein, T. Y. Liow, L. W. Luo, and G. Q. Lo, "A gain-integrated silicon photonic carrier with SOA-array for scalable optical switch fabrics," in *Opt. Fiber Comm. Conf. (OFC)*, Mar. 2016.
- [153] L. Zhang, H. Jiang, X. Yang, X. Gu, and Y. Feng, "High Power Single Frequency 1336 nm Raman Fiber Amplifier," *IEEE/OSA Journal of Lightwave Technology*, vol. PP, no. 99, 2016.
- [154] G. Bolognini, C. Clivati, D. Calonico, S. Faralli, F. Levi, A. Mura, and N. Poli, "Fiber Raman amplification for metrological transfer of phase-coherent optical frequencies," in *Eur. Conf. on Opt. Comm. (ECOC)*, no. We.1.A.1, Sep. 2013.
- [155] F. Smyth, D. C. Kilper, S. Chandrasekhar, and L. P. Barry, "Applied Constant Gain Amplification in Circulating Loop Experiments," *IEEE/OSA Journal of Lightwave Technology*, vol. 27, no. 21, pp. 4686–4696, Nov. 2009.
- [156] P. J. Lin, "Reducing optical power variation in amplified optical network," in *International Conference on Communication Technology (ICCT)*, vol. 1, Apr. 2003, pp. 42–47.
- [157] A. S. Ahsan, C. Browning, M. S. Wang, K. Bergman, D. C. Kilper, and L. P. Barry, "Excursion-Free Dynamic Wavelength Switching in Amplified Optical Networks," *IEEE/OSA Journal of Optical Communications and Networks (JOCN)*, vol. 7, no. 9, pp. 898–905, Sep. 2015.
- [158] D. A. Mongardien, S. Borne, C. Martinelli, C. Simonneau, and D. Bayart, "Managing Channels Add/Drop in Flexible Networks Based on Hybrid Raman/Erbium Amplified Spans," in *Eur. Conf. on Opt. Comm. (ECOC)*, Sep. 2006.
- [159] K. Ishii, J. Kurumida, and S. Namiki, "Wavelength assignment dependency of AGC EDFA gain offset under dynamic optical circuit switching," in *Opt. Fiber Comm. Conf. (OFC)*, Mar. 2014.
- [160] U. Moura, M. Garrich, H. Carvalho, M. Svolenski, A. Andrade, F. Margarido, A. C. Cesar, E. Conforti, and J. Oliveira, "SDN-enabled EDFA gain adjustment cognitive methodology for dynamic optical networks," in *Eur. Conf. on Opt. Comm. (ECOC)*, no. 0683, Valencia, Spain, Sep. 2015.

- [161] M. Sharma and V. R. Sharma, "Gain flattening of EDFA in C-band using RFA for WDM application," in *Int. Conf. on Signal Processing and Integrated Networks (SPIN)*, Feb. 2015, pp. 346–351.
- [162] D. Verma and S. Meena, "Flattening the Gain in 16 Channel EDFA-WDM System by Gain Flattening Filter," in *Int. Conf. on Computational Intelligence and Communication Networks*, Nov. 2014, pp. 174–177.
- [163] "ITU Grid: C-Band, 100 GHz Spacing," ITU, Tech. Rep. [Online]. Available: <http://www.fiberdyne.com/products/itu-grid.html>
- [164] "Power Booster EDFA - Extending Single-span Network Reach," Finisar Corporation, Sunnyvale, CA, USA, Tech. Rep., Dec. 2012. [Online]. Available: <https://www.finisar.com/sites/default/files/resources/Power%20Booster%20EDFA%20Extending%20single-span%20network%20reach.pdf>
- [165] M. Sharma and V. R. Sharma, "Gain flattening of EDFA in C-band using RFA for WDM application," in *Int. Conf. on Signal Processing and Integrated Networks (SPIN)*, Feb. 2015, pp. 346–351.
- [166] "OCM Specification - version3.4, Part num: OM-1C3BM110," Optoplex Corporation, Tech. Rep., Feb. 2016.
- [167] H. Malik, M. Ghoraishi, and R. Tafazolli, "Cross-layer approach for asymmetric traffic accommodation in full-duplex wireless network," in *European Conference on Networks and Communications (EuCNC)*, Jun. 2015, pp. 265–269.
- [168] S. W. Kau, W. T. Lu, W. P. Chen, T. F. Lee, and C. N. Tsai, "Performance Study of Asymmetric Traffic Load for OBS Ring Networks," in *Intelligent Information Hiding and Multimedia Signal Processing, 2009. IHH-MSP '09. Fifth International Conference on*, Sep. 2009, pp. 226–229.

Performance Analysis of Hybrid Opto-Electronic Packet Switch

Wiem SAMOUD

RÉSUMÉ : La fibre optique demeure le support de transmission le plus utilisé, portant le trafic à une énergie par bit relativement faible. Cependant, à cause de l'absence de mémoire tout-optique pratique, la commutation de paquets est toujours exécutée électriquement. Les conversions Optiques Électriques Optiques (O-E-O) nécessaires font de la commutation l'un des domaines les plus consommateurs d'énergie. Ce problème est de plus en plus important spécialement avec la croissance exponentielle du trafic dans les réseaux optiques. Un défi majeur à prendre en considération dans la conception de réseaux optiques futurs est la restriction de leur consommation énergétique. De ce fait, dans le cadre de cette thèse, nous étudions un commutateur hybride opto-électronique qui consiste en une matrice de commutation optique complétée par une mémoire électronique partagée.

L'analyse de performance prenant en compte différentes classes de service, distributions de paquets et méthodes de connectivité du commutateur (canaux WDM et/ou SDM), montre que, grâce aux stratégies de commutation établies, le commutateur hybride répond aux besoins de toutes les classes de service en termes de taux de perte de paquets, la charge durable du système et la latence. De plus, il réduit significativement les conversions O-E-O par rapport aux commutateurs électriques commercialisés, puisqu'ils n'auront lieu que pour les paquets mis en mémoire d'attente. Nous défendons que le commutateur de paquets hybride opto-électronique satisfait les exigences en qualité de service et pourrait être une solution prometteuse pour réduire la consommation d'énergie des réseaux optiques.

MOTS-CLEFS : Commutation de paquets, Gestion de contention, Composants opto-électronique, Réseaux optiques.

ABSTRACT : Most transmission systems are based on optical fibers, carrying the traffic at a relatively low energy per bit. However, due to the lack of mature optical buffers, packet switching is still performed electrically. The required Optical-Electrical-Optical (O-E-O) conversions make the switching one of the areas with the fastest-growing energy consumption. A major challenge that must be met in designing future optical networks is curbing their energy consumption. Therefore, within this thesis, we investigate a hybrid optoelectronic switch which consists of an optical switching matrix supplemented with a shared electronic buffer.

Performance analysis taking into account different classes of service, packet classifications and switch connectivity methods (WDM and/or SDM channels), shows that, thanks to the established switching strategies, the hybrid switch satisfies the requirements of all the different classes of service in terms of Packet Loss Rate, sustainable system load and latency. Moreover, it significantly reduces the O-E-O conversions compared to commercial off-the-shelf electrical switches, since they occur only for buffered packets. We defend that the hybrid opto-electronic packet switch meets the requirements on quality of service and could be a promising solution to reduce the energy consumption of optical networks.

KEY-WORDS : Packet switching, Contention resolution, Opto-electronic components, Optical networks.

