



HAL
open science

Visible light and radio communication for cooperative autonomous driving: applied to vehicle convoy

Mohammad Abualhoul

► **To cite this version:**

Mohammad Abualhoul. Visible light and radio communication for cooperative autonomous driving: applied to vehicle convoy. Automatic. Université Paris sciences et lettres, 2016. English. NNT: 2016PSLEM084 . tel-01734504

HAL Id: tel-01734504

<https://pastel.hal.science/tel-01734504>

Submitted on 14 Mar 2018

HAL is a multi-disciplinary open access archive for the deposit and dissemination of scientific research documents, whether they are published or not. The documents may come from teaching and research institutions in France or abroad, or from public or private research centers.

L'archive ouverte pluridisciplinaire **HAL**, est destinée au dépôt et à la diffusion de documents scientifiques de niveau recherche, publiés ou non, émanant des établissements d'enseignement et de recherche français ou étrangers, des laboratoires publics ou privés.

THÈSE DE DOCTORAT

de l'Université de recherche Paris Sciences et Lettres
PSL Research University

Préparée à MINES ParisTech

COMMUNICATIONS PAR LUMIÈRE VISIBLE ET RADIO POUR LA CONDUITE COOPÉRATIVE AUTONOME:

application à la conduite en convois

— — —

VISIBLE LIGHT AND RADIO COMMUNICATION FOR COOPERATIVE AUTONOMOUS DRIVING:

applied to vehicle convoy

École doctorale n° 432

SCIENCES ET MÉTIERS DE L'INGÉNIEUR

Spécialité MATHÉMATIQUES, INFORMATIQUE TEMPS-RÉEL, ROBOTIQUE

Soutenue par **Mohammad ABUALHOUL**
le 21 Décembre 2016

Dirigée par **Fawzi NASHASHIBI**

COMPOSITION DU JURY :

M. Samir TOHME
UVSQ & Vedecom, Président

M. Luc CHASSAGNE
Université de Versailles, Rapporteur

M. Alexey VINEL
Université de Halmstad, Rapporteur

M. Razvan STANCIA
INSA de Lyon, Examineur

M. Fawzi NASHASHIBI
INRIA, Examineur

Mme. Oyunchimeg SHAGDAR
Vedecom, Examineur



Abstract

With the extensive development of automobile industry and the popularity of using personal road vehicles in the last decade, both traffic accidents and road congestion levels have rapidly increased. Researchers have shown that the significant number of traffic accidents are mainly due to the inability and slow responses of drivers to take the right actions on time, together with the misleading predictions. Taking advantage of the advanced wireless communications to enable Cooperative Intelligent Transportation Systems (**C-ITS**) can improve road fluidity and driver comfort. Ensuring the safety requirements has been the primary interest of the standardization societies dedicated to developing **C-ITS** applications, in particular with the expected significant demand for a broad range of applications targeting these strict safety requirements. Radio Frequency (**RF**) communication technology deploying IEEE 802.11p standard for vehicular applications have been dedicated to facilitating relatively medium communication range that supports high data rate for the vehicular environment, where the technology meant to operate within the road safety requirements level.

As a consequence of the accelerated increase of the wireless-based communication devices numbers for Intelligent Transport Systems (**ITS**) applications, the **RF** communication solutions are pushed toward an insatiable demand for wireless networks data access and a remarkable increase in both latency and channel congestion levels. This instability introduced more usage constraints when **C-ITS** is required. An example of such applications where the safety requirements and usage constraints might be strictly sharp are the convoy-based **ITS** applications.

The reliability of these applications highly depends on the quality of the Vehicle-to-Vehicle (**V2V**) communication link, therefore, understanding the safety requirements for **ITS** applications and investigating the limits of the existing communication solutions are extremely important.

Several solutions and supportive communication technologies were proposed to overcome the usage constraints of the RF technology for C-ITS applications. Suggested solutions were the specific diversity techniques as in directional and smart antennas. Other solutions suggest the use of independent communication medium such as Infra-Red (IR), Visible light communication (VLC). By realizing both low-cost implementation and dual functionality, VLC has become an outstanding intriguing supportive technology by using the vehicular existed infrastructure, (*e.g.* rear and front lamps) as transmission units. However, very few effort have been made to extend and address this technology to particular ITS applications that take into consideration the real-world environment and the optical channel characteristics.

This thesis effort contributes to the autonomous vehicular communication and urban mobility improvements. The work addresses the main radio-based V2V communication limitations and challenges for ITS hard-safety applications and intends to deploy the vehicular lighting system as a supportive communication solution for platooning of IVC-enabled autonomous vehicles. The ultimate objectives of this Ph.D. research are to integrate the VLC system within the existing C-ITS architecture by developing a VLC prototype, together with sufficient hand-over algorithms enabling VLC, RF, and perception-based solutions in order to ensure the maximum safety requirements and the continuous information exchange between vehicles. The feasibility and efficiency of the VLC-RF system implementation and hand-over algorithms were subjects to deep investigations over six self-contained chapters meant to facilitate a logical progression of materials and to enable a relatively easy access. In addition to the improvement in road capacity by utilizing the convoy-based autonomous driving systems. The carried out simulations followed-up by experimental results proved that the integration of VLC with the existed RF solutions lead to a definite benefit in the communication channel quality and safety requirements of a platooning system when a proper hand-over algorithm is utilized.

Résumé

Avec le développement sans précédent du secteur de la construction automobile et la montée spectaculaire de l'utilisation des véhicules dans les quatre coins du monde, ce dernier siècle a connu une augmentation flagrante du nombre des accidents de circulation ainsi que le phénomène de congestion routière.

Les recherches scientifiques investiguant ce phénomène ont montré que ce nombre alarmant des accidents routiers est dû principalement à l'incapacité du conducteur ou sa réponse tardive à prendre à temps les décisions appropriées ou aussi à des fausses prédictions de sa part.

Avec l'avènement des communications sans fil et leur remarquable prolifération, les entités de standardisation sont de plus en plus intéressées à l'utilisation de ces technologies de pointe dans le but d'améliorer la sécurité des routes, le confort du conducteur ainsi que la fluidité de la circulation. Cet intérêt est guidé aussi par la capacité de ces technologies sans fil à satisfaire les exigences de sécurité routière surtout avec un avènement attendu de futures applications exigeant des conditions de sécurité très strictes.

D'autre part, la technologie sans fil IEEE 802.11p dédiée aux applications véhiculaires a été mise en place afin de faciliter les communications véhiculaires à longue portée et en offrant aussi des débits de données importants. Malgré que cette technologie a été conçue pour pouvoir fonctionner sans faire atteinte aux normes de sécurité routière requises dans un réseau de véhicules, nous assistons aujourd'hui à une augmentation remarquable des délais de bout en bout au niveau des applications ainsi qu'une congestion fulgurante des canaux de transmission ce qui met en cause l'efficacité de cette norme dédiée à de tels scénarios. Par conséquent, cette fragilité des communications sans fil limite son utilisation dans des scénarios d'applications nécessitant des contraintes de sécurité très strictes comme le cas de l'application de "platoon".

En effet, la fiabilité de cette application dépend fortement de la qualité du lien des communications Véhicule-à-Véhicule (V2V). Cette fiabilité est de plus en plus forte si les conditions requises par cette application en termes de délai, de succès de transmission, etc sont satisfaites. Ainsi, il devient primordial de bien étudier les exigences requises par chaque application et aussi de s'intéresser aux limites des solutions de communication existantes.

D'autre part, d'autres technologies de communication, basées sur différents médias de communication, comme la technologie VLC (Communication par lumière visible) attirent de plus en plus l'attention de la communauté de recherche ces dernières années. En effet, non seulement la technologie VLC assure une implémentation à faible coût ainsi qu'une double fonctionnalité, mais aussi cette technologie basée sur des impulsions lumineuse permet d'utiliser l'infrastructure déjà existante sur le véhicule à savoir les lampes d'arrière et frontales comme des unités de transmission et ainsi réduire les coûts de fonctionnement.

Cependant, très peu d'efforts scientifiques ont été effectués pour développer l'utilisation de cette technologie dans le cadre des systèmes de transport intelligents ITS et étudier l'impact des conditions environnementales et les caractéristiques du canal optique sur les performances des applications véhiculaires basées sur cette technologie.

Ainsi, nous nous intéressons à travers ce manuscrit aux communications dans un réseau de véhicules autonomes et leurs impacts sur l'amélioration de la mobilité urbaine. Dans cette perspective, ce travail traite tout d'abord les limitations des communications sans fil dans un réseau de véhicules dans le contexte des applications de sécurité routière à hautes exigences. Il met aussi en lumière l'intérêt de l'utilisation de la technologie VLC comme un moyen de soutien pour l'application de "platoon" dans le contexte des véhicules autonomes communicants. L'objectif primordial de ces travaux de recherches est d'intégrer le système de communication VLC dans l'architecture ITS, dédiée aux communications véhiculaires sans fil et déjà existante, afin de bâtir un système de communication plus robuste. Cette intégration nécessite le développement de nouvelles techniques au niveau de la couche MAC et la couche physique, ainsi que la conception de nouveaux algorithmes de handover permettant une transition transparente entre différentes solutions de communication inter-véhiculaires (VLC, communication sans fil, techniques de perception). Le but louable de cette intégration est d'assurer au maximum les exigences de sécurité requises par les applications ainsi que l'échange continue de l'information entre les véhicules dans différents scénarios de communication.

L'efficacité ainsi que la faisabilité de ces algorithmes ont été validées à travers de nombreuses simulations ainsi que des test-bed réels au cours desquels nous avons considéré l'application de conduite automatisée. Ces différentes méthodes de validation ont permis de confirmer l'efficacité de notre approche et ont démontré que les techniques proposées permettent clairement d'améliorer la qualité du canal de transmission ainsi que la satisfaction des exigences de sécurité relatives à l'application de "platoon" en utilisant conjointement les technologies de communication [VLC](#) et sans fil.

Contents

1	General Introduction	1
1.1	Background and motivations	2
1.2	Main contributions	5
1.3	Manuscript organization	7
1.4	List of publications	8
2	State of the Art	9
2.1	Radio communication for ITS	11
2.1.1	Research projects	14
2.1.2	Use cases and application scenarios	16
2.1.2.1	Applications for traffic safety	17
2.1.2.2	Applications for traffic efficiency and management	18
2.1.3	Radio communication requirements & challenges for vehicular cooperative systems	19
2.2	Optical communication for ITS	21
2.2.1	Research projects	27
2.2.2	VLC use cases and application scenarios for ITS	29
2.2.3	Issues impacting outdoor VLC	30
2.3	Handover between VLC and RF technologies	31
2.4	Problem formulation	32
2.5	Conclusion	38
3	Modeling VLC for a Platoon of autonomous vehicles	41
3.1	Introduction	42
3.2	VLC channel model for ITS applications	43
3.2.1	VLC channel path-loss (DC gain)	44
3.2.2	VLC noise model for outdoor applications	45
3.3	Platoon control model	47
3.3.1	Kinematic model	47

3.3.2	Longitudinal and lateral control	48
3.4	Performance evaluation	49
3.4.1	Optical channel performance	50
3.4.2	Platoon control performance	51
3.5	Enhancing the field of view limitation	56
3.5.1	Proposed solution to enhance the FOV limitation	56
3.5.2	Performance evaluation	59
3.6	Conclusion	62
4	VLC prototype development and evaluation for platooning	65
4.1	Introduction	67
4.2	General system description	67
4.3	VLC system implementation	68
4.3.1	System hardware	69
4.3.1.1	VLC transmitter	69
4.3.1.2	VLC receiver	78
4.3.2	System software	86
4.3.2.1	Data encoding	87
4.3.2.2	Mchr3k Arduino manchester encoding library	88
4.3.2.3	Data payload	88
4.3.2.4	Hardware interface	89
4.3.2.5	RTMaps components	90
4.4	VLC prototype evaluation	91
4.4.1	Experimental setup	91
4.4.2	VLC link experimental results	94
4.4.2.1	Prototype calibration	94
4.4.2.2	VLC path-loss model evaluation	96
4.4.2.3	Packets transmission evaluation	98
4.5	Conclusion	101
5	Handover proposals for platooning application	103
5.1	Introduction	104
5.2	Laser-based perception and VLC	107
5.2.1	LRF-VLC system configuration for platooning applic- ation	109
5.2.1.1	Laser Based Detection Model	111
5.2.1.2	Visible Light Communication Model	112
5.2.2	Handover between ACC and CACC using LRF-VLC	113
5.2.3	Platforms Architecture	116
5.2.3.1	VLC Platform	116
5.2.3.2	Pro-SiVIC Platform	117
5.2.4	Performance evaluation	118
5.2.4.1	Straight driving scenario	119
5.2.4.2	Lane-change scenario	119

5.2.4.3	Curve scenario	120
5.3	Radio communication and VLC	123
5.3.1	Conventional VHO existing schemes	124
5.3.2	RF congestion problem	128
5.3.3	RF-VLC system configuration and assumptions for platooning application	132
5.3.4	RF-VLC switching key metrics for platooning	134
5.3.5	Prediction-based VHO method for platoon application	135
5.4	Conclusion	143
6	Conclusion and future research perspective	145
6.1	Conclusion and remarks	145
6.2	Research perspective and future work	149

List of Figures

1.1	Cooperative Intelligent Transportation System (C-ITS). Besides road transportation system, air transportation, rail transportation, and marine transportation are parts of the intelligent transportation system. [1].	3
2.1	Channel allocation and usage for IEEE 802.11p according to FCC/ECC	12
2.2	CAMs and DENMS delivery in IEEE 802.119, messages are regionally broadcast through V2V communication	14
2.3	Communication-based platoon control system has the requirements of both traffic safety and efficiency applications	17
2.4	Electromagnetic spectrum usage. {VLC Spectrum range between $(4 \times 10^{14} \text{ Hz} - 8.5 \times 10^{14} \text{ Hz})$ }	22
2.5	One of the first Basic Study suggesting to use VLC for traffic information systems.	24
2.6	CAMs and DENMS delivery in IEEE 802.119, messages are regionally broadcasted through V2V communication	25
2.7	The relative intensity of VLC spectrum, and the Spectral response of a typical photodetector receiver responsivity.	26
2.8	The main use cases of VLC technology in ITS, First use is the I2V broadcast from traffic lights to vehicles, the second use is the IVC between adjacent vehicles forming a short range communication link between any vehicle formation.	29
2.9	Platoon's communication information flow, a broadcasted CAM periodic messages is required to pass the leader vehicle speed and acceleration together with any DENMs, where a point-to-point link is required to pass the proceeding vehicle acceleration for string stability desired acceleration by the <i>ith</i> vehicle CAMs	34

2.10	Comparison between various packet intervals and sizes for vehicular communication. (a) various packet intervals for Bitrate = 6 Mbps, Packet size = 500 bytes. (b). various packet intervals for Bitrate = 6 Mbps, Packet size = 200 bytes.	36
2.11	NS3 Simulation results of Scenario I and Scenario II illustrated in Chapter 5.	37
3.1	General illustration of the VLC concept.	43
3.2	V2V optical communication system for V2V, where ψ and φ represents both incidence and irradiance angles respectively, d is the inter-vehicle-distance.	44
3.3	Plan view for a platoon of two vehicles (Leader and Follower) which have the longitudinal (Δx) and lateral (Δy) inter-vehicle distances.	48
3.4	Circle trajectory between the follower vehicle's position (X_F, Y_F) and the leader vehicle's position (X_L, Y_L) with a constant steer angle δ	50
3.5	Performance of the optical wireless channel for the three main parameters as a function of BER and the platoon inter-vehicle distance. a. Incidence Angle (φ) effect, b. Electrical Bandwidth limitation. c. Ambient Noise Power P_{bg} influence for different day time. d. represent the optimal parameter values to achieve stable VLC communication for inter-vehicle distance up to 7 meters.	52
3.6	SIMULINK Platooning control using VLC model.	53
3.7	Four vehicles platoon model in <i>SIMULINK</i> for two trajectories. Trajectory 1 illustrates the success scenario when the queued vehicle fall in the FOV of each other. Trajectory 2 illustrates the failure scenario when the trajectory curvature will cause out of FOV.	54
3.8	Incidence and Irradiance angles variations over both success and failure trajectories for 4 platooned vehicles.	55
3.9	Two vehicles VLC-based platoon ray tracing model.	57
3.10	VLC-based Platoon SIMULINK model for four vehicles, each vehicle consist of longitudinal controller, lateral controller, VLC model for path loss calculation and an a FOV enhancement controller.	59
3.11	The angular variation of the vehicle front (θ_F), vehicle rear (θ_R), incidence compensation angle (ψ_x), irradiance compensation angle (φ_x), incidence angle (ψ) and irradiance angle (φ) between every two members in the VLC-based platoon and following trajectory 2 in Figure 3.12.	60

3.12	The angular variation of the vehicle front (θ_F), vehicle rear (θ_R), incidence compensation angle (ψ_x), irradiance compensation angle (φ_x), incidence angle (ψ) and irradiance angle (φ) between two members in the VLC-based platoon following trajectory 3 in Figure 3.12.	61
3.13	Four vehicles platoon model in SIMULNK for three different trajectories. Trajectory 1 illustrate the success scenario when the queued vehicle fall in the FOV of each other. Trajectory 2 and 3 illustrate the failure scenario before applying the enhancement method and when the θ_F or θ_R are exceeding θ_c limits. Both coordinates represented in meter.	62
3.14	Four vehicles platoon model in SIMULNK for three different trajectories. Trajectory 1,2 and 3 illustrate the success scenario when the FOV enhancement method is applied, where θ_F and θ_R never exceeding θ_c . Both coordinates represented in meter.	63
4.1	General description of the proposed communication system between platoon members using both VLC and RF communications in order to reduce channel congestion.	68
4.2	High-level overview of the VLC electrical and optical stages.	69
4.3	VLC transmitter LEDs head content.	70
4.4	Schematic diagram for the VLC transmission unit, the schismatic shows the wiring of the LEDs array with a switching circuit that is controlled by an arduino board and powered by an independent power source.	71
4.5	The basic structure of an LED	72
4.6	LED lampertian emission pattern and the FOV represented by the angle ϕ and the index m	73
4.7	VLC transmitter LED head content	74
4.8	LED light emitting angular radiation lampertian emission pattern and the FOV represented by the angle ϕ and the index m	75
4.9	MOSFET switching transistor for VLC transmitter	76
4.10	DC to DC Step-down 700mA current driver	78
4.11	The VLC receiver unit main components: an optical filter, PD, trans-impedance amplifier, decision circuit and an Arduino micro-controller.	78
4.12	The basic structure of a PD	80
4.13	Response curve of the PDA10A Photo detector	81
4.14	FL635 Bandpass optical filter stage passing 625nm – 645nm of the whole visible light spectrum.	82
4.15	THORLAB FL635 optical filter transmission and optical density.	84

4.16	PDA10A device from THORLABS, Photodetector combined with a transimpedance amplifier.	85
4.17	Decision circuit used to define the VLC receiver sensitivity and threshold level. (a) the actual LM393 dual voltage comparator circuit digram, (b) the LM393 chip mounted on mini brad-board for prototyping usage.	85
4.18	(a). Manchester bit representation for digit 1 (b). Manchester bit representation for digit 0.	87
4.19	Sequence of binary data coded using Manchester line coding.	87
4.20	General Packet format used in VLC for intra-platoon communication, the packet sending a vehicular status such as (ID's, speed, steering, and vehicular coordinations).	89
4.21	VLC system interface components.	90
4.22	The experimental setup to evaluate the VLC prototype performance in daytime conditions.	92
4.23	The three main zones where the VLC receiver was placed to evaluate the received signal with respect to the variation of direct distances changes.	93
4.24	VLC transmitter and receiver ends, (a) Transmitter LED array with the driving circuit, (b) The receiver decision circuit (c) Receiver optical filter mounted over the PD (PDA10A)	93
4.25	Optical received signal results used to calibrate the VLC receiving unit. The calibrations meant to adjust the sensitivity of receiver to achieve detectable signal for link range of 30 meters.	95
4.26	SNR results used to calibrate the VLC receiving unit. The calibrations meant to adjust the gain level at receiver end to achieve SNR of 20 for max link range of 30 meters	96
4.27	Empirical estimation of the VLC link Path-loss exponent, $A_{50dB} = 432.0479$, $n_{50dB} = 1.996$, $A_{40dB} = 139.4479$, $n_{40dB} = 1.99$	97
4.28	Packet Delivery Ratio (PDR) of the VLC platform for 40 dB gain.	99
4.29	The packet inter-reception time (PiT) performance of the VLC platform for 40 dB gain.	100
4.30	The throughput performance of the VLC platform for 40 dB gain.	101
5.1	General concept of deploying RF communication, VLC, and sensor-based solution to improve the platoon system driving safety.	105
5.2	General flow chart of the two main handover algorithms used to enable platoon control using LRF, VLC and RF technologies.	106
5.3	The use of VLC and LRF systems for platooning application.	108

5.4	LRF-VLC system configuration for a platoon of autonomous vehicles.	110
5.5	Laser based preceding vehicle detection and VLC for two platoon members. L represent the vehicle length and W_{Area} is width of the laser detection area of interest. ψ and φ are VLC incidence and irradiance angles.	112
5.6	Flow chart of the handover between ACC and CACC driving modes using the LRF and VLC technologies.	114
5.7	General Packet format used in VLC for intra-platoon communication, the packet sending a vehicular status such as (ID's, speed, steering, and vehicular coordinations).	116
5.8	Pro-SiVIC simulation platform.	117
5.9	Simulation results of Straight driving platoon scenario. laser based detection confidence $C=100\%$	119
5.10	Simulation results of Lane-change driving platoon scenario. laser based detection confidence $C=100\%$	120
5.11	Pro-SiVIC simulation case for 90° curvature scenario, the platoon leader vehicle locate at the edge of the LRF of the follower vehicle.	121
5.12	Simulation results of Curve driving platoon scenario.	121
5.13	PDR and C Simulation result of Curve driving platoon scenario.	122
5.14	Flow diagrams show the two basic VHO schemes. (a) Classic immediate vertical handover (IVHO) diagram between VLC and RF. (b) Dwell vertical handover (D-VHO) diagram with a disconnection waiting period τ_{disc}	125
5.15	IVHO switching stages between VLC and RF.	126
5.16	D-VHO switching stages between VLC and RF.	127
5.17	Four lanes simulation scenarios in NS3: Scenario I enables RF communication broadcast for all vehicles. Scenario II enables RF broadcast for all vehicles except platoon followers, assuming VLC is used as IVC between platoon members.	129
5.18	PDR Simulation results of Scenario I and Scenario II.	130
5.19	The relation between CBR and PDR for different vehicular densities.	131
5.20	RF-VLC communication system for platooning application.	132
5.21	Prediction-based VHO switching stages between VLC and RF.	136
5.22	Two vehicles VLC-based platoon ray tracing model.	137
5.23	The relation between prediction angle θ_p and vehicle velocity v	138
5.24	Flow diagrams explain the PVHO algorithm outputs.	142

List of Tables

2.1	Inter-vehicle distances for different traffic conditions	11
2.2	Cooperative awareness message CAM	13
2.3	Decentralized environmental notification message DENM . . .	13
2.4	The high priority safety applications	18
2.5	VLC Modulation Schemes and Characteristics	25
2.6	Demonstrated performance of high-speed VLC systems	27
2.7	Mathematical Formulations description of equation 2.4	35
2.8	Comparison of VLC and RF communication technology [2] . . .	39
3.1	Simulation Model Parameters	46
4.1	Inter-vehicle distances for different traffic conditions	76
4.2	TIP122 MOSFET Transistor characteristics used for VLC transmitter unit	77
4.3	PDA10A Electrical specifications	82
4.4	Experimental parameters	94
5.1	Experimental parameters	118
5.2	Mobility and communication parameters for multi-lane vehicu- lar distribution	129

List of Acronyms

ABS	Anti-Blocking Systems
ACC	Adaptive Cruise Control
ADC	Analog to Digital Converter
AGC	Automatic Gain Control
AIFS	Arbitration Inter Frame Spacing
AP	Access Point
APD	Avalanche Photodiode
AWGN	Additive White Gaussian Noise
BBB	Beagle-Bone-Board
BER	Bit Error Rate
C2C-CC	Car-to-Car Communication Consortium
C2X	Car-to-Any
CACC	Cooperative Adaptive Cruise Control
CALM	Continuous Air interface for Long and Medium distance
CAM	Cooperative Awareness Message
CBR	Channel Busy Ratio
C-C	Convolutional Codes
CCH	Control Channel
CICAS	Cooperative Intersection Collision Avoidance Systems
CISS	Cooperative Intersection Safety System
C-ITS	Cooperative Intelligent Transportation Systems
COMeSafety	Communications for Electronic Safety
COMeSafety	Communications for Electronic Safety
COOPERS	Cooperative Systems for Intelligent Road Safety
CSK	Color Shift Keying
CSMA/CA	Carrier Sense Multiple Access with Collision Avoidance
CVIS	Cooperative Vehicles Infrastructure Systems
CW	Contention Window

DCC	Decentralized Congestion Control
DENM	Decentralized Environmental Notification Message
DMT	Discrete Multitone
DSRC	Direct Short Range Communication
DSSS	Direct Sequence Spread Spectrum
D-VHO	Dwell Vertical Handover
ECC	Electronic Communications Committee
EDCA	Enhanced Distribution Channel Access
EIFS	Extended Inter-Frame Space
eSafety	Electronic Safety Initiative
ESP	Electronic Stability Control
ETSI	The European Telecommunications Standards Institute
EU	European Union
FCC	Federal Communication Commission
FEC	Forward Error Correction
FOV	Field of View
FPGA	Field Programmable Gate Array
GeoNet	GeoNet - European Project
GPS	Global Positioning System
HHO	Horizontal Handover
HLED	High-Power Light Emitting Diode
I2V	Infrastructure to Vehicle
ICR	instantaneous center of rotation
IDM	Intelligent Driver Model
INRIA	French Institute for Research in Computer Science and Automation
INTERSAFE-2	Inter Safe 2 European project
IoT	Internet of Things
IR	Infra-Red
iTETRIS	Integrated Wireless and Traffic Platform for Real-Time Road Traffic Management Solutions
ITS	Intelligent Transport Systems
IVC	Inter-Vehicle Communication
IVHO	Immediate Vertical Handover
JEITA	Japan Electronics and Information Technology Industries Association
LED	Light Emitting Diode
Li-Fi	Light Fidelity
LoS	Line-of-Sight
LRF	Laser Range Finder
LTE	Long-Term Evolution
MAC	Medium Access Layer
MT	Mobile Terminal

MOSFET	Metal Oxide Semiconductor Field Effect Transistor
NRZ	Non-Return to Zero
NS3	Network Simulator 3
OFDM	Orthogonal Orthogonal Frequency Division Multiplexing
OOK	On-Off-Keying
OW	Optical Wireless
PiT	Packet inter-reception Time
PD	Photo Diode
PDR	Packet Delivery Ratio
PHY	Physical Layer
PI	Proportional Integral
PIN	silicon-based Positive Intrinsic Negative
PPM	Pulse Position Modulation
PRE-DRIVE C2X	Preparation for driving implementation and evaluation of C2X communication technology - European Project
PREVENT	Preventive and Active Safety Applications
PVHO	Prediction Vertical Handover
PWM	Pulse Width Modulation
QAM	Quadrature Amplitude Modulation
QoS	Quality of Service
RF	Radio Frequency
RITS	Robotic Intelligent Transport Systems
RS	Reed Solomon
SAFESPOT	SafeSpot - European Project
SCH	Service Channels
SNR	Signal-to-Noise Ratio
SoC	System on Chip
USDOT	United States Department of Transportation
UWB	Ultra Wideband Band
V2I	Vehicle-to-Infrastructure
V2V	Vehicle-to-Vehicle
V2X	Vehicle-to-Any
VANET	Vehicular Ad-hoc Network
VHO	Vertical Handover
VII	Vehicle Infrastructure Integration
VLC	Visible light communication
VLCC	Visible Light Communications Consortium
VPPM	Variable pulse position Modulation
VSC	Vehicle Safety Communications
VSC-A	Vehicle Safety Communications Applications
WAVE	Wireless Access in Vehicular Environments

WHO	World Health Organization
WiFi	Wireless Fidelity
WLAN	Wireless LAN

CHAPTER 1

General Introduction

Contents

1.1	Background and motivations	2
1.2	Main contributions	5
1.3	Manuscript organization	7
1.4	List of publications	8

Résumé du chapitre

La thèse est structurée en six chapitres autonomes afin de faciliter une description progressive des différentes contributions et de permettre un accès relativement facile. Les efforts de l'auteur sont dédiés à la recherche et à l'évaluation d'une solution supportive pour la technologie de communication de type RF et visent à l'amélioration de la performance de l'application visée. Pour cette raison, des études théoriques sur les modèles des canaux des technologies VLC et RF, l'implantation du système et les évaluations ont été réalisées en tenant compte d'analyse de la qualité de communication pour des différentes conditions de trafic. L'équipe de communication de RITS, délibère sur les défis majeurs de la conception de la technologie, en exécutant conjointement les deux fonctions simultanément : la communication VLC et RF avec les systèmes basés sur la perception pour les applications de conduite autonome basées sur convois. En plus de l'introduction générale dans ce chapitre, chaque sous chapitre commence avec une présentation et une discussion appropriées, appuyée par une analyse théorique, de simulations et des détails de mise en œuvre appropriés. Ce chapitre d'introduction présente les concepts de base de la thèse avec les principales contributions, les organisations de manuscrits et la liste de publications de l'auteur.

1.1 Background and motivations

The concept of vehicular collaboration by exchanging information with either roadside units or/and other vehicles is essential for various types of applications in Intelligent Transport Systems (ITS). The technologies incorporated into the concept of sharing information, known as Cooperative Intelligent Transportation Systems (C-ITS), which aims to lessen the environmental impact of transportation, reduce roads congestion and on the top of all, decrease the number of roads accidents significantly. Ensuring reliable vehicular communications that can suffice the safety requirements was always the highest priority for any C-ITS application. According to the World Health Organization (WHO), only in 2015, there was about 1.25 million pedestrian, and vehicle driver reported deaths due to traffic accidents [3]. The same statistics also estimate a substantial administrative cost of nearly 3% of the Global GDP [3] due to these accidents.

Moreover, the latest estimations report more than 1 billion registered functioning motor vehicles worldwide, and the number is expected to be doubled within the next ten years. As a result, new challenges and series of critical concerns are becoming even more severe in modern ITS, such as traffic congestion, driving comfort, energy waste, and pollution. For instance, in the USA alone, the related traffic losses are estimated to be more than 100 billion US-dollar annually due to wasted fuel and lost time due to the traffic jam problems [4].

Among the many listed C-ITS communication types as shown in Figure 1.1. Vehicle-to-Vehicle (V2V), and Vehicle-to-Infrastructure (V2I) communications are considered the cornerstone to enable a variety of road vehicular safety applications as well as traffic efficiency, driver assistance, and driving comfort.

Besides non-safety applications, most of the solution proposals for ITS safety applications are considering the radio-based communication technology. Examples of such applications are vehicle breakdown, obstacle detection, lane departure warning, accident warning, collision warning, turnover warning, work zone warning, and many other applications as the large list of possible ITS safety applications already described in [5].

One such application where C-ITS considered to be vital is the convoy-based applications such as platooning, where the traffic is arranged into groups of close-following vehicles called convoys or platoons. The most widely studied platoon formation is the line-shape, more known as road trains. By relying on C-ITS and applying strict safety requirements, platooning can allow vehicles to drive in a closer inter-vehicle distance with the same relative

speed, which directly improves both traffic homogeneity and throughput. Moreover, enhancing the driving safety due to small speed variation and relatively very short response time especially in fully autonomous driving mode.

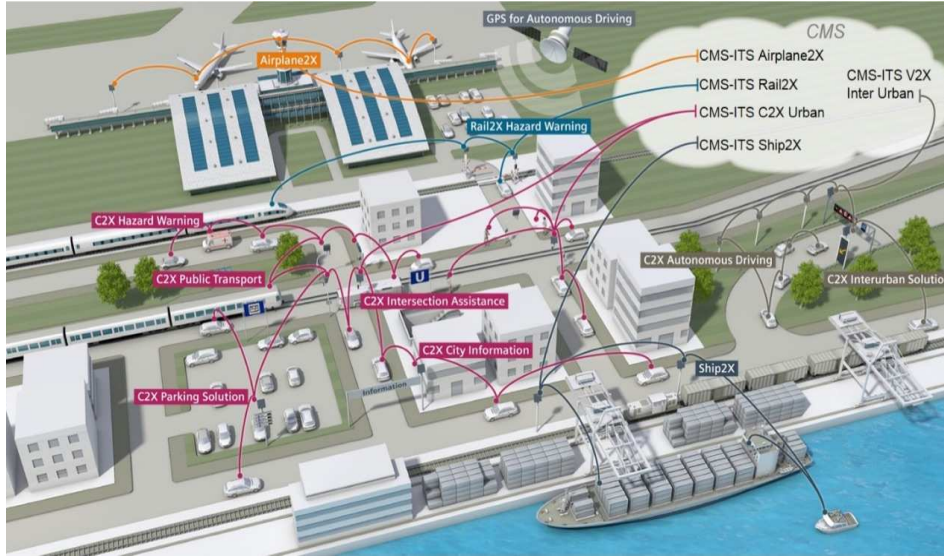

Figure 1.1: Cooperative Intelligent Transportation System (C-ITS). Besides road transportation system, air transportation, rail transportation, and marine transportation are parts of the intelligent transportation system. [1].

Meanwhile, the increased number of both **ITS** safety and non-safety applications, and the use of the same communication medium indistinguishable by both types of applications have triggered a tremendous wireless spectrum demands, where the wireless devices are expected to dominate the roads data traffic soon [6]. Recent reports show that accommodating the rapid growing demand for wireless spectrum does not seem possible in the long run [7] [8].

In addition to the reported constraints and challenges of using Radio Frequency (**RF**)-based communication, especially with the presence of high vehicular dense (as it will be detailed in the subsequent chapters), **RF** spectrum is getting tight and expensive, where the push toward more wireless bandwidth is driving wireless technologies into alternative or supportive spectrum bands. Optical Wireless (**OW**) communication technology has been one of these technologies operating as complementary to the traditional **RF**.

In particular, Visible light communication (VLC) among the many technologies supported by OW is becoming a candidate for short-range communication solutions. Recent research explored the potentials to deploy VLC technology in several contexts, including indoor and outdoor applications, such as high-speed mobile communication, traffic management systems, in-flight entertainment, underwater communication and localization [9].

Thus far, the concept of using communication to enhance the platoon performance has been widely studied [10]. A large number of efforts, techniques, and configurations of the Vehicular Ad-hoc Network (VANET)s have been carried out. Most of these proposals are either too complicated for the context or unsatisfactory for the purpose of safety in high dense conditions, which is the exact platoon circumstances.

This thesis is motivated by all the mentioned strict requirements for hard-safety application in ITS (detailed in subsequent chapters), and the requirements for a simple conception and implementation of new supportive communication technology between platoon members.

The thesis efforts are dedicated to finding and evaluate a supportive solution for the RF communication-based technology and aiming to improve the performance of the application of particular interest. For this reason, theoretical studies on channel models of VLC and RF technologies, system implantation, and evaluations were conducted, taking into account the communication quality analysis for different traffic conditions. We at Robotic Intelligent Transport Systems (RITS) communication team, deliberate on key challenges involved in designing technology jointly performing the two functions simultaneously: VLC and RF communication together with perception-based systems for convoy-based autonomous driving applications.

1.2 Main contributions

This thesis tackles the vehicular communication and the safety requirements for **ITS** applications. The latest studies on the performance of the standardized vehicular communication technologies raised significant challenges concerning the latency of safety application. Moreover, issues such as limited bandwidth, coupled with unreliable wireless links and channel congestion urged toward the need for new communication mediums. The thesis proposes the use of **VLC** as supportive communication technology for the platooning of autonomous vehicles, which intended to reduce the load from radio channel and ensure the safety requirements.

The main research contribution of this work is to implement a **VLC** platform and develop a suitable hand-over algorithm can maximize the overall communication quality for platooning. Particularly, the implementation of **RF-VLC** and sensor-based-**VLC** systems aims to benefit from the presence of two independent communication mediums and sensors data. The key contributions are summarized as follows:

★ **Contribution 1: Analytical study dedicated to investigate the **VLC** feasibility and challenges for **ITS** applications:**

The main goal behind this contribution is to investigate the capability of the new emerging **VLC** technology for platooning application. Indeed, most of the related studies focus on indoor **VLC** systems, and usually tackle different communication challenges, where the indoor **VLC** systems performance can not satisfy the strict safety requirements for **ITS** applications. As a humble effort to enrich these research studies, our proposal and feasibility study is the first step before conducting a platform development, which will be carried out by experimental investigations in the following contributions.

★ **Contribution 2: Evaluating the standardized 802.11p technology for platooning application:**

We focus in this contribution on the performance evaluation of the IEEE 802.11p/**WAVE** communication standard for platooning application. The main goal is to evaluate the standard concerning the safety requirements by simulations and analytical means, considering collision probability, Packet Delivery Ratio (**PDR**), Channel Busy Ratio (**CBR**), and communication latency. The communication evalu-

ation tackles the low, sparse, and high dense vehicular scenarios, where the **PDR** for platooning is expected to decrease while the delay is increasing significantly for higher vehicular densities. The preliminary performance evaluation of the IEEE 802.11p/WAVE for platooning is given in Chapters 2 and 5.

★ **Contribution 3: Developing and evaluating a VLC prototype:**

In this contribution, we present the development and implementation of a low-cost, low-latency and simple outdoor **VLC** prototype that can be installed as a vehicular tail-lighting system. The primary objective of this implementation is to evaluate the overall system by conducting different experiments and compare the **VLC** theoretical modeling with an actual system acquired data. Moreover, an experimental evaluation of the prototype was performed with an especial attention on the **VLC** link resilience to ambient noise and communication range

★ **Contribution 4: Handover algorithm between Laser sensors, VLC, and RF technologies:**

As a result of the previous contributions, this contribution aims to enhance the communication mechanism by proposing three levels of handover between vehicular sensors, **VLC**, and the 802.11p for platooning application. Indeed, vehicles sensors such as Laser Range Finder (**LRF**) have a substantial impact as a backbone system in the case of communication blackout scenarios. Hence, our proposal is to increase the reliability of communications by reducing radio channel load and at the same time maintain the safety requirements. This contribution discusses in Chapter 5 the proposal of using handover between **VLC** and **RF** supported by sensor-based systems for platooning safety enhancement. Moreover, we discuss the proposal of a Vertical Handover (**VHO**) algorithm relying upon prediction method to enable the switch between **RF** and **VLC** technologies.

1.3 Manuscript organization

The thesis is structured into six self-contained chapters to facilitate a logical progression of materials and to enable a relatively easy access. Besides the general introduction in Chapter 1, each subsequent chapter is started with an appropriate presentation and discussion, supported by adequate theoretical, simulation analysis, and implementation details.

Starting with the thesis related literature, Chapter 2 presents the overall state of the art with an up-to-date review of the problem description, as well as the future directions for ITS communication schemes and developments focusing on V2V and Infrastructure to Vehicle (I2V). The wireless access technologies, benefits and limitations, link configurations, application areas and challenges of both radio-based and optical-based communication systems for ITS are all covered in this chapter.

To design and model an efficient VLC system for ITS applications, it is imperative to understand the channel characteristics for an outdoor environment. Propagation model, the ambient noise and path-loss model that significantly affects the VLC link performance for outdoor conditions are studied in Chapter 3. Moreover, we propose in this chapter a tracking alike compensation method using the exchanged vehicles position to enhance the Field of View (FOV) limitation of the VLC. An evaluation of the concept of controlling the platoon using exchanged information over VLC link is also tackled throughout this chapter.

Chapter 4 is dedicated to the development and implementation process of a low-cost, low-latency and simple outdoor VLC prototype that can be installed as a vehicular tail-lighting system. The chapter includes a preliminary evaluation of the VLC prototype on both electrical and packet levels. Moreover, a VHO algorithm relying upon prediction method is proposed in Chapter 5 to enables switching between RF and VLC technologies, where a proper metrics are introduced for decision making. We also study and evaluate the advantage of using VLC and LRF sensors for platooning further safety improvement.

Finally, we conclude this thesis in Chapter 6, where we summarize the key results and highlighting the possible future research perspectives.

1.4 List of publications

1. M. Abualhoul, M. Marouf, O. Shagdar, and F. Nashashibi, **Platoon-ing control using visible light communications: A feasibility study**, in 2013 16th International IEEE Conference on Intelligent Transportation Systems - (ITSC), Oct. 2013, pp. 1535–1540. [Online]: <http://ieeexplore.ieee.org/document/6728448/>
2. M. Y. Abualhoul, M. Marouf, O. Shagdar, and F. Nashashibi, **Enhancing the field of view limitation of visible light communication-based platoon**, in Wireless Vehicular Communications (WiVeC), 2014 IEEE 6th International Symposium on, Sept 2014, pp. 1–5. [Online]: <http://ieeexplore.ieee.org/document/6953221/>
3. Y. Bouchaala, M. Marouf, M. Abualhoul, E. Pollard, O. Shagdar, and F. Nashashibi, **WAVE Low Latency Video Streaming for Platooning Safety Real-Time Application**, in IEEE Vehicular Networking Conference - VNC 2013, O. Altintas, W. Chen, and A. Yglinski, Eds. Boston, Etats-Unis: IEEE, Dec. 2013, p. 2. [Online]: <http://hal.inria.fr/hal-00919440>.
4. M. Abualhoul, O. Shagdar, and F. Nashashibi, **Visible Light Inter-Vehicle Communication for Platooning of Autonomous Vehicles**, in 2016 IEEE Intelligent Vehicles Symposium IV2016, Gothenburg, Sweden, Jun. 2016. [Online]: <http://ieeexplore.ieee.org/document/7535434/>
5. M. Abualhoul, P. Merdrignac, O. Shagdar, and F. Nashashibi, **Study and Evaluation of Laser-based Perception and Light Communication for a Platoon of Autonomous Vehicles**, in 2016 IEEE 19th Intelligent Transportation Systems Conference (ITSC 2016), Rio de Janeiro, Brazil. [Online]: <http://ieeexplore.ieee.org/document/7795802/>

CHAPTER 2

State of the Art

Contents

2.1	Radio communication for ITS	11
2.1.1	Research projects	14
2.1.2	Use cases and application scenarios	16
2.1.2.1	Applications for traffic safety	17
2.1.2.2	Applications for traffic efficiency and management	18
2.1.3	Radio communication requirements & challenges for vehicular cooperative systems	19
2.2	Optical communication for ITS	21
2.2.1	Research projects	27
2.2.2	VLC use cases and application scenarios for ITS	29
2.2.3	Issues impacting outdoor VLC	30
2.3	Handover between VLC and RF technologies	31
2.4	Problem formulation	32
2.5	Conclusion	38

Résumé du chapitre

Ce chapitre explore les travaux présents dans la littérature ainsi que l'application visée **C-ITS** et les projets dans lesquels les technologies de communication radio et optique sont utilisées pour les applications **ITS**. Nous proposons une introduction aux fondamentaux théoriques et techniques qui définissent la communication véhiculaire et démontrent l'état actuel des efforts de normalisation à l'échelle mondiale et des projets de recherche connexes, en particulier les normes IEEE 802.11p et IEEE 802.15.7.

Nous nous concentrons finalement sur la formulation du problème et les questions de recherche de cette thèse : comment les exigences d'application du "platoon" peuvent-elles être mappées à un système de communication respectant les défis et les limites imposés à la fois par les communications radio et optique ? Les communications radio peuvent-elles répondre aux exigences de la sécurité dans les scénarios denses de véhicules ? Quelles sont les limites de cette technologie ? Dans quelles conditions les systèmes de communication **VLC** et/ou **RF** sont-ils capables de répondre aux exigences du "platoon" ? Comment analyser et évaluer la performance de la communication ? De quelle manière le système **VLC** doit-il être conçu et configuré afin de répondre aux exigences des applications "platooning" et de permettre à l'application de fonctionner de manière fiable lors des conditions extérieures ? Comment le transfert entre les différentes technologies peuvent améliorer la sécurité des applications basées sur le convoi ?

This chapter explores the state-of-the-art and envisioned **C-ITS** application together with the projects in which the radio and optical communication technologies are used for **ITS** applications. We give an introduction to the theoretical and technical fundamentals that define vehicular communication and show the current status of worldwide standardization efforts and related research projects, in particular, IEEE 802.11p and IEEE 802.15.7 standards.

We finally concentrate on the problem formulation and research questions of this thesis: how can the platoon application requirements be mapped to a communication system respecting the challenges and limitations given by both radio and optical communications? Can radio communication satisfy the safety requirements in high vehicle dense scenarios? What are the technology limits? Under which conditions are the **VLC** and/or **RF**-based communication systems capable of fulfilling the platoon requirements? How can the communication performance be analyzed and evaluated? How does the system have to be designed and configured such that the requirements

of platooning applications are fulfilled and allowing the application to work reliably in outdoor conditions? How the handover between different technologies can improve the safety of the convoy-based applications?

2.1 Radio communication for ITS

Recently, C-ITS has drawn much attention to solving various traffic problems [11]. The development of the IEEE 802.11p standard [12] for short and medium range vehicular communications combined with the allocation of a dedicated frequency band for ITS communication in Europe and the US have paved the way for future implementations of communication-based ITS applications. The IEEE group has developed a new PHY/MAC amendment of the 802.11 standards, which is dedicated for vehicular communications and introduced as IEEE 802.11p [13]. The technology was standardized to operate as a Direct Short Range Communication (DSRC) in the vehicular environment and meant to handle high-speed vehicle communications.

The main objective of this technology was defined to accommodate vehicular safety applications and improve road efficiency. Moreover, the MAC protocol implementation of this technology was defined to provide low latency performance for a relatively long communication range; corresponding to different traffic scenarios as indicated in Table 2.1.

Table 2.1: Inter-vehicle distances for different traffic conditions

Conditions	Inter-Vehicle distance [m]
Traffic jam	≤ 30
Roadway in urban areas	35-49
Urban highways rush hours	50-66
Urban highways	67-100
Rural highway	101-159
Rural areas	≥ 160

In order to ensure safety with the lowest possible communication latency using the dedicated adopted vehicular communications, the U.S. Federal Communication Commission (FCC) and the European Electronic Communications Committee (ECC) reserved seven and five non-overlapping channels in the 5.85 GHz spectrum respectively, where each channel has 10MHz of bandwidth, as depicted in Figure 2.1. Wireless Access in Vehicular Environments (WAVE) consists of both IEEE 802.11p and IEEE 1609.X [14]. The IEEE 802.11p deals with the Physical Layer (PHY) and Medium Access Layer (MAC), where the IEEE 1609.X considers upper layers.

In the 1609.X standard family, 1609.3 define network and transport layers and 1609.4 specify the multi-channel operation. In the multi-channel operation, a **WAVE** system reserves one channel to be a Control Channel (**CCH**), where the rest are designated as Service Channels (**SCH**s).

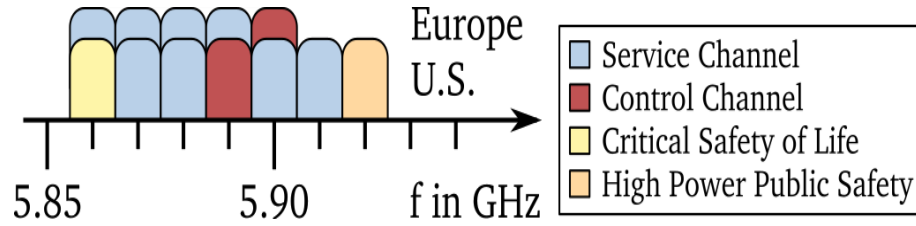

Figure 2.1: Channel allocation and usage for IEEE 802.11p according to FCC/ECC

The **MAC** layer uses Carrier Sense Multiple Access with Collision Avoidance (**CSMA/CA**) method, where a node (Vehicle) can access the **RF** channel only if the channel is sensed to be free during a certain period of time Arbitration Inter Frame Spacing (**AIFS**), and without any presence of any acknowledgment mechanism in a broadcasting mode. If the channel is busy during the **AIFS** period, the communication node defer for a random back-off time, which is counted down during time periods when the channel is sensed free. When the back-off timer reaches zero, the node start the transmission immediately.

To exchanging information in a vehicular environment for safety purposes, there will be a necessity to transfer information between the vehicular network members in periodic custom and with minimum latency. An example of safety-critical applications is driving autonomous vehicles in platooning form. In such application, the automated vehicles need to adapt quickly to any sudden changes. Therefore, the periodic status updates of both vehicle and environment must be recognized as one of the safety highest priorities. Moreover, very high-reliability requirements are also put on the announcement of event-triggered messages within the platoon in the case of unpredictable environmental incidences occurrences, such as accidents, ambulance vehicle arrival, and traffic jams.

For the reasons mentioned earlier, the **ETSI** has developed two basic messaging services for **ITS** applications to distinguish the different communication strategies and their effect on safety applications [15]. These are the Cooperative Awareness Message (**CAM**) and the Decentralized Environmental Notification Message (**DENM**), in which defined as the following:

1. Periodic status exchange.

Awareness messages typically share the vehicle status such as vehicle position, speed, acceleration, identification, engine status and any integrated sensors updates.

Table 2.2: Cooperative awareness message CAM

Periodic time-triggered messages	Use cases
-Length: up to 400 bytes	-Speed limits notification -Emergency vehicle warning -Slow vehicle indication -Intersection collision warning -Motorcycle approaching indication -Collision risk warning

2. Asynchronous notifications.

This type of messages is utilized to inform about a specific environmental event, such as accidents and traffic related conditions. In contrast to the periodic-based status messages ([CAM](#)), the reliability to deliver these messages to a group of terminals is usually a key requirement over latency. Moreover, [DENMs](#) are usually causing a lower communication traffic compared to the periodic [CAMs](#).

Table 2.3: Decentralized environmental notification message DENM

Event-driven hazard warnings	Use cases
-Frequency: (application dependent) -Length: variable	-Emergency electronic brake light -Wrong way driving warning -Stationary vehicle accident -Stationary vehicle-vehicle problem -Traffic condition warning -Signal violation warning -Traffic condition warning -Signal violation warning -Road-work warning -Road adhesion -Visibility -Collision risk warning -Hazardous location -Precipitation, wind

[CAMs](#) can be seen as beacons or heartbeat broadcasts periodically sent by every vehicle to the surrounding receivers providing updated information to increase each vehicle awareness. Furthermore, [DENMs](#) are an event-triggered messages which are broadcasted to inform any hazardous environmental events.

As it will be detailed in the subsequent sections, examples of the usage of the CAMs messaging can be found on both traffic efficiency and safety applications. For safety-based applications, vehicles will require accurate awareness information about surrounding vehicles to enable knowledge of any potential impacts, where a traffic conditions updates are assisting the traffic efficiency applications. Moreover, asynchronous notifications (DENMs) are mainly found in medium range safety-based services (DENM message relevance area), while the CAMs are broadcasted over an awareness range.

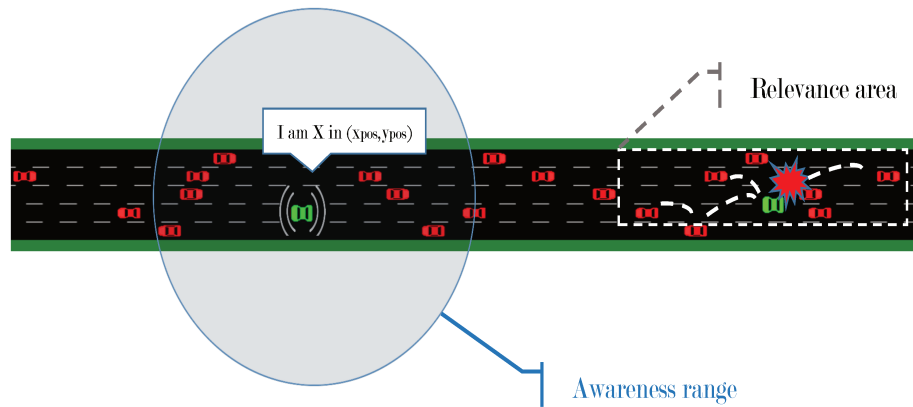

Figure 2.2: CAMs and DENMs delivery in IEEE 802.11p, messages are regionally broadcast through V2V communication

Figure 2.2 illustrate how the availability of the IEEE 802.11p network can benefit from a single broadcast transmission to distribute the message from a particular vehicle in its awareness range (CAMs case) or within a relevance area when hazard situations occur such as collision (in the event triggered conditions of DENMs).

2.1.1 Research projects

Different projects have studied the C-ITS for a various type of applications that are mainly concerned with the positive effect of using communication on improving both traffic safety and efficiency. During the last few years, the particular role of Vehicle-to-Any (V2X) communication came into focus and broadened the research interest in the interaction between the vehicles and the vehicles with the surrounding infrastructure. The possibility to use wireless communication to interact with infrastructure and vehicles (I2V, V2I) , as well as directly between vehicles (V2V), allows revealing entirely new application and enabling scenarios where cooperation of the different objects may be realized in ITS.

Before introducing the challenges of radio-based communication, we start by presenting related projects that tackled such possible applications.

Concerning traffic safety related projects, a significant effort was provided by the United States Department of Transportation (**USDOT**), which conducted more than eight vehicle manufacturers under the title Vehicle Safety Communications (**VSC**) project [16]. Within this collaboration, the main 44 safety-related and 11 non-safety related potential application scenarios were described in detail. Moreover, the possible system design, as well as communication requirements were determined. More interestingly, the application scenarios were categorized for the first time and evaluated concerning their potential future recognition in either near, middle or long term requirements.

Despite the communication technology in use, the project selected eight primary immediate and mid-term applications, where the communication requirements are defined. The list of identified applications includes curve speed warning, lane changing, traffic signal violation warning, pre-crash sensing, collision warning, turn assistant and stop sign movement assistance. Also, several potential candidates wireless communication technologies have been studied by the **VSC** project, such as **DSRC**, 3/4G mobile systems, Bluetooth, Zigbee, Infrared, radar systems and even the Ultra Wideband Band (**UWB**) communication.

The subsequent Vehicle Safety Communications Applications (**VSC-A**) project by **USDOT** was dedicated to continuing the research by focusing on improving and evaluate the existing vehicular safety systems [17]. The Vehicle Infrastructure Integration (**VII**) project concentrated on the communication between vehicles and infrastructure, where the main goal of this project was to show the feasibility of **V2I** communication and how enabling such communication can improve traffic. Moreover, the Cooperative Intersection Collision Avoidance Systems (**CICAS**) project was dedicated to investigating a specific application [18, 19, 20].

In Europe, many interesting projects such as **eSafety** project, **PReVENT**, **COOPERS**, **COMeSafety**, **PRE-DRIVE C2X** and **CVIS** project [21] were also launched and lead by the European Union (**EU**) to explore the emerging **ITS** applications. The mentioned projects have in common the interest to investigating **ITS** solutions, but from different perspectives and for a different type of application and autonomous driving safety requirements. The Cooperative Systems for Intelligent Road Safety (**COOPERS**) project was dedicated to investigating the use of **V2I** communication to improve traffic systems using the **CALM** architecture [22]. As for improving safety by enabling cooperative **ITS**, the **SAFESPOT** project focuses on the **V2V** communication and defined the fundamental technologies and scenarios [23].

Many other individual European projects were launched and dedicated to more particular features. Including but not limited to, the French [GeoNet](#) project [24] was devoted to providing full specifications of GeoNetworking protocol intended to enable geographical dissemination of information in a vehicular network. The Integrated Wireless and Traffic Platform for Real-Time Road Traffic Management Solutions ([iTETRIS](#)) simulation platform project was launched to provide one of the first macro-scale simulation capabilities for [ITS](#) applications [25] by combining both vehicular communication and mobility.

Other extended European projects have tackled vehicular communication development and demonstration such as the [Citymobil1](#) [19] and [Citymobil2](#) [19]. These two projects meant to set up a pilot platform for automated road transport systems across several European urban environments. More specific European projects such as [INTERSAFE-2](#) [26] aimed to improve safety requirements by developing and demonstrating a Cooperative Intersection Safety System ([CISS](#)) that can reduce fatal accidents at intersections. Moreover, the large-scale [DRIVE-C2X](#) [27] project provided a complete, Europe-wide evaluation of cooperative systems through operational field tests.

Furthermore, there are lately specialized societies, initiatives, and organizations intended to coordinate and motivate the cooperation and visibility of the different European projects. These organizations aim to team-up the efforts by collecting and exchanging the data, discussion between various individual projects and institutes. An example of such efforts is the Communications for Electronic Safety ([COMeSafety](#)) and the Car-to-Car Communication Consortium ([C2C-CC](#)) [28, 29].

2.1.2 Use cases and application scenarios

As it was shown so far, the radio-based [V2X](#) communication technologies were subjected to an intensive investigation over the last few years, The application scenarios for which the communication should be applied are often categorized into three different domains:

- Traffic safety applications.
- Traffic efficiency and management applications.
- Infotainment applications.

In this thesis, we will tackle and discuss the first two applications categories, following up the main contribution envisions toward communication-based platoon system.

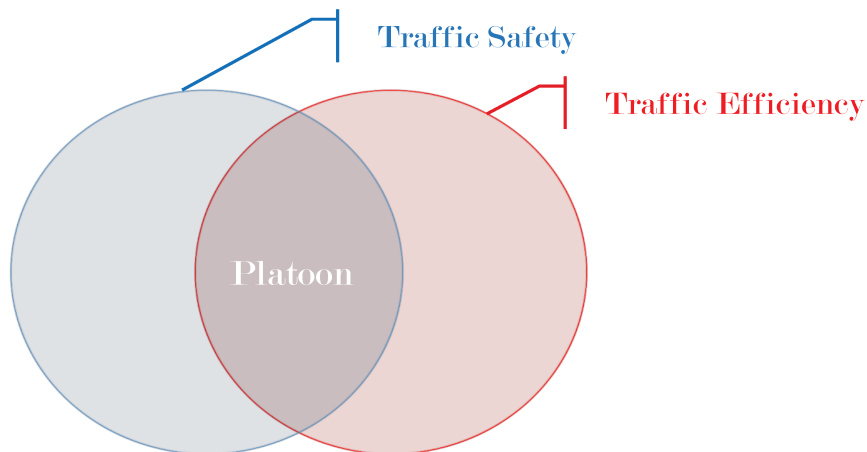

Figure 2.3: Communication-based platoon control system has the requirements of both traffic safety and efficiency applications

2.1.2.1 Applications for traffic safety

The main goal of traffic safety applications is to improve the safety of the human drivers and the pedestrians using transport systems by reducing the number of potential hazards and accidents. With the broad deployment of ITS today, this goal is becoming much more essential for many applications. Nowadays, every smart vehicle is equipped with one or many systems and technologies that developed to enhance the traffic safety either in passive or active means.

Systems such as airbags, automatic braking, Anti-Blocking Systems (ABS), Electronic Stability Control (ESP) are becoming standard safety equipment in today vehicles. Besides some other benefits, advanced systems such as Adaptive Cruise Control (ACC) and Cooperative Adaptive Cruise Control (CACC) are essentially meant to improve the same safety requirements [30]. These systems have in common the necessity to efficiently and actively use and share specific local indicators collected locally by vehicle sensors, which measure several physical values *e.g.* (speed, acceleration, position, distance, temperature, *etc.*).

Table 2.4: The high priority safety applications

Application	Range[m]	Rate[/s]	Latency[/ms]	Type
Traffic Signal Violation Warning	250	10	100	I2V
Curve Speed Warning	200	1	1000	I2V
Emergency Electronic Brake Light	200	10	100	V2V
Pre-Crash Sensing	50	- -	20	V2V
CollisionWarning	150	1	1000	V2V
Left Turn Assistant	300	10	100	I2V
Lane Change Warning	200	1	1000	V2V & I2V
Stop sign assistant	300	1	100	V2V & I2V

As indicated previously. The VSC project [16] has defined the most representative safety applications and out of them, eight were considered of high priority. As summarized in Table 2.4, these type of applications impose very strict limits concerning the communication latencies and inter-vehicles distances. The main reason for such strict requirements is that as the vehicles speed increase, the inter-vehicle distances increase, ensuring that the vehicle will have sufficient reaction-time to react on its own where the potentially hazardous situation is no longer dangerous.

Enabling vehicular cooperative awareness by exchanging information between vehicles can dramatically improve the traffic safety levels. The exchange of vehicles position, speed, and acceleration among all surrounding vehicles give more awareness and an extra advantage to detect in advance any hazards and accidents situations [31]. The vehicular platooning formation is an example of such complex systems combining computing, communication, and control technologies, in which all vehicles communicate and drive in autonomous mode with the requirement for at least four out of the eight high priority safety applications listed in Table 2.4. Many studies investigated the impact on traffic safety when exchanging information between platoon members. The obtained results by [32] showed that low latency communications could much more outperform distance sensors in the effective enhancement of platoon safety.

2.1.2.2 Applications for traffic efficiency and management

The second category of C-ITS applications is meant to enhance traffic efficiency by increasing the effectiveness of the traffic systems by either saving fuel, traveling times, CO₂ emissions, or vehicles flow. Currently, one of the remaining traffic authorities problems is the fact that on-road vehicles can only be notified regarding the current traffic situation using inefficient methods, such as radio stations, traffic signals or GPS systems. Thus, V2X communication systems can play a vital role in providing solutions to covering a macro-scale road network, where the vehicles can be notified instantaneously, independently, and at every location.

Besides the fact that a platooning system is considered a hard-safety application. The platooning formation is considered as one of the most efficient ways to increase road capacity and improve efficiency in highly dense vehicular traffic scenarios. This is done by driving vehicles in platoons with constant inter-vehicle spaces [33]. According to [34, 35, 32], road capacity can be increased dramatically by the use of tightly spaced platoon formations as expressed by the following formula:

$$C = v \frac{n}{nl + (n-1)D + d}, \quad (2.1)$$

where d represents the inter-platoon distance, D the intra-platoon distance, l the vehicle length, v the steady-state speed, and n the number of vehicles in each platoon.

2.1.3 Radio communication requirements & challenges for vehicular cooperative systems

After having provided a brief overview of the two primary C-ITS applications that must be considered for cooperative systems which use V2X radio communication, we will now have a closer look at the challenges and requirements that must be satisfied such that the applications can provide their presumed services.

The radio-based vehicular communication system requirements are usually determined by either the radio channel performance or the vehicular networking applications and use cases [36, 37, 38]. For this thesis scope, and after a brief listing of the main challenges facing radio-based communication for C-ITS, we will focus on the safety communication requirements.

The wide investigation of the standardised 802.11p technology in governmental, industrial and academic levels [39] indicated some of the top tackled challenges in radio communication for ITS as the following:

1. Delay constraints:

Data packets sent by vehicular applications usually have location and time significance. One of the most primary challenges in designing vehicular communication protocols is to provide low latency performance under the effect of vehicular speeds, low connect reliability and rapid topological changes. The results in [40] show that the dedicated 802.11p technology is unable to satisfy the CAM delivery requirements when a particular node retransmits all received CAMs to every surrounding vehicle, and the performance is even worst for higher-density

scenarios. Similar results are achieved when the same targeted vehicle uni-casts CAMs to every vehicle in the one-hop neighborhood.

2. **Prioritization of data packets and congestion control:**

The packets contain the data carrying traffic safety and traffic efficiency information usually have higher importance. Therefore, the traffic safety information should be delivered faster than any other data packets. The majority of the research activities have focused on how to manage and provide the most top priority to the emergency type of data packets. When an emergency situation occurs, the radio communication channel performance is likely to degrade due to a massive broadcast of emergency messages, which is well known as the radio channel congestion [41].

3. **Security, data centric trust and verifications:**

Risk analysis and management are used to identify and manage the resources, threats and any potential offences and illegal uses for vehicular communication radio spectrum. Solutions for handling such attacks have been proposed, but models of attacker behaviour are still missing [42]. For many vehicular applications, the integrity of the data can be more useful than the trustworthiness of the communication sources that are transmitting these data. Data verifications meant to provide the security to vehicular communication and ensure that the exchanged information can be trusted. Vehicles receiving information from other vehicles or another network are required to have entities able to trust somehow the entity that generated this information. One of the main challenges here is the development of a solution that can maintain the tradeoff between the authentication, liability and privacy when the radio network has to disclose the communicated information and its origin to certain authorities [43].

4. **The hidden terminal problem for VANET:**

In vehicular wireless networking, the hidden terminal problem occurs when a node (vehicle) is visible and detectable from a certain wireless Access Point (AP), but not from other nodes (vehicles) sharing the same communication channel and communicating with the same AP. This problem is often said to be one of the major limiting performance factors in wireless vehicular ad-hoc networks. Many proposals have tackled the definition of the hidden terminal problem and proposed some suitable theoretical solutions for broadcast transmissions and how the packet reception probability is affected by the presence of hidden terminals [44].

Various types of many other challenges can also be addressed here for radio-based vehicular communications such as reliability, cross-layering between network and transport layers, secure localization and message forwarding algorithms [39].

Thus far, C-ITS traffic safety applications top priorities are the fast and reliable information exchange of the current traffic situation, vehicles status, and any possible risks in the related surrounding. For such applications, the communication system requires the periodic and event-triggered exchange of broadcast messages[15].

Therefore, increasing the chance of both CAM and DENM messages to be successfully received within the defined safety required time need to be strictly high, as well as the updates rate. The VSC project recommendations for traffic safety applications: exchanged CAM messages of a size of (200-500 byte) every 100 ms as well as being transmitted on an event-driven basis. The standard communication fashion is a point-to-multipoint (broadcasting), with the reception destinations located no more than (50 – 300 meter) with a maximum tolerable communication latency of 100 ms (in some applications, even 20 ms) as indicated in Table 2.4.

The main challenge for applications carrying CAMs is to bypass the communication system overload due to the heavy traffic broadcast made by a high number of vehicles sharing the same communication channel, and updating their status with a frequency more than 10 Hz. This situation can appear more critical, especially in highly dense scenarios, like downtowns, or during rush hours.

2.2 Optical communication for ITS

VLC as all types of OW Communications has recently attracted significant interest from both industry and telecommunication research societies, essentially due to the increasing difficulties facing the RF wireless technologies. Among other advantages as will be explained in the subsequent sections, optical-based communication solutions could provide a much wider bandwidth using an independent medium and exhibit different channel characteristics and challenges compared to the RF communication systems.

The pioneering efforts of utilizing Light Emitting Diode (LED)s toward dual functionality, illumination, as well as data communication terminals is back to the year 2000 when researchers [45] in Keio University in Japan started the proposal of using white LED in home access networks as a low cost last mile communication solutions. Intensive research further advanced these efforts

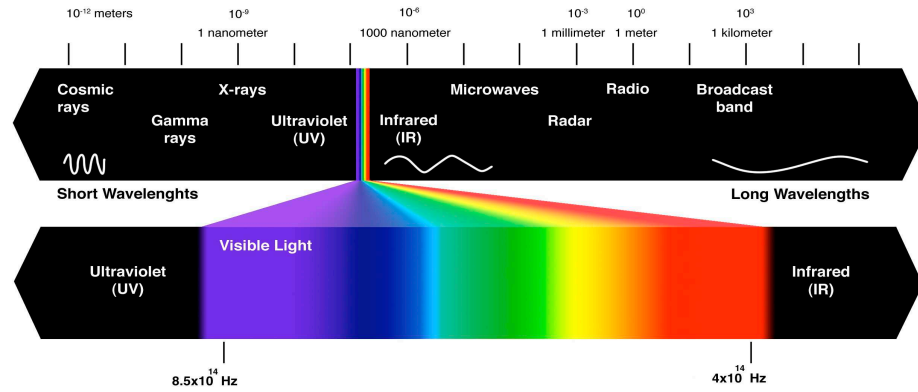

Figure 2.4: Electromagnetic spectrum usage. {VLC Spectrum range between (4×10^{14} Hz - 8.5×10^{14} Hz)}

in VLC domain, especially in Japan. The followed growing interest lead to the first formation of Visible Light Communications Consortium (VLCC) [46] in Japan in November of 2003.

By 2007, the VLCC proposed two standards 1)-Visible Light Communication System Standard and 2)-Visible Light ID System Standard. These standards were later one of the fastest approved standards by Japan Electronics and Information Technology Industries Association (JEITA) [47] as JEITA CP-1221 and CP-1222 respectively, which also triggered the interest toward the VLC technology by extending the applications and use-cases to many other systems.

Moreover, The vast development of lighting technologies, precisely in LEDs, allowed the LED-based traffic lights and vehicles lighting systems to be suited for information broadcast and unicast in vehicular communication systems. Using both I2V and V2V modes, where traffic safety-related information such as the DENMs and CAMs can be broadcasted as the following:

1. LED-based traffic lights can be used as depicted in Figure 2.5 to broadcast the event-triggered messages DENMs over larger geographical area with a less Line-of-Sight (LoS) limitations.
2. The periodic CAMs can be exchanged between adjacent vehicles over the vehicular LED-based lighting systems, such as tail and front lights. Such double functionality of the vehicles lighting system can enable a one communication hop to transfer the vehicles speed, position and moving direction of the vehicles to any adjacent or proceeding vehicles fall in the transmission FOV.

This technology which uses the electromagnetic spectrum in the wavelength interval of 380 - 720 nm as shown in Figure 2.4, offers several interesting advantages over the discussed radio-based communications in the previous section:

- Relatively unlimited bandwidth, more than 350 THz.
- Free license spectrum and available for immediate utilization.
- Secure data exchange, against interception or eavesdropping.
- Spatial reuse allowing substantially improved throughput.
- Low cost technology and continuously decreasing.
- Zero electromagnetic interference.
- Biologically friendly communication system.
- Lower power consumption technology.
- Dual nature of communication and illumination.

In transportation systems, VLC technology is favored over all other OW technologies mainly due to the low-cost [48] and by the gradual increase of the LED light systems integration in roads and vehicular infrastructures [49]. Furthermore, as proposed in [50], VLC can be deployed to provide high accuracy positioning for vehicular localization services.

Moreover, by using the on-vehicles front and rear lighting systems, the vehicles local status can be exchanged and forwarded from one vehicle to another [51, 52]. VLC in automotive applications began as a breakthrough at Akanegawa Labs in 2001 [53], the subsequent advancements in the field were rather insufficient to lead towards technology deployment especially for ITS applications where the system ability to cope with dynamic weather conditions and mobility limitations is still causing problems.

An example of such constraints for ITS applications is to maintain the continuity of a VLC link direct LoS. Since the emitted light from optical sources is responsible for data exchange in free space optical medium and represents the signal strength, the emitter light intensity is an important parameter on which the range of transmission depends.

There are also many interfering light sources such as ambient light, road and streets lights. These noise sources deteriorate the intensity of the received signal and may cause false triggering of the Photo Diode (PD). Moreover, high-intensity optical noise can even saturate the receiver, making it a blind

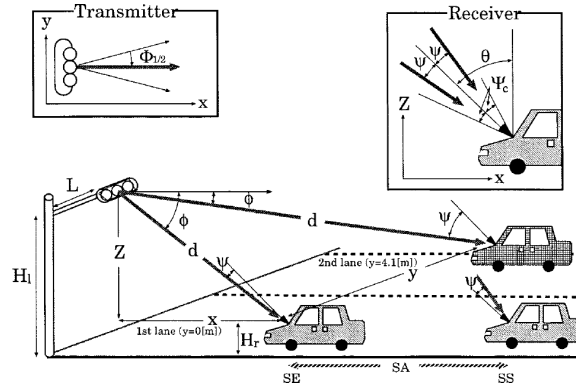

Figure 2.5: One of the first Basic Study suggesting to use VLC for traffic information systems.

device, therefore, optical filters and optical adapters are recommended to be used to minimize as many possible effects.

Furthermore, the previously mentioned limitations to using radio-based communication for both safety and road efficiency applications has firmly emerged the interest toward optical wireless solutions as a favorable complementary technology for the radio communication.

In addition, VLC has gained momentum support by substantial deployments in solid state lighting technology and the release of the IEEE 802.15.7 draft standard [54]. The IEEE 802.15.7 compliant networks consist of two types of nodes, namely, a coordinator which initializes and manages the network and remote devices which communicate with each other via the network coordinator.

The popular classic three types of topologies are considered in IEEE 802.15.7 standard, namely, peer-to-peer, star, and broadcast as shown in Figure 2.6. Also, the standard defines the first two layers of ISO/OSI stack protocol that includes Physical and MAC layers, where MAC is a CSMA/CA based protocol.

The IEEE 802.15.7 standard has specified three main PHY layers supporting different modulation schemes as shown in Tables 2.5. The Table provides a comparison between the four top modulations schemes proposed for VLC. It can be seen that both OFDM and Color Shift Keying (CSK) modulation schemes are more suitable for high data-rate VLC applications. On the other hand, OFDMs is most appropriate for any VLC systems incorporate MIMO designs.

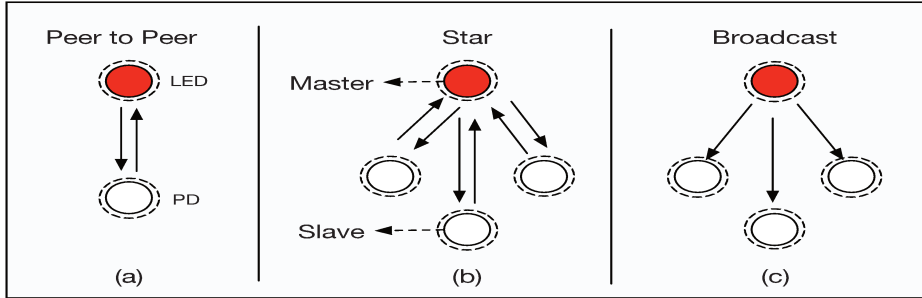

Figure 2.6: CAMs and DENMS delivery in IEEE 802.119, messages are regionally broadcasted through V2V communication

Both **PHY-I** and **PHY-II** utilize On-Off-Keying (**OOK**) and Variable pulse position Modulation (**VPPM**) for modulation. In addition, **PHY-I** includes the Reed Solomon (**RS**) and Convolutional Codes (**C-C**) for Forward Error Correction (**FEC**), while **PHY-II** and **PHY-III** mostly rely for **RS** codes only for **FEC**. However, further research is required to ensure the dimming support when using **OFDM** to modulate the **VLC** signals. Another advantage of **CSK** is that it can push toward the multi-user access through wavelength multiplexing. The expanding demand of higher data-rates is likely to encourage further development and research of **OFDM** and **CSK** for **VLC**-based access networks.

Table 2.5: VLC Modulation Schemes and Characteristics

Modulation	Data Rate	Dimming	Flickering	Main Characteristics
OOK	Low/Moderate	Yes	High	Low complexity transceiver design
PPM	Moderate	Yes	Low	Maximum spectral efficiency
OFDM	High	No	Low	Complex design due to LED non-linearity
CSK	High	Yes	Low	Requires RGB tri-LED, support multi-access

As reported in [55], the optical clock rates in **VLC** systems is an important parameter to define the exact **PHY** layers performance. Thus, **PHY-1** was defined to utilize relatively lower optical frequency of 400 KHz and less. This was recognized by the IEEE 802.15.7 standard because **PHY-1** was dedicated for being usable in outdoor scenarios as well where the LED transmitters are typically high-power and can switch the intensity at relatively slower rates. **PHY-II** is designed to be deployed for indoors applications, where the optical switching rate can be as high as 120 MHz. The recommended optical rate of 24 MHz for **PHY-III** is due to the currently available stable switching rate for white TriLED.

The modulated signal in VLC is transmitted over the pulse, and the LED usually operates at the full brightness over the pulse duration. The PHY type is selected in such way that the data rate of the modulated signal should accommodate the system dimming requirement. The authors in [56] confirmed that any VLC signal dimming level between 0% and 100% can be obtained using high Pulse Width Modulation (PWM) frequencies. One advantage of using PWM is that it supports dimming without any intensity level changes, and without any color shifting, compared with the predefined levels of OOK. The only limitation of PWM is the relatively low data rate (4.8 kbps [56]).

To overcome this limitation, the work presented in [57] suggested a combined solution of PWM and a Discrete Multitone (DMT) for communication and dimming control. Pulse Position Modulation (PPM) is another pulse-based modulation method widely used in VLC and based on the pulse position. In PPM, the symbol duration is separated into number of equal duration time slots, and a pulse is transmitted in one of these slots. In this modulation scheme, the pulse position can identify the transmitted symbol. Due to both system simplicity and efficiency, many early designs [58, 59], and implementations [60] of optical-based wireless systems has adapted the PPM for modulation.

Luminosity function V_λ is a crucial factor in designing and understanding the lighting technology. This function is used mainly to represent the vision of human eye that allows humans to recognize different colors [61]. The work of [62] showed that human's photopic vision exhibits varying levels of sensitivity to different wavelengths of the visible-light spectrum as shown in 2.7. The human eye can see the colors within the range of 360 nm to 700 nm with the maximum sensitivity at the wavelength of 550 nm.

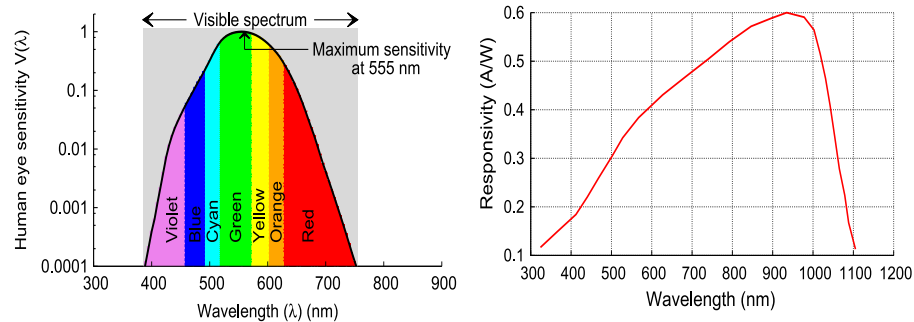

Figure 2.7: The relative intensity of VLC spectrum, and the Spectral response of a typical photodetector receiver responsivity.

2.2.1 Research projects

The replacement of conventional illumination devices by LED's and High-Power Light Emitting Diode (HLED)'s are the accelerating trend toward deploying VLC in many potential applications. At the same time, the exploitation of LEDs as information broadcasting devices has become an active research topic for ITS applications [63, 53, 64]. One of the first recognized works advancing the potential of deploying visible light were published by Akanegawa [53, 64], reporting and suggesting the usage of LEDs to communicate in both indoor and outdoor environments. In particular, the research detailed in [53] and [64] explored for the first time the usage of VLC in one of the ITS applications by broadcasting traffic information, between traffic lights and vehicles as illustrated in Figure 2.5. More recently, projects such as OMEGA [65] and D-Light [66] extended this research area to other applications.

The proposed system in [51] consists of one of the pioneering conducted experimental demonstrations of the cooperation between both I2V and V2V communications. The system achieves a promising BER of 10^{-7} for both I2V and V2V communication with suggestions for further improvements by integrating error detection and correction codes. Other works investigated the IEEE 802.15.7 Physical Layer I PHY-I standard compliant VLC and presented an implementation of the transmitter system-on-a-chip SoC, enabling the use of ordinary white LED lights as beacons or broadcasters for location-based applications realized for relatively short range communication [67].

Table 2.6 provide a summary of the latest achievable data rates for different VLC projects used for various type of applications and for a number of modulation schemes including Non-Return to Zero (NRZ), OOK, and Quadrature Amplitude Modulation (QAM) [68].

Table 2.6: Demonstrated performance of high-speed VIC systems

LED Type	Modulation Scheme	Modulation BW	Achieved Data Rate
White channel	OOK-NRZ	2 MHz	10 Mbps (BER < 10^{-5})
White channel	OOK-NRZ	25 MHz	40 Mbps (BER < 10^{-6}) [69]
Phosphorescent	OOK-NRZ	50 MHz	120 Mbps (BER < 10^{-3}) [70]
Phosphorescent	OOK-NRZ	50 MHz	230 Mbps (BER < 10^{-3}) [71]
Phosphorescent	DMT-QAM	50 MHz	513 Mbps (BER < 10^{-6}) [72]
Phosphorescent	OOK-NRZ	45 MHz	80 Mbps (BER < 10^{-6}) [73]
Phosphorescent	OOK-NRZ	50 MHz	100 Mbps (BER < 10^{-6}) [74]
Phosphorescent	DMT-QAM	25 MHz	100 Mbps (BER < 10^{-9}) [75]
Phosphorescent	DMT-QAM	50 MHz	200 Mbps (BER < 10^{-3}) [76]
Phosphorescent	DMT-QAM	50 MHz	515 Mbps (BER < 10^{-6}) [77]

Moreover, many full projects are being launched worldwide and dedicated to investigating the usage and potential applications of VLC for ITS. As an example and not exhaustively, PreVENT [11], and CALM [78] projects, which aimed to reduce the road fatalities. VIDAS (a research project funded by the Portuguese government), was another project applying VLC concepts for advanced driver assistance systems, commonly used in ITS [79]. VIDAS final results demonstrated the feasibility to establish a low data rate (20kbps) information broadcast link, between LEDs based traffic lights and vehicles (ranging up to 50m coverage). Experimental results showed that operation with BER of less than 10^{-6} could be achieved for up to 20-meter communication range but for very special weather conditions.

In addition, few experimental studies on VLC for outdoor applications were also presented. Using network simulator ns-2, Liu [80] examined the key elements in realizing VLC networks based on experimental results and considering the constraints imposed by the outdoor environment. Liu shows that VLC-based system can satisfy the stringent reachability conditions for Inter-Vehicle Communication (IVC) in relatively high dense vehicle traffic conditions. Where Cailean et al. [81] studied the cooperation application between road infrastructures and mobilized vehicles using VLC and based on pure experimental demonstration.

The authors in [81] presented a prototype of a vehicular system proposing a cooperation between vehicles and road infrastructures; aiming to enhance traffic security. Also, a remarkable effort to implement one of the first PHY and MAC layers of the VLC Standard (IEEE802.11.7) was demonstrated and tested in [48], where a half-duplex VLC prototype for V2I ITS applications has been realised for indoor conditions. These results and research efforts brought new opportunities for the deployment of VLC systems in much more ITS applications.

Some efforts have also been made on analytical modeling of VLC channels. Lee in [82] presented an enhancement of outdoor VLC system using selective combining receiver, while Okada in [83] proposed a road-to-vehicle VLC system using LED traffic lights as a transmitter and mainly discussed the noise effects and receiver design challenges. We at RITS team conducted studies on the applicability of visible light for platooning control [84, 85, 86]. We achieved very encouraging results showing the feasibility of VLC-based platooning control even in the presence of optical noise at significant levels and up to a certain degree of road curvature. Moreover, we proposed an enhancement mechanism to overcome the optical FOV limitations.

2.2.2 VLC use cases and application scenarios for ITS

ITS is now to consider the deployment of VLC technology by focusing on the illustrated two scenarios in Figure 2.8. First of all, the case of I2V where a traffic light system is broadcasting traffic messages which are received by vehicles at intersections. Secondly, the case of IVC or V2V communication that uses the vehicle rear and front panel LED lights to exchange information between vehicles, which is very effective in vehicular high dense scenarios as it will be studied in the subsequent chapters.

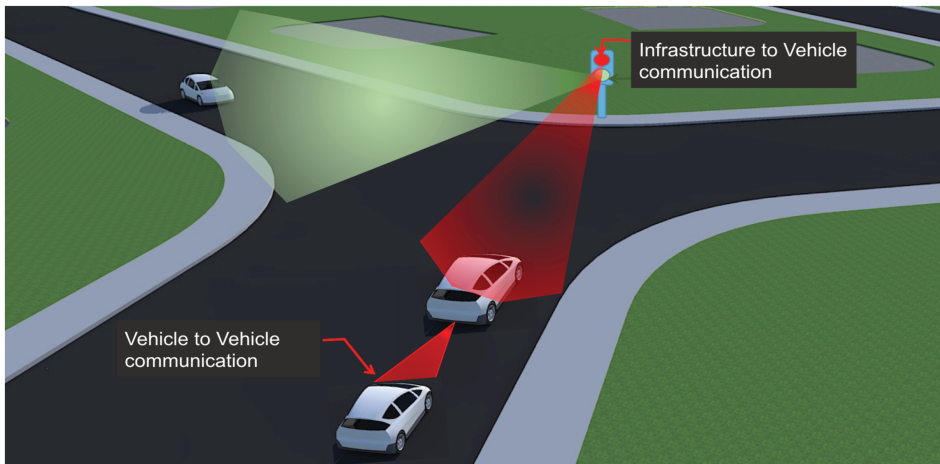

Figure 2.8: The main use cases of VLC technology in ITS, First use is the I2V broadcast from traffic lights to vehicles, the second use is the IVC between adjacent vehicles forming a short range communication link between any vehicle formation.

The use of VLC in such scenarios can dramatically improve the communication safety requirements by establishing a point-to-point link between adjacent vehicles taking some of the load from RF communication channel. The authors in [53] investigated an essential study on traffic information system using LED-based traffic lights. They analyzed the performance and defined a service area, in which communications using a specified data rate together with intensity modulation OOK can be maintained. VLC is not only suitable for a broadcast system in I2V communication systems, but it can be equally effective in both V2I and V2V.

In this thesis, and as will be detailed in the subsequent chapters, we focus on the use of VLC technology in combined solution with the RF by realizing an IVC between platoon members. The system realization will be supported by simulation studies, evaluation, prototyping and the technology demonstration.

2.2.3 Issues impacting outdoor VLC

There are numerous issues and limitations concerning the full deployment of the dual functionality of the VLC (illumination and communication nodes). Both design and implementation of particular VLC system will be further detailed in the subsequent chapters. In this section, we list some of the main challenges and technical limitations:

1. **Ambient Noise:**

The presence of any light source which has the capability to illuminate detectable stronger light levels compared to the VLC transmitter end, can dramatically decrease the Signal-to-Noise Ratio (SNR) level, which causes data inaccuracy, signal distortion, and poor link quality [84, 87, 88].

2. **LoS Propagation:**

The transmitter and receiver in all OW-based communication systems, including VLC, must to be in the FOV of each other and maintain a LoS continuity. Otherwise, the communication link quality will be extremely low or even zero. In some scenarios, the slightest alter of angle might cause entirely link disconnection, and communication range and accuracy will be considerably reduced, especially if the FOV is narrow.

3. **Analog Issues:**

As for the analog related issues, there are two main concerns :

- (a) **LED Brightness:** According to the standardization and eye safety considerations for using LEDs, the commercial LEDs are relatively very dim and can not support the application with long communication range, especially with the presence of strong ambient noise [89].
- (b) **MOSFET Limitations:** MOSFET electronics which used usually for high-speed switching and deal with high current levels can heat up very fast. Therefore high-power illumination system design can add more design complexity and requires a precise cooling systems.

4. Digital issues:

Due to the newly emerging concept of using LED as a VLC sources, the commercial hardware do not exist yet, where it is it's hard to find the precise sampling rate of an on-shelf Analog to Digital Converter (ADC). The output from the ADC can be unstable, especially for high-speed rates, and the cost for an accurate ADCs supported with proper amplifiers are relatively high [90].

2.3 Handover between VLC and RF technologies

The implementation of a way to smoothly evaluate the VLC and RF communication suitability could display a bright improvement on platoon system behavior. However, few problems arise when researching on VLC mobility management as it will be further discussed in the subsequent chapters. In this section, we present the related state-of-art work on the handover between both VLC and RF technologies and switching decision mechanisms. Indeed, there have been a limited number of efforts investigating how both communication technologies can be utilized in complementary customs.

The authors of [91] are one of the first to tackle the general rules for VHO combining VLC and WiFi systems, where they proposed a disconnections avoidance mechanism by distributing resources among Mobile Terminal (MT)s for indoor applications. Vegni in [92] studied Horizontal Handover (HHO) rather than VHO, the proposed mechanism switches between two independent VLC links, in other words, a homogeneous and not a heterogeneous system.

Performance investigation of indoor VLC-WLAN hotspot networks in a mobile scenario was conducted in [93]. The authors proposed VHO method without describing clear steps, which seems oversimplified process. Moreover, an advanced fuzzy logic based VHO algorithm was introduced in [94] to solve the issue related to communication link LoS blockage for RF-Infra-Red (IR) communication system. The proposal here relies on preliminary training procedure. In addition to the fact that the proposal is also for and indoor VLC system, the algorithm determines that its necessary to set a fixed dwell time before executing a handover, regardless of such a waiting time effectiveness on the system performance. An unreasonably assigned timer may cause longer system latency, which is the key requirement to be reduced in ITS safety based applications.

In [95], a VHO algorithm was proposed between VLC and LTE technologies. The authors introduced a reliable VLC-LTE system as a conceptual example of VLC-RF models and suggested a predication-based VHO mechanism (PVHO). The proposed Prediction Vertical Handover (PVHO) recognizes a dynamic dwell time and predicts the effectiveness of both conventional schemes to determine the better one at every VLC link interruption occurrence. To our best knowledge, the state-of-art of the handover proposals recognizing a VLC-RF system are all meant for indoor VLC systems, or what's called lately Light Fidelity (Li-Fi). In such systems, the VLC interruption period of several seconds often considered as normal operation conditions.

2.4 Problem formulation

As it has been discussed in the previous sections, the C-ITS traffic safety applications are based on the periodical critical data exchange of the vehicle's status, such as position, direction, and speed. The (CAM, DENM) standardized messaging systems were implemented in the IEEE802.11p to exchange such information in the vehicular environment.

Considering a platoon system at relatively high speed, aiming to keep a fuel-efficient and inter-vehicle distance as low as few meters. In this case, periodic status updates must be considered even highly safety-critical as the automated controller is required to adapt quickly to any sudden changes. Moreover, For some scenarios, the inter-vehicle distance between platoon members can be extremely low, which will require a more frequent and highly reliable exchange of status updates within the platoon. Such a requirements can dramatically affect the RF communication performance.

Moreover, very strict timing and reliability requirements are also put on the dissemination of event-triggered messages within the platoon in the case of a hazard situations. The delay between event detection (*e.g.* a vehicle suddenly stops or the leading vehicle in the platoon detecting obstacle) and the point in time when the entire platoon successfully received the warning must be significantly minimized.

On the vehicular control level, and without using the IVC, maintaining a desired inter-vehicle distance in platoons formation requires a strong control of each vehicle. For classical human-driven vehicles, the inter-vehicle spacing is predefined through a constant time headway, which simply expects that any increment in speed directly implies increased inter-vehicle distance. According to [96], the desired minimum gap d_{min} between two adjacent vehicles

under the Intelligent Driver Model (IDM) is given by:

$$d_{min}(v, \Delta V) = d_0 + VT + \frac{v\Delta v}{2\sqrt{ab}}, \quad (2.2)$$

where $\Delta V = V_i - V_{i-1}$, i represent the follower vehicle and $i - 1$ represent the leading vehicle, d_0 is the minimum distance in congested traffic scenario, a is the maximum acceleration and b is the correspondent comfortable deceleration value.

The second term of (2.2) is not significant but in the non-stationary traffic situation, when $\Delta V \neq 0$, therefore, for relatively low speeds platoons, the term can be ignored. Term VT is the most relevant one to the resultant spacing policy in stationary traffic, where T denotes the safety time gap.

When speed increases, d_{min} proportionally increases, which implies that the road vehicle density decreases. Therefore, the human driver low-speed reaction time (about 1 second) is the reason for the need of such relatively large safety gap d_{min} that increases proportionally with the vehicle speed. This performance pattern leads to the lack of string stability if applied directly for platooning, and can result in possible collisions between platoon members, where the trade-off between roads capacity improvement and the large safety inter-vehicle distance is evident.

Deploying the IVC between platoon members, and according to [34, 35, 32], road capacity can be increased dramatically by the use of tightly spaced platoon formation as expressed by the following formula:

$$C = v \frac{n}{nl + (n-1)D + d}, \quad (2.3)$$

where d represents the inter-platoon distance, D the intra-platoon distance, l the vehicle length, v the steady-state speed, and n the number of vehicles in each platoon. The analysis assuming that each platoons have the same number of vehicles, and the formations do not change dynamically.

Considering the platoon formation illustrated in Figure 2.9, where the desired acceleration \ddot{x}_{i_des} of the i_{th} vehicle is essential to be calculated for string stability improvement, the following second-order system is attained to calculate this desired acceleration of the i_{th} vehicle (\ddot{x}_{i_des}) [97].

$$\begin{aligned} \ddot{x}_{i_des} = & (1 - C_1)\ddot{x}_{i-1} + C_1\ddot{x}_l \\ & - (2\xi - C_1(\xi + \sqrt{\xi^2 - 1}))w_n\dot{\varepsilon}_i \\ & - (\xi + \sqrt{\xi^2 - 1})W_nC_1(V_i - V_l) - w_n^2\varepsilon_i, \end{aligned} \quad (2.4)$$

where the parameters descriptions of (2.4) are described in Table 2.7.

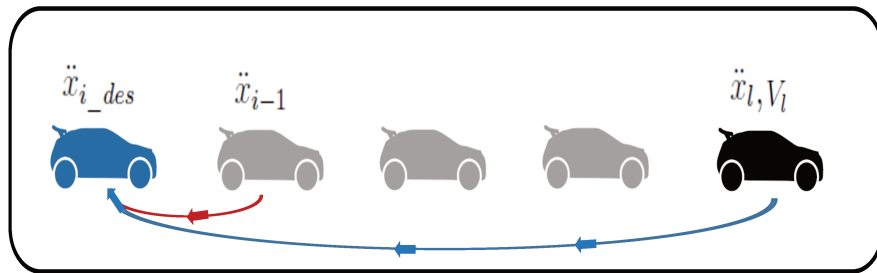

Figure 2.9: Platoon's communication information flow, a broadcasted CAM periodic messages is required to pass the leader vehicle speed and acceleration together with any DENMs, where a point-to-point link is required to pass the proceeding vehicle acceleration for string stability desired acceleration by the i th vehicle CAMs

From the given equation, and as illustrated by Figure 2.9, in order to calculate the i th vehicle desired acceleration \ddot{x}_{i_des} in a platoon formation with relatively high string stability. A wireless broadcast communication link is required to pass the leader acceleration and speed (\ddot{x}_l, V_l) to all platoon members simultaneously, together with a point-to-point communication link to pass the proceeding vehicle acceleration \ddot{x}_{i-1} .

In order to handle such information exchange, and as mentioned earlier, the standardized IEEE802.11p for vehicular communications employs the contention-based channel access which uses CSMA/CA. In Enhanced Distribution Channel Access (EDCA), every node (vehicle) in a platoon formation as depicted in Figure 2.9 with a pending frame will start sensing the channel for a fixed period of dedicated time Extended Inter-Frame Space (EIFS), then transmits the frame only if the channel was idle or defers the transmission for a random back-off time. The back-off time is set according to the standard from the range $\sigma \times [0, CW]$, where, σ represent the slot time and CW is the contention window.

Table 2.7: Mathematical Formulations description of equation 2.4

Symbol	Description
\ddot{x}_{i_des}	i th vehicle desired acceleration
\ddot{x}_{i-1}	Acceleration of the vehicle preceding the i th vehicle
ξ	Damping ratio (equal to 1 for critical damping)
w_n	Controller Bandwidth
L_i	i th vehicle length
x_i	i th vehicle position
x_{i-1}	The position of the vehicle preceding the i th vehicle
$C1$	Longitudinal controller gain (weight factor of the leader with respect to the preceding vehicle, with values varies $0 \leq C1 < 1$)

Assuming that the nodes will always have pending frames. Let us denote the channel access probability τ , which is expressed simply as $1/(CW + 1)$. The probability of successful transmission at a node is $\tau(1 - \tau)^{n-1}$, where n represents the number of nodes in the sensing area (up to 1 km). In order to avoid packets collisions, CW should take a relatively large value when the number of contending nodes (vehicles) is significant.

For this propose, EDCA has defined a mechanism (so-called exponential back-off mechanism), which exponentially increases the CW in a given range of $[CW_{min}, CW_{max}]$ after every consecutive transmission failure, where a reset of CW_{min} is applied after a successful transmission.

One of the earliest experimental studies on channel congestion issues for a vehicular environment using IEEE 802.11p communication system was performed at INRIA [98]. The objective of the experiment was to study the overall performance of the IEEE 802.11p standard, especially the scalability in the context of channel performances affected by the number of nodes (vehicles), packet size and traffic rate.

The experiment results draw attention to the channel congestion issue for safety applications, where the drop of PDR indicates an increase in the probability of traffic accidents. Figure 2.10 represent the ratio of delivered packets measurements PDR for different interval and packet sizes. It can be seen in Figure 2.10.a that increasing the packet size from 200 to 500 for the same low data rate can cause a non-ignorable performance drop for the safety-based application.

Moreover, the results showed the same behavior when the packet interval is changed in Figure 2.10.b, where decreasing the packet size and increasing the packet interval have strict limits for safety ITS applications.

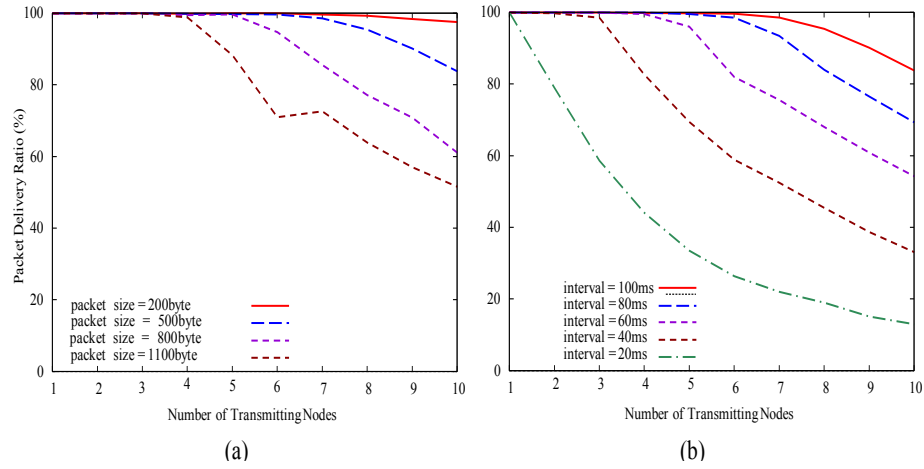

Figure 2.10: Comparison between various packet intervals and sizes for vehicular communication. (a) various packet intervals for Bitrate = 6 Mbps, Packet size = 500 bytes. (b). various packet intervals for Bitrate = 6 Mbps, Packet size = 200 bytes.

In order to maintain the desired minimum inter-vehicle distance gap between platoon members (d_{des}), it is vital that both periodic **CAM** and event-driven **DENM** warning messages can access the channel with low latency and relatively very high reception probability. However, the random access **MAC** protocol defined by the IEEE802.11p standard for **IVC** and the **ETSI** requirements to use both **CAM** and **DENM** messages on the 10 MHz control channel, which is constrained by the congestion control mechanisms still provide insufficient support for highly delay sensitive applications such as platooning [99].

Moreover, recent performance analysis studies showed any performance improvement with the **PDR** regarding periodic status updates is only achievable with a penalty to the dissemination delay of event-driven warning messages within the platoon [100]. Increasing the status update rates to 50 Hz or more, which is beyond the defined rate by the standard (10 Hz), might also increase the warning messages latency. Also, the given performance gains might not be worth the costs of additional transceivers hardware tuned to dedicated service channels as suggested by [101, 102].

The mentioned major constraints for using the standardized **RF** communication in high-density micro-scale scenarios has firmly emerged the interest toward optical wireless communication as a favorable, complementary technology and has gained momentum support by substantial deployments in solid state lighting technology and the release of the **VLC IEEE 802.15.7**

draft standard. In such circumstances, it becomes critical for an *ITS* architecture to be flexible enough to accommodate integration of the new *VLC* systems.

To investigate the relation between *RF* channel congestion levels and vehicular densities for a random traffic consists platooning formations. A simulation study was conducted in the context of this thesis, where two scenarios were built in Network Simulator 3 (*NS3*). The first scenario (All Platoon Member Broadcast) meant to enable the *RF* broadcasting for every individual node (Vehicle). On the other hand, the second scenario (Platoon Head Broadcast) is disabling the *RF* broadcasting of all platoon member except for the platoon leader. The second simulation scenario resembling the use of a *VLC* link between platoon members as depicted in Figure 2.9. Moreover, The simulation scenarios were set according to the standardized sparse, medium, and high-dense traffic conditions of 4 lanes (See Chapter 5 for simulation scenarios details).

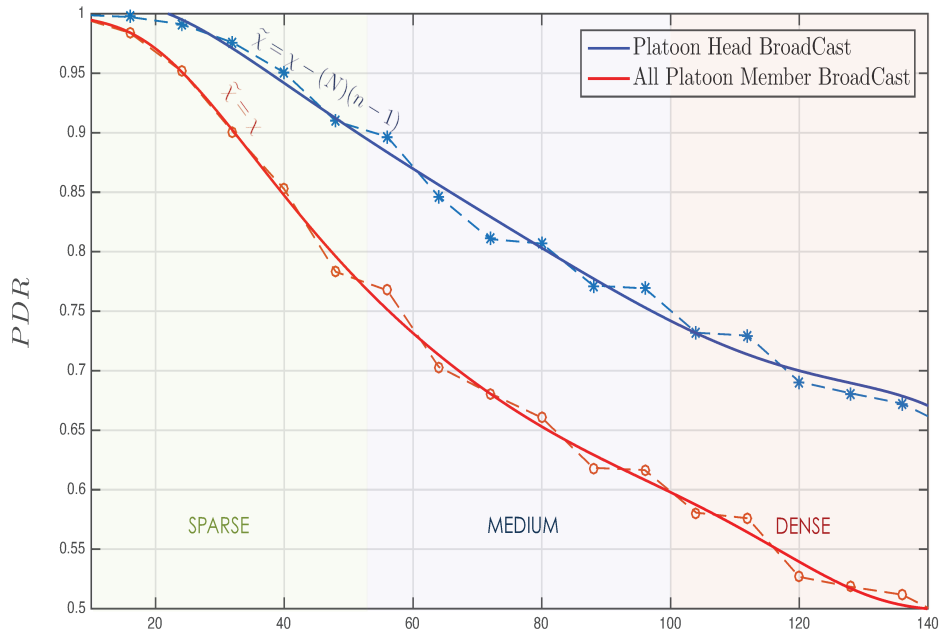

Figure 2.11: NS3 Simulation results of Scenario I and Scenario II illustrated in Chapter 5.

The obtained results in Figure 2.11 draw a remarkable improvement in PDR levels when VLC is deployed between platoon members, where the improvement can reach up to 15% at the beginning of the high dense zone. By only counting the amount of dropped packet for such highly-safety demanded application, we can conclude and observe the severe congestion influence on the RF channel, where the PDR is falling dramatically with the density increment. Further details regarding this simulation study can be found in Chapter 5.

To conclude the performance of the two previously mentioned scenarios. The obtained results showed that by enabling VLC as IVC between platoon members instead of RF, where the x_{i-1} in Figure 2.9 is passed from proceeding vehicle to its follower. The VLC-based platoon system can remarkably reduce the load on the network level and limits the channel congestion effect of the main RF communication channel without impacting the string stability. Therefore, the VLC-based platoon can lead to further safety improvement and increase the road capacity.

2.5 Conclusion

It becomes evident that one of the best ways to efficiently improve road capacity is by the use of vehicle platoons formation with a constant inter-vehicle spacing. Also, to ensure the string stability between platoon members in a constant spacing custom, IVC is required [103, 104]. The safety-based IVCs are crucial for suitable platooning operation. However, DSRC broadcasting performance as discussed before for the standardized IEEE802.11p technology still can not present enough reliability to ensure safe vehicle operation in such high-dense scenarios.

Unfortunately, one of the remaining serious unsolved challenges on the MAC level for IEEE802.11p is the advertising method of awareness and notification messages which is standardized to be broadcasted [105, 101]. Therefore, there will be no acknowledgment procedure and thereby no collision detection. Accordingly, the contention window is never extended in real distributed VANET, and the mechanism will always adapt the value CW_{min} . As a result, the maximum one back-off procedure which is theoretically introduced to enhance the communication system performance in such a scenarios is entirely invoked. Moreover, the CW_{min} using IEEE 802.11p has set the standard to the default value of CW_{min} which is relatively small values for the control channel is can be an intolerable issue for hard-safety applications.

The limitations of IEEE802.11p in supporting delay-sensitive data traffic and sharp-safety applications is a serious problem for ITS communication and the solutions proposed are either unverified or still can not reach the hard-safety requirements [106, 107, 108]. The MAC layer congestion issues at high vehicle densities is serious enough that, ETSI started to standardize a DCC algorithm in order to lower the CAM update occurrence during channel congestion period.

Moreover, recent decisions within ETSI began to propose reducing the strictly periodic nature of CAMs towards an on-demand procedure where CAMs are shared only when the change in particular vehicle status is above a certain predefined threshold. The discussed significant limitations for using the standardized RF communication in high-density micro-scale scenarios such as platooning, has motivated the interest toward the use of VLC as a complementary technology, and has gained momentum support by the release of the VLC IEEE 802.15.7 draft standard.

Table 2.8: Comparison of VLC and RF communication technology [2]

Property	VLC	RF
Bandwidth	Unlimited	Regulated and limited
Electromagnetic Interference	No	Yes
Hazard	No	Yes
Line of Sight	Yes	NO
Security	Good	Poor
Standards	IEEE802.15.7 in progress	IEEE802.11p Matured
Services	Illumination/Communication	Communication
Noise sources	Sun light/ambient lights	All electrical electronic
Power consumption	Low	Medium
Mobility	Limited	Good
FOV	Limited	Omni-directional
Communication range	Short	Short to long

As it will be further investigated in the subsequent chapters, and unlike Omni-directional RF-based communication solutions, VLC is a limited directional technology. Moreover, the LoS dependency of VLC systems can maximize the power efficiency and reduces multi-path distortion and at the same time take off some load from RF link in micro-scale high dense communications ranges. It has been pointed out in this state-of-art that DSRC RF-based communication solutions for ITS applications might be suitable for macro-scale scenarios (hundreds of meters), but it can become critically unstable in heavy traffic conditions (few meters). On the contrast, deploying VLC can contribute in safety performance improvement for increased numbers of close-by vehicles (micro-scale), a summary comparison between both technologies is listed in Table 2.8.

CHAPTER 3

Modeling VLC for a Platoon of autonomous vehicles

Contents

3.1	Introduction	42
3.2	VLC channel model for ITS applications	43
3.2.1	VLC channel path-loss (DC gain)	44
3.2.2	VLC noise model for outdoor applications	45
3.3	Platoon control model	47
3.3.1	Kinematic model	47
3.3.2	Longitudinal and lateral control	48
3.4	Performance evaluation	49
3.4.1	Optical channel performance	50
3.4.2	Platoon control performance	51
3.5	Enhancing the field of view limitation	56
3.5.1	Proposed solution to enhance the FOV limitation	56
3.5.2	Performance evaluation	59
3.6	Conclusion	62

Résumé du chapitre

Dans ce chapitre, nous étudions la modélisation du canal radio et de bruit pour la technologie VLC, en tenant compte du bruit ambiant, des angles optiques et de la bande passante du récepteur électrique. L'étude considère également une méthode de modulation de OOK, où nous utilisons la métrique de performance BER pour varier la distance entre-véhiculaire.

De plus, nous proposons une méthode de compensation de type (tracking alike), en utilisant la position des véhicules échangés entre eux afin d'améliorer la limitation de FOV du VLC pour une application de "platooning". Enfin, à l'aide d'un SIMULINK, nous simulons l'impact de VLC sur les performances de l'application "platooning" autonome, contrôlée par des contrôleurs longitudinaux et latéraux.

3.1 Introduction

Nowadays, the requirements for the solution of road traffic problems such as accidents, roads congestion, and the accompanying environmental pollution have exponentially increased. Both ordinary roads and highways are becoming more jammed every year due to inadequate road development to accommodate the growing number of vehicles.

Automatically controlled vehicles in a platoon formation where the inter-vehicle distance between any two vehicles can be reduced down to few meters will efficiently reduce the traffic jam by increasing the roads fluidity. Moreover, the data flow between vehicles is crucial to delivering information concerning the vehicle state (speed, acceleration, vehicle failure, brake, *etc*), for many convoy-based and road safety applications. For platooning control, V2V communication is needed to guarantee the string stability of the platoon [109].

Therefore, the RF communication deploying IEEE 802.11p standard have been considered to facilitate relatively long range and high data rate communication for vehicular applications with the lowest possible communication latency. However, the technology might suffer from serious drawbacks; mainly it may not always ensure stable communication due to increased channel congestion in highly dense traffic scenarios [102], and indicating that the vehicular communication technologies remain as an open problem. Motivated by this, we consider a use of the vehicles' lighting system for IVC between platoon members.

The core concept of using VLC as free space communication link is depicted in Figure 3.1, where an optical receiver and transmitter ends are transferring data using a visible light spectrum over a free space channel. In order to achieve a reasonable and stable communication link for outdoor environment, there are many technical as well as nontechnical challenges that need to be addressed. One such challenge is the optical signal behavior in free space channel where the ambient noise is actively interrupting the proper detection, especially for V2V and I2V communication in ITS.

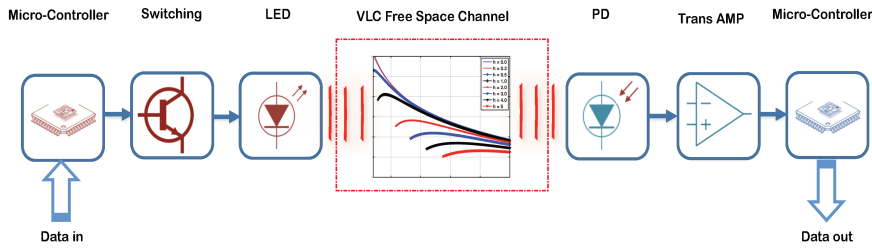

Figure 3.1: General illustration of the VLC concept.

In this chapter, we investigate a complete VLC channel and noise model considering the ambient noise, optical angles, and electrical receiver bandwidth. The investigation also considers an OOK modulation method, where we use the Bit Error Rate (BER) for varying inter-vehicle distance as performance evaluation metric.

Moreover, we propose a tracking alike compensation method using the exchanged vehicles position to enhance the FOV limitation of the VLC for a platooning application. Finally, using a SIMULINK, we simulate the impact of VLC on an autonomous platooning performance controlled by longitudinal and lateral controllers.

3.2 VLC channel model for ITS applications

The physical model of the optical communication system between vehicles (V2V) is illustrated in Figure 3.2. The model shows a half-duplex link between two consecutive vehicles in a platoon. However, adding another connection between each two vehicles for the reversal direction can expand the half-duplex model to the full-duplex one.

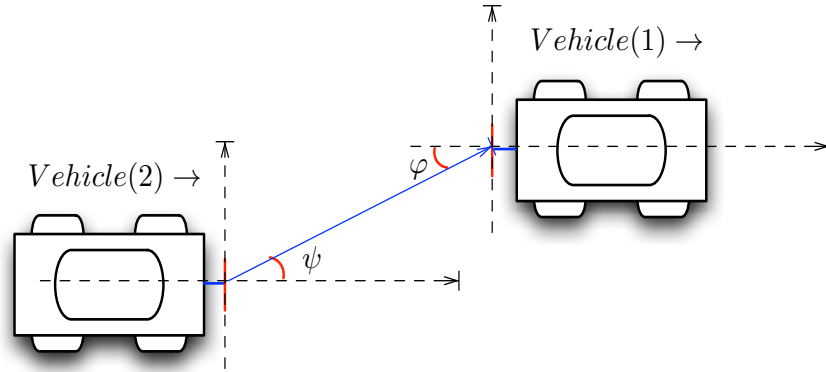

Figure 3.2: V2V optical communication system for V2V, where ψ and φ represents both incidence and irradiance angles respectively, d is the inter-vehicle-distance.

3.2.1 VLC channel path-loss (DC gain)

The VLC channel between consecutive two vehicles in the platoon can be modeled as simple baseband linear system with three main parameters, the PD current $\dot{Y}(t)$, optical input power $\dot{X}(t)$, and impulse response $h(t)$. Outdoor VLC applications are highly sensitive to the direct expose of the PD to any high power visible light sources, which in turn generates high-intensity ambient current induced shot noise in the PD.

Minimizing the receiver background can be easily achieved by using optical band pass filter, which will filter out all the optical spectrum except the desired color. Notwithstanding that, the receiver is still expected to adds shot noise, which is usually the limiting noise source for any receiver. Independently from $\dot{X}(t)$, Gaussian distribution is the most accurate model for any high-intensity shot noise in the PD. On the other hand, the pre-amplifier noise at the receiver side also has Gaussian distribution and is independent of the optical signal [110]. Consequently, the VLC channel can be modeled as an Additive White Gaussian Noise (AWGN) channel as the following:

$$\dot{Y}(t) = \gamma \dot{X}(t) \otimes h(t) + \hat{N}(t). \quad (3.1)$$

Here, the PD current $\dot{Y}(t)$ is a result of the convolution between the optical power and impulse response, γ represents the detector responsivity and $\hat{N}(t)$ is the AWGN.

Optical channel DC gain $H(0)$ (VLC link path-loss) can be determined by following the laser-based communication same analysis for LED Lambertian emission given in [110] and considering the geometry in Figure 3.2.

$$H(0) = \begin{cases} \frac{(m+1)A_{ph}}{2\pi d^2} \cos^m(\varphi) T_s g(\psi) \cos(\psi), & 0 < \psi < \theta_c \\ 0 & elsewhere \end{cases}, \quad (3.2)$$

where d is the separation distance and θ_c is the PD FOV representing the maximum incidence angle. A_{ph} is the physical area of the PD and T_s is the filter transmission coefficient. For an ideal optical filter, such as the case of our simulation assumption, $T_s = 1.0$ (see TABLE 3.1), m is lamper-tian emission order, which is a key parameter specifying the directivity of the transmitter as shown in (3.3). The chosen half-power angle $\Phi_{1/2}$ has a remarkable influence on the coverage range and pattern shape of the lam-bertian light source. By choosing narrower $\Phi_{1/2}$, we can directly increase the service range.

$$\mathbf{m} = -\frac{\ln 2}{\ln(\cos(\Phi_{1/2}))} \quad (3.3)$$

By defining the internal refractive index (n) of the optical lens used in the receiver side, the optical concentrator gain $g(\psi)$ in (3.2) can be calculated from the following formula:

$$g(\psi) = \begin{cases} \frac{n^2}{\sin^2(\theta_c)}, & 0 < \psi < \psi_c \\ 0, & elsewhere \end{cases}. \quad (3.4)$$

Finally, the average received optical power P_r is a result of the additive path-loss to the transmitted power in dB scale

$$P_r = \dot{P}_t + H(0), \quad (3.5)$$

which results in signal component at the receiver side

$$S = \gamma^2 P_r^2. \quad (3.6)$$

3.2.2 VLC noise model for outdoor applications

Deploying VLC for an outdoor application, there are discrete and extended background sources are the main two sources of the daylight noise. The first source is corresponding to the sun optical beam and it is considered as the

Table 3.1: Simulation Model Parameters

Application	Range[m]
Filter Transmission coefficient, T_s	1.0
Incidence/Irradiance Angle, φ, ψ	40°
Photo Diode Responitivity, γ	0.56
Semi Angle at Half Power, $\Phi_{1/2}$	60°
Open Loop voltage Gain, G	10
Noise Bandwidth Factor, I_2	10 MHz
Receiver Field of View, ψ_c	60°
Detector Physical Area, A_{ph}	1 cm ²
Output Optical Power, P_t	170 mw
Electrical Bandwidth, B	10 MHz
FET Transconductence, g_m	30 ms
Ambient Noise Power, P_{bg}	0.012 mw
Maximum steer angle, δ_{Max}	30°
Refractive Index, n	1.5
Wavelength, λ	680 nm

main challenge in any optical receiver design, based on the fact that this noise may or may not be in the LoS of the receiver, and considering as small as few meters (less than 10 m) of inter-vehicle distance in a platoon. We also assume here that the receiver is never directly exposed to the discrete noise (sun). The extended background source assumed to have isotropic behavior and equally effect to the entire received spectrum since the origin of this noise is the skylight and the light scattering and many reflections [110], therefore it can be detected in any optical receiver FOV.

The irradiance as a function of the spectral irradiance $W(\lambda, T_B)$ that falls within the spectral range of the receiver optical filter is

$$E_{det} = \int_{\lambda_1}^{\lambda_2} W(\lambda, T_B) d\lambda. \quad (3.7)$$

Therefore, the background P_{bg} noise power detected by the optical receiver physical area is given by:

$$P_{bg} = E_{det} T_s A_{ph} n^2. \quad (3.8)$$

Total noise variance N is the sum of both shot and thermal noise by combining both (3.10) and (3.11) which yields in

$$N = \sigma_{shot}^2 + \sigma_{thermal}^2. \quad (3.9)$$

Shot noise in this model represents the noise contributions from both LED vehicle rear light and the intense ambient light during the day time as the following;

$$\sigma_{shot}^2 = 2q\gamma(P_r Signal)B + 2q\gamma P_{bg} I_2 B, \quad (3.10)$$

where q is the electronic charge, B is the equivalent noise rectangular transmitter pulse shape [111]. The background noise power P_{bg} is determined using (3.8) as daytime dependent variable reaches its peak at 02:00 pm [82].

Thermal noise is uniformly distributed across the frequency spectrum and can be given by:

$$\sigma_{thermal}^2 = \frac{8\pi kT_A}{G} \eta A I_2 B^2 + \frac{16\pi^2 kT_A \Gamma}{g_m} \eta^2 A_{ph}^2 I_3 B^3, \quad (3.11)$$

where T_A is the environment temperature, G is the open-loop voltage gain, η is the channel noise factor, g_m is the transconductance and I_3 is the noise bandwidth factor for a full raised-cosine pulse shape [111]. All of the modeled parameters are tabulated in Table 3.1. Lastly, we can define the receiver electrical SNR by finding the power ratio between the signal in (3.6) and the total background noise in (3.9)

$$SNR = \frac{S}{N}. \quad (3.12)$$

BER performance is related to both coding and the chosen modulation techniques, due to the simplicity of implementation, we consider for the studied model a binary level modulation scheme consisting of two equally likely symbols OOK and without choosing any specific FEC channel coding.

$$BER = Q\left(\sqrt{SNR}\right). \quad (3.13)$$

3.3 Platoon control model

In this section, we first present the vehicle's kinematic model that govern the motion of a vehicle and which is used in our simulations. Afterwards, we present a longitudinal controller based on a Proportional Integral (PI) controller and the proposed lateral controller based on a constant curvature approach.

3.3.1 Kinematic model

For simplicity, and as depicted in Figure 3.4, we approximate the kinematics of Ackerman steering mechanism of the vehicle to be a bicycle model, which

has the same instantaneous center of rotation (ICR), where δ , l and θ are respectively the steering angle, wheelbase, and the orientation. In an inertial frame Fxy , a vehicle position is defined by a position (X, Y) and orientation θ . The kinematic model which governs the vehicle motion is given by:

$$\begin{cases} \dot{X} = V \times \cos(\theta) \\ \dot{Y} = V \times \sin(\theta) \\ \dot{\theta} = V \times \frac{\tan(\delta)}{l} \end{cases} . \quad (3.14)$$

Figure 3.3 shows a plan view of two vehicles forming a platoon and moving on a horizontal plan. These two vehicles have a longitudinal distance Δx , a lateral distance Δy and an inter-vehicle distance d . In this study, we are interested in testing the basic tracking scenario of vehicles in a VLC-based platoon system, where the main objective of the controllers is to follow the trajectory of the leader vehicle by maintaining a constant inter-vehicle distance.

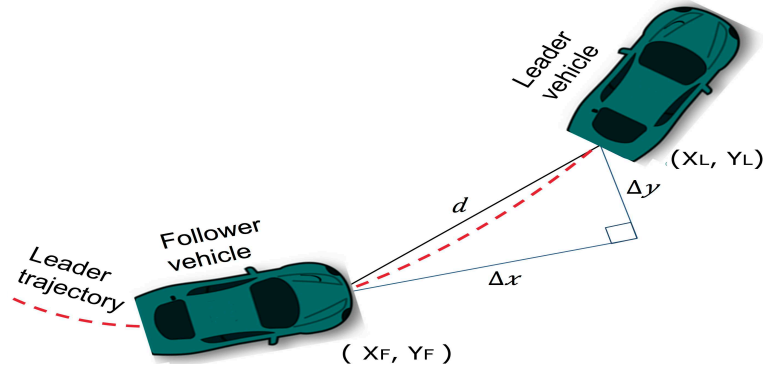

Figure 3.3: Plan view for a platoon of two vehicles (Leader and Follower) which have the longitudinal (Δx) and lateral (Δy) inter-vehicle distances.

3.3.2 Longitudinal and lateral control

In order to maintain a constant inter-vehicle distance reference d_{ref} , we use a standard proportional integral controller to control the velocity $V_F(t)$ at time t of the follower vehicle. For a measured inter-vehicle distance at time t ($d(t)$), the velocity of the follower vehicle is given by the following formula:

$$V_F(t) = K_p \cdot e(t) + K_i \cdot \int_0^t e(\tau) d\tau, \quad (3.15)$$

where K_p and K_i are respectively the proportional and the integral gains, the error $e(t)$ is given by:

$$e(t) = d_{ref} - d(t). \quad (3.16)$$

The proposed lateral controller is based on a constant curvature approach, which allows the follower vehicle to move from its initial position (X_F, Y_F) towards the leader vehicle's position (X_L, Y_L) with a constant steer angle δ as shown in Figure 3.4. The steer angle δ is given by:

$$\delta = \text{atan} \left(\frac{2 \cdot l \cdot \sin(\phi)}{\sqrt{\Delta x^2 + \Delta y^2}} \right), \quad (3.17)$$

where

$$\begin{cases} \phi = \text{atan} \left(\frac{\Delta y}{\Delta x} \right) - \theta \\ \Delta x = X_L - X_F \\ \Delta y = Y_L - Y_F \end{cases}. \quad (3.18)$$

Having a constant steer angle δ , the vehicle's trajectory is a circle with a radius R such as

$$l = R \cdot \tan(\delta), \quad (3.19)$$

and since both positions (X_F, Y_F) and (X_L, Y_L) must be on the circle depicted in Figure 3.4, the triangle defined by the three points (X_F, Y_F) , (X_L, Y_L) and (X', Y') is square, thus

$$\sqrt{\Delta x^2 + \Delta y^2} = 2 \cdot R \cdot \sin(\phi). \quad (3.20)$$

From (3.19) and (3.20), we can obtain the steering angle given by (3.17). Also from Figure 3.4 we can conclude that:

$$\tan(\phi + \theta) = \frac{\Delta y}{\Delta x}, \quad (3.21)$$

which leads us back to the formula presented in (3.18).

3.4 Performance evaluation

In this section, BER simulation results of the VLC channel are presented along with simulation results obtained from the Simulink model which employing the VLC characteristics to control a platoon of autonomous vehicles.

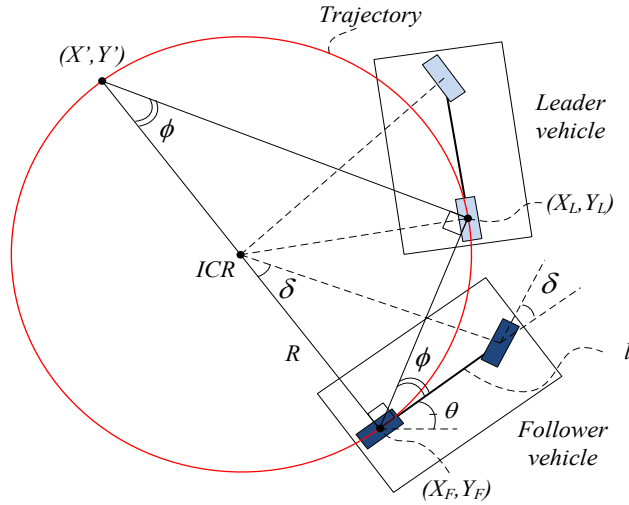

Figure 3.4: Circle trajectory between the follower vehicle's position (X_F, Y_F) and the leader vehicle's position (X_L, Y_L) with a constant steer angle δ .

3.4.1 Optical channel performance

We determine the system performance through the BER plot for different incidence angle, electrical bandwidth and daytime noise in order to determine the feasibility of platooning control using VLC. For numerical illustration, we assume the LED rear light with a dimension of 0.1 m^2 , where both receiver and transmitter had the same height, with no vertical inclination angle and aligned with incidence and irradiance angles as illustrated in Figure 3.2. The properties of the simulated transmitter and receiver are tabulated in Table 3.1.

Considering the OOK modulation scheme, 13.6 dB of SNR which is equivalent to $\text{BER} = 10^{-6}$ is the defined performance requirement for stable communication link; any configuration may result in $\text{BER} > 10^{-6}$ will be considered as a connection failure. Figure 3.5 compares the BER of different separation distance d for the three main parameters of the studied model, Incidence Angle φ , Bandwidth B , and Ambient Noise Power P_{bg} , respectively.

The simulation results depicted in Figure 3.5.a indicate that 11 meters improvement of the separation distance between platooned vehicles can be achieved when the incidence angle of the transmitter decreases from 60° to 20° . Moreover, the obtained results consider the presence of the worst ambient noise level P_{bg} at 02:00 PM and for $B=10 \text{ MHz}$, which explains the strong influence of φ in (3.2).

The major drawback of any optical receiver is the relatively wide optical bandwidth, which allows the receiver to collect a significant amount of background noise and increases the ambient induced shot noise. Figure 3.5.b illustrate the compromise between the optical coverage range and the electrical bandwidth of the receiver. For $\varphi = 40^\circ$ and at background noise as in Figure 3.5.a, the separation distance can reach up to 13 meters instead of only 4 meters if the chosen B reduced from 100 Mhz to 1 MHz.

Since all the simulation scenarios involving the SPCTRAL2 ambient noise model [82], we can predict the background noise power collected by the receiver with relatively high accuracy and for any day time, excluding the sun direct expose scenario. From Figure 3.5.c, the incidence angle is fixed to be 40° and $B = 10$ Mhz, it was interesting to remark that the separation distance can not exceed 7 meters if the vehicles are communicating during the ambient noise peak time 2 : 00 pm. These obtained results due to the impact of the generated noise current as depicted in (3.10).

Figure 3.5.d illustrates the optimal chosen values of the three main parameters in this study, P_{bg} , B and φ in order to achieve up to 7 meters inter-vehicle distance maintaining $BER \leq 10^{-6}$. The chosen values support Δy up to 5.36 meters and covering the average roads lane width.

Finally, it should be noted that the calculation in this study is made for 1 cm^2 PD physical area and using single high intense LED. Communication distance can be largely increased by increasing the number of the LED's or the optical receiver physical aperture. Moreover, we expect remarkable improvement of received signal quality using proper channel error coding together with more advanced optical modulation techniques, such as VPPM.

3.4.2 Platoon control performance

For simplicity, we simulate a platoon of four vehicles with 2 m/s constant speed. The initial inter-vehicle distance is 3 meters, where the desired inter-vehicle distance d_{ref} of 2 meters, that falls in the range of the stable communication link offered by VLC model.

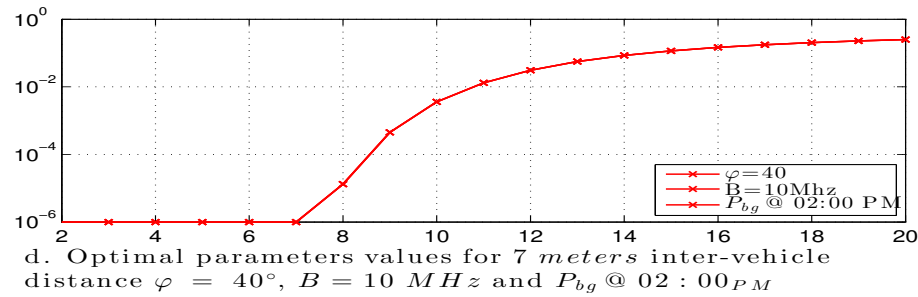
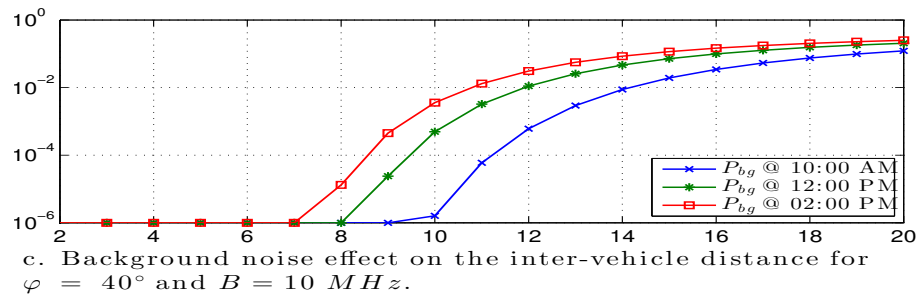
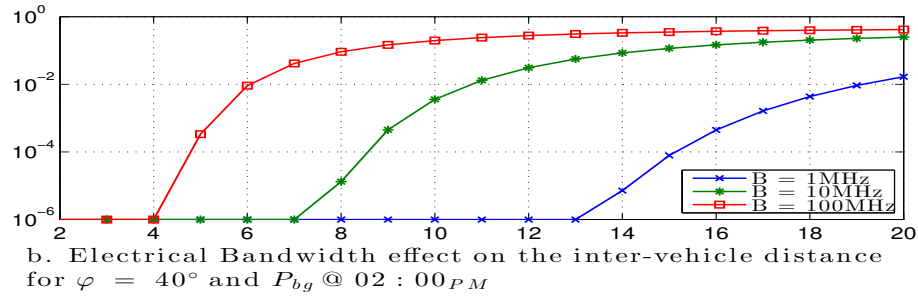
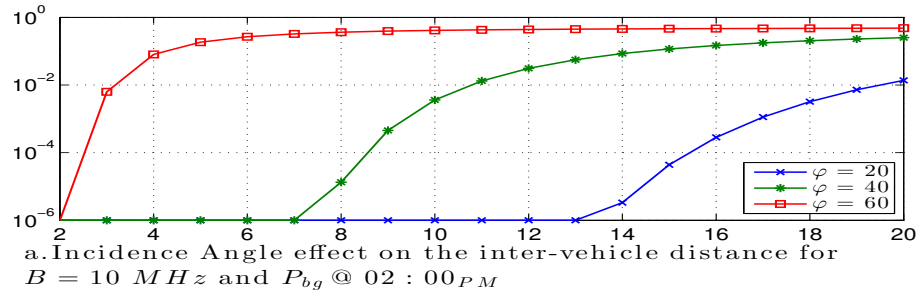

Figure 3.5: Performance of the optical wireless channel for the three main parameters as a function of BER and the platoon inter-vehicle distance. a. Incidence Angle (φ) effect, b. Electrical Bandwidth limitation. c. Ambient Noise Power P_{bg} influence for different day time. d. represent the optimal parameter values to achieve stable VLC communication for inter-vehicle distance up to 7 meters.

Assuming that each vehicle knows its position, and the preceding vehicle will pass the required information to the next vehicle in the queue using VLC. Thus, the received information is processed to calculate the Δx and Δy distances and compute the required velocity, steering angle and position values as in 3.18. Afterward, the system will maintain a constant inter-vehicle distance of 2 meters based on the chosen velocity. The longitudinal and lateral controllers require a local link in the sense that every follower vehicle should receive information from the vehicle ahead. The controller is wholly dependent on these local links.

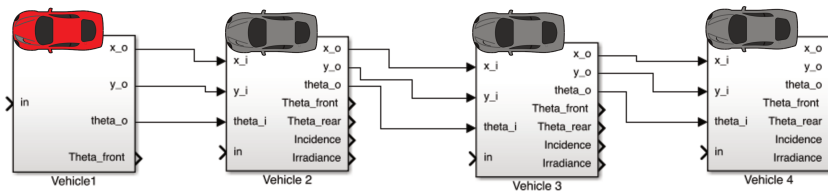

Figure 3.6: SIMULINK Platooning control using VLC model.

To illustrate this, two scenarios were built in SIMULINK, where each block in Figure 3.6 contain a vehicle model described in (3.14). Moreover, vehicle controllers implemented using (3.15) and (3.17), except the first vehicle, which is controlled by a constant velocity and steering angle.

Simulations show that the proposed lateral controller have a good performance with less processing time compared to other more sophisticated controllers. The maximum lateral error, which is the maximum spacing between the trajectory of the head vehicle and the tail vehicle, found to be less than 20 cm.

By driving platoon vehicles using the first scenario illustrated by Trajectory 1 in Figure 3.7, the incidence, and irradiance angles are continuously less than φ_c all along the trajectory path, allowing the queued vehicles to preserve the requirements of the optical hardware. Moreover, as it can be seen in the angles variation over the trajectory in Figure 3.8(a), where the incidence and irradiance angles continuously maintaining the FOV and BER strict requirement for a road curvature does not exceed 22° .

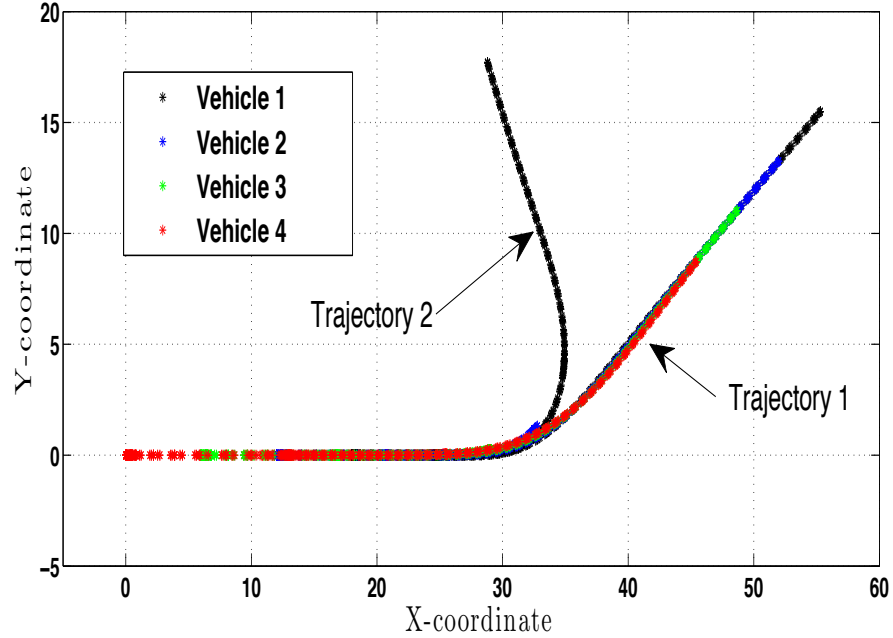
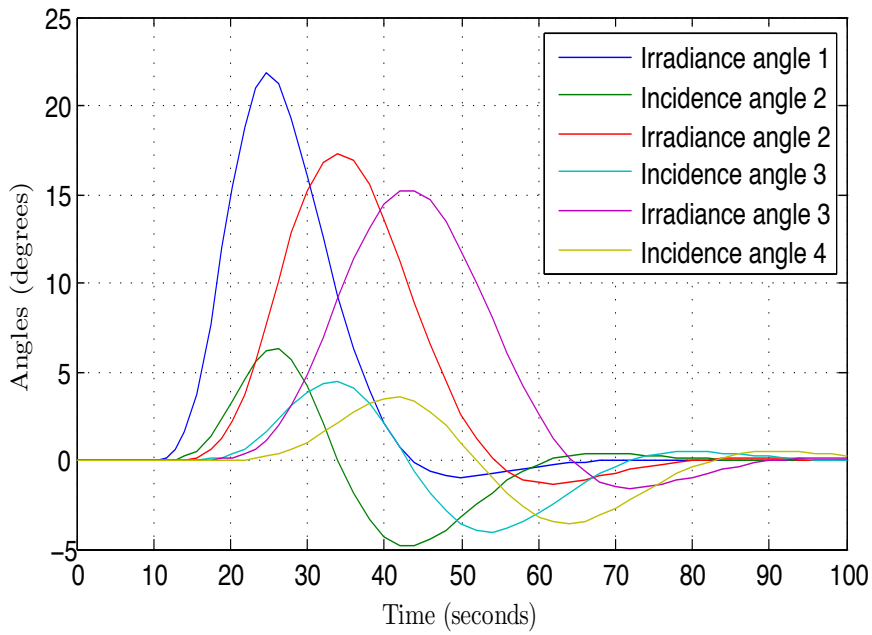

Figure 3.7: Four vehicles platoon model in *SIMULNK* for two trajectories. Trajectory 1 illustrates the success scenario when the queued vehicle fall in the FOV of each other. Trajectory 2 illustrates the failure scenario when the trajectory curvature will cause out of FOV.

The second scenario in Figure 3.7-trajectory 2, taking into account the communication link limits and is expressed by sending a stop (communication failure) signal to any vehicle located just after the link disconnection. For incidence or irradiance angles larger than 40° , the vehicles 2, 3 and 4 have been stopped after losing the connection between the second vehicle and the leading one. These results are depicted in Figure 3.8(b), where the corresponding angles of the 2nd, 3rd and 4th vehicles do not change when the 2nd vehicle incidence angle exceeding the 40° limit. In this case, the decision is made that BER is higher than 10^{-6} , where the next two vehicles will stop immediately after receiving zero speed information from vehicle 2.

Simulation results show the direct impact of the viewing angle and prove that as long as the road curvature does not exceed the chosen φ , which is a considerable angle; VLC can efficiently support platooning. We also confirm that our simulated controllers can robust for vehicles with speed up to 10 m/s.



(a) Angles variations over Trajectory 1.

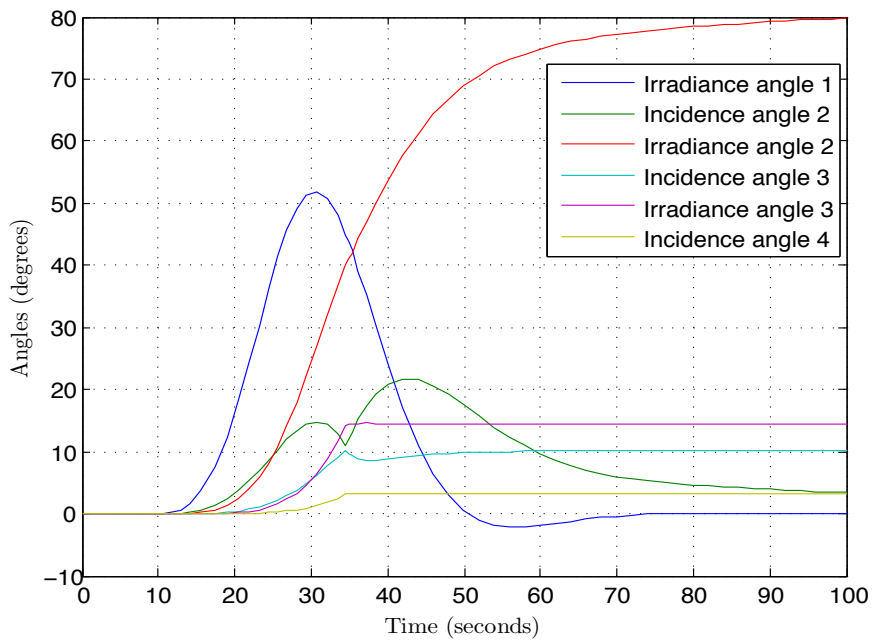

(b) Angles variations over Trajectory 2.

Figure 3.8: Incidence and Irradiance angles variations over both success and failure trajectories for 4 platooned vehicles.

3.5 Enhancing the field of view limitation

In our previous study [84], we investigated analytical model suggesting to employ the vehicles commercial rear lights as a reliable communication link. Ambient noise and the FOV limitations were the main two challenges may prevent using VLC for any ITS application and specifically for VLC-based platooning.

Many solutions were proposed to overcome the ambient noise presence [82] for the relatively short range inter-vehicle distance between platoon members. Even though, FOV which is expressed as the maximum angular size of the PD remained as the main challenge when VLC-based platoon members follow sharp trajectories. In this section, we aim to present a tracking alike method using independent optical arm controller in order to enhance the FOV limitation. The proposed method is meant to compensating the increase in both incidence and irradiance angle smoothly and in real time. This method will ensure the condition of the described angles in Figure 3.2 for stable VLC link as the following:

$$0 \leq (\psi \ \&\& \ \varphi) \leq \theta_c \quad (3.22)$$

where ψ and φ represent the incidence and irradiance angular variation, and θ_c is the maximum critical FOV angle.

3.5.1 Proposed solution to enhance the FOV limitation

Exchanging information about the relative directional position of each member of the platoon, together with front and rear-facing directions of each vehicle, can be very useful data to build a smooth geometrical-based mechanism compensating the FOV misalignment between platoon members. This exchanged information can be processed in each vehicle controller, and generate a real-time compensation movement of both VLC transmitter and receiver.

The proposed mechanism aims to ensure that any increase in both incidence and irradiance angles will never exceed the VLC system FOV limitation.

Figure 3.9 shows a simple platoon consists of two vehicles, where R represents the mounted optical receiver/transmitter arm length on each vehicle, l and d are respectively the vehicle length and the inter-vehicle distance between two vehicles. The angles between vehicles axis and the reference

x -axis for the vehicles are θ_2 and θ_1 respectively, where θ_F and θ_R represent the front and rear angles.

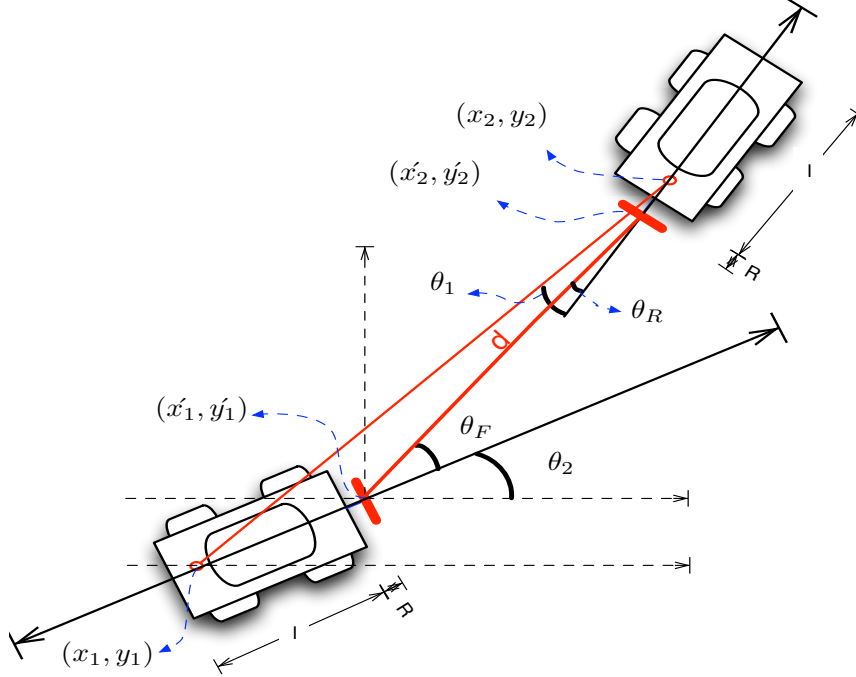

Figure 3.9: Two vehicles VLC-based platoon ray tracing model.

As in any communication-based platoon, we assume that each vehicle is equipped with a positioning system providing the position data (x_2, y_2) and (x_1, y_1) as depicted in Figure 3.9. The distance d can be calculated by defining the relative coordinates (x'_1, y'_1) and (x'_2, y'_2) , which represents the coordination of the mounted optical receiver and transmitter.

$$\begin{cases} x'_1 = x_1 - R \times \cos(\theta_1) \\ y'_1 = y_1 - R \times \sin(\theta_1) \end{cases}, \quad (3.23)$$

$$\begin{cases} x'_2 = x_2 + (l + R) \times \cos(\theta_2) \\ y'_2 = y_2 + (l + R) \times \sin(\theta_2) \end{cases}. \quad (3.24)$$

These relative coordinates can be expressed as two relative distance vectors in both x and y coordinates,

$$\begin{cases} x_{rel} = x'_1 - x'_2 \\ y_{rel} = y'_1 - y'_2 \end{cases}, \quad (3.25)$$

where the square law of those two relative vectors, is the shortest LoS distance between the mounted LED on the rear of vehicle 1 and the PD moun-

ted on the front of vehicle 2.

$$d = \sqrt{(x_{rel})^2 + (y_{rel})^2} . \quad (3.26)$$

Using the result from (3.25), the front angle of the second vehicle can be expressed as the following:

$$\theta_F = \text{atan}\left(\frac{y_{rel}}{x_{rel}}\right) , \quad (3.27)$$

while the rear angle of the head vehicle is:

$$\theta_R = \theta_1 - (\theta_F + \theta_2) . \quad (3.28)$$

After defining the relations between the vehicles orientation and both front and rear angles $(\theta_R, \theta_F) \rightarrow f(\theta_2, \theta_1)$, we can express the optimal compensation value for both incidence and irradiance angles as the following:

$$\begin{cases} \psi_x = \alpha\theta_F \\ \varphi_x = -\alpha\theta_R \end{cases} , \quad (3.29)$$

where α represent the whole platoon direction by comparing between the head and the follower relative coordinates, which allow the mounted optical component arms controller to define the compensation direction either clockwise or counterclockwise.

$$\begin{cases} \alpha = +1, & y_2 > y_1 & \text{Counterclockwise} \\ \alpha = 0, & y_2 = y_1 & \text{No-compensation.} \\ \alpha = -1, & y_2 < y_1 & \text{Clockwise} \end{cases} . \quad (3.30)$$

As can be verified by the simulations in the previous section, a real-time compensation of the irradiance and incidence angles, at the same time inheriting the smooth orientation change of both head and tail vehicles, will expand the FOV limitation condition for stable VLC link as the following:

$$0 \leq (\psi \ \& \ \varphi) \leq \theta_c + \theta_{arm} \quad (3.31)$$

where θ_{arm} is the maximum angle which can be achieved by tuning the arms in Figure 3.9 with respect to the vehicles axes and depending on the arm length.

3.5.2 Performance evaluation

Through this section, the limitation of the ordinary FOV, together with the proposed enhancement method simulation results are presented for different trajectories, and different applied θ_{arm} to each member of the platoon. The variation of both θ_F and θ_R were analyzed, where the influence of the compensation incidence and irradiance angles is observed and compared with the results in [84].

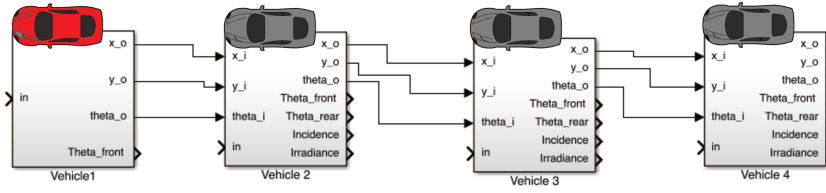

Figure 3.10: VLC-based Platoon SIMULINK model for four vehicles, each vehicle consist of longitudinal controller, lateral controller, VLC model for path loss calculation and an a FOV enhancement controller.

Assuming that each vehicle knows its position, and the preceding vehicle will relay the required information to the next one in the queue using VLC link, we simulate a platoon of four vehicles have an initial inter-vehicle distance of 4 meters and a constant speed of $20m/s$. Moreover, the chosen inter-vehicle distance falls in the range of the stable communication link offered by the proposed VLC model for platooning application. Figure 3.10 illustrates four vehicles VLC-based platoon SIMULINK model, where each block contains a vehicle longitudinal and lateral controller, together with a VLC channel model. In addition to the SIMULINK model presented in [84], we added an independent compensation arms-controller and sharper trajectories generator.

As soon as the variation in θ_F and θ_R which are expressing the trajectory sharpness do not exceed the value of θ_{arm} , the compensation method works smoothly by applying the compensation angles ψ_x and φ_x and results in zero value for both ψ and φ .

Moreover, the obtained results are not only extending the FOV limitation and ensure the continuity of the LoS between the platoon members, but it remarkably improves the optical path loss; where the two terms $\cos^m(\varphi)$ and $\cos(\psi)$ in (3.2) will have no influence on the optical DC Gain calculation $H(0)$.

$$H(0) = \begin{cases} \frac{(m+1)A_{ph}}{2\pi d^2} T_{sg}(\psi) & 0 \leq (\psi \ \&\& \ \varphi) \leq \theta_c, \\ 0 & elsewhere \end{cases}, \quad (3.32)$$

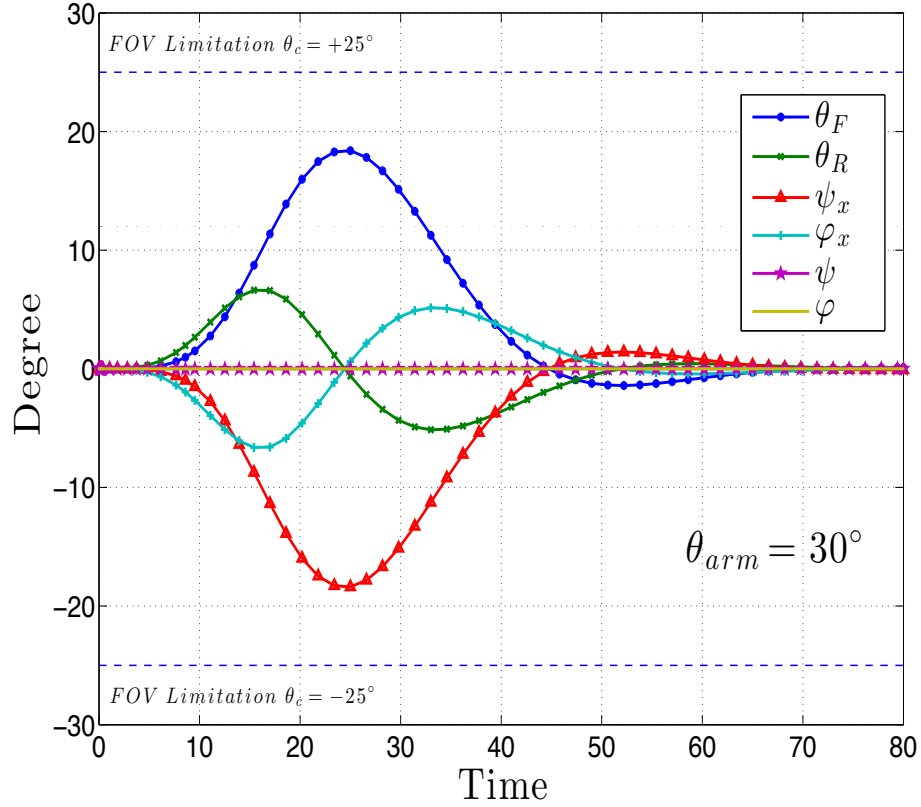

Figure 3.11: The angular variation of the vehicle front (θ_F), vehicle rear (θ_R), incidence compensation angle (ψ_x), irradiance compensation angle (φ_x), incidence angle (ψ) and irradiance angle (φ) between every two members in the VLC-based platoon and following trajectory 2 in Figure 3.12.

Figure 3.11 shows simulation results of the smooth compensation method, based on the exchanged information of the relative orientation and positioning of each member of the platoon. The results are expressing the trajectories 2 in Figure 3.13 and Figure 3.14, where θ_F is never exceeding θ_{arm} all along the platoon path, and result in full compensation.

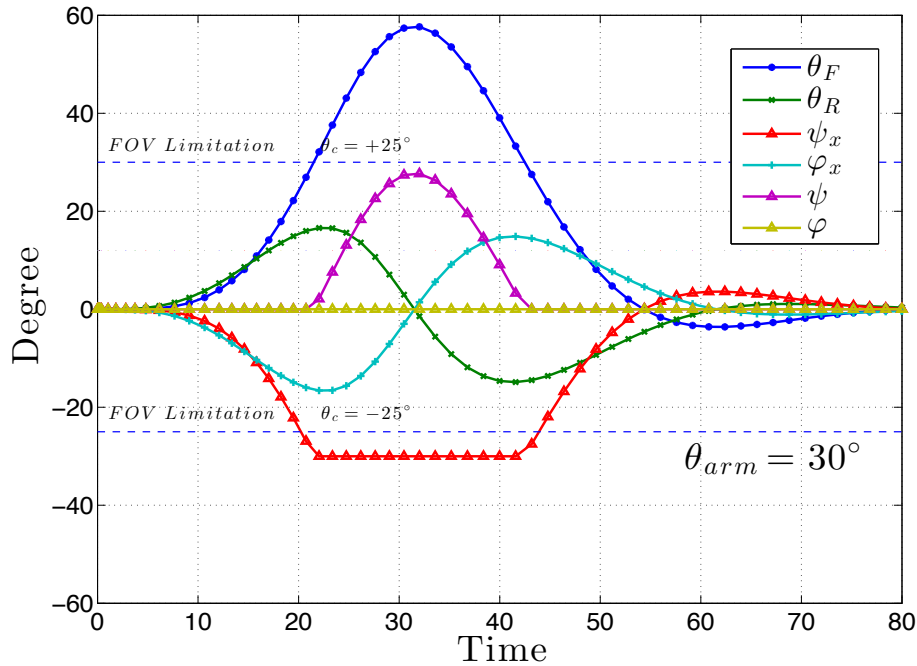

Figure 3.12: The angular variation of the vehicle front (θ_F), vehicle rear (θ_R), incidence compensation angle (ψ_x), irradiance compensation angle (φ_x), incidence angle (ψ) and irradiance angle (φ) between two members in the VLC-based platoon following trajectory 3 in Figure 3.12.

The scenario where θ_F or θ_R is exceeding θ_{arm} can be simulated either by reducing θ_{arm} or applying sharper curvature. Figure 3.12 shows the smooth build up in ψ for compensation angle limit of 30° , while the front angle of the second vehicle is reaching up to 58° . The build up in ψ is a result of adapting the trajectory 3 in Figure 3.13. Although that ψ is increasing for such sharp trajectories, the limitation condition of FOV is still maintained all along the trajectory path for all the platoon member, with a slight influence on the calculated optical signal path loss.

Comparing the results illustrated in Figures 3.13 and 3.14 is enough to understand the impact of extending the FOV limitation for VLC-based platoon. Trajectory 2 and 3 in Figure 3.13 caused a total signal loss scenario for any optical communication-based platoon system, which was the defined limits of the optical receiver in [84]. Applying the proposed enhancement method to the same scenarios and dealing with the same physical limitations of the parameters in the mentioned study, results in an efficient compensation of both ψ and φ .

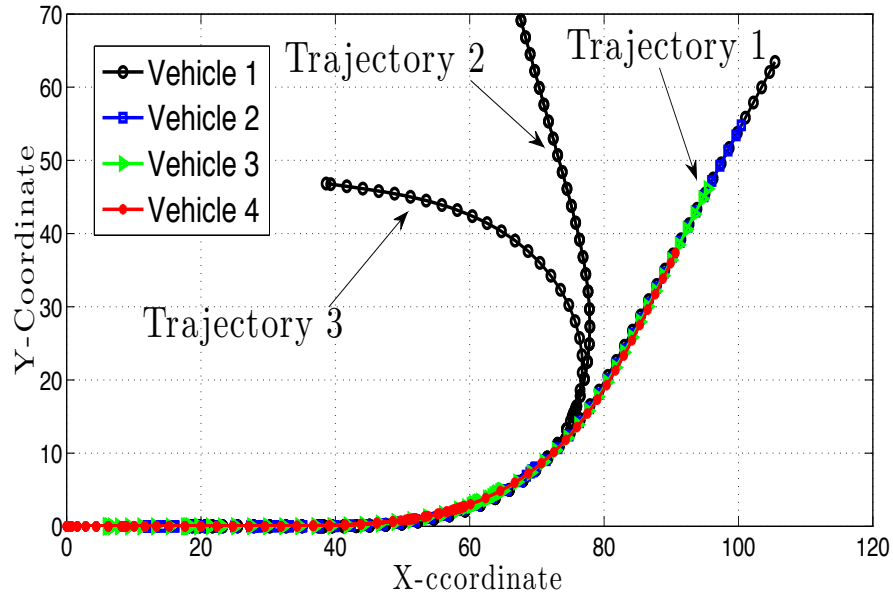

Figure 3.13: Four vehicles platoon model in SIMULNK for three different trajectories. Trajectory 1 illustrate the success scenario when the queued vehicle fall in the FOV of each other. Trajectory 2 and 3 illustrate the failure scenario before applying the enhancement method and when the θ_F or θ_R are exceeding θ_c limits. Both coordinates represented in meter.

The simulation results for many other different scenarios performed using our proposal have confirmed that VLC-based platoon is no longer limited to the receiver FOV. Moreover, choosing the right value for θ_{arm} , θ_c will enable the VLC-based platoon members to overcome any trajectory as soon as the presence of blocking obstacle is not assumed.

3.6 Conclusion

Throughout the VLC channel modeling for ITS applications, we have investigated analytical model; suggesting to employ the vehicles commercial rear lights as a reliable communication link. Furthermore, the main parameters that have significant impacts on the performances of the outdoor VLC system suiting platooning application were defined. The variations of these parameters such as incidence angle, receiver bandwidth, and daytime noise were investigated and compared for different inter-vehicle distances. The simulation of the studied model shows that a BER of 10^{-6} which is equivalent to SNR around 14.6 dB is achievable for separation distance between platoon vehicles up to 7 meters by using a single HLED.

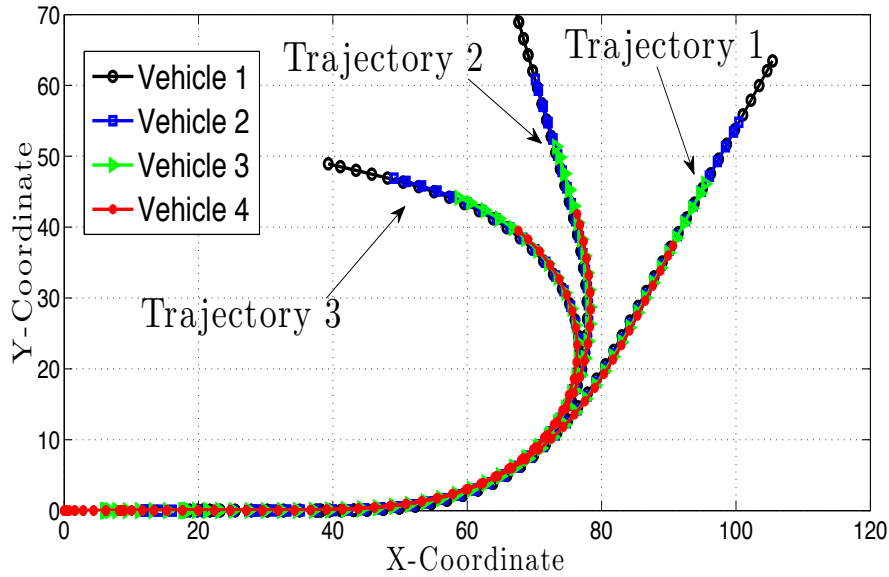

Figure 3.14: Four vehicles platoon model in SIMULNK for three different trajectories. Trajectory 1,2 and 3 illustrate the success scenario when the FOV enhancement method is applied, where θ_F and θ_R never exceeding θ_c . Both coordinates represented in meter.

Matlab/SIMULINK based platoon model with a longitudinal and lateral controllers was implemented for individual vehicles and developed for two scenarios in order to point out the problem of losing VLC communication in different curved trajectories. Moreover, we propose a tracking alike solution to test the technology limitations for a vehicular VLC-based platooning platform, where we tackled the issue of a VLC-based autonomous platoon going through sharp curvatures and intersection areas. The simulation results proved that our proposed method was able to compensate the trajectories influence on the optical incidence and irradiance angles efficiently and without deploying any tracking methods. A smooth and real-time response was observed in our simulation outputs and resulted in a remarkable reduction of the total optical path loss between any two members of the platoon.

Finally, and as it will be explained and demonstrated in the subsequent chapters. We aim to establish a complementary corporation between VLC, RF solutions and vehicular sensors data. The different technologies can be working together to support the diverse requirements of the platooning application using VLC in dense traffic conditions while switching to RF or even sensor-based technology for long range or sharp road curvatures.

CHAPTER 4

VLC prototype development and evaluation for platooning

Contents

4.1	Introduction	67
4.2	General system description	67
4.3	VLC system implementation	68
4.3.1	System hardware	69
4.3.1.1	VLC transmitter	69
4.3.1.2	VLC receiver	78
4.3.2	System software	86
4.3.2.1	Data encoding	87
4.3.2.2	Mchr3k Arduino manchester encoding library	88
4.3.2.3	Data payload	88
4.3.2.4	Hardware interface	89
4.3.2.5	RTMaps components	90
4.4	VLC prototype evaluation	91
4.4.1	Experimental setup	91
4.4.2	VLC link experimental results	94
4.4.2.1	Prototype calibration	94
4.4.2.2	VLC path-loss model evaluation	96
4.4.2.3	Packets transmission evaluation	98
4.5	Conclusion	101

Résumé du chapitre

Dans ce chapitre, nous présentons le développement et la mise en œuvre d'un prototype d'extérieur de VLC peu coûteux, à faible latence et simple qui peut être installé comme un système d'éclairage à l'arrière de véhicule. Le contenu du chapitre étend notre étude précédente sur la modélisation VLC, où l'implémentation considère deux éléments clés nécessaires pour reconnaître la technologie VLC pour les applications ITS:

1. La possibilité d'utiliser VLC dans les conditions extérieures et sous contraintes causés principalement par le bruit ambiant et des situations de conduite en extérieur.
2. La capacité de l'implémentation prévue pour satisfaire aux exigences de sécurité des applications basées sur convois, dont la liaison de communication pour une telle application doit assurer la latence minimale possible avec portée de communication relativement appropriée.

Le chapitre poursuit comme la suite. Nous commençons par la description du processus de prototypage VLC, qui consiste à utiliser des composants disponibles sur le marché, en respectant le facteur de forme standard du système d'éclairage des véhicules. En adoptant des techniques précises du filtrage optique à l'extrémité du récepteur, nous anticipons l'augmentation de la robustesse du prototype contre le bruit ambiant. Puisque l'une des principales intentions de conception est d'assurer la double fonctionnalité de la source lumineuse, nous introduisons l'utilisation du codage linéaire conventionnel et de la technique de modulation pour assurer la continuité de l'émission lumineuse.

Comme on le discutera plus en détail, et en raison des limitations de débit de données matérielles du système, la construction d'un format de paquet particulier utilisant un nombre minimal des bits de commande est une tâche essentielle afin de permettre au système VLC d'échanger le statut véhiculaire, tel qu'ID, vitesse, direction et position. Enfin, nous effectuons une évaluation du prototype VLC pour les niveaux de signal et de paquets dans les conditions de lumière du jour.

4.1 Introduction

In this chapter, we present the development and implementation of a low-cost, low-latency and simple outdoor VLC prototype that can be installed as a vehicular tail-lighting system. The chapter content extends our previous study on VLC modeling, where the implementation considers two key elements necessary to recognize VLC technology for ITS applications:

1. The feasibility to use VLC for outdoor conditions and under constraints posed mainly by the ambient noise and outdoor driving situations.
2. The capability of the intended implementation to satisfy the covoy-based applications safety requirements, where the communication link for such application must ensure the minimum possible latency with a relatively suitable communication range.

The chapter proceeds as follows. We start by describing the VLC prototyping process, which meant to use off-the-shelf components, with the observance of the standard feasible form factor of the vehicular lighting system. By adopting precise optical filtering techniques at the receiver end, we anticipate increasing of the prototype robustness against ambient noise. Since one of the primary design intentions is to ensure the light source dual functionality, we introduce the usage of conventional line coding and modulation technique to ensure light emission continuity.

As it will be further discussed, and due to the system hardware data-rate limitations, the construction of a particular packet format using the minimum possible controlling bits is an essential task to allow the VLC system to efficiently exchange the vehicular status, such as (ID's, speed, steering, and position). Finally, we perform an evaluation of VLC prototype for both the signal and packet levels under daylight conditions.

4.2 General system description

We develop a VLC platform that exploits the vehicular tail-lights system, reducing both the cost and the installation complexity. As discussed in Chapter 3, the constant spacing model suggests relatively high dense vehicular scenarios that can be managed efficiently using platoon formations. Although that using radio technology for intra-platoon communication has been previously studied, we had the conclusion in Chapter 2 that the improvement of the traffic capacity can also dramatically increase radio channel

congestion, which negatively affects the safety requirements.

Ensuring the safety of convey-based applications with the presence of the trade-off between road capacity and channel congestion was the main motivation behind suggesting the supportive VLC for V2V communication between platoon members, in addition to the radio communication deployment.

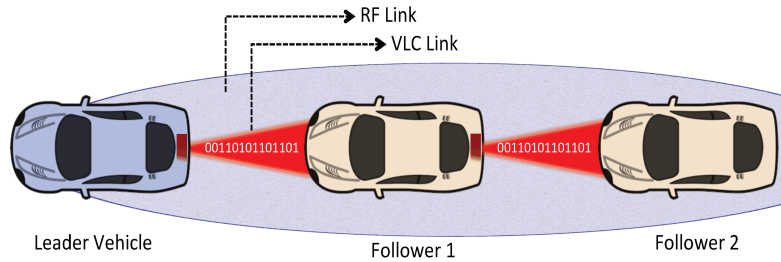

Figure 4.1: General description of the proposed communication system between platoon members using both VLC and RF communications in order to reduce channel congestion.

The proposed scenario deploys the vehicular tail-lighting system to exchange information between platoon members accompanied with radio communication as depicted in Figure 4.1 which is expected to play a fundamental role in reducing the channel congestion of the RF channel.

4.3 VLC system implementation

As it will be further detailed in the subsequent sections, for realizing the VLC data transmission and vehicular lighting functionality, the optical transmitter must use high switching light sources such as LEDs, where the wavelength of these LEDs light emission must be in the red color visible spectrum range. Especially when the break lights are used. As for the receiver end, the main concern will be to maximize the SNR level of the acquired data by the PD with the presence of severe ambient noise level.

Both transmitter and receiver ends contain an electrical and optical stages components as depicted in Figure 4.2, where the channel is the communication medium in-between. At the transmission side, the binary data are modulated and converted into an electrical signal; then this signal is transformed to an optical beam using LEDs to transmit the information over the VLC channel. After propagated through the wireless medium, the VLC

receiver captures the optical signal using a PD, which converts the optical signal into an electrical one before demodulation.

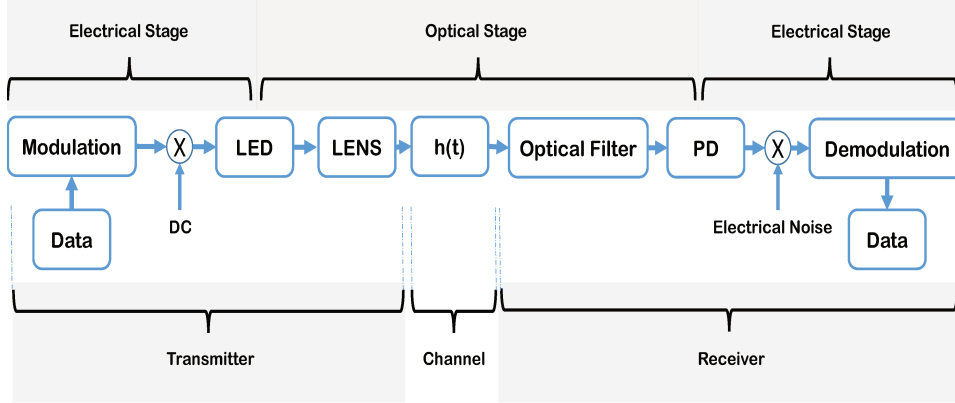

Figure 4.2: High-level overview of the VLC electrical and optical stages.

4.3.1 System hardware

This section is dedicated to describing our VLC system hardware. All the discussed components for transmitter and receiver units are chosen carefully to operate in outdoor conditions and meant to ensure a cost-efficiency and at the same time the suitability implementation for platooning application.

4.3.1.1 VLC transmitter

The VLC transmitter is the end responsible for transforming the digital data into an optical stream of pulses that can be then sent over the optical channel. The design of the VLC transmitter in ITS meant to enable dual functionality, light emitting and data transmission. However, it is important that when a light source is used simultaneously to modulate data, there will be no effect on the overall illumination and/or signaling functionality. To maintain the harmony between these dual functionalities, the VLC transmitter unit must be designed in a way, which guarantees that there will be no noticeable light flickering by the human eye.

The transmitter unit is composed of three main physical components, LED's with mounted focusing lenses on the top of each (as depicted in Figure 4.3), a driving circuit, and an Arduino micro-controller which is represented by the electrical stage in Figure 4.2. In this implementation, an array of 3Watt

HLED's was used to illuminate red-light data beam that was chosen to represent the vehicle taillight.

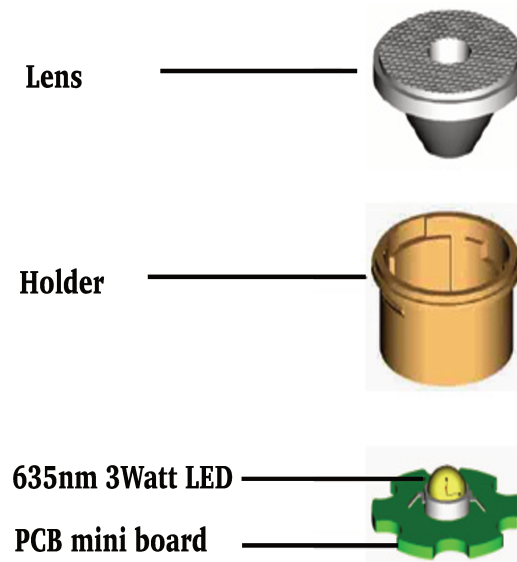

Figure 4.3: VLC transmitter LEDs head content.

The duty of the LEDs array is simply to modulate the light intensity correspondingly to the symbol transmitted by switching on and off the light to represent every subsequent binary digit.

Data processing at both VLC transmission and reception units are done using an Arduino micro-controller, this low-cost microcontroller is by default not capable of providing the required amount of biasing current and voltage to enable the LEDs fast switching requirements. To overcome this limitation, a simple switching circuit was used to make it possible to switch a larger amount of current at a very fast frequency. Figure 4.4 shows the circuit design of the VLC transmission unit and the wiring of the main components.

The processed binary data by the Arduino micro-controller is used to enable the Metal Oxide Semiconductor Field Effect Transistor (MOSFET) switching circuit to its HIGH and LOW status as depicted in Figure 4.4. Accordingly, the MOSFET circuit will bias the LEDs array to expressing OOK modulation. Other modulation techniques, such as Orthogonal Orthogonal Frequency Division Multiplexing (OFDM), Discrete Multi-Tone modulation or even the Direct Sequence Spread Spectrum (DSSS) can be used for further system improvement.

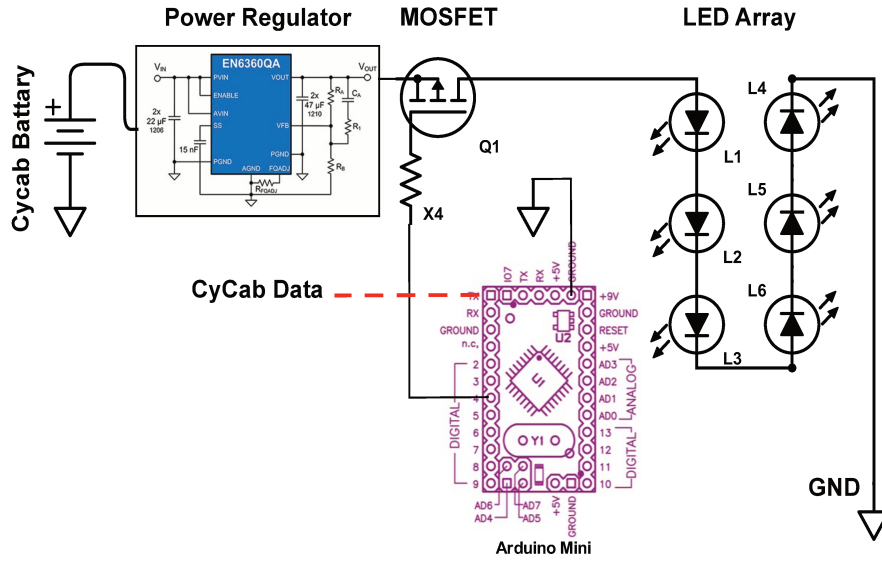

Figure 4.4: Schematic diagram for the VLC transmission unit, the schismatic shows the wiring of the LEDs array with a switching circuit that is controlled by an arduino board and powered by an independent power source.

The usage of Arduino micro-controller represents a viable and cost-effective solution for the encoding stage. In our design, and as it will be further detailed, such a microcontroller can provide high enough performances to ensure reliable and stable operation with less interfacing complexity. Nevertheless, in order to improve the system data rate, the encoding stage can substitute the Arduino micro-controller with a higher performance hardware such as Field Programmable Gate Array (FPGA) or Beagle-Bone-Board (BBB), which will provide more advanced digital signal processing techniques and higher modulation and data rate speeds.

The performance of the VLC transmission unit is defined by the physical characteristics of the LEDs, where the data transmission rate strongly depends on the switching abilities of the LED array and the MOSFET circuit switching speed. Moreover, the transmission range or the communication service area depends on the optical transmission power that LEDs can provide together with the illumination pattern (irradiance angle) and the receiver sensitive aperture size.

LED and lenses

The **LED**, as its name indicates, is described as a simple semiconductor diode that has the capability of emitting light through the solid-state electroluminescence material. The basic structure of any **LED** is formed of a doped positive-type (p-type) layer built on a negative-type (n-type) substrate as depicted in Figure 4.3.

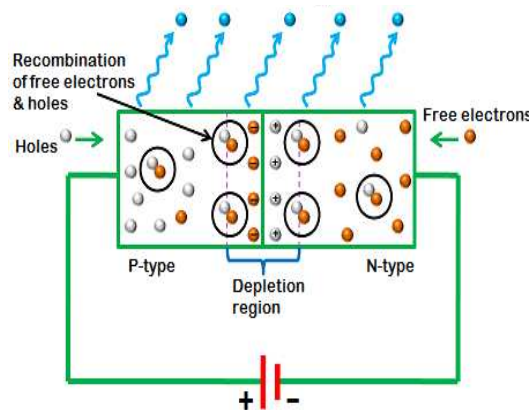

Figure 4.5: The basic structure of an LED

When a flow of any electrical current is passing through the doped p-n junction of the semiconductor material, light with a non-coherence behavior is produced. At the atomic level, when any forward bias is applied, electrons in the negative region diffuse across the whole junction, reducing the width of the depletion region that is formed between the two layers. Once this region is tiny enough, free electrons can drift through and combine with the holes in the p-region side, which enables a forward electrical current flow.

Throughout this recombination process, electrons drop from a higher energy level (conduction band) to a lower one (valence band), and a photon of energy proportional to the energy gap is released causing the light emission. The wavelength which indicates the **LED** emission color is mainly determined by one of three parameters, the band gap energy, the degree of doping, and the material used to build the **LED**.

All industrial **LEDs** have the same basic illumination properties, where **LEDs** follow a non-isotropic emission pattern which is typical forms what's called a Lambertian emission as depicted in Figure 4.6.

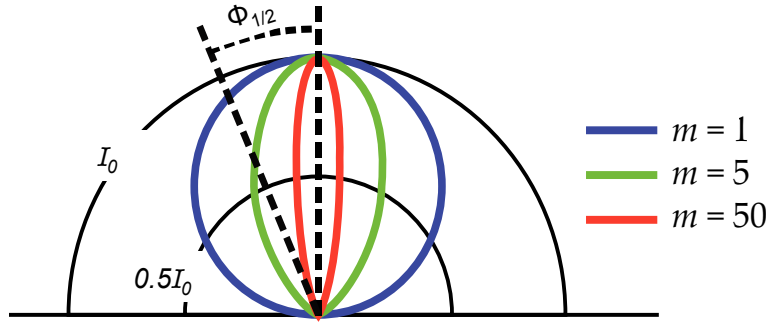

Figure 4.6: LED lambertian emission pattern and the FOV represented by the angle ϕ and the index m

The luminous intensity angular distribution of a Lambertian emitter pattern is corresponding proportionally to the maximum luminous intensity of I_0 and determined by the half-power angle $\phi_{1/2}$ and the index m which is also defined by the angle $\phi_{1/2}$ as described in (4.1). The chosen half-power angle $\phi_{1/2}$ has a remarkable influence on the coverage range and pattern shape of the Lambertian light source.

$$\mathbf{m} = -\frac{\ln 2}{\ln(\cos(\Phi_{1/2}))} \quad (4.1)$$

The improvement of the unity of the term m in (4.1) has an inversely proportional relationship with the angle $\phi_{1/2}$. Therefore, by selecting an LED with a narrower $\phi_{1/2}$, or by applying an optical focusing stage just after the LED illumination surfaces to confine and redirect the emitted beams, we can directly increase the illumination level, which results in longer communication range.

Further details on the influence of the m factor and the emission angles of the LEDs for communication purposes are being discussed earlier in Chapter 3, where we presented the VLC channel model for ITS applications.

There are many variables need to be examined before making the compatible choice of a communication purposes LEDs, especially when considering an outdoor communication environment. These variables usually have trade-off against each other. Hence, if the maximum intensity is required in order to extend the transmission range capability, this will directly reduce the semiconductor material switching speed (rising time). On the other hand, a low-intensity requirement makes it easier to have faster-switching speed (shorter rise time). Also, the more intensity the LEDs generates, the more current is consumed, therefore, the more power it needs.

Moreover, when we chose to have an LEDs with high illuminations such as the HLEDs, we are also required to manage the rapid heat changes by the semiconductors materials, which add an extra design and implementations requirements by adding a cooling stage. This stage can be essential to prevent the non-linearity behavior when the heat is exceeding certain levels. In some cases, an active cooling system consists a proper heat-sink and an active fan might be required.

To satisfy the VLC requirements for outdoor environment and considering using off the shelf components for a vehicular braking (rear) light system as illustrated before in Figure 4.1, the Avonec 3W6-30nm-640nm HLED was chosen [112]. This light emitting source is a low cost dark red HLED made of a single component with a lumination level of $60lm$ as described in Table 4.1. Six of this HLEDs are connected in series as shown in Figure 4.4 to form the VLC transmission head.

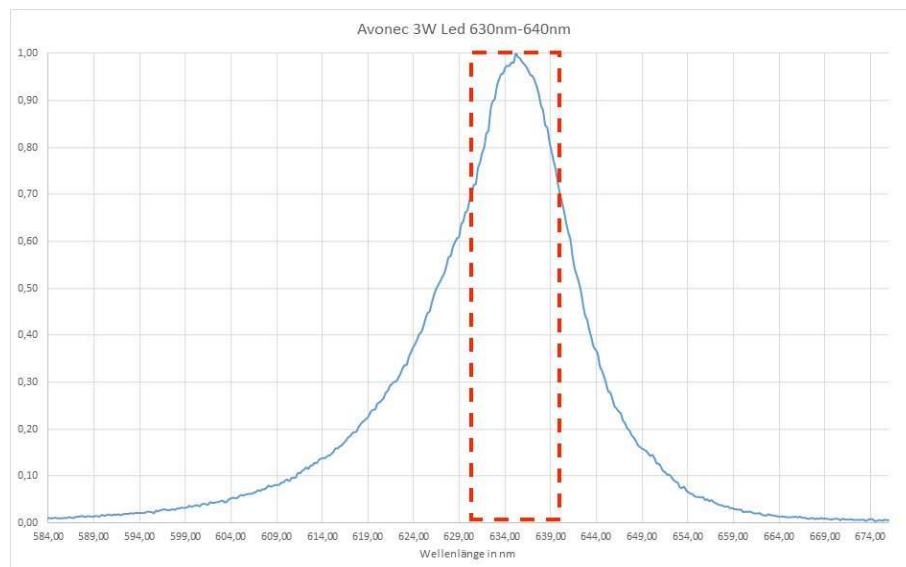

Figure 4.7: VLC transmitter LED head content

The **HLED** has its peak wavelength around the $634nm$ as depicted in Figure 4.7. Usually, the manufacturers of these kinds of low cost **LEDs** do not specify the exact switching characteristics in the provided data-sheets. Therefore, the **LEDs** had to be tested individually in order to check its suitability with the frequencies that were chosen for **VLC** implementation. The selected **HLED** was tested and can perform well at frequencies over few MHz, which is more than what we will need to modulate our data as it will be further illustrated in the subsequent sections.

To control the transmission pattern and improve the communication link range, each single **HLED** was mounted with a removable focusing lens allowing us to downgrade the manufacture $\phi_{1/2}$ easily, from the default value of 60° to any other chosen value.

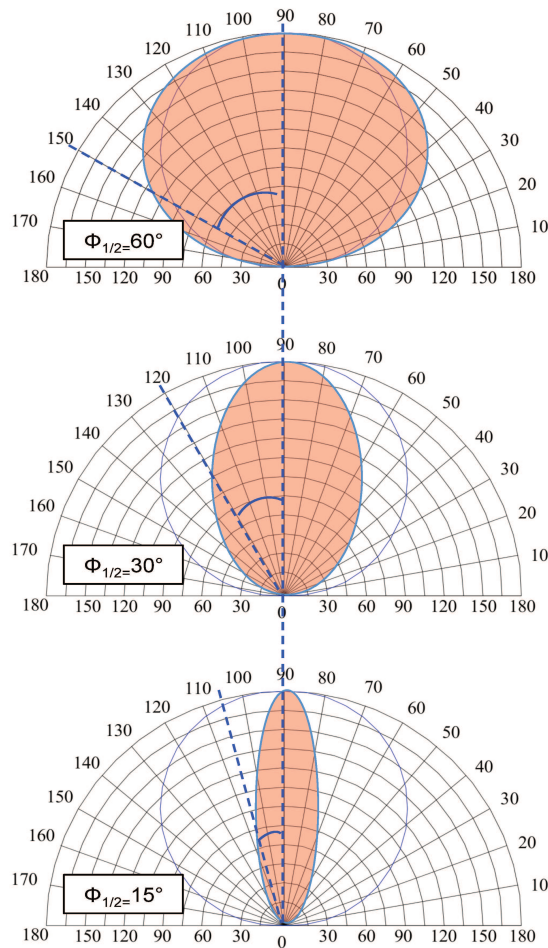

Figure 4.8: LED light emitting angular radiation lampertian emission pattern and the FOV represented by the angle ϕ and the index m

Following our findings in Chapter 3 for the VLC system optimal parameters performance for ITS applications use cases, we pick the 15° , 30° lenses for further communication range improvement and experimental results comparison. Figure 4.8 shows the LED illumination pattern improvement when using different focusing lens.

Table 4.1: Inter-vehicle distances for different traffic conditions

Parameters	Value	Unit
Luminous Flux	60	<i>lm</i>
Wavelength	630-640	<i>nm</i>
Forward Voltage	2.2-2.8	<i>V</i>
Power Dissipation	1.76-2.24	<i>W</i>
View angle	60	<i>degree</i>
Forward current	800	<i>mA</i>

Switching circuit

The transmitted data using the LEDs need to be coded properly using a modulation technique that is recognizable by the receiver end. Here, the switching circuit plays the main role of signal modulation by switching the LEDs array to either ON or OFF status. This switching can directly represent the digital status of the transmitted binaries HIGH (1) and LOW (0) using the simplest form of modulation OOK.

Since the Arduino micro-controller can only convert the binary data sequence into a sequence of corresponding low voltages, a proper cost efficient switching transistor was essential in the overall circuit design as depicted in Figure 4.4. The MOSFET described in Figures 4.9 was suitable for this implementation, mainly because it operates using a low positive voltage on its gate, making the high power LEDs controllable by the Arduino low voltage output.

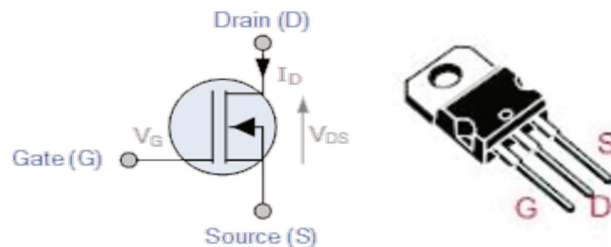

Figure 4.9: MOSFET switching transistor for VLC transmitter

When a low voltage from the Arduino micro-controller is applied to the gate of the transistor representing either 0 or 1 digital status, the **MOSFET** generates an electrical field which lowers the internal resistance and allows a higher current to pass from drain to source. Moreover, due to the high input resistance, the **MOSFET** can handle high currents with an extremely low current on its gate.

This unique characteristic of the **MOSFET** makes it possible for a controller with a low current output such as Arduino to enable and handle any number of **LEDs**. This directly implies that a micro-controller can be used to control the **LEDs** array using totally independent power source. Moreover, the **MOSFET** have a low drain-source resistance which makes it better for even higher speed switching applications for any further data rate and modulation improvement.

Table 4.2: TIP122 MOSFET Transistor characteristics used for VLC transmitter unit

Parameters	Value	Unit
Drain-Gate Voltage	80	V
Drain-Source Voltage	80	V
Drain-Gate Voltage	5	V
Drain current (DC)	5	A
Gate-Current (DC)	120	mA
Junction Temperature	150	C°

The used **MOSFET** in this implementation is N-channel transistor named TIP122 as detailed in Table 4.2. The transistor was chosen with a capability of switching current up to $5A$ at a gate voltage of $5V$ under the room temperature conditions (25°). This switching circuit makes almost no limit to further improvement of the **VLC** transmission unit, either to improve switching speed or to add more **LEDs**.

VLC transmitter power management

The **VLC** transmission unit was meant to be integrated into the Cycab autonomous vehicle. Therefore, our design took into the consideration the compatibility with the Cycab powering system. The shown DC-to-DC Step-down converter in Figure 4.10 was used to ensure this compatibility, and provide protection for any power fluctuations. The circuit fixes the current consumption by the six **LEDs** array and provides enough voltage with fixed $700mA$ and $3Watt$ $5-35V$. Moreover, the transmission unit Arduino micro-controller is driven independently by the serial-over-USB connection using the Cycab computing unit.

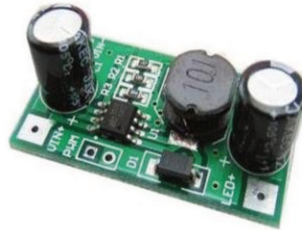

Figure 4.10: DC to DC Step-down 700mA current driver

4.3.1.2 VLC receiver

As for the receiving part, the VLC implementation was intended to extract the data from the received optical signal. The optical receiver parts as depicted in Figure 4.11 includes an optical filtering, photo-detection, amplification, ADC, demodulation, and decoding.

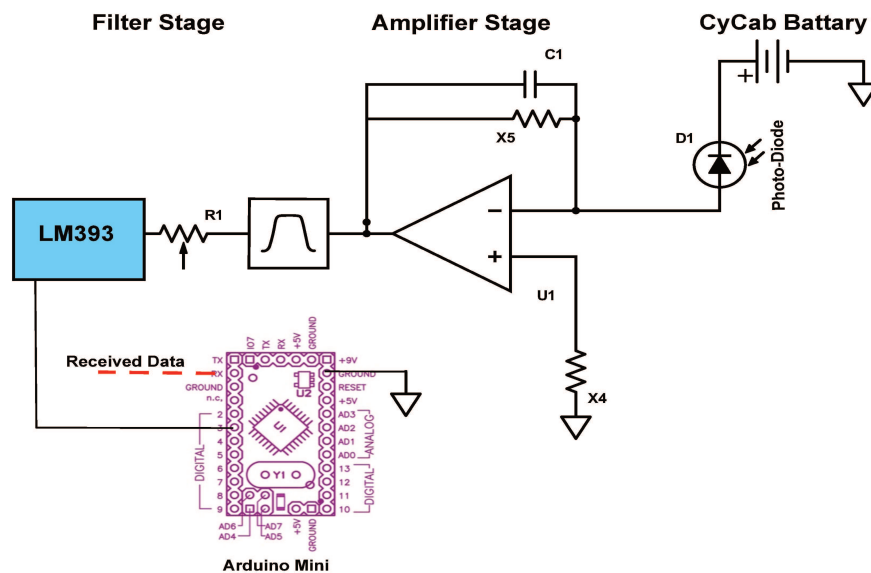

Figure 4.11: The VLC receiver unit main components: an optical filter, PD, trans-impedance amplifier, decision circuit and an Arduino micro-controller.

The VLC direct detection method at receiver end concerned mainly about how much current is produced by the PDs, which is a direct indicator of the amount of optical beams sensed by the aperture. This current will be converted to the corresponding voltage levels and further processed into amplification stage, and finally demodulated and decoded using the same cost-efficient Arduino micro-controller that has been used in the transmission unit. These stages were implemented to recover the accurate packets sent by the LEDs and with the lowest possible latency.

Since the whole VLC system is very sensitive to the amount of the received ambient noise and signal interference, the design of the VLC receiver and choosing components compatible with the outdoor environment requires the maximum attention. Besides the LEDs light beams sent by the transmitter, the VLC receiver can be subjected to any artificial or natural light sources fall in the receiver FOV. The overall design of the VLC receiver focuses mainly on enhancing the performances of the received signal, more precisely, the acquired SNR level which indicates the ratio of how much signal is detectable from the transmitter light source to the added noise from the channel. The chosen components must be selected in a way that we can have relatively high SNR and at the same time cost-efficient implementations.

As it will be further detailed in the subsequent sections, this goal can be achieved by employing an optical filtering stage that rejects any unwanted optical spectrum segments and passes the desired emitted spectrum range by the LED. Moreover, choosing the less affected spectrum range by channel environmental conditions and larger PD aperture can improve the overall SNR quality

Photo-Diode

The PD component is the most sensitive choice when implementing a reliable VLC receiver. This component is used to convert the optical beam to an electrical signal. When a photon is detected by the PD sensitive aperture, an electron, and a positively charged hole pair are instantly created. As depicted in 4.12, the newly generated hole will move towards the anode (N-type material), and the free electron will move oppositely toward the cathode (p-type material). This process produces a corresponding electrical photo-current that is directly proportional to the instantaneous received optical power (number of photons hit the surface). Moreover, the maximum bandwidth of the PD is dictated by the rate at which it can respond to the optical intensity variations; typical PDs can handle bandwidth up to hundreds of MHz.

Our prototype implementation considers devices that are characterized by low-noise, low-cost, tolerance to temperature fluctuations and excellent sensitivity to the chosen LEDs emitted spectrum. In general, there are two types of PDs suitable for such VLC prototype: the Avalanche Photodiode (APD)s or the silicon-based Positive Intrinsic Negative (PIN) PDs.

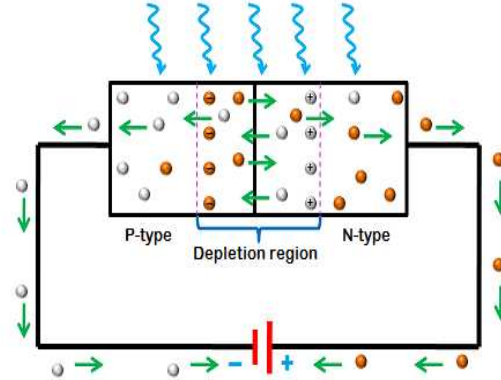

Figure 4.12: The basic structure of a PD

Though APDs are famous in having relatively higher sensitivity and better performance, the internal gain factor makes it a bad choice for outdoor applications. This PD type is usually preferred in low light situations or when pre-amplifier noise is the dominant noise source, which is the case for indoor VLC systems. As for outdoor conditions, which is the targeted conditions for our prototype implementations, using PIN device is more preferred due to their better linearity and more resilience to ambient noise.

For the earlier mentioned reasons, we have chosen the PDA10A unit from THORLABS to be the main component of the VLC receiver end [113]. The photo-detection part of the PDA10A is designed for the detection of light signals between the range $200nm$ to $1100nm$ wavelength range.

The chosen PDA10A is an ideal for measuring both pulsed and continuous light sources. Moreover, the unit has a reverse-biased PIN PD mated to a fixed gain trans-impedance amplifier, and the used PIN of the PDA10A responsivity has a proper linear ratio of the generated photocurrent I_{PD} to the incident light power P for a given wavelength as the following:

$$R(\lambda) = \frac{I_{PD}}{P}. \quad (4.2)$$

The load resistors $x5$ in Figure 4.4 is placed together with the photodetector junction capacitor $C1$ in order to select the desired bandwidth. The switchable gain of the receiver is very sensitively to the feedback element (RF), where the $3dB$ bandwidth of the VLC receiver can be adjusted easily by changing the RF values. In this way, the PDA10A can provide a broad range of gain values. The device $3dB$ bandwidth can be calculated using the following formula:

$$f(-3dB) = \sqrt{\frac{GBP}{4\pi R_f \cdot C_D}}, \quad (4.3)$$

where C_D represents the sum of both PD junction capacitance and the amplifier capacitance, and the GBP is the amplifier gain bandwidth product.

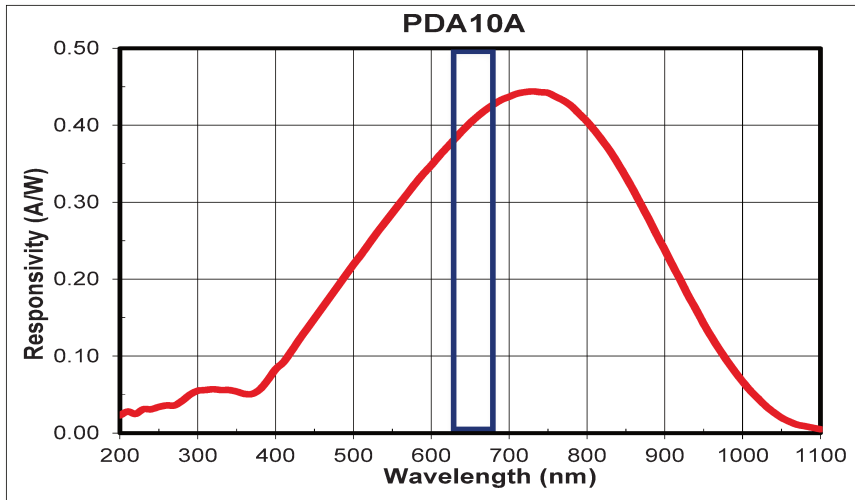

Figure 4.13: Response curve of the PDA10A Photo detector

Moreover, to have proper detection of the optical signal, the PIN must have relatively high responsivity to the emitted beams by the LED at the transmission unit. The depicted PIN PD responsivity in Figure 4.13 makes the PDA10A a perfect choice to detect our implemented transmission unit optical beam that operates at $635nm \pm 10nm$. Full details of the PDA10A unit can be found in Table 4.3.

Table 4.3: PDA10A Electrical specifications

Parameters	Value
Active Area	0.8mm^2
Wavelength range	200 – 1100nm
Peak response	0.44A/W
Noise (RMS)	1.5mVrms
PD Surface depth	4.1mm
Dark offset	10mV
Transimpedance gain	$1 * 10^4, 4 * 10^3\text{V/A}$
Output voltage	0 – 5Volt

Optical band-pass filter

Choosing the less affected spectrum range by channel environmental conditions and narrowing the emission FOV can improve the SNR quality from the transmission side. Moreover, for the receiver side, the performances of the VLC receiver can be dramatically enhanced by employing an optical filtering stage that rejects any unwanted spectrum segments and passes the exact emitted spectrum range by the LEDs as described in Figure 4.14.

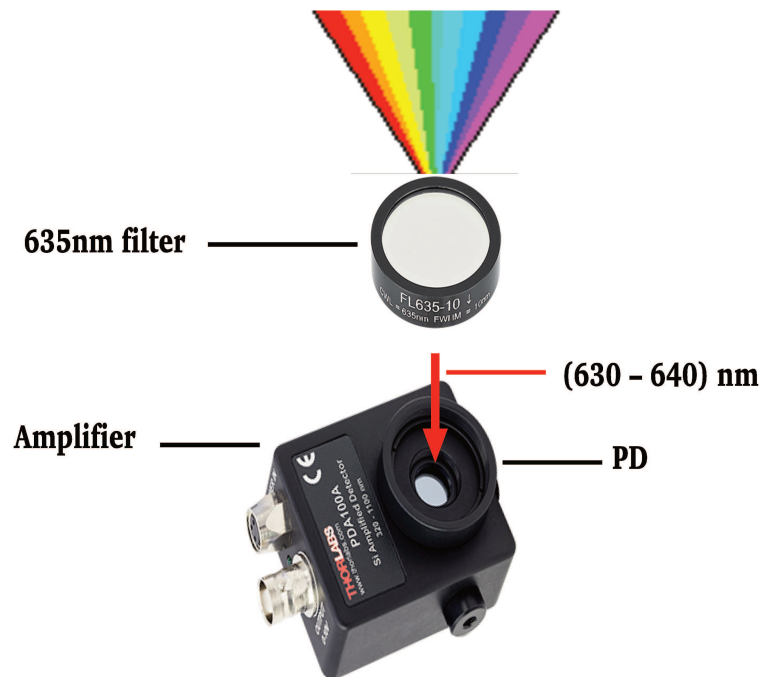

Figure 4.14: FL635 Bandpass optical filter stage passing 625nm – 645nm of the whole visible light spectrum.

Furthermore, In order to increase the receiver performance, the chosen PIN photodiode must have a wide enough effective area $A_{eff}(\psi)$. An expanded aperture size can statistically increase the quantity of the photons accumulated by the receiver side, and consequently, the received optical signal strength represented by the produced current, though at the cost of increased noise level and lower operating bandwidth.

The PD effective area $A_{eff}(\psi)$ can be calculated using:

$$A_{eff}(\psi) = \begin{cases} T_s(\psi)g(\psi)A_{ph}\cos(\psi), & 0 \leq \psi \leq \psi_c \\ 0, & \textit{Otherwise} \end{cases} \quad (4.4)$$

or equivalently to:

$$A_{eff}(\psi) = T_s(\psi)g(\psi)A_{ph}\cos(\psi)\textit{rect}\left(\frac{\psi}{\psi_c}\right), \quad (4.5)$$

where $\textit{rec}\left(\frac{\psi}{\psi_c}\right)$ is a rectangular function. A_{ph} is the physical aperture size of the PD, ψ_c is the FOV of any further concentrator might be used and equal 180° if not used. T_s is the optical filtering stage gain, and $g(\psi)$ is the gain of the concentrate and calculated based on the material refractive index n as the following:

$$g(\psi) = \begin{cases} \frac{n^2}{\sin(\psi_c)}, & 0 \leq \psi \leq \psi_c \\ 0, & \textit{Otherwise} \end{cases} \quad (4.6)$$

Hence, optical filters and concentrators are usually the preferred opinions of increasing the PD's effectiveness, and robustness the received signal without adding further complexity by using digital signal processing stages. The optical bandpass filters are primarily utilized to remove the DC signal offset induced from ambient noise sources, in which the receiver passes only the desired modulated optical signals by the transmission unit, while the concentrators are used to increase the receiver physical aperture size by focusing more incident light onto the PD area.

The receiver unit implementation took into the consideration the sharp band-pass filtering stage that operates around the emission wavelength of the transmitter unit. As it has been detailed in the previous sections, the LEDs array emitting a red light beam over the wavelength range of $630nm - 640nm$ (See Figure 4.7). Therefore, we choose the THORLAB band-pass filter FL635 with mounting compatibility to the PDA10A device. The filter operates sharply at $635nm \pm 10nm$ as depicted in Figure 4.15, which will allow

the system to prevent any unwanted optical signal outside the narrow band of the filter.

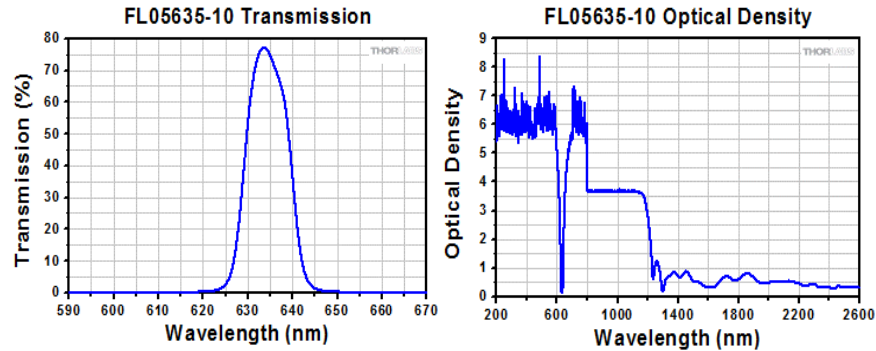

Figure 4.15: THORLAB FL635 optical filter transmission and optical density.

Trans-impedance amplifier

The trans-impedance amplifier is another crucial stage that can play a vital role in improving both data reception and communication range for VLC systems. The chosen PDA10A unit integrates a proper trans-impedance amplifier just after the PD to directly convert the PIN current into readable voltage. Moreover, this type of amplifiers is suitable for our receiver implementation because it increases both response speed and gain, which are vital factors to add immunity against ambient noise for outdoor environment.

The integrated PIN photodiode within the PDA10A unit has its own internal capacitance C , and internal resistance R . Together, they make the time constant $\tau = RC$. By choosing large R value, the overall gain can be switched to higher values, while the response time becomes relatively slow. On the contradiction, to increase the detection speed, a smaller R value is needed, with the cost of gain level.

To avoid trade-off design complexity between response time and gain level, the PDA10A is directly connecting the PD to the trans-impedance amplifier circuit as depicted in Figure 4.16. This connection order makes the time-constant no longer be dictated by either R or C values, and the overall receiver gain can be controlled simply by a feedback adjustable resistor R_F .

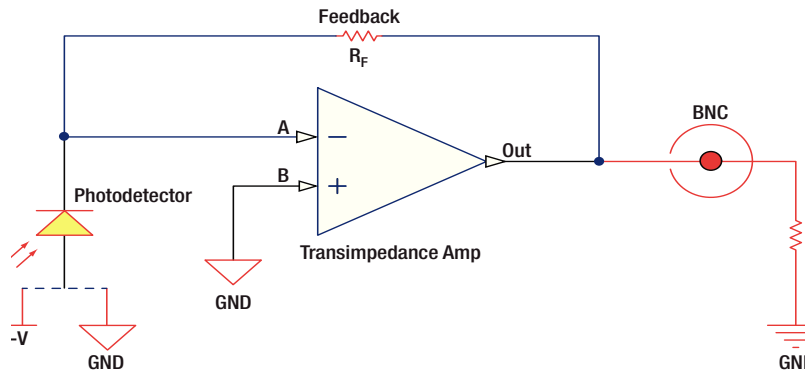

Figure 4.16: PDA10A device from THORLABS, Photodetector combined with a transimpedance amplifier.

Decision circuit

The receiver unit uses the simple decision circuit LM393, which has an adjustable signal threshold voltage. This stage as depicted in Figure 4.4 represents the overall receiver sensitivity, followed by a [ADC](#) stage. Since the received and amplified signal is recognized as an analog signal, the [ADC](#) stage at the receiver side is required to handle these received signal in digital forms to the Arduino microcontroller for further processing.

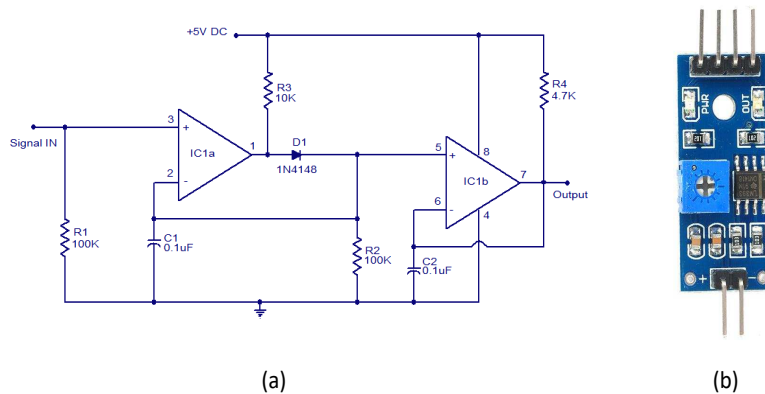

Figure 4.17: Decision circuit used to define the VLC receiver sensitivity and threshold level. (a) the actual LM393 dual voltage comparator circuit diagram, (b) the LM393 chip mounted on mini brad-board for prototyping usage.

The circuit diagram depicted in Figure 4.17 represents a straightforward and low-cost dual voltage comparator circuit using the chip (LM393). This stage compares the received analog signal from the trans-impedance amplifier and

compares the value with a reference level in order to decide the high or low digital status. The circuit operates using +3.5V independent voltage source and can detect signals up to 180 kHz, where the comparison reference values have been obtained empirically based on the impact of the ambient noise levels for many different scenarios and different receiver/transmitter positioning.

Moreover, it is important to mention here that for implementation simplicity, the receiver design does not consider any Automatic Gain Control (AGC) implementation or an automatic sensitivity adjustment techniques. Such an addition can play a vital role in adapting environment changes, especially for handling the changes in background noise level by automatically adjusting the proper threshold level and receiver sensitivity. We are fully aware of the necessity of such stage, especially for outdoor environment, but this thesis scope is mainly to design a low-cost prototype for concept approval, where any further improvement is part of our future work vision.

4.3.2 System software

A good software implementation that can manage proper line coding, together with signal modulation is a necessary task to achieve an efficient VLC communication system that satisfies the illumination standard for ITS applications. Moreover, to decrease the complexity of dealing with any operating system, we develop specific components can provide hardware interface compatibility between the VLC prototype and the computers units.

To use VLC system for vehicular applications; the vehicular data at the transmission unit need to be structured according to a chosen communication protocol. Correspondingly, at the receiver end, the same protocol must be used to interpret the incoming data correctly and try to avoid any transmission losses. The data verification at receiver end can be achieved using continuous check on the bits level to confirm that all data was received correctly.

Since this implementation was intended to exchange information between platoon members, the vehicles CAN-BUS is the data source of any developed software and packet formation. The extracted data are packed into a specific packet format, where RTMaps [114] will do the extraction of specific information such as speed, acceleration, GPS coordinations, and steering angle, then attaches particular timestamp and pre-defined packet headers. These data are then adapt Manchester line coding using the Arduino micro-controller just before modulating the LED array at the transmission unit.

4.3.2.1 Data encoding

Manchester coding (also known as phase encoding) was used here based on the fact that the energy component of the encoded signal is not dependent on the data itself. Moreover, each transmitted bit in this context contains the same amount of energy and results in a constant intensity over transmission, either we send 0's or 1's.

By using Manchester coding, we ensure that human eye will never observe any light intensity fluctuation during data transmission, even if it happened to send a long sequence of zeros followed by a long sequence of ones using a low modulation speed.

Both positive edge or a negative edge symbols generated by the Manchester coding are depicted in Figure 4.18, which produces only two combinations representing the digital digit 0 and 1. A sample of a 4-bit binary data stream (1110) coded using Manchester line coding is illustrated in Figure 4.19.

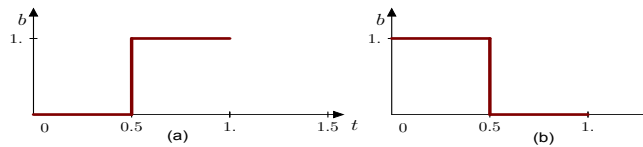

Figure 4.18: (a). Manchester bit representation for digit 1 (b). Manchester bit representation for digit 0.

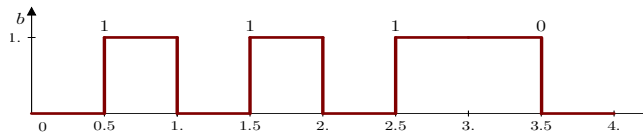

Figure 4.19: Sequence of binary data coded using Manchester line coding.

After applying the Manchester line coding, the LED's array at transmitter end is then driven by the coded data using high-speed MOSFET switching circuit, which uses our desired intensity modulation in conjunction with the OOK.

4.3.2.2 Mchr3k Arduino manchester encoding library

The open source Mchr3k Arduino micro-controller library by Mike McCauley [115] was used at both VLC transmitter and receiver units to enable Manchester coding. The Mchr3k library was originally made to support simple and low data rate communication for the low-cost wireless Internet of Things (IoT) devices. By applying small modifications, the library worked perfectly for our VLC implementation, and could provides full Manchester line coding with the features to send short messages, without any addressing, retransmitting or acknowledgment.

4.3.2.3 Data payload

The exchanged data from the transmission unit can vary in size between 0 and 12 kbits. Moreover, a checksum of the sent packet is also attached to the packet tail to be used for further error detection. By using the Mchr3k library, the developed prototype was able to transmit messages with a payload up to 27 bytes per message with a baud-rate speed of 115200baudps, where each transmitted message is constructed as:

- 12 bit start symbol 0xb38.
- 1 dedicated byte to count the message length.
- 1 dedicated byte to indicate the packet sequence.
- 32 bit training preamble contain a high and low bit pairs.
- up to 27 bytes actual data.
- 32 bit for checksum.

The total number of transmitted bytes, which are contained in the constructed packet defines the receiver listening time, and how many bits are required before starting the subsequent packet construction. The micro-controller at the receiver end will decode and store the payload length and reconstruct the received packet until it has collected the amount of bytes specified by the message length, which is set to be constant most of the time. Figure 4.20 depict a sample of a generated packet that was used to evaluate the system in the subsequent sections.

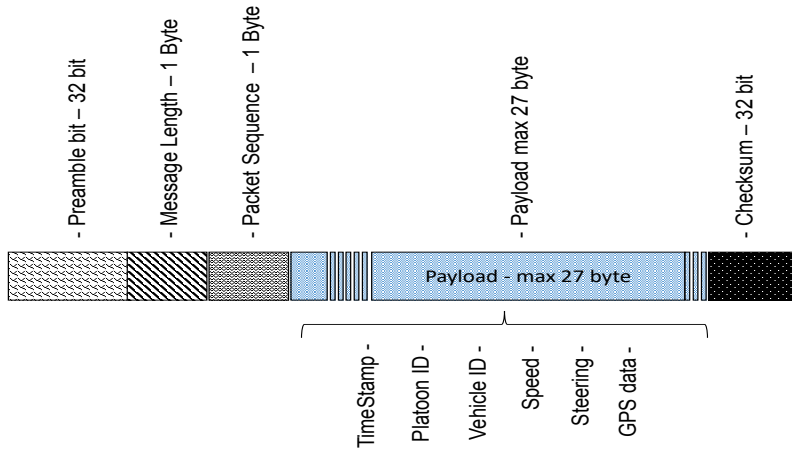

Figure 4.20: General Packet format used in VLC for intra-platoon communication, the packet sending a vehicular status such as (ID's, speed, steering, and vehicular coordinations).

Moreover, packets are all labeled with a sequence number which is transmitted along with the payload. This simple procedure allows us to post-processing the received packet sequence and calculates the **PDR**. In order to notify the **VLC** receiver that there is a packet to be sent, the transmitter will send a predefined preamble (predetermined sequence of bits), where the **VLC** transmitter starts the transmission with 32 bits contains both high and low bit pairs.

4.3.2.4 Hardware interface

In our implementation, we use the Arduino microcontroller to interface and drive the **LEDs**, and also to interface computers and read the **PD** received signal. The Arduino microcontroller using a serial connection to exchange data with the computing ends. The serial port supported by Arduino using the communication standard **UART** and can communicate via a **USB** port directly after using the proper operating system driver.

We chose the Arduino Mini boards to interface our hardware mainly because they are readily available, affordable, having a small size, low power consumption, and compatible with many open source libraries provided by large developers society. Moreover, Arduino boards are easy to use for development and prototyping environment and easy to interface almost all sorts of hardware.

4.3.2.5 RTMaps components

RTMaps platform was used for high layer data processing and interface configurations. This platform was chosen because it is commonly used tool to deal with autonomous vehicles controllers as well the multi-sensor hardware at INRIA. In addition to the default components provided by RTMaps, we developed a specific interfacing components for both VLC transmitter and receiver units. Moreover, complete RTMaps diagrams were prepared to handle the acquired data between the vehicular CAN-BUS and the Arduino micro-controllers.

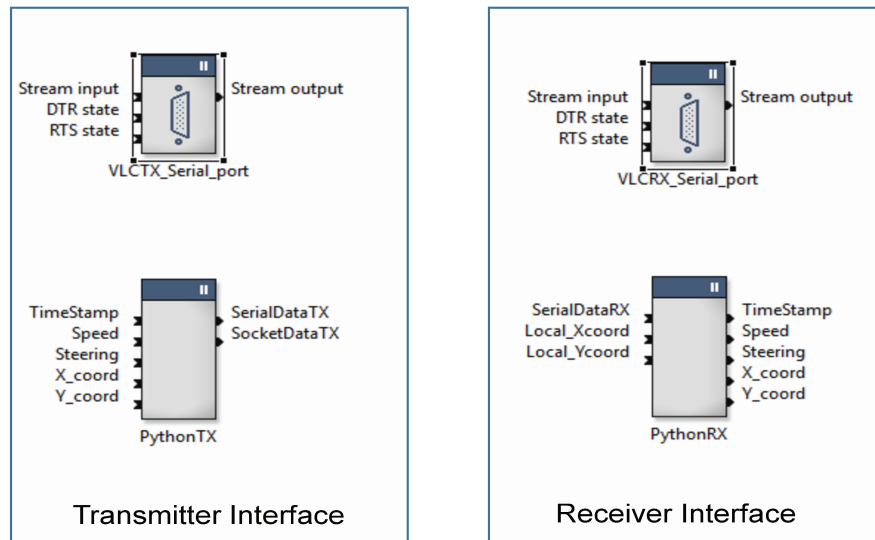

Figure 4.21: VLC system interface components.

The depicted components in Figure 4.21 represents the two main components types being developed and used to interface both transmitter and receiver units:

1. Serial port components:

These components allow the user to exchange data between the Arduino microcontroller and the computer over a serial bus (RS232, RS422 or USB). In our implementation, we interface the Arduino with 115200 baud per second, where the maximum buffer size was set to 28 bytes.

2. Python components:

PythonRx and PythonTX components are both python code based components. These components deal with the high-level data packing and unpacking. The primary function of PythonTX is to convert the values of the TimeStamp, Speed, Steering, and GPS coordination acquired by the CAN-BUS before streaming the data over the serial port component for further lower level processing managed by the micro-controller. The same is being implemented at the receiver side using PythonRX to read the streamed data and unpack the packet in reversal order.

4.4 VLC prototype evaluation

The majority of the existing studies that tackles the use of VLC systems for automotive applications are focused mainly on conceptual approaches and relying only on the theoretical models. In this work, we aim to see how practically this technology can be used for an ITS application. Therefore, this section is dedicated to validating experimentally the VLC theoretical model by testing the implemented VLC prototype in outdoor conditions considering platooning application requirements.

The conducted experiment was meant to test the system performance under different environmental conditions. Moreover, the tests were performed for variable communication distances in order to confirm the path-loss relationship with the distance.

As it will be further discussed in the subsequent sections, the preliminary results confirm the agreement between the measurements data and the path-loss model. Furthermore, the obtained results will demonstrate that the VLC technology can be a strong supportive candidate to be used with the RF communication technology for safety applications.

4.4.1 Experimental setup

When using VLC to establish a IVC link between platoon members, the V2V communication is the most important aspects associated with the safety applications requirements that the developed prototype aim to test. For the VLC transmitter end, a vehicle red backlight had been emulated using an array of six HLEDs. The light source luminous flux measured at 0.6 meters and found to be around $300lm$, where the default luminous of each single LED is $60lm$.

Figure 4.22 illustrates the outdoor VLC link experimental setup. The setup was dedicated to studying the maximum link range d and the communication quality for LoS between the transmission unit (TX) and the receiver end (RX). All tests were performed in a sunny daytime of December the 12th between 12:00 and 14:00 on 2015- (Paris time) and avoiding the direct expose to the sun.

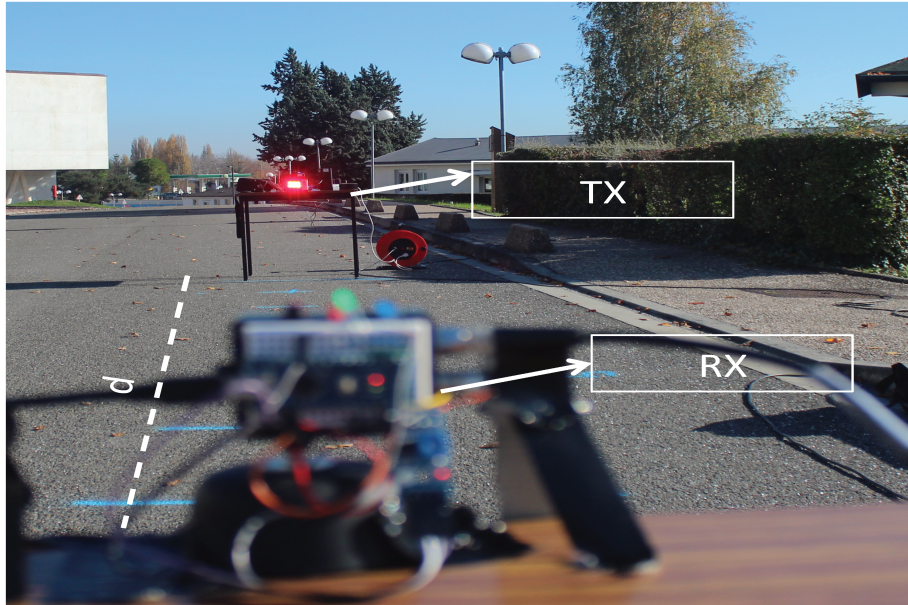

Figure 4.22: The experimental setup to evaluate the VLC prototype performance in daytime conditions.

Multiple iterations of data recording were performed at the receiver end, in which we record data for each +500 cm increment of the direct LoS distance (d). The data recording started from $d = 1$ meter until the maximum achieved range $d = 30$ meters. The experiment configuration meant to observe the behavior of the received optical power with respect to the variation of both direct and axial distances changes. As depicted in Figure 4.23, the receiver unit was placed in three different zones (10m, 20m, and the 30m zone) which represent the receiver displacement distance from the TX source.

Moreover, by using a proper optical filtering stage, the power of the ambient noise expected to be relatively low compared with the emitted power from the LED array. Therefore, this experimental configuration was conducted to ensure that the system can have a high resilience against the ambient noise sources for communication range up to 30 meters.

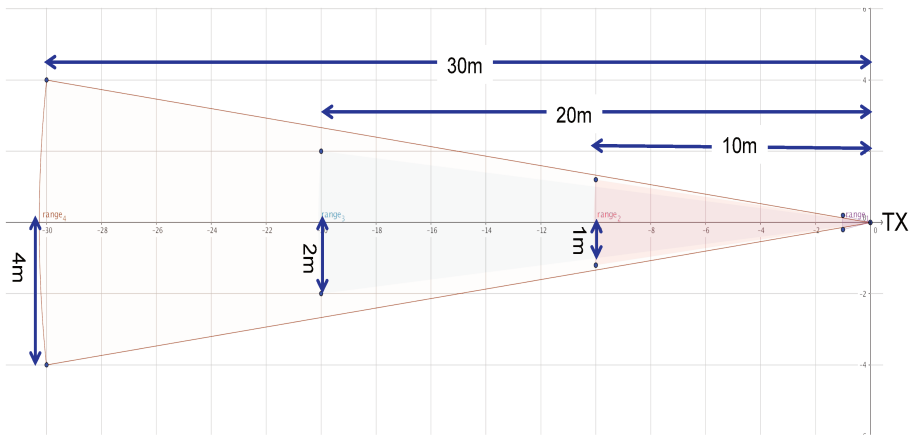

Figure 4.23: The three main zones where the VLC receiver was placed to evaluate the received signal with respect to the variation of direct distances changes.

An independent power source supplied the transmitter components with a constant 24 voltage and 700 mA in order to bias the LED array. The receiver components were also powered independently to enable the trans-impedance amplifier. Arduino micro-controllers at both transmitter and receiver ends were powered by the 5 Volt over USB connection.

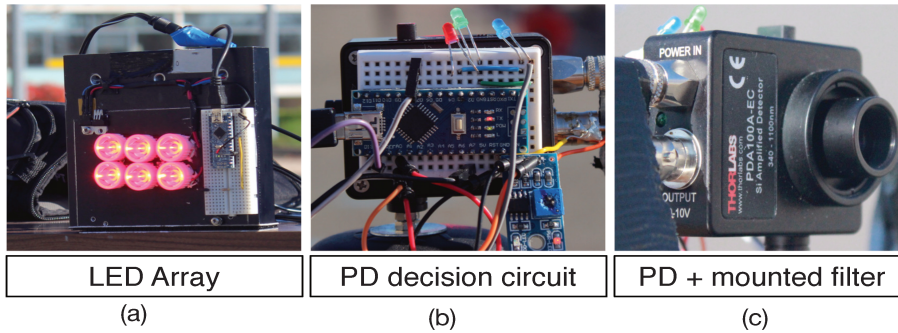

Figure 4.24: VLC transmitter and receiver ends, (a) Transmitter LED array with the driving circuit, (b) The receiver decision circuit (c) Receiver optical filter mounted over the PD (PDA10A)

The height of both TX and RX units are fixed to 85 cm from the ground level, where each of the mounted lenses on the transmission unit LEDs can have the FOV of 5° , 15° , or 30° . More parameters regarding the experimental setup and weather conditions are given in TABLE 4.4, where a detailed image of the both TX and RX units are depicted in Figure 4.24.

Table 4.4: Experimental parameters

Parameter	Value
Transmission data Rate	9.5 kbps
Transmission baud Rate	19 kbps
Link range	30 meter
LED color	Red
LED wavelength	635 nm
Modulation type	OOK
Line coding	Manchester
LED power dissipation	3 Watt
Number of LED array	6
LED lens viewing angle	5°, 15°, 30°
PD active area	100 mm ²
Transmitter & Receiver height	85 cm
Receiver sensitivity	2.1 V
Gain levels	30, 40, 50 dB
Mean Temperature	13°C
Wind Speed	11km/hour
Visibility	12.0 kilometers
Sea Level Pressure	1025.11 hPa
Average Humidity	90

4.4.2 VLC link experimental results

This section presents an experimental evaluation of the implemented VLC prototype under outdoor conditions. The evaluations take into the considerations the presence of severe ambient noise, where all the obtained results use the experimental setup described in Figure 4.22. The evaluation starts by a manual calibration procedure allow us to find the optimal gain level and the decision circuit threshold values (receiver sensitivity level) at the receiver side, together with finding the proper lens to be mounted over the LEDs array at the transmitter end.

The VLC path-loss model is then verified by studying the obtained received power by our prototype receiver and comparing it with the mathematical model. Finally, an obtained performance results at the packet level such as PDR, latency, and the link throughput will be presented.

4.4.2.1 Prototype calibration

As previously mentioned, our VLC receiver implementation does not include any automatic adaptation techniques that can allow the receiver to adapt ambient noise variation or signal dropping due to an increase of the distance between TX and RX units. Therefore, the preliminary experimental results

are obtained by manually calibrating the receiver sensitivity according to the presence of the background noise level during the experiment time. The calibration is done by sending a sequence of binary data over low-frequency signal (2kHz), and then choosing the optimal amplification and sensitivity levels at the receiver side.

A sample of the obtained results during this calibration process are presented in Figure 4.25, where a receiver gain of 60dB was chosen, supplemented by threshold reference value of 2.0 volt. As it can be observed, the received signal (Volt unit) was distinguishable for a LoS communication range up to 30 meters (3^{rd} zone in Figure 4.23).

The calculated SNR results of the preliminary tuning for different communication ranges are depicted in Figure 4.26. The obtained results show a linear ratio behavior; and an excellent link quality indicator, where the SNR value is around 20 at for link range of 30 meters.

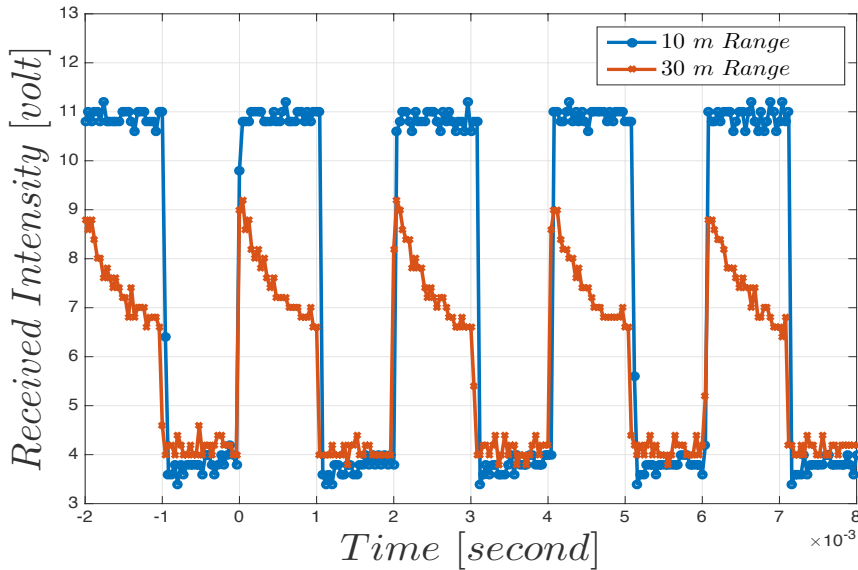

Figure 4.25: Optical received signal results used to calibrate the VLC receiving unit. The calibrations meant to adjust the sensitivity of receiver to achieve detectable signal for link range of 30 meters.

Moreover, and as it can be seen in Figure 4.26, when the gain of 70dB is applied, unstable signal reception behavior was observed for communication link range exceeds the 15 meters. This behavior is mainly due to the PD nonlinearity and the high amplification of the in-components electrical noise sources.

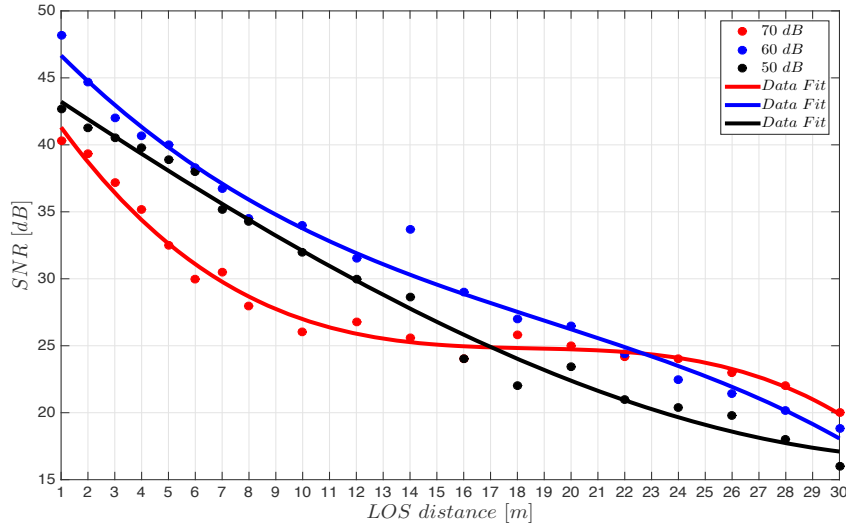

Figure 4.26: SNR results used to calibrate the VLC receiving unit. The calibrations meant to adjust the gain level at receiver end to achieve SNR of 20 for max link range of 30 meters

These preliminary results were enough to demonstrate that the prototype is well suited to transmit optical signals over a communication link for range up to 30 meters during daytime conditions. Further tests on packet level will be presented in the following sections.

4.4.2.2 VLC path-loss model evaluation

By recalling the investigated VLC channel model from Chapter 3, where path-loss is expressed by (4.7). We can observe that for our LoS experiment setup, the distance between transmitter and receiver ends is much greater than the PD aperture size A_r . Moreover, and for further simplicity, the terms $\cos^m(\varphi)$ and $\cos(\theta)$ can set to equal 1 by maintaining aligned direct distance between both transmitter and receiver, where $\theta = \varphi = 0$.

$$P_{loss} = \begin{cases} \frac{(m+1)A_{ph}}{2\pi d^n} \cos^m(\varphi) \cos(\psi), & 0 < \psi, \varphi < \theta_c \\ 0 & elsewhere \end{cases} \quad (4.7)$$

It thus follows that one can simplify the path-loss expression in (4.7) and write the received power with respect to the transmission power as:

$$P_R = P_{Loss}P_T = \frac{(m+1)A_{ph}}{2\pi d^n}P_T. \quad (4.8)$$

Based on the fact that all the influencing parameters except the direct distance between transmitter and receiver were fixed for each experiment iteration. One can encapsulate the constant parameters over the experiment steps $\frac{(m+1)A_{ph}}{2\pi}P_T$ in the term A_0 , where a linear least-square relationship of the received power is expected over the variation in d as the following:

$$P_R = \frac{A_0}{d^n}. \quad (4.9)$$

To estimate the values of the two unknowns A_0 and n , we applied a regression process to the acquired received power as shown in Figure 4.27. The results indicate that there is perfect agreement between the theoretical VLC path-loss model that was tackled in Chapter 3 and the empirical measurements, where the estimated path-loss exponent $n \approx 2$.

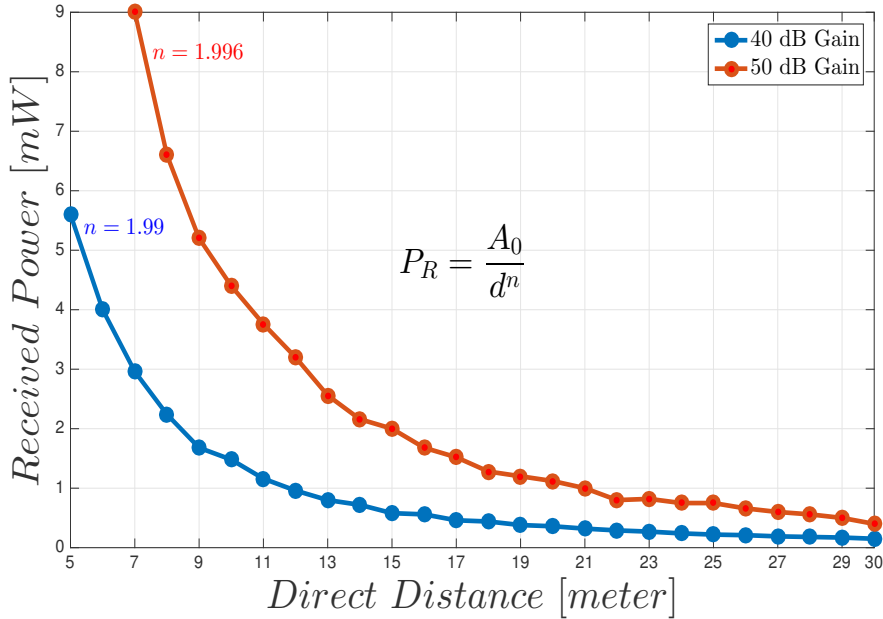

Figure 4.27: Empirical estimation of the VLC link Path-loss exponent, $A_{50dB} = 432.0479$, $n_{50dB} = 1.996$, $A_{40dB} = 139.4479$, $n_{40dB} = 1.99$.

Furthermore, any acquired data for link range shorter than 3 meters has shown an unstable behavior for high amplifier gain levels (40dB, 50dB, and 60dB). This behavior is mainly due to the current saturation in the PD. To overcome this problem, the applied gain, where the decision circuit threshold level should be dynamically adjusted in relevance to the inter-vehicle distance d .

Based on our preliminary findings, and for the exact experiment conditions and by using the same prototype, we suggest using gain levels of 10-20 dB for communication ranges fall in zone 1 (Figure 4.23), and higher gain levels for zones 2 and 3.

4.4.2.3 Packets transmission evaluation

By tracing the received packet sequence, which is a single byte reserved in the transmitted packet format as illustrated in Figure 4.20, we were able to count how many packets were dropped over a given period of reception time as the following:

$$PDR = \frac{\sum RX_{Packets}}{\sum TX_{Packets}} \quad (4.10)$$

Moreover, any repetition or leap off in received packets order was also counted as a dropped packets. The post-processing of these recorded packets for PD gain of 40dB are depicted in Figure 4.28.

The results show the PDR with respect to the distance d increment between both TX and RX units, where a 100 % of PDR was achievable for communication range up to 30 meters. The system performance for outdoor conditions can be considered realistic for platooning application functioning in a vehicular high dense situation. For such a scenario, where vehicles usually have low speed and short inter-vehicle distances. The VLC can easily substitute the radio technology if the LoS is guaranteed.

The Packet inter-reception Time (PiT), or what is called (date age) is analyzed in our evaluation and defined as the time required to successfully receive two subsequent packets while considering each packet sequence. The averaged PiT is represented as the following:

$$PiT = \frac{\sum_1^m (\Delta t)}{m} \quad (4.11)$$

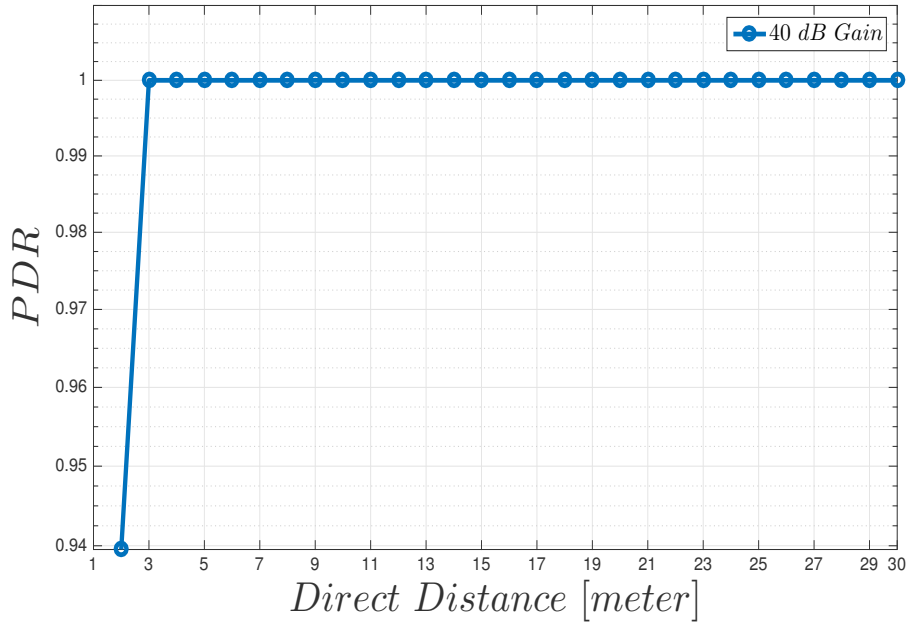

Figure 4.28: Packet Delivery Ratio (PDR) of the VLC platform for 40 dB gain.

The calculated value is an average time of all received packet time difference Δt between every two subsequent packets, where m represent the number of $(\sum RX_{Packets}) - 1$.

In order to calculate Δt , we save the occurrence times t_n and t_{n+1} which represents the successful reception of both $RX_{packet}(n)$ and $RX_{packet}(n+1)$ respectively. The subtraction between those two values is the defined PiT for two subsequently received packets.

$$\Delta t = t_{n+1} - t_n \quad (4.12)$$

where n represent the packet sequence number.

The depicted results in Figure 4.29 show that the system is capable to successfully delivering the packets without exceeding 36 ms of delay time. The obtained results confirm again the suitability of the VLC system to satisfies the requirements of the many hard safety applications, including the platoon.

As for the link throughput, the definition here is simply the number of successfully received useful information bits during a period of time after excluding the headers, training bits, and the preambles. The obtained throughput

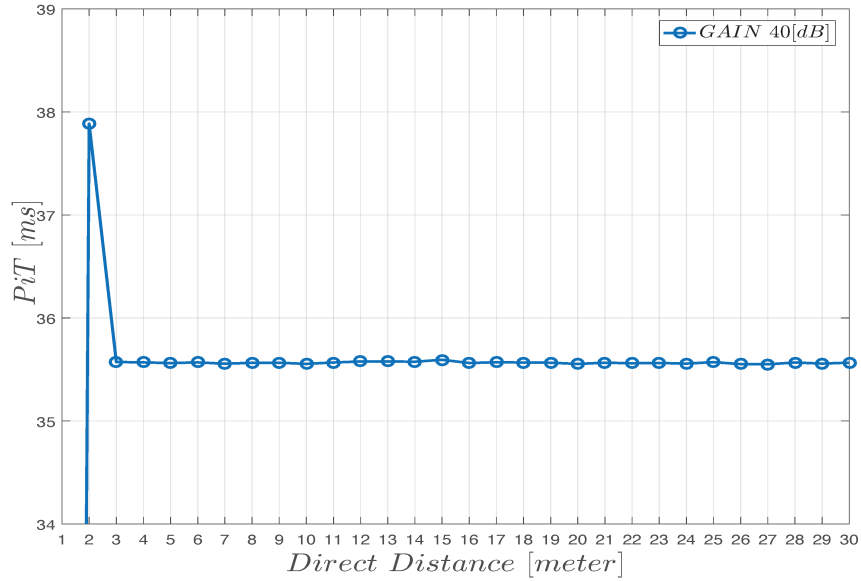

Figure 4.29: The packet inter-reception time (PiT) performance of the VLC platform for 40 dB gain.

measurements were done by finding the ratio between the received data bits $RX_{data-bits}$ and the monitoring time τ as the following:

$$Throughput = \frac{RX_{data-bits}}{\tau}. \quad (4.13)$$

Figure 4.30 represents the average throughput performance over many iterations and using the same platform calibrations. The calculated link throughput was 3.8kbps for all tested different ranges and using the 40 dB gain level.

It might appear that the obtained throughput of 3.8 Kbps is very low, especially if compared to, e.g., 6 Mbps of the standardized IEEE 802.11p technology for ITS applications. However, it should be noted that there is no direct comparison in this context between both technologies, the radio channel of the IEEE 802.11p is a shared medium over approximately 1 km of geographical area, which may conduct hundreds of vehicles that might be sharing the same channel. On the other hand, our proposed VLC system has a channel hardly shared by two transmitting vehicles due to the previously discussed strict LoS and FOV requirements.

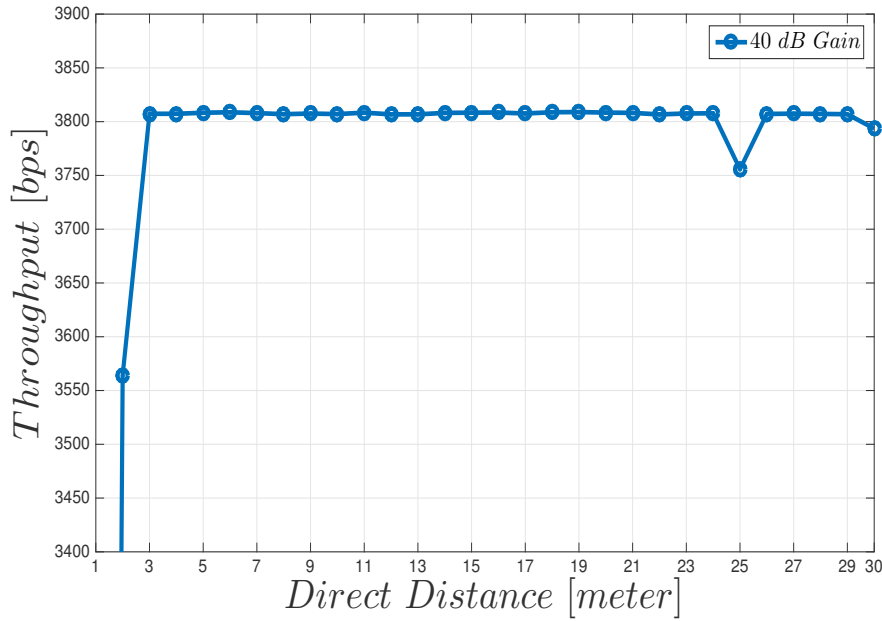

Figure 4.30: The throughput performance of the VLC platform for 40 dB gain.

4.5 Conclusion

Throughout this chapter, we described the process and components details of the prototyping and implementation of a VLC system for an outdoor communication. Both transmitter and receiver components were chosen carefully to emulate the vehicular tail-lighting system and provide the maximum resilience against the ambient noise sources.

Moreover, an experimental evaluation of the prototype was performed with an especial attention on the VLC link resilience to ambient noise and communication range. Through the experiment, we observe that a use of proper optical filtering stage at the receiver side, together with narrowing the transmitter FOV, result in an extended communication range and make the VLC system more resilient to the ambient noises. Experimental results show that the system can provide 30 meters of inter-vehicle communication with 36 ms of PiT for normal daytime conditions.

The main advantages of our implementation were the cost-efficiency and simplicity. Moreover, the prototype has the compatibility to interface with any operating system by using the Arduino microcontroller together with a proper RTMaps components.

Manchester line coding was considered in this implementation to enable light intensity continuity by providing a stable signal with an equal amount of bit energy over time, which is suitable for the meant **ITS** applications and meets the on-road lighting standardization. Furthermore, we conducted several tests that measure the received optical power, packets delivery ratio, link throughput and the packet inter-reception time performances. The implemented prototype shows an excellent end-to-end communication performances regarding both **PDR** and **PiT**, where the measured **VLC** path-loss characteristics show a strong agreement with the theoretical model.

Since the main bottleneck of the current system is due to the processing speed and implementation cost-efficiency, but not the capability of physical **VLC** channel itself, the implemented prototype throughput can be further improved. Moreover, using an **AGC** stage and automatic receiver sensitivity calibration can further improve the system performance and avoid the manual calibration being performed during the system evaluation.

CHAPTER 5

Handover proposals for platooning application

Contents

5.1	Introduction	104
5.2	Laser-based perception and VLC	107
5.2.1	LRF-VLC system configuration for platooning application	109
5.2.1.1	Laser Based Detection Model	111
5.2.1.2	Visible Light Communication Model	112
5.2.2	Handover between ACC and CACC using LRF-VLC	113
5.2.3	Platforms Architecture	116
5.2.3.1	VLC Platform	116
5.2.3.2	Pro-SiVIC Platform	117
5.2.4	Performance evaluation	118
5.2.4.1	Straight driving scenario	119
5.2.4.2	Lane-change scenario	119
5.2.4.3	Curve scenario	120
5.3	Radio communication and VLC	123
5.3.1	Conventional VHO existing schemes	124
5.3.2	RF congestion problem	128
5.3.3	RF-VLC system configuration and assumptions for platooning application	132
5.3.4	RF-VLC switching key metrics for platooning	134
5.3.5	Prediction-based VHO method for platoon application	135
5.4	Conclusion	143

Résumé du chapitre

Ce chapitre traite la proposition de permettre la mobilité entre la communication VLC, RF et les systèmes basés sur les capteurs pour l'amélioration de la sécurité de "platooning" comme illustré dans la Figure 5.1. Afin de faire face aux interruptions attendues VLC, l'échange de données système doit rester continu en utilisant une autre sorte de technologies et/ou de capteurs, qui assurent le système global QoS, et en même temps maximisent la sécurité de conduite autonome avec la latence la plus basse.

Par conséquent, un algorithme peut détecter les défaillances de toute technologie déployée et passer à la technologie actuellement disponible et fiable (VLC et/ou RF et/ou LRF), pourrait afficher une amélioration sur le comportement du système "platoon".

Comme illustré dans la Figure 5.2, les deux algorithmes principaux sont l'algorithme de commutation de technologies (algorithme 1) et l'algorithme de commutation de commande de "platooning" (algorithme 2). Tout d'abord, il est nécessaire de concevoir un algorithme capable de sélectionner une ou plusieurs technologies de communication ; dans notre cas, RF et/ou VLC) pour IVC entre les membres du "platoon". D'un autre côté, un autre algorithme est identifié à l'aide de l'algorithme précédent et détecte la défaillance des systèmes de communication (VLC et RF) et commute entre les différents modes de conduite. L'algorithme 2 est capable de transformer la commande de "platooning" de CACC (basée à la fois sur le système de communication et les systèmes basés sur les capteurs) au mode ACC (dépend du système basé sur un capteur). En plus, pour assurer la sécurité du système, le scénario de défaillance du système arrêtera immédiatement l'outil de "platoon".

5.1 Introduction

Despite the discussed advantages and concept approval of using VLC as a complementary communication solution for vehicular high-density scenarios. Still, the technology coverage is rather short, which results in a limited service area, where obstacles can easily disturb the VLC links and void the application safety requirements. Moreover, for the vehicular application, the curvature shape of the car-following models and the trade-off between the FOV and link range can also prevent the communication continuity when a platoon follow a sharp curvature.

On the other hand, and as being discussed in Chapter 2, the standardized RF communication technology (IEEE 802.11p,) for ITS applications is meant to provide coverage of several hundreds of meters. Therefore, the proper integration of both the technologies (VLC and RF) for an ITS application is imperative owing to satisfy the safety requirements.

Moreover, it is possible that both communication-based solutions (VLC and RF) might fail. In such cases, the platoon needs to fall into the ACC mode, relying on the vehicle-embedded sensors, such as LRF.

This chapter discusses the proposal of enabling handover between VLC, RF communication, and sensor-based systems for platooning safety enhancement as illustrated in Figure 5.1. In order to deal with the expected VLC interruptions, the system data exchange must remain continuous using another sort of technologies and/or sensors; that ensure the system overall Quality of Service (QoS), and at the same time maximize the autonomous driving safety with the lowest latency.

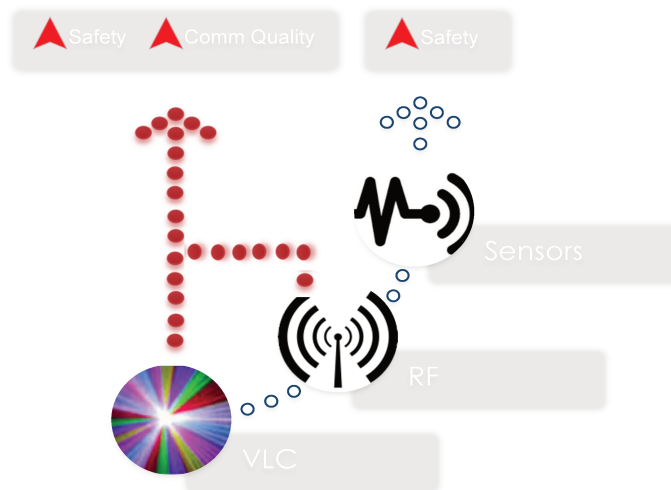

Figure 5.1: General concept of deploying RF communication, VLC, and sensor-based solution to improve the platoon system driving safety.

Therefore, an algorithm can detect the failure(s) of any deployed technology(s) and switch to the currently available and reliable technology (VLC and/or RF and/or LRF); could display an improvement on platoon system behavior.

As illustrated in Figure 5.2. The two main algorithm are technologies switching algorithm (algorithm 1) and platooning control switching algorithm (algorithm 2). First of all, it is necessary to design an algorithm capable of

selecting one or more communication technologies (in our case, **RF** and/or **VLC**) for **IVC** between platoon members. Secondly, another algorithm dedicated to assisting the previous algorithm and detects the failure of the communication systems (**VLC** and **RF**) and switches between different driving modes. Algorithm 2 is capable of turning platooning control from **CACC** (based on both the communication and the sensor-based systems) to **ACC** mode (relies on a sensor-based system). Moreover, to ensure the system safety, the complete systems failure scenario will urgently stop the platoon application.

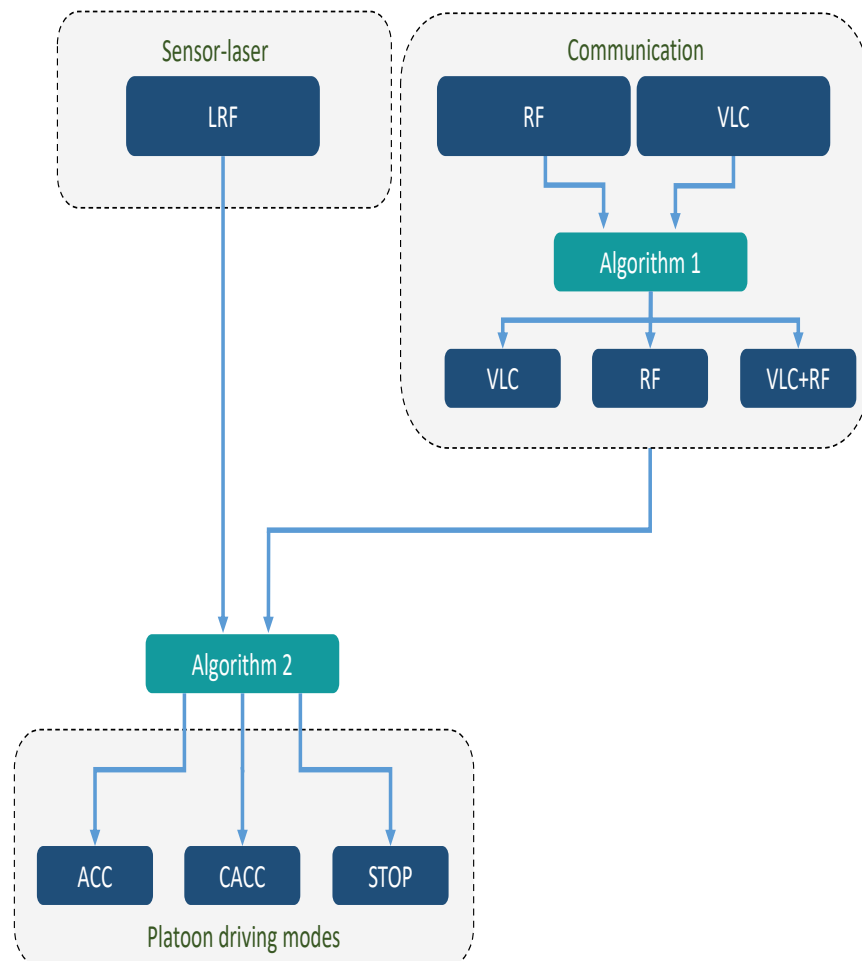

Figure 5.2: General flow chart of the two main handover algorithms used to enable platoon control using LRF, VLC and RF technologies.

Since the core interest of this work is the VLC technology, we are interested in handover between VLC and LRF as well as VLC and radio communication. Note that while the former targets only the VLC as the communication system, the algorithm can be easily extended to include RF by considering the output of the handover between VLC and RF.

To expedite data transmission when VLC experiences disrupt connections, a VHO algorithm relying upon prediction method is proposed to switch between RF and VLC technologies, where a proper metrics are introduced for decision making. Normal handover schemes include either immediate VHOs and or dwell VHOs are briefly discussed. Moreover, we study and evaluate the advantage of using VLC and LRF sensors for platooning further safety improvement.

5.2 Laser-based perception and VLC

Improving traffic safety and comfort by properly utilizing the information technology is one of the shared goals of all ITS applications. Such information can be acquired using the vehicular embedded sensors, which provides the necessary data to perceive the vehicle's surrounding environment. Furthermore, IVC can also play a significant role in improving road traffic safety and comfort [116]. To realize both optical-based LRF and VLC technologies in such context, the communication distance between vehicles, LRF range, and viewing capability are some of the critical issues for a convoy-based application.

As proposed solutions for traffic congestion, automobile manufacturers have developed advanced driver assistant systems such as ACC, which intend to improve traffic fluidity. ACC uses sensors such as cameras, laser or radars to estimate the relative distance and relative velocity of two nearby vehicles [117]. Vehicles with ACC systems are capable of changing acceleration automatically to adapt desired distance and sustain a safe distance from the preceding vehicle.

Moreover, the CACC systems are introduced as an improvement to the ACC by exchanging information between vehicles using wireless communication as an addition to the vehicle embedded sensors. Compared with ACC, CACC can keep relatively smaller headway time, which can enhance traffic flow dramatically, and improves the system stability by providing the assessment of approaching future situations and also result in better decision-making and prediction.

The main benefits of using **VLC** in such configuration is to activate the **CACC** mode between platoon members introducing less load to the radio communication channel, which may be only active for platoon non-**LoS** communications such as leader to all vehicles broadcasting. Although that **VLC** is sensitive to the vehicular orientation, holding a reliable sensor-based backup system able to drive the platoon in **ACC** mode with a sufficient hand-over can overcome this limitation. Figure 5.3 illustrates the **FOV** of embedded sensors (**LRF**) and **VLC** communication range. Such configuration intends to utilize both technologies to ensure platoon application safety requirements.

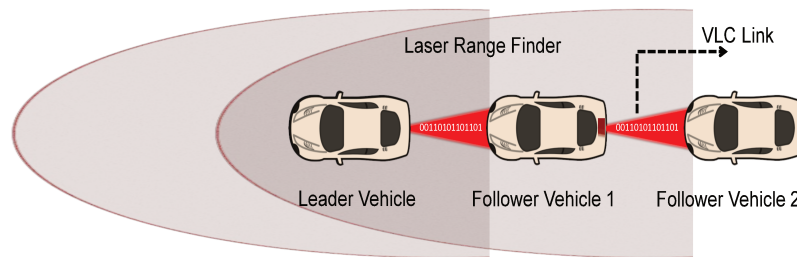

Figure 5.3: The use of VLC and LRF systems for platooning application.

The **LRF** sensors can have a wide **FOV** with a sensing range up to 100 m, make such sensor sufficient to track the preceding vehicle in a platoon. On the other hand, and as being tested and evaluated in chapters 3 and 4, **VLC** operates in relatively narrower **FOV** and can exchange information over a **LoS** communication range up to 30 meters.

In this section, we focus on studying and evaluating the advantage of using **VLC** and **LRF** for platooning. By combining technologies, the vehicular status and GPS positions are exchanged among the platoon members using the vehicular rear lighting system. Further, the **LRF** is continuously operating in redundant mode as a backup for any **VLC** blackout occurrence.

The study examines the overall platoon behavior for different trajectory scenarios, where the simulation scenarios intending to drive the **VLC** link to its **FOV** limits by introducing communication failure of the proposed **LRF-VLC** system. In this particular scenes, our investigations highlight the switching modes between the presence of **VLC** and disconnections cases, in other words, the availability of **CACC** and **ACC** while recognizing the platoon minimum safety requirements.

In this section, we make the following contributions:

- Suggesting a new architecture intend to improve the platoon performance by utilizing both **LRF** and **VLC**.
- Studying the limitations and performance of both technologies for various car-following scenarios (straight-line, lane-change and curve).
- Proposing hand-over algorithm to check the platoon safety requirements and the availability of **ACC** and **CACC** modes.
- Evaluating both system performance and hand-over mechanism for cooperative and **LRF**-only platooning modes.

5.2.1 LRF-VLC system configuration for platooning application

By mapping the vehicles in the surrounding environment using infrared beams [118], **LRF** can detect and precisely localize obstacle with up to 360° **FOV** [119, 120]. Thus, **LRF** sensors can be mounted on every platoon member to measure the distance to the preceding (and follower, if necessary) vehicle. However, using such sensors expected to introduce some imprecision when estimating the preceding vehicle velocity, especially when vehicles follow sharp road curvatures. As it will be further discussed, the vehicular status exchange between platoon members using (**V2V**) communication can overcome these types of limitations [121].

The main requirement of platoon controllers usually concerns the longitudinal control [122, 123]. The **ACC** (sensor-based only) systems with a constant time headway policy have been a standard solution to maintain a safe distance between platoon members [123]. Furthermore, the use of both communication and sensors in a Cooperative **ACC** customs (**CACC**) is expected to show further system improvement compared to either depending on only sensors-based or communication-based systems. Such collaboration can decrease the inter-vehicle time headway from 1.1 s to 0.6 s while satisfying the safety requirement and without affecting the string stability within the platoon [123].

Benefiting from the adaptability of the laser sensors for detection and tracking in the ACC mode, and using the vehicle commercial lighting system to establish a low-cost communication link between platoon members, our proposed LRF-VLC system can rely on the CACC mode as long as the VLC is active.

This approach allows us to overcome the introduced errors when using laser sensors to estimate speed and inter-vehicle distance, at the same time, keeping a backup when the VLC blackout occurs due to the FOV limitations. For our considered LRF sensors, we limit the sensor into an area of interest using the vehicle motion model allowing us to identify the leading vehicle and estimate its position with more precision. Moreover, in our study, we propose to use VLC to exchange vehicular status *e.g.*, (speed, orientation, acceleration) and relative locations within platoon members, redundantly with the laser sensors. In this way, the proposed system can rely on two independent information sources for taking the best decision to drive the platoon either using ACC or CACC driving modes.

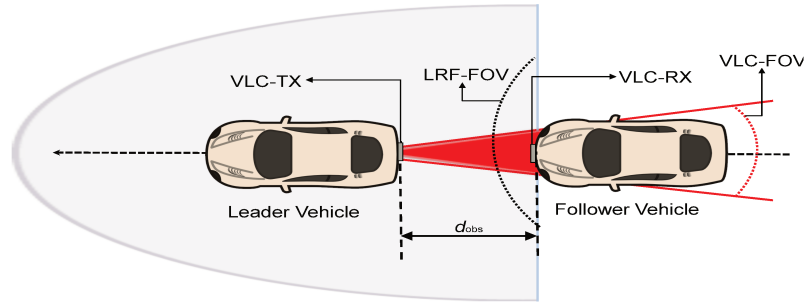

Figure 5.4: LRF-VLC system configuration for a platoon of autonomous vehicles.

Figure 5.4 shows the proposed LRF-VLC system for platooning application, where each platoon member is equipped with LRF to measure the distance with its preceding vehicle and ensure a safe platoon by means of ACC longitudinal control. Vehicles are also equipped with a VLC transmitters and receivers such that the platoon members can rely on a CACC longitudinal control. LRF has FOV of 180° with a sensing range up to 100 m, where VLC operates in relatively narrower FOV, and has a communication range of 30 m suitable to establish IVC between platoon members.

The depicted **FOV** in Figure 5.4 of both **FOV** and **LRF** are defined as follows:

- **LRF** is mounted on the follower vehicle, allowing the follower vehicle to detect reflected beams from the preceding one. Thus, the **LRF-FOV** is defined to be from the follower vehicle end toward the preceding one.
- **VLC** uses the leader vehicle rear-light system as a communication transmission unit, where the receiver is mounted on the follower vehicle. Hence, **VLC-FOV** is defined by the **LED**'s Lambertian characteristics from the preceding vehicle end toward the follower vehicle.

Moreover, the proposed **LRF-VLC** system recognizes the **ITS** hard safety application requirements, where the targeted performance reaches up to 90-100% of data **PDR**, and a maximum latency of 10 to 100 ms [124].

5.2.1.1 Laser Based Detection Model

By using laser sensors, all obstacles fall in the sensor **FOV** are usually detected, classified, and their position regarding the sensor is estimated [125]. In a platoon formation, as the preceding vehicle is close enough, each two members can rely on laser-based detection mechanism to estimate the distance d_{obs} from the vehicle ahead [120]. Such mechanism meant to provide a confidence value C regarding the detected vehicle. This value is describing how accurate is the identification and can reach up to 100% after a certain number of successful observations.

Moreover, assuming that all the detected obstacles are falling in the trajectory of platoon member. The **LRF** can reduce the confusion and increase the confidence parameter by searching in a predefined area of interest that has a width W_{Area} around the predicted vehicle trajectory $(x_p(t), y_p(t))$ as illustrated in Figure 5.5.

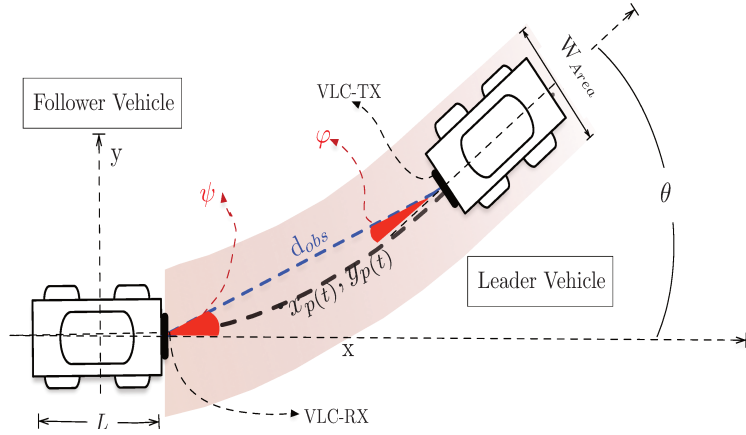

Figure 5.5: Laser based preceding vehicle detection and VLC for two platoon members. L represent the vehicle length and W_{Area} is width of the laser detection area of interest. ψ and φ are VLC incidence and irradiance angles.

For modeling simplicity, a bicycle model was used to predict the vehicle trajectory points $(x_p(t), y_p(t))$ using the following formula:

$$\begin{aligned} x_p(t) &= \frac{L}{\epsilon_p} \sin\left(\frac{L \times v_p}{\epsilon_p} t\right) \\ y_p(t) &= \frac{L}{\epsilon_p} \left(1 - \cos\left(\frac{L \times v_p}{\epsilon_p} t\right)\right), \end{aligned} \quad (5.1)$$

where L represent the vehicle length, v_p is the vehicle current velocity and ϵ_p is the steering angle.

5.2.1.2 Visible Light Communication Model

As being discussed in Chapter 3, VLC channel characteristics are defined mainly by the LED lambertian emission pattern and both transmitter and receiver physical characteristics, where the path-loss can be presented as:

$$P_{loss} = \begin{cases} \frac{(m+1)A_{ph}}{2\pi d^n} \cos^m(\varphi) \cos(\psi), & 0 < \psi, \varphi < \theta_c \\ 0 & elsewhere \end{cases}. \quad (5.2)$$

Moreover, our VLC prototype preliminary evaluation in Chapter 4 confirmed that the path-loss exponent n in (5.2) is equal to 2. In the described model, d represents the inter-vehicle distance between platoon members, θ_c is the critical angle which represent the VLC-FOV system limits. A_{ph} is the physical area of the PD and $m = -\frac{\ln 2}{\ln(\cos(\Phi_{1/2}))}$ is the Lambertian emission order, which is a key parameter specifying the directivity of the transmitter.

The LED half-power angle $\Phi_{1/2}$ has a remarkable influence on the coverage range and pattern shape of the Lambertian light source. By choosing narrower $\Phi_{1/2}$ or mounting the LED with an optical lens, we can directly change the VLC-FOV and increase the communication range. See Chapters 3 and 4 for further details regarding VLC modeling and experimental system evaluation.

5.2.2 Handover between ACC and CACC using LRF-VLC

In our system, the cooperative platooning mode can be possible only when LRF and VLC are both available and satisfy the hard safety requirements. The minimum configuration recognizes LRF for estimating the inter-vehicle distance in order to rely on an ACC mode. The ideal configuration is when the control system can upgrade CACC mode by enabling VLC. Thus, a hand-over is required between these two modes based on the availability of both LRF and VLC. Our proposed hand-over influenced by three main metrics that characterize and track the limitations of LRF and VLC technologies as the following:

1. The laser based detection confidence C is the main LRF metric, this value is estimated after certain number of detections. Once the leader vehicle is correctly detected with $C \geq 90\%$, the leader vehicle identifier (L_{ID}) is passed and ACC mode is activated.
2. The maximum of φ, ψ and θ is the defined term ζ , which represent the VLC transmitter and receiver angular difference with respect to the relative orientation and lane change. If any of the tracked angles exceeds the critical FOV limit (θ_c), the decision then handing the LRF output immediately.
3. The PiT τ : This condition is continuously checked for the safety requirement, where the PiT must remain under the 110ms limit. Also, the exceeded packet arrival time can indicate VLC disconnection due to an obstacle presence while transmitter and receiver might be perfectly aligned. A full definition of the PiT is given in the previous Chapter, section 4.4.2.3.

In general, the proposed handover algorithm has two main input and three output as illustrated in Figure 5.6 and detailed Algorithm in (1). Both VLC and LRF simultaneously provides data update where the algorithm output is the availability of either ACC, CACC or STOP modes.

Since using LRF-alone (ACC) is the minimum and initial configuration for our system, the algorithm is activated with laser data update. The preceding vehicle has to be detected and its identifier L_{ID} is tracked while it remains in the predefined area of interest.

At each time instant, the LRF confidence for detecting the leader vehicle C is compared to a given threshold. When $C \leq 90\%$, the tracking of the leader vehicle is considered lost, and the inter-vehicle distance d_t is predicted based on the previous estimated inter-vehicle distance d_{t-1} using the following:

$$d_t = d_{t-1} - (T_0 \times v_p), \quad (5.3)$$

where T_0 is the sensor update period and v_p is the current vehicle velocity.

The introduced prediction stage was meant to maintain the ACC mode as long as possible and recover the track of the leader vehicle while the distance d is above the vehicle length L . If the predicted distance is too short, then the STOP is called to exit the platooning mode. Otherwise, the vehicle can continue driving autonomously within the platoon using the ACC mode.

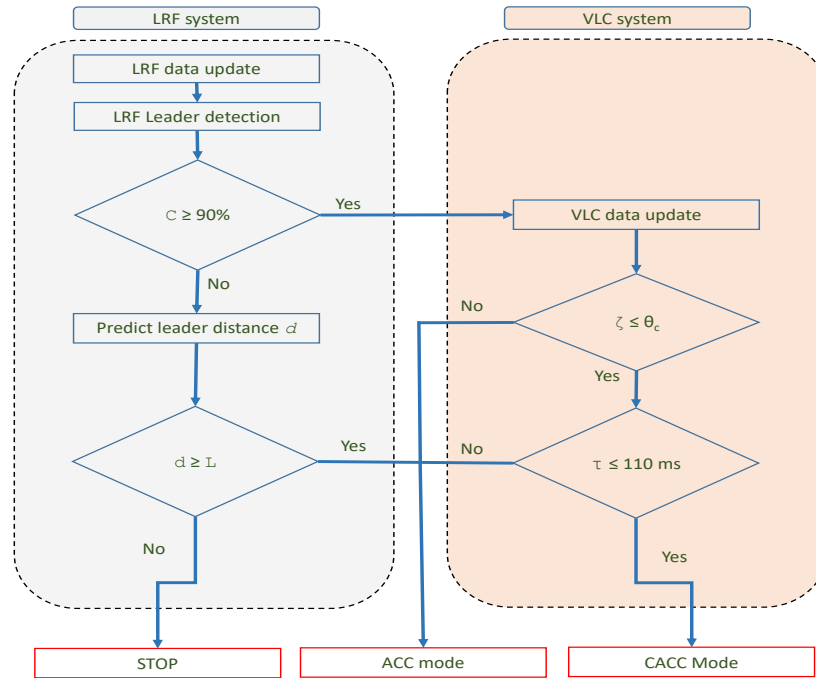

Figure 5.6: Flow chart of the handover between ACC and CACC driving modes using the LRF and VLC technologies.

Algorithm 1: The handover algorithm to switch between ACC, CACC, and STOP modes for platooning application using VLC to LRF.

```

Platoon system initialization;
Activate LRF detection;
Activate VLC transmission/reception;
 $L_{ID} \leftarrow$  Output Leader ID using LRF;
while ( $L_{ID}$  detected and fall in the  $W_{Area}$ ) do
    Activate ACC mode; ▷ Default mode
    while ( $C \geq 90\%$ ) do
        if ( $\zeta \leq \theta_c$  &  $\tau \leq 110ms$ ) then
            | Activate CACC mode ▷ Check VLC availability ;
        else
            | go to default mode;
        end
    end
    if ( $d \geq L$ ) then
        | go to default mode;
    else
        | Emergency STOP ▷  $v_p \leftarrow 0$ ;
    end
end

```

While the preceding vehicle is correctly detected by the LRF system ($C \geq 90\%$), the updated VLC data are analyzed to evaluate whether the conditions are sufficient or not to activate a cooperative mode. The first criteria checks if all of the tracked angles in (5.4) satisfies the safety requirement of being less than the critical angle $\zeta \leq \theta_c$.

$$\zeta = \max(\varphi, \psi, \theta). \quad (5.4)$$

The second criteria checks in real time if the delay τ between any two consecutive received packets is below the maximum allowed time delay (110ms). When these two criteria are satisfied, the algorithm outputs that it is safe to activate the CACC mode. However, when one of these conditions fails, only the ACC mode is allowed. If the detected failure of the VLC is followed by any problems with the LRF requirements, the STOP state is called immediately to exit the platooning mode.

5.2.3 Platforms Architecture

The proposed LRF-VLC system is evaluated combining the actual VLC hardware developed in Chapter 4, where the LRF, vehicular controller, vehicle models, and car-following trajectories are implemented in Pro-SiVIC simulation environment. Such evaluation meant to validate the feasibility of our system for the platooning application before applying the system in our experimental platforms.

5.2.3.1 VLC Platform

For the VLC system evaluation, we use the same prototype implemented in Chapter 4, where all the hardware's are detailed in 4.3.1. To recapitulate, realizing the VLC dual functionality of both data transmission and vehicular lighting, six LEDs array with an emission wavelength of 635 nm were deployed to imitate vehicular rear-light as a transmitter. As for the receiver end, the main components are the silicon PD with a trans-impedance switchable gain PDA100A, combined with an optical band-pass filter and a direct detection decision circuit. Figure 4.24 in 4.4.1 pictures the VLC principal components used in our study.

Moreover, the exchanged vehicular status are packed into a particular packet format as shown in Figure 5.7, where the data payload is detailed in 4.3.2.3. These data are then adapt Manchester line coding before modulating the LED array.

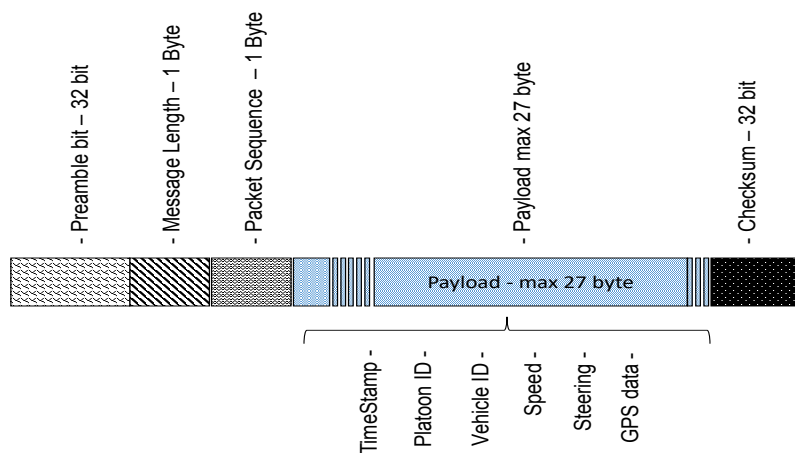

Figure 5.7: General Packet format used in VLC for intra-platoon communication, the packet sending a vehicular status such as (ID's, speed, steering, and vehicular coordinations).

5.2.3.2 Pro-SiVIC Platform

This validation of the **LRF-VLC** allows us to test the proposed system performance and limitations before the final integration into real platforms. Therefore, the primary goal was to test and validate the proposed approach uses cases and system feasibility for different road curvatures. Hence, Pro-SiVIC, a simulation platform for vehicles, sensors, and environment is used to simulate two autonomous vehicles forming a platoon and driving in three different scenarios:

1. Straight driving scenario: In this scenario, the leader vehicle is driven in a straight line with no road curvatures. The configuration introduces no limitation to either **VLC** or **LRF** which can activate the **CACC** mode.
2. Lane change scenario: This scenario drive the leader vehicle in straight lane and introduce lane change, where the leader vehicle is changing the lane at certain time instants.
3. Curve scenario: In this scenario, we use road curvature of crossroad, where the leader vehicle reaches 90° of orientation during the simulation, which is challenging for both **LRF** and **VLC**.

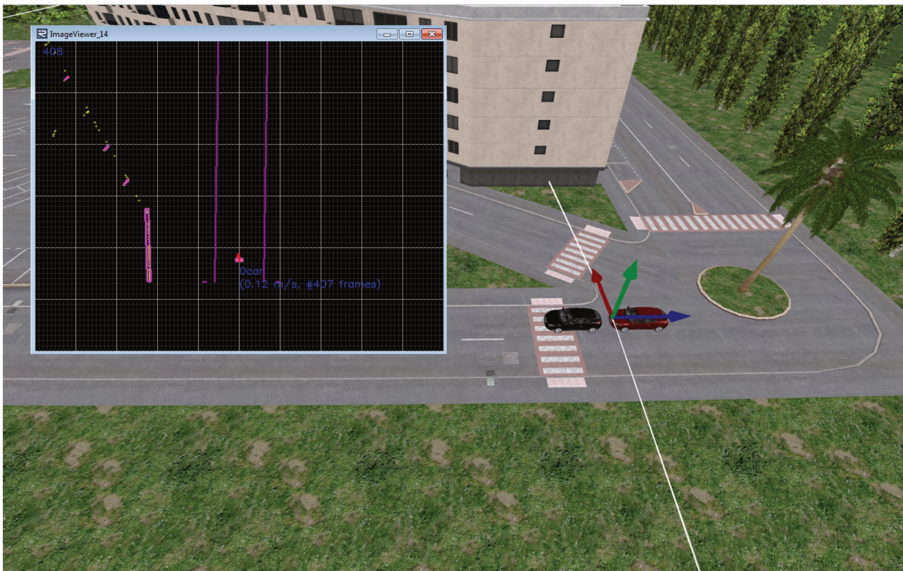

Figure 5.8: Pro-SiVIC simulation platform.

Figure 5.8 illustrates the Pro-SiVIC simulation environment where two autonomous vehicles models used to form a platoon. The black vehicle is the leader connected to an actual **VLC** transmitter, where the red one is the platoon

member equipped with VLC receiver and LRF to receive data and estimate the inter-vehicle distance. The top left image in Figure 5.8 pictures sample of the follower vehicle detection using LRF. The simulation environment parameters of the Pro-SiVIC and the hardware details of the VLC platform are both listed in Table 5.1. Moreover, full details regarding the VLC transmitter and receiver units are previously discussed in Chapter 4.

Table 5.1: Experimental parameters

VLC Platform Parameter	Value
Transmission data Rate	9.5 kbps
Link maximum range	30 meter
LED wavelength	635 nm (RED)
Line coding & Modulation	Manchester, OOK
LED power dissipation	3 Watt
Number of LED array	6
LED lens viewing angle	5°, 15°, 35°, 45°
PD active area	100 mm ²
Transmitter & Receiver heights	85 cm
Gain levels	30 dB, 40 dB
Pro-SiVIC Parameters	Value
Vehicle mass	1500 kg
Vehicle length (L)	4.2 m
LRF range	100 m
LRF angular aperture	180°
LRF angular resolution	0.25°
W_{Area}	9 m

5.2.4 Performance evaluation

The LRF-VLC system evaluation was carried the above mentioned three simulation scenarios representing different driving challenges. Specifically, the scenarios were meant to introduce communication and/or sensor failure and to compare the platoon behavior for the scenarios with and without VLC. For each of the listed scenarios, the VLC-FOV was set to 5°, 15°, 30° and 45°, where the LRF-FOV was set to 180° with width of interest $W_{Area} = 9m$.

All the depicted results in Figures (5.9, 5.10, 5.12) compare the leader vehicle speed ($Leader_{Speed}$) with the received speed over VLC link at the follower side (RX_{Speed}). Regardless the technology-in-use, either VLC or LRF, the results compare these speeds with the actual applied speed of the follower vehicle ($Follower_{Speed}$), where the $Speed_{difference}$ for each VLC-FOV case is calculated by:

$$Speed_{difference} = Leader_{Speed} - Follower_{Speed}. \quad (5.5)$$

5.2.4.1 Straight driving scenario

Figure 5.9 shows some of the obtained simulation results for straight curvature scenario. The results manifest an agreement between $Leader_{Speed}$, RX_{Speed} and $Follower_{Speed}$, where none of the tracking angles(θ, ϕ, ψ) exceeded the minimum 5° limit, and the LRF confidence $C = 100\%$ all over the trajectory. Thus, follower vehicle always uses the received $Leader_{Speed}$ over VLC link and drive in the CACC mode.

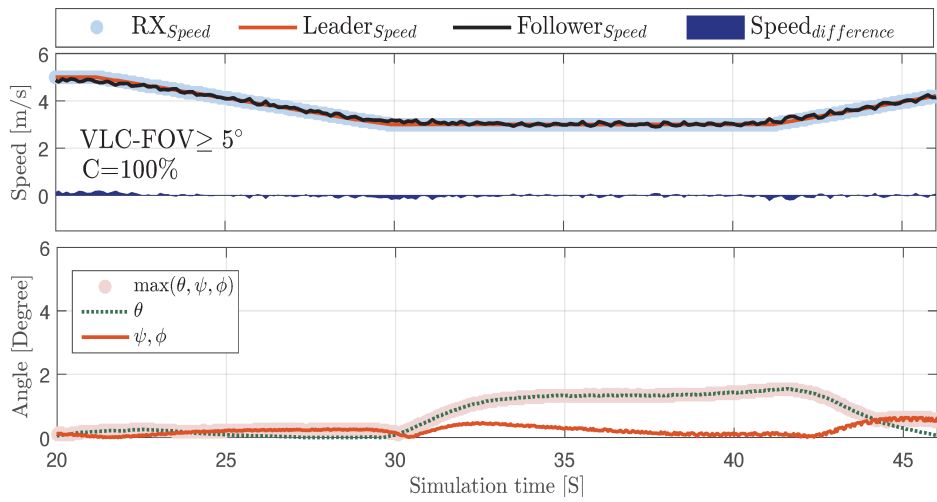

Figure 5.9: Simulation results of Straight driving platoon scenario. laser based detection confidence $C=100\%$.

5.2.4.2 Lane-change scenario

The VLC link is more subjected to FOV misalignment, especially when leader vehicle changes the lane. The results depicted in Figure 5.10 show the smooth performance of the $Follower_{Speed}$ till the simulation time window 30-43s (the period when the leader vehicle began to change the lane until the follower vehicle reach aligned state). In this time period, the $\max(\theta, \psi, \phi)$ exceeds the $\theta_c = 5^\circ$ and the disconnection occurs.

Since the obtained $C = 100\%$, the LRF will manage to backup the VLC link disturb and drive the platoon by downgrading the CACC to the ACC as described in the hand-over algorithm. Moreover, for any $VLC-FOV \geq 30$, the system behavior was as in the previous straight-lane scenario (completely driven using CACC mode).

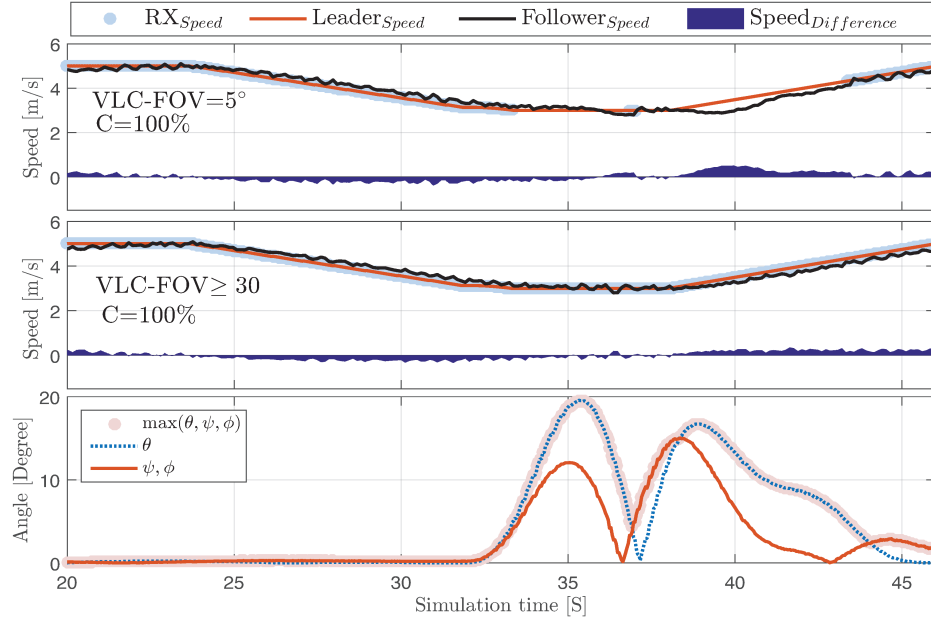

Figure 5.10: Simulation results of Lane-change driving platoon scenario. laser based detection confidence $C=100\%$.

5.2.4.3 Curve scenario

Compared to the two previous scenarios, driving the platoon using 90° curve trajectory will surely subjects the VLC link to the maximum FOV misalignment and even drives the follower vehicle close to the edge of LRF detection area.

As depicted in Figure 5.11, in this scenario, the leader vehicle is turning at the boundary of the laser area of interest (W_{Area}). The LRF system will start to lose the tracking continuity, and the confidence parameter C fluctuates between 0 and 100% for the first time in contrast to the previous other scenarios.

Thus, the distance to the preceding vehicle predicted by the controller is based on the latest vehicle displacement. In this particular case, the $Follower_{Speed}$ slows down while the leader vehicle is not detected with $C \geq 90\%$ over the time window 39.5-40.5s for VLC-FOV=5° in Figure 5.12. Better performance is observed for a VLC-FOV ≥ 45°, but the occurrence of communication disconnection is still observed.

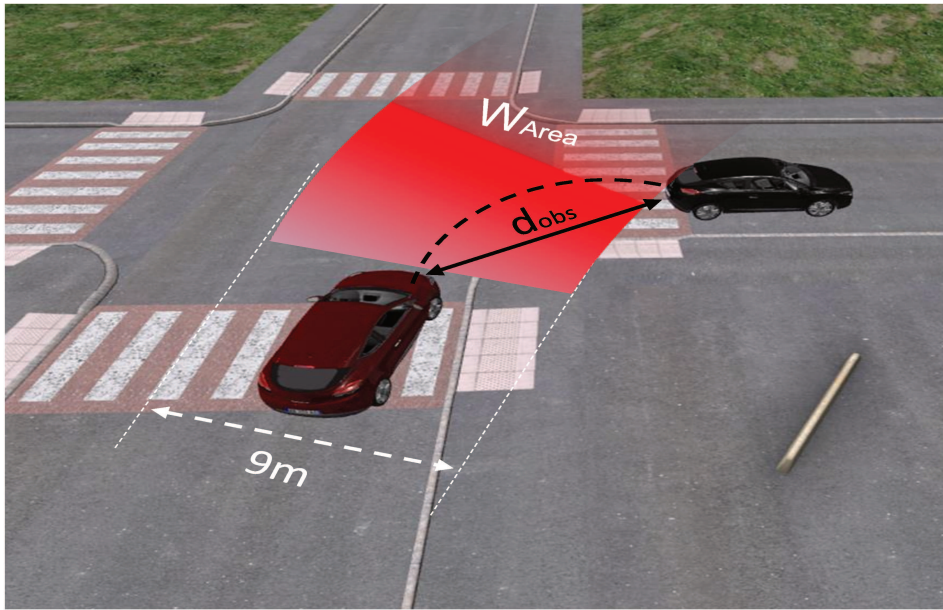

Figure 5.11: Pro-SiVIC simulation case for 90° curvature scenario, the platoon leader vehicle locate at the edge of the LRF of the follower vehicle.

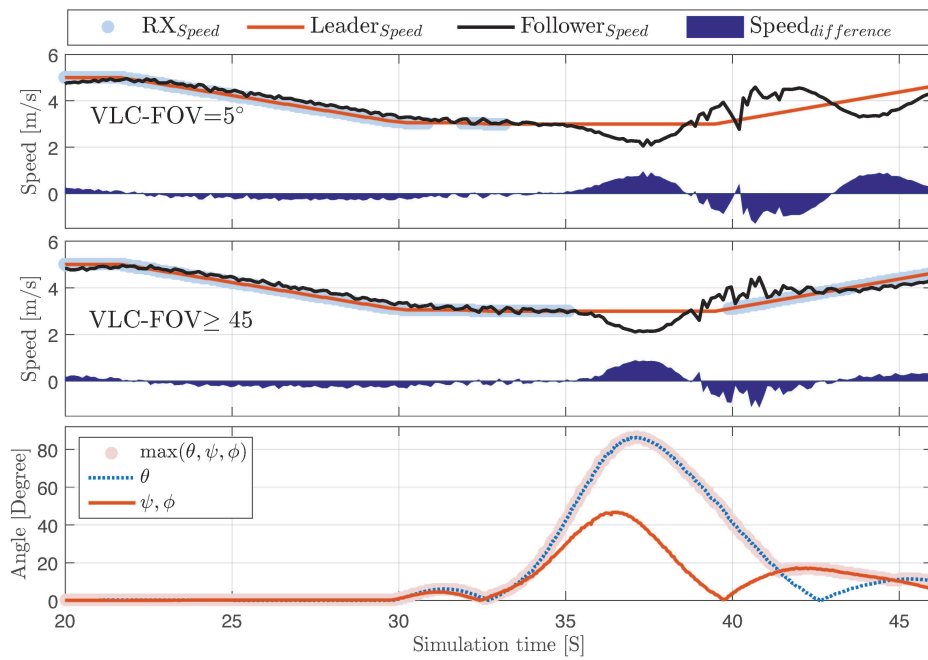

Figure 5.12: Simulation results of Curve driving platoon scenario.

While the tracked metric C is below the defined 90% limit in the hand-over algorithm, a non-smooth behavior of the $Followers_{speed}$ is observed due to the fluctuations of the estimated inter-vehicle distance. Since VLC is not enabled here, the system will try to predict the distance and maintain the ACC mode for the longest possible period before calling the emergency STOP status.

After 40.5s simulation time for $VLC-FOV \geq 45^\circ$, the leader vehicle is already detected with $C \geq 90\%$ and the VLC is enabled again, where both vehicles just finished the turning at the cross road as depicted in Figure 5.11. At this point, the condition $\max(\varphi, \psi, \theta) \leq 45^\circ$ is met and an activation of the CACC mode takes place again.

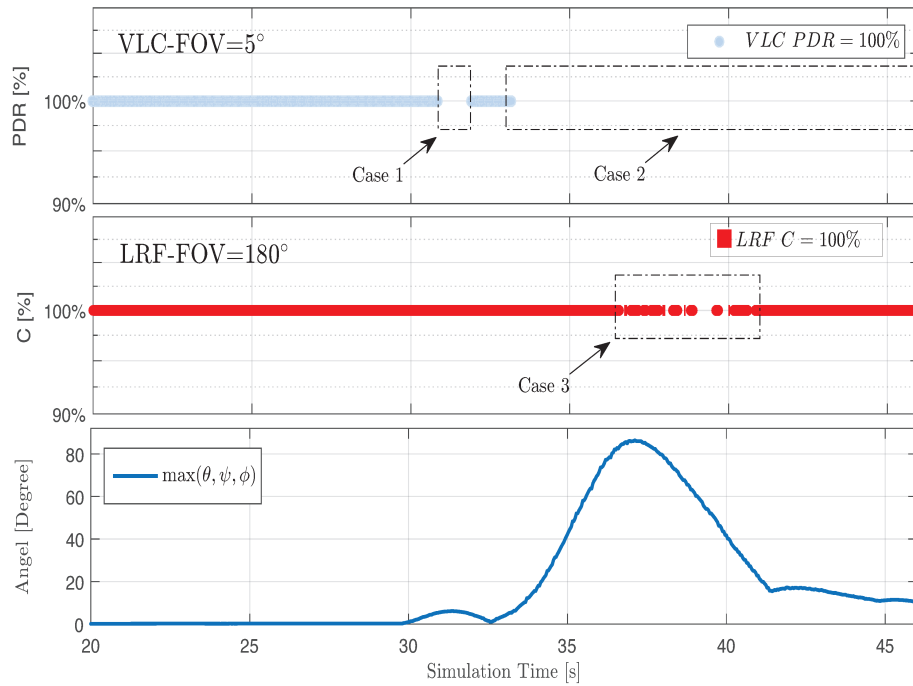

Figure 5.13: PDR and C Simulation result of Curve driving platoon scenario.

Figure 5.13 addresses the laser detection problem when the following one no more detects the leader vehicle. The results examine the narrowest VLC-FOV over the sharpest curvature (90°). Case 1 indicates the first occurrence of VLC disconnection due to the orientation limitation, during this period, the LRF is capable of substituting VLC and activate the ACC mode.

In case 2, the disconnection occurs again, but this time, the LRF will not be able to backup within a time delay satisfies the platoon safety requirements. The variation in C as seen in case 3 occurs because the leader vehicle is repeatedly detected and lost by the LRF of the follower. This detection fluctuation results in a non-smooth vehicle response. Indeed, the obtained results here open the discussion to either use one more backup technology such as radio communication or go toward improving the laser-based solution.

5.3 Radio communication and VLC

This section presents the proposed switching algorithm between VLC and RF technologies as an example of the complementary conceptual functionality of RF-VLC system. In order to ensure the data transmission continuity, a vertical handover algorithm using prediction mechanism PVHO is introduced.

The proposed RF-VLC system defers from the previously discussed LRF-VLC system in the way that when RF technology is deployed, the primary goal will be to reduce the load from the RF channel, where a proper handover needs to minimize the dependency on RF communication and use VLC as much as possible. Therefore, the redundancy period of both technologies is reduced without affecting application safety requirement or communication continuity. On the other hand, and as was explained in the previous sections, when LRF is used to backup the VLC for the same platoon application, the redundant usage of LRF and a communication technology is active all over the application lifetime. In another words, the LRF-VLC system is an application handover between (ACC and CACC), where the RF-VLC system is technology handover for the same CACC application.

The existing efforts deal with the conventional handover between two technologies included the primarily Immediate Vertical Handover (IVHO) and Dwell Vertical Handover (D-VHO) [94]. In general, the IVHO performs an immediate switching between two different technologies based on a metric defined by the handover algorithm. Applying this to the RF-VLC system, the handover algorithm will switch between RF and VLC channels immediately when the VLC link is interrupted or resumed. On the other hand, the D-VHO sets a fixed period of time (few seconds) before executing any switching. The both schemes are taken into consideration to indicate that neither IVHO or D-VHO alone is desirable for platooning applications, where safety requirements are strict.

Moreover, an extended version of these conventional mechanisms will be proposed to manage the VHO between RF and VLC technology by giving an attention to application safety requirement and switching timing.

By recording VLC disconnection duration τ_{disc} and message sequence number in real time, together with tracking the VLC link FOV, we propose a PVHO mechanism that identifies proper switching time and predicts the effectiveness of both the schemes to achieve a better decision when an interruption occurs. Moreover, a metric to sense the RF channel congestion levels is introduced to ensure the data flow continuity and safety requirements of platoon application. Therefore, the switching mechanism between RF and VLC is defined to be based on the availability of VLC technology and the RF CBR metric.

5.3.1 Conventional VHO existing schemes

The existing handover proposals for RF-VLC systems are meant for indoor VLC systems, or what's called lately Li-Fi communication such as home internet APs [126]. In such systems, the VLC interruption period of several seconds often considered as normal operation conditions.

For this reason, the existing handover algorithms are not perfectly suitable for an ITS environment. Still, C-ITS applications using VLC have the common motivation with these handover mechanisms, which is reducing heavy load from RF spectrum. Therefore, we still can benefit from the conventional VHO mechanism to implement an appropriate switching solution for platooning application.

Two conventional schemes as described in [94, 95] are usually used as basic VHO algorithms as the following:

1. Immediately performing a VHO to RF technology (IVHO scheme or hard-handover).
2. Waiting period of time in case of VLC resumption then performing a VHO to RF technology (D-VHO scheme).

Figure 5.14 represents the flow diagrams of these two basic VHO mechanisms. When application enables communications, the RF is enabled by default to start information exchange. The depicted algorithm in 5.14.a start monitoring the availability of VLC data. If available, the algorithm will switch the reception to the VLC channel in immediate customs. Whenever an interruption occurs, the IVHO scheme performs instant switching back to the RF channel and avoids any waiting.

On the other hand, a more advanced mechanism **D-VHO** uses a predefined fixed time τ_{disc} as in Figure 5.14.b. This monitoring timer was mainly introduced to prevent any decision fluctuation.

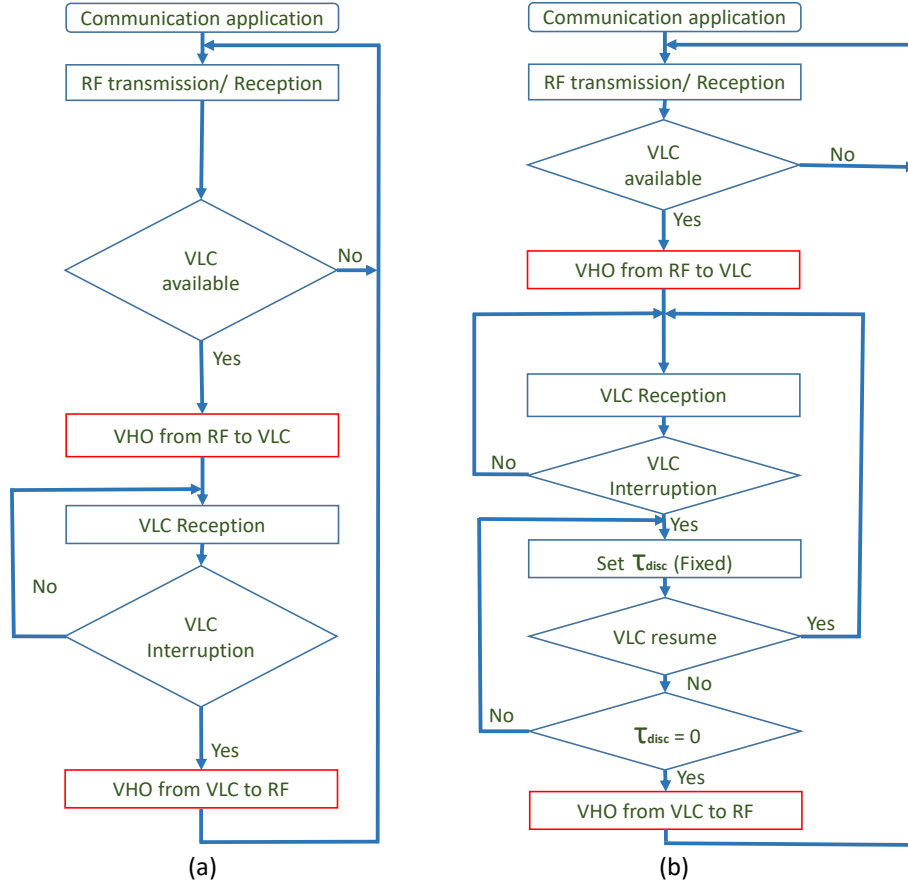

Figure 5.14: Flow diagrams show the two basic VHO schemes. (a) Classic immediate vertical handover (IVHO) diagram between VLC and RF. (b) Dwell vertical handover (D-VHO) diagram with a disconnection waiting period τ_{disc} .

The delayed activation of the **RF** transmission will allow the **VLC** to recover the transmission if the interruption is shorter than a predefined dwell time τ_{disc} . Moreover, the third conditional statement in Figure 5.14.b will check if the **VLC** does not resume the transmission before the timer expires. Otherwise, a handover to **RF** will be applied.

The conventional **IVHO** flow diagram depicted in Figure 5.14.a can be further illustrated by (Algorithm 2) and Figure 5.15. The simplicity of this mechanism makes it inadequate for **ITS** safety applications, where the hard-handover cases may raise-up causing communication continuity instability.

Algorithm 2: IVHO algorithm, the switching from VLC to RF and vice-versa is immediate

```

Communication system initialization;
Activate RF transmission/reception;
Activate VLC transmission/reception;
while (System active) do
  while (VLC available) do
    Deactivate RF transmission;           ▷ VHO from RF to VLC ⇒
    if (VLC interrupted) then           ▷ VHO from VLC to RF ⇐;
      | Activate RF transmission
    else
      | break; (exit while loop)
    end
  end
end
end

```

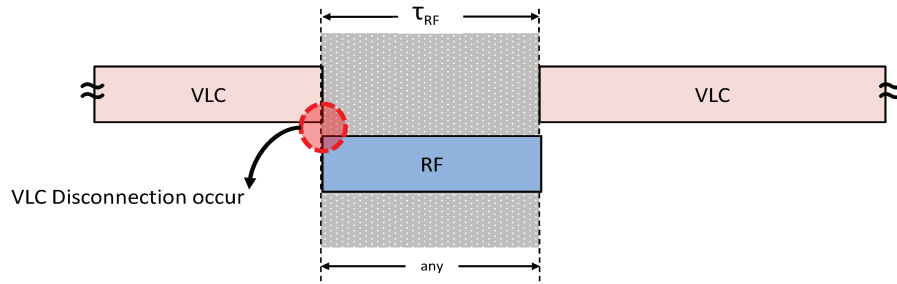

Figure 5.15: IVHO switching stages between VLC and RF.

In the same way, the D-VHO diagram in Figure 5.14.b can be interpreted by (Algorithm3) and Figure 5.16. The second scheme proposes to use τ_{disc} , which represents the time in which the system can hold (waiting for the VLC to recover before switching to the RF), and τ_{RF} is the time period of enabling RF technology.

The waiting process starts by setting a fixed period while continuously checking the VLC availability, once the timer expires, the VHO to RF is enabled by activating the RF transmission. Otherwise, VLC resumption will keep the RF disabled. Also, the handover from VLC to RF takes an immediate behavior upon VLC availability.

Algorithm 3: D-VHO algorithm, the switching from RF to VLC is immediate whenever interruption occur, while switching back to RF is dependent on VLC resume over a fixed period of time (τ_{disc}).

```

Communication system initialization;
Activate RF transmission/reception;
Activate VLC transmission/reception;
while (System active) do
  while (VLC available) do
     $\tau_{init} \leftarrow$  System time;
    Deactivate RF transmission;  $\triangleright$  VHO from RF to VLC  $\implies$ 
    if (VLC interrupted) then
       $\tau_{disc} \leftarrow 0$ ;
      while ( $\tau_{disc} \leq$  (Fixed value)) do
        if VLC available then
          | break; (exit while loop)
        else
          |  $\tau_{disc} =$  System time  $- \tau_{init}$ ;
        end
      end
      Activate RF transmission  $\triangleright$  VHO from VLC to RF  $\longleftarrow$ ;
    else
      | break; (exit while loop)
    end
  end
end

```

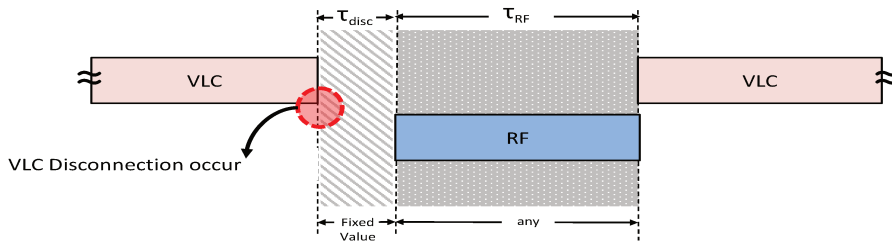

Figure 5.16: D-VHO switching stages between VLC and RF.

The conventional D-VHO mechanism can be extended and deployed for platoon applications. The subsequent sections introduce our proposed VHO between RF and VLC using dynamic D-VHO and a prediction-based mechanism, where an additional dynamic redundancy period $\tau_{Redundant}$ is applied

after any interruption occurrence for further safety confirmations. Moreover, a specific platoon related key metrics are defined to make the prediction-based handover decisions.

So far, the proposed conventional handover algorithms define the switching status from RF channel to VLC channel only based on the availability of VLC technology. For such mechanisms, the switching decision is entirely depending on the VLC link PHY metrics, such as packets arrival time, FOV limitation, where the main goal is to disable the RF technology by assuming the presence of critical channel congestion levels. Therefore, no real-time evaluation of the RF technology is tackled. Moreover, the core assumption of these proposals considers the absolute condition of the RF channel when VLC is interrupted, which adds an inconsistency of the initial assumption.

5.3.2 RF congestion problem

To understand the RF channel congestion influence and extract a proper metric. A simulation study was conducted to investigate the RF communication channel performance for different traffic densities consisting a platoon formation. Two scenarios were built in NS3 to test the RF channel congestion improvement when VLC is enabled between platoon members. The performance was evaluated by extracting the PDR for many iterations and different vehicular densities as follows:

- **Scenario I**
Road length is 10 km. Three lanes of random traffic and one lane dedicated for multi-platoon formation. All vehicles in this scenario use radio communication to broadcast information using the same communication channel, where the number of active communication nodes equals the number of all presented vehicles in the scenario $\tilde{\chi} = \chi$.
- **Scenario II**
Road length is 10 km. Three lanes of random traffic and one lane dedicated for multi-platoon formation. All vehicles in the random traffic lanes use radio communication to broadcast information using the same RF channel, together with the platoon's leader vehicles, while the platoons following vehicles are not using any communication, assuming VLC is used. The number of the active communication nodes equals the number of random lane vehicles, added to the number of platoon formations. $\tilde{\chi} = \chi - (N)(n - 1)$, where N represent the number of platoon formations (number of platoon leaders) and n represent the individual platoon members number.

The simulation scenarios were set to resemble the sparse, medium, and high-dense traffic conditions of the depicted 4 lanes in Figure 5.17, where the communication and mobility configurations are detailed in Table 5.2 .

Table 5.2: Mobility and communication parameters for multi-lane vehicular distribution

Communication simulator	NS3-23 WAVE Module - 2015
Number of nodes	600 (vehicle/node)
Application	V2V communication - No RSUs Vehicular safety messaging - VANET Broadcast-message based 100ms update time - CAM on availability - DENM Communication range - Omnidirectional 500m Sensing range 1km
Mobility simulator	SUMO 0.26 - 2015
Scenario length	10 km
Number of lanes	4 lanes - bi-directional One lane dedicated for platoon Lane number 1
Inter-vehicle distance	8 m
Intra-platoon distance	24 m
Number of platoons	22 formation
platoon size	4 vehicles
Number of platoons members	22x4=88 vehicle
Number of non-platoons members	600-88= 512 vehicle
Random vehicle speed	Mixed speed Min 10 m/s - Max 20 m/s
Platoon speed	constant speed 12 m/s

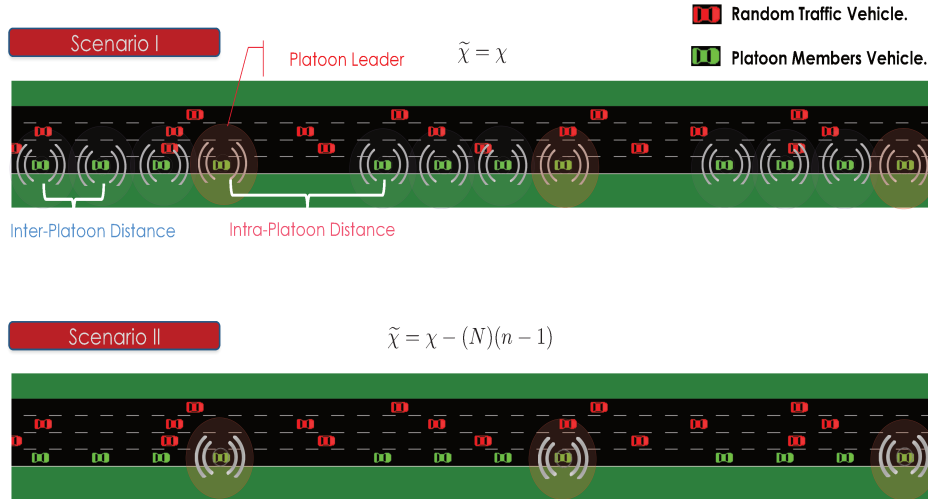

Figure 5.17: Four lanes simulation scenarios in NS3: Scenario I enables RF communication broadcast for all vehicles. Scenario II enables RF broadcast for all vehicles except platoon followers, assuming VLC is used as IVC between platoon members.

Figure 5.18 compares the obtained results when the VLC is assumed to be enabled between platoon members (Platoon Head BroadCast) and the standard situation when all vehicles are using RF communication (All Platoon Members BroadCast).

The obtained results draw a remarkable improvement in PDR levels when VLC is deployed between platoon members, where the improvement can reach up to 20% in a high dense scenario. By only counting the amount of dropped packets for such highly-safety demanded application, we can conclude and observe the severe congestion influence on the RF channel, where the PDR is falling dramatically with the density increment. In contrast, the results show that by enabling VLC, the overall performance is much better for increased numbers of close-by vehicles (micro-scale).

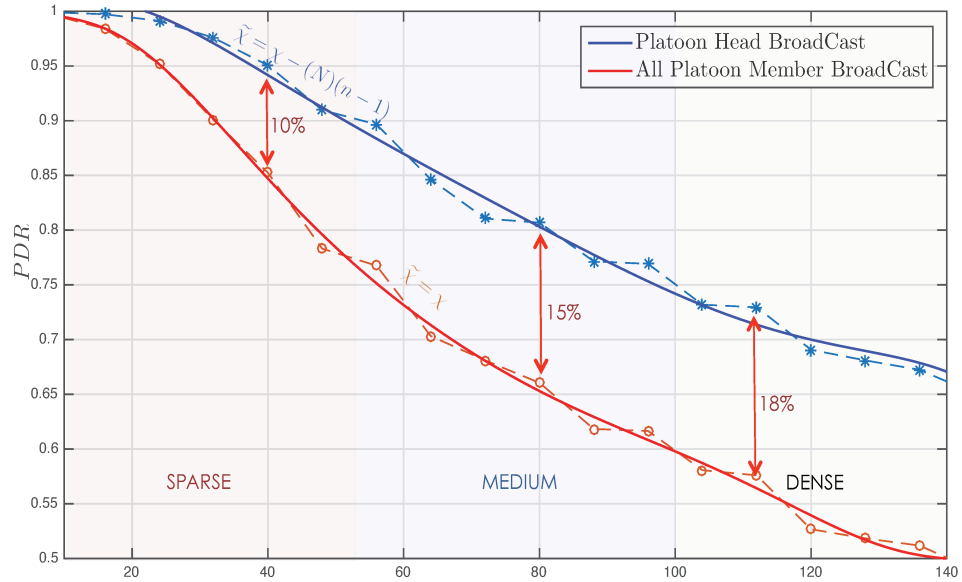

Figure 5.18: PDR Simulation results of Scenario I and Scenario II.

For distributed systems such as VANET, the vehicles that exchanging the CAM and/or DENM message over the RF channel are not aware of the number of all vehicles sharing the same channel. Therefore, the numbers represented by the simulation study such as $\tilde{\chi}$ and χ are only obtained in a simulation environment and then post-processed to observe the overall performance. Hence, the PDR is not a beneficial metric to be used to evaluate the RF channel congestion issues. On the other hand, an interesting RF channel metric such as the CBR (or channel occupancy ratio) can be an accurate metric to sense the RF channel congestion [127].

By drawing a relation (or lookup table) between the obtained **PDR** and **CBR** values, each vehicle in a **VANET** can sense in real time the **RF** channel congestion levels.

The simplest definition of the **CBR** metric is a measurement of the **RF** channel load. It can also be interpreted as a function that calculates the ratio of the time channel being busy (T_{busy}), (*i.e.* the received power is greater than a predefined sensing threshold), over the monitoring interval ($T_{monitor}$):

$$CBR = \sum \frac{T_{busy}}{T_{monitor}}. \quad (5.6)$$

The depicted results in Figure 5.19 shows the relationship between the **PDR** and **CBR** for different vehicular densities. For this simulation scenario, the monitoring interval $T_{monitor}$ was set to $100ms$, where the **CBR** measurement function is triggered periodically. An example of results can be extracted from Figure 5.19, where the **CBR** around 30% is directly representing **PDR** more than 95%, which can be the threshold for particular safety application.

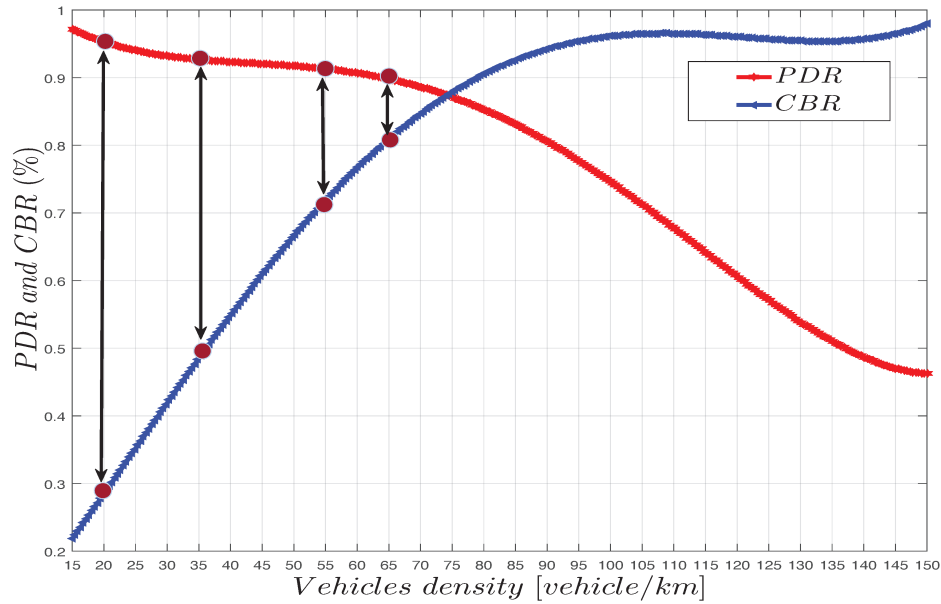

Figure 5.19: The relation between CBR and PDR for different vehicular densities.

Establishing a relationship between the outputs of both **PDR** and **CBR** can be a cornerstone concept defining the next improvement of the proposed **PVHO** algorithm decision. As it will be detailed in the subsequent sections, deploying the **CBR** metric can allow both **RF** and **VLC** channels to operate in a redundant mode as soon as the **CBR** is under certain levels. By using such configuration, we expect a further safety improvement of the convoy-based systems.

5.3.3 RF-VLC system configuration and assumptions for platooning application

As it has been discussed and evaluated earlier, the longer deployment of the **VLC**, the lower is the **RF** channel load. Therefore, when recognizing **RF-VLC** system, the main intention is to enable the **VLC** between platoon members as much possible by defining a proper way to switch between both technologies while ensuring the maximum safety requirements while driving autonomous-based platoon.

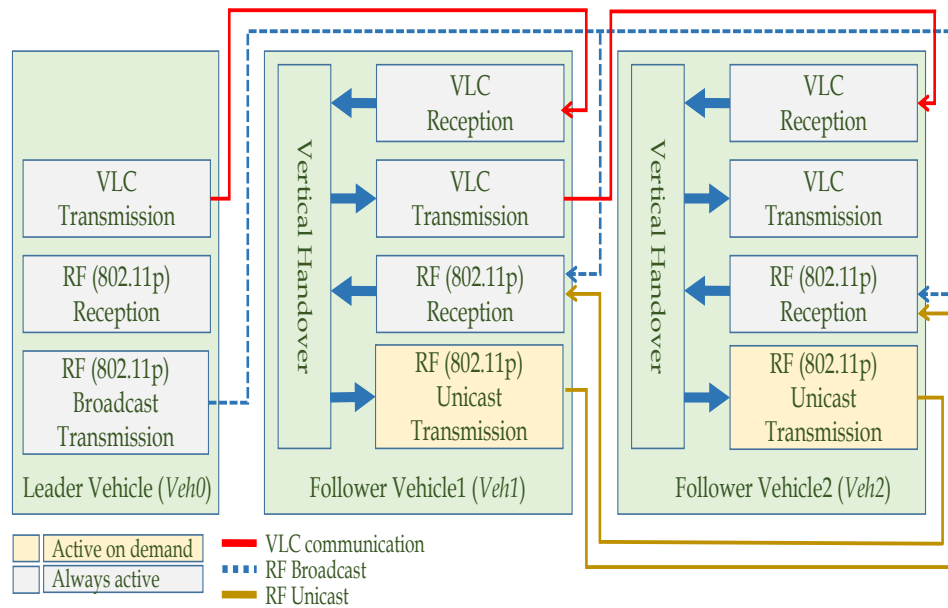

Figure 5.20: RF-VLC communication system for platooning application.

Figure 5.20 illustrates the communication configurations of the proposed **RF-VLC** system for platooning application. The communication system suggests the deployment of the **VLC** as an inter-vehicle communication com-

bined with a unicast and broadcast RF communication links. The illustration scenario recognizes two platoon members in which lead by a platoon leader (*Leader Vehicle Veh0*).

Each platoon member in the proposed system is capable of exchanging data with other platoon members over RF channel by utilizing broadcasting/unicasting mechanisms. The VLC channel supports half-duplex-link that enable communication from each vehicle to the subsequent follower *e.g.* (*Veh0-to-Veh1*, *Veh1-to-Veh2*) based on technology availability. The leader vehicle has the same configurations except it has no VLC-receiver unit, and it will always use RF-broadcasting.

The highlighted stages in follower vehicles 1 and 2 (RF unicast transmission/reception) are the only on-demand activated stages, whereas all other stages are active over the entire application activation time. Since VLC provides a half-duplex communication link, the RF unicast transmission stages are used to inform the proceeding vehicle when a VLC interruption is expected to occur. A trigger message will be received by the (RF (802.11p) unicast reception) to activate the proceeding vehicle (RF (802.11p) unicast transmission) and therefore switch to the RF channel upon request.

Moreover, every individual platoon member will continuously listen to any request to enable the RF transmission due to any detected failure or delay in VLC packets reception. Therefore, the (RF(802.11p) Reception) will always be an active stage. However, this activation is not contributing in any beaconing or adding any load to the RF channel.

The proposed RF-VLC system for platooning application is based on the following assumptions:

- The communication system always starts by using the RF technology to broadcast from (*Veh0*) to all platoon members, together with RF unicast links to exchange data between each vehicle.
- Since the RF-VLC system is using the VLC upon availability, and for safety reasons, whenever the system detects an interruption in VLC reception by any mean, the RF technology will be activated despising its channel condition.
- We suggest a dynamic prediction-based handover method (which means a decision before the occurrence). The access time needed to enable the RF technology after detecting the VLC potential discontinuity was assumed to be less than disconnection occurrence time.
- All platoon members using the RF-VLC system are assumed to have highly accurate positioning capability (GPS systems).

5.3.4 RF-VLC switching key metrics for platooning

For any VLC link interruption occurrence, the packets which are partially transmitted or waiting for transmission will be directly affected. The used packet format depicted in 5.7, contains a packet sequence and message length data, accompanied with the message payload. The interruption effect on the packet can be easily tracked by continuously monitoring these two values. Moreover, tracking a specific packet sequence followed by unique platoon ID and Vehicle ID, could allow the system to ignore any packet reception interference from other VLC communication sources.

The PiT which was defined as the time required to successfully receive two subsequent packets while considering each packet sequence order; has also a direct impact on the continuity of the communication process and safety requirements.

The system implementation and the proposed PVHO in the subsequent sections focus on checking the VLC availability and switching from VLC to the RF technology in the presence of any interruption. Moreover, the CBR metric is considered to evaluate, in real-time, the RF channel performance in order to control the redundant period between both technologies dynamically. Therefore, our proposed handover mechanism strongly depends on tracking of both the RF and VLC channels parameters.

Furthermore, tracking the VLC subsequent packets reception together with CBR can overcome the situation when the FOV requirements might be satisfied with a presence of a blocking obstacle.

We suggest the following metrics as the performance indicators of our vertical handover strategy:

1. Packet sequence (N): The handover algorithm can track the VLC received packets sequence, any certain jump in the sequence number such as $\Delta N \geq 4$ will trigger the handover to RF channel. In other words, If the counted PiT between any two subsequent packets reception exceeds a certain threshold ($110ms$), the handover algorithm can judge that the VLC link was interrupted.
2. Message length (l): Our system transmits packets with a fixed length, where any change in the received packet length can be counted as a partially received packet. Consequently, the VLC link interruption occurrence will be assumed.
3. Vehicles relative orientation: This metric is special for platooning application, where it represents the relative angular orientation between

two subsequent platoon members. The misalignment tracking is vital to predict the upcoming VLC link interruptions.

4. **RF** channel occupation time (**CBR**). This metric used to guarantee the **RF** channel reliability when the redundant mode is active.

The difference between two subsequent packet numbers ΔN was chosen based on the experimental results of the VLC prototype validation in Chapter 4. The experiment results depicted in Chapter 4, Figure 4.29 showed that the system average PiT was no more than 36 ms when the VLC is at its best performance. Therefore, the system can handle three subsequent missed packets of total update time = $3 \times 36 = 108$ ms. If three subsequent packets are lost ($\Delta N \geq 4$), the system reception delay time will exceed the application 100ms safety limits; consequently, ΔN was set to be ≤ 3 . Further details regarding the vehicular relative-orientation metric and tracking mechanism are further described in the subsequent section.

5.3.5 Prediction-based VHO method for platoon application

In order to achieve communication continuity of the RF-VLC system, we propose an extended version of the D-VHO mechanism as depicted in Figure 5.21. The proposed PVHO mechanism implies using a realistic fixed redundant time period $\tau_{Redundant} = 500ms$, which is enough period to successfully receive about 15 packets over the VLC channel and before disabling the RF transmission units. In addition to improving system reliability by giving enough waiting time, $\tau_{Redundant}$ was chosen to prevent any fluctuation of the switching mechanism, where VLC system can be sensitive to tiny period of disconnection when the switching process operates around a specific threshold level.

For further safety improvement, an additional dynamic redundant period (τ_{cbr}) is proposed to enable both technologies based on the CBR metric. If the RF channel measured CBR levels found to be at certain levels, the RF technology would remain active in redundant mode and despising the excellent performance of the VLC channel.

The PVHO suggests using vehicular related velocity, maximum vehicle velocity, and the angular orientation between each two sequenced platoon members to predict the VLC interruption. The prediction decision is based on processing the prediction angle (θ_p), which dynamically influence a redundant period between RF and VLC (τ_p) before disconnection occurs.

To find the VLC predicted interruption angle θ_p , the proposed RF-VLC system assumes that each platoon member is equipped with an accurate

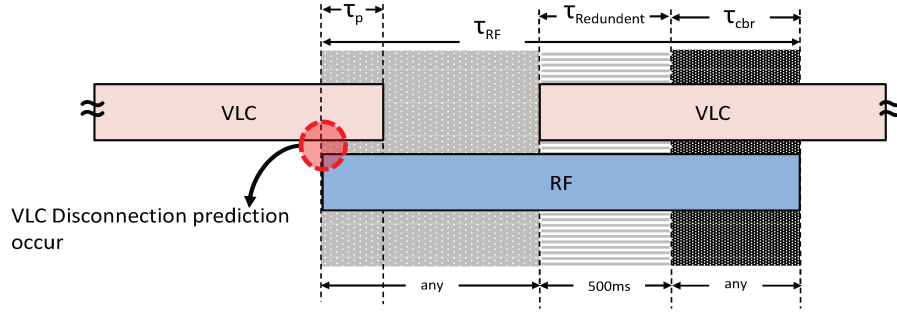

Figure 5.21: Prediction-based VHO switching stages between VLC and RF.

positioning system providing the (x_2, y_2) and (x_1, y_1) coordination data as depicted in Figure 5.22. Instead of the actual position of the GPS devices that assumed to be centering a vehicle of length L , the system prediction mechanism aim to calculate the relative coordinates (x'_1, y'_1) and (x'_2, y'_2) , which represents the coordination of *Preceding vehicle* rear aspect and *Follower vehicle* front side respectively.

Following the same procedure introduced within the previous proposal to enhance the FOV limitations in Chapter 3, we calculate the relative coordinations as the following:

$$\begin{cases} x'_1 = x_1 - \cos(\theta_1) \\ y'_1 = y_1 - \sin(\theta_1) \end{cases} \quad (5.7)$$

$$\begin{cases} x'_2 = x_2 + L \times \cos(\theta_2) \\ y'_2 = y_2 + L \times \sin(\theta_2) \end{cases} \quad (5.8)$$

Hence, the relative coordinates regarding the follower vehicle can be expressed as two relative distance vectors as the following:

$$\begin{cases} x_{rel} = x'_1 - x'_2 \\ y_{rel} = y'_1 - y'_2 \end{cases} \quad (5.9)$$

By using (5.9), we can conclude that the front angle of the following vehicle θ_F can be expressed as the following:

$$\theta_F = \text{atan}\left(\frac{y_{rel}}{x_{rel}}\right), \quad (5.10)$$

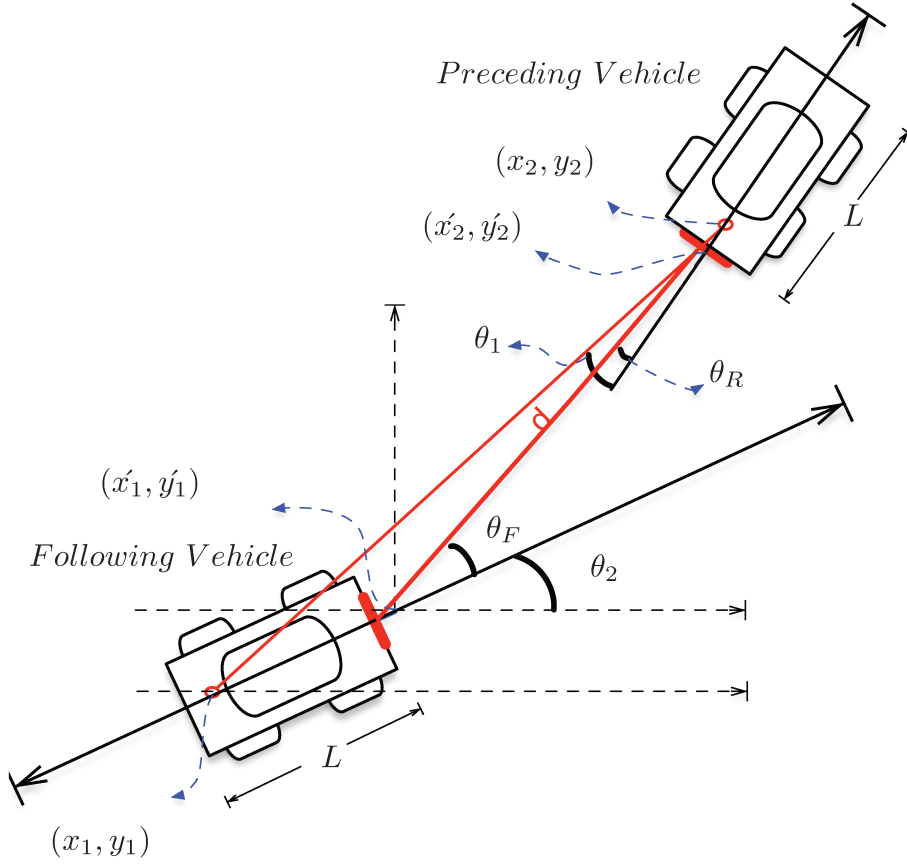

Figure 5.22: Two vehicles VLC-based platoon ray tracing model.

while the rear angle of the preceding vehicle is:

$$\theta_R = \theta_1 - (\theta_F + \theta_2). \quad (5.11)$$

After developing explicit relations between the vehicles orientation and both front and rear angles $(\theta_R, \theta_F) \rightarrow f(\theta_2, \theta_1)$, we can use this information to track the relative misalignment between both vehicles in real time. By now, the VLC between autonomous platoon members will certainly experience disconnection when $(\max(\theta_R, \theta_F) \geq \theta_c)$, where θ_c represent the critical optical FOV limitation. Moreover, (θ_R, θ_F) angles can also be seen in this context as a dynamically changing incidence and irradiance angles of the VLC link.

As depicted in Figure 5.21, to dynamically enable RF and VLC redundancy before the actual VLC disconnection occurrence. The mechanism suggests using vehicular velocity v and maximum vehicle velocity v_{max} to regulate the dimension of this redundancy period by making $\theta_p \rightarrow f(v)$ as the following:

$$\theta_p = \theta_c - \left(\frac{1}{2} \frac{v^2}{v_{max}^2} \right). \quad (5.12)$$

Since the RF-VLC platoon system using the constant inter-vehicle distance (d) approach, the separation distance between platoon members will remain constant. Therefore, we chose to use the relative vehicle velocity to update the prediction angle. The term $\frac{1}{2} \frac{v^2}{v_{max}^2}$ has been selected to decrease the prediction angle in square law manners while the velocity increases. Figure 5.23 shows the dynamic relation between relative vehicle velocity and the prediction angle, for an optical critical angle $\theta_c = 15^\circ$.

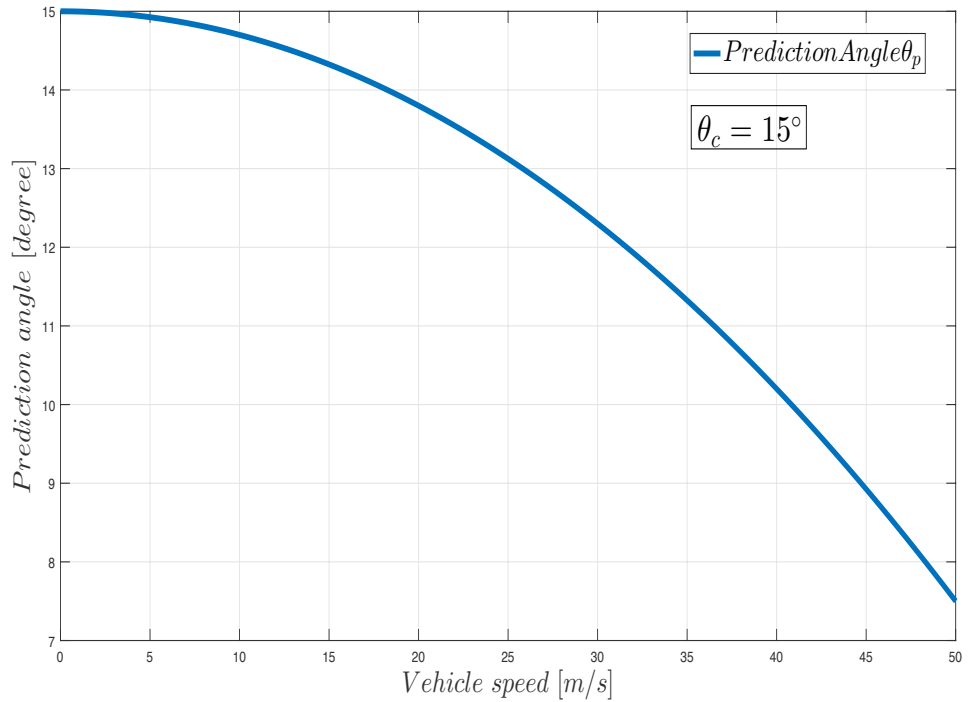

Figure 5.23: The relation between prediction angle θ_p and vehicle velocity v .

To this end, we can see that the essence of the proposed PVHO algorithm is to continuously check if the $(\max(\theta_R, \theta_F) < \theta_p)$, which represent one of VLC availability handover algorithm conditions as it will be further detailed.

If the condition for some reason is dissatisfied, the algorithm decides that a VLC disconnection is about to occur. Therefore, instant activation of the RF-transmission is expected to give enough redundancy time to ensure communication continuity.

Moreover, for any interruption occurrence due to either ΔN , or l , while the RF communication is off, the proposed PVHO algorithm will turn to be a conventional D-VHO algorithm as described in 3.

The sub-Algorithm 4 shows the proposed PVHO core function for VLC availability test. Whenever the function $find(\theta_p, \Delta N, l)$ is called, the link disconnection prediction angle θ_p and the received packets sequence ΔN , together with the received packet length l are processed.

Algorithm 4: The proposed PVHO algorithm core function to sense the VLC availability

Function $find(\theta_p, \Delta N, l)$

$\Delta N \leftarrow (N_{i+1} - N_i);$

▷ Difference between two subsequent received packets

$\theta_p = \theta_c - \left(\frac{1}{2} \frac{v^2}{v_{max}^2}\right);$

▷ VLC disconnection prediction angle

$l \leftarrow \text{received packet length};$

▷ VLC received packet length

As for monitoring the RF CBR metric, the sub-algorithm 5 is called in a periodic manners to calculate the channel occupation time and return the ratio.

Algorithm 5: The proposed PVHO algorithm core function to sense the VLC availability

Function $calculate(CBR)$

$T_{monitor} \leftarrow 100ms;$

▷ Assign monitoring time

$CBR \leftarrow \frac{T_{busy}}{T_{monitor}};$

▷ Calculate CBR metric

Algorithm 6 details the **PVHO** decision-making process to enable platoon of autonomous vehicles relying on **RF-VLC** system by checking the availability and performance of two independent communication technologies. Algorithm procedure starts by enabling both **RF** and **VLC**, where all communication stages of the depicted system description in Figure 5.20 are active. An initialization of both $\tau_{Redundant}$ and τ_{disc} is performed before start recording any received packet over the **VLC** link.

While the system is active, the algorithm will continuously call the two core functions ($find(\theta_p, \Delta N, l)$) and ($calculate(CBR)$) to immediately check the **VLC** link availability and the **RF** channel performance. If the link is available, a redundant timer $\tau_{Redundant}$ of 500ms will be set co-occurred with a continuous check of the **VLC** link metrics. Moreover, any reported link disturbance before the $\tau_{Redundant}$ timeout will reset the timer to keep the **RF** in redundant mode, while the **VLC** link availability check is active.

Once the system is active, **VLC** is available, and the $\tau_{Redundant}$ timer is expired, the algorithm will check if the **RF** congestion level can allow further extension of the redundant period. Referring to the obtained results in Figure 5.19, a **CBR** of 60% was considered as the maximum congestion level to allow the redundancy extension. If the **CBR** condition is not met, only then, **RF** unicast transmission units depicted in Figure 5.20 are disabled and the **VHO** from **RF** to **VLC** is performed. At this point, the meant two platoon members will totally depend on the inter-**VLC** channel to exchange information.

Since both ΔN and l metrics errors are due to an obstacle presence in the **VLC** link **LoS** or the relatively large inter-vehicle distance. Any further detected **VLC** interruption due to the terms ΔN , or l , will trigger an immediate switching from **VLC** to **RF**. Otherwise, if the disconnection is expected to occur due to the **FOV** misalignment, the system will have a soft-handover, where the **RF** stages are activated before the **VLC** disconnection occurrence.

Algorithm 6: IVHO mechanism, for any platoon members except the leader vehicle, where the RF transmission is always active

```

Platoon system initialization;
Activate RF transmission/reception;
Activate VLC transmission/reception;
 $\tau_{disc} \leftarrow 0ms$ ;
 $\tau_{Redunence} \leftarrow 0ms$ ;

while Active do
   $N_i \leftarrow$  Packet number            $\triangleright$  Save VLC received packet number
  find( $\theta_p, \Delta N, l$ );                 $\triangleright$  compute  $\theta_p$  and  $\Delta N$ 
  if ( $\max(\theta_R, \theta_F) \leq \theta_p \parallel \Delta N_{packet} \leq 3$ ) then
     $\tau_{init1} =$  system time;
    while ( $\tau_{Redunence} < 500ms$ ) do
      find( $\theta_p, \Delta N, l$ );               $\triangleright$  compute  $\theta_p$  and  $\Delta N$ 
      if ( $\max(\theta_R, \theta_F) > \theta_p \parallel \Delta N > 3$ ) then
        |  $\tau_{Redunence} \leftarrow 0ms$             $\triangleright$  reset  $\tau_{Redundant}$ 
      else
        |  $\tau_{Redundant} \leftarrow (system\ time - \tau_{init1})$ ;
      end
    end
    calculate(CBR);                        $\triangleright$  compute CBR
    if ( $CBR \geq 60\%$ ) then
      | Deactivate RF transmission;  $\triangleright$  VHO from RF to VLC  $\implies$ 
    else
      | break; (exit while loop)
    end
  else
    while ( $\tau_{disc} \leq 100ms$ )              $\triangleright$  wait  $\tau_{Redundant}$  do
       $\tau_{init2} \leftarrow$  system time;
      find( $\theta_p, \Delta N, l$ );               $\triangleright$  compute  $\theta_p$  and  $\Delta N$ 
      if ( $\max(\theta_R, \theta_F) \leq \theta_p \parallel \Delta N \leq 3$ ) then
        |  $\tau_{Redunence} \leftarrow 500ms$ ;
        | break; (exit while loop)
      else
        |  $\tau_{disc} \leftarrow (system\ time - \tau_{init2})$ ;
      end
      Activate RF transmission            $\triangleright$  VHO from VLC to RF  $\longleftarrow$ 
       $\tau_{Redunence} \leftarrow 0ms$ ;
       $\tau_{disc} \leftarrow 0ms$ ;
    end
  end
end
end

```

Either the disconnection occurrence is expected or immediate, a proper redundant period was set to avoid any hard-handover or switching fluctuations for the reversal switching from VLC to RF. As we propose the RF-VLC system for safety platooning application, we set a fixed value of disconnection timer $\tau_{disc} = 100ms$ before any handover decision is performed.

A disconnection period less than $100ms$ while the handover is relying on the VLC channel will set $\tau_{Redundant}$ timer to its maximum value avoiding the RF activation stage if the metric CBR was $\geq 60\%$, by exiting the waiting loop. Otherwise, a VHO from VLC to RF is enabling the RF-unicast stage to request immediate activation of RF channel despising the measured congestion level.

To summarize, the three primary conditions assisting the PVHO algorithm to either enable both technologies or one of them as depicted in the Figure 5.24. Despising the specified redundancy periods and switching timing in Algorithm 6, the RF-VLC system output is one of three statuses, (RF only), (VLC only), or (RF+VLC).

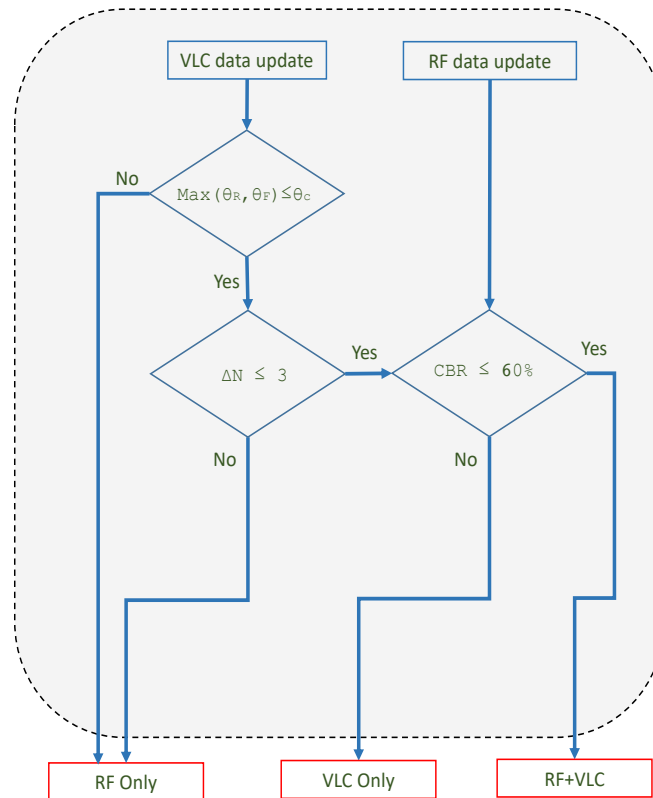

Figure 5.24: Flow diagrams explain the PVHO algorithm outputs.

5.4 Conclusion

In this chapter, we studied the handover between **VLC** and other technologies meant to ensure safety requirement and improve communication quality for a platooning of autonomous vehicles application. First of all, we proposed and studied **LRF-VLC** system supported by an application-level hand-over algorithm using both laser-based system and **VLC** to switch between **ACC** and **CACC** driving modes. Although **LRFs** and **VLC** technologies are independent of each other and provide a different type of information, the study showed that the trajectory shape and vehicles orientation has a direct influence on both technologies. Indeed, our results showed a perfect availability of cooperative platooning mode for low-curve scenarios with 100% of **PDR** for **VLC** and 100% of confidence for **LRF**.

However, the **LRF-VLC** system performance could drop over extreme curves ($\geq 90^\circ$) due to the **VLC** link discontinuity, combined with fluctuations in **LRF** confidence value. The main limitation found to be of the difficulty to correctly identify the preceding vehicle.

To overcome such limitation, the second part of this chapter tackled the prediction-based handover proposal recognizing **RF-VLC** system, in which we introduced a conventional handover mechanisms for **ITS** safety applications (technologies-based handover). Moreover, a platoon application related **PHY** metrics such as disconnection duration, message sequence number, and **VLC** link **FOV**, together with the radio channel **CBR** metric were proposed to predict the **VLC** disconnection occurrence and switching process.

The proposed prediction-based **PVHO** mechanism suggesting to use vehicular velocity to regulate a prediction critical angle that can safely allow proper redundancy period before the actual **VLC** link disconnection occurrence, where a soft-handover and communication continuity is guaranteed.

Moreover, the proposed **RF-VLC** system defers from the **LRF-VLC** system in the way that when **RF** technology is deployed, the primary goal will be to take off the load from **RF** channel by enabling **VLC** as long as possible. On the other hand, **LRFs** were used in a redundant mode to backup the **VLC** all over the application lifetime.

An integration of both **LRF-VLC** and **RF-VLC** systems into one single system for platooning application is part of this thesis future work, where we intend to propose and evaluate **LRF-RF-VLC** system providing three different backup substitutes to improve the platooning application safety further.

CHAPTER 6

Conclusion and future research perspective

Contents

6.1	Conclusion and remarks	145
6.2	Research perspective and future work	149

Résumé du chapitre

Ce chapitre conclut et résume les travaux de recherche présentés tout au long de cette thèse. Les principales contributions et sont présentées sous forme d'un chapitre conclusion. De plus, les limites des travaux présentés concernant l'utilisation de VLC pour les applications ITS sont également décrites suivant la perspective future de la recherche.

This chapter concludes and summarizes the research work presented throughout this thesis. The key contributions and findings are exhibited by drawing a chapters-based general conclusion. Moreover, limitations of the presented work regarding the use of VLC for ITS applications are also outlined followed by a scope for future research perspectives.

6.1 Conclusion and remarks

The thesis general scope was to tackle the vehicular communication and the safety requirements for ITS-convoy related applications. The latest studies on the performance of the standardized vehicular communication technologies raised significant challenges concerning the latency of safety application in the presence of high vehicular dense. Moreover, issues such as limited

bandwidth, coupled with unreliable wireless links and channel congestion urged toward the need for new communication mediums.

Therefore, the thesis core contribution was to propose the use of **VLC** as supportive communication technology working alongside the **RF** communication technology; for the platooning of autonomous vehicles, which intended to reduce the load from radio channel and ensure the safety requirements.

Moreover, these thesis contributions addressed the implementation and evaluation of a **VLC** platform suitable for **ITS** applications, where we used precise components to emulate the vehicular rare lighting system as a **VLC** transmitter. Moreover, we propose two different platoon driving systems using two handover mechanisms. The **RF-VLC** system which aims to benefit from the presence of two independent communication mediums, and the **LRF-VLC** system that profit from the vehicle sensors data to enable either **ACC** or **CACC** driving modes.

The feasibility and efficiency of the system implementation and hand-over algorithms were subjects to extensive investigations using computer simulators and test-bed that recognizes the safety requirements of convoy-based automated driving applications. Moreover, the carried out simulations followed-up by experimental results proved that the integration of **VLC** with the existed **RF** solutions, and laser-based sensors can lead to a definite benefit in the communication channel quality and safety requirements of a platooning system.

The main contributions that have been accomplished in the course of this thesis work are described in the following:

VLC channel modeling

At the outset, a complete **VLC** analytical channel model was investigated, where the main parameters that have significant impacts on the performances of an outdoor **VLC** system and applicable for platooning application were defined. The variations of these parameters such as incidence angle, receiver bandwidth, and daytime noise were examined and compared for different inter-vehicle distances. The investigated channel model was suggesting to employ the vehicles commercial rear lights as a reliable communication link between platoon members.

a **SIMULINK**-based model with longitudinal and lateral controllers were implemented for individual vehicles of platoon formation and examined using two curved trajectories scenarios to point out the misalignment problem and the system **FOV** limitation. Moreover, we propose a tracking alike solution

for the vehicular **VLC**-based platooning system, where we tackled the issue of a **VLC**-based autonomous platoon going through sharp curvatures and intersection areas.

The simulation of the analytical channel model in Chapter 3 showed that a **BER** of 10^{-6} which is equivalent to **SNR** around 14.6 dB is achievable for **IVC** distance up to 7 meters. Moreover, the simulation results regarding the proposed taking alike mechanism proved that our proposed method to enhance the **FOV** limitation was able to efficiently compensate the trajectories influence on both incidence and irradiance angles. A smooth and real-time compensation response was observed in our simulation outputs; resulted in a remarkable reduction of the optical channel path loss between any two members of the platoon.

VLC system prototyping and evaluation

After analytically proving the feasibility to use **VLC** for platooning application, we further proceeded with the prototyping and implementation of an actual **VLC** system as described in Chapter 4. Throughout this contribution, we explained the process and components details of the system implementation considering the application safety requirements. Moreover, we constructed a proper packet format utilizing less controlling bits and allowing the system to exchange the vehicular status, such as (ID's, speed, steering, and position).

To ensure the light source dual functionality and at the same time having light emission continuity, we used a Manchester line coding combined with the conventional **OOK** modulation technique. The prototype of both transmitter and receiver components were chosen carefully to provide the maximum resilience against the ambient noise sources. The main advantages of the performed implementation were the cost-efficiency and simplicity.

An experimental evaluation of the implemented prototype was carried out with an especial attention on the **VLC** link resilience to ambient noise and communication range. Compared to the 7 meters of **IVC** obtained analytically, experimental results showed that the implemented **VLC** system using proper optical filtering stage could have up to 30 meters of **IVC**, with less than 36 ms of latency for normal daytime conditions. Through the conducted experiment, we observed that a use of proper optical filtering stage at the receiver side, together with narrowing the transmitter **FOV**, result in an extended communication range, and make the **VLC** system more resilient to the ambient noises.

The experimental evaluation conducted several tests meant to measure the received optical power, packets delivery ratio, link latency, and throughput performances for different daytime conditions. The implemented prototype showed an excellent communication performances regarding both PDR and delay. Furthermore, we confirmed a substantial agreement between the theoretical VLC path-loss model tackled in Chapter 3 and the empirical measurements, where the estimated path-loss exponent n found to be ≈ 2 .

Handover proposals

Finally, in Chapter 5, we discussed the proposal of enabling handover between VLC, RF communication, and sensor-based systems for further platooning safety enhancement. First of all, we considered LRF-VLC system supported by a simple hand-over algorithm using both laser-based system and VLC to switch between ACC and CACC driving modes. The evaluation of the proposed system is verified using the implemented VLC prototype and Pro-SiVIC Simulator environment that was used to drive a platoon of two autonomous vehicles over different curvature scenarios.

Although LRFs and VLC technologies are independent of each other and provide a different type of information, the study showed that the trajectory shape and vehicles orientation has a direct influence on both technologies. Indeed, the acquired results showed a perfect availability of cooperative platooning mode for low-curve scenarios with 100% of PDR for VLC and 100% of confidence for LRF. Moreover, the system evaluation showed that the performance could drop dramatically when driving the platoon over extreme curves ($\geq 90^\circ$) due to the VLC link discontinuity, combined with fluctuations in LRF confidence value; where the main limitation found to be of the difficulty to correctly identify the preceding vehicle.

To overcome such limitation, we proposed the prediction-based handover mechanism recognizing RF-VLC system, in which we introduced a conventional handover mechanisms for ITS safety applications. The platoon application related PHY metrics such as disconnection duration, message sequence number, and VLC link FOV, together with the RF-CBR metric were proposed to predict the VLC disconnection occurrence.

The proposed prediction-based PVHO mechanism suggest the use of vehicular velocity to dynamically regulate a prediction critical angle that can safely allow proper redundancy period before the actual VLC link disconnection occurrence, where a soft-handover and communication continuity are meant to be guaranteed.

The difference between these two proposed systems is that when **RF-VLC** is enabled; the primary goal will be to take off the load from **RF** channel by enabling **VLC** for **IVC** as long as possible, while the **RF** is disabled in high channel congestion scenarios. On the other hand, for the **LRF-VLC** system, the vehicle's sensors were used in a redundant mode to backup the **VLC** all over the application lifetime, where a switching between the **ACC** and **CACC** modes was evaluated.

6.2 Research perspective and future work

Since one of the primary goals of this thesis work was defined to evaluate the **VLC** system feasibility for an **ITS** application, and since the main bottleneck of the current system is due to the processing speed, cost-efficiency, but not the capability of physical **VLC** channel itself. Few technical implementation-related problems were left open. The implemented **VLC** prototype can be further improved by using an **AGC** stage and automatic receiver sensitivity calibration. Such addition, can improve the system performance and avoid the insufficient manual calibration.

Moreover, the usage of Arduino micro-controller represents a viable and cost-effective solution for the implemented system encoding stage. For further hardware requirements, the encoding stage of both **VLC** transmission and reception units can substitute the Arduino micro-controller with a higher processing capability equipment such as **FPGAs** or **BBBs** which will provide more advanced digital signal processing, higher modulation, and better data rate speeds.

The optical channel scintillation effects were not considered yet in our **VLC** link modeling and prototyping. Further analytical and evaluation might be required to evaluate the system performance with the presence of different weather conditions, such as fog, rain, and snow. Using frequency and spatial diversity schemes are also expected to improve the **VLC** communication link performance by enabling the **MAC** layer and allowing the **VLC** networking.

For distributed systems such as **VANET**, the proposed handover algorithm in Chapter 5 opens an interesting research problems related to the standardized **RF** technology for **ITS** application. So far, the proposed **PVHO** handover algorithm define the switch status from **RF** channel to **VLC** channel based on the availability of **VLC** technology. The algorithm might be expanded to include a calculation of more **RF** channel related metrics. By adding new metric to sense the **RF** channel performance can allow better integration of both **LRF-VLC** and **RF-VLC** systems into one single system contributing

to further safety and comfort improvement of the convey-based application. Moreover, an evaluation of **LRF-RF-VLC** system providing three different substitutes option is a necessary as future perspective work.

Moreover, the research extension toward further investigation of the vehicular system security improvement by adopting optical-based (directional-based) communication solutions is also one of the interesting future research perspectives.

Bibliography

- [1] “Why 802.11p beats LTE and 5g for V2x,” Apr. 2016. [Online]. Available: <http://www.automotive-eetimes.com/design-center/why-80211p-beats-lte-and-5g-v2x>
- [2] Z. Ghassemlooy, W. Popoola, and S. Rajbhandari, *Optical Wireless Communications: System and Channel Modelling with MATLAB®*, 1st ed. CRC Press, Aug. 2012.
- [3] “Global status report on road safety 2015.” [Online]. Available: about:reader?url=http%3A%2F%2Fwww.who.int%2Fviolence_injury_prevention%2Froad_safety_status%2F2015%2Fen%2F
- [4] “Traffic Congestion Costs Billions in Wasted Fuel, Time, Report Says.” [Online]. Available: <http://www.ttnews.com/articles/basetemplate.aspx?storyid=29007>
- [5] P. Papadimitratos, A. La Fortelle, K. Evensen, R. Brignolo, and S. Cosenza, “Vehicular communication systems: Enabling technologies, applications, and future outlook on intelligent transportation,” *Communications Magazine, IEEE*, vol. 47, no. 11, pp. 84–95, November 2009.
- [6] K. Dar, M. Bakhouya, J. Gaber, M. Wack, and P. Lorenz, “Wireless communication technologies for ITS applications [topics in automotive networking],” *IEEE Communications Magazine*, vol. 48, no. 5, pp. 156–162, 2010.
- [7] K. Selvarajah, A. Tully, and P. Blythe, “ZigBee for intelligent transport system applications,” in *IET Road Transport Information and Control - RTIC 2008 and ITS United Kingdom Members’ Conference*, 2008, pp. 1–7.

- [8] Y. Chen and L. Chen, "Using bluetooth wireless technology in vehicles," in *IEEE International Conference on Vehicular Electronics and Safety, 2005*, 2005, pp. 344–347.
- [9] "Visible light communication market." [Online]. Available: <http://www.marketsandmarkets.com/Market-Reports/visible-light-communication-market-946.html>
- [10] D. Jia, K. Lu, J. Wang, X. Zhang, and X. Shen, "A survey on platoon-based vehicular cyber-physical systems," *IEEE Communications Surveys Tutorials*, vol. 18, no. 1, pp. 263–284, Firstquarter 2016.
- [11] PreVENT., "IP-PreVENT, "IP D15: Final Report," Preventive and Active Safety Applications Integrated Project, May 2008," <http://www.vlcc.net/>, 2008.
- [12] "Ieee standard for wireless access in vehicular environments (wave)–multi-channel operation," *IEEE Std 1609.4-2010 (Revision of IEEE Std 1609.4-2006)*, pp. 1–89, Feb 2011.
- [13] "Ieee std. 802.11-2012 part11: Wireless. lan medium access control (mac) and physical layer (phy) specifications." March 2012.
- [14] M. Alam, J. Ferreira, and J. Fonseca, *Intelligent Transportation Systems: Dependable Vehicular Communications for Improved Road Safety*. Springer, Jan. 2016.
- [15] G. Araniti, C. Campolo, M. Condoluci, A. Iera, and A. Molinaro, "Lte for vehicular networking: a survey," *IEEE Communications Magazine*, vol. 51, no. 5, pp. 148–157, May 2013.
- [16] "Vehicle Safety Communications Project, Final Report, DOT HS 810 591, April 2006. - Open Access Library." [Online]. Available: <http://www.jourlib.org/references/7767901>
- [17] F. Ahmed-Zaid, F. Bai, S. Bai, C. Basnayake, B. Bellur, S. Brovold, G. Brown, L. Caminiti, D. Cunningham, H. Elzein, K. Hong, J. Ivan, D. Jiang, J. Kenney, H. Krishnan, J. Lovell, M. Maile, D. Masselink, E. McGlohon, P. Mudalige, Z. Popovic, V. Rai, J. Stinnett, L. Tellis, K. Tirey, and S. VanSickle, "Vehicle Safety Communications – Applications (VSC-A) Final Report: Appendix Volume 2 Communications and Positioning," Sep. 2011. [Online]. Available: <https://trid.trb.org/view.aspx?id=1136548>
- [18] "ITS International - US IntelliDrive cooperative infrastructure programme." [Online]. Avail-

- able: <http://www.itsinternational.com/sections/nafta/features/us-intellidrive-cooperative-infrastructure-programme/>
- [19] “CityMobil - Towards advanced road transport for the urban environment.” [Online]. Available: <http://www.citymobil-project.eu/>
- [20] “CityMobil2 - Cities demonstrating automated road passenger transport.” [Online]. Available: <http://www.citymobil2.eu/en/>
- [21] “Automobile.” [Online]. Available: <http://www.pre-drive-c2x.eu/>
- [22] “AIT Austrian Institute Of Technology - COOPERS - CO-OPERative Systems for Intelligent Road Safety.” [Online]. Available: <http://www.ait.ac.at/research-services/research-services-digital-safety-security/verification-and-validation/reference-projects/projects-completed/coopers-co-operative-systems-for-intelligent-road-safety/?L=1>
- [23] “Safespot.” [Online]. Available: <http://www.safespot-eu.org/>
- [24] “GeoNet » RITS.” [Online]. Available: <https://team.inria.fr/rits/projet/geonet/>
- [25] “iTETRIS Platform.” [Online]. Available: <http://www.ict-itetris.eu/>
- [26] “Sicheres Einkaufen im Internet.” [Online]. Available: <http://www.intersafe-2.eu/>
- [27] “DRIVE C2x successfully completed in July 2014 - DRIVE C2x.” [Online]. Available: http://www.drive-c2x.eu/news-item/items/DRIVE_C2X_successfully_completed_in_July_2014
- [28] “COMeSafety.” [Online]. Available: <http://www.ecomove-project.eu/links/comesafety/>
- [29] “Car 2 Car - Communication Consortium: Mission & Objectives.” [Online]. Available: <https://www.car-2-car.org/index.php?id=5>
- [30] L. Guvenc, I. M. C. Uygan, K. Kahraman, R. Karaahmetoglu, I. Altay, M. Senturk, M. T. Emirler, A. E. H. Karci, B. A. Guvenc, E. Altug, M. C. Turan, O. S. Tas, E. Bozkurt, U. Ozguner, K. Redmill, A. Kurt, and B. Efendioglu, “Cooperative adaptive cruise control implementation of team mekar at the grand cooperative driving challenge,” *IEEE Transactions on Intelligent Transportation Systems*, vol. 13, no. 3, pp. 1062–1074, Sept 2012.
- [31] E. Uhlemann, “Introducing connected vehicles [connected vehicles],” *IEEE Vehicular Technology Magazine*, vol. 10, no. 1, pp. 23–31, March

2015.

- [32] L. Xu, L. Y. Wang, G. Yin, and H. Zhang, “Communication information structures and contents for enhanced safety of highway vehicle platoons,” *IEEE Transactions on Vehicular Technology*, vol. 63, no. 9, pp. 4206–4220, Nov 2014.
- [33] P. Varaiya, “Smart cars on smart roads: problems of control,” *Automatic Control, IEEE Transactions on*, vol. 38, no. 2, pp. 195–207, Feb 1993.
- [34] “Vehicle Dynamics and Control | Rajesh Rajamani | Springer,” 2006.
- [35] P. Fernandes and U. Nunes, “Platooning of autonomous vehicles with intervehicle communications in sumo traffic simulator,” in *Intelligent Transportation Systems (ITSC), 2010 13th International IEEE Conference on*, Sept 2010, pp. 1313–1318.
- [36] “TR 102 638 - V1.1.1 - Intelligent Transport Systems (ITS); Vehicular Communications; Basic Set of Applications; Definitions - etsi_tr\102600_102699\102638\01.01.01_60\tr_102638v010101p.pdf.” [Online]. Available: http://www.etsi.org/deliver/etsi_tr%5C102600_102699%5C102638%5C01.01.01_60%5Ctr_102638v010101p.pdf
- [37] “PRE-DRIVE Final Report - PRE-DRIVE C2x Deliverable D0.3 Final report_20100929.pdf.” [Online]. Available: http://www.drive-c2x.eu/tl_files/publications/PRE-DRIVE%20C2X%20Deliverable%20D0.3%20Final%20report_20100929.pdf
- [38] “ - SP_d1 2 1_vehicle_probe_usecase_v1.6.doc - D1.2.1_vehicle_probe_use_case-and_test_scenarios.pdf.” [Online]. Available: http://www.safespot-eu.org/documents/D1.2.1_Vehicle_probe_use_case-and_test_scenarios.pdf
- [39] G. Karagiannis, O. Altintas, E. Ekici, G. Heijenk, B. Jarupan, K. Lin, and T. Weil, “Vehicular networking: A survey and tutorial on requirements, architectures, challenges, standards and solutions,” *IEEE Communications Surveys Tutorials*, vol. 13, no. 4, pp. 584–616, Fourth 2011.
- [40] A. Vinel, “3gpp lte versus ieee 802.11p/wave: Which technology is able to support cooperative vehicular safety applications?” *IEEE Wireless Communications Letters*, vol. 1, no. 2, pp. 125–128, April 2012.
- [41] T. Ghosh and S. Mitra, “Congestion control by dynamic sharing of bandwidth among vehicles in vanet,” in *2012 12th International Con-*

-
- ference on Intelligent Systems Design and Applications (ISDA)*, Nov 2012, pp. 291–296.
- [42] L. Zhou and Z. J. Haas, “Securing ad hoc networks,” *IEEE Network*, vol. 13, no. 6, pp. 24–30, Nov 1999.
- [43] J. P. Hubaux, S. Capkun, and J. Luo, “The security and privacy of smart vehicles,” *IEEE Security Privacy*, vol. 2, no. 3, pp. 49–55, May 2004.
- [44] K. Sjoberg, E. Uhlemann, and E. G. Strom, “How severe is the hidden terminal problem in vanets when using csma and stdma?” in *Vehicular Technology Conference (VTC Fall), 2011 IEEE*, Sept 2011, pp. 1–5.
- [45] Y. Tanaka, S. Haruyama, and M. Nakagawa, “Wireless optical transmissions with white colored led for wireless home links,” in *Personal, Indoor and Mobile Radio Communications, 2000. PIMRC 2000. The 11th IEEE International Symposium on*, vol. 2, 2000, pp. 1325–1329 vol.2.
- [46] V. L. C. Consortium, “<http://www.vlcc.net/>.”
- [47] “[JEITA]Japan Electronics and Information Technology Industries Association / Home.” [Online]. Available: <http://www.jeita.or.jp/english/>
- [48] A. Belle, M. Falcitelli, M. Petracca, and P. Pagano, “Development of IEEE802.15.7 based ITS services using low cost embedded systems,” in *2013 13th International Conference on ITS Telecommunications (ITST)*, Nov. 2013, pp. 419–425.
- [49] X. Long, J. He, J. Zhou, L. Fang, X. Zhou, F. Ren, and T. Xu, “A review on light-emitting diode based automotive headlamps,” *Renewable and Sustainable Energy Reviews*, vol. 41, no. C, pp. 29–41, 2015. [Online]. Available: <https://ideas.repec.org/a/eee/rensus/v41y2015icp29-41.html>
- [50] R. Roberts, P. Gopalakrishnan, and S. Rathi, “Visible light positioning: Automotive use case,” in *Vehicular Networking Conference (VNC), 2010 IEEE*, Dec 2010, pp. 309–314.
- [51] A. M. Cailean, B. Cagneau, L. Chassagne, S. Topsu, Y. Alayli, and M. Dimian, “Visible light communications cooperative architecture for the intelligent transportation system,” in *2013 IEEE 20th Symposium on Communications and Vehicular Technology in the Benelux (SCVT)*, Nov 2013, pp. 1–5.

- [52] G. Pang, T. Kwan, C.-H. Chan, and H. Liu, "Led traffic light as a communications device," in *Intelligent Transportation Systems, 1999. Proceedings. 1999 IEEE/IEEJ/JSAI International Conference on*, 1999, pp. 788–793.
- [53] M. Akanegawa, Y. Tanaka, and M. Nakagawa, "Basic study on traffic information system using LED traffic lights," *IEEE Transactions on Intelligent Transportation Systems*, vol. 2, no. 4, pp. 197–203, 2001.
- [54] " "Wireless Medium Access Control (MAC) and Physical Layer (PHY) specifications, IEEE 802.15.7-2011 draft8 standard." "
- [55] "IEEE standard for local and metropolitan area Networks–Part 15.7: Short-range wireless optical communication using visible light," pp. 1–309, 2011.
- [56] H. Sugiyama, S. Haruyama, and M. Nakagawa, "Brightness control methods for illumination and visible-light communication systems," in *Wireless and Mobile Communications, 2007. ICWMC '07. Third International Conference on*, March 2007, pp. 78–78.
- [57] G. Ntogari, T. Kamalakis, J. Walewski, and T. Sphicopoulos, "Combining illumination dimming based on pulse-width modulation with visible-light communications based on discrete multitone," *IEEE/OSA Journal of Optical Communications and Networking*, vol. 3, no. 1, pp. 56–65, January 2011.
- [58] C. N. Georghiades, "Modulation and coding for throughput-efficient optical systems," *IEEE Transactions on Information Theory*, vol. 40, no. 5, pp. 1313–1326, Sep 1994.
- [59] D.-S. Shiu and J. M. Kahn, "Differential pulse position modulation for power-efficient wireless infrared communication," in *Global Telecommunications Conference, 1998. GLOBECOM 1998. The Bridge to Global Integration. IEEE*, vol. 1, 1998, pp. 219–224 vol.1.
- [60] T. Ohtsuki, "Rate adaptive transmission scheme using punctured convolutional codes in a fixed channel reuse strategy with ppm cdma," in *Global Telecommunications Conference, 1998. GLOBECOM 1998. The Bridge to Global Integration. IEEE*, vol. 1, 1998, pp. 207–212 vol.1.
- [61] "Introduction to Solid-State Lighting: Arturas zukauskas, Michael S. Shur, Remis Gaska: 9780471215745: Amazon.com: Books." [Online]. Available: <https://www.amazon.com/Introduction-Solid-State-Lighting-Art-ukauskas/dp/0471215740>

-
- [62] “CIE - INTERNATIONAL COMMISSION ON ILLUMINATION.” [Online]. Available: <http://www.cie.co.at/>
- [63] G. Pang, K.-L. Ho, T. Kwan, and E. Yang, “Visible light communication for audio systems,” *IEEE Transactions on Consumer Electronics*, vol. 45, no. 4, pp. 1112–1118, Nov. 1999.
- [64] T. Komine and M. Nakagawa, “Fundamental analysis for visible-light communication system using LED lights,” vol. 50, no. 1, pp. 100 – 107, Feb. 2004.
- [65] OMEGA., “Home Gigabit Access - Project Flyer 2nd Ed,” <http://www.ict-omega.eu>, 2011, [Project web page].
- [66] D-Light., “D-Light (data-light) Project,” <http://www.see.ed.ac.uk/research/IDCOM/d-light/>, 2011, [Project web page].
- [67] N.-T. Le and Y. M. Jang, “Broadcasting mac protocol for ieee 802.15.7 visible light communication,” in *2013 Fifth International Conference on Ubiquitous and Future Networks (ICUFN)*, July 2013, pp. 667–671.
- [68] “Optical Wireless Communications: System and Channel Modelling with MATLAB - MATLAB & Simulink Based Books - MathWorks United Kingdom.” [Online]. Available: <http://uk.mathworks.com/support/books/book73596.html?category=2>
- [69] “CIMO_guide-7th_edition-2008.pdf.” [Online]. Available: https://www.wmo.int/pages/prog/gcos/documents/gruanmanuals/CIMO/CIMO_Guide-7th_Edition-2008.pdf
- [70] M. Grabner and V. Kvicera, “Case study of fog attenuation on 830 nm and 1550 nm free-space optical links,” in *Proceedings of the Fourth European Conference on Antennas and Propagation*, April 2010, pp. 1–4.
- [71] “OSA | Bandwidth specification for adaptive optics systems*.” [Online]. Available: <https://www.osapublishing.org/josa/abstract.cfm?uri=josa-67-3-390>
- [72] “Mathematical model for the irradiance probability density function of a laser beam propagating through turbulent media | Optical Engineering | SPIE.” [Online]. Available: <http://opticalengineering.spiedigitallibrary.org/article.aspx?articleid=1098315>
- [73] S. Rajbhandari, Z. Ghassemlooy, J. Perez, H. L. Minh, M. Ijaz, E. Leitgeb, G. Kandus, and V. Kvicera, “On the study of the fso link perform-

- ance under controlled turbulence and fog atmospheric conditions,” in *Telecommunications (ConTEL), Proceedings of the 2011 11th International Conference on*, June 2011, pp. 223–226.
- [74] M. Grabner and V. Kvicera, “On the relation between atmospheric visibility and optical wave attenuation,” in *2007 16th IST Mobile and Wireless Communications Summit*, July 2007, pp. 1–5.
- [75] “Application of wavelets and artificial neural network for indoor optical wireless communication systems - Northumbria Research Link.” [Online]. Available: <http://nrl.northumbria.ac.uk/1933/>
- [76] F. Nadeem, V. Kvicera, M. S. Awan, E. Leitgeb, S. S. Muhammad, and G. Kandus, “Weather effects on hybrid fso/rf communication link,” *IEEE Journal on Selected Areas in Communications*, vol. 27, no. 9, pp. 1687–1697, December 2009.
- [77] “Application of wavelets and artificial neural network for indoor optical wireless communication systems - Northumbria Research Link.” [Online]. Available: <http://nrl.northumbria.ac.uk/1933/>
- [78] CALM., “Communications in Cooperative Intelligent Transport Systems - CALM for C-ITS: Introduction to Communications Access for Land Mobiles.” <http://calm.its-standards.eu/>, 2011.
- [79] Visible light communication for advanced driver assistant systems. [Online]. Available: <http://www.docstoc.com/docs/31467481/Visible-Light-Communication-for-Advanced-Driver-Assistant-Systems>
- [80] C. B. Liu, B. Sadeghi, and E. W. Knightly, “Enabling vehicular visible light communication (V2LC) networks,” in *Proceedings of the Eighth ACM international workshop on Vehicular inter-networking*, ser. VANET '11. New York, NY, USA: ACM, 2011, p. 41–50. [Online]. Available: <http://doi.acm.org/10.1145/2030698.2030705>
- [81] A. Cailean, B. Cagneau, L. Chassagne, S. Topsu, Y. Alayli, and J.-M. Blosseville, “Visible light communications: Application to cooperation between vehicles and road infrastructures,” in *2012 IEEE Intelligent Vehicles Symposium (IV)*, 2012, pp. 1055–1059.
- [82] I. Lee, M. Sim, and F. Kung, “Performance enhancement of outdoor visible-light communication system using selective combining receiver,” *IET Optoelectronics*, vol. 3, no. 1, pp. 30–39, Feb. 2009.
- [83] S. Okada, T. Yendo, T. Yamazato, T. Fujii, M. Tanimoto, and Y. Kimura, “On-vehicle receiver for distant visible light road-to-vehicle

- communication,” in *2009 IEEE Intelligent Vehicles Symposium*, 2009, pp. 1033–1038.
- [84] M. Abualhoul, M. Marouf, O. Shagdar, and F. Nashashibi, “Platooning control using visible light communications: A feasibility study,” in *2013 16th International IEEE Conference on Intelligent Transportation Systems - (ITSC)*, Oct. 2013, pp. 1535–1540.
- [85] M. Y. Abualhoul, M. Marouf, O. Shag, and F. Nashashibi, “Enhancing the field of view limitation of visible light communication-based platoon,” in *Wireless Vehicular Communications (WiVeC), 2014 IEEE 6th International Symposium on*, Sept 2014, pp. 1–5.
- [86] M. Abualhoul, O. Shagdar, and F. Nashashibi, “Visible Light Inter-Vehicle Communication for Platooning of Autonomous Vehicles,” in *2016 IEEE Intelligent Vehicles Symposium IV2016*, Gothenburg, Sweden, Jun. 2016. [Online]. Available: <https://hal.inria.fr/hal-01308430>
- [87] B. Turan, S. Ucar, S. C. Ergen, and O. Ozkasap, “Dual channel visible light communications for enhanced vehicular connectivity,” in *Vehicular Networking Conference (VNC), 2015 IEEE*, Dec 2015, pp. 84–87.
- [88] F. Che, L. Wu, B. Hussain, X. Li, and C. P. Yue, “A fully integrated ieee 802.15.7 visible light communication transmitter with on-chip 8-w 85 x0025; efficiency boost led driver,” *Journal of Lightwave Technology*, vol. 34, no. 10, pp. 2419–2430, May 2016.
- [89] W. Feng and X. Chen, “Led visible light communication system based on fpga,” in *2015 IEEE Advanced Information Technology, Electronic and Automation Control Conference (IAEAC)*, Dec 2015, pp. 428–432.
- [90] A. Pradana, N. Ahmadi, and T. Adionos, “Design and implementation of visible light communication system using pulse width modulation,” in *Electrical Engineering and Informatics (ICEEI), 2015 International Conference on*, Aug 2015, pp. 25–30.
- [91] M. B. Rahaim, A. M. Vegni, and T. D. C. Little, “A hybrid radio frequency and broadcast visible light communication system,” in *2011 IEEE GLOBECOM Workshops (GC Wkshps)*, Dec 2011, pp. 792–796.
- [92] A. M. Vegni and T. D. C. Little, “Handover in vlc systems with co-operating mobile devices,” in *Computing, Networking and Communications (ICNC), 2012 International Conference on*, Jan 2012, pp. 126–130.

- [93] H. Chowdhury and M. Katz, "Data download on move in indoor hybrid (radio-optical) wlan-vlc hotspot coverages," in *Vehicular Technology Conference (VTC Spring), 2013 IEEE 77th*, June 2013, pp. 1–5.
- [94] J. Hou and D. C. O'Brien, "Vertical handover-decision-making algorithm using fuzzy logic for the integrated radio-and-ow system," *IEEE Transactions on Wireless Communications*, vol. 5, no. 1, pp. 176–185, Jan 2006.
- [95] S. Liang, H. Tian, B. Fan, and R. Bai, "A novel vertical handover algorithm in a hybrid visible light communication and lte system," in *Vehicular Technology Conference (VTC Fall), 2015 IEEE 82nd*, Sept 2015, pp. 1–5.
- [96] A. Kesting, "Microscopic Modeling of Human and Automated Driving: Towards Traffic-Adaptive Cruise Control," May 2007. [Online]. Available: http://www.qucosa.de/recherche/frontdoor/?tx_slubopus4frontend%5bid%5d=urn:nbn:de:bsz:14-ds-1204804167720-57734
- [97] P. Fernandes and U. Nunes, "Platooning of autonomous vehicles with intervehicle communications in sumo traffic simulator," in *Intelligent Transportation Systems (ITSC), 2010 13th International IEEE Conference on*, 2010, pp. 1313–1318.
- [98] K. Mori, O. Shagdar, S. Matsuura, M. Tsukada, T. Ernst, and K. Fujikawa, "Experimental Study on Channel Congestion using IEEE 802.11p Communication System," IPSJ Technical Workshop on Mobile Computing and Ubiquitous Communications, Tokyo, Japon, Mar. 2013. [Online]. Available: <http://hal.inria.fr/hal-00799218>
- [99] R. Reinders, M. van Eenennaam, G. Karagiannis, and G. Heijenk, "Contention window analysis for beaconing in vanets," in *2011 7th International Wireless Communications and Mobile Computing Conference*, July 2011, pp. 1481–1487.
- [100] A. Serageldin, H. Alturkostani, and A. Krings, "On the reliability of dsrc safety applications: A case of jamming," in *2013 International Conference on Connected Vehicles and Expo (ICCVE)*, Dec 2013, pp. 501–506.
- [101] K. Bilstrup, E. Uhlemann, E. Strom, and U. Bilstrup, "Evaluation of the ieee 802.11p mac method for vehicle-to-vehicle communication," in *Vehicular Technology Conference, 2008. VTC 2008-Fall. IEEE 68th*, Sept 2008, pp. 1–5.

-
- [102] S. Eichler, "Performance evaluation of the IEEE 802.11p WAVE communication standard," in *Vehicular Technology Conference, 2007. VTC-2007 Fall. 2007 IEEE 66th*, 2007, pp. 2199–2203.
- [103] "A Comparison of Spacing and Headway Control Laws for Automatically Controlled Vehicles1: Vehicle System Dynamics: Vol 23, No 1." [Online]. Available: <http://www.tandfonline.com/doi/abs/10.1080/00423119408969077>
- [104] "Vehicle Dynamics and Control | Rajesh Rajamani | Springer." [Online]. Available: <http://www.springer.com/us/book/9781461414322>
- [105] G. Bansal, J. Kenney, and C. Rohrs, "Limeric: A linear adaptive message rate algorithm for dsrc congestion control," *Vehicular Technology, IEEE Transactions on*, vol. 62, no. 9, pp. 4182–4197, Nov 2013.
- [106] Q. Chen, D. Jiang, and L. Delgrossi, "Ieee 1609.4 dsrc multi-channel operations and its implications on vehicle safety communications," in *Vehicular Networking Conference (VNC), 2009 IEEE*, Oct 2009, pp. 1–8.
- [107] Y. Wang, A. Ahmed, B. Krishnamachari, and K. Psounis, "Ieee 802.11p performance evaluation and protocol enhancement," in *Vehicular Electronics and Safety, 2008. ICVES 2008. IEEE International Conference on*, Sept 2008, pp. 317–322.
- [108] M. Torrent-Moreno, J. Mittag, P. Santi, and H. Hartenstein, "Vehicle-to-vehicle communication: Fair transmit power control for safety-critical information," *Vehicular Technology, IEEE Transactions on*, vol. 58, no. 7, pp. 3684–3703, Sept 2009.
- [109] W. Dunbar and D. Caveney, "Distributed receding horizon control of vehicle platoons: Stability and string stability," *Automatic Control, IEEE Transactions on*, vol. 57, no. 3, pp. 620–633, March 2012.
- [110] J. Kahn and J. Barry, "Wireless infrared communications," vol. 85, no. 2, pp. 265–298, Feb. 1997.
- [111] J. R. Barry, *Wireless Infrared Communications*. Springer, 1994.
- [112] "Avonec red 630nm-640nm 3w single led." [Online]. Available: https://avonec.de/images/3W_datasheets/630nm-640nm/3w_single_630nm-640nm.pdf
- [113] "Thorlabs, Inc. - Your Source for Fiber Optics, Laser Diodes, Optical Instrumentation and Polarization Measurement & Control." [Online].

Available: <http://www.thorlabs.de/index.cfm>

- [114] “Intempora,” <http://www.intempora.com>.
- [115] “mchr3k manchester library for arduino.” [Online]. Available: <http://mchr3k.github.io/>
- [116] S. Tsugawa, “Inter-vehicle communications and their applications to intelligent vehicles: an overview,” in *Intelligent Vehicle Symposium, 2002. IEEE*, vol. 2, June 2002, pp. 564–569 vol.2.
- [117] S. H. Hosseinnia, I. Tejado, V. Milanés, J. Villagr a, and B. M. Vinagre, “Experimental application of hybrid fractional-order adaptive cruise control at low speed,” *IEEE Transactions on Control Systems Technology*, vol. 22, no. 6, pp. 2329–2336, Nov 2014.
- [118] B. Schwarz, “LIDAR: Mapping the world in 3-D,” *Nature Photonics*, vol. 4, no. 7, 2010.
- [119] B. Douillard, J. Underwood, N. Kuntz, V. Vlaskine, A. Quadros, P. Morton, and A. Frenkel, “On the segmentation of 3D LIDAR point clouds,” in *2011 IEEE International Conference on Robotics and Automation*, 2011.
- [120] F. Nashashibi and A. Bargeton, “Laser-based vehicles tracking and classification using occlusion reasoning and confidence estimation,” in *IEEE Intelligent Vehicles Symposium*, no. September, 2008.
- [121] P. Fernandes and U. Nunes, “Platooning with dsrc-based ivc-enabled autonomous vehicles: Adding infrared communications for ivc reliability improvement,” in *Intelligent Vehicles Symposium (IV), 2012 IEEE*, 2012, pp. 517–522.
- [122] S. Oncu, J. Ploeg, N. van de Wouw, and H. Nijmeijer, “Cooperative adaptive cruise control: Network-aware analysis of string stability,” *Intelligent Transportation Systems, IEEE Transactions on*, vol. 15, no. 4, pp. 1527–1537, 2014.
- [123] V. Milanés, S. E. Shladover, J. Spring, C. Nowakowski, H. Kawazoe, and M. Nakamura, “Cooperative adaptive cruise control in real traffic situations,” *Intelligent Transportation Systems, IEEE Transactions on*, vol. 15, no. 1, pp. 296–305, 2014.
- [124] U. Department of Transportation, “Vehicle safety communications project task 3.” <http://www.ntis.gov/>.
- [125] P. Merdrignac, O. Shagdar, I. Ben Jemaa, and F. Nashashibi, “Study

-
- on Perception and Communication Systems for Safety of Vulnerable Road Users,” in *18th IEEE International Conference on Intelligent Transportation Systems (ITSC 2015)*, 2015.
- [126] S. Kulkarni, A. Darekar, and P. Joshi, “A survey on li-fi technology,” in *2016 International Conference on Wireless Communications, Signal Processing and Networking (WiSPNET)*, March 2016, pp. 1624–1625.
- [127] A. Autolitano, M. Reineri, R. M. Scopigno, C. Campolo, and A. Molinaro, “Understanding the channel busy ratio metrics for decentralized congestion control in vanets,” in *2014 International Conference on Connected Vehicles and Expo (ICCVE)*, Nov 2014, pp. 717–722.

Résumé

L'objectif de cette thèse CIFRE est de contribuer à la communication véhiculaire autonome et au développement de la mobilité urbaine. Les travaux sont basés sur les limitations et défis de la communication par radio pour les applications de sécurité et envisagent de déployer le système d'éclairage des véhicules en tant que solution de communication de soutien pour le platooning d'IVC-activées par VC Véhicules autonomes. L'objectif principal de cette recherche doctorale consiste à intégrer le système VLC dans l'architecture existante de C-ITS en développant un prototype VLC, ainsi que des algorithmes de transfert suffisants permettant VLC, RF et des solutions basées sur la perception afin d'assurer les exigences de sécurité maximales et l'échange continu d'informations entre les véhicules.

La faisabilité et l'efficacité de la mise en œuvre du système et des algorithmes de transfert ont fait l'objet de recherches approfondies sur six chapitres, destinés à faciliter une progression logique des matériaux et permettre un accès relativement facile. En plus de l'amélioration de la capacité routière en utilisant les systèmes de conduite autonome à la base de convoi. Les simulations réalisées ainsi que les résultats expérimentaux ont montré que l'intégration de VLC avec les solutions existantes RF a un avantage certain dans la qualité du canal de communication et les exigences de sécurité d'un système de platooning quand un algorithme appropriée est utilisé.

Une thèse est soumise en complément d'exigences pour le degré de Docteur en Philosophie (ENGINEERING SCIENCES) à l'Ecole Mine ParisTech.

Mots clés

VLC, Communication de lumière visible, Communication radio, IEEE 802.11p, IEEE 802.15.7, Conduite autonome, ITS applications, Communication véhiculaire, handover.

Abstract

This thesis effort contributes to the autonomous vehicular communication and urban mobility improvements. The work addresses the main radio-based V2V communication limitations and challenges for ITS hard-safety applications and intends to deploy the vehicular lighting system as a supportive communication solution for platooning of IVC-enabled autonomous vehicles. The ultimate objectives of this Ph.D. research are to integrate the VLC system within the existing C-ITS architecture by developing a VLC prototype, together with sufficient hand-over algorithms enabling VLC, RF, and perception-based solutions in order to ensure the maximum safety requirements and the continuous information exchange between vehicles. The feasibility and efficiency of the VLC-RF system implementation and hand-over algorithms were subjects to deep investigations over six self-contained chapters meant to facilitate a logical progression of materials and to enable a relatively easy access. In addition to the improvement in road capacity by utilizing the convoy-based autonomous driving systems. The carried out simulations followed-up by experimental results proved that the integration of VLC with the existed RF solutions lead to a definite benefit in the communication channel quality and safety requirements of a platooning system when a proper hand-over algorithm is utilized.

A dissertation submitted in partial fulfillment of the requirements for the degree of Doctor of Philosophy (ENGINEERING SCIENCES) at Mine ParisTech.

Keywords

VLC, Visible light communication, radio communication, RF, IEEE 802.11p, IEEE 802.15.7, platooning, autonomous driving, handover.