



HAL
open science

Croissance des degrés d'applications rationnelles en dimension 3

Nguyen-Bac Dang

► **To cite this version:**

Nguyen-Bac Dang. Croissance des degrés d'applications rationnelles en dimension 3. Géométrie algébrique [math.AG]. Université Paris Saclay (COmUE), 2018. Français. NNT : 2018SACLX044 . tel-01853243

HAL Id: tel-01853243

<https://pastel.hal.science/tel-01853243v1>

Submitted on 2 Aug 2018

HAL is a multi-disciplinary open access archive for the deposit and dissemination of scientific research documents, whether they are published or not. The documents may come from teaching and research institutions in France or abroad, or from public or private research centers.

L'archive ouverte pluridisciplinaire **HAL**, est destinée au dépôt et à la diffusion de documents scientifiques de niveau recherche, publiés ou non, émanant des établissements d'enseignement et de recherche français ou étrangers, des laboratoires publics ou privés.

Croissance des degrés d'applications rationnelles en dimension trois.

Thèse de doctorat de l'Université Paris-Saclay
préparée à l'École Polytechnique

Ecole doctorale n°574 École doctorale de mathématiques Hadamard (EDMH)
Spécialité de doctorat : Mathématiques fondamentales

Thèse présentée et soutenue à Palaiseau, le 19/07/2018, par

NGUYEN-BAC DANG

Rapporteurs :

Serge CANTAT
Directeur de Recherche, Université de Rennes I
Keiji OGUISO
Professeur, University of Tokyo

Composition du Jury :

Andreas BERNIG Professeur, Goethe Universität	Examineur
Serge CANTAT Directeur de Recherche, Université de Rennes I	Rapporteur
Yves DE CORNULIER Directeur de Recherche, Université Lyon I	Examineur
Charles FAVRE Directeur de Recherche, École Polytechnique	Directeur de thèse
Paul GAUDUCHON Directeur de Recherche émérite, École Polytechnique	Président du jury

Table des matières

Remerciements	v
Introduction	vii
1 Degrees of rational maps	1
1.1 Chow group	5
1.1.1 General facts	5
1.1.2 Intersection with Cartier divisors	7
1.1.3 Characteristic classes	7
1.2 Space of numerical cycles	9
1.2.1 Definitions	9
1.2.2 Algebra structure on the space of numerical cycles	11
1.2.3 Pullback on dual numerical classes	13
1.2.4 Canonical morphism	14
1.2.5 Numerical spaces are finite dimensional	16
1.3 Positivity	17
1.3.1 Pseudo-effective and numerically effective cones	17
1.3.2 Pliant classes	17
1.3.3 Basepoint free cone on normal projective varieties	18
1.3.4 Siu's inequality in arbitrary codimension	22
1.3.5 Norms on numerical classes	24
1.4 Relative numerical classes	26
1.4.1 Relative classes	26
1.4.2 Pullback and pushforward	28
1.4.3 Restriction to a general fiber and relative canonical morphism	29
1.5 Application to dynamics	31
1.5.1 Degrees of rational maps	31
1.5.2 Sub-multiplicativity	32
1.5.3 Norms of operators associated to rational maps	34
1.6 Semi-conjugation by dominant rational maps	36
1.7 Mixed degree formula	37
1.7.1 Positivity estimate of the diagonal	38
1.7.2 Submultiplicativity of mixed degrees	44
1.7.3 Proof of Theorem 4	45
1.8 Kähler case	47
1.9 Comparison with Fulton's approach	48
2 Positivity of convex valuations	51
2.0.1 Organization of the chapter	56
2.1 Preliminaries	56
2.1.1 Convex valuations	56

2.1.2	McMullen's grading decomposition	57
2.1.3	Alesker's irreducibility theorem	58
2.1.4	Convolution and product of smooth valuations	58
2.2	\mathcal{P} -Positive convex valuations	60
2.2.1	\mathcal{P} -Positivity of valuations	60
2.2.2	Reverse Khovanskii-Teissier inequality	63
2.2.3	Norms on the space of valuations	66
2.2.4	An extension of the convolution operator	72
2.3	A variant of Minkowski's existence theorem	74
2.3.1	Existence of the solutions	74
2.3.2	Compactness of the solution set	76
2.4	Dynamical degrees	78
2.4.1	Existence	78
2.4.2	Evaluation of dynamical degrees	83
2.4.3	A generalization : multiple dynamical degrees	87
2.5	Positivity of invariant convex valuations	88
2.5.1	Invariant classes in complex dynamics	88
2.5.2	Invariant convex valuations	89
3	Degree growth of tame automorphisms	97
3.1	Introduction	97
3.2	General facts on the tame group of the quadric	100
3.2.1	The geometry of a quadric threefold and its compactification in \mathbb{P}^4	100
3.2.2	The orthogonal group	101
3.2.3	Elementary transformations	102
3.3	The square complex associated to the tame group	108
3.3.1	Construction of the square complex	109
3.3.2	Stabilizer of vertices of type III	111
3.3.3	Stabilizers of vertices of type II	113
3.3.4	Bass-Serre tree associated to plane automorphisms	114
3.3.5	Link over a vertex of type I	115
3.3.6	2×2 squares centered along each vertices	118
3.4	Valuative estimates	122
3.4.1	Valuations on affine and projective varieties	122
3.4.2	Valuations \mathcal{V}_0 on the quadric	123
3.4.3	Valuations in \mathcal{V}_0 and the geometry at infinity	125
3.4.4	Parachute	129
3.4.5	Key polynomials	131
3.4.6	Parachute inequalities	133
3.5	Global geometry of the complex	136
3.5.1	Gromov curvature and Gromov-hyperbolicity	136
3.5.2	Application to the degree growths of elliptic automorphisms	138
3.5.3	Bands and regions	140
3.5.4	Function on the vertices of the complex and the graph \mathcal{C}' associated to a valuation	141
3.6	Degree estimates in the graph \mathcal{C}_ν	144
3.6.1	Choice of squares with non-critically resonant edges	144
3.6.2	Degree estimates at a ν -maximal vertex	146
3.6.3	Degree at a non-extremal vertex	151
3.6.4	Degree estimates on a band	153

3.6.5	Degree estimates at a ν -minimal vertex	156
3.6.6	Proof of Theorem 3.6.0.1	157
3.6.7	Proof of Theorem 9	161
3.6.8	Proof of Theorem 10	163
4	Perspectives	165
4.1	Degrés dynamiques des automorphismes modérés de la quadrique	165
4.2	Produits aléatoires d'automorphismes dans $\text{Tame}(\mathbb{Q})$	165
4.3	Croissance des degrés des automorphismes modérées de \mathbb{A}^3	166

Remerciements

Je tiens tout d'abord à remercier chaleureusement mon directeur de thèse Charles Favre. Sa relecture minutieuse et ses nombreux commentaires ont largement contribué à perfectionner l'exposé de cette thèse, à la fois sur la forme et sur le contenu mathématique. Les thèmes variés abordés lors de nombreuses discussions ont particulièrement enrichi ma compréhension des mathématiques et sa bienveillance à mon égard et à tous les doctorants du CMLS m'a beaucoup aidé pendant ces quatre années. Ses conseils, autant mathématiques que pratiques, ont été un grand atout face à la tâche que je devais accomplir.

Je suis reconnaissant envers Serge Cantat et Keiji Oguiso pour avoir accepté de rapporter cette thèse. Leurs regards extérieurs et commentaires sur mes travaux m'ont permis d'améliorer la qualité globale de ce manuscrit. Merci d'avoir pris le temps de relire autant en si peu de temps.

Je voudrais aussi exprimer ma gratitude envers Andreas Bernig, Serge Cantat, Yves de Cornulier et Paul Gauduchon pour avoir accepté de faire partie du jury de soutenance.

Une partie de cette thèse est le fruit d'un travail en commun avec Jian Xiao, qui a généreusement approuvé que je rajoute nos résultats dans le second chapitre de cette thèse. La partie principale de la thèse s'appuie sur des résultats de Stéphane Lamy, Jean-Philippe Furter et Cinzia Bisi. Stéphane et Jean-Philippe ont patiemment répondu à mes questions pas souvent très claires et m'ont aidé à éclaircir les subtilités de leur construction. Par ailleurs, de nombreux arguments sont venus ou m'ont été suggérés via des discussions avec Hsueh-Yung Lin, René Mboro, Fabrice Orgogozo, Mihai Fulger, Brian Lehmann, Sébastien Boucksom, Serge Cantat, Matteo Ruggiero, Junyi Xie, Alexandre Martin, Tuyen Truong, Andreas Bernig, Julie Déserti, Jean-Marie Maillard, Lorenzo Fantini.

Je suis redevable envers Marine Amier, Pascale Fuseau, Carole Juppín, Carole Khalil, David Delavennat, Danh Pham Kim, qui ont toujours été là pour atténuer le chaos administratif et informatique lié à ma présence au labo, et remercie les membres passés et présents du CMLS avec lequel j'ai pu discuter, François Golse, Daniel Han-Kwan, Jean Lannes, Benjamin Schraen, Yvan Martel, Pascale Harinck, Erwan Brugallé, Bertrand Rémy, David Renard, Stéphane Bijałowski, Alena Pirutka, Jean Lannes, Sébastien Boucksom, Juanyong Wang, Javier Fresan, Claude Sabbah, Ildar Gaisin, Valentin Hernandez, Yann Brenier, Cécile Huneau, Matthieu Leautaud, Thomas Kramer, mes collègues doctorants Jacek Jendrej, Benoit Loisel, Thomas Megarbane, Tatiana Zolotareva, Vinh Nguyen, Aymeric Baradat, Matthieu Kochersperger, Nicolas Martin, Ivan Moyano Garcia. Pour reprendre une formule due à Rita, merci à Antoine et Aurélien qui ont fait en sorte que le mercredi soit le meilleur jour de la semaine.

Pendant ces quatre années, j'ai eu l'opportunité de pouvoir interagir avec de nombreuses personnes, à travers les groupes de travaux et séminaires divers et variés. Merci à Sandrine, Lucas Kauffman, Viet Vu, William Gignac, Matteo Ruggiero mon demi-frère, mes frères et soeurs (mathématiques) Junyi Xie, Rita Rodriguez pour leur présence au séminaire Bourbaki où toutes les questions étaient permises mais aussi à Matteo pour organiser des soirées jeux de société, Sandrine pour faire des plaisanteries douteuses, Rita pour dénicher des soirées improbables, l'intégralité de la famille Fantini, merci à la communauté de dynamique, à Gabriel

Vigny pour animer chaque dîner de conférence, à Thomas Gautier pour lequel les références à Robert Rodriguez ne passent pas inaperçu, à Romain Dujardin pour ses très bons conseils en pâtisseries parisiennes haut de gamme, à mon cousin Sebastien Biebler pour m'avoir fait saisir le vocabulaire fruité de la dynamique holomorphe (i.e les blender), à mes collègues bretons (par adoption) Federico Lo Bianco, Christian Urech, à mes collègues toulousains, Anne Lanjou, Fabrizio Bianchi, et pour ne pas mettre la pression, merci à Eleonora d'accepter de faire un tiramisu et pour la concoction de spritz chargé en alcool pour le jury de la soutenance.

Je ne me serais pas engagé dans cette voie sans les innombrables conseils de lecture que Volodya Roubtsov m'avait prodigués lors de mon premier stage et qui ont ravivé ma passion pour les sciences, ni les explications de Frank Loray lors d'un second stage portant sur les subtilités du problème de Riemann-Hilbert ou les encouragements de Hussein Mourtada alors que nous étions en TD de topologie algébrique. J'ai par la suite particulièrement apprécié l'atmosphère du séminaire des singularités, dans lequel les membres étaient toujours prêts à partager leur maîtrise des valuations.

Mon retour à Paris pour effectuer cette thèse n'aurait pas été si agréable sans le soutien moral de ma famille et de mes amis. Les mets et plats fusion de Maman (sponsorisé par Saveurs Lointaines) ont certainement contribué à mon bien-être, particulièrement le fameux Pho de Hanoi revisité à sa manière et l'optimisme de Papa envers et contre tout continuera à me fasciner. Je tiens à remercier mon grand frère Viet, ma petite soeur Thi et mon cousin Vo-An pour tout ce que nous partageons depuis l'enfance, Tho et Vincent pour avoir organisé les meilleurs séjours en Bretagne et à Lyon respectivement, tonton Binh pour avoir accompagné Maman depuis leur tumultueux périple dans les îles malaysiennes et thaïlandaises, Dao et le petit Minh qui déborde d'énergie, mes proches éloignés, George et Laurence, Claire et Jean-Baptiste avec leurs deux petits parisiens Quentin et Lauriane, Laurent et Phuong Anh, Delphine et Richard ; le meilleur couple originaire de Dundee ; merci à Alice Tacaille pour m'avoir fait part de ses découvertes sur la musique occidentale du XVI-ième siècle qui m'ont littéralement fait sortir du monde dynamique.

Je souhaite aussi faire quelques dédicaces à mes amis : à Marine pour partager ses plans pâtisseries et pour venir exprès de Lyon pour cette soutenance, à John qui m'impressionnera toujours avec ses bricolages électroniques compliqués, à Victor que je vois à chaque fois entre deux stages de danse, aux grolleurs du mercredi soir Simon alias Gimli, Théo anciennement sosie de Neo, Léo notre futur grand pâtissier et Lucas devenu végétarien à son insu, les soul dogs accompagnés par Nico, Ali le George Benson de Marseille, Julio au saxo qui tue, Bruno et Dana, aux anciens carolingiens Pierre, Ali, Théo, Anthony et Isabelle qui, malgré la distance nous séparant, arrive à me faire partager les dessous de la scène musicale underground washingtonienne-new-yorkaise, au crew de Saint-Ouen : Valentine la hypeuse, Joel notre lockeur, Doriane, Joanna, Maud, Brune et enfin notre danseuse et prof préférée Colline, à Adrien, Ninon, Sélim et Léa pour m'avoir tant fait rigoler et tourner la tête depuis les hautes montées de la Croix-Rousse, à aussi ceux qui me traînent dans les bars le samedi soir : Pierre le receleur de Chartreuse, Hugo le nerveux, Antoine, Sandrine l'Amy Winehouse de la bande, Tarek et Coralie que je vois trop peu, Cerise et Don mes fournisseurs de pastis, Maxime, qui j'espère ne cessera jamais de faire des blagues peu conventionnelles, Marion pour m'avoir fait découvrir les nouveautés funk à chaque fois que je mets les pieds à Lyon.

Je terminerai avec une dernière pensée à Mamie Renée, qui n'a jamais renoncé à tenter de comprendre mon sujet de thèse.

Introduction

Cette thèse comporte trois chapitres indépendants portant sur l'itération des applications rationnelles sur des variétés projectives et plus spécifiquement sur l'étude du comportement de la suite des degrés des itérés de telles applications.

Dans le premier chapitre, nous prouvons l'existence d'invariants fondamentaux que sont les degrés dynamiques dans un cadre très général, et ce sans hypothèse ni sur la caractéristique du corps de base ni sur les singularités de l'espace ambiant. Cette preuve repose sur des propriétés de positivité des cycles algébriques, et propose une alternative aux approches analytiques de Dinh et Sibony [DS05b] ou algébriques de Truong [Tru16a].

Le second chapitre est issu d'un article écrit en commun avec Jian Xiao. Notre contribution porte sur des objets centraux en géométrie convexe appelés valuations. Nous transférons à l'espace des valuations des notions de positivité des cycles algébriques récemment introduites par Lehmann et Xiao [LX15a], ce qui nous permet d'étendre l'opération de convolution originellement définie par Bernig et Fu [BF06] à une sous-classe de valuations suffisamment positives.

Le troisième chapitre constitue le coeur de la thèse, et porte sur des estimations des degrés dynamiques des automorphismes dit modérés de la quadrique affine de dimension 3. Nos arguments sont de natures variées, et s'appuient sur l'action du groupe modéré sur un complexe carré CAT(0) et Gromov hyperbolique récemment introduite par Bisi, Furter et Lamy dans [BFL14].

Nous avons finalement collecté dans un dernier et court chapitre quelques pistes de recherche directement inspirées des travaux présentés ici.

◇

Fixons une variété projective normale X de dimension n définie sur un corps k algébriquement clos, et H un diviseur ample sur X . Étant donnée une application rationnelle dominante $f : X \dashrightarrow X$, il est crucial de pouvoir contrôler la croissance des nombres d'intersection $(V \cdot f^p(W))$ lorsque V et W sont des sous-variétés algébriques de X et que $p \rightarrow \infty$. Par exemple dans le cas où $k = \mathbb{C}$ et W est de dimension $n - i$, le nombre $H^{n-i} \cdot f^p(W)$ s'interprète comme le volume de $f^p(W)$ par la formule de Wirtinger. Les travaux de Gromov [Gro87], puis de Dinh et Sibony [DS05b] ont alors montré que la croissance asymptotique des volumes des variétés bornaient l'entropie topologique de f .

Revenons au cas d'un corps k algébriquement clos quelconque, et notons π_1 et π_2 les projections du graphe de f dans $X \times X$ sur chacun de ses facteurs. Pour tout $i \leq n$, le i -ième degré de f , noté $\deg_{i,H}(f)$, est un entier donné par la formule

$$\deg_{i,H}(f) = (\pi_1^* H^{n-i} \cdot \pi_2^* H^i) .$$

Il a été remarqué par Russakovski et Schiffman [RS97] que la suite $(\deg_{i,H}(f^p))_{p \in \mathbb{N}}$ était sous-multiplicative dans le cas des applications rationnelles des espaces projectifs. Ce résultat a ensuite été généralisé par Dinh et Sibony [DS05b] au cas de toutes les applications rationnelles définies sur le corps des complexes. Notre premier théorème étend cela en caractéristique quelconque.

Théorème 1. *Soient X une variété projective normale de dimension n et H un diviseur ample sur X . Les assertions suivantes sont vérifiées.*

(i) *Il existe une constante $C > 0$ telle que pour tout entier $i \leq n$ et pour toutes applications rationnelles dominantes $f, g : X \dashrightarrow X$, on ait :*

$$\deg_{i,H}(f \circ g) \leq C \deg_{i,H}(f) \deg_{i,H}(g).$$

(ii) *Considérons $g : Y \dashrightarrow X$ une application birationnelle entre variétés projectives normales et H' un diviseur ample sur Y . Alors il existe une constante $C > 0$ telle que pour toute application rationnelle dominante $f : X \dashrightarrow X$, on ait pour tout $i \leq n$:*

$$\frac{1}{C} \deg_{i,H}(f) \leq \deg_{i,H'}(g^{-1} \circ f \circ g) \leq C \deg_{i,H}(f).$$

On déduit du lemme de Fekete et du théorème ci-dessus l'existence de la limite

$$\lambda_i(f) := \lim_{p \rightarrow \infty} \deg_{i,H}(f^p)$$

et le fait que cette limite ne dépende ni du choix du diviseur ample, ni de la classe de conjugaison birationnelle de f . Ce taux de croissance $\lambda_i(f)$ est appelé i -ième degré dynamique de f .

Dans le cas d'une application régulière d'une variété complexe lisse dans elle-même, Dinh [Din05] a montré que $\lambda_i(f)$ était égal au rayon spectral de l'action de f sur l'espace de cohomologie de De Rham $H^{2i}(X, \mathbb{R})$. L'énoncé qui suit constitue une généralisation de ce fait dans le cadre du théorème précédent.

Dans un cadre purement algébrique, il est naturel de travailler avec les groupes de Chow $A_i(X)$ des cycles de dimension i , et les groupes de Chow opérationnels $A^i(X)$ des cycles de codimension i définis par Fulton [Ful98]. Une application rationnelle dominante $f : X \dashrightarrow X$ induit naturellement un morphisme de $A^i(X)$ vers $A_{n-i}(X)$. Cependant, ces groupes de Chow ne sont en général pas finiment engendrés, et il est plus commode de travailler avec des \mathbb{R} -espaces vectoriels pour lesquels on peut espérer analyser les propriétés spectrales d'opérateurs induits par f . On considère donc plutôt les groupes de cycles de dimension i à équivalence numérique près dont il existe deux avatars $N^{n-i}(X)$ et $N_i(X)$. Ce sont des \mathbb{R} -espaces vectoriels de dimension finie obtenus comme quotients des groupes de Chow $A^{n-i}(X)$ et $A_i(X)$ respectivement. On obtient de plus un morphisme naturel $f^* : N^i(X) \rightarrow N_{n-i}(X)$ dont la norme est reliée aux degrés via le résultat suivant :

Théorème 2. *Soit X une variété projective normale et H un diviseur ample sur X . Il existe une constante $C > 0$ telle que pour tout $i \leq n$ et pour toute application rationnelle dominante $f : X \dashrightarrow X$, on ait :*

$$\frac{1}{C} \leq \frac{\|f^* : N^i(X) \rightarrow N_{n-i}(X)\|}{\deg_{i,H}(f)} \leq C,$$

où $\|f^* : N^i(X) \rightarrow N_{n-i}(X)\|$ désigne la norme d'opérateur du morphisme induit $f^* : N^i(X) \rightarrow N_{n-i}(X)$.

En particulier, le théorème 2 implique que le degré dynamique se calcule par la formule :

$$\lambda_i(f) = \lim_{p \rightarrow +\infty} \|(f^p)^* : N^i(X) \rightarrow N_{n-i}(X)\|^{1/p}.$$

Nous allons maintenant indiquer brièvement les méthodes pour démontrer le Théorème 1.

Sur le corps des complexes, on se ramène tout d'abord au cas où X est lisse par le théorème de désingularisation d'Hironaka. Dinh et Sibony utilisent ensuite des arguments de nature

purement analytiques. Le point clef est un résultat d'approximation des courants positifs fermés de bidegré quelconque par des différences de courants positifs lisses de masse contrôlée.

Sur un corps de caractéristique quelconque, ces deux outils ne sont pas disponibles. Truong ([Tru16a]) parvient cependant à se ramener au cas lisse en s'appuyant sur l'existence d'altérations dûe à De Jong. Cette étape le force à quitter le monde des applications rationnelles et à définir les degrés pour des correspondances assez générales. L'approximation des courants est dans son approche remplacée par le Chow's moving lemma. Ses arguments portent tous dans le groupe de Chow de la variété ambiante.

Notre preuve n'utilise pas le théorème de De Jong, et nous travaillons directement sur la variété X singulière. Nous nous appuyons sur la généralisation des inégalités dites de Morse holomorphes transcendentes dues à Xiao [Xia15a], et Popovici [Pop16a] qui nous permettent de comparer deux classes d'intersections complètes. Étant donné un diviseur α nef et un diviseur β big nef sur X , rappelons que l'on note $\alpha^i \leq \beta^i$ si pour tout $\epsilon > 0$, le cycle $\beta^i - \alpha^i + \epsilon H^i$ est rationnellement équivalent à un cycle effectif. L'inégalité de Siu implique pour des classes de diviseurs que :

$$\alpha \leq n \frac{(\alpha \cdot \beta^{n-1})}{(\beta^n)} \beta.$$

Notre remarque cruciale est qu'en appliquant successivement l'inégalité précédente, on aboutit à :

$$\alpha^i \leq (n - i + 1)^i \frac{(\alpha^i \cdot \beta^{n-i})}{(\beta^n)} \beta^i. \quad (1)$$

Cette inégalité est plus faible que celle obtenue par Xiao et Popovici dans le cas complexe mais elle reste valide sur un corps de caractéristique quelconque. Montrons de quelle manière on peut exploiter l'inégalité (1) pour montrer le théorème dans le cas où $f, g : X \rightarrow X$ sont des morphismes réguliers surjectifs. On observe que $\alpha = f^* g^* H$ et $\beta = f^* H$ sont tous deux des diviseurs big nef, et en intersectant l'inégalité (1) avec H^{n-i} , on obtient la sous-multiplicativité des degrés souhaitée. La preuve dans le cas général adopte la même stratégie que dans le cas régulier si ce n'est que l'on doit faire les calculs d'intersection sur un modèle birationnel de X adéquat.

Notons que les inégalités (1) ci-dessus comportent des analogues en géométrie convexe donnés par Xiao et Lehmann ([LX17]). Ces analogues vont jouer un rôle important dans le second chapitre de cette thèse que nous présentons maintenant.

◇

Le travail effectué en commun avec Jian Xiao porte sur divers aspects de géométrie convexe de l'espace euclidien \mathbb{R}^n . Rappelons qu'une valuation ϕ est une fonction à valeurs réelles définie sur l'ensemble des corps convexes $\mathcal{K}(\mathbb{R}^n)$, qui est continue pour la distance de Gromov-Hausdorff et telle que pour tous corps convexes $K, L \in \mathcal{K}(\mathbb{R}^n)$ satisfaisant $K \cup L \in \mathcal{K}(\mathbb{R}^n)$, on ait

$$\phi(K \cup L) = \phi(K) + \phi(L) - \phi(K \cap L).$$

Nous nous restreindrons de plus aux valuations invariantes par translation vérifiant $\phi(K + t) = \phi(K)$ pour tout corps convexe $K \in \mathcal{K}(\mathbb{R}^n)$ et tout $t \in \mathbb{R}^n$. Les principaux exemples de telles valuations sont obtenues à partir des volumes mixtes $K \mapsto V(K[i], L_i, \dots, L_{n-i})$ où L_i, \dots, L_{n-i} sont des corps convexes fixés.

Les travaux de Bernig et Fu [BF06] mettent en évidence une structure d'algèbre graduée commutative sur un sous-espace de l'espace $\text{Val}(\mathbb{R}^n)$ de toutes valuations. Rappelons qu'un théorème de McMullen montre que $\text{Val}(\mathbb{R}^n)$ se décompose en somme directe

$$\text{Val}(\mathbb{R}^n) = \bigoplus \text{Val}_i(\mathbb{R}^n),$$

où les valuations $\phi \in \text{Val}_i(\mathbb{R}^n)$ sont homogène de degré i , i.e. pour tout $K \in \mathcal{K}(\mathbb{R}^n)$ et tout $\lambda > 0$, on a $\phi(\lambda K) = \lambda^i \phi(K)$.

En utilisant des techniques d'analyse subtils, Bernig et Fu ont défini une opération de convolution sur le sous-espace (dense pour une topologie adéquate) des valuations dites lisses. Lorsque $K_1, \dots, K_l, K'_1, \dots, K'_m$ sont des corps convexes à bord lisses et strictement convexes, les valuations $V(K_1, \dots, K_l, \cdot[n-l])$, $V(K'_1, \dots, K'_m, \cdot[n-m])$ sont lisses et leur convolution peut être définie par :

$$V(K_1, \dots, K_l, \cdot[n-l]) * V(K'_1, \dots, K'_m, \cdot[n-m]) = V(K'_1, \dots, K_l, K'_1, \dots, K'_m, \cdot[n-m-l]).$$

Le cœur de l'approche de Bernig et Fu est de montrer que cette opération s'étend continûment à l'espace de toutes les valuations lisses.

Alesker et Bernig [AB17] ont ensuite étendu cette opération de convolution à des classes de valuations non nécessairement lisses en utilisant la théorie géométrique de la mesure. Cependant leur approche ne permet pas de définir la convolée de volumes mixtes de polytopes en toute généralité.

Notre approche de la convolution repose sur le sous-espace \mathcal{V}' suivant de $\text{Val}(\mathbb{R}^n)$. Notons Δ le simplexe standard dans \mathbb{R}^n . Une valuation ϕ est dans \mathcal{V}' s'il existe un entier i et une mesure μ de Radon signée sur $\mathcal{K}(E)^{n-i}$ telle que

$$\int_{L_1, \dots, L_{n-i}} V(\Delta[i], L_1, \dots, L_{n-i}) d|\mu|(L_1, \dots, L_{n-i}) < \infty,$$

où $|\mu|$ désigne la valeur absolue de la mesure μ et

$$\phi(K) = \int_{L_1, \dots, L_{n-i}} V(K[i], L_1, \dots, L_{n-i}) d\mu(L_1, \dots, L_{n-i})$$

pour tout corps convexe K dans \mathbb{R}^n . On montre que le sous-espace des valuations lisses de \mathcal{V}' est strictement inclus dans \mathcal{V}' , mais reste dense dans $\text{Val}(\mathbb{R}^n)$.

Rappelons que toute valuation peut être polarisée de la manière suivante :

$$\phi(K_1, \dots, K_i) = \frac{1}{i!} \left(\frac{\partial^i}{\partial t_1 \partial t_2 \dots \partial t_i} \right) \Big|_{t_1=\dots=t_i=0^+} \phi(t_1 K_1 + \dots + t_i K_i),$$

où K_1, \dots, K_i sont des corps convexes.

Théorème 3. *Il existe un unique opérateur bilinéaire symétrique $*$: $\mathcal{V}' \times \mathcal{V}' \rightarrow \mathcal{V}'$ compatible avec la convolution sur l'espace des valuations lisses, et qui soit borné pour la norme*

$$\|\phi\|_{\mathcal{P}} = \inf\{\epsilon \geq 0, |\phi(K_1, \dots, K_i)| < \epsilon V(\Delta[n-i], K_1, \dots, K_i) \text{ pour tout } K_1, \dots, K_i \in \mathcal{K}(\mathbb{R}^n)\}.$$

La convolution induit sur \mathcal{V}' une structure d'algèbre commutative normée graduée admettant un élément neutre.

Notre opérateur de convolution se déduit assez simplement de la convolution sur l'espace des mesures. Le point clef est de montrer que l'opérateur ainsi obtenu est borné. Pour cela, nous utilisons de manière intensive les estimées suivantes dûes à Xiao et Lehmann, qui sont des analogues convexes de (1).

Théorème 4 (Xiao-Lehmann). *Si $K_1, \dots, K_i, L, K'_1, \dots, K'_{n-i}$ sont des corps convexes et L est d'intérieur non vide, alors l'inégalité suivante est satisfaite :*

$$V(K_1, \dots, K_i, K'_1, \dots, K'_{n-i}) \leq \binom{n}{i} \frac{V(L[n-i], K_1, \dots, K_i)}{\text{vol}(L)} V(L[i], K'_1, \dots, K'_{n-i}).$$

En guise d'application du Théorème 3, nous retrouvons ainsi une formule due à Lin [Lin12] et Favre-Wulcan [FW12] reliant le i -ième degré dynamique d'une application monomiale avec les propriétés spectrales de son application linéaire induite.

Rappelons que si $g \in \mathrm{GL}_n(\mathbb{R})$ et ϕ est une valuation sur \mathbb{R}^n , alors $g \cdot \phi$ est la valuation $\phi \circ g^{-1}$. Notons \mathcal{V}'_i le sous-espace des valuations homogènes de degré i dans \mathcal{V}' .

Théorème 5. *Considérons une application linéaire $g \in \mathrm{GL}_n(\mathbb{R})$. Alors l'égalité suivante est vérifiée :*

$$\|g: \mathcal{V}'_{n-i} \rightarrow \mathcal{V}'_{n-i}\| = \lim_{p \rightarrow +\infty} \|g^p \cdot V(\Delta[i], \cdot [n-i])\|^{1/p} = \frac{1}{|\det(g)|} \rho_1 \cdot \rho_2 \cdot \dots \cdot \rho_i,$$

où les ρ_i sont les valeurs absolues des valeurs propres de g ordonnées par ordre décroissant.

Considérons f une application monomiale, c'est-à-dire que f est de la forme :

$$(x_1, \dots, x_n) \rightarrow (x_1^{a_{11}} \dots x_n^{a_{1n}}, \dots, x_1^{a_{n1}} \dots x_n^{a_{nn}}),$$

où $g = (a_{ij})$ est une matrice inversible $n \times n$ à coefficients entiers. On peut montrer que le i -ième degré de f se déduit d'un calcul de volume mixte

$$\deg_i(f) = V(g(\Delta)[i], \Delta[n-i]).$$

Par conséquent, le i -ième degré dynamique de f se déduit du théorème précédent et nous obtenons l'égalité $\lambda_i(f) = \|g: \mathcal{V}'_{n-i} \rightarrow \mathcal{V}'_{n-i}\|$, ce qui nous donne un analogue du Théorème 2.

◇

La détermination de la suite $\deg_i(f^p)$ des degrés des itérés d'une application rationnelle d'un espace projectif donnée est un problème extraordinairement difficile. Dans le cas le plus simple des applications monomiales, le degré des itérés se calcule en termes de volumes mixtes et on ne peut obtenir de formules simples pour $\deg_i(f^p)$ en fonction des coefficients de la matrice déterminant l'application même lorsque $i = 1$, voir [HS95]. Des calculs assistés par ordinateur ont été réalisés en particulier par Abarenkova, Anglès d'Auriac, Boukraa, Maillard [AdMV06, AAdB⁺99, AAdBM99] pour $i = 1$, mais ceux-ci ne portent que sur un petit nombre d'itérés (généralement $p \leq 15$) du fait de la croissance exponentielle des degrés. Par conséquent, nous nous restreindrons uniquement à la détermination de l'asymptotique de la suite $(\deg_i(f^p))$ et au taux de croissance exponentiel $\lambda_i(f)$ de celle-ci.

De nombreux travaux portent sur la croissance de ces suites pour les applications rationnelles de surfaces : citons par exemple les travaux de Friedland et Milnor [FM89] dans le cas des automorphismes du plan affine ; de Diller et Favre [DF01] et de Blanc et Cantat [BC16] pour les applications birationnelles ; et de Favre et Jonsson pour les applications polynomiales du plan affine [FJ11]. Boucksom, Favre et Jonsson [BFJ08a] ont de plus montré que $\deg_1(f^p) \simeq c \lambda_1(f)^p$ pour un $c > 0$ dès que $\lambda_1 > \lambda_2^2$.

À partir de la dimension trois, les méthodes employées dans le cas des surfaces s'avèrent inopérantes. De fait très peu de résultats ont été établis, et nous ne disposons de résultats généraux que pour des classes d'applications rationnelles préservant des structures géométriques très fortes. Les degrés et la croissance sont connus pour les applications régulières, dans le cas monomial, et pour les applications birationnelles sur des variétés hyperkähleriennes ([Bia16]). En dimension trois, le cas particulier des pseudo-automorphismes et des automorphismes a fait l'objet de nombreux travaux [Tru16b, OT14, Tru17, OT15]. Pour les automorphismes et les

endomorphismes, la connaissance de la suite des degrés permet de retrouver des informations de nature dynamique et géométriques [Zha09, Zha10, CWZ14, CO15, Les15].

Nous allons traiter ici d'une classe assez large d'exemples : les automorphismes dits modérés de la quadrique affine de dimension 3.

Fixons (x, y, z, t) des coordonnées affines dans \mathbb{A}^4 et notons \mathcal{Q} la quadrique affine de \mathbb{A}^4 d'équation $xt - yz = 1$. Nous nous intéressons au sous-groupe dit modéré $\text{Tame}(\mathcal{Q})$ engendré par les applications de la forme $(x, y, z, t) \rightarrow (x, y, z + xP(x, y), t + yP(x, y))$ et par les applications linéaires préservant cette quadrique. Notons que la fermeture de Zariski de \mathcal{Q} dans \mathbb{P}^4 est une variété rationnelles lisse, et que l'on obtient donc une inclusion naturelle du sous-groupe $\text{Tame}(\mathcal{Q})$ dans $\text{Bir}(\mathbb{P}^3)$.

Le théorème principal du dernier chapitre s'énonce comme suit.

Théorème 6. *Soit f un automorphisme modéré. Alors l'une des conditions suivantes est vérifiée.*

(i) *La suite $(\deg(f^n), \deg(f^{-n}))$ est bornée. De plus soit f est conjuguée à une application linéaire ; soit f^2 est conjuguée à un automorphisme de la forme*

$$(x, y, z, t) \mapsto (ax, by + xR(x), b^{-1}z + xP(x, y), a^{-1}(t + yP(x, y) + zR(x) + xR(x)P(x, y)))$$

avec $a, b \in \mathbb{k}^$, $P \in \mathbb{k}[x, y]$ et $R \in \mathbb{k}[x]$.*

(ii) *Il existe une constante $C > 0$ telle que pour tout $n \in \mathbb{N}^*$ et pour tout $\epsilon \in \{+1, -1\}$:*

$$\frac{1}{C}n \leq \deg(f^{\epsilon n}) \leq Cn,$$

et f est conjuguée à un automorphisme de la forme :

$$(x, y, z, t) \mapsto (ax, b^{-1}(z + xR(x)), b(y + xP(x)z), a^{-1}(t + z^2P(x) + yR(x))),$$

avec $a, b \in \mathbb{k}^$, $R \in \mathbb{k}[x]$ et $P \in \mathbb{k}[x] \setminus \mathbb{k}$.*

(iii) *Il existe une constante $C > 0$ (qui dépend de f) telle que :*

$$\min(\deg(f^{-n}), \deg(f^n)) \geq C \left(\frac{4}{3}\right)^n.$$

Bien que ce résultat ne permette pas de déterminer l'asymptotique de la suite $\deg_1(f^n)$, il répond cependant à deux questions naturelles posées par Urech [Ure16, Question 2, Question 4] dans le cas des applications dans $\text{Tame}(\mathcal{Q})$. Notons de plus que nous obtenons l'inclusion $\{\lambda(f), f \in \text{Tame}(\mathcal{Q})\} \subset \{1\} \cup [4/3, +\infty[$.

Pour démontrer ce théorème, nous allons exploiter des arguments de théorie géométrique des groupes (l'action de $\text{Tame}(\mathcal{Q})$ sur un complexe carré \mathcal{C} adéquat) ainsi que des estimées fines des valeurs de valuations spéciales sur les dérivées partielles de fonctions régulières sur \mathcal{Q} (appelées inégalités de type parachute). Expliquons les principales étapes de la preuve de ce théorème.

Rappelons tout d'abord la construction du complexe \mathcal{C} dû à Bisi-Furter-Lamy [BFL14]. Celui-ci est un complexe polyédral de dimension deux dont les cellules de dimension maximale sont des carrés et dont les sommets sont de trois types différents (en d'autres termes il existe un marquage sur les sommets par $\{I, II, III\}$). Notons O_4 le sous-groupe des applications linéaires préservant \mathcal{Q} . On définit alors

— les sommets de type I comme les sous-ensembles de $k[\mathcal{Q}]$ donnés par

$$[f_1] := \{af_1 \mid a \in k^*\},$$

où $f = (f_1, f_2, f_3, f_4)$ est un automorphisme modéré;

— les sommets de type II comme les sous-ensembles de $k[\mathcal{Q}]^2$ donnés par

$$[f_1, f_2] := \left\{ (af_1 + bf_2, cf_1 + df_2) \mid \begin{pmatrix} a & b \\ c & d \end{pmatrix} \in \mathrm{GL}_2(k) \right\}$$

où $f = (f_1, f_2, f_3, f_4)$ est un automorphisme modéré;

— et enfin les sommets de type III comme les sous-ensembles de $k[\mathcal{Q}]^4$ donnés par :

$$[f] := \{u \circ f \in k[\mathcal{Q}]^4 \mid u \in O_4\},$$

où $f = (f_1, f_2, f_3, f_4)$ est un automorphisme modéré.

Une arête relie un sommet v de type I à un sommet v' de type II ssi il existe un automorphisme modéré $f = (f_1, f_2, f_3, f_4)$ tel que $v = [f_1]$ et $v' = [f_1, f_2]$. De la même manière, on relie un sommet v de type II à v' de type III ssi il existe un automorphisme modéré $f = (f_1, f_2, f_3, f_4)$ tel que $v = [f_1, f_2]$ et $v' = [f]$.

Enfin deux sommets v_1 et v_2 de type II, un sommet v_3 de type III et un sommet v_4 de type I forment un carré ssi on peut trouver un automorphisme modéré f tel que $v_1 = [f_1, f_2]$, $v_2 = [f_1, f_3]$, $v_3 = [f]$ et $v_4 = [f_1]$.

On munit chaque carré de la métrique euclidienne de telle sorte que chaque arête soit de longueur 1, et on définit une distance naturelle sur \mathcal{C} en considérant des chaînes de carrés reliant deux points donnés. Dans la suite, nous appellerons 2×2 carrés tout assemblage de 4 carrés dont l'union est isométrique à $[0, 2]^2$ et est centrée en un sommet de type III.

Le groupe $\mathrm{Tame}(\mathcal{Q})$ agit naturellement sur \mathcal{C} par isométries de la façon suivante :

$$g \cdot [f_1] = [f_1 \circ g^{-1}], g \cdot [f_1, f_2] := [f_1 \circ g^{-1}, f_2 \circ g^{-1}] \text{ et } g \circ [f] = [f \circ g^{-1}],$$

où $f = (f_1, f_2, f_3, f_4) \in \mathrm{Tame}(\mathcal{Q})$. Notons que cette action est transitive sur les sommets de type fixé et libre.

Bisi, Furter, et Lamy ont décrit en détail la structure du complexe \mathcal{C} et montré que celui-ci était à la fois $\mathrm{CAT}(0)$ et Gromov-hyperbolique. La structure des isométries des espaces hyperboliques est bien comprise, voir [BH99]. On conclut qu'un automorphisme modéré f soit fixe un sommet du complexe (on dit alors qu'il est elliptique), soit agit par translation non-triviale sur une géodésique de \mathcal{C} (et on dit qu'il est hyperbolique).

Nous traitons le cas des automorphismes elliptiques à la Section 3.5.2 en exploitant la description explicite des stabilisateurs des points du complexe donnée par Bisi-Furter-Lamy. On tombe soit dans les cas (1) et (2) du Théorème soit sur des applications qui préservent toutes des fibrations, et qui sont conjuguées à des automorphismes de la forme

$$(x, y, z, t) \mapsto (x, f_2, f_3, f_4),$$

avec $f_2, f_3, f_4 \in k[\mathcal{Q}]$.

Le cœur de notre analyse concerne les automorphismes hyperboliques. Soit $f \in \mathrm{Tame}(\mathcal{Q})$, un tel automorphisme. On va démontrer qu'il existe une constante $C > 0$ telle que

$$\deg(f^p) \geq C(4/3)^{pd}, \tag{2}$$

où d est la distance de translation sur une géodésique invariante par f .

Pour ce faire, soit γ une demi-géodésique invariante par l'action de f . Quitte à conjuguer par un élément du groupe modéré, on peut toujours supposer que γ passe dans le carré contenant $[\text{Id}]$ et $[x]$. Observons que la géométrie d'une géodésique invariante générale admet une combinatoire compliquée car elle peut successivement toucher des points de types différents. Afin de simplifier nos explications, nous supposons que γ est une demi-géodésique partant de $[t]$ passant par $[\text{Id}]$ et $[x]$, et passant alternativement par des sommets de type I et III.

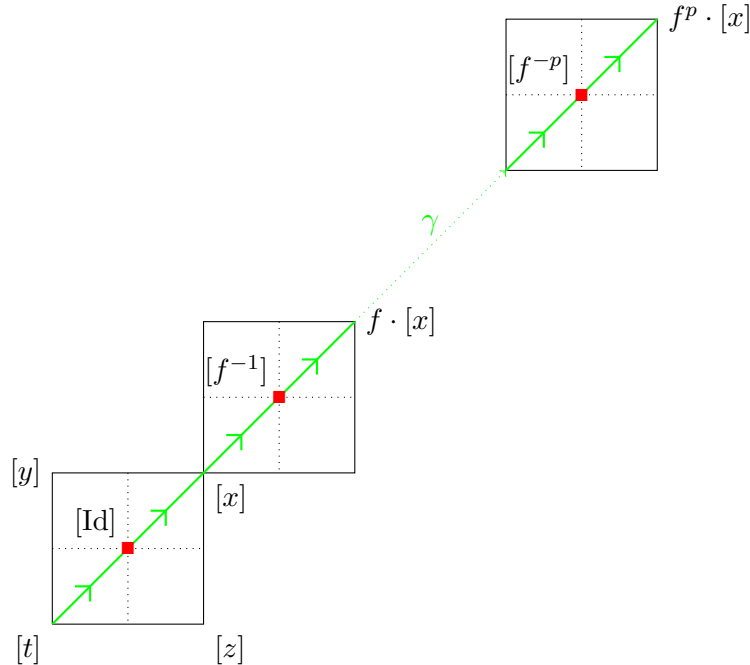

La preuve consiste alors à estimer le degré des points de type I contenus dans γ . Plus précisément, on montre par récurrence qu'entre deux sommets de type I consécutifs, le quotient des degrés est au moins $4/3$. Dans toute la suite, on fixe donc un automorphisme $f \in \text{Tame}(\mathcal{Q})$ de telle sorte que l'image du carré S_0 de taille 2×2 dont les sommets sont les coordonnées x, y, z et t est un carré S telle que $S_0 \cap S = [x]$ comme sur la figure ci-contre.

Notons tout d'abord que la fonction $-\text{deg}$ définit une valuation sur $k[\mathcal{Q}]$ déterminée par ses valeurs (égales) sur les coordonnées x, y, z et t (on dit qu'elle est monomiale). Afin de pouvoir mettre en place notre récurrence nous aurons besoin de dissymétriser les rôles de ces quatre coordonnées. Pour ce faire nous choisissons une valuation monomiale ν telle que

$$\nu(t) > \max\{\nu(z), \nu(y)\} \geq \min\{\nu(z), \nu(y)\} > \nu(x),$$

et nous cherchons à estimer $\nu(x \circ f^{-p})$ pour tout entier p . Le théorème en découlera en prenant une suite de valuations monomiales convergeant vers $-\text{deg}$.

Pour montrer $\nu(f \cdot [x]) < (4/3)\nu(x)$, on exploite la géométrie locale au voisinage du link de $[x]$ dans \mathcal{C} (voir §3.3.5) pour construire une suite de carrés $S_0, \dots, S_p = S$ tels que $[x] \in S_i$, $e_i = S_i \cap S_{i+1}$ est un arête contenant $[x]$, et $e_i \cap e_{i+1} = [x]$ pour tout i . Lorsque trois carrés consécutifs S_i ne sont pas contenus dans un grand carré de taille 4×4 nous dirons que la suite forme un escalier en colimaçon autour de $[x]$.

En guise d'exemple, notons g_1, g_2, g_3, g_4 les automorphismes élémentaires donnés par :

$$\begin{aligned} g_1 &= (x, y, z - xP_1(x, y), t - yP_1(x, y)), \\ g_2 &= (x, y - xP_2(x, z), z, t - zP_2(x, z)), \\ g_3 &= (x, y, z - xP_3(x, y), t - yP_3(x, y)), \end{aligned}$$

où $P_1, P_2, P_3 \in k[x, y] \setminus k[x]$. Considérons un automorphisme f de la forme :

$$f = g_1 \circ g_2 \circ g_3 \circ (t, z, y, x).$$

Alors l'escalier en colimaçon autour $[x]$ est composé de quatre carrés représentés dans la figure suivante.

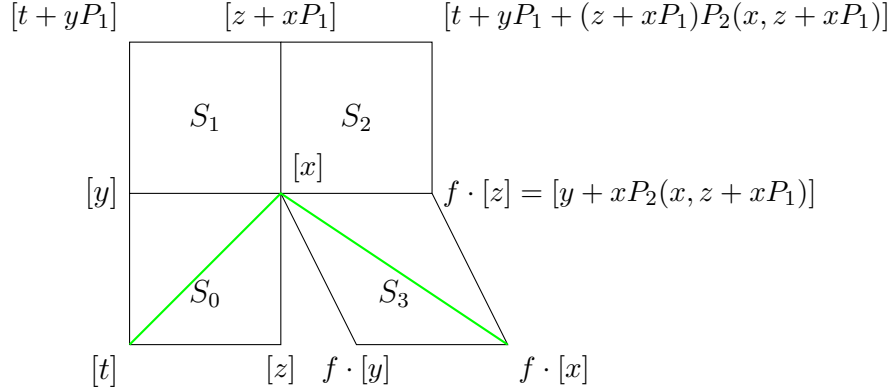

Pour simplifier l'argumentation, nous munissons chaque arête reliant deux sommets de type I d'une orientation dès que la valeur de ν est différente sur ces sommets. On indiquera une flèche allant de $[v_1]$ à $[v_2]$ lorsque $\nu([v_1]) > \nu([v_2])$. Notons que le choix de la valuation ν induit une orientation sur le carré de départ S_0 , voir la figure ci-dessous.

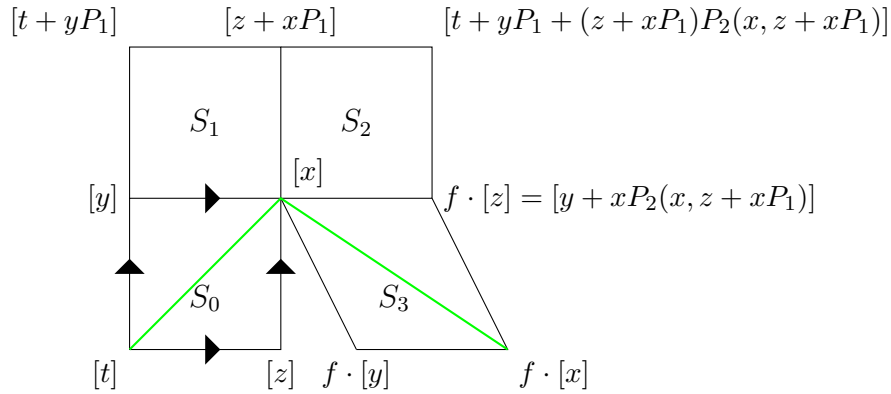

Des arguments élémentaires nous permettent dans un premier temps de traiter le cas des sommets du carré S_1 , et on obtient la figure suivante.

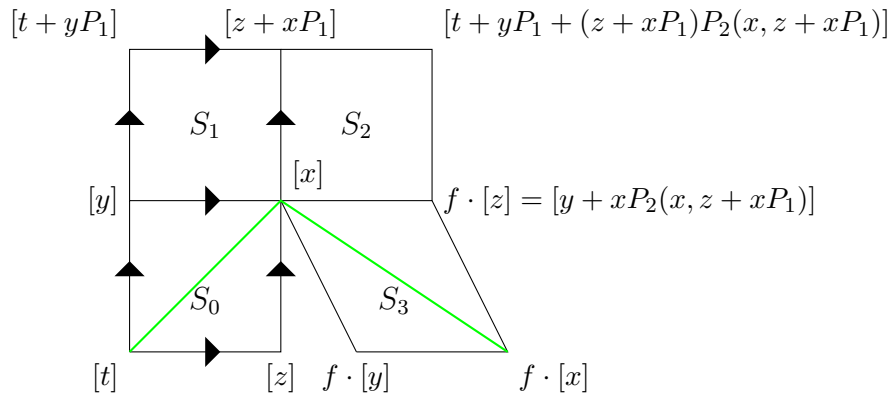

Pour propager les orientations des arêtes le long de S_2 et borner les degrés de ses sommets, on utilise maintenant les inégalités appelées "parachutes".

Ces inégalités sont dérivées des travaux de Sheshtakov et Umirbaev [SU03] et permettent de minorer le degré. Plus précisément, notons f_1, f_2 les composantes d'un automorphisme $f = (f_1, f_2, f_3, f_4)$ tels que $\nu(f_1) < \nu(f_2) < 0$. Supposons que f_1, f_2 ne soient pas *critiquement résonants*, c'est-à-dire qu'il n'existe aucun polynôme H de la forme $x - \lambda y^q$ où $\lambda \in k^*$ et q est un entier tel que $\nu(H(f_1, f_2)) > \nu(f_1)$ et $\nu(f_1) = q\nu(f_2)$. Nous marquons en bleu de telles arêtes. Les inégalités parachutes (voir §3.4) montrent alors que pour tout polynôme $P \in k[x, y]$, on a

$$\nu(f_2 P(f_1, f_2)) < \min \left\{ \frac{4}{3}\nu(f_2), \nu(f_1) \right\}.$$

Lorsque f_1, f_2 sont critiquement résonants, les inégalités parachutes ne s'appliquent plus et on marque alors une telle arête en rouge. Le point clef est de montrer que lorsque deux carrés consécutifs sont adjacents le long d'une arête critiquement résonante, alors on peut choisir une autre suite de carré $\tilde{S}_0, \tilde{S}_1, \dots$ formant un colimaçon et dont les arêtes $\tilde{S}_i \cap \tilde{S}_{i+1}$ sont toutes non critiquement résonantes. La construction de cette nouvelle suite de carrés repose sur la géométrie au voisinage d'un sommet de type I et un changement de carré correspond à une homotopie dans le link des sommets de type I.

Illustrons notre méthode sur notre exemple $f = g_1 \circ g_2 \circ g_3 \circ (t, z, y, x)$, et montrons que $\nu(x \circ f) < (4/3)\nu(x)$ lorsque P_1 est de la forme

$$P_1 = x^6 + x^4 + y^3,$$

et $P_2, P_3 \in k[x, y] \setminus k[x]$ sont quelconques. Nous allons estimer le degré en considérant trois carrés consécutifs dans le colimaçon autour de $[x]$.

Remarquons que l'arête contenant $[x]$ et $[z + x(x^6 + x^4 + y^3)]$ est critiquement résonante. En effet le polynôme $H = x - y^7$ vérifie :

$$\nu(H(z + x^7 + x^5 + xy^3, x)) = 5\nu(x) > 7\nu(x).$$

On considère alors le carré contenant $[x], [y]$ et $[z + x^5 + xy^3]$. L'arête $[x], [z + x^5 + xy^3]$ est aussi critiquement résonante, mais on a toujours :

$$\nu(z + x^5 + xy^3) = 5\nu(x) < \nu(x).$$

Et nous avons : $\nu(\bar{H}(z + x^5 + xy^3, x)) = \nu(xy^3) > 5\nu(x)$ où $\bar{H} = x - y^5$. On considère alors le carré \tilde{S}_1 contenant $[y], [x]$ et $[z + xP_1(x, y) - x^7 - x^5]$. Comme l'arête $\tilde{S}_1 \cap \tilde{S}_2$ n'est pas critiquement résonante, les inégalités parachute s'appliquent, et comme $P_2 \in k[x, y] \setminus k[x]$, on a :

$$\nu(y + xP_2(x, z + x^7 + x^5 + xy^3)) < \min \left(\frac{4}{3}\nu(x), \nu(z + xy^3) \right).$$

Un argument élémentaire (Lemme 3.5.4.3 et Lemme 3.5.4.2) nous donne l'orientation de toutes les arêtes du carrés S_2 (ainsi que celles de \tilde{S}_1 et \tilde{S}_2) :

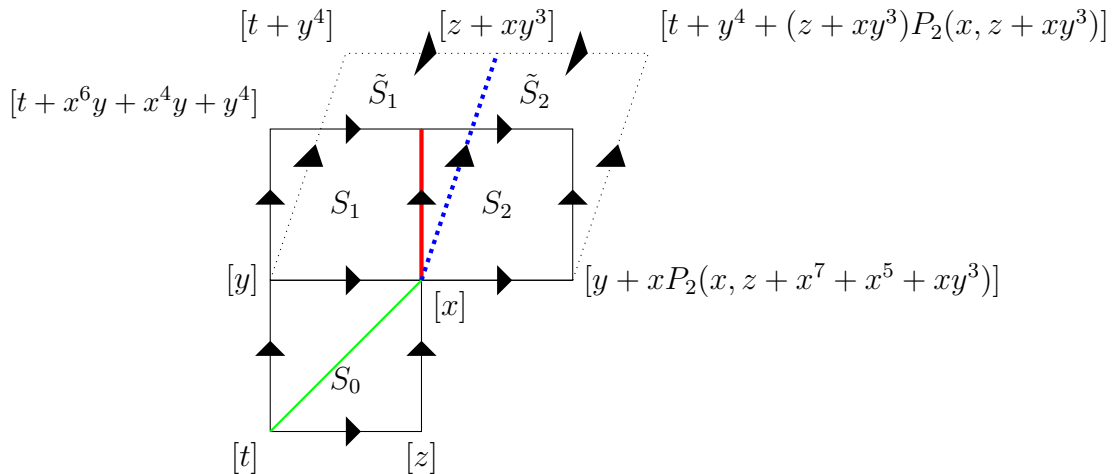

Pour obtenir les estimations sur le carré S_3 , on tente d'appliquer le même raisonnement aux trois carrés $\tilde{S}_1, \tilde{S}_2, S_3$:

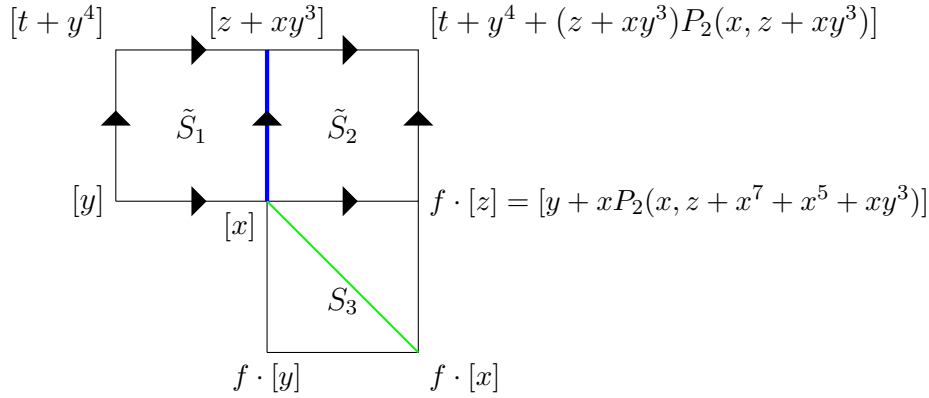

Si l'arête $\tilde{S}_2 \cap S_3$ n'est pas critiquelement résonante, les inegalités parachute s'appliquent directement et on obtient finalement que la valeur de ν sur le sommet $f \cdot [x]$ est minimale dans S_3 et que l'on a $\nu(f \cdot [x]) < \nu(f \cdot [y]) < \frac{4}{3}\nu(x)$ ce qui termine la preuve.

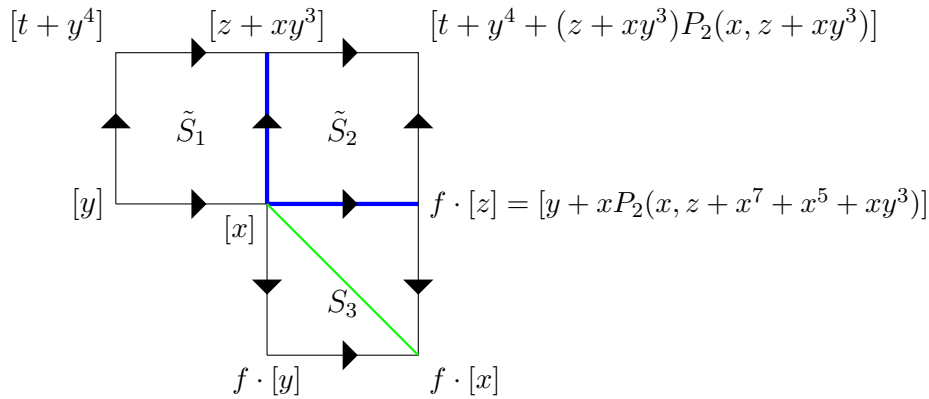

Sinon $\tilde{S}_2 \cap S_3$ est critiquelement résonante, et on cherche à construire deux carrés S'_1, S'_2 comme sur la figure :

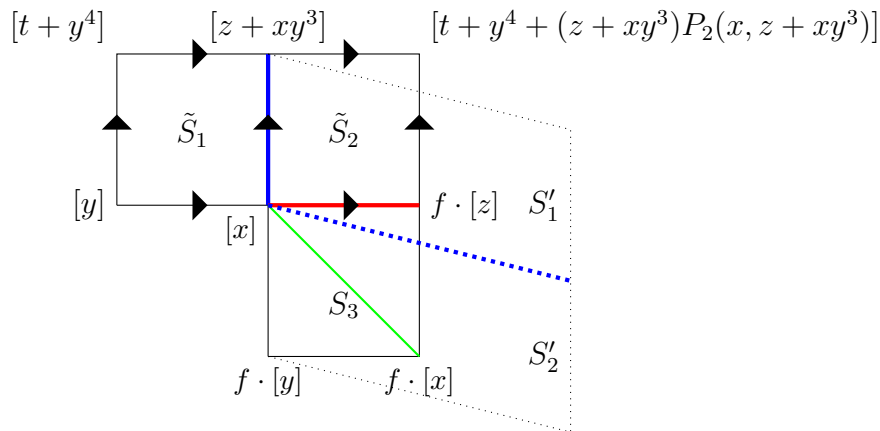

A nouveau les inegalités parachute permettent de conclure. Pour expliquer comment trouver l'arête non critiquelement résonante $S'_1 \cap S'_2$, notons que $f_3 = y + xP_2(x, z + x^7 + x^5 + xy^3)$. Le fait que $[x], [f_3]$ soit critiquelement résonante nous permet de trouver $\lambda \in k^*$ et $q \in \mathbb{N}^*$ tels que $\nu(f_3 - \lambda x^q) > \nu(f_3) = q\nu(x)$. Si $[x], [f_3 - \lambda x^q]$ n'est pas critiquelement résonante, S'_1 (resp. S'_2)

est l'unique carré contenant $[x], [z + xy^3]$ et $[f_3 - \lambda x^q]$ (resp. $[x], [f_2 = f \cdot y]$ et $[f_3 - \lambda x^q]$). Sinon on remarque alors que pour tout polynôme $R \in \mathbb{k}[x] \setminus \mathbb{k}$, on a :

$$\nu(y + xP_2(x, z + x^7 + x^5 + xy^3) + xR(x)) < \nu(x) ,$$

ce qui nous permet de trouver λ', q' tels que $\nu(f_3 - \lambda x^q - \lambda' x^{q'}) > \nu(f_3 - \lambda x^q) = q'\nu(x)$, et une récurrence rapide nous permet finalement de trouver l'arête non critique résonante désirée (voir Proposition 3.6.1.2 pour les détails).

Chapitre 1

Degrees of iterates of rational maps on normal projective varieties

Let $f : X \dashrightarrow X$ be any dominant rational self-map of a normal projective variety X of dimension n defined over an algebraically closed field k of arbitrary characteristic. If X is not normal then one can always consider its normalization. Moreover, if the field is not algebraically closed, then we shall take its algebraic closure.

Given any big and nef (e.g ample) Cartier divisor H_X on X , and any integer $0 \leq i \leq n$, one defines the i -th degree of f as the integer :

$$\deg_{i,H_X}(f) = (\pi_1^* H_X^{n-i} \cdot \pi_2^* H_X^i),$$

where π_1 and π_2 are the projections from the normalization of the graph of f in $X \times X$ onto the first and the second factor respectively and where (\cdot) denotes the intersection product on this graph.

The main theorem of the chapter can be stated as follows.

Theorem 1. *Let X be a normal projective variety of dimension n and let H_X be a big and nef Cartier divisor on X .*

(i) *There is a positive constant $C > 0$ such that for any dominant rational self-maps f, g on X , one has :*

$$\deg_{i,H_X}(f \circ g) \leq C \deg_{i,H_X}(f) \deg_{i,H_X}(g).$$

(ii) *For any big nef Cartier divisor H'_X on X , there exists a constant $C > 0$ such that for any rational self-map f on X , one has :*

$$\frac{1}{C} \leq \frac{\deg_{i,H_X}(f)}{\deg_{i,H'_X}(f)} \leq C.$$

Observe that Theorem 1.(ii) implies that the degree growth of f is a birational invariant, in the sense that there is a positive constant C such that for any birational map $g : X' \dashrightarrow X$ with X' projective, and any big nef Cartier divisor $H_{X'}$ on X' , one has

$$\frac{1}{C} \leq \frac{\deg_{i,H_X}(f^p)}{\deg_{i,H_{X'}}(g^{-1} \circ f^p \circ g)} \leq C,$$

for any $p \in \mathbb{N}$. Indeed, by applying Theorem 1.(ii) for the induced action by f on the normalization of the graph of g , one deduces that the growth of the degrees on the graph of g and on X and X' are controlled by a strictly positive constant. Fekete's lemma and Theorem 1.(i)

also imply the existence of the dynamical degree (first introduced in [RS97] for rational maps of the projective space) as the following quantity :

$$\lambda_i(f) := \lim_{p \rightarrow +\infty} \deg_{i, H_X}(f^p)^{1/p} .$$

The independence of $\lambda_i(f)$ under the choice of H_X , and its birational invariance are the consequence of Theorem 1.(ii) .

When $k = \mathbb{C}$, Theorem 1 was proved by Dinh and Sibony in [DS05b], and further generalized to compact Kähler manifolds in [DS04a]. The core of their argument relied on a procedure of regularization for closed positive currents of any bidegree ([DS04a, Theorem 1.1]) and was therefore transcendental in nature. When k is a field of characteristic zero, there exists an inclusion of the field k in \mathbb{C} by Lefschetz principle ([Lef53]) and Dinh and Sibony's argument proves that the i -th dynamical degree of any rational dominant map is well-defined. Recently, Truong [Tru15] managed to get around this problem and proved Theorem 1 for arbitrary smooth varieties using an appropriate Chow-type moving lemma. He went further in [Tru16a] and obtained Theorem 1 for any normal variety in all characteristic by applying de Jong's alteration theorem ([Jon96]). Note however that he had to deal with correspondences since a rational self-map can only be lifted as a correspondence through a general alteration map. Our approach avoids this technical difficulty.

To illustrate our method, let us explain the proof of Theorem 1, when X is smooth, $i = 1$ and f, g are regular following the method initiated in [BFJ08a, Proposition 3.1]. Recall that a divisor α on X is *pseudo-effective* and one writes $\alpha \geq 0$ if for any ample Cartier divisor H on X , and any rational $\epsilon > 0$, a suitable multiple of the \mathbb{Q} -divisor $\alpha + \epsilon H$ is linearly equivalent to an effective one.

Recall also the fundamental Siu inequality¹ ([Laz04, Theorem 2.2.13], [Cut15]) which states :

$$\alpha \leq n \frac{(\alpha \cdot \beta^{n-1})}{(\beta^n)} \beta, \tag{1.1}$$

for any nef divisor α , and any big and nef divisor β .

Since the pullback by a dominant morphism of a big nef divisor remains big and nef, we may apply (1.1) to the big nef divisors $\alpha = g^* f^* H_X$ and $\beta = f^* H_X$, and we get

$$g^* f^* H_X \leq n \frac{\deg_{1, H_X}(f)}{(H_X^n)} g^* H_X .$$

Intersecting with the cycle H_X^{n-1} yields the submultiplicativity of the degrees with the constant $C = n/(H_X^n)$.

We observe that the previous inequality (1.1) can be easily extended to complete intersections by cutting out by suitable ample sections. In particular, we get a positive constant C such that for any big nef divisors α and β , one has :

$$\alpha^i \leq C \frac{(\alpha^i \cdot \beta^{n-i})}{(\beta^n)} \beta^i. \tag{1.2}$$

Such inequalities have been obtained by Xiao ([Xia15a]) and Popovici ([Pop16a]) in the case $k = \mathbb{C}$. Their proof uses the resolution of complex Monge-Ampère equations and yields a constant $C = \binom{n}{i}$. On the other hand, our proof applies in arbitrary characteristic and in fact to more general classes than complete intersection ones. We refer to Theorem 3 below and the

1. this inequality is also referred to as the weak transcendental holomorphic Morse inequality in [LX15b]

discussion preceding it for more details. Note however that we only obtain $C = (n - i + 1)^i$, far from the expected optimal constant $C = \binom{n}{i}$ of Popovici. Once (1.2) is proved, Theorem 1 follows by a similar argument as in the case $i = 1$.

Going back to the case where X is a complex smooth projective variety, recall that the degree of f is controlled up to a uniform constant by the norm of the linear operator $f^{\bullet,i}$, induced by pullback on the de Rham cohomology space $H_{dR}^{2i}(X)_{\mathbb{R}}$ ([DS05b, Lemma 4]). One way to construct $f^{\bullet,i}$ is to use the Poincaré duality isomorphisms $\psi_X : H_{dR}^{2i}(X, \mathbb{R}) \rightarrow H_{2n-2i}(X, \mathbb{R})$, $\psi_{\Gamma_f} : H_{dR}^{2i}(\Gamma_f, \mathbb{R}) \rightarrow H_{2n-2i}(\Gamma_f, \mathbb{R})$ where $H_i(X, \mathbb{R})$ denotes the i -th simplicial homology group of X . The operator $f^{\bullet,i}$ is then defined following the commutative diagram below :

$$\begin{array}{ccccc} H_{dR}^{2i}(\Gamma_f, \mathbb{R}) & \xrightarrow{\psi_{\Gamma_f}} & H_{2n-2i}(\Gamma_f, \mathbb{R}) & \xrightarrow{\pi_{1*}} & H_{2n-2i}(X, \mathbb{R}) \\ \pi_2^* \uparrow & & & & \downarrow \psi_X^{-1} \\ H_{dR}^{2i}(X, \mathbb{R}) & \xrightarrow{f^{\bullet,i}} & & & H_{dR}^{2i}(X, \mathbb{R}), \end{array}$$

where Γ_f is a desingularization of the graph of f in $X \times X$, and π_1, π_2 are the projections from Γ_f onto the first and second factor respectively.

In order to state an analogous result in our setting, we need to find a replacement for the de Rham cohomology group $H_{dR}^{2i}(X)_{\mathbb{R}}$ and define suitable pullback operators. When X is smooth, one natural way to proceed is to consider the spaces $N^i(X)_{\mathbb{R}}$ of algebraic \mathbb{R} -cycles of codimension i modulo numerical equivalence. The operator $f^{\bullet,i}$ is then simply given by the composition $\pi_{1*} \circ \pi_2^* : N^i(X)_{\mathbb{R}} \rightarrow N^i(X)_{\mathbb{R}}$.

When X is singular, then the situation is more subtle because one cannot intersect arbitrary cycle classes in general². One can consider two natural spaces of numerical cycles $N^i(X)_{\mathbb{R}}$ and $N_i(X)_{\mathbb{R}}$ on which pullback operations and pushforward operations by proper morphisms are defined respectively. More specifically, the *space of numerical i -cycles* $N_i(X)_{\mathbb{R}}$ is defined as the group of \mathbb{R} -cycles of dimension i modulo the relation $z \equiv 0$ if and only if $(p^*z \cdot D_1 \cdots D_{e+i}) = 0$ for any proper flat surjective map $p : X' \rightarrow X$ of relative dimension e and any Cartier divisors D_j on X' . One can prove that $N_i(X)_{\mathbb{R}}$ is a finite dimensional vector space and one defines $N^i(X)_{\mathbb{R}}$ as its dual $\text{Hom}(N_i(X)_{\mathbb{R}}, \mathbb{R})$.

Note that our presentation differs slightly from Fulton's definition (see Appendix 1.9 for a comparison), but we also recover the main properties of the numerical groups. This approach is more suitable to compare cycles using positivity estimates on complete intersections.

As in the complex case, we are able to construct Poincaré duality maps $\psi_X : N^i(X)_{\mathbb{R}} \rightarrow N_{n-i}(X)_{\mathbb{R}}$ and $\psi_{\Gamma_f} : N^i(\Gamma_f)_{\mathbb{R}} \rightarrow N_{n-i}(\Gamma_f)_{\mathbb{R}}$, but they are not necessarily isomorphisms due to the presence of singularities. As a consequence, we are only able to define a linear map $f^{\bullet,i}$ as $f^{\bullet,i} := \pi_{1*} \circ \psi_{\Gamma_f} \circ \pi_2^* : N^i(X)_{\mathbb{R}} \rightarrow N_{n-i}(X)_{\mathbb{R}}$ between two distinct vector spaces. Despite this limitation, we prove a result analogous to one of Dinh and Sibony. The next theorem was obtained by Truong for smooth varieties ([Tru16a, Theorem 1.1.(5)]).

Theorem 2. *Let X be a normal projective variety of dimension n . Fix any norms on $N^i(X)_{\mathbb{R}}$ and $N_{n-i}(X)_{\mathbb{R}}$, and denote by $\|\cdot\|$ the induced operator norm on linear maps from $N^i(X)_{\mathbb{R}}$ to $N_{n-i}(X)_{\mathbb{R}}$. Then there is a constant $C > 0$ such that for any rational selfmap $f : X \dashrightarrow X$, one has :*

$$\frac{1}{C} \leq \frac{\|(f)^{\bullet,i}\|}{\text{deg}_{i,H_X}(f)} \leq C. \quad (1.3)$$

2. an arbitrary curve can only be intersected with a Cartier divisor, not with a general Weil divisor.

Our proof of Theorem 2 exploits a natural notion of positive classes in $N^i(X)_{\mathbb{R}}$ combined with a strengthening of (1.2) to these classes that we state below (see Theorem 3).

To simplify our exposition, let us suppose again that X is smooth. As in codimension 1, one can define the *pseudo-effective cone* $\text{Psef}^i(X)$ as the closure in $N^i(X)_{\mathbb{R}}$ of the cone generated by effective cycles of codimension i . Its dual with respect to the intersection product is the *nef cone* $\text{Nef}^{n-i}(X)$, which however does not behave well when $i \geq 2$ (see [DELV11a]). Some alternative notions of positive cycles have been introduced by Fulger and Lehmann in [FL14b], among which the notion of basepoint free classes emerges. Basepoint free classes have many good properties such as being both pseudo-effective and nef, being invariant by pull-backs by morphisms and by intersection products, and forming a salient convex cone with non-empty interior. The terminology comes from the fact that the basepoint free classes always have a cycle representing them which intersects any subvariety with the expected dimension. Denote by $\text{BPF}^i(X)$ the cone of basepoint free classes. It is defined as the closure in $N^i(X)_{\mathbb{R}}$ of the cone generated by \mathbb{R} -cycles of the form $p_*(D_1 \cdots D_{e+i})$ where D_j are ample Cartier \mathbb{R} -divisors and $p : X' \rightarrow X$ is a flat surjective proper morphism of relative dimension e .

For basepoint free classes, we are able to prove the following generalization of (1.2).

Theorem 3. *Let X be a normal projective variety of dimension n . Then there exists a constant $C > 0$ such that for any basepoint free class $\alpha \in \text{BPF}^i(X)$, for any big nef divisor β , one has in $N^i(X)_{\mathbb{R}}$:*

$$\alpha \leq C \frac{(\alpha \cdot \beta^{n-i})}{(\beta^n)} \times \beta^i. \quad (1.4)$$

Theorem 2 follows from (1.4) by observing that $f^{\bullet,i} \text{BPF}^i(X) \subset \text{Psef}^i(X)$, so that the operator norm $\|f^{\bullet,i}\|$ can be computed by evaluating $f^{\bullet,i}$ only on basepoint free classes.

In the singular case, the proof of Theorem 2 is completely similar but the spaces $N^i(X)_{\mathbb{R}}$ and $N_{n-i}(X)_{\mathbb{R}}$ are not necessarily isomorphic in general. As a consequence, several dual notions of positivity appear in $N^i(X)_{\mathbb{R}}$ and $N_i(X)_{\mathbb{R}}$ that make the arguments more technical.

Finally, using the techniques developed in this paper, we give a new proof of the product formula of Dinh, Nguyen, Truong ([DN11a, Theorem 1.1],[DNT12, Theorem 1.1]) which they proved when $k = \mathbb{C}$ and which was later generalized by Truong ([Tru16a, Theorem 1.1.(4)]) to normal projective varieties over any field.

The setup is as follows. Let $q : X \rightarrow Y$ be any proper surjective morphism between normal projective varieties, and fix two big and nef divisors H_X, H_Y on X and Y respectively. Consider two dominant rational self-maps $f : X \dashrightarrow X, g : Y \dashrightarrow Y$, which are semi-conjugated by q , i.e. which satisfy $q \circ f = g \circ q$. To simplify notation we shall write $X/qY \xrightarrow[f]{g} X/qY$ when these assumptions hold true.

Recall that the *i -th relative degree* of $X/qY \xrightarrow[f]{g} X/qY$ is given by the intersection product

$$\text{reldeg}_i(f) := (\pi_1^*(H_X^{\dim X - \dim Y - i} \cdot q^* H_Y^{\dim Y}) \cdot \pi_2^* H_X^i),$$

where π_1 and π_2 are the projections from the graph of f in $X \times X$ onto the first and the second component respectively. One can show a relative version of Theorem 1 (see Theorem 1.5.2.1), and define as in the absolute case, the *i -th relative dynamical degree* $\lambda_i(f, X/Y)$ as the limit $\lim_{p \rightarrow +\infty} \text{reldeg}_i(f^p)^{1/p}$. It is also a birational invariant in the sense that if $\varphi : X' \dashrightarrow X, \psi : Y' \dashrightarrow Y$ such that $q' = \psi^{-1} \circ q \circ \varphi$ is regular, then $\lambda_i(\varphi^{-1} \circ f \circ \varphi, X'/Y') = \lambda_i(f, X/Y)$, and does not depend on the choices of H_X and H_Y . When $q : X \dashrightarrow Y$ is merely rational and dominant, then we define (see Section 1.6) the *i -th relative degree of f* by replacing X with the normalization of graph of q . We prove the following theorem.

Theorem 4. *Let X, Y be normal projective varieties. For any dominant rational self-maps $f : X \dashrightarrow X$, $g : Y \dashrightarrow Y$ which are semi-conjugated by a dominant rational map $q : X \dashrightarrow Y$, we have*

$$\lambda_i(f) = \max_{\max(0, i-l) \leq j \leq \min(i, e)} (\lambda_{i-j}(g) \lambda_j(f, X/Y)) . \quad (1.5)$$

Our proof follows closely Dinh and Nguyen's method from [DN11a] and relies on a fundamental inequality (see Corollary 1.7.1.5 below) which follows from Künneth formula at least when $k = \mathbb{C}$. To state it precisely, consider $\pi : X' \rightarrow X$ a surjective generically finite morphism and $q : X \rightarrow Y$ a surjective morphism where X', X and Y are normal projective varieties such that $n = \dim X = \dim X'$ and such that $l = \dim Y$. We prove that for any basepoint free classes $\alpha \in \text{BPF}^i(X')$ and $\beta \in \text{BPF}^{n-i}(X')$, one has :

$$(\beta \cdot \alpha) \leq C \sum_{\max(0, i-l) \leq j \leq \min(i, e)} U_j(\alpha) \times (\beta \cdot \pi^*(q^* H_Y^{i-j} \cdot H_X^j)), \quad (1.6)$$

where H_Y and H_X are big and nef divisors on Y and X respectively, and $U_j(\alpha)$ is the intersection product given by $U_j(\alpha) = (\pi^*(q^* H_Y^{l-i+j} \cdot H_X^{e-j}) \cdot \alpha)$.

In the singular case, Truong has obtained this inequality using Chow's moving intersection lemma. We replace this argument by a suitable use of Siu's inequality and Theorem 3 in order to prove a positivity property for a class given by the difference between a basepoint free class in $X' \times X'$ and the fundamental class of the diagonal of X' in $X' \times X'$ (see Theorem 1.7.1.1). Inequality (1.6) is a weaker version of [DN11a, Proposition 2.3] proved by Dinh-Nguyen when Y is a complex projective variety, and was extended to a field arbitrary characteristic by Truong when Y is smooth ([Tru16a, Lemma 4.1]).

Organization of the chapter

In the first Sections 1.1 and 1.2, we review the background on the Chow groups and recall the definitions of the spaces of numerical cycles and provide their basic properties. In §1.3, we discuss the various notions of positivity of cycles and prove Theorem 3. In §1.4, we define relative numerical cycles and canonical morphisms which are the analogous to the Poincaré morphisms ψ_X in a relative setting. In §1.5, we prove Theorem 1, Theorem 2 and Theorem 4. Finally we give an alternate proof of Dinh-Sibony's theorem in the Kähler case ([DS05b, Proposition 6]) in §1.8 using Popovici [Pop16a] and Xiao's inequality [Xia15a]. Note that these inequalities allow us to avoid regularization techniques of closed positive currents but rely on a deep theorem of Yau. In Section 1.9, we prove that our presentation and Fulton's definition of numerical cycles are equivalent, hence proving that any numerical cycles can be pulled back by a flat morphism.

1.1 Chow group

1.1.1 General facts

Let X be a normal projective variety of dimension n defined over an algebraically closed field k of arbitrary characteristic.

The space of cycles $Z_i(X)$ is the free abelian group generated by irreducible subvarieties of X of dimension i , and $Z_i(X)_{\mathbb{Q}}$, $Z_i(X)_{\mathbb{R}}$ will denote the tensor products $Z_i(X) \otimes_{\mathbb{Z}} \mathbb{Q}$ and $Z_i(X) \otimes_{\mathbb{Z}} \mathbb{R}$.

Let $q : X \rightarrow Y$ be a morphism where Y is a normal projective variety. Since X and Y are respectively projective, the map q is proper. Following [Ful98], we define the proper pushforward of the cycle $[V] \in Z_i(X)$ as the element of $Z_i(Y)$ given by :

$$q_*[V] = \begin{cases} 0 & \text{if } \dim(q(V)) < \dim V \\ [\mathfrak{k}(\eta) : \mathfrak{k}(q(\eta))] \times [q(V)] & \text{if } \dim V = \dim(q(V)), \end{cases}$$

where V is an irreducible subvariety of X of dimension i , η is the generic point of V and $\mathfrak{k}(\eta)$, $\mathfrak{k}(q(\eta))$ are the residue fields of the local rings \mathcal{O}_η and $\mathcal{O}_{q(\eta)}$ respectively. We extend this map by linearity and obtain a morphism of abelian groups $q_* : Z_i(X) \rightarrow Z_i(Y)$.

Let C be any closed subscheme of X of dimension i and denote by C_1, \dots, C_r its i -dimensional irreducible components. Then C defines a fundamental class $[C] \in Z_i(X)$ by the following formula :

$$[C] := \sum_{j=1}^r l_{\mathcal{O}_{C_j, C}}(\mathcal{O}_{C_j, C})[C_j],$$

where $l_A(M)$ denotes the length of an A -module M ([Eis95, section 2.4]).

For any flat morphism $q : X \rightarrow Y$ of relative dimension e between normal projective varieties, we can define a flat pullback of cycles $q^* : Z_i(Y) \rightarrow Z_{i+e}(X)$ (see [Ful98, section 1.7]). If C is any subscheme of Y of dimension i , the cycle $q^*[C]$ is by definition the fundamental class of the scheme-theoretic inverse by q :

$$q^*[C] := [q^{-1}(C)] \in Z_{i+e}(X).$$

Let W be a subvariety of X of dimension $i+1$ and φ be a rational map on W . Then we define a cycle on X by :

$$[\text{div}(\varphi)] := \sum \text{ord}_V(\varphi)[V],$$

where the sum is taken over all irreducible subvarieties V of dimension i of $W \subset X$. A cycle α defined this way is rationally equivalent to 0 and in that case we shall write $\alpha \simeq 0$.

The i -th Chow group $A_i(X)$ of X is the quotient of the abelian group $Z_i(X)$ by the free group generated by the cycles that are rationally equivalent to zero. We denote by $A_\bullet(X)$ the abelian group $\bigoplus A_i(X)$.

We recall now the functorial operations on the Chow group, which result from the intersection theory developed in [Ful98].

Theorem 1.1.1.1. *Let $q : X \rightarrow Y$ be a morphism between normal projective varieties. Then we have :*

- (i) *The morphism of abelian groups $q_* : Z_i(X) \rightarrow Z_i(Y)$ induces a morphism of abelian groups $q_* : A_i(X) \rightarrow A_i(Y)$.*
- (ii) *If the morphism q is flat of relative dimension e , then the morphism $q^* : Z_i(Y) \rightarrow Z_{i+e}(X)$ induces a morphism of abelian groups $q^* : A_i(Y) \rightarrow A_{i+e}(X)$.*

Assertion (i) is proved in [Ful98, Theorem 1.4] and assertion (ii) is given in [Ful98, Theorem 1.7].

Remark 1.1.1.2. Let $q : X \rightarrow Y$ is a flat morphism of normal projective varieties. Suppose $\alpha \in A_i(Y)$ is represented by an effective cycle $\alpha \simeq \sum n_j [V_j]$ where the n_j are positive integers. Then $q^*\alpha$ is also represented by an effective cycle.

Any cycle $\alpha \in Z_0(X)_{\mathbb{Z}}$ is of the form $\sum n_j [p_j]$ with $p_j \in X(\mathfrak{k})$ and $n_j \in \mathbb{Z}$. We define the degree of α to be $\text{deg}(\alpha) := \sum n_j$ and we shall write :

$$(\alpha) := \text{deg}(\alpha) = \sum n_j.$$

The morphism of abelian groups $\text{deg} : Z_0(X)_{\mathbb{Z}} \rightarrow \mathbb{Z}$ induces a morphism of abelian groups $\text{deg} : A_0(X) \rightarrow \mathbb{Z}$.

1.1.2 Intersection with Cartier divisors

Let X be a normal projective variety and D be a Cartier divisor on X . Let V be a subvariety of dimension i in X and denote by $j : V \hookrightarrow X$ the inclusion of V in X . We define the intersection of D with $[V]$ as the class :

$$D \cdot [V] := j_*[D'] \in A_{i-1}(X),$$

where D' is a Cartier divisor on V such that the line bundles $j^*\mathcal{O}_X(D)$ and $\mathcal{O}_V(D')$ are isomorphic. Observe that D' exists since the exact sequence $0 \longrightarrow \mathcal{O}_V^* \longrightarrow \mathcal{M}_V^* \longrightarrow \mathcal{M}_V^*/\mathcal{O}_V^* \longrightarrow 0$ induces a surjective map from the divisor subgroups $H^0(V, \mathcal{M}_V^*/\mathcal{O}_V^*)$ of V onto the Picard group $\text{Pic}(V) = H^1(V, \mathcal{O}_V^*)$ where \mathcal{M}_V^* is the sheaf of non-zero rational functions on V .

We extend this map by linearity into a morphism of abelian groups $D \cdot : Z_i(X) \rightarrow A_{i-1}(X)$.

Theorem 1.1.2.1. *Let X be a normal projective variety and D be a Cartier divisor on X . The map $D \cdot : Z_i(X) \rightarrow A_{i-1}(X)$ induces a morphism of abelian groups $D \cdot : A_i(X) \rightarrow A_{i-1}(X)$. Moreover, the following properties are satisfied :*

1. *For all Cartier divisors D and D' on X , for all class $\alpha \in A_i(X)$, we have :*

$$(D' + D) \cdot \alpha = D' \cdot \alpha + D \cdot \alpha.$$

2. *(Projection formula) Let $q : X \rightarrow Y$ be a morphism between normal projective varieties. Then for all class $\beta \in A_i(X)$ and all Cartier divisor D on Y , we have in $A_{i-1}(Y)$:*

$$q_*(q^*D \cdot \beta) = D \cdot q_*(\beta).$$

1.1.3 Characteristic classes

Definition 1.1.3.1. *Let X be a normal projective variety of dimension n and L be a line bundle on X . There exists a Cartier divisor D on X such that the line bundles L and $\mathcal{O}_X(D)$ are isomorphic. We define the first Chern class of L as :*

$$c_1(L) := [D] \in A_{n-1}(X).$$

Definition 1.1.3.2. *For all normal projective varieties X , the group $\text{IC}^i(X)$ is the free group generated by elements of the form $D_1 \cdot \dots \cdot D_i$ where D_1, \dots, D_i are Cartier divisors on X .*

Definition 1.1.3.3. *Let X be a normal projective variety and E be a vector bundle of rank $e + 1$ on X . Given any vector bundle E on X , we shall denote by $\mathbb{P}(E)$ the projective bundle of hyperplanes in E following the convention of Grothendieck. Let p be the projection from $\mathbb{P}(E^*)$ to X and $\xi = c_1(\mathcal{O}_{\mathbb{P}(E^*)}(1))$. We define the i -th Segré class $s_i(E)$ as the morphism $s_i(E) \lrcorner : A_\bullet(X) \rightarrow A_{\bullet-i}(X)$ given by :*

$$s_i(E) \lrcorner \alpha := p_*(\xi^{e+i} \cdot p^*\alpha). \tag{1.7}$$

Remark 1.1.3.4. When X is smooth of dimension n , we can define an intersection product on the Chow groups $A_i(X) \times A_l(X) \rightarrow A_{n-i-l}(X)$ (see [Ful98, Definition 8.1.1]) which is compatible with the intersection with Cartier divisors and satisfies the projection formula (see [Ful98, Example 8.1.7]). Applying the projection formula to (1.7), we get

$$s_i(E) \lrcorner \alpha = p_*(\xi^{e+i}) \cdot \alpha,$$

so that $s_i(E)$ is represented by an element in $A_{n-i}(X)$. To simplify we shall also denote $s_i(E)$ this element.

As Segré classes of vector bundles are operators on the Chow groups $A_{\bullet}(X)$, the composition of such operators defines a product.

Theorem 1.1.3.5. (cf [Ful98, Proposition 3.1]) *Let $q : X \rightarrow Y$ be a morphism between normal projective varieties. For any vector bundle E and F on Y , the following properties hold.*

- (i) *For all $\alpha \in A_i(Y)$ and all $j < 0$, we have $s_j(E) \lrcorner \alpha = 0$.*
- (ii) *For all $\alpha \in A_i(Y)$, we have $s_0(E) \lrcorner \alpha = \alpha$.*
- (iii) *For all integers j, m , we have $s_j(E) \lrcorner (s_m(F) \lrcorner \alpha) = s_m(F) \lrcorner (s_j(E) \lrcorner \alpha)$.*
- (iv) (Projection formula) *For all $\beta \in A_i(X)$ and any integer j , we have $q_*(s_j(q^*E) \lrcorner \beta) = s_j(E) \lrcorner q_*\beta$.*
- (v) *If the morphism $q : X \rightarrow Y$ is flat, then for all $\alpha \in A_i(Y)$ and any integer j , we have $s_j(q^*E) \lrcorner q^*\alpha = q^*(s_j(E) \lrcorner \alpha)$.*

The j -th Chern class $c_j(E)$ of a vector bundle E on X is an operator $c_j(E) : A_{\bullet}(X) \rightarrow A_{\bullet-j}$ defined formally as the coefficients in the inverse power series :

$$(1 + s_1(E)t + s_2(E)t^2 + \dots)^{-1} = 1 + c_1(E)t + \dots + c_{r+1}(E)t^{r+1}.$$

A direct computation yields for example $c_1(E) = -s_1(E)$, $c_2(E) = (s_1(E)^2 - s_2(E))$.

Definition 1.1.3.6. *Let X be a normal projective variety. The abelian group $A^i(X)$ is the subgroup of $\text{Hom}(A_{\bullet}(X), A_{\bullet-i}(X))$ generated by product of Chern classes $c_{i_1}(E_1) \cdot \dots \cdot c_{i_p}(E_p)$ where i_1, \dots, i_p are integers satisfying $i_1 + \dots + i_p = i$ and where E_1, \dots, E_p are vector bundles over X . We denote by $A^{\bullet}(X)$ the group $\bigoplus A^i(X)$.*

Observe that by definition, $A^i(X)$ contains the image of $\text{IC}^i(X)$.

Recall that the Grothendieck group $K^0(X)$ is the free group generated by vector bundles on X quotiented by the subgroup generated by relations of the form $[E_1] + [E_3] - [E_2]$ where there is an exact sequence of vector bundles :

$$0 \longrightarrow E_1 \longrightarrow E_2 \longrightarrow E_3 \longrightarrow 0.$$

Moreover, the group $K^0(X)$ has a structure of rings given by the tensor product of vector bundles.

Recall also that the Chern character is the unique morphism of rings $\text{ch} : (K^0(X), +, \otimes) \rightarrow (A^{\bullet}(X), +, \cdot)$ satisfying the following properties (see [Ful98, Example 3.2.3]).

1. If L is a line bundle on X , then one has :

$$\text{ch}(L) = \sum_{i \geq 0} \frac{c_1(L)^i}{i!}.$$

2. For any morphism $q : X' \rightarrow X$ and any vector bundle E on X , we have $q^* \text{ch}(E) = \text{ch}(q^*E)$.

For any vector bundle E on X , we will denote by $\text{ch}_i(E)$ the term in $A^i(X)$ of $\text{ch}(E)$.

We recall Grothendieck-Riemann-Roch's theorem for smooth varieties.

Theorem 1.1.3.7. (see [Ful98, Corollary 18.3.2]) *Let X be a smooth variety. Then the Chern character induces an isomorphism :*

$$\text{ch} \lrcorner [X] : E \in K^0(X) \otimes \mathbb{Q} \rightarrow \text{ch}(E) \lrcorner [X] \in A_{\bullet}(X) \otimes \mathbb{Q}.$$

We also recall the definition of Schur polynomials.

Definition 1.1.3.8. Consider a vector bundle E of rank e on X . Fix two integers e, i and a decreasing partition $\lambda = (\lambda_1, \dots, \lambda_i)$ of i with terms lower or equal than e . The Schur class $s_\lambda(E)$ is the class given by :

$$s_\lambda(E) = \begin{vmatrix} c_{\lambda_1}(E) & c_{\lambda_1+1}(E) & \dots & c_{\lambda_1+i-1}(E) \\ c_{\lambda_2-1}(E) & c_{\lambda_2}(E) & \dots & c_{\lambda_2+i-2}(E) \\ \dots & \dots & \dots & \dots \\ c_{\lambda_i-i+1}(E) & c_{\lambda_i-i+2}(E) & \dots & c_{\lambda_i}(E) \end{vmatrix}.$$

If E is a vector bundle of rank e on X , then the Schur class $s_\lambda(E) \in A^i(X)$ is the Schur polynomial in the variables given by the Chern classes $c_1(E), \dots, c_e(E)$.

When the vector bundle E is globally generated, then the Schur classes can be interpreted as degeneracy loci (see [Laz04, Example 8.3.6]).

1.2 Space of numerical cycles

1.2.1 Definitions

In all this section, X, Y, X_1, X_2, X_3 and X' are normal projective varieties and X is of dimension n . Two cycles α and β in $Z_i(X)$ are said to be numerically equivalent and we will denote by $\alpha \equiv \beta$ if for all flat morphisms $p_1 : X_1 \rightarrow X$ of relative dimension e and all Cartier divisors D_1, \dots, D_{e+i} in X_1 , we have :

$$(D_1 \cdot \dots \cdot D_{e+i} \cdot q^* \alpha) = (D_1 \cdot \dots \cdot D_{e+i} \cdot q^* \beta).$$

Definition 1.2.1.1. The group of numerical classes of dimension i is the quotient $N_i(X) = Z_i(X) / \equiv$.

By construction, the group $N_i(X)$ is torsion free and there is a canonical surjective morphism $A_i(X) \rightarrow N_i(X)$ for any integer i .

Remark 1.2.1.2. Observe also that for $i = 0$, two cycles are numerically equivalent if and only if they have the same degree. Since smooth points are dense in X (see [Har77, Theorem 5.3]) and are of degree 1, this proves that the degree realizes the isomorphism $N_0(X) \simeq \mathbb{Z}$.

We set $N_i(X)_{\mathbb{Q}}$ and $N_i(X)_{\mathbb{R}}$ the two vector spaces obtained by tensoring by \mathbb{Q} and \mathbb{R} respectively.

Remark 1.2.1.3. This definition allows us to pullback numerical classes by any flat morphism $q : X \rightarrow Y$ of relative dimension e . Our presentation is slightly different from the classical one given in [Ful98, Section 19.1]. We refer to Appendix 1.9 for a proof of the equivalence of these two approaches.

Proposition 1.2.1.4. Let $q : X \rightarrow Y$ a morphism. Then the morphism of groups $q_* : Z_i(X) \rightarrow Z_i(Y)$ induces a morphism of abelian groups $q_* : N_i(X) \rightarrow N_i(Y)$.

Proof. Let n be the dimension of X and l be the dimension of Y , and let α be a cycle in $Z_i(X)$ such that α is numerically trivial. We need to prove that $q_* \alpha$ is also numerically trivial.

Take $p_1 : Y_1 \rightarrow Y$ a flat morphism of relative dimension e_1 . Let X_1 be the fibred product $X \times_Y Y_1$ and let p'_1 and q' be the natural projections from X_1 to X and Y_1 respectively.

$$\begin{array}{ccc} X_1 & \xrightarrow{p'_1} & X \\ \downarrow q' & & \downarrow q \\ Y_1 & \xrightarrow{p_1} & Y \end{array}$$

Since flatness is preserved by base change ([Har77, Proposition 9.2.(b)]), the morphism p'_1 is flat and q' is proper. Pick any cycle γ whose class is in $\text{IC}^{e_1+i}(Y_1)$. We want to prove that $(\gamma \cdot p_1^* q_* \alpha) = 0$. By [Ful98, Proposition 1.7], we have that $p_1^* q_* \alpha = q'_* p_1'^* \alpha$ in $Z_{e_1+i}(Y_1)$. Applying the projection formula, we get :

$$\gamma \cdot p_1^* q_* \alpha = \gamma \cdot q'_* p_1'^* \alpha \simeq q'_*(q'^* \gamma \cdot p_1'^* \alpha).$$

Because p'_1 is flat and $q'^* \gamma \in \text{IC}^{e_1+i}(X_1)$, we have $(q'^* \gamma \cdot p_1'^* \alpha) = 0$ so that $(\gamma \cdot p_1^* q_* \alpha) = 0$ as required. \square

The numerical classes defined above are hard to manipulate, we want to define a pullback of numerical classes by any proper morphism. We proceed and define dual classes.

We denote by $Z^i(X) = \text{Hom}_{\mathbb{Z}}(Z_i(X), \mathbb{Z})$ the space of cocycles. If $p_1 : X_1 \rightarrow X$ is a flat morphism of relative dimension e_1 , then any element $\gamma \in \text{IC}^{e_1+i}(X_1)$ induces an element $[\gamma]$ in $Z^i(X)$ by the following formula :

$$[\gamma] : \alpha \in Z_i(X) \rightarrow (\gamma \cdot p_1^* \alpha) \in \mathbb{Z}. \quad (1.8)$$

Definition 1.2.1.5. *The abelian group $N^i(X)$ is the subgroup of $Z^i(X)$ generated by elements of the form $[\gamma]$ where $\gamma \in \text{IC}^{e_1+i}(X_1)$ and X_1 is flat over X of relative dimension e_1 .*

Remark 1.2.1.6. By definition, the map $\text{deg} : Z_0(X) \rightarrow \mathbb{Z}$ is naturally an element of $Z^0(X)$. Moreover, one has using Theorem 1.1.3.5.(ii) that :

$$z \in Z_0(X) \rightarrow (s_0(E) \lrcorner z) = \text{deg}(z) \in \mathbb{Z},$$

for any vector bundle E on X . Hence, deg defines an element of $N^0(X)$ by definition of Segré classes (Definition 1.7).

Proposition 1.2.1.7. *By definition of the numerical equivalence relation, any element of $N^i(X)$ induces an element of the dual $\text{Hom}_{\mathbb{Z}}(N_i(X), \mathbb{Z})$. Hence, we can define a natural pairing between $N^i(X)$ and $N_i(X)$. For any normal projective variety, the pairing $N^i(X) \times N_i(X) \rightarrow \mathbb{Z}$ is non degenerate (i.e the canonical morphism from $N^i(X)$ to $\text{Hom}_{\mathbb{Z}}(N_i(X), \mathbb{Z})$ is injective).*

Proof. It follows directly from the definition of $N^i(X)$ and $N_i(X)$. \square

A priori, an element of $N^i(X)$ is a combination of elements $[\gamma_1] + [\gamma_2] + \dots + [\gamma_j]$. The following proposition proves one can always take $j = 1$ at least if we tensor all spaces by \mathbb{Q} .

Proposition 1.2.1.8. *Any element of $N^i(X)$ is induced by $\gamma \in \text{IC}^{e_1+i}(X_1)_{\mathbb{Q}}$ where $p_1 : X_1 \rightarrow X$ is a flat morphism of relative dimension e_1 .*

Proof. By an immediate induction argument, we are reduced to prove the assertion for the sum of two elements $[\gamma_1] + [\gamma_2]$ where $\gamma_j \in \mathrm{IC}^{e_j+i}(X_j)_{\mathbb{Q}}$ and $p_j : X_j \rightarrow X$ are flat morphisms of relative dimension e_1 and e_2 respectively.

Let us consider X' the fibre product $X_1 \times X_2$ over X and p'_j the flat projections from X' to X_j for $j = 1, 2$. By linearity, we only need to show that there exists an element $\gamma'_1 \in \mathrm{IC}^{e_1+e_2+i}(X')$ such that $[\gamma'_1] = [\gamma_1]$ in $N^i(X)$.

$$\begin{array}{ccc}
 & X_1 \times X_2 & \\
 & \swarrow p'_2 & \searrow p'_1 \\
 X_1 & & X_2 \\
 & \searrow p_1 & \swarrow p_2 \\
 & X &
 \end{array}$$

Take an ample Cartier divisor H_{X_2} on X_2 and λ_2 an integer such that $p_{2*}H_{X_2}^{e_2} \simeq \lambda_2[X]$. Setting $\gamma'_1 = \frac{1}{\lambda_2} p_1^* H_{X_2}^{e_2} \cdot p_2^* \gamma_1$, we need to prove that for any $\alpha \in Z_i(X)$, one has $(\gamma_1 \cdot p_1^* \alpha) = (\gamma'_1 \cdot p_1^* \alpha)$. By [Ful98, Proposition 1.7], we have the equality $p'_{2*} p_1^* H_{X_2}^{e_2} = p_1^* p_{2*} H_{X_2}^{e_2}$ in $Z^{e_2}(X_2)$, hence :

$$p'_{2*} p_1^* H_{X_2}^{e_2} = \lambda_2 p_1^* [X].$$

Since X_1 is reduced and $p_1^* [X]$ is a cycle of codimension 0 in X_1 , we have $p_1^* [X] = [X_1]$. Hence by the projection formula, we have :

$$\begin{aligned}
 \frac{1}{\lambda_2} p'_{2*} (p_2^* (\gamma_1 \cdot p_1^* \alpha) \cdot p_1^* H_{X_2}^{e_2}) &= \frac{1}{\lambda_2} (p_1^* \alpha \cdot \gamma_1) \cdot p_{2*} p_1^* H_{X_2}^{e_2} \\
 &= \frac{1}{\lambda_2} (p_1^* \alpha \cdot \gamma_1) \cdot \lambda_2 [X_1] \\
 &= p_1^* \alpha \cdot \gamma_1.
 \end{aligned}$$

In particular, the degrees are equal and $[\gamma_1] = [\gamma'_1] \in N^i(X)$ as required.

By the same argument, there exists a class $\gamma'_2 \in \mathrm{IC}^{e_1+e_2+i}(X_1 \times X_2)$ such that $[\gamma_2] = [\gamma'_2] \in N^i(X)$, hence $[\gamma_1] + [\gamma_2] = [\gamma'_1] + [\gamma'_2] = [\gamma'_1 + \gamma'_2] \in N^i(X)$ as required. \square

Definition 1.2.1.9. We define $N_{\bullet}(X)$ (resp. $N^{\bullet}(X)$) by $\bigoplus_i N_i(X)$ (resp. $\bigoplus_i N^i(X)$).

1.2.2 Algebra structure on the space of numerical cycles

We now define a structure of algebra on $N^{\bullet}(X)$, and prove that $N_{\bullet}(X)$ has a structure of $N^{\bullet}(X)$ module.

Pick $\gamma \in \mathrm{IC}^{e_1+i}(X_1)_{\mathbb{Q}}$ where $p_1 : X_1 \rightarrow X$ is a flat morphism of relative dimension e_1 . The element γ induces a morphism in the Chow group :

$$\gamma_{\perp} \cdot : \alpha \in A_l(X) \rightarrow p_{1*}(\gamma \cdot p_1^* \alpha) \in A_{l-i}(X). \quad (1.9)$$

The morphism $\gamma_{\perp} \cdot : A_l(X) \rightarrow A_{l-i}(X)$ induces a morphism of abelian groups from $N_l(X)$ to $N_{l-i}(X)$.

Proposition 1.2.2.1. Any element $\alpha \in N^i(X)$ induces a morphism $\alpha_{\perp} \cdot : N_{\bullet}(X) \rightarrow N_{\bullet-i}(X)$ such that the following conditions are satisfied.

- (i) If α is induced by $\gamma \in \mathrm{IC}^{e_1+i}(X_1)_{\mathbb{Q}}$ where $p_1 : X_1 \rightarrow X$ is a flat morphism of relative dimension e_1 , then for any integer l and any $z \in N_l(X)$, one has in $N_{l-i}(X)$:

$$\alpha_{\perp} z = \gamma_{\perp} z.$$

(ii) For any $\alpha, \beta \in N^i(X)$ and any $z \in N_l(X)$, we have :

$$(\alpha + \beta)_\perp z = \alpha_\perp z + \beta_\perp z.$$

Proof. Let us consider $\alpha \in N^i(X)$ and suppose it is induced by $\gamma_1 \in \text{IC}^{e_1+i}(X_1)_\mathbb{Q}$ where $p_1 : X_1 \rightarrow X$ is a flat morphism of relative dimension e_1 . We define the map $\alpha_\perp \cdot$ as :

$$\alpha_\perp z = \gamma_1 \perp z,$$

for any $z \in N_l(X)$. We show that the morphism does not depend on the choice of the class γ_1 and (i) is follows from Proposition 1.2.1.8. Assertion (ii) follows from the linearity of the intersection product whose proof follows closely the proof of Proposition 1.2.1.8.

Suppose that $[\gamma_1] = [\gamma_2] \in N^i(X)$ where $\gamma_2 \in \text{IC}^{e_2+i}(X_2)_\mathbb{Q}$ and $p_2 : X_2 \rightarrow X$ is a flat morphism of relative dimension e_2 , then we need to prove that :

$$p_{1*}(\gamma_1 \cdot p_1^* z) \equiv p_{2*}(\gamma_2 \cdot p_2^* z),$$

for any fixed $z \in Z_l(X)$. Take $\beta \in \text{IC}^{e_3+l-i}(X_3)$ where $p_3 : X_3 \rightarrow X$ is flat morphism of relative dimension e_3 , we only need to show that :

$$(\beta \cdot p_{3*} p_{1*}(\gamma_1 \cdot p_1^* z)) = (\beta \cdot p_{3*} p_{2*}(\gamma_2 \cdot p_2^* z)).$$

Let X'_1 and X'_2 the fibre products $X_1 \times X_3$ and $X_2 \times X_3$, and $p'_1 : X'_1 \rightarrow X_3$, $p'_3 : X'_1 \rightarrow X_1$, $q_2 : X'_2 \rightarrow X_3$, $q_3 : X'_2 \rightarrow X_2$ be the corresponding flat projection morphisms such that we obtain the following commutative diagrams :

$$\begin{array}{ccc} & X'_1 & \\ & \swarrow p'_3 & \searrow p'_1 \\ X_1 & & X_3 \\ & \searrow p_1 & \swarrow p_3 \\ & X & \end{array} \quad \begin{array}{ccc} & X'_2 & \\ & \swarrow q_3 & \searrow q_2 \\ X_2 & & X_3 \\ & \searrow p_2 & \swarrow p_3 \\ & X & \end{array}$$

As above, we have $p_{3*} p_{1*} = p'_{1*} p'_{3*}$, hence :

$$\begin{aligned} (\beta \cdot p_{3*} p_{1*}(\gamma_1 \cdot p_1^* z)) &= (\beta \cdot p'_{1*} p'_{3*}(\gamma_1 \cdot p_1^* z)) \\ &= (p'_{1*} \beta \cdot p'_{3*}(\gamma_1 \cdot p_1^* z)) \\ &= (p_{3*} \gamma_1 \cdot p_1^* p_{3*} z \cdot p_1^* \beta) \\ &= (\gamma_1 \cdot p_{3*} p_1^*(p_{3*} z \cdot \beta)) \\ &= (\gamma_1 \cdot p_1^* p_{3*}(p_{3*} z \cdot \beta)) \\ &= (\gamma_2 \cdot p_2^* p_{3*}(p_{3*} z \cdot \beta)). \end{aligned}$$

By a similar argument, we show that $(\beta \cdot p_{3*} p_{2*}(\gamma_2 \cdot p_2^* z)) = (\gamma_2 \cdot p_2^* p_{3*}(p_{3*} z \cdot \beta))$ which implies the desired equality :

$$(\beta \cdot p_{3*} p_{1*}(\gamma_1 \cdot p_1^* z)) = (\beta \cdot p_{3*} p_{2*}(\gamma_2 \cdot p_2^* z)).$$

□

Proposition 1.2.2.2. *There exists a unique structure of commutative graded ring with unit (deg) on $N^\bullet(X)$ given by $(\alpha, \beta) \in N^\bullet(X) \times N^\bullet(X) \mapsto \alpha \cdot \beta \in N^\bullet(X)$ which satisfies the following properties :*

(i) For any $\alpha, \beta \in N^\bullet(X)$ and any $z \in N_\bullet(X)$, one has :

$$(\alpha \cdot \beta)_\perp z = (\alpha_\perp(\beta_\perp z)) = (\beta_\perp(\alpha_\perp z)).$$

(ii) For any $z \in N_{\bullet}(X)$, we have $(\deg)_{\perp} z = z$.

(iii) The morphism of abelian groups given by

$$(\alpha, z) \in N^{\bullet}(X) \times N_{\bullet}(X) \mapsto \alpha_{\perp} z \in N_{\bullet}(X)$$

is bilinear.

Hence, the abelian group $N_{\bullet}(X)$ has the structure of a graded $N^{\bullet}(X)$ -module.

Proof. Take $\alpha_1 \in N^i(X)$ and $\alpha_2 \in N^l(X)$ and define $\varphi \in Z^{i+l}(X)$ by the formula :

$$\varphi : z \in Z_{i+l}(X) \rightarrow (\alpha_1 \perp (\alpha_2 \perp z)).$$

We prove that φ is an element of $N^{i+l}(X)$.

By linearity, we can suppose that α_i is induced by $\gamma_i \in IC^{i+e_j}(X_j)$ where $p_j : X_j \rightarrow X$ is a flat morphism of relative dimension e_j for $j = 1, 2$. Let $X' = X_1 \times_X X_2$ be the fibre product, let p'_1 and p'_2 be the projections from X' to X_1 and X_2 respectively such that we have the commutative diagram :

$$\begin{array}{ccc} & X' & \\ p'_2 \swarrow & & \searrow p'_1 \\ X_1 & & X_2 \\ p_1 \searrow & & \swarrow p_2 \\ & X & \end{array}$$

By the projection formula, we obtain for all $z \in Z_{i+l}(X)$:

$$\varphi(z) = (p_1'^* \gamma_2 \cdot p_2'^* \gamma_1 \cdot p_2'^* p_1^* z). \quad (1.10)$$

In particular, we have shown that φ is induced by $p_1'^* \gamma_2 \cdot p_2'^* \gamma_1 \in IC^{e_1+e_2+i+l}(X')$, hence φ is an element of $N^{i+l}(X)$. Moreover, the commutativity of the intersection product in (1.10) proves that $(\alpha_2 \perp (\alpha_1 \perp z)) = (\alpha_1 \perp (\alpha_2 \perp z))$ for any $z \in N_{i+l}(X)$, hence $\alpha_1 \cdot \alpha_2 = \alpha_2 \cdot \alpha_1$.

Pick a vector bundle E on X . As the element $\deg \in N^0(X)$ is equal to $z \rightarrow (s_0(E)_{\perp} z)$ in $N^0(X)$ (see Remark 1.2.1.6), we get using Theorem 1.1.3.5.(ii) that :

$$(\alpha_{\perp} z) = (\alpha_{\perp} (s_0(E)_{\perp} z)) = (s_0(E)_{\perp} (\alpha_{\perp} z)) = ((\alpha \cdot \deg)_{\perp} z) = (\deg \cdot \alpha)_{\perp} z,$$

for any $z \in N_l(X)$ and any $\alpha \in N^l(X)$. Hence, \deg is a unit of $N^{\bullet}(X)$. □

1.2.3 Pullback on dual numerical classes

Let us consider $q : X \rightarrow Y$ a proper morphism. We define for any integer i the pullback $q^* : N^i(Y) \rightarrow \text{Hom}_{\mathbb{Z}}(N_i(X), \mathbb{Z})$ as the dual of the pushforward operation $q_* : N_i(X) \rightarrow N_i(Y)$ with respect to the pairing $N^i(X) \times N_i(X) \rightarrow \mathbb{Z}$ defined in Proposition 1.2.1.7.

Proposition 1.2.3.1. *Let $q : X \rightarrow Y$ be a proper morphism. The morphism q^* induces a morphism of graded rings $q^* : N^{\bullet}(Y) \rightarrow N^{\bullet}(X)$ which satisfies the projection formula :*

$$\forall \alpha \in N^i(Y), \forall z \in N_l(X), q_*(q^* \alpha \perp z) = \alpha \perp q_* z.$$

Proof. We only need to prove that the image $q^*(N^i(Y))$ is contained in $N^i(X)$ and that the projection formula is satisfied as it directly implies that $q^* : N^\bullet(Y) \rightarrow N^\bullet(X)$ is a morphism of rings since :

$$(\alpha \cdot \beta) \lrcorner q_* z = q^*(\alpha \cdot \beta) \lrcorner z = \alpha \lrcorner q_*(q^* \beta \lrcorner z) = (q^* \alpha \cdot q^* \beta) \lrcorner z,$$

for any $\alpha \in N^i(Y)$, $\beta \in N^l(Y)$ and any $z \in N_{i+l}(X)$.

Consider a class $\alpha \in N^i(Y)$ which is induced by $\gamma \in \text{IC}^{e_1+i}(Y_1)$ where $p_1 : Y_1 \rightarrow Y$ is a flat proper morphism of relative dimension e_1 . Setting X_1 to be the fibre product $Y_1 \times X$ and p'_1, q' the projections from X_1 to X and Y_1 respectively, one remarks using the equality $q'_* p'^* = p_1^* q_*$ ([Ful98, Proposition 1.7]) that $q^* \alpha$ is induced by $q'^* \gamma$, hence $q^* \alpha \in N^i(X)$ as required. And the projection formula follows easily from the projection formula on divisors (Theorem 1.1.2.1.(ii)). \square

Let us sum up all the properties of numerical classes proven so far :

Theorem 1.2.3.2. *Let $q : X \rightarrow Y$ be a proper morphism. For any integer $0 \leq i \leq \dim X$ and $0 \leq l \leq \dim Y$:*

- (i) *The pushforward morphism $q_* : Z_i(X) \rightarrow Z_i(Y)$ induces a morphism of abelian groups $q_* : N_i(X) \rightarrow N_i(Y)$.*
- (ii) *The dual morphism $q^* : Z^l(Y) \rightarrow Z^l(X)$ maps $N^l(Y)$ into $N^l(X)$.*
- (iii) *The induced morphism $q^* : N^\bullet(Y) \rightarrow N^\bullet(X)$ preserves the structure of graded rings.*
- (iv) *(Projection formula) For all $\alpha \in N^l(Y)$ and all $z \in N_i(X)$, we have $q_*(q^* \alpha \lrcorner z) \equiv \alpha \lrcorner q_* z$ in $N_{i-l}(Y)$.*

1.2.4 Canonical morphism

Theorem 1.2.4.1. *The morphism $\psi_X : \alpha \in N^i(X) \mapsto \alpha \lrcorner [X] \in N_{n-i}(X)$ is the unique morphism which satisfies the following properties.*

- (i) *The image of the morphism $\text{deg} : Z_0(X) \rightarrow \mathbb{Z}$ seen as an element of $Z^0(X)$ is given by $\psi_X(\text{deg}) = [X]$.*
- (ii) *The morphism ψ_X is $N^i(X)$ -equivariant, i.e for all $\alpha \in N^i(X)$ and all $\beta \in N^l(X)$, we have :*

$$\psi_X(\alpha \cdot \beta) = \alpha \lrcorner \psi_X(\beta).$$

- (iii) *Suppose $q : X \rightarrow Y$ is a generically finite morphism where Y is of dimension n , then we have the following identity :*

$$q_* \circ \psi_X \circ q^* = \text{deg}(q) \times \psi_Y.$$

Proof. Recall that deg is the unit in $N^\bullet(X)$, hence $\psi_X(\text{deg}) = [X]$ and (ii) follows directly from the definition and Proposition 1.2.2.2.

Assertion (iii) is then a consequence of the projection formula (see Theorem 1.2.3.2.(iv)) and the fact that $q_*[X] = \text{deg}(q)[Y]$.

Let us prove that ψ_X is unique. Suppose that $\varphi : N^i(X) \rightarrow N_{n-i}(X)$ satisfies the hypothesis of the theorem. Since $\varphi(\text{deg}) = [X]$ and since deg is the unit element of the ring $N^\bullet(X)$, we have that for any $\alpha \in N^i(X)$, $\alpha = \alpha \cdot \text{deg}$. By (ii),

$$\varphi(\alpha) = \varphi(\alpha \cdot \text{deg}) = \alpha \lrcorner \varphi(\text{deg}) = \alpha \lrcorner [X] = \psi_X(\alpha),$$

as required. \square

Now we prove some properties of ψ_X in some particular cases.

Theorem 1.2.4.2. *The following properties are satisfied.*

- (i) *If X is smooth, then for all integers $0 \leq i \leq n$, the induced morphism $\psi_X : N^i(X)_{\mathbb{Q}} \rightarrow N_{n-i}(X)_{\mathbb{Q}}$ is an isomorphism.*
- (ii) *If X is smooth and $q : X \rightarrow Y$ is a surjective generically finite morphism where Y is a normal projective variety. Then we have for all integer i :*

$$q^*(\psi_Y(N^{n-i}(Y)_{\mathbb{Q}})^{\perp}) = q^*(N^i(Y)_{\mathbb{Q}}) \cap \text{Ker}(q_* \circ \psi_X : N^i(X)_{\mathbb{Q}} \rightarrow N_{n-i}(Y)_{\mathbb{Q}}). \quad (1.11)$$

Proof. (i) Let us show that ψ_X is surjective. By the Grothendieck-Riemann-Roch's theorem (Theorem 1.1.3.7), the Chern character induces an isomorphism :

$$\text{ch}_{\mathbb{L}}[X] : E \in K^0(X) \otimes \mathbb{Q} \rightarrow \text{ch}(E)_{\mathbb{L}}[X] \in A_{\bullet}(X) \otimes \mathbb{Q}.$$

This implies that the morphism $\psi_X : N^i(X)_{\mathbb{Q}} \rightarrow N_{n-i}(X)_{\mathbb{Q}}$ is surjective because any Chern class is the image of a product of Cartier divisors by a flat map (see Remark 1.1.3.4).

We now prove that $\psi_X : N^i(X)_{\mathbb{Q}} \rightarrow N_{n-i}(X)_{\mathbb{Q}}$ is injective. Take $\alpha_1 \in N^i(X)_{\mathbb{Q}}$ such that $\psi_X(\alpha_1) = 0$. By Proposition 1.2.1.8, the class α_1 is induced by $\gamma_1 \in \text{IC}^{e_1+i}(X_1)_{\mathbb{Q}}$ where $p_1 : X_1 \rightarrow X$ is a flat morphism of relative dimension e_1 . The condition $\psi_X(\alpha_1) = 0$ is equivalent to the equality $p_{1*}\gamma_1 = 0 \in N_{n-i}(X)$. We need to show that $(\gamma_1 \cdot p_1^*z) = 0$ for any cycle $z \in Z_i(X)$. As X is smooth, we may compute intersection products inside the Chow group $A_{\bullet}(X)$ directly by Remark 1.1.3.4 and we get :

$$(\gamma_1 \cdot p_1^*z) = (p_{1*}(\gamma_1 \cdot p_1^*z)) = (p_{1*}\gamma_1 \cdot z) = 0$$

as the class $z \in N_i(X)$ is the image of an element of $N^{n-i}(X)_{\mathbb{Q}}$ by surjectivity of ψ_X .

(ii) We have the following series of equivalence :

$$\begin{aligned} \beta \in \psi_Y(N^{n-i}(Y)_{\mathbb{Q}})^{\perp} &\Leftrightarrow \forall \alpha \in N^{n-i}(Y)_{\mathbb{Q}}, (\beta \llcorner \psi_Y(\alpha)) = 0 \\ &\Leftrightarrow \forall \alpha \in N^{n-i}(Y)_{\mathbb{Q}}, (\beta \llcorner (q_*\psi_X q^*\alpha)) = 0 \\ &\Leftrightarrow \forall \alpha \in N^{n-i}(Y)_{\mathbb{Q}}, (q^*\beta \cdot q^*\alpha) = 0 \\ &\Leftrightarrow \forall \alpha \in N^{n-i}(Y)_{\mathbb{Q}}, (\alpha \llcorner q_*\psi_X q^*\beta) = 0 \\ &\Leftrightarrow q^*\beta \in \text{Ker}(q_* \circ \psi_X : N^i(X)_{\mathbb{Q}} \rightarrow N_{n-i}(Y)_{\mathbb{Q}}), \end{aligned}$$

where the second equivalence follows from Theorem 1.2.4.2.(iii), the third and the fourth equivalence from the projection formula, and the last equivalence is a consequence of the fact that ψ_X is self-adjoint :

$$(\beta \llcorner \psi_Y(\alpha)) = (\beta \llcorner (\alpha \llcorner [Y])) = (\alpha \llcorner (\beta \llcorner [Y])) = (\alpha \llcorner \psi_Y(\beta)),$$

where $\alpha \in N^i(Y)$ and $\beta \in N^{n-i}(Y)$. □

Remark 1.2.4.3. The proof of Theorem 1.2.4.2.(i) shows that when X is smooth, $N_i(X)_{\mathbb{Q}}$ is the quotient of $Z_i(X)_{\mathbb{Q}}$ by cycles $z \in Z_i(X)_{\mathbb{Q}}$ such that for any cycle $z' \in Z_{n-i}(X)_{\mathbb{Q}}$, one has $(z \cdot z') = 0$.

Remark 1.2.4.4. When X is smooth and when $k = \mathbb{C}$, denote by $\text{Alg}^i(X)$ the subgroup of the de Rham cohomology $H^{2i}(X, \mathbb{C})$ generated by algebraic cycles of dimension i in X . Then there is a surjective morphism $\text{Alg}^i(X) \rightarrow N^i(X)_{\mathbb{Q}}$

1.2.5 Numerical spaces are finite dimensional

Theorem 1.2.5.1. *Both \mathbb{Q} -vector spaces $N_i(X)_{\mathbb{Q}}$ and $N^i(X)_{\mathbb{Q}}$ are finite dimensional.*

Proof. If X is smooth, then using Remark 1.2.4.3, $N_i(X)_{\mathbb{Q}}$ is the quotient of $Z_i(X)_{\mathbb{Q}}$ by the equivalence relation which identifies cycles α and β in $Z_i(X)_{\mathbb{Q}}$ if for any cycle $z \in Z_{n-i}(X)_{\mathbb{Q}}$, $(z \cdot \alpha) = (z \cdot \beta)$. In particular, the vector-space $N_i(X)_{\mathbb{Q}}$ is finitely generated (see [Mil13, Theorem 23.6] for a reference), and so is $N^i(X)_{\mathbb{Q}}$ using Theorem 1.2.4.2.(i).

If X is not smooth, by DeJong's alteration theorem (cf [Jon96, Theorem 4.1]), there exists a smooth projective variety X' and a generically finite surjective morphism $q : X' \rightarrow X$. We only need to show that the pushforward $q_* : N_i(X')_{\mathbb{Q}} \rightarrow N_i(X)_{\mathbb{Q}}$ is surjective. Indeed this first implies that $N_i(X)_{\mathbb{Q}}$ is finite dimensional. Since the natural pairing $N^i(X)_{\mathbb{Q}} \times N_i(X)_{\mathbb{Q}} \rightarrow \mathbb{Q}$ is non degenerate we get an injection of $N^i(X)_{\mathbb{Q}}$ onto $\text{Hom}_{\mathbb{Q}}(N_i(X)_{\mathbb{Q}}, \mathbb{Q})$ which is also finite dimensional.

We take V an irreducible subvariety of codimension i in X . If $\dim q^{-1}(V) = \dim V$, then the class $q_*[q^{-1}(V)]$ in $N_{\dim V}(X)_{\mathbb{Q}}$ is represented by a cycle of dimension $\dim V$ which is included in V . As V is irreducible, we have $q_*[q^{-1}(V)] \equiv \lambda[V]$ for some $\lambda \in \mathbb{N}^*$.

If the dimension of $q^{-1}(V)$ is strictly greater than V , we take W an irreducible component of $q^{-1}(V)$ such that its image by $q|_W : W \rightarrow V$ is dominant. We write the dimension of W as $\dim V + r$ where $r > 0$ is an integer. Fix an ample divisor H_X on X . The class $H_X^r \llcorner [W] \in N_{\dim V}(X')_{\mathbb{Q}}$ is represented by a cycle of dimension $\dim V$ in W . So the image of the class $q_*(H_X^r \llcorner [W]) \in N_{\dim V}(X)_{\mathbb{Q}}$ is a multiple of $[V]$ which implies the surjectivity of q_* . □

Corollary 1.2.5.2. *For any integer $0 \leq i \leq n$, the pairing $N^i(X)_{\mathbb{R}} \times N_i(X)_{\mathbb{R}} \rightarrow \mathbb{R}$ is perfect (i.e the canonical morphism from $N^i(X)_{\mathbb{R}}$ to $\text{Hom}_{\mathbb{R}}(N_i(X)_{\mathbb{R}}, \mathbb{R})$ is an isomorphism).*

Corollary 1.2.5.3. *Suppose that the dimension of X is $2n$, then the morphism $\psi_X : N^n(X)_{\mathbb{Q}} \rightarrow N_n(X)_{\mathbb{Q}}$ is an isomorphism.*

Proof. We apply (1.11) to an alteration X' of X where $q : X' \rightarrow X$ is a proper surjective morphism and where X' is a smooth projective surface. This proves that $\psi_X : N^n(X)_{\mathbb{Q}} \rightarrow N_n(X)_{\mathbb{Q}}$ is surjective. By duality, this gives that $\psi_X : N^n(X)_{\mathbb{Q}} \rightarrow N_n(X)_{\mathbb{Q}}$ is injective. As a consequence, we have that $\psi_X : N^n(X)_{\mathbb{Q}} \rightarrow N_n(X)_{\mathbb{Q}}$ is an isomorphism. □

Corollary 1.2.5.4. *Let X be a complex normal projective variety with at most rational singularities. We suppose that X is numerically \mathbb{Q} -factorial in the sense of [BdFFU15]. Then the morphisms $\psi_X : N^1(X)_{\mathbb{Q}} \rightarrow N_{n-1}(X)_{\mathbb{Q}}$ and $\psi_X : N^{n-1}(X)_{\mathbb{Q}} \rightarrow N_1(X)_{\mathbb{Q}}$ are isomorphisms.*

Proof. Using [BdFFU15, Theorem 5.11], then any Weil divisor which is numerically \mathbb{Q} -Cartier is \mathbb{Q} -Cartier. In particular, $\psi_X : N^1(X)_{\mathbb{Q}} \rightarrow N_{n-1}(X)_{\mathbb{Q}}$ is surjective. Using (1.11) to an alteration of X' applied to $i = 1$, we have that $\psi_X : N^1(X)_{\mathbb{Q}} \rightarrow N_{n-1}(X)_{\mathbb{Q}}$ is injective. Hence $N^1(X)_{\mathbb{Q}}$ and $N_{n-1}(X)_{\mathbb{Q}}$ are isomorphic and by duality $N^{n-1}(X)_{\mathbb{Q}}$ and $N_1(X)_{\mathbb{Q}}$ are also isomorphic. □

Example 1.2.5.5. When $X = X(\Delta)$ be a toric variety associated to a complete fan Δ . The map $\psi_X : N^1(X)_{\mathbb{Q}} \rightarrow N_{n-1}(X)_{\mathbb{Q}}$ is an isomorphism if and only if Δ is a simplicial fan. Indeed, denote by N the lattice containing Δ and $M = \text{Hom}(N, \mathbb{Z})$ its dual. For any cone $\sigma \in N$, we denote by $M(\sigma)$ the vector space defined by $M(\sigma) = \{l \in M \mid \langle l, v \rangle = 0, \forall v \in \sigma\}$. The proposition in [Ful93, §5.1] implies that any class in $N_{n-1}(X)_{\mathbb{Q}}$ is represented by a torus-invariant Weil \mathbb{Q} -divisor $D = \sum a_i[V_i]$ in $X(\Delta)$. Since every maximal cone σ in the fan $\Delta \subset N$ is full-dimensional, one has $M(\sigma) = \{0\}$ and there exists an element $u(\sigma) \in M/M(\sigma) = M$ such that for any 1-dimensional ray $v_i \in \sigma$, one has :

$$\langle u(\sigma), v_i \rangle = -a_i.$$

The element $u(\sigma)$ is uniquely determined if and only if the family of rays $v_i \in \sigma$ are linearly independent (i.e Δ is simplicial).

1.3 Positivity

The notion of positivity is relatively well understood for cycles of codimension 1 and of dimension 1. For cycles of intermediate dimension this situation is however more subtle and was only recently seriously considered (see [DELV11a], [CC15], [CLO16] and the recent series of papers by Fulger and Lehmann ([FL14a], [FL14b]).

For our purpose, we will first review the notions of pseudo-effectivity and numerically effective classes. Then we generalize the construction of the basepoint free cone introduced by [FL14b] to normal projective varieties. This cone is suitable for stating generalized Siu's inequalities (see Section 1.3.4).

1.3.1 Pseudo-effective and numerically effective cones

As in the previous section, X is a normal projective variety of dimension n . To ease notation we shall also write $N^i(X)$ and $N_i(X)$ for the real vector spaces $N^i(X)_{\mathbb{R}}$ and $N_i(X)_{\mathbb{R}}$.

Definition 1.3.1.1. *A class $\alpha \in N_i(X)$ is pseudo-effective if it is in the closure of the cone generated by effective classes. This cone is denoted $\text{Psef}_i(X)$.*

When $i = 1$, $\text{Psef}_1(X)$ is the Mori cone (see e.g [KM98, Definition 1.17]), and when $i = n - 1$, $\text{Psef}_{n-1}(X)$ is the classical cone of pseudo-effective divisors, its interior being the big cone.

Definition 1.3.1.2. *A class $\beta \in N^i(X)$ is numerically effective (or nef) if for any class $\alpha \in \text{Psef}_{n-i}(X)$, $(\beta \lrcorner \alpha) \geq 0$. We denote this cone by $\text{Nef}^i(X)$.*

When $i = 1$, the cone $\text{Nef}^1(X)$ is the cone of numerically effective divisors, its interior is the ample cone.

We can define a notion of effectivity in the dual $N^i(X)$.

Definition 1.3.1.3. *A class $\alpha \in N^i(X)$ is pseudo-effective if $\psi_X(\alpha) \in \text{Psef}_{n-i}(X)$. We will write this cone as $\text{Psef}^i(X)$.*

Definition 1.3.1.4. *A class $z \in N_i(X)$ is numerically effective if for any class $\alpha \in \text{Psef}^i(X)$, one has $(\alpha \lrcorner z) \geq 0$. This cone is denoted $\text{Nef}_i(X)$.*

By convention, we will write $\alpha \leq \beta$ (resp. $\alpha \leq \beta$) for any $\alpha, \beta \in N_i(X)$ (resp. $\alpha, \beta \in N^i(X)$) if $\beta - \alpha \in \text{Psef}_i(X)$ (resp. $\beta - \alpha \in \text{Psef}^i(X)$).

When X is smooth, the morphism ψ_X induces an isomorphism between $N^i(X)$ and $N_{n-i}(X)$, and we can identify these cones :

$$\begin{aligned} \text{Nef}^i(X) &= \text{Nef}_{n-i}(X), \\ \text{Psef}^i(X) &= \text{Psef}_{n-i}(X). \end{aligned}$$

1.3.2 Pliant classes

We recall the definition of pliant classes introduced in [FL14b, Definition 3.1] and their main properties. Their definition involve Schur classes which were introduced in Section 1.1.3.

Definition 1.3.2.1. *The pliant cone $\text{PL}^\bullet(X)$ is defined as the convex cone generated by product of Schur classes of globally generated vector bundle.*

We denote by $\text{PL}^i(X)$ the set of pliant classes of codimension i in X .

Theorem 1.3.2.2. (see [FL14b, Theorem 1.3]) *The pliant cone $\text{PL}^i(X)$ satisfies the following properties.*

- (i) *The cone $\text{PL}^i(X)$ is a closed convex salient cone with non-empty interior in $\mathbb{N}^i(X)_{\mathbb{R}}$.*
- (ii) *The cone $\text{PL}^i(X)$ contains product of ample Cartier divisors in its interior.*
- (iii) *For all integer i, l , we have $\text{PL}^i(X) \cdot \text{PL}^l(X) \subset \text{PL}^{i+l}(X)$.*
- (iv) *For any (proper) morphism $q : X \rightarrow Y$, one has that $q^* \text{PL}^i(Y) \subset \text{PL}^i(X)$.*

We recall another proposition which we will reuse in our proofs.

Proposition 1.3.2.3. (cf [FL14b, Example 3.13]) *Let \mathbb{G} be a Grassmannian variety. Then $\text{PL}^i(\mathbb{G}) = \text{Psef}^i(\mathbb{G})$.*

1.3.3 Basepoint free cone on normal projective varieties

In this section, we define a cone $\text{BPF}^i(X)$ and prove in Corollary 1.3.3.4 that this cone is equal to the basepoint free cone defined by Fulger-Lehmann when X is smooth. This generalizes [FL14b, Theorem 1.7] to normal projective varieties and our proof follows closely Fulger-Lehmann's approach.

Recall that a complete intersection $\gamma \in \text{IC}^{i+e}(X')$ on X' where $p : X' \rightarrow X$ is a flat morphism of relative dimension e and where X' is an equidimensional projective scheme induces naturally (see Definition 1.2.1.5) an element $[\gamma] \in \mathbb{N}^i(X)_{\mathbb{R}} = \text{Hom}_{\mathbb{R}}(\mathbb{N}_i(X)_{\mathbb{R}}, \mathbb{R})$ by intersecting the class γ with the pullback by p of a i -dimensional cycle in X . We also refer to Proposition 1.2.2.2 for the definition of the product $\mathbb{N}^i(X)_{\mathbb{R}} \times \mathbb{N}^l(X)_{\mathbb{R}} \rightarrow \mathbb{N}^{i+l}(X)_{\mathbb{R}}$.

Definition 1.3.3.1. *The cone $\text{BPF}^i(X)$ is the closure of the convex cone in $\mathbb{N}^i(X)_{\mathbb{R}}$ generated by products of the form $[\gamma_1] \cdot \dots \cdot [\gamma_l]$ where each γ_j is a product of $e_j + i_j$ ample Cartier divisors on an equidimensional projective scheme X_j which is flat over X of relative dimension e_j and where i_j are integers satisfying $i_1 + \dots + i_l = i$.*

Remark 1.3.3.2. By definition, the cone $\text{BPF}^i(X)$ contains the products of ample Cartier divisors and Segré classes of anti-ample vector bundles.

Recall also that if $q : X \rightarrow Y$ is a flat morphism of relative dimension e between projective schemes, then the pushforward is well-defined on numerical cycles $q_* : \mathbb{N}^i(X)_{\mathbb{R}} \rightarrow \mathbb{N}^{i-e}(Y)_{\mathbb{R}}$ (see Corollary 1.9.5).

Theorem 1.3.3.3. *The cone $\text{BPF}^i(X)$ satisfies the following properties.*

- (i) *The cone $\text{BPF}^i(X)$ is a salient, closed, convex cone with non-empty interior in $\mathbb{N}^i(X)_{\mathbb{R}}$.*
- (ii) *The cone $\text{BPF}^i(X)$ contains products of ample Cartier divisors in its interior.*
- (iii) *For all integer i and l , we have $\text{BPF}^i(X) \cdot \text{BPF}^l(X) \subset \text{BPF}^{i+l}(X)$.*
- (iv) *For any (proper) morphism $q : X \rightarrow Y$, we have $q^* \text{BPF}^i(Y) \subset \text{BPF}^i(X)$.*
- (v) *For any integer i , we have $\text{BPF}^i(X) \subset \text{Nef}^i(X) \cap \text{Psef}^i(X)$.*
- (vi) *In codimension 1, one has $\text{BPF}^1(X) = \text{Nef}^1(X)$.*
- (vii) *For any flat morphism $q : X \rightarrow Y$ between equidimensional projective schemes of relative dimension e and any integer $i \geq e$, we have $q_* \text{BPF}^i(X) \subset \text{BPF}^{i-e}(Y)$.*

Moreover, $\text{BPF}(X)$ is the smallest cone satisfying properties (iii), (vi) and (vii).

Proof. We prove successively the items (iii), (vii), (v), (vi), (iv), (ii) and (i).

(iii), (vii) This follows from the definition of $\text{BPF}^i(X)$.

(v) It is sufficient to prove that for any effective cycle $z \in Z_{n-l}(X)$ and any basepoint free class $\alpha \in \text{BPF}^i(X)$, then $\alpha \perp z \in \text{Psef}_{n-i-l}(X)$. Indeed, apply this successively to $z = [X]$ and $z \in \text{Psef}_i(X)$ give the inclusions $\text{BPF}^i(X) \subset \text{Psef}^i(X)$ and $\text{BPF}^i(X) \subset \text{Nef}^i(X)$. By definition of basepoint free classes and by linearity, we can suppose that α is equal to a product $[\gamma_1] \cdot \dots \cdot [\gamma_p]$ where $\gamma_i \in \text{IC}^{e_j+i_j}(X_j)_{\mathbb{R}}$ are products of ample Cartier divisors on X_j where $p_j : X_i \rightarrow X$ is a flat proper morphism of relative dimension e_j and where i_j are integers such that $i_1 + \dots + i_p = i$. By definition, one has $[\gamma_1] \perp z = p_{1*}(\gamma_1 \cdot p_1^*z)$. Because the cycle z is pseudo-effective, the cycle p_1^*z remains pseudo-effective as p_1 is a flat morphism. As γ_1 is a positive combination of products of ample Cartier divisors, we deduce that the cycle $\gamma_1 \cdot p_1^*z$ is pseudo-effective. Hence, $[\gamma_1] \perp z \in \text{Psef}_{n-l_1-l}(X)$. Iterating the same argument, we get that $\alpha \perp z \in \text{Psef}_{n-i-l}(X)$ as required.

(vi) The interior of $\text{Nef}^1(X)$ is equal to the ample cone of X so by definition :

$$\text{Int}(\text{Nef}^1(X)) \subset \text{BPF}^1(X).$$

As the closure of the ample cone is the nef cone by [Laz04, Theorem 1.4.21.(i)], one gets $\text{Nef}^1(X) \subset \text{BPF}^1(X)$. Conversely, the cone $\text{BPF}^1(X)$ is included in the cone $\text{Nef}^1(X)$, so we get $\text{BPF}^1(X) = \text{Nef}^1(X)$.

(iv) By linearity and stability by products, we are reduced to treat the case of a class $[D]$ induced by an ample Cartier divisor on Y_1 where $p_1 : Y_1 \rightarrow Y$ is a flat proper morphism, and prove that $q^*[D]$ is a limit of ample Cartier divisors on a flat variety over X . Let X_1 be the fibre product of Y_1 and X and let q' be the natural projection from X_1 to Y_1 , observe that $q^*[D]$ is induced by q'^*D which remains nef on X_1 as q' is proper. In particular, it is the limit of ample divisors on $\text{N}^1(X_1)$.

(i) Take $\alpha \in \text{BPF}^i(X)$ such that $-\alpha \in \text{BPF}^i(X)$. Then for all $z \in \text{Psef}_i(X)$, one has that $(\alpha \perp z) = 0$ as α is nef by (v). Since effective classes of dimension i generate $Z_i(X)$, it follows that $(\alpha \perp z) = 0$ for any $z \in \text{N}_i(X)_{\mathbb{R}}$ which implies by definition that $\alpha = 0$. This shows $\text{BPF}^i(X)$ is salient.

(ii) We show now that $\text{BPF}^i(X)$ contains product of ample divisors in its interior. To do so we prove that $\text{PL}^i(X) \subset \text{BPF}^i(X)$ for any integer $i \geq 1$.

For $i = 1$, $\text{BPF}^1(X) = \text{Nef}^1(X)$, and by definition, the divisor h is ample so it is in the interior of the nef cone and we are done. Take a globally generated vector bundle E of rank r on X and consider the induced morphism ϕ given by :

$$\phi : X \rightarrow \mathbb{G} = G(r, \mathbb{P}(H^0(X, E)^*)).$$

Since $\text{PL}^i(X) \supset \phi^* \text{PL}^i(\mathbb{G})$ and since these cones are preserved by pullbacks, we are then reduced to proving that $\text{PL}^i(\mathbb{G}) \subset \text{BPF}^i(\mathbb{G})$. Denote by $G = \text{PGL}(H^0(X, E)^*)$ the projective special orthogonal group of the vector space $H^0(X, E)^*$ and consider a class $\alpha \in \text{N}^i(\mathbb{G})_{\mathbb{R}}$. Since \mathbb{G} is smooth, $\psi_{\mathbb{G}} : \text{N}^i(\mathbb{G})_{\mathbb{R}} \rightarrow \text{N}_{n-i}(\mathbb{G})_{\mathbb{R}}$ is an isomorphism by Theorem 1.2.4.2 and α is represented by an effective cycle $z \in Z_{n-i}(\mathbb{G})_{\mathbb{R}}$.

Consider W the Zariski closure in $G \times \mathbb{G}$ given by :

$$W = \overline{\{(g, g \cdot x)\}_{g \in G, x \in z}} \subset G \times \mathbb{G}.$$

By construction, W is a quasi-projective scheme and the projection $p : W \rightarrow \mathbb{G}$ onto \mathbb{G} is a flat morphism. Denote by $q : W \rightarrow G$ the projection onto G . Fix H a very ample divisor on G and denote by M the dimension of the group $\mathrm{PGL}(H^0(X, E)^*)$. Then there exists an open embedding $j : W \rightarrow \mathbb{P}_{\mathbb{G}}^M$ such that one has the following diagram :

$$\begin{array}{ccccc} G & \longrightarrow & \mathbb{P}^M & \xleftarrow{h} & \mathbb{P}_{\mathbb{G}}^M \\ & \searrow q & & \nearrow j & \searrow \pi \\ & & W & \xrightarrow{p} & \mathbb{G} \end{array}$$

where $\pi : \mathbb{P}_{\mathbb{G}}^M \rightarrow \mathbb{G}$ is the projection onto \mathbb{G} and $h : \mathbb{P}_{\mathbb{G}}^M \rightarrow \mathbb{P}^M$ is the projection onto \mathbb{P}^M

By construction the general fiber of q over an element $g \in G$ is numerically equivalent to α and since we can choose H to be a hyperplane of \mathbb{P}^M , we have :

$$\frac{1}{(H^M)} p_* q^* H^M = \alpha \in N_{n-i}(\mathbb{G})_{\mathbb{R}}.$$

Moreover [Ful98, Proposition 1.7] implies that $p_* j^* = \pi_*$ in $Z_{n-i}(\mathbb{P}_{\mathbb{G}}^M)$, hence :

$$p_* q^* H^M = \pi_* h^* H^M = (H^M) \alpha \in N_{n-i}(\mathbb{G})_{\mathbb{R}}.$$

Since H is ample, $h^* H$ is nef and the class $h^* H^M$ belongs to $\mathrm{BPF}_{n-i}(\mathbb{P}_{\mathbb{G}}^M)$. Assertion (vii) thus implies that the class $\pi_* h^* H^M / (H^M) = \alpha$ belongs to $\mathrm{BPF}_{n-i}(\mathbb{G})_{\mathbb{R}}$, as required.

Since $\mathrm{PL}^i(X)$ has non-empty interior in $N^i(X)_{\mathbb{R}}$ by Theorem 1.3.2.2.(ii), we have proved (ii).

Let us prove that the cone $\mathrm{BPF}^i(X)$ is the smallest cone satisfying properties (iii), (vi) and (vii). Denote by BPF' the minimal cone satisfying these conditions. We have that $\mathrm{BPF}^i(X) \subset \mathrm{BPF}'(X)$ by minimality. Take $q : X_1 \rightarrow X$ a flat morphism of relative dimension e where X_1 is an equidimensional projective scheme and consider $\alpha \in \mathrm{IC}^{i+e}(X_1)$ a product of ample Cartier divisors on X_1 . Since $q_* : N^i(X_1)_{\mathbb{R}} \rightarrow N^{i-e}(X)_{\mathbb{R}}$ and since $\alpha \in \mathrm{BPF}^{i+e}(X_1)$, we have that $q_* \alpha \in \mathrm{BPF}^i(X)$ by (vii), hence $\mathrm{BPF}^i(X) \subset \mathrm{BPF}'(X)$ as required. \square

We recall Fulger-Lehmann's construction of the basepoint free cone. A class $\alpha \in N_{n-i}(X)_{\mathbb{R}}$ is strongly basepoint free if there is :

- an equidimensional quasi-projective scheme U of finite type over k ,
- a flat proper morphism $s : U \rightarrow X$
- and a proper morphism $p : U \rightarrow W$ of relative dimension $n - i$ to a quasi-projective scheme W such that each component of U surjects onto W

such that

$$s_{|F_p}([F_p]) = \alpha,$$

where $[F_p]$ is the fundamental class of a general fiber of p . We denote by $\mathrm{BPF}^i(X)$ the closure of the convex cone generated by strongly basepoint free classes in this sense. The cone $\mathrm{BPF}'(X)$ as above was defined by Fulger-Lehmann and they proved that this cone satisfies Theorem 1.3.3.3 when X is smooth ([FL14b, Theorem 1.7]). The following result proves that the cones $\mathrm{BPF}'(X)$ and $\mathrm{BPF}(X)$ are equal in this case.

Corollary 1.3.3.4. *Suppose X is smooth, then the cone $\mathrm{BPF}^i(X)$ is equal to the basepoint free cone $\mathrm{BPF}^i(X)$.*

Remark 1.3.3.5. Our construction of the cone $\text{BPF}(X)$ allows us to generalize Fulger-Lehmann's result for normal varieties. This improvement is due to the fact that we are able to pushforward dual numerical classes by flat morphism.

Proof. By [FL14b, Theorem 1.7], the cone $\text{BPF}'(X)$ satisfies the conditions of Theorem 1.3.3.3, hence $\text{BPF}^i(X) \subset \text{BPF}'^i(X)$. Let us prove the reverse inclusion $\text{BPF}'^i(X) \subset \text{BPF}^i(X)$. Take $p : U \rightarrow W$ a projective morphism onto an equidimensional quasi-projective variety W where U is a quasi-projective scheme and a flat map $s : U \rightarrow X$ such that $s_*[F_p] = \alpha$ where F_p is a general fiber of p . Take H_W an ample divisor on W , then the class α satisfies :

$$\alpha = s_* p^* H_W^{i+e} \in N_{n-i}(X)_{\mathbb{R}}.$$

Choose an ample divisor H on U , since the class $p^* H_W$ is nef, for any $\epsilon > 0$, the divisor $p^* H_W + \epsilon H$ is ample.

Since the morphism $s : U \rightarrow X$ is also quasi-projective and there exists an integer l (which depends on ϵ) such that the following diagram is commutative

$$\begin{array}{ccc} & \mathbb{P}_X^l & \\ f_\epsilon \nearrow & & \searrow \pi \\ U & \xrightarrow{s} & X \end{array}$$

where $f_\epsilon : U \rightarrow \mathbb{P}_X^l$ is an immersion induced by $p^* H_W + \epsilon H$ and $\pi : \mathbb{P}_X^l \rightarrow X$ is the flat projection onto X .

Let ξ be the relative class $c_1(\mathcal{O}_{\mathbb{P}_X^l}(1))$ on \mathbb{P}_X^l , then one has that for any cycle $z \in Z_i(X)_{\mathbb{R}}$:

$$((p^* H_W + \epsilon H)^{i+e} \cdot s^* z) = (\xi^{i+e} \cdot \pi^* z),$$

since $f_\epsilon^* \xi = p^* H_W + \epsilon H$. Hence, we obtain :

$$(s_*(p^* H_W + \epsilon H)^{i+e} \cdot z) = (\pi_* \xi^{i+e} \cdot z).$$

Since the class ξ^{i+e} is nef and since these cones are stable by flat pushforward, we have $\pi_*(\xi^{i+e}) \subset \text{BPF}^i(X)$. Taking the limit as $\epsilon \rightarrow 0$, we have that $s_*(p^* H_W + \epsilon H)^{i+e} \rightarrow \alpha = s_* p^* H_W^{i+e}$, hence $\alpha \in \text{BPF}^i(X)$ since each class $s_*(p^* H_W + \epsilon H)^{i+e} \in N^i(X)_{\mathbb{R}}$ belongs to $\text{BPF}^i(X)$. \square

We give here a detailed proof of the fact that the pseudo-effective cone is salient (see also [FL14b, Corollary 3.17]). The proof uses a useful proposition that we will use later on.

Proposition 1.3.3.6. *Let $\alpha \in \text{Psef}_{n-i}(X)$ be a pseudo-effective class on X and $\gamma \in \text{BPF}^{n-i}(X)$ be class lying in the interior of the basepoint free cone. Then we have $(\gamma \lrcorner \alpha) = 0$ if and only if $\alpha = 0$.*

Proof. Let us fix two basepoint free classes β and γ in $N^{n-i}(X)$, and a norm $\|\cdot\|$ on $N^{n-i}(X)_{\mathbb{R}}$. As γ is in the interior of $\text{BPF}^{n-i}(X)$ by Theorem 1.3.3.3.(ii), there exists a positive constant $C > 0$ such that for any $\beta \in \text{BPF}^{n-i}(X)$, one has :

$$C \|\beta\|_{N^{n-i}(X)_{\mathbb{R}}} \gamma - \beta \in \text{BPF}^{n-i}(X).$$

Intersecting with $\alpha \in \text{Psef}_{n-i}(X)$ and using Theorem 1.3.3.3.(v), we have that $(\beta \cdot \alpha) = 0$. Since the basepoint free cone $\text{BPF}^{n-i}(X)$ generates all $N^{n-i}(X)_{\mathbb{R}}$ by Theorem 1.3.3.3.(i), we have proved that $(\beta' \lrcorner \alpha) = 0$ for any $\beta' \in N^{n-i}(X)$, hence $\alpha = 0$ as required. \square

Corollary 1.3.3.7. *The pseudo-effective cone $\text{Psef}_{n-i}(X)$ is a closed, convex, full dimensional salient cone in $N_{n-i}(X)_{\mathbb{R}}$.*

Proof. We take $u \in \text{Psef}_{n-i}(X)$ such that $-u \in \text{Psef}_{n-i}(X)$, then for any ample Cartier divisor H_X on X , the products $(H_X^{n-i} \cdot u)$ and $(-u \cdot H_X^{n-i})$ are non-negative hence $(u \cdot H_X^{n-i}) = 0$. This implies that $u = 0$ by Proposition 1.3.3.6. \square

1.3.4 Siu's inequality in arbitrary codimension

We recall Siu's inequality :

Proposition 1.3.4.1. *([Laz04, Theorem 2.2.13]) Let V be a closed subscheme of dimension r in X and let A, B be two \mathbb{Q} -divisors nef on X such that $A|_V$ is big, then we have in $N_{i-1}(X)$,*

$$B \lrcorner [V] \leq \frac{r((A^{r-1} \cdot B) \lrcorner [V])}{(A^r \lrcorner [V])} A \lrcorner [V].$$

Remark 1.3.4.2. The case $V = X$ is a consequence of the bigness criterion given in [Laz04, Theorem 2.2.13], however we will need the result for possibly non-reduced subschemes of X .

Remark 1.3.4.3. The proof of the previous proposition implies that $B|_V \leq r(A^{r-1} \cdot B \lrcorner [V]) / (A^r \lrcorner [V]) \times A|_V$ in the Chow group $A^1(V)$. However, since we want to work in the numerical group, we compare these classes in X (we look at their pushforward by the inclusion of V in X).

Proof. The proof is the same as in [Laz04, Theorem 2.2.13], that is to find a section of the line bundle $\mathcal{O}_V(m(A - B))$. Up to some small perturbations of A and B of the form $A + \epsilon H$ and $B + \epsilon H$ of A and B where $\epsilon \rightarrow 0$, we can suppose that A and B are ample. Moreover, by taking a high multiple of A and B , we can suppose that they are also both very ample. Since B is very ample, we choose m general elements E_j of the linear system $|B|$ and consider the exact sequence :

$$0 \longrightarrow \mathcal{O}_V(mA - mB) \longrightarrow \mathcal{O}_V(mA) \longrightarrow \mathcal{O}_{\cup E_j}(mA) \longrightarrow 0.$$

Taking long exact sequence associated, one obtains the minoration :

$$h^0(V, \mathcal{O}_V(mA - mB)) \geq h^0(V, \mathcal{O}_V(mA)) - h^0(\cup_{j=1}^m E_j, \mathcal{O}_{\cup_{j=1}^m E_j}(mA)).$$

Observe that $[\cup E_j] = \sum_{j=1}^m [E_j] = mB \lrcorner [V]$. Applying [GGJ+16, Corollary 3.6.3] to the nef divisor A , we get $h^0(V, \mathcal{O}_V(mA)) = m^r / (r!) (A^r \lrcorner [V]) + o(m^r)$ and

$$h^0(\cup E_j, \mathcal{O}_{\cup_{j=1}^m E_j}(mA)) = \sum_{j=1}^m \frac{m^{r-1}}{(r-1)!} A^{r-1} \cdot B \lrcorner [V] + o(m^r).$$

Hence,

$$h^0(V, \mathcal{O}_V(mA - mB)) \geq \frac{m^r}{r!} (A^r - rA^{r-1} \cdot B) \lrcorner [V] + o(m^r).$$

In particular, this implies the required inequality. \square

The next result is a key for our approach to controlling degrees of dominant rational maps.

Theorem 1.3.4.4. *Let i be an integer and V be a closed subscheme of dimension r in X . For any Cartier divisors $\alpha_1, \dots, \alpha_i$ and β which are big and nef on V , then there exists a constant $C > 0$ depending only on r and i such that :*

$$(\alpha_1 \cdot \dots \cdot \alpha_i) \lrcorner [V] \leq (r - i + 1)^i \frac{(\alpha_1 \cdot \dots \cdot \alpha_i \cdot \beta^{r-i} \lrcorner [V])}{(\beta^r \lrcorner [V])} \times \beta^i \lrcorner [V] \in N_{r-i}(X).$$

Remark 1.3.4.5. Observe that $(\beta^n) > 0$ since β is big.

Proof. By continuity, we can suppose that α_i and β are ample Cartier divisors. We apply successively Siu's inequality by restriction to subschemes representing the classes $\alpha_2 \cdot \dots \cdot \alpha_i \llcorner [V]$, $\beta \cdot \alpha_3 \cdot \dots \cdot \alpha_i \llcorner [V]$, \dots , $\beta^{i-1} \cdot \alpha_i \llcorner [V]$:

$$\begin{aligned} \alpha_1 \cdot \alpha_2 \cdot \dots \cdot \alpha_i \llcorner [V] &\leq (r-i+1) \frac{(\alpha_1 \cdot \dots \cdot \alpha_i \cdot \beta^{r-i} \llcorner [V])}{(\beta^{r-i+1} \cdot \alpha_2 \cdot \dots \cdot \alpha_i \llcorner [V])} \times \beta \cdot \alpha_2 \cdot \dots \cdot \alpha_i \llcorner [V], \\ \beta \cdot \alpha_2 \cdot \dots \cdot \alpha_i \llcorner [V] &\leq (r-i+1) \frac{(\beta^{r-i+1} \cdot \alpha_2 \cdot \dots \cdot \alpha_i \llcorner [V])}{(\beta^{r-i+2} \cdot \alpha_3 \cdot \dots \cdot \alpha_i \llcorner [V])} \times \beta^2 \cdot \alpha_3 \cdot \dots \cdot \alpha_i \llcorner [V], \\ \dots &\dots \\ \beta^{i-1} \cdot \alpha_i \llcorner [V] &\leq (r-i+1) \frac{(\beta^{r-1} \cdot \alpha_i \llcorner [V])}{(\beta^r \llcorner [V])} \times \beta^i \llcorner [V]. \end{aligned}$$

This gives the required inequality :

$$\alpha_1 \cdot \dots \cdot \alpha_i \llcorner [V] \leq (n-i+1)^i \frac{(\alpha_1 \cdot \dots \cdot \alpha_i \cdot \beta^{r-i} \llcorner [V])}{(\beta^r \llcorner [V])} \times \beta^i \llcorner [V].$$

□

Corollary 1.3.4.6. *Let i be an integer, then for any $a \in \text{BPF}^i(X)$ and any big nef Cartier divisor β on X , one has :*

$$a \leq (n-i+1)^i \frac{(a \cdot \beta^{n-i})}{(\beta^n)} \times \beta^i.$$

Proof. By linearity and stability by product, we just need to prove the inequality for $a = D_1 \cdot \dots \cdot D_{e_1+i} \in \text{IC}^{e_1+i}(X_1)$, where D_i are ample Cartier divisors X_1 , where $p_1 : X_1 \rightarrow X$ is a flat proper morphism of relative dimension e_1 . We apply Theorem 1.3.4.4 to $a' = D_{e_1+1} \cdot \dots \cdot D_{e_1+i} \cdot Z$ and $\beta' = p_1^* \beta|_Z$ where $Z = D_1 \cdot \dots \cdot D_{e_1}$. We obtain :

$$a \leq (n-i+1)^i \frac{(a \cdot p_1^* \beta^{n-i})}{(p_1^* \beta^n \cdot Z)} \times p_1^* \beta^i \cdot Z.$$

As the restriction of p_1 on Z is generically finite, by the projection formula, we get :

$$a \leq (n-i+1)^i \frac{(a \cdot \beta^{n-i})}{(\beta^n)} \times \beta^i.$$

□

The previous inequality can be applied when we have positivity hypothesis on a birational model as follows.

Corollary 1.3.4.7. *Let X, Y be two normal projective varieties of dimension n . Let β be a class in $\text{BPF}^i(Y)$, we suppose there exists a birational morphism $q : X \rightarrow Y$ and an ample Cartier divisor A on X such that $A^i \leq q^* \beta$. Then there exists a class $\beta^* \in \text{N}_i(X)_{\mathbb{R}} \cap \text{Psef}_i(X)$ such that for any class $\alpha \in \text{BPF}^i(X)$, we have :*

$$\alpha \leq (\alpha \llcorner \beta^*) \times \beta.$$

Proof. We just have to set $\beta^* = \frac{(n-i+1)^i}{(A^n)} q_* \psi_X(A^{n-i})$.

□

Remark 1.3.4.8. We conjecture that for any basepoint free class $a \in \text{BPF}^i(X)$ and any big nef divisor b , one has

$$a \leq \binom{n}{i} \frac{(a \cdot b^{n-i})}{(b^n)} b^i. \quad (1.12)$$

One can show that this inequality (if true) is optimal since equality can happen when X is an abelian variety.

1.3.5 Norms on numerical classes

In this section, the positivity properties combined with Siu's inequality allows us to define some norms on $N_i(X)_{\mathbb{R}}$ and on $N^i(X)_{\mathbb{R}}$.

Norms on $N_i(X)_{\mathbb{R}}$

Let $i \leq n$ be an integer and let $\gamma \in \text{BPF}^i(X)$ be a basepoint free class on X . Any cycle $z \in N_i(X)_{\mathbb{R}}$ can be written $z = z^+ - z^-$ where z^+ and z^- are pseudo-effective. We define :

$$F_{\gamma}(z) := \inf_{\substack{z = z^+ - z^- \\ z^+, z^- \in \text{Psef}_i(X)}} \{(\gamma \cdot z^+) + (\gamma \cdot z^-)\}. \quad (1.13)$$

Proposition 1.3.5.1. *For any class $\gamma \in \text{BPF}^i(X)$ lying in the interior of the basepoint free cone, the function F_{γ} defines a norm on $N_i(X)_{\mathbb{R}}$. In particular, if we fix a norm $\|\cdot\|_{N_i(X)_{\mathbb{R}}}$ on $N_i(X)_{\mathbb{R}}$, there exists a constant $C > 0$ such that for any pseudo-effective class $z \in \text{Psef}_i(X)$, one has :*

$$\frac{1}{C} \|z\|_{N_i(X)_{\mathbb{R}}} \leq (\gamma \cdot z) \leq C \|z\|_{N_i(X)_{\mathbb{R}}}. \quad (1.14)$$

Proof. The only point to clarify is that $F_{\gamma}(z) = 0$ implies $z = 0$. Observe that Proposition 1.3.3.6 implies the result for $z \in \text{Psef}_i(X)$. In general, pick any two sequences $(z_p^+)_{p \in \mathbb{N}}$ and $(z_p^-)_{p \in \mathbb{N}}$ in $\text{Psef}_i(X)$ such that $z = z_p^+ - z_p^-$ and such that $\gamma \cdot z_p^+ + \gamma \cdot z_p^- \rightarrow 0$. Since z_p^+ and z_p^- are pseudo-effective and γ is basepoint free, it follows from Theorem 1.3.3.3.(v) that

$$\lim_{p \rightarrow +\infty} (\gamma \cdot z_p^+) = \lim_{p \rightarrow +\infty} (\gamma \cdot z_p^-) = 0.$$

As γ lies in the interior of $\text{BPF}^i(X)$, given any β in $\text{BPF}^i(X)$, one has that $C\gamma - \beta$ is still in $\text{BPF}^i(X)$ for some sufficiently large constant $C > 0$. Intersecting with the pseudo-effective classes z_p^+ and z_p^- and using Theorem 1.3.3.3.(v), we have $\lim_{p \rightarrow \infty} (\beta \cdot z_p^+) = \lim_{p \rightarrow \infty} (\beta \cdot z_p^-) = 0$, thus $(\beta \cdot z) = 0$. Since the basepoint free cone $\text{BPF}^i(X)$ generates all $N^i(X)$ by Theorem 1.3.3.3.(i), we conclude that $z = 0$ as required. \square

Norms on $N^i(X)_{\mathbb{R}}$

Definition 1.3.5.2. *We define the subcone $\text{BPF}_0^i(X)$ of $\text{BPF}^i(X)$ as the classes $\alpha \in \text{BPF}^i(X)$ such that for any birational map $q : X' \rightarrow X$, there exists an ample Cartier divisor A on X' such that $q^*\alpha \geq A^i$.*

Proposition 1.3.5.3. *When X is smooth, the cone $\text{BPF}_0^1(X)$ is equal to the big nef cone. In particular BPF_0^i is neither closed nor open in general.*

Proof. Take $\alpha \in N^1(X)_{\mathbb{R}}$ a big nef divisor. Then for any birational map $q : X' \rightarrow X$ and any ample Cartier divisor A , one has by Theorem 1.3.4.4 applied to A and $q^*\alpha$:

$$A \leq n \frac{(A \cdot q^*\alpha^{n-1})}{(\alpha^n)} q^*\alpha.$$

Hence, $\alpha \in \text{BPF}_0^1(X)$. Conversely, take a class $\alpha \in \text{BPF}_0^1(X)$, then there exists an ample divisor A on X such that $\alpha \geq A$. Since ample divisors are big, we have that α is big. Moreover, since $\text{BPF}^1(X) = \text{Nef}^1(X) \cap \text{Psef}^1(X)$, we have that α is big and nef as required. \square

Proposition 1.3.5.4. *The cone $\text{BPF}_0^i(X)$ is a convex open subset of $\text{BPF}^i(X)$ that contains the classes induced by products of big nef divisors.*

Proof. The cone $\text{BPF}_0^i(X)$ contains the products of big and nef Cartier divisors. The fact that $\text{BPF}_0^i(X)$ is convex is a consequence of Siu's inequality. We take two elements α and β in $\text{BPF}_0^i(X)$ and any birational map $q : X' \rightarrow X$. By definition, there exists some ample Cartier divisors A and B on X' such that $q^*\alpha \geq A^i$ and $q^*\beta \geq B^i$. As A and B are ample, there is a constant $C > 0$ such that $A^i \geq C B^i$ using the generalization of Siu's inequality (Theorem 1.3.4.4). This proves that $q^*(t \times \alpha + (1-t) \times \beta) \geq (tC + (1-t)) \times B^i$ for any $t \in [0, 1]$. Hence $t \times \alpha + (1-t) \times \beta \in \text{BPF}_0^i(X)$ and the cone $\text{BPF}_0^i(X)$ is convex.

We prove that $\text{BPF}_0^i(X)$ is an open subset of $\text{BPF}^i(X)$. We take $\alpha \in \text{BPF}_0^i(X)$. We take any ample Cartier divisor H_X on X such that $\alpha - tH_X^i$ is in $\text{BPF}^i(X)$ for small $t > 0$. We just need to show that $\alpha - tH_X^i$ stays in $\text{BPF}_0^i(X)$ when t is small enough. Let $q : X' \rightarrow X$ be a birational map where X' is projective and normal. By definition of α , there exists an ample Cartier divisor A on X' such that $q^*\alpha \geq A^i$. By Siu's inequality, there exists a constant C such that :

$$q^*H_X^i \leq C \frac{(A^i \cdot q^*H_X^{n-i})}{(H_X^n)} \times A^i.$$

This implies the inequality :

$$q^*\beta - tq^*H_X^i \geq \left(1 - tC \frac{A^i \cdot H_X^{n-i}}{H_X^n}\right) \times A^i. \quad (1.15)$$

As $A^i \leq q^*\alpha$, we have the following upper bound :

$$(A^i \cdot H_X^{n-i}) \leq (q^*\alpha \cdot q^*H_X^{n-i}).$$

We get the following minoration which depends only on α and H_X :

$$1 - t \frac{C(\alpha \cdot H_X^{n-i})}{(H_X^n)} \leq 1 - t \frac{C(A^i \cdot H_X^{n-i})}{(H_X^n)}. \quad (1.16)$$

Using (1.15) and (1.16), one gets that for $t < \frac{(H_X^n)}{C(\alpha \cdot H_X^{n-i})}$, the class $\alpha - tH_X^i$ is in $\text{BPF}_0^i(X)$. \square

Remark 1.3.5.5. The cone $\text{BPF}_0^i(X)$ is not always equal to the cone generated by complete intersections. Following [LX15b, Example 9.6], there exists a smooth toric threefold such that the cone generated by complete intersections in $N_1(X)_{\mathbb{R}}$ is not convex, so it cannot be equal to $\text{BPF}_0^2(X)$ using the following proposition.

Let X be a normal projective variety of dimension n . Any class $\alpha \in N^i(X)_{\mathbb{R}}$ can be decomposed as $\alpha^+ - \alpha^-$ where α^+ and α^- are basepoint free classes. For any $\gamma \in \text{BPF}_0^{n-i}(X)$, we define the function :

$$G_\gamma(\alpha) := \inf_{\substack{\alpha = \alpha^+ - \alpha^- \\ \alpha^+, \alpha^- \in \text{BPF}^i(X)}} \{(\gamma \cdot \alpha^+) + (\gamma \cdot \alpha^-)\}. \quad (1.17)$$

Proposition 1.3.5.6. *For any $\gamma \in \text{BPF}_0^{n-i}(X)$, the function G_γ defines a norm on $N^i(X)_{\mathbb{R}}$. In particular, for any norm $\|\cdot\|_{N^i(X)_{\mathbb{R}}}$ on $N^i(X)_{\mathbb{R}}$, there is a constant $C > 0$ such that for any class $\alpha \in \text{BPF}^i(X)$:*

$$\frac{1}{C} \|\alpha\|_{N^i(X)_{\mathbb{R}}} \leq (\gamma \cdot \alpha) \leq C \|\alpha\|_{N^i(X)_{\mathbb{R}}}.$$

Proof. The only fact which is not immediate is the fact that $G_\gamma(\alpha) = 0$ implies $\alpha = 0$. We are reduced to treat the case where $\alpha \in \text{BPF}^i(X)$.

Suppose first that X is smooth. Since γ belongs to the interior of the basepoint free cone by Proposition 1.3.5.4, one has that for any basepoint free class $\beta \in \text{BPF}^{n-i}(X)$, there exists a constant $C > 0$ such that :

$$C\|\beta\|\gamma - \beta \in \text{BPF}^{n-i}(X).$$

In particular, since α is nef, one has :

$$0 = G_\gamma(\alpha) = C\|\beta\|(\gamma \cdot \alpha) \geq (\beta \cdot \alpha) \geq 0.$$

Hence $(\beta \cdot \alpha) = 0$ for any basepoint free class $\beta \in \text{BPF}^{n-i}(X)$ and $\alpha = 0 \in \text{N}^i(X)_\mathbb{R}$ since the basepoint free cone generates all $\text{N}^{n-i}(X)_\mathbb{R}$ by Theorem 1.3.3.3.(i).

Suppose that X is not smooth. Fix an ample Cartier divisor H_X on X . Take an alteration $\pi : X' \rightarrow X$ of X . Since the morphism $\pi^* : \text{N}^i(X)_\mathbb{R} \rightarrow \text{N}^i(X')_\mathbb{R}$ is injective, we are reduced to prove that $\pi^*\alpha = 0$. Consider $\beta \in \text{BPF}^{n-i}(X)$, we have by the projection formula that :

$$(\pi^*\gamma \cdot \pi^*\alpha) = (\alpha \cdot \gamma).$$

Since γ belongs to the interior of the basepoint free cone, there exists a constant $C > 0$ such that :

$$H_X^{n-i} \leq C\gamma.$$

In particular, this implies that :

$$(\pi^*H_X^{n-i} \cdot \pi^*\alpha) = (H_X^{n-i} \cdot \alpha) = 0.$$

Since π^*H_X is a big nef Cartier divisor, the class $\pi^*H_X^{n-i}$ belongs to $\text{BPF}_0^{n-i}(X')$ by Proposition 1.3.5.4, hence $\pi^*\alpha = 0$ by the previous argument. □

Remark 1.3.5.7. In fact, the above proof gives a stronger statement : for any generically finite morphism $q : X' \rightarrow X$ and any $\gamma \in \text{BPF}_0^{n-i}(X)$, the function $G_{q^*\gamma}$ defines a norm on $\text{N}^i(X')_\mathbb{R}$.

1.4 Relative numerical classes

1.4.1 Relative classes

In this section, we fix $q : X \rightarrow Y$ a surjective proper morphism between normal projective varieties where $\dim X = n$, $\dim Y = l$ and we denote by $e = \dim X - \dim Y$ the relative dimension of q .

Definition 1.4.1.1. *The abelian group $\text{N}_i(X/Y)$ is the subgroup of $\text{N}_i(X)$ generated by classes of subvarieties V of X such that the image $q(V)$ is a point in Y .*

Observe that by definition, there is a natural injection from $\text{N}_i(X/Y)$ into $\text{N}_i(X)$:

$$0 \longrightarrow \text{N}_i(X/Y) \longrightarrow \text{N}_i(X).$$

Definition 1.4.1.2. *The abelian group $\text{N}^i(X/Y)$ is the quotient of $Z^i(X)$ by the equivalence relation \equiv_Y where $\alpha \equiv_Y 0$ if for any cycle $z \in Z_i(X)$ whose image by q is a collection of points in Y , we have $(\alpha \frown z) = 0$.*

Therefore, one has the following exact sequence :

$$N^i(X) \longrightarrow N^i(X/Y) \longrightarrow 0.$$

As before, we write $N_i(X/Y)_{\mathbb{R}} = N_i(X/Y) \otimes_{\mathbb{Z}} \mathbb{R}$, $N^i(X/Y)_{\mathbb{R}} = N^i(X/Y) \otimes \mathbb{R}$, $N_{\bullet}(X/Y) = \bigoplus N_i(X/Y)$ and $N^{\bullet}(X/Y) = \bigoplus N^i(X/Y)$.

Proposition 1.4.1.3. *The abelian groups $N_i(X/Y)$ and $N^i(X/Y)$ are torsion free and of finite type. Moreover, the pairing $N_i(X/Y)_{\mathbb{Q}} \times N^i(X/Y)_{\mathbb{Q}} \rightarrow \mathbb{Q}$ induced by the pairing $N_i(X)_{\mathbb{Q}} \times N^i(X)_{\mathbb{Q}} \rightarrow \mathbb{Q}$ is perfect.*

Proof. Since $N_i(X/Y)$ is a subgroup of $N_i(X)$, it is torsion free and of finite type. The group $N^i(X/Y)$ is also torsion free. Indeed pick $\alpha \in Z^i(X)$ such that $p\alpha \equiv_Y 0$ for some integer p , then for any cycle z whose image by q is a union of points, we have $(p\alpha \lrcorner z) = p(\alpha \lrcorner z) = 0$ hence $\alpha \equiv_Y 0$. Finally, since there is a surjection from $N^i(X)$ to $N^i(X/Y)$, the group $N^i(X/Y)$ is also of finite type.

Let us show that the pairing is well defined and non degenerate. Take a cycle $z \in Z_i(X)_{\mathbb{Q}}$ such that $q(z)$ is a finite number of points in Y , then if $\alpha \in N^i(X)$ such that its image is 0 in $N^i(X/Y)$, then $(\alpha \lrcorner z) = 0$ and the pairing $N^i(X/Y) \times N_i(X/Y) \rightarrow \mathbb{Z}$ is well-defined. Let us suppose that for any $\alpha \in N^i(X/Y)_{\mathbb{Q}}$, $(\alpha \lrcorner z) = 0$. This implies that for any $\beta \in N^i(X)$, the intersection product $(\beta \lrcorner z) = 0$, thus $z \equiv 0$. Conversely, suppose that $(\alpha \lrcorner z) = 0$ for any $z \in N_i(X/Y)$, then by definition $\alpha \equiv_Y 0$. □

Example 1.4.1.4. When Y is a point, we have $N_i(X/Y) = N_i(X)$ and $N^i(X/Y) = N^i(X)$.

Example 1.4.1.5. If the morphism $q : X \rightarrow Y$ is finite, then we have $N^0(X/Y)_{\mathbb{Q}} = N_0(X/Y)_{\mathbb{Q}} = \mathbb{Q}$ and $N^i(X/Y) = N_i(X/Y) = \{0\}$ for $i \geq 1$ since X is irreducible.

Example 1.4.1.6. When $i = 1$, the group $N_1(X/Y)$ is generated by curves contracted by q so that $N^1(X/Y)$ is the relative Neron-Severi group and its dimension is the relative Picard number (see [?]).

Remark 1.4.1.7. When i is greater than the relative dimension, the relative classes might not be trivial. For example if $q : X \rightarrow Y$ is a birational map, then $e = 0$ but the space $N^1(X/Y)_{\mathbb{R}}$ is generated by classes of exceptional divisors of q .

Proposition 1.4.1.8. *The intersection product on $N^{\bullet}(X)$ induces a structure of algebra on $N^{\bullet}(X/Y)$. Moreover, the action from $N^{\bullet}(X)$ on $N_{\bullet}(X)$ induces an action from $N^{\bullet}(X/Y)$ on $N_{\bullet}(X/Y)$, so that the vector space $N_{\bullet}(X/Y)_{\mathbb{R}}$ becomes a $N^{\bullet}(X/Y)_{\mathbb{R}}$ -module.*

Proof. Observe that if $z \in Z_i(X)$ such that $q(z)$ is a union of points in Y and $\alpha \in N^l(X)$, then $\alpha \lrcorner z$ lies in $N_{i-l}(X/Y)$. Indeed, by definition, the class $\alpha \lrcorner z$ is represented by a cycle supported in z , so its image by q is a collection of points in Y .

Let us now prove that the product is well-defined in $N^{\bullet}(X/Y)$. Take $\alpha \in N^i(X)$ such that $\alpha = 0$ in $N^i(X/Y)$ and $\beta \in N^l(X)$, we must prove that $\alpha \cdot \beta = 0$ in $N^i(X/Y)$. Pick a cycle $z \in Z_{i+l}(X)$ whose image by q is a collection of points, by the properties of the intersection product, $((\alpha \cdot \beta) \lrcorner z) = (\alpha \lrcorner (\beta \lrcorner z))$. As $\beta \lrcorner z$ is in $N_i(X/Y)$, we get that $((\alpha \cdot \beta) \lrcorner z) = 0$ as required. □

As an illustration, we give an explicit description of these groups in a particular example.

Proposition 1.4.1.9. *Suppose $q : X = \mathbb{P}(E) \rightarrow Y$ where E is a vector bundle of rank $e + 1$ on Y . Then for any integer $0 \leq i \leq e$, one has :*

$$\begin{aligned} N_i(X/Y)_{\mathbb{Q}} &= \mathbb{Q} \xi^{e-i} \lrcorner q^*[pt], \\ N^i(X/Y)_{\mathbb{Q}} &= \mathbb{Q} \xi^i, \end{aligned}$$

where $\xi = c_1(\mathcal{O}_{\mathbb{P}(E)}(1))$.

Proof. Since the pairing $N^i(X/Y)_{\mathbb{Q}} \times N_i(X/Y)_{\mathbb{Q}} \rightarrow \mathbb{Q}$ is non degenerate and since $(\xi^i \lrcorner (\xi^{e-i} \lrcorner q^*[pt])) = 1$, the second equality is an immediate consequence of the first one. We suppose first that $i > 0$. Pick $\alpha \in Z_i(X)$ which defines a class in $N_i(X/Y)_{\mathbb{Q}}$. Using [Ful98, Theorem 3.3.(b)], α is rationally equivalent to $\sum_{e-i \leq j \leq e} \xi^j \lrcorner q^* \alpha_j$ where α_j is an element of the Chow group $A_{i-e+j}(Y)_{\mathbb{Q}}$. Since the image of α by q is a union of points in Y , we have that $q_* \alpha = 0$ in $A_i(Y)_{\mathbb{Q}}$. Observe that

$$q_*(\xi^e \lrcorner q^* \alpha_e) = \alpha_e,$$

and that for any $j < e$, one has that

$$q_*(\xi^j \lrcorner q^* \alpha_j) = 0$$

since the support of the cycle α_i is of dimension $i - e + j < i$ and $q_*(\xi^e \lrcorner q^* \alpha_j)$ belongs to $A_i(Y)$. Hence the conditions $q_* \alpha = 0$ implies that $\alpha_e = 0$ in $A_i(Y)_{\mathbb{Q}}$. Since $\xi^j \lrcorner \alpha$ defines also a class in $N_{i-j}(X/Y)_{\mathbb{Q}}$, this implies also that $\alpha_{e-j} = 0$ in $A_{i-e+j}(Y)_{\mathbb{Q}}$ for any $j < i$. We have finally that in $N_i(X/Y)_{\mathbb{Q}}$:

$$\alpha = \xi^{e-i} \lrcorner q^* \alpha_{e-i}.$$

Since α_{e-i} belongs to $A_0(Y)_{\mathbb{Q}}$ and $N_0(Y) = \mathbb{Q}[pt]$, the \mathbb{Q} -module $N_i(X/Y)$ is generated by $\xi^{e-i} \lrcorner q^*[pt]$ for $i > 0$.

For $i = 0$, the groups $N_0(X)_{\mathbb{Q}}$ and $N_0(X/Y)_{\mathbb{Q}}$ are isomorphic to \mathbb{Q} , so we get the desired conclusion. □

1.4.2 Pullback and pushforward

In this section, we fix any two (proper) surjective morphisms $q_1 : X_1 \rightarrow Y_1$, $q_2 : X_2 \rightarrow Y_2$ between normal projective varieties. To simplify the notation, we write $X_1/q_1 Y_1 \xrightarrow{f} X_2/q_2 Y_2$ when we have two regular maps $f : X_1 \rightarrow X_2$ and $g : Y_1 \rightarrow Y_2$ such that $q_2 \circ f = g \circ q_1$ and we shall say that $X_1/q_1 Y_1 \xrightarrow{f} X_2/q_2 Y_2$ is a morphism. When $f : X_1 \dashrightarrow X_2$ and $g : Y_1 \dashrightarrow Y_2$ are merely rational maps, then we write $X_1/q_1 Y_1 \dashrightarrow X_2/q_2 Y_2$ and we shall call it a rational map.

Proposition 1.4.2.1. *Let $X_1/q_1 Y_1 \xrightarrow{f} X_2/q_2 Y_2$ be a morphism. Then the morphism of abelian groups $f_* : N_i(X_1) \rightarrow N_i(X_2)$ induces a morphism of abelian groups $f_* : N_i(X_1/Y_1) \rightarrow N_i(X_2/Y_2)$.*

Proof. Take a cycle $z \in Z_i(X_1)$ such that $q_1(z)$ is a union of points of Y_1 . Then the image of the cycle z by $q_2 \circ f$ is also a union of points of Y_2 due to the fact that $q_2 \circ f = g \circ q_1$. Hence f_* maps $N_i(X_1/Y_1)$ to $N_i(X_2/Y_2)$. □

Proposition 1.4.2.2. *Let $X_1/q_1 Y_1 \xrightarrow{f} X_2/q_2 Y_2$ be a morphism. Then the morphism of graded rings $f^* : N^\bullet(X_1) \rightarrow N^\bullet(X_2)$ induces a morphism of graded rings $f^* : N^\bullet(X_1/Y_1)_{\mathbb{Q}} \rightarrow N^\bullet(X_2/Y_2)_{\mathbb{Q}}$.*

Proof. This results follows immediately by duality from the previous proposition since the pairing $N^i(X_i/Y_i)_{\mathbb{Q}} \times N_i(X_i/Y_i)_{\mathbb{Q}} \rightarrow \mathbb{Q}$ is non degenerate. □

1.4.3 Restriction to a general fiber and relative canonical morphism

Recall that $\dim X = n$, $\dim Y = l$ and that the relative dimension of $q : X \rightarrow Y$ is e .

Proposition 1.4.3.1. *There exists a unique class $\alpha_{X/Y} \in N^l(X)_{\mathbb{Q}}$ satisfying the following conditions.*

1. *The image $\psi_X(\alpha_{X/Y})$ belongs to the subspace $N_e(X/Y)_{\mathbb{Q}}$ of $N_e(X)_{\mathbb{Q}}$.*
2. *For any class $\beta \in N_l(X)_{\mathbb{Q}}$, $q_*\beta = (\alpha_{X/Y} \frown \beta) [Y]$.*

Moreover, for any open subset V of Y such that the restriction q to $U = q^{-1}(V)$ is flat, and for all $y \in V$ and any irreducible component F of the scheme-theoretic fiber X_y , we have :

$$\psi_X(\alpha_{X/Y}) = [X_y] = r[F],$$

where r is a rational number which only depends on F and where $[X_y]$ (resp. $[F]$) denotes the fundamental class of X_y (resp. F) viewed as an element of $N_e(X/Y)$.

More explicitly, the class $\alpha_{X/Y}$ is given by

$$\alpha_{X/Y} = \frac{1}{(H_Y^l)} q^* H_Y^l \in N^l(X/Y)_{\mathbb{Q}},$$

where H_Y is an ample divisor on Y .

Remark 1.4.3.2. Recall that by generic flatness (see [FGI⁺05, Theorem 5.12]), one can always find an open subset V of Y such that the restriction of q to $q^{-1}(V)$ is flat over V .

Proof. Fix an ample Cartier divisor H_Y on Y , we set

$$\alpha_{X/Y} := \frac{1}{(H_Y^l)} q^* H_Y^l \in N^l(X)_{\mathbb{Q}}.$$

Write the class H_Y^l in $A_0(Y)$ as :

$$H_Y^l = \sum a_j [p_j] \tag{1.18}$$

where $p_j \in V(k)$ are points in V and a_j are positive integers satisfying $\sum a_j = (H_Y^l)$. By the projection formula (Theorem 1.2.3.2.(iv)), the class $\alpha_{X/Y}$ satisfies (i) and (ii). Let us show that any class satisfying (i) and (ii) is unique. Suppose there is another one $\alpha' \in N^l(X)_{\mathbb{Q}}$. Then for any class $\beta \in N_l(X)_{\mathbb{Q}}$, $((\alpha_{X/Y} - \alpha') \frown \beta) = 0$ so that $\alpha = \alpha'$ since the pairing $N^l(X)_{\mathbb{Q}} \times N_l(X)_{\mathbb{Q}} \rightarrow \mathbb{Q}$ is non degenerate.

Let us prove the last assertion. By generic flatness [FGI⁺05, Theorem 5.12], Let V be an open subset of Y such that the restriction $q|_{q^{-1}(V)} : q^{-1}(V) \rightarrow V$ is flat and such that the dimension of every fiber is e . Since H_Y is ample, we can find some hyperplanes of $H_i \subset Y$ such that $H_1 \cap \dots \cap H_l$ represents the class H_Y^l and such that $H_1 \cap \dots \cap H_l \subset V$. In particular, by [Ful98, Proposition 2.3.(d)], the pullback $q^* H_Y^l$ is represented by a cycle in the fiber of $H_1 \cap \dots \cap H_l$. Denote by $u : V \rightarrow Y$ and $g : U \rightarrow X$ the inclusion maps of V and U into Y and X respectively. The morphisms u and g are open embedding hence are flat. Moreover we have the following commutative diagram.

$$\begin{array}{ccc} U & \xrightarrow{u} & X \\ \downarrow q|_U & & \downarrow q \\ V & \xrightarrow{g} & Y \end{array}$$

Using [Ful98, Example 2.4.2], one has that for any $\beta \in A_l(X)$:

$$(q^* H_Y^l \frown \beta) = (q|_U^* g^* (H_Y^l) \frown u^* \beta).$$

Using (1.18), one obtains in $A_e(X)$:

$$q_{|U}^* g^* H_Y^l = q_{|U}^* g^* \left(\sum a_j [p_j] \right) = \sum a_j [q^{-1}(p_j)],$$

which is well-defined since the restriction of q on U is flat. By [Ful98, Theorem 10.2], we have that $[X_{p_j}] = [X_y] \in N_e(X)$ for any $p_j, y \in V$. In particular, we have :

$$\psi_X(q^* H_Y^l) = \left(\sum a_j \right) [X_y] = (H_Y^l) [X_y] \in N_e(X),$$

where y is a point in V , which proves that $\psi_X(\alpha_{X/Y}) = [X_y]$ in $N_e(X)_{\mathbb{Q}}$ for any point y in V . By the Stein factorization theorem, there exists a morphism $q' : X \rightarrow Y'$ with connected fibres and a finite morphism $f : Y' \rightarrow Y$ such that $q' = q \circ f$. Since $(H_Y^l) [X_y] = q^* H_Y^l = q'^* f^* H_Y^l$ and since $f^* H_Y^l \in N^l(Y')_{\mathbb{R}}$ which is canonically isomorphism to \mathbb{R} , we have that $f^* H_Y^l = p \cdot [y'] \in N^l(Y')_{\mathbb{R}}$ where p is an integer and where $[y']$ is a general point in $f^{-1}(y)$. We have thus proven that :

$$[X_y] = \frac{p}{(H_Y^l)} [q'^{-1}(y')] \in N_e(X),$$

and $q'^{-1}(y')$ is an irreducible component of X_y as required. \square

The class previously constructed allows us to define a restriction morphism.

Definition 1.4.3.3. *Suppose that $\dim Y = l$ and that H_Y is an ample Cartier divisor on Y , then we define $\text{Res}_{X/Y} : N_{\bullet}(X)_{\mathbb{Q}} \rightarrow N_{\bullet-l}(X/Y)_{\mathbb{Q}}$ by setting :*

$$\text{Res}_{X/Y}(\beta) := \frac{1}{(H_Y^l)} q^* H_Y^l \lrcorner \beta = \alpha_{X/Y} \lrcorner \beta.$$

This morphism does not depend on the choice of H_Y .

We shall denote by $\text{Res}_{X/Y}^* : \beta \in N^{\bullet}(X/Y)_{\mathbb{Q}} \rightarrow \alpha_{X/Y} \cdot \beta \in N^{\bullet+l}(X)_{\mathbb{Q}}$ the dual morphism induced by $\text{Res}_{X/Y}$ with respect to the pairing $N^{\bullet}(X/Y)_{\mathbb{Q}} \times N_{\bullet}(X/Y)_{\mathbb{Q}} \rightarrow \mathbb{Q}$.

Proposition 1.4.3.4. *Recall that $\dim Y = l$. The following properties are satisfied.*

1. *For any class $\alpha \in N^{\bullet}(X)_{\mathbb{Q}}$, one has :*

$$\psi_X \circ \text{Res}_{X/Y}^*(\alpha) = \text{Res}_{X/Y} \circ \psi_X(\alpha).$$

2. *For any morphism $X'/_q Y' \xrightarrow[f]{g} X/_q Y$ where $\dim X' = \dim X = n$ and $\dim Y' = \dim Y = l$ such that the topological degree of g is d , we have for any $\alpha \in N^{i-l}(X/Y)_{\mathbb{Q}}$:*

$$d \times \text{Res}_{X'/Y'}^* \circ f^* \alpha = f^* \circ \text{Res}_{X/Y}^* \alpha.$$

The definition of the restriction morphism gives a natural way to generalize the definition of the canonical morphism $\psi_X : N^i(X) \rightarrow N_{n-i}(X)$ to the relative case.

Definition 1.4.3.5. *Recall that the relative dimension of the morphism $q : X \rightarrow Y$ is e . For any integer $i \geq 0$, we define the canonical morphism $\psi_{X/Y}$ by :*

$$\psi_{X/Y} := \psi_X \circ \text{Res}_{X/Y}^* : \beta \in N^i(X/Y)_{\mathbb{Q}} \rightarrow \psi_X(\alpha_{X/Y} \cdot \beta) \in N_{e-i}(X/Y)_{\mathbb{Q}}.$$

Remark 1.4.3.6. When $i > e$ by convention the map $\psi_{X/Y}$ is zero.

We give here a situation where this map is an isomorphism.

Proposition 1.4.3.7. *Suppose $q : X \rightarrow Y$ is a smooth morphism of relative dimension e , then for any integer $0 \leq i \leq e$, the map $\psi_{X/Y} : N^i(X/Y)_{\mathbb{Q}} \rightarrow N_{e-i}(X/Y)_{\mathbb{Q}}$ is an isomorphism.*

Proof. Since the pairing $N^i(X/Y)_{\mathbb{Q}} \times N_i(X/Y)_{\mathbb{Q}} \rightarrow \mathbb{Q}$ is perfect by Proposition 1.4.1.3, we have that the dual morphism $\psi_{X/Y}^* : N^{e-i}(X/Y)_{\mathbb{Q}} \rightarrow N_i(X/Y)_{\mathbb{Q}}$ of $\psi_{X/Y}$ is surjective whenever $\psi_{X/Y} : N^i(X/Y)_{\mathbb{Q}} \rightarrow N_{e-i}(X/Y)_{\mathbb{Q}}$ is injective. We are thus reduced to prove the injectivity of $\psi_{X/Y} : N^i(X/Y)_{\mathbb{Q}} \rightarrow N_{e-i}(X/Y)_{\mathbb{Q}}$. Take $a \in N^i(X/Y)_{\mathbb{Q}}$ such that $\psi_{X/Y}(a) = 0$, and choose a class $\alpha \in N^i(X)_{\mathbb{Q}}$ representing a . We fix a subvariety V of dimension i in a fiber X_y of q where y is a point in Y . We need to prove that $(\alpha \lrcorner [V]) = 0$.

By Proposition 1.4.3.1, the condition $\psi_{X/Y}(\alpha) = 0$ implies that :

$$\alpha \lrcorner [X_y] = 0 \in N_{e-i}(X)_{\mathbb{Q}}.$$

As the morphism $q : X \rightarrow Y$ is smooth, the fiber X_y over y is smooth. By Theorem 1.2.4.2, there exists a class $\beta \in N^{e-i}(X_y)_{\mathbb{Q}}$ such that :

$$\beta \lrcorner [X_y] = [V].$$

In particular, we get :

$$(\alpha \lrcorner [V]) = (\alpha \lrcorner (\beta \lrcorner [X_y])) = (\beta \lrcorner (\alpha \lrcorner [X_y])) = 0$$

as required. □

Example 1.4.3.8. If $X = \mathbb{P}(E)$ where E is a vector bundle on Y , then Proposition 1.4.1.9 implies that $\psi_{X/Y} : N^i(X/Y)_{\mathbb{Q}} \rightarrow N_{e-i}(X/Y)_{\mathbb{Q}}$ is an isomorphism for any integer $0 \leq i \leq e$.

Example 1.4.3.9. If X is the blow-up of $\mathbb{P}^1 \times \mathbb{P}^1$ at a point and q is the projection from $\mathbb{P}^1 \times \mathbb{P}^1$ to the first component $Y = \mathbb{P}^1$ composed with the blow-down from X to $\mathbb{P}^1 \times \mathbb{P}^1$. Then the morphism $\psi_{X/Y} : N^0(X/Y)_{\mathbb{Q}} \rightarrow N_1(X/Y)_{\mathbb{Q}}$ is not surjective and $\psi_{X/Y} : N^1(X/Y)_{\mathbb{Q}} \rightarrow N_0(X/Y)_{\mathbb{Q}}$ is not injective.

1.5 Application to dynamics

In this section, we shall consider various normal projective varieties X_j and Y_j respectively of dimension n and l and we write $e = n - l$. Recall from Section 1.4.2 that the notation $X_j/q_j Y_j$ means that $q_j : X_j \rightarrow Y_j$ is a surjective morphism of relative dimension e and that $X/q Y \xrightarrow[f]{g} X'/q' Y'$ means that $f : X \dashrightarrow X'$ and $g : Y \dashrightarrow Y'$ are dominant rational maps such that $q' \circ f = g \circ q$. We shall also fix H_{X_j} and H_{Y_j} big and nef Cartier divisors on X_j and Y_j respectively.

In this section we prove Theorem 1 and Theorem 2. They will follow from Theorem 1.5.2.1 and Theorem 1.5.3.2 respectively.

1.5.1 Degrees of rational maps

Definition 1.5.1.1. *Let us consider a rational map $X_1/q_1 Y_1 \xrightarrow[f]{g} X_2/q_2 Y_2$ and let Γ_f (resp. Γ_g) be the normalization of the graph of f (resp. g) in $X_1 \times X_2$ (resp. $Y_1 \times Y_2$). We denote by $\tilde{\Gamma}_f$ the normalization of the graph of the map induced by $q \circ f$ from Γ_f to Γ_g , we thus have the*

following diagram.

$$\begin{array}{ccc}
 & \tilde{\Gamma}_f & \\
 \pi_1 \swarrow & & \searrow \pi_2 \\
 X_1 & \overset{f}{\dashrightarrow} & X_2 \\
 q_1 \downarrow & & \downarrow q_2 \\
 Y_1 & \overset{g}{\dashrightarrow} & Y_2 \\
 \swarrow \pi'_1 & & \searrow \pi'_2 \\
 & \Gamma_g &
 \end{array}$$

The i -th relative degree of f is defined by the formula :

$$\text{reldeg}_i(f) := (\pi_1^*(H_{X_1}^{e-i} \cdot (q_1^* H_{Y_1})^l) \cdot \pi_2^*(H_{X_2})^i).$$

When Y_1 and Y_2 are reduced to a point, we simply write $\text{deg}_i(f) = \text{reldeg}_i(f)$.

Remark 1.5.1.2. If $e = 0$, then $\text{reldeg}_i(f) = (q_1^* H_{Y_1}^l)$ if $i = 0$ and $\text{reldeg}_i(f) = 0$ for $i > 0$.

Remark 1.5.1.3. Observe that in the above diagram, the $\varpi : \tilde{\Gamma}_f \rightarrow \Gamma_g$ is a regular surjective morphism.

Note that the degrees always depend on the choice of the big nef divisors, but to simplify the notations, we deliberately omit it.

We now explain how to associate to any rational map $X_1/q_1 Y_1 \xrightarrow[f]{g} X_2/q_2 Y_2$ a pullback operator $(f, g)^{\bullet, i}$.

Definition 1.5.1.4. Let $X_1/q_1 Y_1 \xrightarrow[f]{g} X_2/q_2 Y_2$ be a rational map and let π_1 and π_2 be the projections from the graph of f in $X_1 \times X_2$ onto the first and the second factor respectively. We define the linear morphisms $(f, g)^{\bullet, i}$ and $(f, g)_{\bullet, i}$ by the following formula :

$$(f, g)^{\bullet, i} : \alpha \in N^i(X_2/Y_2)_{\mathbb{R}} \longrightarrow (\pi_{1*} \circ \psi_{\tilde{\Gamma}_f/\Gamma_g} \circ \pi_2^*)(\alpha) \in N_{e-i}(X_1/Y_1)_{\mathbb{R}}.$$

$$(f, g)_{\bullet, i} : \beta \in N^i(X_1/Y_1)_{\mathbb{R}} \longrightarrow (\pi_{2*} \circ \psi_{\tilde{\Gamma}_f/\Gamma_g} \circ \pi_1^*)(\beta) \in N_{e-i}(X_2/Y_2)_{\mathbb{R}}.$$

Remark 1.5.1.5. When Y_1 and Y_2 are reduced to a point, then we simply write $f^{\bullet, i}(\alpha) := (f, \text{Id}_{\{pt\}})^{\bullet, i}(\alpha)$ and $f_{\bullet, i}(\beta) := (f, \text{Id}_{\{pt\}})_{\bullet, i}(\beta)$.

Remark 1.5.1.6. Since $N^i(X/Y) = 0$ and $N_{e-i}(X) = 0$ when $i > e$, it implies that $(f, g)^{\bullet, i}$ and $(f, g)_{\bullet, i}$ are identically zero for any $i > e$.

1.5.2 Sub-multiplicativity

Theorem 1.5.2.1. Let us consider the composition $X_1/q_1 Y_1 \xrightarrow[g_2]{f_1} X_2/q_2 Y_2 \xrightarrow[g_2]{f_2} X_3/q_3 Y_3$ of dominant rational maps. Then for any integer $0 \leq i \leq e$, there exists a constant $C > 0$ which depends only on the choice of H_{X_2} , H_{Y_2} , i , l and e such that :

$$\text{reldeg}_i(f_2 \circ f_1) \leq C \text{reldeg}_i(f_1) \text{reldeg}_i(f_2).$$

More precisely, $C = (e - i + 1)^i / (H_{X_2}^e \cdot q_2^* H_{Y_2}^l)$.

Proof. We denote by $\tilde{\Gamma}_{f_1}$ (resp. $\tilde{\Gamma}_{f_2}, \Gamma_{g_1}, \Gamma_{g_2}$) the normalization of the graph of $q_2 \circ f_1$ (resp. $q_3 \circ f_2, g_1, g_2$) and π_1, π_2 (resp. $\pi_3, \pi_4, \pi'_1, \pi'_2$ and π'_3, π'_4) the projections onto the first and the second factor respectively. We set Γ as the graph of the rational map $\pi_3^{-1} \circ f_1 \circ \pi_1 : \tilde{\Gamma}_{f_1} \dashrightarrow \tilde{\Gamma}_{f_2}$, u and v the projections from Γ onto $\tilde{\Gamma}_{f_1}$ and $\tilde{\Gamma}_{f_2}$ and ϖ_i the restriction on $\tilde{\Gamma}_{f_i}$ of the projection from $X_i \times X_{i+1}$ to $Y_i \times Y_{i+1}$ for each $i = 1, 2$. We have thus the following diagram.

$$\begin{array}{ccccc}
 & & \Gamma & & \\
 & u \swarrow & & \searrow v & \\
 & \tilde{\Gamma}_{f_1} & & \tilde{\Gamma}_{f_2} & \\
 \pi_1 \swarrow & & & & \searrow \pi_4 \\
 X_1 & \cdots \xrightarrow{f_1} & X_2 & \cdots \xrightarrow{f_2} & X_3 \\
 q_1 \downarrow & & \varpi_1 & & \varpi_2 \downarrow q_3 \\
 Y_1 & \cdots \xrightarrow{g_1} & Y_2 & \cdots \xrightarrow{g_2} & Y_3 \\
 \pi'_1 \swarrow & & \Gamma_{g_1} & & \searrow \pi'_4 \\
 & & & & \Gamma_{g_2}
 \end{array} \tag{1.19}$$

By Proposition 1.4.3.1 applied to $q_2 \circ \pi_2 \circ u : \Gamma \rightarrow Y_2$, the class $\psi_\Gamma(u^* \pi_2^* q_2^* H_{Y_2}^l)$ is represented by the fundamental class $[V]$ where V is a subscheme of dimension e in Γ which is a general fiber of $q_2 \circ \pi_2 \circ u$. We apply Theorem 1.3.4.4 by restriction to V to the class $a = v^* \pi_4^* H_{X_3}^i \lrcorner [V]$ and $b = u^* \pi_2^* H_{X_2}^i \lrcorner [V]$. We obtain :

$$v^* \pi_4^* H_{X_3}^i \lrcorner [V] \leq (e - i + 1)^i \frac{(v^* \pi_4^* H_{X_3}^i \cdot u^* \pi_2^* H_{X_2}^{e-i} \lrcorner [V])}{(u^* \pi_2^* H_{X_2}^e \lrcorner [V])} u^* \pi_2^* H_{X_2}^i \lrcorner [V] \in N_{e-i}(\Gamma). \tag{1.20}$$

Let us simplify the right hand side of inequality (1.20). Since $\pi_2 \circ u = \pi_3 \circ v$, $\psi_\Gamma(u^* \pi_2^* q_2^* H_{Y_2}^l) = [V] \in N_e(\Gamma)$ and since the morphism v is generically finite, one has that :

$$(v^* \pi_4^* H_{X_3}^i \cdot u^* \pi_2^* H_{X_2}^{e-i} \lrcorner [V]) = (v^* (\pi_4^* H_{X_3}^i \cdot \pi_3^* H_{X_2}^{e-i} \cdot \pi_3^* q_2^* H_{Y_2}^l)) = d \times \text{reldeg}_i(f_2), \tag{1.21}$$

where d is the topological degree of v . The same argument gives :

$$(u^* \pi_2^* H_{X_2}^e \lrcorner [V]) = d \times (H_{X_2}^e \cdot q_2^* H_{Y_2}^l). \tag{1.22}$$

Using (1.21), (1.22), inequality (1.20) can be rewritten as :

$$u^* \pi_2^* q_2^* H_{Y_2}^l \cdot v^* \pi_4^* H_{X_3}^i \leq C \text{reldeg}_i(f_2) u^* \pi_2^* H_{X_2}^i \cdot u^* \pi_2^* q_2^* H_{Y_2}^l \in N^{l+i}(\Gamma),$$

where $C = (e - i + 1)^i / (H_{X_2}^e \cdot q_2^* H_{Y_2}^l)$. Since the class $u^* \pi_1^* H_{X_1}^{e-i} \in N^{e-i}(\Gamma)$ is nef, we can intersect this class in the previous inequality to obtain :

$$(u^* (\pi_1^* H_{X_1}^{n-l-i} \cdot \pi_2^* q_2^* H_{Y_2}^l) \cdot v^* \pi_4^* H_{X_3}^i) \leq C' \text{reldeg}_i(f_2) (u^* \pi_2^* H_{X_2}^i \cdot u^* \pi_2^* q_2^* H_{Y_2}^l \cdot u^* \pi_1^* H_{X_1}^{n-l-i}). \tag{1.23}$$

Let us simplify the expressions in inequality (1.23). Because $\pi_2^* q_2^* H_{Y_2}^l = \varpi_1^* \pi_2'^* H_{Y_2}^l$ and $\text{deg}_l(g_1) = (\pi_2'^* H_{Y_2}^l)$, we deduce that :

$$\pi_2^* q_2^* H_{Y_2}^l = \frac{\text{deg}_l(g_1)}{(H_{Y_1}^l)} \varpi_1^* \pi_1'^* H_{Y_1}^l = \frac{\text{deg}_l(g_1)}{(H_{Y_1}^l)} \pi_1^* q_1^* H_{Y_1}^l. \tag{1.24}$$

Applying (1.24), the inequality (1.23) can be translated as :

$$\frac{\text{deg}_l(g_1)}{(H_{Y_1}^l)} (u^* \pi_1^* (H_{X_1}^{n-l-i} \cdot q_1^* H_{Y_1}^l) \cdot v^* \pi_4^* H_{X_3}^i) \leq C \frac{\text{deg}_l(g_1)}{(H_{Y_1}^l)} \text{reldeg}_i(f_2) (u^* (\pi_2^* H_{X_2}^i \cdot \pi_1^* q_1^* H_{Y_1}^l \cdot \pi_1^* H_{X_1}^{n-l-i})).$$

We obtain thus :

$$\frac{\deg_i(g_1)}{(H_{Y_1}^l)} \operatorname{reldeg}_i(f_2 \circ f_1) \leq C \frac{\deg_l(g_1)}{(H_{Y_1}^l)} \operatorname{reldeg}_i(f_1) \operatorname{reldeg}_i(f_2).$$

This concludes the proof of the inequality after dividing by $\deg_l(g_1)/(H_{Y_1}^l)$. \square

1.5.3 Norms of operators associated to rational maps

The proof of Theorem 2 relies on an easy but crucial lemma which is as follows.

Lemma 1.5.3.1. *Let us consider $(V, \|\cdot\|)$ a finite dimensional normed \mathbb{R} -vector space and let \mathcal{C} be a closed convex cone with non-empty interior in V . Then there exists a constant $C > 0$ such that any vector $u \in V$ can be decomposed as $v = v^+ - v^-$ where u^+ and u^- are in \mathcal{C} such that :*

$$\|v^{+/-}\| \leq C\|v\|.$$

Proof. Let us define the map $f : V \rightarrow \mathbb{R}^+$ given by :

$$f(v) = \inf\{\|v'\| + \|v' - v\| \mid v' \in \mathcal{C}, v' - v \in \mathcal{C}\}.$$

We check easily that f defines a norm on V which is similar to the proof of Proposition 1.3.5.1. Since V is finite dimensional, there exists a constant C such that for any $v \in V$, one has :

$$f(v) \leq C\|v\|,$$

Hence $\|v^+\| \leq C\|v\|$ and $\|v^-\| \leq C\|v\|$. \square

Theorem 1.5.3.2. *Let $X/qY \xrightarrow[f]{g} X/qY$ be a rational map. We fix an integer $i \leq e$, some norms on $N^i(X/Y)_{\mathbb{R}}$, on $N_{e-i}(X/Y)_{\mathbb{R}}$. Then there is a constant $C > 0$ such that for any rational map $X/qY \xrightarrow[f]{g} X/qY$, we have :*

$$\frac{1}{C} \leq \frac{\|(f, g)^{\bullet, i}\|}{\operatorname{reldeg}_i(f)} \leq C.$$

In particular, the i -th relative dynamical degree of f satisfies the following equality :

$$\lambda_i(f, X/Y) = \lim_{p \rightarrow +\infty} \|(f^p, g^p)^{\bullet, i}\|^{1/p}.$$

Moreover, when Y is reduced to a point, we obtain :

$$\lambda_i(f) = \lim_{p \rightarrow +\infty} \|(f^p)^{\bullet, i}\|^{1/p}.$$

Remark 1.5.3.3. The proof of Theorem 2 follows directly from Theorem 1.5.3.2 since $N^i(X/Y) = N^i(X)$ and $N_{e-i}(X/Y) = N_{e-i}(X)$ when Y is reduced to a point.

Proof. We denote by π_1 and π_2 the projections from the normalization of the graph $\tilde{\Gamma}_f$ of $q \circ f$ onto the first and the second component respectively as in Definition 1.5.1.1. Since we want to control the norm of $f^{\bullet, i}$ by the i -th relative degree of f , we first find an appropriate norm to relate the norm on $N_{e-i}(X)_{\mathbb{R}}$ with an intersection product. As $N_{e-i}(X/Y)_{\mathbb{R}}$ is a subspace of $N_{e-i}(X)_{\mathbb{R}}$, we can extend the norm $\|\cdot\|_{N_{e-i}(X/Y)_{\mathbb{R}}}$ into a norm on $N_{e-i}(X)_{\mathbb{R}}$. As $N_{e-i}(X)_{\mathbb{R}}$ is

a finite dimensional vector space and since H_X^{e-i} is a class in the interior of the basepoint free cone $\text{BPF}^{e-i}(X)$, we can suppose by equivalence of norms that the norm on $N_{e-i}(X)_{\mathbb{R}}$ given by

$$\|z\| = \inf_{\substack{z=z^+-z^- \\ z^+, z^- \in \text{Psef}_{e-i}(X)}} \{(H_X^{e-i} \lrcorner z^+) + (H_X^{e-i} \lrcorner z^-)\}$$

as in Proposition 1.3.5.1.

Let us prove that the lower bound of $\|(f, g)^{\bullet, i}\|/\text{reldeg}_i(f)$ is 1. We denote by $\varphi : N^i(X) \rightarrow N^i(X/Y)$ the canonical surjection. Since H_X^i is basepoint free, it implies that the class $(f, g)^{\bullet}(\varphi(H_X^i)) \in N_{e-i}(X/Y)_{\mathbb{R}} \subset N_{e-i}(X)_{\mathbb{R}}$ is pseudo-effective. In particular, this implies that its norm is exactly $\text{reldeg}_i(f)$. We have thus by definition :

$$\frac{\|(f, g)^{\bullet, i}\|}{\text{reldeg}_i(f)} = \left(\frac{\|(f, g)^{\bullet, i}\|}{\|(f, g)^{\bullet, i}\varphi(H_X^i)\|} \right) \geq 1,$$

as required.

Let us find an upper bound for $\|(f, g)^{\bullet, i}\|/\|(f, g)^{\bullet, i}\varphi(H_X^i)\|$. First we fix a morphism $s : N^i(X/Y)_{\mathbb{R}} \rightarrow N^i(X)_{\mathbb{R}}$ such that $\varphi \circ s = \text{Id}$. Take $\alpha \in N^i(X/Y)_{\mathbb{R}}$ of norm 1, then the class $u = s(\alpha) \in N^i(X)_{\mathbb{R}}$ is a representant of α . By construction, the norm of u is bounded by $\|u\|_{N^i(X)_{\mathbb{R}}} \leq C_1 \|\alpha\|_{N^i(X/Y)_{\mathbb{R}}} = C_1$ where C_1 is the norm of the operator s . Since by Proposition 1.4.3.4.(ii), $\text{Res}_{\Gamma_f/\Gamma_g}^* \circ \pi_2^* = (1/\text{deg}_l(g)) \times \pi_2^* \circ \text{Res}_{X/Y}^*$, we have therefore :

$$(f, g)^{\bullet, i}\alpha = \frac{1}{\text{deg}_l(g)} \times \pi_{1*} \circ \psi_{\Gamma_f} \circ \pi_2^* \circ \text{Res}_{X/Y}^*(\alpha) = \text{Res}_{X/Y} f^{\bullet, i}u.$$

By Theorem 1.3.3.3, the pliant cone $\text{BPF}^i(X)$ has a non-empty interior in $N^i(X)_{\mathbb{R}}$ and we can apply Lemma 1.5.3.1. There exists a constant $C_2 > 0$ which depends only on $\text{BPF}^i(X)$ and the choice of the norm on $N^i(X)_{\mathbb{R}}$ such that the class u can be decomposed as $u = u_1 - u_2$ where $u_i \in \text{BPF}^i(X)$ such that $\|u_i\|_{N^i(X)_{\mathbb{R}}} \leq C_2 \|u\|_{N^i(X)_{\mathbb{R}}}$ for $i = 1, 2$. We set $\alpha_i = \varphi(u_i)$ for all $i \in \{1, 2\}$. By the triangular inequality, we have :

$$\frac{\|(f, g)^{\bullet, i}\alpha\|_{N_{e-i}(X/Y)}}{\|(f, g)^{\bullet, i}\varphi(H_X^i)\|} \leq \frac{\|(f, g)^{\bullet, i}\alpha_1\|_{N_{e-i}(X)_{\mathbb{R}}}}{\|(f, g)^{\bullet, i}\varphi(H_X^i)\|} + \frac{\|(f, g)^{\bullet, i}\alpha_2\|_{N_{e-i}(X)_{\mathbb{R}}}}{\|(f, g)^{\bullet, i}\varphi(H_X^i)\|}.$$

We have to find an upper bound of $\|(f, g)^{\bullet, i}\alpha_i\|_{N_{e-i}(X/Y)_{\mathbb{R}}}$ for each $i = 1, 2$. Applying Siu's inequality (Corollary 1.3.4.6) to $a = \pi_2^*u_i$ and $b = \pi_2^*H_X$ and then composing with $\text{Res}_{X/Y} \circ \pi_{1*} \circ \psi_{\Gamma_f}$ gives

$$\text{Res}_{X/Y}(f^{\bullet, i}(u_i)) \leq C_3 \frac{\|u_i\|_{N^i(X)_{\mathbb{R}}}}{(H_X^n)} \times \text{Res}_{X/Y}(f^{\bullet, i}(H_X^i)),$$

where C_3 is a positive constant which depends only on the choice of big nef divisors. This implies by intersecting with H_X^{e-i} the inequality :

$$\|((f, g)^{\bullet, i}(\alpha_i))\|_{N_{e-i}(X/Y)_{\mathbb{R}}} \leq C_3 \frac{\|u_i\|_{N^i(X)_{\mathbb{R}}}}{(H_X^n)} \|(f, g)^{\bullet, i}(\varphi(H_X^i))\|_{N_{e-i}(X/Y)_{\mathbb{R}}}.$$

In particular we have shown that :

$$1 \leq \frac{\|(f, g)^{\bullet, i}\alpha\|_{N_{e-i}(X/Y)_{\mathbb{R}}}}{\|(f, g)^{\bullet, i}\varphi(H_X^i)\|_{N_{e-i}(X/Y)_{\mathbb{R}}}} \leq \frac{2C_1C_2C_3}{(H_X^n)},$$

which concludes the proof. \square

1.6 Semi-conjugation by dominant rational maps

In this section, we consider a more general situation than in the previous section. We still suppose that the varieties X_i and Y_i are of dimension n and l respectively such that the relative dimension is $e = n - l$, but we suppose the maps $q_i : X_i \dashrightarrow Y_i$ merely *rational* and dominant : they may exhibit indeterminacy points. Recall also that H_{X_i} and H_{Y_i} are again big and nef Cartier divisors on X_i and Y_i respectively.

Definition 1.6.0.1. *Let $f : X_1 \dashrightarrow X_2$, $g : Y_1 \dashrightarrow Y_2$, $q_1 : X_1 \dashrightarrow Y_1$ and $q_2 : X_2 \dashrightarrow Y_2$ be four dominant rational maps such that $q_2 \circ f = g \circ q_1$. We define the i -th relative dynamical degree of f (still denoted $\text{reldeg}_i(f)$) as the relative degree $\text{reldeg}_i(\tilde{f})$ with respect to the rational map $\Gamma_{q_1}/Y_1 \xrightarrow{\tilde{f}} \Gamma_{q_2}/Y_2$ where Γ_{q_i} are the normalization of the graphs of q_i in $X_i \times Y_i$ for each integer $i \in \{1, 2\}$ respectively and $\tilde{f} : \Gamma_{q_1} \dashrightarrow \Gamma_{q_2}$ is the rational map induced by f .*

Theorem 1.6.0.2. (i) *Consider now the following commutative diagram :*

$$\begin{array}{ccccc} X_1 & \xrightarrow{f_1} & X_2 & \xrightarrow{f_2} & X_3 \\ | & & | & & | \\ q_1 & & q_2 & & q_3 \\ \downarrow & & \downarrow & & \downarrow \\ Y_1 & \xrightarrow{g_1} & Y_2 & \xrightarrow{g_2} & Y_3 \end{array}$$

where $f_i : X_i \dashrightarrow X_{i+1}$, $g_i : Y_i \dashrightarrow Y_{i+1}$, $q_1 : X_1 \dashrightarrow Y_1$, $q_2 : X_2 \dashrightarrow Y_2$, $q_3 : X_3 \dashrightarrow Y_3$ are dominant rational maps for any integer $j \in \{1, 2, 3\}$ such that $q_{j+1} \circ f_j = g_j \circ q_j$ for any integer $j \in \{1, 2\}$. Then there exists a constant $C > 0$ which depends only e, i and the choice of big nef Cartier divisors such that :

$$\text{reldeg}_i(f_2 \circ f_1) \leq C \text{reldeg}_i(f_2) \text{reldeg}_i(f_1).$$

(ii) *Consider now the following commutative diagram :*

$$\begin{array}{ccccc} & & X'_1 & \xrightarrow{\tilde{f}} & X'_2 \\ & \swarrow \phi_1 & | & & | \\ X_1 & \xrightarrow{f} & X_2 & & \\ & \searrow \phi_2 & | & & | \\ & & Y'_1 & \xrightarrow{\tilde{g}} & Y'_2 \\ & \swarrow \phi_1 & | & & | \\ Y_1 & \xrightarrow{g} & Y_2 & & \end{array}$$

where $f : X_1 \dashrightarrow X_2$, $g : Y_1 \dashrightarrow Y_2$, $q_1 : X_1 \dashrightarrow Y_1$, $q_2 : X_2 \dashrightarrow Y_2$ are four dominant rational maps such that $q_2 \circ f = g \circ q_1$. We consider some birational maps $\phi_i : X'_i \dashrightarrow X_i$ and $\phi_i : Y'_i \dashrightarrow Y_i$ for $i = 1, 2$ such that $\tilde{f} = \phi_2^{-1} \circ f \circ \phi_1$ and $\tilde{g} = \phi_2^{-1} \circ g \circ \phi_1$. Then for any integer $0 \leq i \leq e$, there exists a constant $C > 0$ which depends on e, i , on the choice of big nef Cartier divisors and on the rational maps ϕ_1 and ϕ_2 such that :

$$\frac{1}{C} \text{reldeg}_i(f) \leq \text{reldeg}_i(\tilde{f}) \leq C \text{reldeg}_i(f). \quad (1.25)$$

Proof. (i) Recall that the normalization of the graph of q_j in $X_j \times Y_j$ is birational to X_j for $j \in \{1, 2\}$, hence one can define $\tilde{f}_j : \Gamma_{q_j} \dashrightarrow \Gamma_{q_{j+1}}$ the rational maps induced by f_j on the graph

Γ_{q_j} of q_j for $j \in \{1, 2\}$ respectively. Then (i) results directly from Theorem 1.5.2.1 applied to the composition $\Gamma_{q_1}/Y_1 \xrightarrow[g_1]{\tilde{f}_1} \Gamma_{q_2}/Y_2 \xrightarrow[g_2]{\tilde{f}_2} \Gamma_{q_3}/Y_3$.

(ii) Let us suppose first that the maps $q_j : X_j \rightarrow Y_j$ and $q'_j : X'_j \rightarrow Y'_j$ are all regular for $j = 1, 2$. Let us apply successively Theorem 1.5.2.1 to the composition $X'_1/q'_1 Y'_1 \xrightarrow[\phi_1]{\varphi_1} X_1/q_1 Y_1 \xrightarrow[g]{f} X_2/q_2 Y_2 \xrightarrow[\phi_2^{-1}]{\varphi_2^{-1}} X'_2/q'_2 Y'_2$. We obtain :

$$\text{reldeg}_i(\varphi_2^{-1} \circ f \circ \varphi_1) \leq C_2 \text{reldeg}_i(f \circ \varphi_1) \text{reldeg}_i(\varphi_2^{-1}) \leq C_1 C_2 \text{reldeg}_i(f) \text{reldeg}_i(\varphi_1) \text{reldeg}_i(\varphi_2^{-1}), \quad (1.26)$$

where $C_1 = (e - i + 1)^i / (H_{X_1}^e \cdot q_1^* H_{Y_1}^l)$ and $C_2 = (e - i + 1)^i / (H_{X_2}^e \cdot q_2^* H_{Y_2}^l)$. This proves that :

$$\text{reldeg}_i(\varphi_2^{-1} \circ f \circ \varphi_1) \leq C \text{reldeg}_i(f),$$

where

$$C = \frac{(e - i + 1)^{2i} \text{reldeg}_i(\varphi_1) \text{reldeg}_i(\varphi_2^{-1})}{(H_{X_1}^e \cdot q_1^* H_{Y_1}^l)(H_{X_2}^e \cdot q_2^* H_{Y_2}^l)}.$$

The proof follows easily from the regular case since the maps $\Gamma_{q'_1} \dashrightarrow \Gamma_{q_1}$ and $\Gamma_{q'_2} \dashrightarrow \Gamma_{q_2}$ are birational where $\Gamma_{q'_i}$ are the graphs of q'_i in $X'_i \times Y'_i$ for $i = 1, 2$. \square

Proof of Theorem 1 : (i) We apply Theorem 1.5.2.1 to $Y_1 = Y_2 = Y_3 = \text{Spec}(\mathbf{k})$, $X_1 = X_2 = X_3 = X$ and $H_{X_1} = H_{X_2} = H_{X_3} = H_X$, we get thus the desired conclusion :

$$\text{deg}_i(g \circ f) \leq \frac{(n - i + 1)^i}{(H_X^n)} \text{deg}_i(f) \text{deg}_i(g).$$

(ii) Applying Theorem 1.6.0.2.(ii) to the varieties $X'_1 = X'_2 = X_1 = X_2 = X$, $Y'_1 = Y'_2 = Y_1 = Y_2 = \text{Spec}(\mathbf{k})$, to the choice of big nef divisors $H_{X'_1} = H_{X'_2} = H'_X$, $H_{Y'_1} = H_{Y'_2} = H'_Y$, $H_{X_1} = H_{X_2} = H_X$ and to the rational maps $\varphi_1 = \varphi_2 = \text{Id}_X$, $\phi_1 = \phi_2 = g = \text{Id}_{\text{Spec}(\mathbf{k})}$, $f : X \dashrightarrow X$ yields the desired result.

1.7 Mixed degree formula

Let us consider three dominant rational maps $f : X \dashrightarrow X$, $q : X \dashrightarrow Y$, $g : Y \dashrightarrow Y$ such that $q \circ f = g \circ q$. Theorem 1.6.0.2.(i) implies that for any integer $i \leq e$ the sequence $\text{reldeg}_i(f^n)$ is submultiplicative. Define i -th relative dynamical degree as follows.

$$\lambda_i(f, X/Y) := \lim_{p \rightarrow +\infty} (\text{reldeg}_i(f^p))^{1/p}.$$

When Y is reduced to a point, then we simply write $\lambda_i(f) := \lambda_i(f, X/\{pt\})$.

Remark 1.7.0.1. Since $\text{reldeg}_i(f^p) \in \mathbb{N}$ is an integer, one has that $\lambda_i(f, X/Y) \geq 1$.

Remark 1.7.0.2. Theorem 1.6.0.2.(ii) implies that $\lambda_i(f, X/Y)$ is invariant by birational conjugacy, i.e $\lambda_i(f, X/Y)$ does not depend on the choice of big nef Cartier divisors and on any choice of varieties X' and Y' which are birational to X and Y respectively.

Our aim in this section is to prove Theorem 4. To that end, we follow the approach from [DNT12]. The main ingredient (Corollary 1.7.1.5) is an inequality relating basepoint free classes which generalizes to arbitrary fields (see [DN11a, Proposition 2.3] and [DNT12, Proposition 2.5]). This inequality is a direct consequence of Theorem 1.7.1.1 which estimates the positivity of the diagonal in a quite general setting. After this, we prove in Theorem 1.7.2.3 the submultiplicativity formula for the mixed degrees. Once the submultiplicativity of these mixed degrees holds, the proof follows from a linear algebra argument.

1.7.1 Positivity estimate of the diagonal

In this section, we prove the following theorem.

Theorem 1.7.1.1. *Let $q : X \rightarrow Y$ be a surjective morphism such that $\dim Y = l$ and such that q is of relative dimension e . There exists a constant $C > 0$ such that for any surjective generically finite morphism $\pi : X' \rightarrow X$ and any class $\gamma \in \text{BPF}^{l+e}(X' \times X')$:*

$$(\gamma \llcorner [\Delta_{X'}]) \leq C \times (\gamma \cdot (\pi \times \pi)^*(H_X^e \cdot H_Y^l)), \quad (1.27)$$

where p_1 and p_2 are the projections from $X \times X$ to the first and the second factor respectively, $H_X = p_1^*H_X + p_2^*H_X$ and $H_Y = p_1^*q^*H_Y + p_2^*q^*H_Y$, and where $\Delta_{X'}$ (resp. Δ_X) is the diagonal of X' (resp. of X) in $X' \times X'$ (resp. in $X \times X$).

Remark 1.7.1.2. The fact that the constant $C > 0$ does not depend on π but only on H_X, H_Y is crucial in the applications. Theorem 1.7.1.1 implies that the difference $(\pi \times \pi)^*(H_X^e \cdot H_Y^l) - [\Delta_{X'}]$ belongs to the dual cone of the cone $\text{BPF}_{e+l}(X' \times X')_{\mathbb{R}}$ with respect to the intersection product, however we conjecture that this class should be pseudo-effective :

$$[\Delta_{X'}] \leq C \psi_{X' \times X'}((\pi \times \pi)^*(H_X^e \cdot H_Y^l)) \in N_{l+e}(X' \times X')_{\mathbb{R}}. \quad (1.28)$$

We shall use several times the following lemma which is proved at the end of this section.

Lemma 1.7.1.3. *Let $X_1/q_1 Y_1 \xrightarrow[f]{g} X_2/q_2 Y_2$ be two dominant rational maps where $\dim Y_1 = \dim Y_2 = l$ and $\dim X_1 = \dim X_2 = e + l$ and where q_1, q_2 are regular surjective morphisms. We denote by Γ_f and Γ_g the normalizations of the graph of f and g in $X_1 \times X_2$ and $Y_1 \times Y_2$ respectively, $\pi_1, \pi_2, \pi'_1, \pi'_2$ are the projections from Γ_f and Γ_g on the first and the second factor respectively. Then there exists a constant $C > 0$ such that for any surjective generically finite morphism $\pi : X' \rightarrow \Gamma_f$, any integer $0 \leq j \leq l$ and any class $\beta \in \text{BPF}^{e+l-j}(X')$, one has :*

$$(\beta \cdot \pi^* \pi_2^* q_2^* H_{Y_2}^j) \leq C \frac{\deg_j(g)}{(H_{Y_1}^l)} \times (\beta \cdot \pi^* \pi_1^* q_1^* H_{Y_1}^j),$$

where $\deg_j(g)$ is the j -th degree of the rational map g with respect to the divisors H_{Y_1} and H_{Y_2} .

Proof of Theorem 1.7.1.1. By Siu's inequality, we can suppose that both the classes H_X and H_Y are ample in X and Y respectively. We proceed in three steps. Fix $\pi : X' \rightarrow X$.

Step 1 : We suppose first that $X = \mathbb{P}^l \times \mathbb{P}^e$, $Y = \mathbb{P}^l$ and q is the projection onto the first factor. Since $X \times X$ is smooth, the pullback $(\pi \times \pi)^*$ is well-defined in $N_{l+e}(X \times X)_{\mathbb{R}}$ because the morphism $\psi_{X \times X} : N^{l+e}(X \times X)_{\mathbb{R}} \rightarrow N_{l+e}(X \times X)_{\mathbb{R}}$ is an isomorphism. Our objective is to prove that there exists a constant $C_1 > 0$ such that

$$[\Delta_{X'}] \leq C_1 \psi_{X' \times X'}((\pi \times \pi)^*(H_X^e \cdot H_Y^l)) \in N_{l+e}(X' \times X')_{\mathbb{R}}.$$

As $X \times X$ is homogeneous, we apply the following lemma analogous to [Tru16a, Lemma 4.4] which we prove at the end of the section.

Lemma 1.7.1.4. *Let X be a homogeneous projective variety of dimension n and let $\pi : X' \rightarrow X$ be a surjective generically finite morphism. Then one has that :*

$$[\Delta_{X'}] \leq (\pi \times \pi)^*[\Delta_X] \in N_n(X' \times X')_{\mathbb{R}}.$$

We denote by p'_1, p'_2 (resp. p''_1, p''_2) the projections from $Y \times Y$ (resp. from $X \times X$) onto the first and the second factor respectively. Since the basepoint free cone has a non-empty interior by Theorem 1.3.3.3.(i) and since the class $p_1^*H_Y + p_2^*H_Y$ is ample on $Y \times Y$, there exists a constant $C_2 > 0$ such that the class $-\Delta_Y + C_2(p_1^*H_Y + p_2^*H_Y)^l \in N^l(Y \times Y)_{\mathbb{R}}$ is basepoint free. Since $\Delta_X = \Delta_Y \times \Delta_{\mathbb{P}^e}$ and by intersection and by pullback, we have that the class :

$$-\Delta_X + C_2 H_Y^l \cdot p^*[\Delta_{\mathbb{P}^e}] \in N^{e+l}(X \times X)$$

is basepoint free where p denotes the projection from $X \times X$ to $\mathbb{P}^e \times \mathbb{P}^e$. By the same argument, there exists a constant $C_3 > 0$ such that the class $-p^*[\Delta_{\mathbb{P}^e}] + C_3 H_X^e \in N^e(X \times X)_{\mathbb{R}}$ is basepoint free. We have proved that the class :

$$-\Delta_X + C_2 C_3 H_Y^l \cdot H_X^e \in N^{e+l}(X \times X)_{\mathbb{R}}$$

is basepoint free. Since the basepoint free cone is stable by pullback, we have thus :

$$[\Delta_{X'}] \leq (\pi \times \pi)^*[\Delta_X] \leq C_1 \psi_{X' \times X'}((\pi \times \pi)^*(H_Y^l \cdot H_X^e)) \in N_{l+e}(X' \times X')_{\mathbb{R}},$$

where $C_1 = C_2 \times C_3$ as required.

Step 2 : We now suppose that $X = Y \times \mathbb{P}^e$. Since Y is projective, there exists a dominant rational map $\phi : Y \dashrightarrow \mathbb{P}^l$ (ϕ can be chosen as the composition of an embedding in \mathbb{P}^N with a linear projection on a linear hypersurface). Let Y' be the normalization of the graph of ϕ in $X \times \mathbb{P}^e \times \mathbb{P}^l$ and we denote by ϕ_1 and φ_1 the projections from Y' onto the first and the second factor respectively. Let $\varphi_2 : Y' \times \mathbb{P}^e \rightarrow \mathbb{P}^l \times \mathbb{P}^e$ (resp. $\phi_2 : Y' \times \mathbb{P}^e \rightarrow X$) the map induced by φ_1 (resp. ϕ_1). Let X'' be the fibred product of X' with $Y' \times \mathbb{P}^e$ so that ϕ_3, π' are the projections from X'' onto X' and $Y' \times \mathbb{P}^e$ respectively. We obtain the following commutative diagram :

$$\begin{array}{ccccc}
 X' & \longleftarrow & X'' & & \\
 \downarrow \pi & & \downarrow \pi' & & \\
 Y \times \mathbb{P}^e & \longleftarrow & Y' \times \mathbb{P}^e & \xrightarrow{\varphi_2} & \mathbb{P}^l \times \mathbb{P}^e \\
 \downarrow q & & \downarrow p_{Y'} & & \downarrow p_{\mathbb{P}^l} \\
 Y & \longleftarrow & Y' & \xrightarrow{\varphi_1} & \mathbb{P}^l
 \end{array}$$

where $p_{Y'}$ and $p_{\mathbb{P}^l}$ are the projections from $Y' \times \mathbb{P}^e$ and $\mathbb{P}^l \times \mathbb{P}^e$ onto Y' and \mathbb{P}^l respectively and where the horizontal arrows are birational maps. Let us prove that there exists a constant $C_4 > 0$ which does not depend on the morphism $\pi : X' \rightarrow X$ such that for any basepoint free class $\gamma' \in \text{BPF}^{e+l}(X'' \times X'')$, one has :

$$(\gamma' \lrcorner [\Delta_{X''}]) \leq C_4 (\gamma' \cdot (\phi_3 \times \phi_3)^*(\pi \times \pi)^*(H_X^e \cdot H_Y^l)).$$

Fix a class $\gamma' \in \text{BPF}^{e+l}(X'' \times X'')$. We apply the conclusion of the first step to the surjective generically finite morphism $\pi'' := \varphi_2 \circ \pi' : X'' \rightarrow \mathbb{P}^l \times \mathbb{P}^e$. There exists a constant $C_1 > 0$ such that

$$[\Delta_{X''}] \leq C_1 \psi_{X'' \times X''}((\pi'' \times \pi'')^*(H_{\mathbb{P}^l}^l \cdot H_{\mathbb{P}^l \times \mathbb{P}^e}^e)) \in N_{l+e}(X'' \times X'')_{\mathbb{R}}, \quad (1.29)$$

where $H_{\mathbb{P}^l \times \mathbb{P}^e}$ is an ample Cartier divisor in $(\mathbb{P}^l \times \mathbb{P}^e)^2$ and $H_{\mathbb{P}^l}$ is the pullback by $p_{\mathbb{P}^l} \times p_{\mathbb{P}^l}$ of an ample Cartier divisor in $\mathbb{P}^l \times \mathbb{P}^l$. Let us apply Theorem 1.3.4.4 to the class $(\pi'' \times \pi'')^* H_{\mathbb{P}^l \times \mathbb{P}^e}^e$ and to the class $(\pi' \times \pi')^*(\phi_2 \times \phi_2)^* H_X$, there exists a constant $C_5 > 0$ such that :

$$(\pi'' \times \pi'')^* H_{\mathbb{P}^l \times \mathbb{P}^e}^e \leq C_5 \frac{((\pi' \times \pi')^*((\phi_2 \times \phi_2)^* H_X^{2l+e} \cdot (\varphi_2 \times \varphi_2)^* H_{\mathbb{P}^l \times \mathbb{P}^e}^e))}{((\pi' \times \pi')^*(\phi_2 \times \phi_2)^* H_X^{2(l+e)})} \times (\pi' \times \pi')^*(\phi_2 \times \phi_2)^* H_X^e \in N^e(X'' \times X'')_{\mathbb{R}}.$$

Since $((\pi' \times \pi')^* \alpha) = \deg(\pi')(\alpha)$ for any class $\alpha \in N^{2l+2e}((Y' \times \mathbb{P}^e)^2)_{\mathbb{R}}$, we have thus :

$$(\pi'' \times \pi'')^* H_{\mathbb{P}^l \times \mathbb{P}^e}^e \leq C_6 (\pi' \times \pi')^*(\phi_2 \times \phi_2)^* H_X^e \in N^e(X'' \times X'')_{\mathbb{R}}, \quad (1.30)$$

where $C_6 = C_5((\phi_2 \times \phi_2)^* H_X^{2l+e} \cdot (\varphi_2 \times \varphi_2)^* H_{\mathbb{P}^l \times \mathbb{P}^e}^e) / ((\phi_2 \times \phi_2)^* H_X^{2l+2e}) > 0$ does not depend on $\pi : X' \rightarrow X$. Using (1.30) and (1.29), we obtain :

$$[\Delta_{X''}] \leq C_7 \psi_{X'' \times X''}((\pi'' \times \pi'')^* H_{\mathbb{P}^l}^l \cdot (\phi_3 \times \phi_3)^*(\pi \times \pi)^* H_X^e) \in N_{l+e}(X'' \times X'')_{\mathbb{R}}, \quad (1.31)$$

where $C_7 = C_6 \times C_1$. Since the basepoint free cone is contained in the nef cone by Theorem 1.3.3.3.(v), we have thus :

$$(\gamma' \lrcorner [\Delta_{X''}]) \leq C_7 (\gamma' \cdot (\phi_3 \times \phi_3)^*(\pi \times \pi)^* H_X^e \cdot (\pi'' \times \pi'')^* H_{\mathbb{P}^l}^l). \quad (1.32)$$

Let us denote by $X_1 = (Y \times \mathbb{P}^e)^2$, $X_2 = (\mathbb{P}^l \times \mathbb{P}^e)^2$, $Y_1 = Y \times Y$, $Y_2 = \mathbb{P}^l \times \mathbb{P}^l$ and let $f := (\varphi_2 \circ \phi_2^{-1} \times \varphi_2 \circ \phi_2^{-1}) : X_1 \dashrightarrow X_2$ and $g := (\varphi_1 \circ \phi_1^{-1} \times \varphi_1 \circ \phi_1^{-1}) : Y_1 \dashrightarrow Y_2$ be the corresponding dominant rational maps. Let us apply Lemma 1.7.1.3 to the class $(\pi' \times \pi')^*(\varphi_2 \times \varphi_2)^* H_{\mathbb{P}^l}^l$ and to the class $(\pi' \times \pi')^*(\phi_2 \times \phi_2)^* H_Y^l$, there exists a constant $C_8 > 0$ which is independent of the morphism $\pi' \times \pi' : X'' \times X'' \rightarrow (Y' \times \mathbb{P}^e)^2$ such that for any class $\beta \in \text{BPF}^{2e+l}(X'' \times X'')$:

$$(\beta \cdot (\pi' \times \pi')^*(\varphi_2 \times \varphi_2)^* H_{\mathbb{P}^l}^l) \leq C_8 \frac{\deg_i(g)}{(H_Y^{2l})} (\beta \cdot (\phi_3 \times \phi_3)^*(\pi \times \pi)^* H_Y^l). \quad (1.33)$$

Using (1.32) and (1.33) to the class $\beta = \gamma' \cdot (\phi_3 \times \phi_3)^*(\pi \times \pi)^* H_X^e \in \text{BPF}^{l+2e}(X'' \times X'')$, we obtain :

$$(\gamma' \lrcorner [\Delta_{X''}]) \leq C_4 (\gamma' \cdot (\phi_3 \times \phi_3)^*(\pi \times \pi)^*(H_X^e \cdot H_Y^l)),$$

where $C_4 = C_4 \times C_8(\deg_i(g)) / (H_Y^{2l}) > 0$ does not depend on π . The conclusion of the theorem follows from the projection formula and from the fact that $\phi_3 \times \phi_3$ is a birational map. Indeed, we apply the previous inequality to $\gamma' = (\phi_3 \times \phi_3)^* \gamma$ where $\gamma \in \text{BPF}^{l+e}(X' \times X')$, we obtain

$$(\gamma \lrcorner [\Delta_{X'}]) = ((\phi_3 \times \phi_3)^* \gamma \lrcorner [\Delta_{X''}]) \leq C_4 (\gamma \cdot (\pi \times \pi)^*(H_X^e \cdot H_Y^l))$$

as required.

Step 3 : We prove the theorem in the general case. Suppose $q : X \rightarrow Y$ is a surjective morphism of relative dimension e and fix a class $\beta \in \text{BPF}^{l+e}(X' \times X')$. Since X is projective over Y , there exists a closed immersion $i : X \rightarrow Y \times \mathbb{P}^N$ such that $q = p'_Y \circ i$ where p'_Y is the projection of $Y \times \mathbb{P}^N$ onto Y . Let us choose a projection $Y \times \mathbb{P}^N \dashrightarrow Y \times \mathbb{P}^e$ so that the composition with i gives a dominant rational map $f : X \dashrightarrow Y \times \mathbb{P}^e$. Let us denote by Γ_f the normalization of the graph of f in $X \times Y \times \mathbb{P}^e$ and π_1, π_2 the projections of Γ_f onto the first and the second factor respectively. We set X'' the fibred product of X' with Γ_f and we denote

by π' and ϕ the projection of X'' to Γ_f and X' respectively. We get the following commutative diagram :

$$\begin{array}{ccc}
X' & \xleftarrow{\phi} & X'' \\
\downarrow \pi & & \downarrow \pi' \\
X & \xleftarrow{\pi_1} & \Gamma_f \\
\downarrow q & \searrow f & \downarrow \pi_2 \\
Y & \xleftarrow{p_Y} & Y \times \mathbb{P}^e
\end{array}$$

where p_Y is the projection of $Y \times \mathbb{P}^e$ onto Y . We apply the result of Step 2 to the class $(\phi \times \phi)^* \beta \in \text{BPF}^{l+e}(X'' \times X'')$ and to the diagonal of X'' . There exists a constant $C_4 > 0$ which does not depend on π such that :

$$((\phi \times \phi)^* \beta \llcorner [\Delta_{X''}]) \leq C_4 ((\phi \times \phi)^* (\beta \cdot (\pi \times \pi)^* H_Y^l)) \cdot ((\pi_2 \circ \pi') \times (\pi_2 \circ \pi'))^* H_{Y \times \mathbb{P}^e}^e. \quad (1.34)$$

Let us apply Theorem 1.3.4.4 to the class $((\pi_2 \circ \pi') \times (\pi_2 \circ \pi'))^* H_{Y \times \mathbb{P}^e}^e$ and to the class $(\phi \times \phi)^* (\pi \times \pi) H_X$. There exists a constant $C_9 > 0$ such that :

$$\begin{aligned}
((\pi_2 \circ \pi') \times (\pi_2 \circ \pi'))^* H_{Y \times \mathbb{P}^e}^e &\leq C_9 \frac{((\pi' \times \pi')^* ((\pi_2 \times \pi_2)^* H_{Y \times \mathbb{P}^e}^e \cdot (\pi_1 \times \pi_1)^* H_X^{2l+2e}))}{((\pi' \times \pi')^* (\pi_1 \times \pi_1)^* H_X^{2l+2e})} \\
&(\phi \times \phi)^* (\pi \times \pi) H_X^e \in N^e(X'' \times X'')_{\mathbb{R}}.
\end{aligned}$$

Since $((\pi' \times \pi')^* ((\pi_2 \times \pi_2)^* H_{Y \times \mathbb{P}^e}^e \cdot (\pi_1 \times \pi_1)^* H_X^{2l+2e})) / ((\pi' \times \pi')^* (\pi_1 \times \pi_1)^* H_X^{2l+2e}) = \deg_e(f \times f) / (H_X^{2l+2e})$ and using (1.34), we obtain :

$$((\phi \times \phi)^* \beta \llcorner [\Delta_{X''}]) \leq C ((\phi \times \phi)^* (\beta \cdot (\pi \times \pi)^* (H_X^e \cdot H_Y^l))),$$

where $C = C_4 C_9 \deg_e(f \times f) / (H_X^{2l+2e})$. Since the morphism $\pi_1 : \Gamma_f \rightarrow X$ is birational, the map $\phi : X'' \rightarrow X'$ is also birational and we conclude using the projection formula and since $(\phi \times \phi)_* [\Delta_{X''}] = [\Delta_{X'}]$:

$$(\beta \llcorner [\Delta_{X'}]) \leq C (\beta \cdot (\pi \times \pi)^* (H_X^e \cdot H_Y^l)).$$

□

Recall that X, Y are normal projective varieties and H_X, H_Y are ample divisors on X and Y respectively.

Corollary 1.7.1.5. *Let $q : X \rightarrow Y$ be a surjective morphism of relative dimension e where $\dim Y = l$. Then there exists a constant $C > 0$ such that for any surjective generically finite morphism $\pi : X' \rightarrow X$ such that for any class $\alpha \in \text{BPF}^i(X')$ and any class $\beta \in \text{BPF}^{l+e-i}(X')$, one has :*

$$(\beta \cdot \alpha) \leq C \sum_{\max(0, i-l) \leq j \leq \min(i, e)} U_j(\pi_* \psi_{X'}(\alpha)) \times (\beta \cdot \pi^*(q^* H_Y^{i-j} \cdot H_X^j)), \quad (1.35)$$

where $U_j(\pi_* \psi_{X'}(\alpha)) = (H_X^{e-j} \cdot q^* H_Y^{l-i+j} \llcorner \pi_* \psi_{X'}(\alpha))$.

Remark 1.7.1.6. Note that when $i \leq e$, then the inequality is already a consequence of Siu's inequality (Theorem 1.3.4.4). Indeed, the term on the right hand side of (1.35) with $j = i$ corresponds exactly to the term $C(\pi^* H_X^{n-i} \cdot \alpha) \times \pi^* H_X^i$.

Remark 1.7.1.7. Equation (1.35) proves that the class

$$-\psi_{X'}(\alpha) + C \sum_{\max(0, i-l) \leq j \leq \min(i, e)} U_j(\pi_* \psi_{X'}(\alpha)) \psi_{X'}(\pi^*(q^* H_Y^{i-j} \cdot H_X^j)) \in N_{n-i}(X')_{\mathbb{R}}$$

is in the dual of the basepoint free cone $\text{BPF}^{n-i}(X')$. Moreover, if (1.28) is satisfied, then this class is pseudo-effective.

Proof. We apply Theorem 1.7.1.1 to the class $\gamma = p_1^* \beta \cdot p_2^* \alpha \in \text{BPF}^n(X' \times X')$. There exists a constant $C_1 > 0$ such that for any surjective generically finite morphism $\pi : X' \rightarrow X$ and any class $\gamma \in \text{BPF}^n(X' \times X')$, one has :

$$(\gamma \llcorner [\Delta_{X'}]) \leq C_1(\gamma \cdot (\pi \times \pi)^*(H_X^e \cdot H_Y^l)).$$

We denote by p_1 and p_2 the projections of $X' \times X'$ onto the first and the second factors respectively. Fix $\alpha \in \text{BPF}^i(X')$ and $\beta \in \text{BPF}^{n-i}(X')$. Let us apply the previous inequality to $\gamma = p_1^* \beta \cdot p_2^* \alpha \in \text{BPF}^n(X' \times X')$. We obtain :

$$(\beta \cdot \alpha) = (p_1^* \beta \cdot p_2^* \alpha \llcorner [\Delta_{X'}]) \leq C_1(p_1^* \beta \cdot p_2^* \alpha \cdot (\pi \times \pi)^*(H_X^e \cdot H_Y^l)).$$

Since $(p_1^* \pi^*(H_X^m \cdot q^* H_Y^j) \cdot p_2^*(\pi^*(q^* H_Y^{l-m} \cdot H_X^{e-j}) \cdot \gamma)) = 0$ when $m + j \neq i$, we obtain :

$$(\beta \cdot \alpha) \leq C \sum_{\max(0, i-l) \leq j \leq \min(e, i)} (\pi^*(q^* H_Y^{l-i+j} \cdot H_X^{e-j}) \cdot \alpha) (\pi^*(q^* H_Y^{i-j} \cdot H_X^j) \cdot \beta).$$

where $C = C_1 \left(1 + \max \left(\binom{e}{j} \binom{l}{i-j} \right) \right)$. Hence by the projection formula, we have proved the required inequality :

$$(\beta \cdot \alpha) \leq C \sum_{\max(0, i-l) \leq j \leq \min(e, i)} U_j(\pi_* \psi_{X'}(\alpha)) \times (\beta \cdot \pi^*(q^* H_Y^{i-j} \cdot H_X^j)).$$

□

Proof of Lemma 1.7.1.4 : (see [Tru16a, Lemma 4.4]) Since X is homogeneous, it is smooth. Let G be the automorphism group of $X \times X$, we denote by \cdot the (transitive) action of G on $X \times X$. By generic flatness (see [FGI⁺05, Theorem 5.12]), there exists a non empty open subset $V \subset X \times X$ such that the restriction of $\pi \times \pi$ to $U := (\pi \times \pi)^{-1}(V)$ is flat over V . Recall that two subvarieties $F \subset X \times X$ and $W \subset X \times X$ intersect properly in $X \times X$ if $\dim(F \cap W) = \dim F + \dim W - 2n$. Since G acts transitively on $X \times X$, there exists by [Ful98, Lemma B.9.2] a Zariski dense open subset $O \subset G$ such that for any point $g \in O$, the cycle $g \cdot [\Delta_X]$ intersects properly every component of $X \times X \setminus V$. In particular, there exists a one parameter subgroup $\tau : \mathbb{G}_m \rightarrow G$ such that $\tau(1) = \text{Id} \in G$ and such that τ maps the generic point of \mathbb{G}_m to a point in O . Let S be the closure in $X' \times X' \times \mathbb{P}^1$ of the set $\{(x', t) \in U \times \mathbb{G}_m \mid (\pi \times \pi)(x') \in \tau(t) \cdot \Delta_X\}$. Let $p : X' \times X' \times \mathbb{P}^1 \rightarrow X' \times X'$ be the projection onto $X' \times X'$ and let $f : S \rightarrow \mathbb{P}^1$ be the morphism induced by the projection of $X' \times X' \times \mathbb{P}^1$ onto \mathbb{P}^1 . As in [Ful98, Section 1.6], we denote by $S_t := p_*[f^{-1}(t)] \in Z_n(X' \times X')$ for any $t \in \mathbb{G}_m$. By construction the cycle $S_1 \in Z_n(X' \times X')$ is effective and its support contains the diagonal $\Delta_{X'}$ in $X' \times X'$, hence :

$$[\Delta_{X'}] \leq S_1 \in N_n(X' \times X')_{\mathbb{R}}.$$

Let $t \in \mathbb{G}_m$ such that $\tau(t) \in O$. Since $S_1 = S_t \in A_n(X' \times X')$ for any $t \in \mathbb{P}^1$, we have thus :

$$[\Delta_{X'}] \leq S_t \in N_n(X' \times X')_{\mathbb{R}}.$$

Since the cycle $\tau(t) \cdot [\Delta_X]$ intersects properly every component of $X \times X \setminus V$ and since the restriction of $\pi \times \pi$ to $U = (\pi \times \pi)^{-1}(V)$ is flat over V , [Ful98, Example 11.4.8.(b)] asserts that the pullback of $(\pi \times \pi)^* \tau(t) \cdot [\Delta_X]$ is rationally equivalent to the cycle $[(\pi \times \pi)^{-1}_U(\tau(t) \cdot \Delta_X)]$. We have thus :

$$S_t = [(\pi \times \pi)^{-1}_U(\tau(t) \cdot \Delta_X)] = (\pi \times \pi)^* [\Delta_X] \in A_n(X' \times X').$$

Hence :

$$[\Delta_{X'}] \leq (\pi \times \pi)^* [\Delta_X] \in N_n(X' \times X')_{\mathbb{R}}.$$

□

Proof of Lemma 1.7.1.3. Observe that one has the following commutative diagram :

$$\begin{array}{ccccc}
 & & X' & & \\
 & & \downarrow \pi & & \\
 & & \Gamma_f & & \\
 & \swarrow \pi_1 & & \searrow \pi_2 & \\
 X_1 & \overset{f}{\dashrightarrow} & X_2 & & \\
 \downarrow q_1 & & & & \downarrow q_2 \\
 Y_1 & \overset{g}{\dashrightarrow} & Y_2 & & \\
 \swarrow \pi'_1 & & \searrow \pi'_2 & & \\
 & & \Gamma_g & &
 \end{array}$$

Fix a class $\beta \in \text{BPF}^{e+l-j}(X')$. By linearity and by Proposition 1.2.1.8, we can suppose that the class β is induced by a product of nef divisors $D_1 \cdot \dots \cdot D_{e_1+e+l-j}$ where D_i are nef divisors on X'_1 where $p : X'_1 \rightarrow X'$ is a flat morphism of relative dimension e_1 . The intersection $(\beta \cdot \pi^* \pi_2^* q_2^* H_{Y_2}^j)$ is thus given by the formula :

$$(\beta \cdot \pi^* \pi_2^* q_2^* H_{Y_2}^j) = (D_1 \cdot \dots \cdot D_{e_1+e+l-j} \cdot p^* \pi^* \pi_2^* q_2^* H_{Y_2}^j).$$

Take A an ample Cartier divisor on X'_1 and set $\alpha_\epsilon = (D_1 + \epsilon A) \cdot \dots \cdot (D_{e_1+e+l-j} + \epsilon A) \in N^{e_1+e}(X'_1)_{\mathbb{R}}$ for any $\epsilon > 0$. Since the class α_ϵ is a complete intersection and since the morphisms q_i are surjective, there exists a cycle $V_\epsilon \in Z_l(X'_1)_{\mathbb{R}}$ such that $\psi_{X'_1}(\alpha_\epsilon) = \{V_\epsilon\} \in N_l(X'_1)_{\mathbb{R}}$ and such that the restrictions of the morphisms $\pi_1 \circ \pi \circ p$ and $\pi_2 \circ \pi \circ p$ to the support of V_ϵ are surjective and generically finite onto Y_1 and Y_2 respectively. We apply Theorem 1.3.4.4 to the class $(p^* \pi^* \pi_2^* q_2^* H_{Y_2}^j)|_{V_\epsilon}$ and to $(p^* \pi^* \pi_1^* q_1^* H_{Y_1}^j)|_{V_\epsilon}$, we get :

$$p^* \pi^* \pi_2^* q_2^* H_{Y_2}^j \cdot \alpha_\epsilon \leq C \frac{(p^* \pi^* (\pi_2^* q_2^* H_{Y_2}^j \cdot \pi_1^* H_{Y_1}^{l-j}) \llcorner \{V_\epsilon\})}{(p^* \pi^* \pi_1^* q_1^* H_{Y_1}^l \llcorner \{V_\epsilon\})} \times p^* \pi^* \pi_1^* q_1^* H_{Y_1}^j \cdot \alpha_\epsilon \in N^{j+e_1+e}(X'_1)_{\mathbb{R}}.$$

By the projection formula applied to the morphism $\pi \circ p$, we have that

$$(p^* \pi^* (\pi_2^* q_2^* H_{Y_2}^j \cdot \pi_1^* H_{Y_1}^{l-j}) \llcorner \{V_\epsilon\}) / (p^* \pi^* \pi_1^* q_1^* H_{Y_1}^l \llcorner \{V_\epsilon\}) = \text{deg}_j(g) / (H_{Y_1}^l),$$

hence :

$$p^* \pi^* \pi_2^* q_2^* H_{Y_2}^j \cdot \alpha_\epsilon \leq C \frac{\text{deg}_j(g)}{(H_{Y_1}^l)} p^* \pi^* \pi_1^* q_1^* H_{Y_1}^j \cdot \alpha_\epsilon \in N^{j+e_1+e}(X'_1)_{\mathbb{R}}.$$

We intersect with the class $(D_{e_1+e+1} \cdot \dots \cdot D_{e_1+e+l-j}) \in N^{l-j}(X'_1)_{\mathbb{R}}$ and take the limit as ϵ tends to zero. We obtain :

$$(\beta \cdot \pi^* \pi_2^* q_2^* H_{Y_2}^j) = (D_1 \cdot \dots \cdot D_{e_1+e+l-j} \cdot p^* \pi^* \pi_2^* q_2^* H_{Y_2}^j) \leq C \frac{\text{deg}_j(g)}{(H_{Y_1}^l)} (\beta \cdot \pi^* \pi_1^* q_1^* H_{Y_1}^j),$$

as required. □

1.7.2 Submultiplicativity of mixed degrees

Definition 1.7.2.1. Let $X_1/q_1 Y_1 \xrightarrow{f/g} X_2/q_2 Y_2$ be rational maps where $e = \dim X_i - \dim Y_i$ and $l = \dim Y_i$ for $i = 1, 2$. We fix some ample divisors H_{X_i} and H_{Y_i} on each variety respectively. We define for any integer $0 \leq i \leq n$:

$$a_{i,j}(f) := \begin{cases} ((H_{Y_1}^{l-j} \cdot H_{X_1}^{e+j-i}) \lrcorner f^{\bullet,i}(H_{X_2}^i)) & \text{if } \max(0, i-e) \leq j \leq l, \\ 0 & \text{otherwise.} \end{cases}$$

Remark 1.7.2.2. For $j = 0$, it is the i -th relative degree $a_{i,0}(f) = \text{reldeg}_i(f)$ and when $j = l$, it corresponds to the i -th degree of f , $a_{i,l}(f) = \text{deg}_i(f)$.

Theorem 1.7.2.3. Let $q_1 : X_1 \rightarrow Y_1$, $q_2 : X_2 \rightarrow Y_2$, $q_3 : X_3 \rightarrow Y_3$ be three surjective morphisms such that $\dim X_i = e + l$ and $\dim Y_i = l$ for all $i \in \{1, 2, 3\}$. Then there exists a constant $C > 0$ such that for any rational maps $X_1/q_1 Y_1 \xrightarrow{f_1/g_1} X_2/q_2 Y_2$, $X_2/q_2 Y_2 \xrightarrow{f_2/g_2} X_3/q_3 Y_3$ and for all integers $0 \leq j_0 \leq l$:

$$a_{i,j_0}(f_2 \circ f_1) \leq C \sum_{\max(0, i-l) \leq j \leq \min(e, i)} \text{deg}_{i-j}(g_1) a_{i, i-j}(f_2) a_{j, j+j_0-i}(f_1).$$

Proof. Since we are in the same situation as Theorem 1.5.2.1, we can consider the diagram (1.19) and we keep the same notations. We denote by $n = e + l$ the dimension of X_i .

Let us denote by d the topological degree of the map f_2 . We apply Corollary 1.7.1.5 to the pliant class $\alpha := (1/d)v^*\pi_4^*H_{X_3}^i \in \text{BPF}^i(\Gamma)$, to the class $\beta := u^*\pi_1^*(H_{X_1}^{e-i+j_0} \cdot q_1^*H_{Y_1}^{l-j_0}) \in \text{BPF}^{n-i}(\Gamma)$ and to the morphism $\pi = \varphi \circ \pi_3 \circ v$. There exists a constant $C_1 > 0$ which depends only on the choice of divisors $H_{Y_2 \times \mathbb{P}^e}$ and H_{Y_2} such that :

$$a_{i,j_0}(f_2 \circ f_1) \leq C_1 \sum_{\max(0, i-l) \leq j \leq \min(e, i)} U_j(\pi_*\psi_\Gamma(\alpha))(\beta \cdot \pi^*(H_{X_2}^j \cdot q_2^*H_{Y_2}^{i-j})),$$

where $U_j(\gamma) = (H_{X_2}^{e-j} \cdot q_2^*H_{Y_2}^{l-i+j} \lrcorner \gamma)$ for any class $\gamma \in \mathbb{N}_{n-i}(X_2)_{\mathbb{R}}$. We observe that $U_j(\pi_*\psi_\Gamma(\alpha)) = a_{i, i-j}(f_2)$. We have thus :

$$a_{i,j_0}(f_2 \circ f_1) \leq C_1 \sum_{\max(0, i-l) \leq j \leq \min(e, i)} a_{i, i-j}(f_2) (u^*(\pi_1^*(H_{X_1}^{e-i+j_0} \cdot q_1^*H_{Y_1}^{l-j_0}) \cdot \pi_2^*(H_{X_2}^j \cdot q_2^*H_{Y_2}^{i-j}))). \quad (1.36)$$

Applying Lemma 1.7.1.3 to the class $u^*\pi_2^*q_2^*H_{Y_2}^{i-j} \in \text{BPF}^{i-j}(\Gamma)$ and to $\beta' = \beta \cdot u^*\pi_2^*H_{X_2}^j \in \text{BPF}^{n-i+j}(\Gamma)$, there exists a constant $C_2 > 0$ such that :

$$(\beta' \cdot u^*\pi_2^*q_2^*H_{Y_2}^{i-j}) \leq C_2 \text{deg}_{i-j}(g_1) (u^*(\pi_1^*(H_{X_1}^{e-i+j_0} \cdot q_1^*H_{Y_1}^{l-j_0+i-j}) \cdot \pi_2^*H_{X_2}^j)).$$

Since the map $u : \Gamma \rightarrow \Gamma_{f_1}$ is birational, we have that :

$$(u^*(\pi_1^*(H_{X_1}^{e-i+j_0} \cdot q_1^*H_{Y_1}^{l-j_0}) \cdot \pi_2^*(H_{X_2}^j \cdot q_2^*H_{Y_2}^{i-j}))) \leq C_2 \text{deg}_{i-j}(g_1) a_{j, j_0+j-i}(f_1). \quad (1.37)$$

Finally, (1.36) and (1.37) imply :

$$a_{i,j_0}(f_2 \circ f_1) \leq C \sum_{\max(0, i-l) \leq j \leq \min(e, i)} a_{i, i-j}(f_2) a_{j, j_0+j-i}(f_1) \text{deg}_{i-j}(g_1),$$

where $C = C_2 C_1 > 0$ is a constant which is independent of f_1 and f_2 as required. \square

1.7.3 Proof of Theorem 4

Recall that we want to prove the following formula :

$$\lambda_i(f) = \max_{j \leq i} (\lambda_j(f, X/Y) \lambda_{i-j}(g)).$$

By definition of the relative degrees, we are reduced to prove the theorem when $q : X \rightarrow Y$ is a proper surjective morphism. Recall that $\dim X = n$ and $\dim Y = l$ such that $q : X \rightarrow Y$ has relative dimension $e = n - l$. Let us consider the following commutative diagram :

$$\begin{array}{ccccc}
 & & \Gamma_f & & \\
 & \swarrow \pi_1 & & \searrow \pi_2 & \\
 X & \overset{f}{\dashrightarrow} & & \dashrightarrow & X \\
 \downarrow q & & \varpi & & \downarrow q \\
 Y & \overset{g}{\dashrightarrow} & & \dashrightarrow & Y \\
 & \swarrow \pi'_1 & & \searrow \pi'_2 & \\
 & & \Gamma_g & &
 \end{array} \tag{1.38}$$

where $f : X \dashrightarrow X$, $g : Y \dashrightarrow Y$ are dominant rational maps, Γ_f, Γ_g are the normalization of the graph of f and g respectively, $\pi_1, \pi_2, \pi'_1, \pi'_2$ are the projections from Γ_f and Γ_g onto the first and second factor respectively and $\varpi : \Gamma_f \rightarrow \Gamma_g$ is the restriction of $q \times q$ to Γ_f .

The following lemma proves that $\max_{j \leq i} (\lambda_j(f, X/Y) \lambda_{i-j}(g)) \leq \lambda_i(f)$.

Lemma 1.7.3.1. *For any integer $\max(0, i - l) \leq j \leq \min(i, e)$, there exists a constant $C > 0$ such that for any rational map $X/qY \xrightarrow{f} X/qY$, we have $\deg_{i-j}(g) \operatorname{reldeg}_j(f) \leq C \deg_i(f)$.*

Granting the above lemma, then we obtain the lower bound on $\lambda_i(f)$ as :

$$\lambda_i(f) \geq \lambda_j(f, X/Y) \lambda_{i-j}(g).$$

Proof. It suffices to consider the product $(\pi_1^*(H_X^{e-j} \cdot q^* H_Y^{l-i+j}) \cdot \pi_2^*(H_X^j \cdot q^* H_Y^{i-j}))$. Since $\pi_i \circ q = \varpi \circ \pi'_i$ for $i \in \{1, 2\}$, we obtain :

$$(\pi_1^*(H_X^{e-j} \cdot q^* H_Y^{l-i+j}) \cdot \pi_2^*(H_X^j \cdot q^* H_Y^{i-j})) = (\varpi^*(\pi_1'^* H_Y^{l-i+j} \cdot \pi_2'^* H_Y^{i-j}) \cdot \pi_1^* H_X^{e-j} \cdot \pi_2^* H_X^j).$$

Moreover, one has that $\pi_1'^* H_Y^{l-i+j} \cdot \pi_2'^* H_Y^{i-j} = (\pi_1'^* H_Y^{l-i+j} \cdot \pi_2'^* H_Y^{i-j}) [p_0] = \deg_{i-j}(g) [p_0]$ where p_0 is a general point in Γ_g . We can hence apply Proposition 1.4.3.1 to the morphism $\varpi : \Gamma_f \rightarrow \Gamma_g$ and obtain :

$$(\pi_1^*(H_X^{e-j} \cdot q^* H_Y^{l-i+j}) \cdot \pi_2^*(H_X^j \cdot q^* H_Y^{i-j})) = \deg_{i-j}(g) (\pi_1^* H_X^{e-j} \cdot \pi_2^* H_X^j \llcorner [\Gamma_{f_{p_0}}]).$$

Since π_1' is a birational morphism, a general fiber of ϖ is equal to a general fiber of $\pi_1' \circ \varpi$. In other words, we have that $\operatorname{Res}_{\Gamma_f/\Gamma_g} = \operatorname{Res}_{\Gamma_f/Y}$ and since $\pi_1^* H_X^{e-j} \cdot \pi_2^* H_X^j \llcorner [\Gamma_{f_{p_0}}] = \operatorname{Res}_{\Gamma_f/\Gamma_g} (\pi_1'^* H_X^{e-j} \cdot \pi_2'^* H_X^j)$, we obtain :

$$(\pi_1^*(H_X^{e-j} \cdot q^* H_Y^{l-i+j}) \cdot \pi_2^*(H_X^j \cdot q^* H_Y^{i-j})) = \deg_{i-j}(g) \times \operatorname{reldeg}_j(f).$$

As H_X is ample, we apply Theorem 1.3.3.3 to the classes $\pi_2^* q^* H_Y$ and $\pi_2^* H_X$:

$$\pi_2^* q^* H_Y^{i-j} \leq (n - i + j + 1)^{i-j} \frac{(\pi_2^* q^* H_Y^{i-j} \cdot \pi_2^* H_X^{n-i+j})}{(\pi_2^* H_X^n)} \pi_2^* H_X^{i-j} = C_1 \pi_2^* H_X^{i-j} \in N^{i-j}(X)_{\mathbb{R}},$$

where $C_1 = (n - i + j + 1)^{i-j} (q^* H_Y^{i-j} \cdot H_X^{n-i+j}) / (H_X^n)$ depends only on n, i and the choice of big nef Cartier divisors. Intersecting with $\pi_1^* H_X^{n-i} \cdot \pi_2^* H_X^j$, one obtains :

$$\deg_{i-j}(g) \cdot \text{reldeg}_j(f) \leq C_1 (\pi_2^* H_X^i \cdot \pi_1^* (H_X^{e-j} \cdot q^* H_Y^{l-i+j})).$$

By the same argument, there exists a constant $C_2 > 0$ which depends only on H_Y, H_X and i such that :

$$\pi_1^* q^* H_Y^{l-i+j} \leq C_2 \pi_1^* H_X^{l-i+j}.$$

Hence, we obtain :

$$\deg_{i-j}(g) \text{reldeg}_j(f) \leq C \deg_i(f),$$

where $C = C_1 C_2$. □

Let us prove the converse inequality. We fix an integer $0 \leq i \leq n$. Let us apply Theorem 1.7.2.3 to $f_1 = f, f_2 = f^p, g_1 = g$ and $g_2 = g^p$, we can rewrite the inequality as :

$$a_{i,j_0}(f^{p+1}) \leq C \sum_{\max(0, i-e) \leq j \leq \min(i, l)} \deg_j(g) a_{i-j, j_0-j}(f) a_{i,j}(f^p). \quad (1.39)$$

Let us denote by $U_i(f)$ the column vector given by :

$$U_i(f) = (a_{i,j}(f))_{0 \leq j \leq l} = \begin{pmatrix} a_{i,0}(f) \\ \dots \\ a_{i,l}(f) \end{pmatrix}.$$

Let us also denote by $M_i(f)$ the $(l+1) \times (l+1)$ lower-triangular matrix given by :

$$M_i(f) := (\deg_j(g) a_{i-j, m-j}(f) \times \chi_{[i-e, \min(i, l)]}(j))_{0 \leq m \leq l, 0 \leq j \leq l},$$

where χ_A denotes the characteristic function of the set A . Therefore, (1.39) can be rewritten as :

$$U_i(f^{p+1}) \leq C M_i(f) \cdot U_i(f^p),$$

where \cdot denotes the linear action on \mathbb{Z}^{l+1} . A simple induction proves :

$$U_i(f^p) \leq C^p (M_i(f))^{p-1} \cdot U_i(f)$$

Since the $(l+1)$ -th entry of the vector $U_i(f^p)$ corresponds to $\deg_i(f^p)$, we deduce that :

$$\deg_i(f^p)^{1/p} \leq C \langle e_l, (M_i(f))^p \cdot U_i(f) \rangle^{1/p}, \quad (1.40)$$

where (e_0, \dots, e_l) denotes the canonical basis of \mathbb{Z}^{l+1} . In particular, $\deg_i(f^p)^{1/p}$ is controlled up to a constant by the eigenvalues of the matrix $M_i(f)$ which are $\deg_j(g) \text{reldeg}_{i-j}(f)$ for $\max(0, i-e) \leq j \leq \min(i, l)$ since $M_i(f)$ is lower-triangular. Applying (1.40) to f^r , we get :

$$\deg_i(f^{pr})^{1/(pr)} \leq C^{1/r} \|U_i(f^r)\|^{1/pr} \max_{\max(0, i-e) \leq j \leq \min(i, l)} (\deg_j(g^r) \text{reldeg}_{i-j}(f^r))^{1/r}.$$

We conclude by taking the lim sup as $r \rightarrow +\infty, p \rightarrow +\infty$:

$$\lambda_i(f) \leq \max_{\max(0, i-l) \leq j \leq \min(i, e)} \lambda_{i-j}(g) \lambda_j(f, X/Y).$$

Remark 1.7.3.2. Note that the previous theorem gives information only on the dynamical degrees of f . Lemma 1.7.3.1 provides a lower bound on the degree of f^p . However, one cannot find an upper bound for $\deg_i(f^p)$ which would only depend on the relative degrees and the degree on the base. If $X = E \times E$ is a product of two elliptic curves and if $f : (z, w) \in E \times E \rightarrow (z, z+w)$ is an automorphism of X , then the degree growth of f^p is equivalent to p^2 whereas the degree on the base and on any fiber are trivial.

1.8 Kähler case

We prove the submultiplicativity of the k -th degrees in the case where (X, ω) is a complex compact Kähler manifold. For any closed smooth (p, q) -form α on X , we denote by $\{\alpha\}$ its class in the Dolbeault cohomology $H^{p,q}(X)_{\mathbb{R}}$.

Definition 1.8.0.1. *Let (X, ω) be a compact Kähler manifold. A class $\alpha \in H^{1,1}(X)_{\mathbb{R}}$ is nef if for any $\epsilon > 0$, the class $\alpha + \epsilon\{\omega\}$ is represented by a Kähler metric.*

A class α of degree (i, i) is pseudo-effective if it can be represented by a closed positive current T . Moreover, one says that α is big if there exists a constant $\delta > 0$ such that $T - \delta\omega$ is a closed positive current and we write $T \geq \delta\omega^i$.

Theorem 1.8.0.2. *(cf [Xia15a, Remark 3.1], [Pop15]) Let (X, ω) be a compact Kähler manifold of dimension n . Let k be an integer and α, β be two nef classes in $H^{1,1}(X)$ such that $\alpha^i \in H^{i,i}(X)$ is big and such that $\int_X \alpha^n - \binom{n}{i} \int_X \alpha^{n-i} \wedge \beta^i > 0$. Then the class $\alpha^i - \beta^i$ is big.*

Recall that the degree of a meromorphic selfmap $f : X \dashrightarrow X$ when (X, ω) is given by :

$$\deg_i(f) := \int_{\Gamma_f} \pi_1^* \omega^{n-i} \wedge \pi_2^* \omega^i,$$

where Γ_f is the desingularization of the graph of f and π_j are the projections from Γ_f onto the first and the second factor respectively.

Remark 1.8.0.3. When X is a projective variety and ω represents the class of a hyperplane section H_X , then the intersection of the form coincides with the cup-product in cohomology, hence $\deg_i(f) = \deg_{i, H_X}(f)$.

Corollary 1.8.0.4. *Let (X_1, ω_{X_1}) , (X_2, ω_{X_2}) and (X_3, ω_{X_3}) be some compact Kähler manifolds of dimension n . Then there exists a constant $C > 0$ which depends only on the choice of the Kähler classes ω_{X_j} such that for any dominant meromorphic maps $f_1 : X_1 \dashrightarrow X_2$ and $f_2 : X_2 \dashrightarrow X_3$, one has :*

$$\deg_i(f_2 \circ f_1) \leq C \deg_i(f_1) \deg_i(f_2).$$

Moreover, the constant C may be chosen to be equal to $\binom{n}{i} / (\int_{X_2} \omega_{X_2}^n)$.

Proof. The previous theorem gives that for any big nef class $\beta^i \in H^{i,i}(X)$, for any nef class $\alpha \in H^{1,1}(X)$, one has :

$$\alpha^i \leq \binom{n}{i} \frac{\int_X \alpha^i \wedge \beta^{n-i}}{\int_X \beta^n} \times \beta^i. \quad (1.41)$$

Then, the proof is formally the same as Theorem 1.5.2.1. Indeed, one only needs to consider the diagram (1.19) where $Y_1 = Y_2 = Y_3$ are reduced to a point and where $\Gamma_{f_1}, \Gamma_{f_2}, \Gamma$ are the desingularizations of the graph of f_1, f_2 and $\pi_3^{-1} \circ f_1 \circ \pi_1$ respectively. We apply (1.41) to $\alpha = v^* \pi_4^* \omega_{X_3}$ and $\beta = v^* \pi_3^* \omega_{X_2}$ to obtain :

$$v^* \pi_4^* \omega_{X_3}^i \leq \binom{n}{i} \frac{\deg_i(f_2)}{\int_{X_2} \omega_{X_2}^n} \times v^* \pi_3^* \omega_{X_2}^i.$$

By intersecting the previous inequality with the class $u^* \pi_1^* \omega_{X_1}^{n-i}$, we finally get :

$$\deg_i(f_2 \circ f_1) \leq \binom{n}{i} \frac{\deg_i(f_2) \deg_i(f_1)}{\int_{X_2} \omega_{X_2}^n}.$$

□

1.9 Comparison with Fulton's approach

In [Ful98, Chapter 19], a cycle $z \in Z_i(X)$ on a variety X is defined to be numerically trivial if $(c \lrcorner z)$ for any product $c = c_{i_1}(E_1) \cdots c_{i_p}(E_p) \in A^i(X)$ of Chern classes $c_{i_j}(E_j)$ where E_j is a vector bundle on X and $i_1 + \cdots + i_p = i$. This appendix is devoted to the proof of the following result :

Theorem 1.9.1. *Let X be a normal projective variety of dimension n . For any $z \in Z_i(X)$, the following conditions are equivalent :*

- (i) *For any product of Chern classes $c = c_{i_1}(E_1) \cdots c_{i_p}(E_p) \in A^i(X)_{\mathbb{R}}$ where E_j are vector bundles on X and $i_1 + \cdots + i_p = i$, we have $(c \lrcorner z) = 0$.*
- (ii) *For any integer e , any flat morphism $p_1 : X_1 \rightarrow X$ of relative dimension e where X_1 is a projective scheme and any Cartier divisors D_1, \dots, D_{e+i} on X_1 , we have $(D_1 \cdots D_{e+i} \lrcorner p_1^* z) = 0$.*
- (iii) *For any integer e , any flat morphism $p_1 : X_1 \rightarrow X$ of relative dimension e between normal projective varieties and any Cartier divisors D_1, \dots, D_{e+i} on X_1 , we have $(D_1 \cdots D_{e+i} \lrcorner p_1^* z) = 0$.*

The implication (ii) \Rightarrow (i) follows immediately from the definition of Chern classes. The implication (ii) \Rightarrow (iii) is also straightforward. For the converse implications (i) \Rightarrow (ii) and (i) \Rightarrow (iii), we rely on the following proposition.

Proposition 1.9.2. *Let $q : X \rightarrow Y$ be a flat morphism of relative dimension e where X is a projective scheme and Y is a normal projective variety. For any Cartier divisors D_1, \dots, D_{e+i} be some ample Cartier divisors on X , there exist vector bundles E_j , and a homogeneous polynomial $c = P(c_{i_1}(E_1), \dots, c_{i_p}(E_p))$ of degree i with respect to the weight (i_1, \dots, i_p) , with rational coefficients such that for any cycle $z \in Z_i(X)$, $(c \cdot z) = (D_1 \cdots D_{e+i} \cdot q^* z)$.*

Proof. We take some ample Cartier divisors D_1, \dots, D_{e+i} on X . We denote by \mathcal{L}_i the line bundle $\mathcal{O}_X(D_i)$. By Grauert's Theorem (cf [Har77, Corollary 12.9]), the sheaves $R^i q_*(\mathcal{L}_1^{m_1} \otimes \cdots \otimes \mathcal{L}_{e+i}^{m_{e+i}})$ are locally free. By [Har77, Theorem 8.8], we have that $R^i q_*(\mathcal{L}_1^{m_1} \otimes \cdots \otimes \mathcal{L}_{e+i}^{m_{e+i}}) = 0$ for $i > 0$ and m_i large enough since the line bundle \mathcal{L}_i are ample. So the sheaf $q_*(\mathcal{L}_1^{m_1} \otimes \cdots \otimes \mathcal{L}_{e+i}^{m_{e+i}})$ is locally free and we have in $K_0(Y)$:

$$q_*[\mathcal{L}_1^{m_1} \otimes \cdots \otimes \mathcal{L}_{e+i}^{m_{e+i}}] = \sum (-1)^i [R^i q_*(\mathcal{L}_1^{m_1} \otimes \cdots \otimes \mathcal{L}_{e+i}^{m_{e+i}})] = [q_*(\mathcal{L}_1^{m_1} \otimes \cdots \otimes \mathcal{L}_{e+i}^{m_{e+i}})]. \quad (1.42)$$

Lemma 1.9.3. *For any $j \leq i$:*

1. *The function $(m_1, \dots, m_{e+i}) \rightarrow \text{ch}_j(q_*(\mathcal{L}_1^{m_1} \otimes \cdots \otimes \mathcal{L}_{e+i}^{m_{e+i}})) \in N^j(Y)_{\mathbb{R}}$ is a polynomial of degree $e + j$ with coefficients in $N^j(Y)$.*
2. *For any cycle $z \in Z_j(Y)$, the coefficient in $m_1 \cdots m_{e+i}$ in $(\text{ch}_j(q_*(\mathcal{L}_1^{m_1} \otimes \cdots \otimes \mathcal{L}_{e+i}^{m_{e+i}})) \lrcorner z)$ is $((D_1 \cdots D_{e+i}) \lrcorner q^* z)$.*

Proof. Let us set $\mathcal{F} = \mathcal{L}_1^{m_1} \otimes \cdots \otimes \mathcal{L}_{e+i}^{m_{e+i}}$. We prove the result by induction on $0 \leq j \leq i$.

For $j = 0$, choosing a point $y \in Y(k)$, the number $\text{ch}_0(q_*(\mathcal{F}))$ is equal to $h^0(X_y, \mathcal{F}|_{X_y})$. By asymptotic Riemann-Roch, for m_1, \dots, m_{e+i} large enough, it is a polynomial of degree $\dim X_y = e$. Moreover, Snapper's theorem (see [Deb01, Definition 1.7]) states that the coefficient in $m_1 \cdots m_{e+i}$ is the number $(D_1 \cdots D_{e+i} \lrcorner [X_y])$.

We suppose by induction that $\text{ch}_i(q_*(\mathcal{F}))$ is a polynomial of degree $e + i$ for any $i \leq j$ where $j \leq i - 1$. For any subvariety V of dimension $j + 1$ in Y , we denote by W its scheme-theoretic preimage by q .

For any scheme V , let us denote by τ_V the morphisms :

$$\tau_V : K_0(V) \otimes \mathbb{Q} \rightarrow A_\bullet(V) \otimes \mathbb{Q}.$$

We refer to [Ful98, Theorem 18.3] for the construction of this morphism and its properties. We apply Grothendieck-Riemann-Roch's theorem for singular varieties (see [Ful98, Theorem 18.3.(1)]) and using (1.42), we get in $A_\bullet(Y)_\mathbb{Q}$:

$$\mathrm{ch}(q_*(\mathcal{L}_1^{m_1} \otimes \dots \otimes \mathcal{L}_{e+i}^{m_{e+i}})) \lrcorner \tau_V(\mathcal{O}_V) = q_*(\mathrm{ch}(\mathcal{L}_1^{m_1} \otimes \dots \otimes \mathcal{L}_{e+i}^{m_{e+i}}) \lrcorner \tau_W(\mathcal{O}_W)). \quad (1.43)$$

The term in $A_0(Y)_\mathbb{Q}$ in the left handside of the previous equation is equal to :

$$\mathrm{ch}_{j+1}(q_*(\mathcal{F})) \lrcorner [V] + \sum_{i \leq j} \mathrm{ch}_i(q_*(\mathcal{F})) \lrcorner \tau_{V,i}(\mathcal{O}_V),$$

where $\tau_{V,i}(\mathcal{O}_V)$ is the term in $A_i(Y)$ of $\tau_V(\mathcal{O}_V)$. By the induction hypothesis, every $\mathrm{ch}_i(q_*\mathcal{F})$ is a polynomial of degree $e+i$, and the right hand side of equation (1.43) is a polynomial of degree $e+j+1$, so $\mathrm{ch}_{j+1}(q_*(\mathcal{L}_1^{m_1} \otimes \dots \otimes \mathcal{L}_{e+i}^{m_{e+i}}))$ is also a polynomial of degree $e+j+1$. Now we identify the coefficients in $m_1 \dots m_{e+i}$ of the term in $N_0(Y)$ in equation (1.43). It follows from [Ful98, example 18.3.11] that $\tau_W(\mathcal{O}_W) = [W] + R_W$ where R_W is a linear combination of cycles of dimension $< e+i$. Therefore, the coefficient in $m_1 \dots m_{e+i}$ of the right hand side of equation (1.43) in $N_0(Y)$ is $((D_1 \dots D_{e+i}) \lrcorner [W])$ if $j+1 = i$ or 0 otherwise.

We have proved that the coefficient of $\mathrm{ch}_{j+1}(q_*(\mathcal{L}_1^{m_1} \otimes \dots \otimes \mathcal{L}_{e+i}^{m_{e+i}})) \lrcorner [V]$ is $((D_1 \dots D_{e+i}) \lrcorner [W])$ if $\dim V = i$ or 0 otherwise. Extending it by linearity, one gets the desired result. \square

We have that $\mathrm{ch}_i(q_*(\mathcal{L}_1^{m_1} \otimes \dots \otimes \mathcal{L}_{e+i}^{m_{e+i}}))$ is by definition a polynomial in Chern classes of vector bundles on Y . Using the previous lemma, the coefficient $U(D_1, \dots, D_{e+i})$ in $m_1 \dots m_{e+i}$ of $\mathrm{ch}_i(q_*(\mathcal{L}_1^{m_1} \otimes \dots \otimes \mathcal{L}_{e+i}^{m_{e+i}}))$ is equal to $P(c_{i_1}(E_1), \dots, c_{i_p}(E_p))$ where P is a homogeneous polynomial with rational coefficients of degree i with respect to the weight (i_1, \dots, i_p) and E_i are vector bundles on Y . We have proven that for any cycle $z \in Z_i(Y)$:

$$(P(c_{i_1}(E_1), \dots, c_{i_p}(E_p)) \lrcorner z) = ((D_1 \dots D_{e+i}) \lrcorner q^*z).$$

As any Cartier divisor can be written as a difference of ample Cartier divisors. The proposition provides a proof for the implication (i) \Rightarrow (ii) of Theorem 1.9.1. \square

Remark 1.9.4. In codimension 1, the intersection product $(D_1 \dots D_{e+1} \lrcorner q^*z)$ is represented by Deligne's product $I_X(\mathcal{O}_X(D_1), \dots, \mathcal{O}_X(D_{e+1})) \in N^1(X)_\mathbb{R}$ (see [Gar00] for a reference). Indeed, one has by [Gar00, Section 6] that for any cycle $z \in N_1(X)$:

$$c_1(I_X(\mathcal{O}_X(D_1), \dots, \mathcal{O}_X(D_{e+1}))) \lrcorner z = D_1 \dots D_{e+1} \lrcorner q^*z.$$

This gives an answer to the question of numerical pullback formulated in [FL14b, section 1.2].

Corollary 1.9.5. *Let $q : X \rightarrow Y$ be a flat morphism of relative dimension e between normal projective varieties. Then the morphism $q^* : A_\bullet(Y)_\mathbb{Q} \rightarrow A_{e+\bullet}(X)_\mathbb{Q}$ induces a morphism of abelian groups $q^* : N_\bullet(Y)_\mathbb{Q} \rightarrow N_{e+\bullet}(X)_\mathbb{Q}$. By duality, the morphism $q_* : A^\bullet(X)_\mathbb{Q} \rightarrow A^{\bullet-e}(Y)_\mathbb{Q}$ induces a morphism of abelian groups $q_* : N^\bullet(X)_\mathbb{Q} \rightarrow N^{\bullet-e}(Y)_\mathbb{Q}$.*

Chapitre 2

Positivity of convex valuations on convex bodies and invariant valuations by linear actions (en commun avec Jian Xiao)

Introduction

Let E be a Euclidian real vector space of dimension n , and let $\mathcal{K}(E)$ be the family of convex bodies (i.e., compact closed convex subsets) of E . We endow the space $\mathcal{K}(E)$ with the Hausdorff metric, that is, for any $K, L \in \mathcal{K}(E)$ the distance is defined by

$$d_H(K, L) = \min\{\varepsilon > 0 \mid K \subset L + \varepsilon\mathbf{B} \ \& \ L \subset K + \varepsilon\mathbf{B}\},$$

where \mathbf{B} is the unit ball in E . A real (convex) valuation ϕ on E is a function $\phi : \mathcal{K}(E) \rightarrow \mathbb{R}$ such that

$$\phi(K \cup L) = \phi(K) + \phi(L) - \phi(K \cap L)$$

for any $K, L \in \mathcal{K}(E)$ satisfying $K \cup L \in \mathcal{K}(E)$. Moreover, a valuation ϕ is called *translation invariant* if $\phi(K + t) = \phi(K)$ for any $K \in \mathcal{K}(E)$ and any $t \in E$, and it is called *continuous* if it is continuous with respect to the topology of $\mathcal{K}(E)$ given by the metric d_H . We denote by $\text{Val}(E)$ the Banach space of continuous, translation invariant valuations on E where the norm of $\phi \in \text{Val}(E)$ is given by :

$$\|\phi\| := \sup_{K \subset \mathbf{B}} |\phi(K)|, \tag{2.1}$$

where the supremum is taken over all convex bodies K contained in the unit ball \mathbf{B} .

A valuation $\phi \in \text{Val}(E)$ is called homogeneous of degree i , where $0 \leq i \leq n$, if for any $K \in \mathcal{K}(E)$ and any $\lambda \geq 0$, one has :

$$\phi(\lambda K) = \lambda^i \phi(K).$$

The subspace of $\text{Val}(E)$ of homogeneous valuations of degree i is denoted by $\text{Val}_i(E)$. By a theorem of McMullen (see [McM77]), there is a decomposition of $\text{Val}(E)$ in terms of $\text{Val}_i(E)$ given by :

$$\text{Val}(E) = \bigoplus_{i=0}^n \text{Val}_i(E).$$

The most basic examples of homogeneous valuations of degree i are given by the mixed volumes

$$K \mapsto V(L_1, \dots, L_{n-i}, K[i])$$

where $L_1, \dots, L_{n-i} \in \mathcal{K}(E)$ and the symbol $V(-)$ denotes the mixed volume of convex bodies, and $K[i]$ means that the convex body K is repeated i times in the expression of the mixed volume.

The space of valuations contains a dense subspace called the space of smooth valuations. We recall the definition of this space. The Lie group $\mathrm{GL}(E)$ has a natural action on $\mathrm{Val}(E)$:

$$\begin{aligned} \mathrm{GL}(E) \times \mathrm{Val}(E) &\rightarrow \mathrm{Val}(E), \\ (g, \phi) &\mapsto g \cdot \phi, \end{aligned}$$

where $g \cdot \phi(K) := \phi(g^{-1}K)$ for any $K \in \mathcal{K}(E)$ (see [Ale01]). The valuation ϕ is called *smooth* if the map $g \mapsto g \cdot \phi$ is smooth. We denote by $\mathrm{Val}^\infty(E)$ the subset of $\mathrm{Val}(E)$ of smooth translation invariant valuations, and by $\mathrm{Val}_i^\infty(E)$ the smooth translation invariant valuations which are homogeneous of degree i . Similar to the decomposition for $\mathrm{Val}(E)$, one also has

$$\mathrm{Val}^\infty(E) = \bigoplus_{i=0}^n \mathrm{Val}_i^\infty(E).$$

We now introduce the following key notion of positivity for convex valuations. For any positive Radon measure μ on $\mathcal{K}(E)^{n-i}$ such that

$$\int_{\mathcal{K}(E)^{n-i}} V(\mathbf{B}[i], K_1, \dots, K_{n-i}) d\mu(K_1, \dots, K_{n-i}) < +\infty,$$

we define a valuation ϕ_μ given by

$$\phi_\mu(L) = \int_{\mathcal{K}(E)^{n-i}} V(L[i], K_1, \dots, K_{n-i}) d\mu(K_1, \dots, K_{n-i}).$$

Observe that the dominated convergence theorem ensures the fact that ϕ_μ is a continuous translation invariant valuation. Moreover, such a valuation is monotone in the sense that if $K \subset L \in \mathcal{K}(E)$ then $\phi(K) \leq \phi(L)$. Note that the linear map $\mu \rightarrow \phi_\mu$ is not injective.

A valuation $\phi \in \mathrm{Val}_i(E)$ is said to be \mathcal{P} -positive if there exists a measure μ as above such that $\phi = \phi_\mu$. We denote by $\mathcal{P}_i \subset \mathrm{Val}_i(E)$ the set of \mathcal{P} -positive homogeneous valuations of degree i .

Example 2.0.0.1. The set of positive linear combinations of mixed volumes of degree i is contained in \mathcal{P}_i .

Remark 2.0.0.2. We emphasize that the positivity notation introduced above is different from (and stronger than) the positivity in the traditional setting. In the traditional setting, a valuation $\phi \in \mathrm{Val}(E)$ is called positive if $\phi(K) \geq 0$ for any $K \in \mathcal{K}(E)$. Many interesting results on this kind of positive valuations have been obtained by Parapatits-Wannerer [PW13] and Bernig-Fu [BF11]. Note that a monotone valuation must be positive in this traditional sense. There are valuations which are positive in the traditional sense but not monotone, e.g., Kazarnovskii pseudo-volume in hermitian integral geometry (see [BF11]), and there are also valuations which are monotone but not \mathcal{P} -positive in our setting (see [Ber12, Section 5.5]).

By a polarization argument, a valuation $\phi \in \mathcal{P}_i$ defines a unique function on $\mathcal{K}(E)^i$:

$$\phi(L_1, \dots, L_i) = \frac{1}{i!} \left(\frac{\partial^i}{\partial t_1 \partial t_2 \dots \partial t_i} \right)_{|t_1=\dots=t_i=0^+} \phi(t_1 L_1 + \dots + t_i L_i),$$

where L_1, \dots, L_i are convex bodies. If $L_1 = \dots = L_i = L$, then $\phi(L_1, \dots, L_i) = \phi(L)$.

We say that a valuation $\phi \in \mathcal{P}_i$ is *strictly \mathcal{P} -positive* if there exists $\epsilon > 0$ such that

$$\phi(L_1, \dots, L_i) \geq \epsilon V(\mathbf{B}[n-i], L_1, \dots, L_i)$$

holds for any convex bodies L_1, \dots, L_i .

The convex cone \mathcal{P}_i generates a vector space $\mathcal{V}'_i \subset \text{Val}_i(E)$. For any $\phi \in \mathcal{V}'_i$, there is a signed Radon measure μ on $\mathcal{K}(E)^{n-i}$ such that its absolute value $|\mu|$ satisfies :

$$\int_{\mathcal{K}(E)^{n-i}} V(\mathbf{B}[i], K_1, \dots, K_{n-i}) d|\mu|(K_1, \dots, K_{n-i}) < +\infty.$$

The subspace \mathcal{V}'_i is endowed with an appropriate norm defined as follows.

Definition 2.0.0.3. For any $\phi \in \mathcal{V}'_i$, the norm $\|\cdot\|_{\mathcal{P}}$ is defined by

$$\|\phi\|_{\mathcal{P}} := \inf\{t \geq 0 \mid |\phi(L_1, \dots, L_i)| \leq tV(\mathbf{B}[n-i], L_1, \dots, L_i) \text{ for any } L_1, \dots, L_i \in \mathcal{K}(E)\}.$$

The fact that $\|\phi\|_{\mathcal{P}}$ is finite follows from the reverse Khovanskii-Teissier inequality [LX17] (see also Theorem 2.2.2.1). One of the main properties of the norm $\|\cdot\|_{\mathcal{P}}$ is that *the subspace $\mathcal{V}'_i \cap \text{Val}_i^\infty(E)$ forms a dense subspace in \mathcal{V}'_i with respect to this norm* (see Theorem 2.2.3.8).

Remark 2.0.0.4. The norm $\|\cdot\|_{\mathcal{P}}$ is inspired by complex geometry, the motivation is that the analogous notation for a cohomology class over a projective manifold measures the pseudo-effectivity of that class. In our setting, $\|\phi_\mu\|_{\mathcal{P}}$ measures the positivity of ϕ_μ .

Let $\mathcal{V}_i^{\mathcal{P}}$ be the completion of \mathcal{V}'_i with respect to the norm $\|\cdot\|_{\mathcal{P}}$. By definition, for any $L \subset \mathbf{B}$ we have $|\phi(L)| \leq \text{vol}(\mathbf{B})\|\phi\|_{\mathcal{P}}$, hence $\|\phi\| \leq \text{vol}(\mathbf{B})\|\phi\|_{\mathcal{P}}$. Thus there is a continuous injection

$$(\mathcal{V}_i^{\mathcal{P}}, \|\cdot\|_{\mathcal{P}}) \hookrightarrow (\text{Val}_i(E), \|\cdot\|).$$

A deep theorem of Alesker [Ale01] implies that the linear combinations of mixed volumes span a dense set in $\text{Val}(E)$. As a consequence, $\mathcal{V}_i^{\mathcal{P}}$ is dense in $\text{Val}_i(E)$ with respect to the norm $\|\cdot\|$. We do not know whether $\mathcal{V}_i^{\mathcal{P}}$ is dense in $\text{Val}_i(E)$ with respect to the norm $\|\cdot\|_{\mathcal{P}}$.

Besides the norm $\|\cdot\|_{\mathcal{P}}$, another norm $\|\cdot\|_{\mathcal{C}}$ induced by the cone structure is also defined on \mathcal{V}'_i . For any $\phi \in \mathcal{V}'_i$, $\|\phi\|_{\mathcal{C}}$ is given by

$$\|\phi\|_{\mathcal{C}} := \inf_{\phi = \phi_+ - \phi_-, \phi_{\pm} \in \mathcal{P}_i} (\phi_+(\mathbf{B}) + \phi_-(\mathbf{B})),$$

Its properties are also discussed in the paper (see Section 2.2.3). However, we do not know whether smooth valuations are dense in \mathcal{V}'_i for the topology induced by this cone norm.

Our first theorem shows that the convolution of valuations can be uniquely extended to $\mathcal{V}_i^{\mathcal{P}}$. Let us recall the convolution operation defined by Bernig-Fu [BF06] and studied further by Alesker [Ale11] on smooth valuations. By [BF06] (see also [Ale11]), there exists a unique continuous, symmetric bilinear map $*$ which is homogeneous of degree $-n$:

$$\begin{aligned} \text{Val}^\infty(E) \times \text{Val}^\infty(E) &\rightarrow \text{Val}^\infty(E), \\ (\phi, \varphi) &\mapsto \phi * \varphi, \end{aligned}$$

such that for any $K, L \in \mathcal{K}(E)$ with smooth and strictly convex boundary, one has that :

$$\text{vol}(\cdot + K) * \text{vol}(\cdot + L) = \text{vol}(\cdot + K + L) \in \text{Val}^\infty(E).$$

In particular, assume that $K_1, \dots, K_{n-i}, L_1, \dots, L_{n-j} \in \mathcal{K}(E)$ have smooth and strictly convex boundary, then

$$V(-; K_1, \dots, K_{n-i}) * V(-; L_1, \dots, L_{n-j}) = \frac{i!j!}{n!} V(-; K_1, \dots, K_{n-i}, L_1, \dots, L_{n-j}). \quad (2.2)$$

We can now state our first theorem (see Theorem 2.2.3.8 and Theorem 2.2.4.1).

Theorem 5. Fix two integers i, j such that $2n \geq i + j \geq n$. There exists a unique symmetric bilinear operator $\tilde{*} : \mathcal{V}_i^{\mathcal{P}} \times \mathcal{V}_j^{\mathcal{P}} \rightarrow \mathcal{V}_{i+j-n}^{\mathcal{P}}$ satisfying the following properties.

1. The operator $\tilde{*}$ is continuous with respect to the topology induced by the norm $\|\cdot\|_{\mathcal{P}}$.
2. The operator $\tilde{*}$ coincides with the convolution $*$ on $(\mathcal{V}_i^{\mathcal{P}} \cap \text{Val}_i^{\infty}(E)) \times (\mathcal{V}_j^{\mathcal{P}} \cap \text{Val}_j^{\infty}(E))$, and $\mathcal{V}_k^{\mathcal{P}} \cap \text{Val}_k^{\infty}(E)$ is dense in $\mathcal{V}_k^{\mathcal{P}}$ with respect to the topology induced by the norm $\|\cdot\|_{\mathcal{P}}$.

In particular, the space $(\bigoplus_{i=0}^n \mathcal{V}_i^{\mathcal{P}}, \tilde{*})$ is a commutative associative algebra with the unit given by the Lebesgue measure.

A priori, the convolution is only well defined on the space of smooth valuations $\text{Val}^{\infty}(E)$ and one cannot extend it continuously to $\text{Val}(E)$. Theorem 5 allows us to extend the operation with respect to a finer topology than the one in $\text{Val}_i(E)$.

Bernig-Faifman and Alesker-Bernig (see [BF16], [AB12]) studied another extension on the generalized valuations satisfying specified conditions, using the general theory of wave fronts. The space of generalized valuations, denoted by $\text{Val}^{-\infty}(E)$, is defined to be the dual of $\text{Val}^{\infty}(E)$. However, it is unclear how one can compare these two extensions.

Our extension is closely related to equation (2.2). Indeed, if μ and ν are two Radon measures on $\mathcal{K}(E)^{n-i}$ and $\mathcal{K}(E)^{n-j}$ respectively so that their associated valuations ϕ_{μ} and ϕ_{ν} belong to \mathcal{V}'_i and \mathcal{V}'_j respectively, then the valuation $\phi_{\mu} \tilde{*} \phi_{\nu} \in \mathcal{V}'_{i+j-n}$ is a valuation associated to the measure :

$$\frac{i!j!}{n!} p_1^* \mu \otimes p_2^* \nu,$$

where $p_1 : \mathcal{K}(E)^{2n-i-j} \rightarrow \mathcal{K}(E)^{n-i}$ and $p_2 : \mathcal{K}(E)^{2n-i-j} \rightarrow \mathcal{K}(E)^{n-j}$ are the projections onto the first $n-i$ factors and the last $n-j$ factors respectively. The formula for the valuation $\phi_{\mu} \tilde{*} \phi_{\nu}$ is given by :

$$\phi_{\mu} \tilde{*} \phi_{\nu}(-) := \frac{i!j!}{n!} \int_{\mathcal{K}(E)^{2n-i-j}} V(-; K_1, \dots, K_{n-i}, K'_1, \dots, K'_{n-j}) d\mu(K_1, \dots, K_{n-i}) d\nu(K'_1, \dots, K'_{n-j}),$$

which is always well defined by Proposition 2.2.2.4.

Let $L_1, \dots, L_{n-1} \in \mathcal{K}(E)$ be convex bodies with non-empty interior, by Minkowski's existence theorem (see [Ale38]), there exists a unique (up to a translation) convex body $L \in \mathcal{K}(E)$ with non-empty interior such that

$$V(L_1, \dots, L_{n-1}, -) = V(L[n-1], -).$$

Our next result can be considered as a variant of Minkowski's existence theorem (see Theorem 2.3.1.1 and Proposition 2.3.2.1).

Theorem 6. For any $\psi \in \mathcal{P}_i$ strictly \mathcal{P} -positive, then there is a constant $c > 0$ (depending only on ψ) and a convex body B with $\text{vol}(B) = 1$ such that

$$\psi \tilde{*} V(B[i-1], -) = cV(B[n-1], -) \in \text{Val}_1(E).$$

Moreover, up to translations the solution set

$$S = \{B \in \mathcal{K}(E) | \psi \tilde{*} V(B[i-1], -) = cV(B[n-1], -), \text{vol}(B) = 1\}$$

is compact in $\mathcal{K}(E)$ endowed with the Hausdorff metric.

Remark 2.0.0.5. When $i = 1$, the previous Theorem is just a consequence of Minkowski's existence theorem [Ale38, Sch14] (see Example 2.2.1.7).

Our next results focus on linear actions on valuations. We are interested in the behaviour of the sequence $\{g^k \cdot \phi\}_{k=1}^{\infty}$ where $\phi \in \mathcal{V}_{n-i}^{\mathcal{P}}$ and $g \in \mathrm{GL}(E)$. Given $g \in \mathrm{GL}(E)$, $\phi \in \mathcal{P}_{n-i}$ and $\psi \in \mathcal{P}_i$ two strictly \mathcal{P} -positive valuations, we define the i -th dynamical degree of g by

$$d_i(g) := \lim_{k \rightarrow \infty} ((g^k \cdot \phi) \tilde{*} \psi)^{1/k}.$$

The terminology ‘‘dynamical degree’’ comes from the study of dynamics of holomorphic maps, where these numbers are defined for rational self-maps on projective varieties. These two notions of dynamical degrees are closely related in the particular case of rational self-maps over toric varieties which preserve the torus action.

Note that g induces a linear operator (denoted by g_{n-i}) on the Banach space $(\mathcal{V}_{n-i}^{\mathcal{P}}, \|\cdot\|_{\mathcal{P}})$:

$$g_{n-i} : \mathcal{V}_{n-i}^{\mathcal{P}} \rightarrow \mathcal{V}_{n-i}^{\mathcal{P}}.$$

A direct application of the reverse Khovanski-Teissier inequality (see Theorem 2.2.2.1) and the method in [Dan17] shows that the number $d_i(g)$ is well-defined and is equal to the norm of the operator g_{n-i} . Our next theorem (see Theorem 2.4.1.9 and Theorem 2.4.2.1) relates the norm of g_{n-i} , the eigenvalues of g and the dynamical degrees.

Theorem 7. *Given $g \in \mathrm{GL}(E)$, the dynamical degree $d_i(g)$ exists and is independent of the choices of the strictly \mathcal{P} -positive valuations $\phi \in \mathcal{P}_{n-i}, \psi \in \mathcal{P}_i$. Moreover, assume that $\rho(g_{n-i})$ is the spectral radius of g_{n-i} and ρ_1, \dots, ρ_n are the eigenvalues of g satisfying*

$$|\rho_1| \geq |\rho_2| \geq \dots \geq |\rho_n|,$$

then the i -th dynamical degree $d_i(g) = \rho(g_{n-i}) = |\det g|^{-1} \prod_{k=1}^i |\rho_k|$.

Our proof relies on the observation that the dynamical degrees define continuous mappings from $\mathrm{GL}(E)$ to \mathbb{R} . We are then reduced to proving the Theorem 7 for diagonalizable matrices. Observe that our proof gives an alternative approach to the results of Lin (see [Lin12, Theorem 6.2]) and Favre-Wulcan (see [FW12, Corollary B]) which relied on Minkowski weights and integral geometry respectively.

We say that a valuation ϕ is $d_i(g)$ -invariant if it belongs to the eigenspace of eigenvalue $d_i(g)$ (i.e., $g \cdot \phi = d_i(g)\phi$).

By Alexandrov-Fenchel inequality or Theorem 7, it is clear that the sequence of dynamical degrees $\{d_i(g)\}$ is log-concave. In particular, $d_i(g)^2 \geq d_{i+s}(g)d_{i-s}(g)$. Our last theorem (see Theorem 2.5.2.1) gives some positivity properties of invariant valuations under a natural strict log-concavity assumption on these numbers.

Theorem 8. *Assume $2i \leq n$. Consider $g \in \mathrm{GL}(E)$. Then the following properties are satisfied.*

1. *There exists a non zero $d_i(g)$ -invariant valuation in $\overline{\mathcal{P}_{n-i}} \subset \mathcal{V}_{n-i}^{\mathcal{P}}$.*
2. *Assume that the strict log-concavity inequality is satisfied for some $s \leq \min(i, n-i)$:*

$$d_i(g)^2 > d_{i-s}(g)d_{i+s}(g),$$

then for any two $d_i(g)$ -invariant convex valuations $\phi_1, \phi_2 \in \mathcal{V}_{n-i}^{\mathcal{P}}$, we have

$$\phi_1 \tilde{*} \phi_2 = 0.$$

3. *Assume that*

$$d_1^2(g) > d_2(g),$$

then there exists a unique (up to a multiplication by a positive constant) $d_1(g)$ -invariant convex valuation $\phi \in \overline{\mathcal{P}_{n-1}} \subset \mathcal{V}_{n-1}^{\mathcal{P}}$. Moreover, ϕ lies in an extremal ray of $\overline{\mathcal{P}_{n-1}} \subset \mathcal{V}_{n-1}^{\mathcal{P}}$.

In the study of monomial maps, the conclusion of (3) implies also the existence of a unique invariant b -divisor class in the sense of [FW12]. The results (2) and (3) can be understood as the higher dimensional convex analog of a result by [BFJ08b] for projective surfaces. Given a projective surface X and a dominant rational map f on it. Suppose that the dynamical degree $d_1(f)$ and $d_2(f)$ satisfy $d_1(f)^2 > d_2(f)$, Boucksom, Favre and Jonsson proved the existence and the uniqueness (up to scaling) of two nef Weil-classes θ^+ and θ^- which are $d_1(f)$ -invariant by f^* and f_* respectively. They proved also that the self-intersection $\theta^+ \cdot \theta^+$ is equal to zero.

Remark 2.0.0.6. We remark that Theorem 7 and Theorem 8 also hold for the norm $\|\cdot\|_C$. As for Theorem 5, as we do not know if the density result (Theorem 2.2.3.8) holds for the norm $\|\cdot\|_C$, we have a slightly weaker version of Theorem 5 for this norm.

2.0.1 Organization of the chapter

In Section 2.1, we give a brief review of valuations on convex sets. Section 2.2 devotes to the study of some positivity results of convex valuations, and the continuous extension of the convolution operator. In Section 2.3, using the convolution operator we study a generalization of Minkowski's existence theorem. In Section 2.4, we use the positivity results to study the dynamical degree and calculate its value. In Section 2.5, we study the positivity of invariant valuations under a natural strict log-concavity assumption on certain dynamical degrees.

2.1 Preliminaries

2.1.1 Convex valuations

We first give a brief overview of valuations on convex sets. The classical references are [MS83, McM93]. We also refer the reader to the more recent surveys [Ale07], [AF14] and [Ber12]. Our general reference for convexity is [Sch14].

Let E be a Euclidian real vector space of dimension n . We denote the family of non-empty compact convex subsets of E by $\mathcal{K}(E)$. Then $\mathcal{K}(E)$ has a natural topology induced by the Hausdorff metric defined as follows :

$$d_H(K, L) := \inf\{\varepsilon > 0 \mid K \subset L + \varepsilon\mathbf{B} \ \& \ L \subset K + \varepsilon\mathbf{B}\},$$

where \mathbf{B} is the unit ball, where $K, L \in \mathcal{K}(E)$ and where $+$ is the Minkowski sum. By Blaschke selection theorem, $(\mathcal{K}(E), d_H)$ is a locally compact space. Moreover, by associating a convex set to its support function, $(\mathcal{K}(E), d_H)$ can be isometrically embedded into the function space $C^0(\mathbb{S}^{n-1})$ equipped with L^∞ -norm.

Definition 2.1.1.1. A functional $\phi : \mathcal{K}(E) \rightarrow \mathbb{R}$ is called a real convex valuation if

$$\phi(K \cup L) = \phi(K) + \phi(L) - \phi(K \cap L)$$

whenever $K, L, K \cup L \in \mathcal{K}(E)$.

Remark 2.1.1.2. The convex valuation is just called valuation in classical literatures, here we follow the terminology of [Ale07] because the valuation theory has been extended to not necessarily convex sets on manifolds.

Definition 2.1.1.3. A convex valuation ϕ is called continuous if ϕ is continuous with respect to the Hausdorff metric d_H ; A convex valuation ϕ is called translation-invariant if $\phi(K + x) = \phi(K)$ for any $K \in \mathcal{K}(E)$ and any $x \in E$.

Let us denote by $\text{Val}(E)$ the space of translation-invariant continuous valuations. The linear space $\text{Val}(E)$ has the natural topology given by a sequence of semi-norms :

$$\|\phi\|_N = \sup_{K \subset \mathbf{B}_N} |\phi(K)|,$$

where \mathbf{B}_N is the ball of radius N . This sequence of semi-norms defines a Fréchet space structure on $\text{Val}(E)$. Actually, $\text{Val}(E)$ is a Banach space endowed with the norm $\|\cdot\|_1$.

2.1.2 McMullen's grading decomposition

We recall McMullen's decomposition of the space of valuations $\text{Val}(E)$.

Definition 2.1.2.1. *A convex valuation ϕ is called α -homogeneous if $\phi(\lambda K) = \lambda^\alpha \phi(K)$ for any $\lambda \geq 0, K \in \mathcal{K}(E)$.*

Let us denote by $\text{Val}_\alpha(E)$ the subspace of $\text{Val}(E)$ of α -homogeneous convex valuations. The following result is due to McMullen [McM77].

Theorem 2.1.2.2 (McMullen decomposition). *Let $n = \dim E$, then*

$$\text{Val}(E) = \bigoplus_{i=0}^n \text{Val}_i(E).$$

Furthermore, every valuation ϕ can be decomposed uniquely into even and odd parts

$$\phi = \phi^{\text{even}} + \phi^{\text{odd}},$$

where $\phi^{\text{even}}(-K) = \phi^{\text{even}}(K)$, $\phi^{\text{odd}}(-K) = -\phi^{\text{odd}}(K)$ for every $K \in \mathcal{K}(E)$. Thus we have the following decomposition

$$\text{Val}(E) = \bigoplus_{i=0, \dots, n; i \in \{\text{even}, \text{odd}\}} \text{Val}_i^\epsilon(E).$$

Examples

Let us present some examples of convex valuations :

1. The Euler characteristic χ which satisfies $\chi(K) = 1$ for every $K \in \mathcal{K}(E)$ is a constant valuation.
2. The Lebesgue measure $\text{vol}(\cdot)$ belongs to $\text{Val}_n(E)$.
3. For any convex body A , the function $\phi : \mathcal{K}(E) \rightarrow \mathbb{R}$ defined by $\phi(K) = \text{vol}(K + A)$ is in $\text{Val}(E)$.
4. Let $K_1, \dots, K_r \in \mathcal{K}(E)$ be convex bodies, then there is a polynomial relation

$$\text{vol}(t_1 K_1 + \dots + t_r K_r) = \sum_{i_1 + \dots + i_r = n} \frac{n!}{i_1! i_2! \dots i_r!} V(K_1[i_1], \dots, K_r[i_r]) t_1^{i_1} \dots t_r^{i_r},$$

where $t_i \geq 0$ and $K_j[i_j]$ denotes i_j copies of K_j and where the coefficient $V(K_1[i_1], \dots, K_r[i_r])$ denotes the *mixed volume*. Fix $A_1, \dots, A_{n-k} \in \mathcal{K}(E)$, then the function $\psi : \mathcal{K}(E) \rightarrow \mathbb{R}$ defined by

$$\psi(K) := V(K[k], A_1, \dots, A_{n-k})$$

belongs to $\text{Val}_k(E)$.

2.1.3 Alesker's irreducibility theorem

The group $\mathrm{GL}(E)$ acts on $\mathrm{Val}(E)$ by

$$(g \cdot \phi)(K) = \phi(g^{-1}K).$$

Note that $\mathrm{Val}_i^{\mathrm{even}}$ (resp. $\mathrm{Val}_i^{\mathrm{odd}}$) is invariant under this action.

Example 2.1.3.1. Assume that $\phi \in \mathrm{Val}_i(E)$ is given by $\phi_{L_1, \dots, L_{n-i}}(K) := V(K[i], L_1, \dots, L_{n-i})$, then

$$\begin{aligned} (g \cdot \phi_{L_1, \dots, L_{n-i}})(K) &= V(g^{-1}(K)[i], L_1, \dots, L_{n-i}) \\ &= |\det g|^{-1} V(K[i], g(L_1), \dots, g(L_{n-i})) \\ &= |\det g|^{-1} \phi_{g(L_1), \dots, g(L_{n-i})}(K), \end{aligned}$$

which implies $g \cdot \phi_{L_1, \dots, L_{n-i}} = |\det g|^{-1} \phi_{g(L_1), \dots, g(L_{n-i})}$. In particular, if $|\det g| = 1$, then $g \cdot \phi_{L_1, \dots, L_{n-i}} = \phi_{g(L_1), \dots, g(L_{n-i})}$.

In the case of a general Radon measure μ on $\mathcal{K}(E)^{n-i}$ such that :

$$\int_{\mathcal{K}(E)^{n-i}} V(\mathbf{B}[i], g(L_1), \dots, g(L_{n-i})) d\mu(L_1, \dots, L_{n-i}) < +\infty,$$

we have

$$g \cdot \phi_\mu(K) = \frac{1}{|\det g|} \int_{\mathcal{K}(E)^{n-i}} V(K[i], g(L_1), \dots, g(L_{n-i})) d\mu(L_1, \dots, L_{n-i}).$$

In particular, if we set $g \cdot \mu(L_1, \dots, L_{n-i}) = \mu(g^{-1}(L_1), \dots, g^{-1}(L_{n-i}))$, then $g \cdot \phi_\mu = \frac{1}{|\det g|} \phi_{g \cdot \mu}$.

Alesker's irreducibility theorem [Ale01] is one of the milestones of the modern development of convex valuation theory, it can be stated as follows :

Theorem 2.1.3.2 (Alesker's irreducibility theorem). *As a $\mathrm{GL}(E)$ -module, the natural representation of $\mathrm{GL}(E)$ on the space $\mathrm{Val}_i^{\mathrm{even}}(E)$ and $\mathrm{Val}_i^{\mathrm{odd}}(E)$ is irreducible for every $i = 0, 1, \dots, n$ (that is, there is no proper closed $\mathrm{GL}(E)$ -invariant subspace).*

As an immediate consequence, the above irreducibility result implies McMullen's conjecture on mixed volumes : the valuations of the form $\phi(K) = \mathrm{vol}(K + A)$ span a dense subspace in $\mathrm{Val}(E)$; the mixed volumes span a dense subspace in $\mathrm{Val}(E)$. Moreover, the above theorem also implies in the same way that the linear combinations of valuations of the form $\phi(K) = V(K[i], \Delta[n-i])$, where Δ is a simplex in E , are dense in the space $\mathrm{Val}_i(E)$. Alesker's irreducibility theorem also enables us to define some explicit positive cones in $\mathrm{Val}_i(E)$ with nice properties.

2.1.4 Convolution and product of smooth valuations

Definition 2.1.4.1 (Alesker). *A valuation $\phi \in \mathrm{Val}(E)$ is called smooth if the map*

$$\mathrm{GL}(E) \rightarrow \mathrm{Val}(E), \quad g \mapsto g \cdot \phi$$

is smooth as a map from a Lie group to a Banach space.

As a smooth valuation ϕ induces a map $\mathrm{GL}(E) \rightarrow \mathrm{Val}(E)$ given by $g \mapsto g \cdot \phi \in \mathrm{Val}(E)$. The space of smooth valuations can be endowed with the topology of \mathcal{C}^∞ functions on $\mathrm{GL}(E)$ with

values in the Banach space $\text{Val}(E)$ (this is usually called the Garding topology). This topology is naturally stronger than the topology from $\text{Val}(E)$ since there is a continuous injection

$$\text{Val}^\infty(E) \hookrightarrow \text{Val}(E).$$

The space of smooth valuations is denoted by $\text{Val}^\infty(E)$, it is dense in $\text{Val}(E)$. Moreover, the representation of $\text{GL}(E)$ in $\text{Val}^\infty(E)$ is continuous (see e.g. [AF14]).

By McMullen's grading decomposition, we have

$$\text{Val}^\infty(E) = \bigoplus_{i=0, \dots, n; \epsilon \in \{\text{even}, \text{odd}\}} \text{Val}_i^{\epsilon, \infty}(E).$$

Example 2.1.4.2. Assume that $A_1, \dots, A_{n-i} \in \mathcal{K}(E)$ are strictly convex bodies with smooth boundary, then $\phi_{A_1, \dots, A_{n-i}}(-) = V(-[i]; A_1, \dots, A_{n-i})$ is in $\text{Val}_i^\infty(E)$.

Example 2.1.4.3 (G -invariant valuations). Let $G \subset \text{SO}(E)$ be a compact subgroup. Let $\text{Val}^G(E)$ be the subspace of $\text{Val}(E)$ of G -invariant convex valuations. By [Ale07, Proposition 2.6, 2.7] (see also [Ale04]), the space $\text{Val}^G(E)$ is finite dimensional if and only if G acts transitively on the unit sphere of E , and under the assumption that G acts transitively on the unit sphere of E one has $\text{Val}^G(E) \subset \text{Val}^\infty(E)$.

An crucial ingredient in recent development of valuation theory (or algebraic integral geometry) is the product structure introduced by Alesker [Ale04]. To define it, Alesker used his irreducibility theorem.

Definition 2.1.4.4 (Product). *There exists a bilinear map*

$$\text{Val}^\infty(E) \times \text{Val}^\infty(E) \rightarrow \text{Val}^\infty(E)$$

which is uniquely characterized by the following two properties :

1. *continuity ;*
2. *if $A, B \in \mathcal{K}(E)$ are strictly convex bodies with smooth boundary, then the product of $\phi_A(\cdot) = \text{vol}(\cdot + A)$, $\phi_B(\cdot) = \text{vol}(\cdot + B)$ is given by*

$$\phi_A \cdot \phi_B(K) = \text{vol}_{V \times V}(\Delta(K) + (A \times B)),$$

where $\Delta : E \rightarrow E \times E$ is the diagonal embedding.

The product makes $\text{Val}^\infty(E)$ a commutative associative algebra with the unit given by the Euler characteristic.

Example 2.1.4.5. (see [Ale04, Proposition 2.2]) Assume that A_1, \dots, A_{n-k} and B_1, \dots, B_k are strictly convex bodies with smooth boundary, then

$$V(-; A_1, \dots, A_{n-k}) \cdot V(-; B_1, \dots, B_k) = \frac{k!(n-k)!}{n!} V(A_1, \dots, A_{n-k}, -B_1, \dots, -B_k) \text{vol}(-).$$

The convolution on $\text{Val}^\infty(E)$ was introduced by Bernig and Fu in [BF06].

Definition 2.1.4.6 (Convolution). *There exists a bilinear map*

$$\text{Val}^\infty(E) \times \text{Val}^\infty(E) \rightarrow \text{Val}^\infty(E)$$

which is uniquely characterized by the following two properties :

1. *continuity ;*

2. if $A, B \in \mathcal{K}(E)$ are strictly convex bodies with smooth boundary, then the convolution of $\phi_A(\cdot) = \text{vol}(\cdot + A)$, $\phi_B(\cdot) = \text{vol}(\cdot + B)$ is given by

$$\phi_A * \phi_B(K) = \text{vol}(K + (A + B)).$$

The convolution makes $\text{Val}^\infty(E)$ a commutative associative algebra with the unit given by the Lebesgue measure.

The following formula of $*$ is important in its extension to arbitrary mixed volumes (see Section 2.2.4).

Example 2.1.4.7. (see [BF06, Corollary 1.3]) Assume that A_1, \dots, A_{n-k} and B_1, \dots, B_{n-l} are strictly convex bodies with smooth boundary, and $k + l \geq n$, then

$$V(-; A_1, \dots, A_{n-k}) * V(-; B_1, \dots, B_{n-l}) = \frac{k!l!}{n!} V(-; A_1, \dots, A_{n-k}, B_1, \dots, B_{n-l}).$$

The product and convolution of smooth valuations are dual to each other by Alesker's Fourier transform.

Theorem 2.1.4.8 (see [Ale11]). *There is an algebra isomorphism $\widehat{\cdot}: (\text{Val}^\infty(E), \cdot) \rightarrow (\text{Val}^\infty(E), *)$ such that*

$$\widehat{\phi \cdot \psi} = \widehat{\phi} * \widehat{\psi}, \quad \phi, \psi \in \text{Val}^\infty(E).$$

Remark 2.1.4.9. Comparing with the intersection theory in algebraic geometry, it is convenient to view $\text{Val}_i^\infty(E)$ as the group of numerical cycle classes of dimension i , then the convolution can be considered as the cup product of cohomology classes, the product can be considered as the intersection of cycles and Alesker-Fourier transform can be considered as Poincaré duality. In our setting, by Example 2.1.4.7 we find it convenient to apply convolution operation rather than product operation.

2.2 \mathcal{P} -Positive convex valuations

2.2.1 \mathcal{P} -Positivity of valuations

By Alesker's irreducibility theorem, we know that the mixed volumes span a dense subspace in $\text{Val}(E)$. Let $\phi \in \text{Val}_i(E)$, then for any $\varepsilon > 0$ there exist valuations given by mixed volumes and real numbers c_1, \dots, c_m such that

$$\|\phi - \sum_{k=1}^m c_k \psi_k\| \leq \varepsilon,$$

where $\psi_k(-) = V(-; K_1^k, \dots, K_{n-i}^k) \in \text{Val}_i(E)$ for some $K_1^k, \dots, K_{n-i}^k \in \mathcal{K}(E)$. This motivates the following definition for our positive cone.

For any positive Radon measure μ on $\mathcal{K}(E)^{n-i}$ such that

$$\int_{\mathcal{K}(E)^{n-i}} V(\mathbf{B}[i], K_1, \dots, K_{n-i}) d\mu(K_1, \dots, K_{n-i}) < +\infty,$$

Denote by ϕ_μ the map from $\mathcal{K}(E)$ to \mathbb{R} given by :

$$\phi_\mu(L) = \int_{\mathcal{K}(E)^{n-i}} V(L[i], K_1, \dots, K_{n-i}) d\mu(K_1, \dots, K_{n-i}),$$

where $L \in \mathcal{K}(E)$ is a convex body. We will see that for any Radon measure μ as above, the map ϕ_μ defines a continuous translation invariant valuation (see Lemma 2.2.1.4).

Definition 2.2.1.1. We define the convex cone $\mathcal{P}_i \subset \text{Val}_i(E)$ given by :

$$\mathcal{P}_i := \left\{ \phi_\mu \mid \phi_\mu(L) := \int_{\mathcal{K}(E)^{n-i}} V(L[i], K_1, \dots, K_{n-i}) d\mu(K_1, \dots, K_{n-i}) \right\},$$

where μ is taken over the positive Radon measures on $\mathcal{K}(E)^{n-i}$ such that

$$\int_{\mathcal{K}(E)^{n-i}} V(\mathbf{B}[i], K_1, \dots, K_{n-i}) d\mu(K_1, \dots, K_{n-i}) < +\infty.$$

We call a valuation $\phi \in \text{Val}_i(E)$ \mathcal{P} -positive if $\phi \in \mathcal{P}_i$.

It is clear that \mathcal{P}_i is a convex cone.

By a polarization argument, observe that a valuation $\phi \in \mathcal{P}_i$ defines a unique function on $\mathcal{K}(E)^i$:

$$\phi(L_1, \dots, L_i) = \frac{1}{i!} \frac{\partial^i}{\partial t_1 \partial t_2 \dots \partial t_i} (\phi(t_1 L_1 + \dots + t_i L_i)) \Big|_{t_1 = \dots = t_i = 0^+},$$

where L_1, \dots, L_i are convex bodies. In particular, $\phi(L, \dots, L) = \phi(L)$.

Definition 2.2.1.2. We say that a valuation $\phi \in \mathcal{P}_i$ is strictly \mathcal{P} -positive if there exists $\varepsilon > 0$ such that :

$$\phi(L_1, \dots, L_i) \geq \varepsilon V(\mathbf{B}[n-i], L_1, \dots, L_i)$$

for any convex body $L_1, \dots, L_i \in \mathcal{K}(E)$.

Remark 2.2.1.3. The definition for ‘‘strict positivity’’ is inspired by the study of positivity properties of cohomology classes in complex geometry. The convex body \mathbf{B} can be viewed as a Kähler class, and the inequality defining strict positivity of ϕ_μ can be viewed as the pseudo-effectivity of $\phi_\mu - \varepsilon V(\mathbf{B}[n-i]; -)$.

We prove that the cone \mathcal{P}_i is well-defined, i.e., $\mathcal{P}_i \subset \text{Val}_i(E)$.

Lemma 2.2.1.4. For any Radon measure μ on $\mathcal{K}(E)^{n-i}$ such that :

$$\int_{\mathcal{K}(E)^{n-i}} V(\mathbf{B}[i], K_1, \dots, K_{n-i}) d\mu(K_1, \dots, K_{n-i}) < +\infty,$$

the valuation ϕ_μ defines a continuous and translation invariant valuation.

Proof. Let us first prove that the integral is well-defined. Take a convex body $L \in \mathcal{K}(E)$, there exists a constant $\lambda > 0$ such that $L \subset \lambda \mathbf{B}$. Since the mixed volume is monotone, we have :

$$\begin{aligned} \phi_\mu(L) &= \int_{\mathcal{K}(E)^{n-i}} V(L[i], K_1, \dots, K_{n-i}) d\mu(K_1, \dots, K_{n-i}) \\ &\leq \lambda^i \int_{\mathcal{K}(E)^{n-i}} V(\mathbf{B}[i], K_1, \dots, K_{n-i}) d\mu(K_1, \dots, K_{n-i}) < +\infty. \end{aligned}$$

As $V(-; K_1, \dots, K_{n-i})$ is a translation invariant valuation for any $K_1, \dots, K_{n-i} \in \mathcal{K}(E)$, it is clear that ϕ_μ is also a translation invariant valuation. Let us prove that ϕ_μ is continuous. Assume that $d_H(L_k, L) \rightarrow 0$, we need to check that $\phi_\mu(L_k) \rightarrow \phi_\mu(L)$. This is a direct consequence of the dominated convergence theorem. \square

Definition 2.2.1.5. We denote by \mathcal{V}'_i the subspace generated by \mathcal{P}_i , i.e., $\mathcal{V}'_i = \mathcal{P}_i - \mathcal{P}_i$.

By Alesker’s density theorem, \mathcal{V}'_i is dense in $\text{Val}_i(E)$ (with respect to the norm $\|\cdot\|$).

Example 2.2.1.6. When μ is a finite linear combination of Dirac measures on $\mathcal{K}(E)^{n-i}$, then the associated valuation $\phi_\mu \in \mathcal{V}_i'$ is a linear combination of mixed volumes.

Example 2.2.1.7. Let us consider the positive cones \mathcal{P}_1 and \mathcal{P}_{n-1} :

1. By Minkowski's existence theorem (see [Sch14]), if μ is a positive Borel measure on \mathbb{S}^{n-1} which is not concentrated on any great subsphere and has the origin as its center of mass, then μ is given by the surface area measure of a convex body with non-empty interior. In particular, for any $n-1$ convex bodies K_1, \dots, K_{n-1} with non-empty interior, up to a translation, there is a unique convex body K with non-empty interior such that

$$V(-; K_1, \dots, K_{n-1}) = V(-; K[n-1]).$$

By Minkowski's existence theorem again, for any two convex bodies K, L , up to a translation, there exists a unique convex body M such that

$$V(-; K[n-1]) + V(-; L[n-1]) = V(-; M[n-1]).$$

We claim that the set of strictly \mathcal{P} -positive elements in \mathcal{P}_1 is just

$$\{V(-; K[n-1]) \mid K \in \mathcal{K}(E) \text{ with non-empty interior}\}.$$

Thus the cone \mathcal{P}_1 can be viewed as a convex cone in the space of Borel measures on \mathbb{S}^{n-1} . To this end, let $\phi_\mu \in \mathcal{P}_1$, we show that it gives a bounded linear functional on $C^0(\mathbb{S}^{n-1})$ endowed with the norm $|\cdot|_\infty$. For any $f \in C^0(\mathbb{S}^{n-1})$, we have

$$\begin{aligned} \phi_\mu(f) &:= \int_{\mathcal{K}(E)^{n-1}} d\mu(A_1, \dots, A_{n-1}) \int_{\mathbb{S}^{n-1}} f dS(A_1, \dots, A_{n-1}) \\ &\leq |f|_\infty \int_{\mathcal{K}(E)^{n-1}} d\mu(A_1, \dots, A_{n-1}) \int_{\mathbb{S}^{n-1}} h_{\mathbf{B}} dS(A_1, \dots, A_{n-1}) \\ &= \phi_\mu(\mathbf{B}) |f|_\infty, \end{aligned}$$

where $d\mu(A_1, \dots, A_{n-1})$ is the surface area associated to A_1, \dots, A_{n-1} and $h_{\mathbf{B}}$ is the support function of the unit ball which is equal to 1 on \mathbb{S}^{n-1} . Furthermore, if ϕ_μ is strictly \mathcal{P} -positive, then by Minkowski's existence theorem there is a unique (up to a translation) convex body K_μ with non-empty interior such that $\phi_\mu = V(-; K_\mu[n-1])$.

2. For \mathcal{P}_{n-1} , by the discussions in the proof of Theorem 2.2.3.8 and Theorem 2.5.2.1 we will see that

$$\mathcal{P}_{n-1} = \{V(-; K) \mid K \in \mathcal{K}(E)\}.$$

By the embedding theorem for convex bodies, \mathcal{P}_{n-1} can be also realized as a convex cone in the continuous function space $C^0(\mathbb{S}^{n-1})$, which is generated by support functions.

Remark 2.2.1.8. For the space $\text{Val}_{n-1}(E)$, we have McMullen's characterization [McM80]. Let $L(\mathbb{S}^{n-1})$ denote the space of the restriction of linear functions to the unit sphere, then there is an isomorphism between the quotient space $C^0(\mathbb{S}^{n-1})/L(\mathbb{S}^{n-1})$ and $\text{Val}_{n-1}(E)$. Thus for every $\phi \in \text{Val}_{n-1}(E)$, up to a linear function, there is a unique continuous function f_ϕ such that

$$\phi(K) = \int_{\mathbb{S}^{n-1}} f_\phi(x) dS(K^{n-1}; x),$$

where $dS(K^{n-1}; x)$ is the surface area measure of K . By the correspondences established in [LX17], the analogy of the space $\text{Val}_{n-1}(E)$ on a projective variety is the vector space of real numerical divisor classes, and the analogy of \mathcal{P}_{n-1} is the movable cone of divisor classes. As for

\mathcal{P}_1 , its closure is the dual of the cone given by positive continuous functions, and its analogy in complex geometry is the movable cone of curve classes.

For the general space $\text{Val}_i(E) = \text{Val}_i^+(E) \oplus \text{Val}_i^-(E)$, we have the Klain-Schneider realizations (see e.g. [Ale01, Section 2], [Ale11, Section 2.4]). The space $\text{Val}_i^+(E)$ can be $\text{GL}(E)$ -equivalently realized as a subspace of the space of smooth sections of certain line bundle over the Grassmannian $\text{Gr}_i(E)$, and the space $\text{Val}_i^-(E)$ can be $\text{GL}(E)$ -equivalently realized as a subspace of the quotient of the space of smooth sections of certain line bundle over the partial flag space $\mathcal{F}_{i,i+1}(E)$. Thus by Klain-Schneider realizations, it seems possible to discuss positivity in the smooth section space of certain line bundles.

Remark 2.2.1.9. Another motivation for the definition of \mathcal{P}_k is the positive cone in $\text{Val}^{\text{SO}(n)}(E)$ – the space of $\text{SO}(n)$ -invariant valuations. By the definition in [Ber12, Section 5.5], a valuation ϕ is called positive if $\phi(K) \geq 0$ for all $K \in \mathcal{K}(E)$. By Hadwiger's theorem, a $\text{SO}(n)$ -invariant valuation ϕ is positive if and only if $\phi = \sum_k c_k \mu_k$, where $c_k \geq 0$ and μ_k is the k -th intrinsic volume. Thus $\mathcal{P}_k^{\text{SO}(n)} = \mathbb{R}_+ \mu_k$. In the setting of hermitian integral geometry, there are also similar results (see [BF11, Proposition 4.1]). It is interesting to give a characterization for valuations $\phi \in \text{Val}_i(E)$ satisfying $\phi(K) \geq 0$ for every $K \in \mathcal{K}(E)$.

2.2.2 Reverse Khovanskii-Teissier inequality

Consider two Radon measures μ, ν on $\mathcal{K}(E)^{n-i}$ and $\mathcal{K}(E)^{n-j}$ respectively. Let $\phi_\mu \in \mathcal{V}'_i, \phi_\nu \in \mathcal{V}'_j$ be their associated valuations. We define the valuation $\phi_\mu \tilde{*} \phi_\nu$ given by :

$$\phi_\mu \tilde{*} \phi_\nu(-) = \frac{i!j!}{n!} \int_{\mathcal{K}(E)^{2n-i-j}} V(-; A_1, \dots, A_{n-i}, B_1, \dots, B_{n-j}) d\mu(A) d\nu(B). \quad (2.3)$$

where $d\mu(A) := d\mu(A_1, \dots, A_{n-i}), d\nu(B) := d\nu(B_1, \dots, B_{n-j})$. We will see immediately that the integral in (2.3) is well defined, that is, for any $D \in \mathcal{K}(E)$, $\phi_\mu \tilde{*} \phi_\nu(D)$ is finite (see Corollary 2.2.2.5).

The following inequality is a key ingredient of our paper. It was proved for valuations given by mixed volumes in [LX17, Theorem 5.9]. In this section, we state it for valuations from the positive cones \mathcal{P}_i .

Theorem 2.2.2.1. *Let $\phi \in \mathcal{P}_k$ and $\psi \in \mathcal{P}_{n-k}$, then for any $K \in \mathcal{K}(E)$ we have*

$$\phi(K)\psi(K) \geq \text{vol}(K)\phi \tilde{*} \psi.$$

Proof. By definition, there exists two Radon measures μ and ν on $\mathcal{K}(E)^{n-k}$ and $\mathcal{K}(E)^k$ such that $\phi = \phi_\mu$ and $\psi = \phi_\nu$ respectively. By definition, $\phi_\mu \tilde{*} \phi_\nu$ is equal to

$$\phi_\mu \tilde{*} \phi_\nu = \frac{k!(n-k)!}{n!} \int_{\mathcal{K}(E)^n} V(A_1, \dots, A_{n-k}, B_1, \dots, B_k) d\mu(A_1, \dots, A_{n-k}) d\mu(B_1, \dots, B_k).$$

Claim : there is a constant $c > 0$ depending only on n, k such that

$$V(K[k]; A_1, \dots, A_{n-k})V(K[n-k]; B_1, \dots, B_k) \geq cV(A_1, \dots, A_{n-k}, B_1, \dots, B_k) \text{vol}(K).$$

The above inequality is just a slight generalization of [LX17, Theorem 5.9], and the proof is similar. We refer to [LX17, Section 5] for the details (see also [Xia17]). Let us give a sketch of the argument here. Without loss of generality, we can assume the A_l, B_l and K are open and have non-empty interior. We apply a result of [Gro90] and results from mass transport (see [Bre91, McC95]). Then after solving a real Monge-Ampère equation related to K , the desired geometric inequality of convex bodies can be reduced to an inequality for mixed discriminants

– the mixed discriminants given by the Hessian of those convex functions defining the convex bodies. More precisely, as in [LX17] (see also [ADM99]) the inequality for mixed volumes is reduced to an inequality for integrals :

$$\begin{aligned} & \int_{\mathbb{R}^n} D(\nabla^2 f_{A_1}, \dots, \nabla^2 f_{A_{n-k}}, (\nabla^2 F_K)[k]) dx \int_{\mathbb{R}^n} D((\nabla^2 F_K)[n-k], \nabla^2 f_{B_1}, \dots, \nabla^2 f_{B_k}) dx \\ & \geq \frac{k!(n-k)!}{n!} \int_{\mathbb{R}^n} \det(\nabla^2 F_K) dx \int_{\mathbb{R}^n} D(\nabla^2 f_{A_1}, \dots, \nabla^2 f_{A_{n-k}}, \nabla^2 f_{B_1}, \dots, \nabla^2 f_{B_k}) dx, \end{aligned}$$

where ∇^2 is the Hessian operator, $D(-)$ denotes mixed discriminants, and f_{A_i}, f_{B_j}, F_K are convex functions obtained by the results in [Gro90] and [Bre91, McC95].

Let $M_K, M_1, \dots, M_{n-k}, M'_1, \dots, M'_k$ be the associated positive symmetric matrices given by $\nabla^2 F_K, \nabla^2 f_{A_1}, \dots, \nabla^2 f_{A_{n-k}}, \nabla^2 f_{B_1}, \dots, \nabla^2 f_{B_k}$ respectively. After an application of the Cauchy-Schwarz inequality

$$\left(\int |fg| dv \right)^2 \leq \left(\int |f|^2 dv \right) \left(\int |g|^2 dv \right)$$

to the left hand side of the above inequality for integrals, the pointwise inequality needed is :

$$D(M_K[k]; M_1, \dots, M_{n-k}) D(M_K[n-k]; M'_1, \dots, M'_k) \geq \frac{k!(n-k)!}{n!} D(M_1, \dots, M_{n-k}, M'_1, \dots, M'_k) \det(M_K).$$

The above inequality for positive matrices is equivalent to an inequality for positive $(1, 1)$ -forms by replacing the positive matrices by positive $(1, 1)$ forms and the discriminants by wedge product of differential forms (see e.g. [Xia17, Section 2]). Assume that $M = [a_{i\bar{j}}]$ is a positive Hermitian matrix, then it determines a positive $(1, 1)$ form on \mathbb{C}^n given by :

$$M \mapsto \omega_M := \sqrt{-1} \sum_{i,j} a_{i\bar{j}} dz^i \wedge d\bar{z}^j.$$

By this correspondence, the pointwise inequality for discriminants is equivalent to

$$(\omega_{M_K}^k \wedge \omega_{M_1} \wedge \dots \wedge \omega_{M_{n-k}}) (\omega_{M_K}^{n-k} \wedge \omega_{M'_1} \wedge \dots \wedge \omega_{M'_k}) \geq \frac{k!(n-k)!}{n!} \omega_{M_K}^n (\omega_{M_1} \wedge \dots \wedge \omega_{M_{n-k}} \wedge \omega_{M'_1} \wedge \dots \wedge \omega_{M'_k}).$$

Note that wedge products of positive $(1, 1)$ forms are Hermitian positive. More generally, assume that Φ is a Hermitian positive $(n-k, n-k)$ form, Ψ is a Hermitian positive (k, k) form and ω is a positive $(1, 1)$ form¹, then

$$(\Phi \wedge \omega^k) (\omega^{n-k} \wedge \Psi) \geq \frac{k!(n-k)!}{n!} (\Phi \wedge \Psi) \omega^n. \quad (2.4)$$

Recall that a (l, l) form is Hermitian positive on the vector space \mathbb{C}^n if its associated Hermitian form on $\wedge^l \mathbb{C}^n$ is semipositive (see [DELV11b, Definition 1.4]), that is, the coefficients of the (l, l) form give a semipositive Hermitian matrix on $\wedge^l \mathbb{C}^n$, here $\wedge^l \mathbb{C}^n$ is the l -th wedge product of \mathbb{C}^n . By taking some local coordinates, it is sufficient to check the above inequality when ω is given by the identity matrix. As Φ is Hermitian positive, then

$$\sum_{|J|=n-k} \left(\sum_{|I|=n-k} \Phi_{I,I} \right) dz_J \wedge d\bar{z}_J - \Phi$$

1. For the positivity of forms, we refer the reader to [Dem12b, Chapter 3] and [DELV11b, Section 1]. In [DELV11b, Definition 1.4], ‘‘Hermitian positive’’ is called semipositive.

is also Hermitian positive. As Ψ is Hermitian positive and the cone generated by Hermitian positive (k, k) forms is dual to the cone generated by Hermitian positive $(n - k, n - k)$ forms (see [DELV11b, Section 1]), we get

$$\left(\sum_{|J|=n-k} \left(\sum_{|I|=n-k} \Phi_{I,J} \right) dz_J \wedge d\bar{z}_J - \Phi \right) \wedge \Psi \geq 0,$$

which gives the desired pointwise inequality (2.4).

In summary, we finally obtain

$$\phi(K)\psi(K) \geq \text{vol}(K)\phi\tilde{*}\psi,$$

as required. \square

Remark 2.2.2.2. As for the terminology “reverse Khovanskii-Teissier inequality”, it was used in [LX16]. The reason is that : the classical Khovanskii-Teissier inequality gives us a lower bound of $\phi\tilde{*}\psi$, but the above inequality gives us an upper bound :

$$\phi\tilde{*}\psi \leq \inf_{\text{vol}(K)=1} \phi(K)\psi(K).$$

See also [LX16] for a discussion in the abstract setting from the viewpoint of convex analysis. In complex geometry, as a corollary of Demailly’s holomorphic Morse inequality (see [Dem12a, Chapter 8]), the special case of the above inequality for divisor classes (when $k = 1$) was first noted by Siu [Siu93]. The inequality for general (k, k) classes was first noted in [Xia15b]. The pointwise inequality for forms in the proof is a generalization of [Pop16b], where the weak transcendental Morse inequality for $(1, 1)$ classes was proved with optimal estimate.

Bézout type inequality

Recently, inspired by Bézout bound in algebraic geometry, the second author [Xia17] noticed that the reverse Khovanskii-Teissier inequality can be used to obtain Bézout type inequality in convex geometry (see also [SZ16]). This can be also formulated using convolution.

Theorem 2.2.2.3 (see [Xia17], Theorem 1.1). *Let $\phi_i \in \mathcal{P}_{n-a_i}$ where $1 \leq i \leq r$ and $|a| := \sum_{i=1}^r a_i \leq n$, then there is a constant $c > 0$ depending only on n, a_1, \dots, a_r such that, for any $D \in \mathcal{K}(E)$ we have*

$$(\phi_1\tilde{*}\dots\tilde{*}\phi_r)(D) \text{vol}(D)^{r-1} \leq c \prod_{i=1}^r \phi_i(D).$$

In particular, if $|a| = n$, then

$$(\phi_1\tilde{*}\dots\tilde{*}\phi_r) \text{vol}(D)^{r-1} \leq c \prod_{i=1}^r \phi_i(D).$$

Proof. This follows directly from Theorem 2.2.2.1, as exactly in [Xia17, Theorem 1.1]. \square

Proposition 2.2.2.4. *The operator $\tilde{*}$ defined by the formula (2.3) induces a bilinear map $\tilde{*} : \mathcal{V}'_i \times \mathcal{V}'_j \rightarrow \mathcal{V}'_{i+j-n}$.*

Proof. This proposition follows immediately from the following Lemma 2.2.2.5 and Lemma 2.2.2.6. \square

Lemma 2.2.2.5. *For any $\phi_\mu \in \mathcal{P}_i, \psi_\nu \in \mathcal{P}_j$, the integral (2.3) defining $\phi_\mu\tilde{*}\psi_\nu$ is well defined.*

Proof. We only need to check that the integral defining $\phi_\mu \tilde{*} \psi_\nu(D)$ is well defined, when D has non-empty interior. This follows directly from Theorem 2.2.2.3. \square

It is possible that different Radon measures give the same valuations, we prove that $\phi_\mu \tilde{*} \phi_\nu$ is independent of the representations.

Lemma 2.2.2.6. *The valuation $\phi_\mu \tilde{*} \phi_\nu$ is independent of the choices of μ, ν .*

Proof. Consider Radon measures μ_1, μ_2 on $\mathcal{K}(E)^{n-i}$ and ν_1, ν_2 on $\mathcal{K}(E)^{n-j}$ respectively. Assume that $\phi_{\mu_1} = \phi_{\mu_2}, \phi_{\nu_1} = \phi_{\nu_2}$, we prove that $\phi_{\mu_1} \tilde{*} \phi_{\nu_1} = \phi_{\mu_2} \tilde{*} \phi_{\nu_2}$.

We need to verify that for any $L \in \mathcal{K}(E)$,

$$\begin{aligned} & \int_{\mathcal{K}(E)^{2n-i-j}} V(L[i+j-n]; A_1, \dots, A_{n-i}, B_1, \dots, B_{n-j}) d\mu_1(A) d\nu_1(B) \\ &= \int_{\mathcal{K}(E)^{2n-i-j}} V(L[i+j-n]; A_1, \dots, A_{n-i}, B_1, \dots, B_{n-j}) d\mu_2(A) d\nu_2(B). \end{aligned}$$

For any $t = (t_1, \dots, t_j) \in (\mathbb{R}^+)^j$, denote by $K_t = t_1 K_1 + \dots + t_j K_j$ where K_1, \dots, K_j are convex bodies. Since $\phi_{\nu_1} = \phi_{\nu_2}$, we have that $\phi_{\nu_1}(K_t) = \phi_{\nu_2}(K_t)$. Since $\phi_{\nu_i}(K_t)$ is a polynomial in t_1, \dots, t_j , the equality on the coefficients of the polynomial gives

$$\int_{\mathcal{K}(E)^{n-j}} V(K_1, \dots, K_j; B_1, \dots, B_{n-j}) d\nu_1(B) = \int_{\mathcal{K}(E)^{n-j}} V(K_1, \dots, K_j; B_1, \dots, B_{n-j}) d\nu_2(B).$$

In particular, this implies $\phi_{\mu_1} \tilde{*} \phi_{\nu_1} = \phi_{\mu_1} \tilde{*} \phi_{\nu_2}$. Similarly, $\phi_{\mu_1} \tilde{*} \phi_{\nu_2} = \phi_{\mu_2} \tilde{*} \phi_{\nu_2}$, hence $\phi_{\mu_1} \tilde{*} \phi_{\nu_1} = \phi_{\mu_2} \tilde{*} \phi_{\nu_2}$. \square

2.2.3 Norms on the space of valuations

The aim of this section is to define some norms on the space generated by \mathcal{P}_i . These norms are induced by the positive cone \mathcal{P}_i .

Positivity norm $\|\cdot\|_{\mathcal{P}}$

We define the norm $\|\cdot\|_{\mathcal{P}}$, for which we will show that the subspace $\mathcal{P}_i \cap \text{Val}^\infty(E)$ of smooth valuations is dense in \mathcal{V}'_i .

Definition 2.2.3.1. *For any valuation $\phi \in \mathcal{V}'_i$, we define $\|\phi\|_{\mathcal{P}}$ by the following formula.*

$$\|\phi\|_{\mathcal{P}} := \inf\{t \geq 0 \mid |\phi(L_1, \dots, L_i)| \leq tV(\mathbf{B}[n-i], L_1, \dots, L_i) \text{ for any } L_1, \dots, L_i \in \mathcal{K}(E)\}.$$

First we note that for any $\phi \in \mathcal{V}'_i$, $\|\phi\|_{\mathcal{P}}$ is well defined.

Proposition 2.2.3.2. *The map $\|\cdot\|_{\mathcal{P}} : \mathcal{V}'_i \rightarrow \mathbb{R}^+$ defines a norm on \mathcal{V}'_i .*

Proof. The only fact which is not straightforward is whether $\|\cdot\|_{\mathcal{P}_i}$ is well-defined. Consider $\phi \in \mathcal{V}'_i$, we prove that there exists a $t > 0$ such that

$$|\phi(L_1, \dots, L_i)| \leq tV(\mathbf{B}[n-i], L_1, \dots, L_i).$$

By definition, there exists a signed Radon measure μ on $\mathcal{K}(E)^{n-i}$ such that $\phi = \phi_\mu$. Consider the Hahn decomposition $\mu = \mu^+ - \mu^-$ of the measure μ so that $\phi_\mu = \phi_{\mu^+} - \phi_{\mu^-}$. One has that

$$|\phi(L_1, \dots, L_i)| \leq \phi_{\mu^+}(L_1, \dots, L_i) + \phi_{\mu^-}(L_1, \dots, L_i).$$

Let us find an upper bound for $\phi_{\mu^+}(L_1, \dots, L_i)$. By Theorem 2.2.2.1 we have

$$\begin{aligned} \phi_{\mu^+}(L_1, \dots, L_i) &= \int_{\mathcal{K}(E)^{n-i}} V(L_1, \dots, L_i, K_1, \dots, K_{n-i}) d\mu^+(K) \\ &\leq cV(\mathbf{B}[n-i], L_1, \dots, L_i) \int_{\mathcal{K}(E)^{n-i}} V(\mathbf{B}[i], K_1, \dots, K_{n-i}) d\mu^+(K), \end{aligned}$$

where $c > 0$ depends only on $n, i, \text{vol}(\mathbf{B})$. Since $\phi_{\mu^+} \in \mathcal{P}_i$, we get

$$\phi_{\mu^+}(L_1, \dots, L_i) \leq tV(\mathbf{B}[n-i], L_1, \dots, L_i)$$

for some $t > 0$. Similar estimates also hold for ϕ_{μ^-} , this proves that $\|\phi\|_{\mathcal{P}} < +\infty$. \square

Remark 2.2.3.3. Observe that by homogeneity for L_1, \dots, L_i , we have

$$\|\phi\|_{\mathcal{P}} := \inf\{t \geq 0 \mid |\phi(L_1, \dots, L_i)| \leq tV(\mathbf{B}[n-i], L_1, \dots, L_i) \text{ for any } L_1, \dots, L_i \subset \mathbf{B}\}.$$

By the above remark, we get :

Proposition 2.2.3.4. *For any $\phi \in \mathcal{V}'_i$, $\|\phi\| \leq \text{vol}(\mathbf{B})\|\phi\|_{\mathcal{P}}$. Hence, there is a continuous injection :*

$$(\mathcal{V}'_i, \|\cdot\|_{\mathcal{P}}) \hookrightarrow (\text{Val}_i(E), \|\cdot\|).$$

Regarding the definition for $\|\cdot\|_{\mathcal{P}}$, we introduce the following positivity notation.

Definition 2.2.3.5. *Let $\phi, \psi \in \mathcal{V}'_i$, we say that $\phi \preceq \psi$ (or equivalently, $\psi \succeq \phi$), if for any $L_1, \dots, L_i \in \mathcal{K}(E)$,*

$$\phi(L_1, \dots, L_i) \leq \psi(L_1, \dots, L_i).$$

Using the terminology from complex geometry, $\phi \preceq \psi$ means that $\psi - \phi$ is pseudo-effective in some sense.

Lemma 2.2.3.6. *Let $\psi \in \mathcal{P}_j, \phi_1, \phi_2 \in \mathcal{V}'_i$. Assume that $\phi_1 \succeq \phi_2$, then $\phi_1 \tilde{*} \psi \succeq \phi_2 \tilde{*} \psi$.*

Proof. This follows directly from the definition. \square

We also note that the $\text{GL}(E)$ actions preserve the partial order \succeq .

Lemma 2.2.3.7. *Let $g \in \text{GL}(E)$. Consider $\phi_1, \phi_2 \in \mathcal{V}'_i$ such that $\phi_1 \succeq \phi_2$, then $g \cdot \phi_1 \succeq g \cdot \phi_2$.*

Next we show that the space of smooth valuations is dense in \mathcal{V}'_i with respect to the topology given by $\|\cdot\|_{\mathcal{P}}$.

Theorem 2.2.3.8. *The space of finite sums of mixed volumes of convex bodies with strictly convex and smooth boundary is dense in \mathcal{V}'_i for the topology induced by the norm $\|\cdot\|_{\mathcal{P}}$. In particular, the space $\text{Val}_i^\infty(E) \cap \mathcal{V}'_i$ is dense in \mathcal{V}'_i for the topology induced by the norm $\|\cdot\|_{\mathcal{P}}$.*

Proof. Since \mathcal{V}'_i is generated by \mathcal{P}_i , we are reduced to prove the density of smooth valuations in \mathcal{P}_i . We prove that the finite sums of mixed volumes of convex bodies with strictly convex and smooth boundary are dense in \mathcal{V}'_i .

We prove it in two steps.

Step 1 : Let us first prove that the valuations in \mathcal{P}_i such that their associated measure has bounded support are dense in \mathcal{P}_i .

Take $\phi \in \mathcal{P}_i$ such that $\phi = \phi_\mu$ where μ is its associated positive Radon measure on $\mathcal{K}(E)^{n-i}$. For any integer $k > 0$, we consider the measure μ_k given by $\mu_k = \mu|_{B(0,k)}$, where

$$B(0, k) = \{(K_1, \dots, K_{n-i}) \in \mathcal{K}(E)^{n-i} \mid K_j \subset k\mathbf{B}, \forall 0 \leq j \leq n-i\} \subset \mathcal{K}(E)^{n-i}.$$

By construction, the measure μ_k has bounded support. (By Blaschke selection theorem, $B(0, k)$ is a compact set.) By the monotone convergence theorem, we have that :

$$\phi_{\mu_k}(L) = \int_{\mathcal{K}(E)^{n-i}} V(K_1, \dots, K_{n-i}, L[i]) d\mu_k(K_1, \dots, K_{n-i}) \rightarrow \phi(L).$$

Let us prove that $\|\phi_\mu - \phi_{\mu_k}\|_{\mathcal{P}}$ converges to zero as $k \rightarrow +\infty$. Fix some convex bodies L_1, \dots, L_i . By construction, one has that :

$$0 \leq \phi(L_1, \dots, L_i) - \phi_{\mu_k}(L_1, \dots, L_i).$$

Moreover, by Theorem 2.2.2.1 applied to $\phi' = V(K_1, \dots, K_{n-i}, -[i])$ and $\psi' = V(L_1, \dots, L_i, -[n-i])$ and to the convex body \mathbf{B} , there exists a constant $C > 0$ such that we have :

$$V(K_1, \dots, K_{n-i}, L_1, \dots, L_i) \leq C \frac{V(K_1, \dots, K_{n-i}, \mathbf{B}[i])}{\text{vol}(\mathbf{B})} V(\mathbf{B}[n-i], L_1, \dots, L_i).$$

Integrating on the previous inequality, one obtains :

$$\begin{aligned} & \phi(L_1, \dots, L_i) - \phi_{\mu_k}(L_1, \dots, L_i) \\ & \leq \frac{C}{\text{vol}(\mathbf{B})} \left(\int_{B(0,k)^c} V(K_1, \dots, K_{n-i}, \mathbf{B}[i]) d\mu(K_1, \dots, K_{n-i}) \right) V(\mathbf{B}[n-i], L_1, \dots, L_i), \end{aligned}$$

where $B(0, k)^c = \mathcal{K}(E)^{n-i} \setminus B(0, k)$. We have thus proved :

$$|(\phi - \phi_{\mu_k})(L_1, \dots, L_i)| \leq \frac{C}{\text{vol}(\mathbf{B})} (\phi(\mathbf{B}) - \phi_{\mu_k}(\mathbf{B})) V(\mathbf{B}[n-i], L_1, \dots, L_i),$$

for any convex bodies L_1, \dots, L_i . Since $\phi(\mathbf{B}) - \phi_{\mu_k}(\mathbf{B}) \rightarrow 0$ as $k \rightarrow +\infty$, we have that $\|\phi - \phi_{\mu_k}\|_{\mathcal{P}} \rightarrow 0$ as required.

Step 2 : Suppose that $\phi = \phi_\mu \in \mathcal{P}_i$ is a valuation where μ is a Radon measure on $\mathcal{K}(E)^{n-i}$ whose support is bounded. We prove that ϕ can be approached by ϕ_k , where $\phi_k \in \mathcal{P}_i \cap \text{Val}_i^\infty(E)$ is a finite sum of mixed volumes given by convex bodies with strictly convex and smooth boundary.

Suppose that the support of μ is contained in $B(0, N)$ where $N > 0$ is an integer. For any $\epsilon > 0$, there exists a partition $\cup_{j=1}^m O_j$ of $B(0, N)$ such that for any $(K_1, \dots, K_{n-i}), (K'_1, \dots, K'_{n-i}) \in O_j$, one has :

$$d_H(K_j, K'_j) \leq \epsilon, \quad \forall 1 \leq j \leq n-i. \quad (2.5)$$

Since the valuations given by mixed volumes are monotone and since $\text{supp } \mu \subset B(0, N)$, there is a constant $C > 0$ (depending only on N, i) such that

$$|V(K_1, \dots, K_{n-i}, L_1, \dots, L_i) - V(K'_1, \dots, K'_{n-i}, L_1, \dots, L_i)| \leq C\epsilon V(\mathbf{B}[n-i], L_1, \dots, L_i). \quad (2.6)$$

Let us define the measure μ_ϵ given by

$$\mu_\epsilon := \sum_{j=1}^m \mu(O_j) \delta_{(K_1^j, \dots, K_{n-i}^j)},$$

where $(K_1^j, K_2^j, \dots, K_{n-i}^j) \in O_j$ satisfying that K_1^j, \dots, K_{n-i}^j are convex bodies with smooth and strictly convex boundary, and where $\delta_{(K_1^j, K_2^j, \dots, K_{n-i}^j)}$ is the dirac mass at the point $(K_1^j, K_2^j, \dots, K_{n-i}^j)$. Let us estimate the norm $\|\phi_{\mu_\epsilon} - \phi\|_{\mathcal{P}}$. Take $L_1, \dots, L_i \in \mathcal{K}(E)$. By definition, one has that

$$\begin{aligned} \phi_{\mu_\epsilon}(L_1, \dots, L_i) &= \sum_{j=1}^m \mu(O_j) V(K_1^j, \dots, K_{n-i}^j, L_1, \dots, L_i), \\ &= \sum_{j=1}^m \int_{O_j} V(K_1^j, \dots, K_{n-i}^j, L_1, \dots, L_i) d\mu(K_1, \dots, K_i). \end{aligned}$$

The difference $|\phi_{\mu_\epsilon}(L_1, \dots, L_i) - \phi(L_1, \dots, L_i)|$ is bounded by :

$$\begin{aligned} &|\phi_{\mu_\epsilon}(L_1, \dots, L_i) - \phi(L_1, \dots, L_i)| \\ &\leq \sum_{j=1}^m \left| \int_{O_j} (V(K_1^j, \dots, K_{n-i}^j, L_1, \dots, L_i) - V(K_1, \dots, K_{n-i}, L_1, \dots, L_i)) d\mu(K_1, \dots, K_{n-i}) \right| \\ &\leq \sum_{j=1}^m \int_{O_j} |V(K_1^j, \dots, K_{n-i}^j, L_1, \dots, L_i) - V(K_1, \dots, K_{n-i}, L_1, \dots, L_i)| d\mu(K_1, \dots, K_{n-i}). \end{aligned}$$

Applying (2.6) to the previous inequality, we obtain the following upper bound :

$$|\phi_{\mu_\epsilon}(L_1, \dots, L_i) - \phi(L_1, \dots, L_i)| \leq C\epsilon \sum_{j=1}^m \int_{O_j} V(\mathbf{B}[n-i], L_1, \dots, L_i) d\mu(K_1, \dots, K_{n-i}).$$

Hence,

$$|\phi_{\mu_\epsilon}(L_1, \dots, L_i) - \phi(L_1, \dots, L_i)| \leq C\epsilon V(\mathbf{B}[n-i], L_1, \dots, L_i) \mu(B(0, N)),$$

and this implies that $\|\phi_{\mu_\epsilon} - \phi\|_{\mathcal{P}} \leq C\epsilon \mu(B(0, N))$ is arbitrary small since $\mu(B(0, N))$ is finite.

We have thus proven that finite sums of mixed volumes of convex bodies with smooth and strictly convex boundary are dense in \mathcal{P}_i with respect to the norm $\|\cdot\|_{\mathcal{P}}$ as required. \square

A direct consequence is the following result :

Corollary 2.2.3.9. *The set of valuations $\{V(L; -[n-1]) \mid L \in \mathcal{K}(E)\}$ is dense in \mathcal{P}_{n-1} with respect to the topology given by $\|\cdot\|_{\mathcal{P}}$.*

For further relation between the spaces $\text{Val}_i^\infty(E)$ and \mathcal{V}'_i , it is natural to ask :

Questions. *Do we have $\text{Val}_i^\infty(E) \subset \mathcal{V}'_i$?*

Note that $\text{Val}_i^\infty(E)$ has a decomposition into even valuations and odd valuations, i.e., $\text{Val}_i^\infty(E) = \text{Val}_i^{\infty,+}(E) \oplus \text{Val}_i^{\infty,-}(E)$. For even valuations, it is not hard to get the following result :

Proposition 2.2.3.10. *For any integer $i \leq n$, we have the inclusion $\text{Val}_i^{\infty,+}(E) \subset \mathcal{V}'_i$.*

Proof. Take an even valuation $\phi \in \text{Val}_i^{\infty,+}(E)$. By [Ale11] (see also [Ber12]), there exists a smooth measure dm_ϕ on $\text{Gr}_i(E)$ such that

$$\phi(K) = \int_{H \in \text{Gr}_i(E)} \text{vol}_H(\pi_H(K)) dm_\phi(H),$$

where $\pi_H : E \rightarrow H$ is the orthogonal projection onto H and where vol_H denotes the volume on H . By the projection formula (see [Sch14, Theorem 5.3.1]), take $B \in \mathcal{K}(E)$ with non-empty interior and let $B_H := B \cap H^\perp$, one has that :

$$\binom{n}{i} V(B_H[n-i], K[i]) = \text{vol}_{H^\perp}(B_H) \text{vol}_H(\pi_H(K)),$$

where $\pi_H : E \rightarrow H$ is the orthogonal projection onto H . In particular, one has that :

$$\phi(K) = \int_{H \in \text{Gr}_i(E)} \text{vol}_{H^\perp}(B_H)^{-1} \binom{n}{i}^{-1} V(B_H[n-i], K[i]) dm_\phi(H).$$

Take μ to be the push-forward of the measure $\text{vol}_{H^\perp}(B_H)^{-1} \binom{n}{i}^{-1} dm_\phi(H)$ by the continuous map :

$$H \in \text{Gr}_i(E) \rightarrow B_H^{n-i} \in \mathcal{K}(E)^{n-i}.$$

Then we have that :

$$\phi(K) = \int V(K[i], L_1, \dots, L_{n-i}) d\mu(L_1, \dots, L_{n-i}),$$

and $\phi \in \mathcal{V}'_i$ as required. □

Remark 2.2.3.11. For the case when ϕ is odd, there exists a smooth function $\varphi : \text{Gr}_{i+1}(E) \rightarrow \text{Val}_i(E)$ such that for any $H \in \text{Gr}_{i+1}(E)$, one has that $\varphi(H)|_H \in \text{Val}_i^{\infty,-}(H)$ and

$$\phi(K) = \int_{H \in \text{Gr}_{i+1}(E)} \varphi(H)(\pi_H(K)) dm(H),$$

where dm is a smooth measure on $\text{Gr}_{i+1}(E)$. Since the valuation $\varphi(H)|_H$ defines a valuation of degree i on the $(i+1)$ -dimensional space H , by Remark 2.2.1.8, $\varphi(H)|_H$ can be written as the integral against some continuous function f on the unit sphere in H . However, we do not know if the smoothness of $\varphi(H)|_H$ would imply enough regularity of f . If f is at least second-order differentiable, then by [Sch14, Lemma 1.7.8] f can be written as the difference of two support functions, and one could get a positive answer to Question 2.2.3.

Cone norm $\|\cdot\|_{\mathcal{C}}$

As \mathcal{V}'_i is generated by \mathcal{P}_i , it is naturally endowed a norm $\|\cdot\|_{\mathcal{C}}$ induced by the cone structure. This construction is inspired by the construction in algebraic geometry (see [Dan17]).

Definition 2.2.3.12. For any $\phi \in \mathcal{V}'_i$, we define $\|\phi\|_{\mathcal{C}}$ by the following formula :

$$\|\phi\|_{\mathcal{C}} := \inf_{\phi = \phi_+ - \phi_-, \phi_{\pm} \in \mathcal{P}_i} \phi_+(\mathbf{B}) + \phi_-(\mathbf{B}).$$

Here, the symbol \mathcal{C} stands for the fact that this norm is induced by the convex cone \mathcal{P}_i .

Remark 2.2.3.13. Equivalently, by the Jordan decomposition of signed measures we have $\|\phi_\mu\|_{\mathcal{C}} := \phi_{|\mu|}(\mathbf{B})$, where $|\mu|$ is the absolute value of a Radon measure μ on $\mathcal{K}(E)^{n-i}$.

Remark 2.2.3.14. By construction, if $\phi \in \mathcal{P}_i$, then $\|\phi\|_{\mathcal{C}} = \phi(\mathbf{B})$.

Lemma 2.2.3.15. The function $\|\cdot\|_{\mathcal{C}}$ defined above is a norm on the space \mathcal{V}'_i .

Proof. It is clear that :

- For any $c \in \mathbb{R}$ and any $\phi \in \mathcal{V}'_i$, we have $\|c\phi\|_c = |c|\|\phi\|_c$;
- For any $\phi, \psi \in \mathcal{V}'_i$, we have $\|\phi + \psi\|_c \leq \|\phi\|_c + \|\psi\|_c$.

It remains to verify :

- If $\|\phi\|_c = 0$, then $\phi = 0$.

To this end, take a sequence of decompositions $\phi = \phi_k^+ - \phi_k^-$ such that $\phi_k^+(\mathbf{B}) + \phi_k^-(\mathbf{B}) \rightarrow 0$. By the definition of the Banach structure on $\text{Val}(E)$ (see (2.1)), for any $K \subset \mathbf{B}$ we have

$$|\phi(K)| = |\phi_k^+(K) - \phi_k^-(K)| \leq \phi_k^+(\mathbf{B}) + \phi_k^-(\mathbf{B}) \rightarrow 0.$$

Hence, $\phi(K) = 0$ for any $K \subset \mathbf{B}$, implying $\phi = 0$. □

Proposition 2.2.3.16. *The set of \mathcal{P} -positive valuations ϕ_μ , where μ has bounded support, is dense in \mathcal{P}_i with respect to the topology given by $\|\cdot\|_c$.*

Proof. This is straightforward. □

Comparison of two norms

Proposition 2.2.3.17. *For any $\phi \in \mathcal{V}'_i$, one has that $\|\phi\|_{\mathcal{P}} \leq C\|\phi\|_c$ for some uniform constant $C > 0$. Hence, there is a continuous injection :*

$$(\mathcal{V}'_i, \|\cdot\|_c) \hookrightarrow (\mathcal{V}'_i, \|\cdot\|_{\mathcal{P}}).$$

Proof. Consider $\phi \in \mathcal{V}'_i$ and assume that $\phi = \phi_+ - \phi_-$ where $\phi_+, \phi_- \in \mathcal{P}_i$. Fix some convex bodies L_1, \dots, L_i . One has that :

$$|\phi(L_1, \dots, L_i)| \leq |\phi_+(L_1, \dots, L_i)| + |\phi_-(L_1, \dots, L_i)|.$$

By Theorem 2.2.2.1 applied to $\phi' = \phi_{\pm}$, $\psi = V(L_1, \dots, L_i, [n-i])$ and to the convex body \mathbf{B} respectively, there exists a uniform constant $C > 0$ such that :

$$\phi_{\pm}(L_1, \dots, L_i) \leq C\phi_{\pm}(\mathbf{B})V(\mathbf{B}[n-i], L_1, \dots, L_i).$$

In particular, this implies that :

$$|\phi(L_1, \dots, L_i)| \leq C(\phi_+(\mathbf{B}) + \phi_-(\mathbf{B}))V(\mathbf{B}[n-i], L_1, \dots, L_i).$$

By considering two sequences $\phi_{+,j}, \phi_{-,j} \in \mathcal{P}_i$ such that $\lim_j \phi_{+,j}(\mathbf{B}) + \phi_{-,j}(\mathbf{B}) = \|\phi\|_c$, we obtain :

$$|\phi(L_1, \dots, L_i)| \leq C\|\phi\|_c V(\mathbf{B}[n-i], L_1, \dots, L_i),$$

for any convex bodies L_1, \dots, L_i . By definition, we obtain :

$$\|\phi\|_{\mathcal{P}} \leq C\|\phi\|_c,$$

as required. □

Corollary 2.2.3.18. *One has the following sequence of continuous injections :*

$$(\mathcal{V}'_i, \|\cdot\|_c) \hookrightarrow (\mathcal{V}'_i, \|\cdot\|_{\mathcal{P}}) \hookrightarrow (\text{Val}_i(E), \|\cdot\|).$$

Proof. This follows directly from Proposition 2.2.3.4 and Proposition 2.2.3.17. □

Sub-multiplicity of norms

We get the following sub-multiplicity result for the norms defined above. This will be important in the completion of the space \mathcal{V}'_i .

Lemma 2.2.3.19. *Let $\phi_\mu \in \mathcal{P}_i, \psi_\nu \in \mathcal{P}_j$, then there is $c > 0$ depending only on $i, j, n, \text{vol}(\mathbf{B})$ such that :*

- $\|\phi_\mu \tilde{*} \psi_\nu\|_c \leq c \|\phi_\mu\|_c \|\psi_\nu\|_c$;
- $\|\phi_\mu \tilde{*} \psi_\nu\|_{\mathcal{P}} \leq c \|\phi_\mu\|_{\mathcal{P}} \|\psi_\nu\|_{\mathcal{P}}$.

Proof. Let us first prove the first inequality. Note that

$$\|\phi_\mu \tilde{*} \psi_\nu\|_c = \phi_\mu \tilde{*} \psi_\nu(\mathbf{B}) \leq c \phi_\mu(\mathbf{B}) \psi_\nu(\mathbf{B}) = c \|\phi_\mu\|_c \|\psi_\nu\|_c,$$

where the second estimate follows from Theorem 2.2.2.3.

For the second inequality, let $L_1, \dots, L_{i+j-n} \in \mathcal{K}(E)$, we have

$$\begin{aligned} \phi_\mu \tilde{*} \psi_\nu(L_1, \dots, L_{i+j-n}) &= \frac{i!j!}{n!} \int_{\mathcal{K}(E)^{2n-i-j}} V(L_1, \dots, L_{i+j-n}, A_1, \dots, A_{n-i}, B_1, \dots, B_{n-j}) d\mu(A) d\nu(B) \\ &\leq c \|\phi_\mu\|_{\mathcal{P}} \int_{\mathcal{K}(E)^{n-j}} V(\mathbf{B}[n-i]; L_1, \dots, L_{i+j-n}, B_1, \dots, B_{n-j}) d\nu(B) \\ &\leq c \|\phi_\mu\|_{\mathcal{P}} \|\psi_\nu\|_{\mathcal{P}} V(\mathbf{B}[2n-i-j]; L_1, \dots, L_{i+j-n}). \end{aligned}$$

Thus, by definition $\|\phi_\mu \tilde{*} \psi_\nu\|_{\mathcal{P}} \leq c \|\phi_\mu\|_{\mathcal{P}} \|\psi_\nu\|_{\mathcal{P}}$. □

2.2.4 An extension of the convolution operator

Recall that for $\phi_\mu \in \mathcal{V}'_i, \psi_\nu \in \mathcal{V}'_j$, the formula for $\phi_\mu \tilde{*} \psi_\nu \in \mathcal{V}'_{i+j-n}$ is defined by

$$\phi_\mu \tilde{*} \psi_\nu(-) = \frac{i!j!}{n!} \int_{\mathcal{K}(E)^{2n-i-j}} V(-; A_1, \dots, A_{n-i}, B_1, \dots, B_{n-j}) d\mu(A) d\nu(B).$$

Let $\mathcal{V}^c_i, \mathcal{V}^{\mathcal{P}}_i$ be the completions of the space \mathcal{V}'_i with respect to the norms $\|\cdot\|_c$ and $\|\cdot\|_{\mathcal{P}}$ respectively.

In the following, we let $\gamma \in \{\mathcal{C}, \mathcal{P}\}$. We show that the operator $\tilde{*}$ extends continuously to the spaces \mathcal{V}^γ_i with respect to $\|\cdot\|_\gamma$.

Theorem 2.2.4.1. *With respect to $\|\cdot\|_\gamma$, the operator $\tilde{*} : \mathcal{V}^\gamma_i \times \mathcal{V}^\gamma_j \rightarrow \mathcal{V}^\gamma_{i+j-n}$ extends continuously to a bilinear operator*

$$\begin{aligned} \tilde{*} : \mathcal{V}^\gamma_i \times \mathcal{V}^\gamma_j &\rightarrow \mathcal{V}^\gamma_{i+j-n} \\ (\Phi, \Psi) &\mapsto \Phi \tilde{*} \Psi. \end{aligned}$$

Proof. We first consider the case when $\gamma = \mathcal{C}$. Assume that $\{\phi_k\} \subset \mathcal{V}'_i, \{\psi_k\} \subset \mathcal{V}'_j$ are Cauchy sequences with respect to the norm $\|\cdot\|_c$, and $\phi_k \rightarrow \Phi, \psi_k \rightarrow \Psi$. We show that $\{\phi_k \tilde{*} \psi_k\} \subset \mathcal{V}'_{i+j-n}$ is also a Cauchy sequence with respect to $\|\cdot\|_c$.

As $\{\phi_k\}, \{\psi_k\}$ are Cauchy sequences, by the definition of the cone norm $\|\cdot\|_c$, we have the following properties :

1. For any $\varepsilon > 0$ and for all k, l large enough, there exist decompositions

$$\phi_k - \phi_l = \phi^+ - \phi^-, \quad \psi_k - \psi_l = \psi^+ - \psi^-$$

such that $\phi^\pm \in \mathcal{P}_i, \psi^\pm \in \mathcal{P}_j$ and

$$\phi^+(\mathbf{B}) + \phi^-(\mathbf{B}) < \varepsilon, \quad \psi^+(\mathbf{B}) + \psi^-(\mathbf{B}) < \varepsilon.$$

2. There exist two decompositions

$$\phi_k = \phi_k^+ - \phi_k^-, \quad \psi_k = \psi_k^+ - \psi_k^-$$

such that $\phi_k^\pm \in \mathcal{P}_i, \psi_k^\pm \in \mathcal{P}_j$ and such that

$$\phi_k^+(\mathbf{B}) + \phi_k^-(\mathbf{B}) \leq C, \quad \psi_k^+(\mathbf{B}) + \psi_k^-(\mathbf{B}) \leq C$$

for a uniform constant $C > 0$.

We write $\phi_k \tilde{*} \psi_k - \phi_l \tilde{*} \psi_l$ as follows :

$$\begin{aligned} \phi_k \tilde{*} \psi_k - \phi_l \tilde{*} \psi_l &= \phi_k \tilde{*} (\psi_k - \psi_l) + (\phi_k - \phi_l) \tilde{*} \psi_l \\ &= (\phi_k^+ - \phi_k^-) \tilde{*} (\psi^+ - \psi^-) + (\phi^+ - \phi^-) \tilde{*} (\psi_k^+ - \psi_k^-) \\ &= (\phi_k^+ \tilde{*} \psi^+ + \phi_k^- \tilde{*} \psi^- + \phi^+ \tilde{*} \psi_k^+ + \phi^- \tilde{*} \psi_k^-) \\ &\quad - (\phi_k^+ \tilde{*} \psi^- + \phi_k^- \tilde{*} \psi^+ + \phi^+ \tilde{*} \psi_k^- + \phi^- \tilde{*} \psi_k^+). \end{aligned} \tag{2.7}$$

This is a decomposition of $\phi_k \tilde{*} \psi_k - \phi_l \tilde{*} \psi_l$ as a difference of two elements in \mathcal{P}_{i+j-n} . By Lemma 2.2.3.19 applied to each term of (2.7), we get

$$\|\phi_k \tilde{*} \psi_k - \phi_l \tilde{*} \psi_l\|_C \leq c' C \varepsilon, \tag{2.8}$$

where c' depends only on $\text{vol}(\mathbf{B}), i, j, n$. Thus $\{\phi_k \tilde{*} \psi_k\}$ must be a Cauchy sequence with respect to the norm $\|\cdot\|_C$.

Next, assume that $\{\phi'_k\}, \{\psi'_k\}$ are another two Cauchy sequences also satisfying $\phi'_k \rightarrow \Phi, \psi'_k \rightarrow \Psi$, we need to verify that the limits of $\{\phi'_k \tilde{*} \psi'_k\}$ and $\{\phi_k \tilde{*} \psi_k\}$ are the same, i.e.,

$$\lim_{k \rightarrow \infty} \|\phi'_k \tilde{*} \psi'_k - \phi_k \tilde{*} \psi_k\|_C = 0.$$

Since $\|\phi'_k - \phi_k\|_C \rightarrow 0$ and $\|\psi'_k - \psi_k\|_C \rightarrow 0$, this follows from similar arguments as above.

In particular, the convolution of Φ, Ψ is defined by the following (well-defined) limit :

$$\Phi \tilde{*} \Psi := \lim_{k \rightarrow \infty} \phi_k \tilde{*} \psi_k \in \mathcal{V}_{i+j-n}^C \subset \text{Val}_{i+j-n}(E).$$

Let us consider the case when $\gamma = \mathcal{P}$. We use the same notations as above. Assume that $\{\phi_k\} \subset \mathcal{P}_i - \mathcal{P}_i, \{\psi_k\} \subset \mathcal{P}_j - \mathcal{P}_j$ are Cauchy sequences with respect to the norm $\|\cdot\|_{\mathcal{P}}$, and $\phi_k \rightarrow \Phi, \psi_k \rightarrow \Psi$. We show that $\{\phi_k \tilde{*} \psi_k\} \subset \mathcal{P}_{i+j-n} - \mathcal{P}_{i+j-n}$ is also a Cauchy sequence with respect to $\|\cdot\|_{\mathcal{P}}$.

As $\{\phi_k\}, \{\psi_k\}$ are Cauchy sequences, by the definition of the positivity norm $\|\cdot\|_{\mathcal{P}}$, we have the following properties :

1. For any $\varepsilon > 0$ and for all k, l large enough,

$$\begin{aligned} -\varepsilon V(\mathbf{B}[n-i]; -) &\preceq \phi_k - \phi_l \preceq \varepsilon V(\mathbf{B}[n-i]; -) \\ -\varepsilon V(\mathbf{B}[n-j]; -) &\preceq \psi_k - \psi_l \preceq \varepsilon V(\mathbf{B}[n-j]; -). \end{aligned}$$

2. There exists $c > 0$ such that for all k we have

$$\begin{aligned} -cV(\mathbf{B}[n-i]; -) &\preceq \phi_k \preceq cV(\mathbf{B}[n-i]; -) \\ -cV(\mathbf{B}[n-j]; -) &\preceq \psi_k \preceq cV(\mathbf{B}[n-j]; -) \end{aligned}$$

We write $\phi_k \tilde{*} \psi_k - \phi_l \tilde{*} \psi_l$ as follows :

$$\phi_k \tilde{*} \psi_k - \phi_l \tilde{*} \psi_l = \phi_k \tilde{*} (\psi_k - \psi_l) + (\phi_k - \phi_l) \tilde{*} \psi_l.$$

For any $L_1, \dots, L_{i+j-n} \in \mathcal{K}(E)$, as $\phi_k \tilde{*} (\psi_k - \psi_l)(L_1, \dots, L_{i+j-n})$ is computed by an integral, by the above properties it is easy to see that

$$|\phi_k \tilde{*} (\psi_k - \psi_l)(L_1, \dots, L_{i+j-n})| \leq c\varepsilon V(\mathbf{B}[2n - i - j]; L_1, \dots, L_{i+j-n}).$$

Hence, $\|\phi_k \tilde{*} (\psi_k - \psi_l)\|_{\mathcal{P}} \leq c\varepsilon$. Similarly, we also have $\|\psi_k \tilde{*} (\phi_k - \phi_l)\|_{\mathcal{P}} \leq c\varepsilon$.

The same argument shows that the limit

$$\Phi \tilde{*} \Psi := \lim_{k \rightarrow \infty} \phi_k \tilde{*} \psi_k \in \mathcal{V}_{i+j-n}^{\mathcal{P}} \subset \text{Val}_{i+j-n}(E)$$

is well defined, i.e., it is independent of the choices of the Cauchy sequences. \square

Remark 2.2.4.2. By Theorem 2.2.4.1, the results in Theorem 2.2.2.1 and Theorem 2.2.2.3 can be extended to valuations in the closure of the cones \mathcal{P}_i , with respect to the norms $\|\cdot\|_{\gamma}$.

2.3 A variant of Minkowski's existence theorem

By the discussion in Example 2.2.1.7, the classical Minkowski's existence theorem shows that every strictly \mathcal{P} -positive element in \mathcal{P}_1 is of the form $V(-; K[n-1])$. In this section, we discuss a generalization of this result, proving Theorem 6.

2.3.1 Existence of the solutions

Theorem 2.3.1.1. *For any strictly \mathcal{P} -positive valuation $\psi \in \mathcal{P}_i$, there is a constant $c > 0$ (depending only on ψ) and a convex body B with $\text{vol}(B) = 1$ such that*

$$\psi \tilde{*} V(B[i-1]; -) = cV(B[n-1]; -) \in \text{Val}_1(E).$$

In the following proof, we denote by ϕ_B the valuation given by $\phi_B = V(B[i-1]; -[n-i+1])$ where B is a convex body.

Given $\psi \in \mathcal{P}_i$, by scaling the convex set B , Theorem 2.3.1.1 implies that the functional equation (with unknown $B \in \mathcal{K}(E)$) :

$$(\psi - V(B[n-i]; -)) \tilde{*} \phi_B = 0 \in \text{Val}_1(E), \text{ where } \text{vol}(B) > 0$$

always admits a solution.

Proof. The proof is inspired by the method in [LX16]². We consider the following variational problem :

$$c := \inf_{M \in \mathcal{K}(E), \text{vol}(M)=1} \psi(M).$$

Claim 1 : Let $\{M_l\}$ be a minimizing sequence, that is, $\text{vol}(M_l) = 1$ and $\psi(M_l) \searrow c$, then we prove that up to some translations, the sequence $\{M_l\}$ is compact in $(\mathcal{K}(E), d_H)$.

Since $\psi \in \mathcal{P}_i$ is strictly \mathcal{P} -positive, there exists an $\varepsilon > 0$ such that :

$$\psi(L_1, \dots, L_i) \geq \varepsilon V(\mathbf{B}[n-i], L_1, \dots, L_i)$$

². It was realized in [LX17] that the same ideas had previously appeared in the classical work of Alexandrov [Ale38].

for any convex body L_1, \dots, L_i . In particular, one has that

$$V(K[n-i], M[i]) \leq \psi(M)$$

for any convex body M where $K = 1/\epsilon^{n-i}\mathbf{B}$. Then there is a uniform constant $d > 0$ such that

$$V(K[n-i]; M_l[i]) \leq d$$

for the minimizing sequence M_l .

By Alexandrov-Fenchel's inequality, we have

$$V(K[n-i]; M_l[i]) \geq V(K[n-1], M_l)^{n-i/n-1} \text{vol}(M_l)^{i-1/n-1} = V(K[n-1], M_l)^{n-i/n-1},$$

where the last equality follows from $\text{vol}(M_l) = 1$. In particular, $V(K[n-1], M_l)$ is uniformly bounded above. Let $r_l > 0$ be the minimal number such that $M_l \subset r_l K$ (up to a translation). Or equivalently, $1/r_l$ is the maximal number such that $M_l/r_l \subset K$ (up to a translation). By the Diskant inequality,

$$\begin{aligned} 1/r_l &\geq \frac{V(K[n-1], M_l)^{\frac{1}{n-1}} - \left(V(K[n-1], M_l)^{\frac{n}{n-1}} - \text{vol}(K) \text{vol}(M_l)^{\frac{1}{n-1}} \right)^{\frac{1}{n}}}{\text{vol}(M_l)^{\frac{1}{n-1}}} \\ &\geq \frac{\text{vol}(K)}{nV(K[n-1], M_l)}, \end{aligned}$$

where the last inequality follows from the generalized binomial formula (see also [LX17]). We get³

$$r_l \leq nV(K[n-1], M_l)/\text{vol}(K). \quad (2.9)$$

Thus the sequence r_l is uniformly bounded above. Then Blaschke selection theorem implies that, up to translations, the sequence M_l has an accumulation point $B \in \mathcal{K}(E)$ with $\text{vol}(B) = 1$. In particular,

$$c = \psi(B) = \inf_{M \in \mathcal{K}(E), \text{vol}(M)=1} \psi(M).$$

Claim 2 : For any $N \in \mathcal{K}(E)$, we have

$$\frac{n!}{i!(n-i+1)!} \psi^* \phi_B(N) - \psi(B)V(B[n-1], N) \geq 0, \quad (2.10)$$

and

$$\frac{n!}{i!(n-i+1)!} \psi^* \phi_B(B) - \psi(B)V(B[n-1], B) = 0. \quad (2.11)$$

Note that, since the minimal of the variational problem is achieved at $M = B$, for any $t \geq 0$ and any convex body N , we have

$$\psi \left(\frac{B + tN}{\text{vol}(B + tN)^{1/n}} \right) \geq \psi(B).$$

Calculating the right derivative at $t = 0$ implies

$$\frac{n!}{i!(n-i+1)!} \psi^* \phi_B(N) - \psi(B)V(B[n-1], N) \geq 0.$$

3. This can also be obtained by applying Theorem 2.2.2.1.

The equality (2.11) for B follows from the minimal property of B .

Claim 3 : There is a convex body L with non-empty interior such that

$$\frac{n!}{i!(n-i+1)!} \psi \tilde{*} \phi_B(-) = V(L[n-1], -).$$

By the discussion in Example 2.2.1.7, this is a direct consequence of Minkowski's existence theorem since $\psi \tilde{*} \phi_B \in \mathcal{P}_1$ is strictly \mathcal{P} -positive.

Now we can finish the proof of our theorem. By Claim 2 and 3, we have

$$V(L[n-1], N) - \psi(B)V(B[n-1], N) \geq 0$$

for any $N \in \mathcal{K}(E)$. Let $N = L$, we get

$$\text{vol}(L) = V(L[n-1], L) \geq \psi(B)V(B[n-1], L) \geq \psi(B) \text{vol}(B)^{n-1/n} \text{vol}(L)^{1/n}.$$

Thus $\text{vol}(L)^{n-1/n} \geq \psi(B) \text{vol}(B)^{n-1/n}$. On the other hand, let $N = B$, the equality in Claim 2 implies

$$V(L[n-1], B) = \psi(B) \text{vol}(B) \geq \text{vol}(L)^{n-1/n} \text{vol}(B)^{1/n}.$$

Thus $V(L[n-1], B) = \text{vol}(L)^{n-1/n} \text{vol}(B)^{1/n}$, which implies the $L = \psi(B)^{1/n-1} B$. Then we get

$$\frac{n!}{i!(n-i+1)!} \psi \tilde{*} \phi_B(-) = V(L[n-1], -) = \psi(B)V(B[n-1], -).$$

This finishes the proof of the result. □

2.3.2 Compactness of the solution set

In Minkowski's existence theorem, up to some translation, the solution is unique. In the generalized case, we show that the (normalized) solution set of the functional equation (with unknown $B \in \mathcal{K}(E)$)

$$(\psi - V(B[n-i]; -)) \tilde{*} \phi_B = 0 \in \text{Val}_1(E), \text{ where } \text{vol}(B) = 1, \phi_B(-) = V(-; B[i-1]),$$

is compact in $(\mathcal{K}(E), d_H)$.

Proposition 2.3.2.1. *Given any strictly \mathcal{P} -positive valuation $\psi \in \mathcal{P}_i$, up to translations, the set of normalized solutions of the above equation is compact.*

Proof. Fix a convex body L with non-empty interior. Since $\text{vol}(B) = 1$, similar to the argument in Theorem 2.3.1.1, by Blaschke selection theorem and the Diskant inequality it is sufficient to show that $V(B; L[n-1])$ is uniformly bounded above.

To this end, note that

$$V(B[n-1], L) \geq V(B, L[n-1])^{1/n-1} \text{vol}(B)^{n-2/n-1},$$

thus it is sufficient to prove the upper bound for $V(B[n-1], L)$. By the functional equation, we get

$$\frac{n!}{i!(n-i+1)!} (\psi \tilde{*} \phi_B)(L) = V(B[n-1], L).$$

Assume that ψ is given by the measure μ , then

$$\begin{aligned} \frac{n!}{i!(n-i+1)!}(\psi\tilde{*}\phi_B)(L) &= \int_{\mathcal{K}(E)^{n-i}} V(B[i-1], L; A_1, \dots, A_{n-i}) d\mu(A_1, \dots, A_{n-i}) \\ &\leq cV(B[i-1], L[n-i+1]) \int_{\mathcal{K}(E)^{n-i}} V(L[i], A_1, \dots, A_{n-i}) d\mu(A_1, \dots, A_{n-i}), \end{aligned}$$

where the second inequality follows from Theorem 2.2.2.1, and $c > 0$ depends only on $n, i, \text{vol}(L)$. Then it is sufficient to give an upper bound for $V(B[i-1], L[n-i+1])$.

Since ψ is strictly \mathcal{P} -positive,

$$1 = \text{vol}(B) = \frac{n!}{i!(n-i+1)!}(\psi\tilde{*}\phi_B)(B) \geq c'V(L[n-i]; B[i]),$$

thus $V(B[i], L[n-i])$ is uniformly bounded above. On the other hand, since $\text{vol}(B) = 1$, the Alexandrov-Fenchel inequality implies that

$$V(B[i], L[n-i]) \geq V(B[i-1], L[n-i+1])^{n-i/n-i+1}.$$

Thus $V(B[i-1], L[n-i+1])$ is uniformly bounded above, which implies the compactness of the solution set. \square

Remark 2.3.2.2. By the above proof, it is clear that the compactness result holds whenever the $\text{vol}(B)$ has a uniformly positive lower bound.

Remark 2.3.2.3. Using the same argument as in Theorem 2.3.1.1 and Proposition 2.3.2.1, one can get the following analogy in complex geometry (see also [LX16, Section 5]).

Let X be a compact Kähler manifold of dimension n . Assume that $\Theta \in H^{k,k}(X, \mathbb{R})$ is a strictly positive (k, k) class in the sense that for some Kähler class ω the class $\Theta - \omega^k$ contains some positive (k, k) current. Let

$$c = \inf_{A \text{ Kähler, } \text{vol}(A)=1} (\Theta \cdot A^{n-k}).$$

Then there is a decomposition

$$\Theta \cdot B^{n-k-1} = cB^{n-1} + \mathcal{N},$$

where B is big and nef satisfying $\text{vol}(B) = 1$, $\mathcal{N} \cdot N \geq 0$ for any nef class N and $\mathcal{N} \cdot B = 0$. Moreover, the set of the (normalized) solutions B is compact.

In particular, if any big nef class is Kähler, we must have $\mathcal{N} = 0$, thus on Kähler manifolds satisfying this condition, for any strictly positive (k, k) class Θ , there is a Kähler class B such that

$$(\Theta - B^k) \cdot B^{n-k-1} = 0.$$

Note that this holds for Abelian varieties and generic hyperkähler manifolds.

Assume that X is a smooth Abelian variety or generic hyperkähler manifold, and assume $2k \leq n$. By Hodge theory, we have the primitive decomposition with respect to the Kähler class B :

$$\Theta - B^k = P_k \oplus B \cdot \Gamma,$$

where $P_k \in H^{k,k}(X, \mathbb{R})$ is the primitive class (i.e., $B^{n-2k+1} \cdot P_k = 0$), and Γ is a $(k-1, k-1)$ class. In particular, if $n = 4, k = 2$, then $(\Theta - B^2) \cdot B = 0$. Hence, up to a primitive class, every strictly positive $(2, 2)$ class is equal to B^2 for some Kähler class B .

2.4 Dynamical degrees

2.4.1 Existence

Recall that $\mathrm{GL}(E)$ has a natural action on $\mathrm{Val}(E)$, which is defined by

$$(g \cdot \phi)(K) = \phi(g^{-1}K).$$

The space $\mathrm{Val}_i(E)$ is fixed by this action. Furthermore, by Example 2.1.3.1, the map $\phi \mapsto g \cdot \phi$ maps the positive cone \mathcal{P}_i to \mathcal{P}_i .

Definition 2.4.1.1 (Degree). *Given $\psi \in \mathcal{P}_i$ and $\phi \in \mathcal{P}_{n-i}$ strictly \mathcal{P} -positive, the $(n-i)$ -th degree of $g \in \mathrm{GL}(E)$ with respect to ϕ, ψ is defined by*

$$\mathrm{deg}_{n-i}(g) = (g \cdot \psi) \tilde{*} \phi.$$

We are interested in the sequence $\{\mathrm{deg}_{n-i}(g^p)\}_p$.

Definition 2.4.1.2 (Dynamical degree). *Given $g \in \mathrm{GL}(E)$, $\psi \in \mathcal{P}_i$ and $\phi \in \mathcal{P}_{n-i}$ strictly \mathcal{P} -positive, the $(n-i)$ -th dynamical degree of g is defined by*

$$\begin{aligned} d_{n-i}(g) &:= \lim_{k \rightarrow \infty} \mathrm{deg}_{n-i}(g^k)^{1/k} \\ &= \lim_{k \rightarrow \infty} ((g^k \cdot \psi) \tilde{*} \phi)^{1/k}. \end{aligned}$$

Remark 2.4.1.3. In the study of the dynamics of a holomorphic map $f : X \rightarrow X$ where X is a projective variety, one can similarly define a degree :

$$\mathrm{deg}_k(f) = \int_X f^* \omega^k \wedge \omega^{n-k},$$

where ω is a Kähler class on X . Similarly, we can study the asymptotic behaviour of the sequence $\mathrm{deg}_{n-i}(f^k)$, $k \in \mathbb{N}$, and the i -th dynamical degree of f is defined similarly.

Our first fundamental result is that the $(n-i)$ -th dynamical degree exists, that is, the limit defining $d_{n-i}(g)$ exists, and $d_{n-i}(g)$ is independent of the choices of $\psi \in \mathcal{P}_i, \phi \in \mathcal{P}_{n-i}$.

Sub-multiplicity estimate

In order to prove the existence of $d_{n-i}(g)$, we first establish the following sub-multiplicity estimate for degrees.

Lemma 2.4.1.4. *Consider $\phi \in \mathcal{P}_{n-i}$ and $\psi \in \mathcal{P}_i$ are given by*

$$\psi(-) = V(-; B[n-i]) \in \mathcal{P}_i, \phi(-) = V(-; B[i]) \in \mathcal{P}_{n-i},$$

where $B \in \mathcal{K}(E)$ has non-empty interior. We consider the $n-i$ -th degree deg_{n-i} given by ϕ, ψ . Assume $f, g \in \mathrm{GL}(E)$, then there is a constant $C > 0$ depending only on $\mathrm{vol}(B), n, i$ such that

$$\mathrm{deg}_{n-i}(fg) \leq C \mathrm{deg}_{n-i}(f) \mathrm{deg}_{n-i}(g).$$

In particular, given $g \in \mathrm{GL}(E)$, the sequence $\{\log(C \mathrm{deg}_{n-i}(g^k))\}_{k=1}^{\infty}$ is subadditive, that is,

$$\log(C \mathrm{deg}_{n-i}(g^{k+l})) \leq \log(C \mathrm{deg}_{n-i}(g^k)) + \log(C \mathrm{deg}_{n-i}(g^l)), \text{ for any } k, l \in \mathbb{N}.$$

Proof. For any convex body B , let us denote by ϕ_B and ψ_B given by $\phi_B = V(B[i], -[n-i])$ and $\psi_B = V(B[n-i], -[i])$.

Since $\deg_{n-i}(-)$ is given by ψ_B and ϕ_B , we get

$$\begin{aligned} \deg_{n-i}(f) \deg_{n-i}(g) &= ((f \cdot \psi_B) \tilde{*} \phi_B) ((g \cdot \psi_B) \tilde{*} \phi_B) \\ &= |\det(fg)|^{-1} (\psi_{f(B)} \tilde{*} \phi_B) (\psi_{g(B)} \tilde{*} \phi_B) \\ &= |\det(fg)|^{-1} |\det f|^{-1} (\psi_{f(B)} \tilde{*} \phi_B) (\psi_{fg(B)} \tilde{*} \phi_{f(B)}). \end{aligned} \quad (2.12)$$

Note that there exists a constant $c' > 0$ such that $(\psi_{f(B)} \tilde{*} \phi_B) (\psi_{fg(B)} \tilde{*} \phi_{f(B)}) = c' \phi_B(f(B)) \psi_{fg(B)}(f(B))$. By Theorem 2.2.2.1, there is a uniform constant $c > 0$ such that

$$\begin{aligned} (\psi_{f(B)} \tilde{*} \phi_B) (\psi_{fg(B)} \tilde{*} \phi_{f(B)}) &\geq c \operatorname{vol}(f(B)) (\psi_{fg(B)} \tilde{*} \phi_B) \\ &= c |\det f| |\det fg| \operatorname{vol}(B) ((fg \cdot \psi_B) \tilde{*} \phi_B) \\ &= c |\det f| |\det fg| \operatorname{vol}(B) \deg_{n-i}(fg). \end{aligned} \quad (2.13)$$

Thus, (2.12) and (2.13) imply that

$$\deg_{n-i}(fg) \leq C \deg_{n-i}(f) \deg_{n-i}(g),$$

where $C = 1/(c \operatorname{vol}(B)) > 0$ and this finishes the proof of the sub-multiplicity estimate. \square

Remark 2.4.1.5. In the study of complex dynamics, the analogous estimate for rational self-maps is obtained in [DS05c, DS04b] using the theory of positive currents. The above simple proof is inspired by [Dan17].

Lemma 2.4.1.6 (Fekete lemma). *For every subadditive sequence $\{a_k\}_{k=1}^{\infty}$, the limit $\lim_{k \rightarrow \infty} \frac{a_k}{k}$ exists and*

$$\lim_{k \rightarrow \infty} \frac{a_k}{k} = \inf_{k \geq 1} \frac{a_k}{k}.$$

Theorem 2.4.1.7. *Given $g \in \operatorname{GL}(E)$, the dynamical degree $d_{n-i}(g)$ exists and is independent of the choices of strictly \mathcal{P} -positive $\psi \in \mathcal{P}_i, \phi \in \mathcal{P}_{n-i}$.*

Proof. If $\psi = V(-; \mathbf{B}[n-i]), \phi = V(-; \mathbf{B}[i])$, the existence of $d_{n-i}(g)$ follows directly from Fekete's lemma.

For the independence on ψ, ϕ , we first note that

$$\psi \preceq \|\psi\|_{\mathcal{P}} V(\mathbf{B}[n-i]; -), \quad \phi \preceq \|\phi\|_{\mathcal{P}} V(\mathbf{B}[i]; -),$$

which follow from the definition of $\|\cdot\|_{\mathcal{P}}$. Applying Lemma 2.2.3.7 implies :

$$g^k \cdot \psi \preceq \|\psi\|_{\mathcal{P}} g^k \cdot V(\mathbf{B}[n-i]; -).$$

Moreover, Lemma 2.2.3.6 yields :

$$(g^k \cdot \psi) \tilde{*} \phi \leq \|\psi\|_{\mathcal{P}} g^k \cdot V(\mathbf{B}[n-i]; -) \tilde{*} \phi.$$

Then we get :

$$(g^k \cdot \psi) \tilde{*} \phi \leq \|\psi\|_{\mathcal{P}} \|\phi\|_{\mathcal{P}} (g^k \cdot V(\mathbf{B}[n-i]; -)) \tilde{*} V(\mathbf{B}[i]; -). \quad (2.14)$$

On the other hand, by the strict positivity of ψ, ϕ , there is a constant $C > 0$ depending only on ψ, ϕ such that

$$C(g^k \cdot V(\mathbf{B}[n-i], -)) \tilde{*} V(\mathbf{B}[i], -) \leq (g^k \cdot \psi) \tilde{*} \phi. \quad (2.15)$$

Thus, the inequalities (2.14), (2.15) imply that $d_{n-i}(g)$ does not depend on the choices of $\phi \in \mathcal{P}_{n-i}$ and $\psi \in \mathcal{P}_i$. \square

Norms of linear operators

Let $g \in \text{GL}(E)$, then by Example 2.1.3.1 it induces a linear operator (denoted by g_i) :

$$g_i : \mathcal{V}'_i \rightarrow \mathcal{V}'_i.$$

In the following, let $\gamma \in \{\mathcal{C}, \mathcal{P}\}$.

We first show that g_i extends to a map :

$$g_i : \mathcal{V}_i^\gamma \rightarrow \mathcal{V}_i^\gamma.$$

Lemma 2.4.1.8. *Let $g \in \text{GL}(E)$. Assume that $\|\phi_k - \phi\|_\gamma \rightarrow 0$, then $\|g \cdot \phi_k - g \cdot \phi\|_\gamma \rightarrow 0$.*

Proof. For the norm $\|\cdot\|_{\mathcal{C}}$, it is obvious.

We only need to deal with the norm $\|\cdot\|_{\mathcal{P}}$. By definition, we have

$$|(\phi_k - \phi)(L_1, \dots, L_i)| \leq \|\phi_k - \phi\|_{\mathcal{P}} V(\mathbf{B}[n-i]; L_1, \dots, L_i),$$

which implies

$$\begin{aligned} |g \cdot (\phi_k - \phi)(L_1, \dots, L_i)| &\leq \|\phi_k - \phi\|_{\mathcal{P}} V(\mathbf{B}[n-i]; g^{-1}(L_1), \dots, g^{-1}(L_i)) \\ &= \|\phi_k - \phi\|_{\mathcal{P}} \frac{1}{|\det g|} V(g(\mathbf{B})[n-i]; L_1, \dots, L_i). \end{aligned}$$

On the other hand, by Theorem 2.2.2.1 we have

$$V(g(\mathbf{B})[n-i]; L_1, \dots, L_i) \leq c V(g(\mathbf{B})[n-i]; \mathbf{B}[i]) V(\mathbf{B}[n-i]; L_1, \dots, L_i),$$

where $c > 0$ depends only on $n, i, \text{vol}(\mathbf{B})$. Hence,

$$\|g \cdot (\phi_k - \phi)\|_{\mathcal{P}} \leq c \frac{1}{|\det g|} V(g(\mathbf{B})[n-i]; \mathbf{B}[i]) \|\phi_k - \phi\|_{\mathcal{P}}.$$

This finishes the proof of the result. □

Next we show that the dynamical degree $d_{n-i}(g)$ is just the spectral radius of this operator.

Theorem 2.4.1.9. *Let $g \in \text{GL}(E)$ and let g_i be the induced operator on \mathcal{V}'_i , then the following equality is satisfied :*

$$d_{n-i}(g) = \|g_{n-i} : \mathcal{V}_i^{\mathcal{P}} \rightarrow \mathcal{V}_i^{\mathcal{P}}\| = \|g_{n-i} : \mathcal{V}_i^{\mathcal{C}} \rightarrow \mathcal{V}_i^{\mathcal{C}}\|,$$

where the symbol $\|g_{n-i} : \mathcal{V}_i^{\mathcal{P}} \rightarrow \mathcal{V}_i^{\mathcal{P}}\|$ and $\|g_{n-i} : \mathcal{V}_i^{\mathcal{C}} \rightarrow \mathcal{V}_i^{\mathcal{C}}\|$ denotes the norm of the operator g_{n-i} on $\mathcal{V}_i^{\mathcal{P}}$ and $\mathcal{V}_i^{\mathcal{C}}$ respectively.

Proof. For simplicity, since each space is endowed with its appropriate norm, we denote by $\|g_{n-i}\|_{\mathcal{P}}$ and $\|g_{n-i}\|_{\mathcal{C}}$ the norm of the operator g_{n-i} on $\mathcal{V}_i^{\mathcal{P}}$ and $\mathcal{V}_i^{\mathcal{C}}$ respectively. We need to verify the equality

$$d_{n-i}(g) = \lim_{k \rightarrow \infty} \|g_i^k\|_\gamma^{1/k}.$$

We first consider the case when $\gamma = \mathcal{C}$.

Let $\phi_{\mathbf{B}} = V(\mathbf{B}[n-i]; -)$, by definition we get

$$\begin{aligned} \|g^k \cdot \phi_{\mathbf{B}}\|_{\mathcal{C}} &= (g^k \cdot \phi_{\mathbf{B}})(\mathbf{B}) = V(g^k(\mathbf{B})[n-i], \mathbf{B}[i]) / |\det g|^k, \\ \|\phi_{\mathbf{B}}\|_{\mathcal{C}} &= \phi_{\mathbf{B}}(\mathbf{B}) = V(\mathbf{B}[n-i], \mathbf{B}[i]). \end{aligned}$$

This implies that

$$\|g_i^k\|_c \geq \frac{V(g^k(\mathbf{B})[n-i], \mathbf{B}[i])}{|\det g|^k \text{vol}(\mathbf{B})}. \quad (2.16)$$

On the other hand, take a sequence $\phi_l \in \mathcal{P}_i - \mathcal{P}_i$ such that $\|\phi_l\|_c = 1$ and $\|g^k \cdot \phi_l\|_c \rightarrow \|g_i^k\|_c$ as $l \rightarrow \infty$. For l_0 large enough, we have $\|g_i^k\|_c \leq 2\|g^k \cdot \phi_{l_0}\|_c$. Assume that $\phi_{l_0} = \phi_{l_0}^+ - \phi_{l_0}^-$ is a decomposition for ϕ_{l_0} , then

$$\|g_i^k\|_c \leq 2(g^k \cdot \phi_{l_0}^+(\mathbf{B}) + g^k \cdot \phi_{l_0}^-(\mathbf{B})).$$

For the term $g^k \cdot \phi_{l_0}^+(\mathbf{B})$, by Theorem 2.2.2.1 there is a constant $c > 0$ depending only on $n, i, \text{vol}(\mathbf{B})$ such that

$$\begin{aligned} g^k \cdot \phi_{l_0}^+(\mathbf{B}) &= \int_{\mathcal{K}(E)^{n-i}} V(g^{-k}(\mathbf{B})[i], A_1, \dots, A_{n-i}) d\mu_{l_0}^+(A_1, \dots, A_{n-i}) \\ &\leq cV(g^{-k}(\mathbf{B})[i], \mathbf{B}[n-i]) \int_{\mathcal{K}(E)^{n-i}} V(\mathbf{B}[i], A_1, \dots, A_{n-i}) d\mu_{l_0}^+(A_1, \dots, A_{n-i}) \\ &= cV(g^{-k}(\mathbf{B})[i], \mathbf{B}[n-i])\phi_{l_0}^+(\mathbf{B}). \end{aligned}$$

Similarly,

$$g^k \cdot \phi_{l_0}^-(\mathbf{B}) \leq cV(g^{-k}(\mathbf{B})[i], \mathbf{B}[n-i])\phi_{l_0}^-(\mathbf{B}). \quad (2.17)$$

Since $\|\phi_{l_0}\|_c = 1$, we get

$$\|g_i^k\|_c \leq 2cV(g^{-k}(\mathbf{B})[i], \mathbf{B}[n-i]). \quad (2.18)$$

Next we consider the case when $\gamma = \mathcal{P}$. Note that $\|\phi_{\mathbf{B}}\|_{\mathcal{P}} = 1$. By the definition for $\|g^k \cdot \phi_{\mathbf{B}}\|_{\mathcal{P}}$, we have $g^k \cdot \phi_{\mathbf{B}}(\mathbf{B}) \leq \|g^k \cdot \phi_{\mathbf{B}}\|_{\mathcal{P}} \text{vol}(\mathbf{B})$, hence

$$\|g^k \cdot \phi_{\mathbf{B}}\|_{\mathcal{P}} \geq V(\mathbf{B}[n-i], g^{-k}(\mathbf{B})[i]) / \text{vol}(\mathbf{B}).$$

This implies that

$$\|g_i^k\|_{\mathcal{P}} \geq \frac{V(g^k(\mathbf{B})[n-i], \mathbf{B}[i])}{|\det g|^k \text{vol}(\mathbf{B})}. \quad (2.19)$$

On the other hand, take a sequence ϕ_l such that $\|\phi_l\|_{\mathcal{P}} = 1$ and $\|g^k \cdot \phi_l\|_{\mathcal{P}} \rightarrow \|g_i^k\|_{\mathcal{P}}$ as $l \rightarrow \infty$. For l_0 large enough, we have $\|g_i^k\|_{\mathcal{P}} \leq 2\|g^k \cdot \phi_{l_0}\|_{\mathcal{P}}$. For any L_1, \dots, L_i ,

$$\begin{aligned} |g^k \cdot \phi_{l_0}(L_1, \dots, L_i)| &= |\phi_{l_0}(g^{-k}(L_1), \dots, g^{-k}(L_i))| \\ &\leq \|\phi_{l_0}\|_{\mathcal{P}} V(\mathbf{B}[n-i], g^{-k}(L_1), \dots, g^{-k}(L_i)). \end{aligned}$$

Applying $\|\phi_{l_0}\|_{\mathcal{P}} = 1$ and Theorem 2.2.2.1 yields a uniform constant $c' > 0$ such that

$$\|g_i^k\|_{\mathcal{P}} \leq c'V(g^k(\mathbf{B})[n-i], \mathbf{B}[i]) / |\det g|^k. \quad (2.20)$$

In summary, by (2.16), (2.18), (2.19), (2.20) and taking the limits, we obtain the desired equality

$$d_{n-i}(g) = \lim_{k \rightarrow \infty} \|g_i^k\|_{\gamma}^{1/k}.$$

□

Log-concavity

By Theorem 2.4.1.7, the definition of $d_{n-i}(g)$ is independent of the choices of ψ, ϕ . A direct consequence of this result is the following :

Proposition 2.4.1.10. *For any $g \in \text{GL}(E)$, the sequence $\{d_i(g)\}$ is log-concave, that is, for $1 \leq i \leq n-1$*

$$d_i(g)^2 \geq d_{i-1}(g)d_{i+1}(g).$$

Proof. By Theorem 2.4.1.7, we get

$$\begin{aligned} d_i(g) &= \lim_{k \rightarrow \infty} (|\det g^k|^{-1} V(g^k(B)[i], B[n-i]))^{1/k} \\ &= |\det g|^{-1} \lim_{k \rightarrow \infty} (V(g^k(B)[i], B[n-i]))^{1/k}, \end{aligned}$$

where B is a fixed convex body with non-empty interior. Then the log-concavity property follows immediately from the Alexandrov-Fenchel inequality for mixed volumes. \square

Relative version

In the study of dynamics of a holomorphic map that preserves some fibration, it is useful to consider a relative version of dynamical degrees. We have a corresponding picture for convex valuations. Let S be a subspace of dimension m , and assume that $l : S \rightarrow E$ is the embedding. Assume that $g \in \text{GL}(E)$ fixes the subspace S , equivalently, there is a map $f \in \text{GL}(S)$ such that $g \circ l = l \circ f$.

Definition 2.4.1.11. *Assume that $\psi \in \mathcal{P}_i(E), \phi \in \mathcal{P}_{n-i+m}(E)$ are strictly \mathcal{P} -positive, and let $\tau_B = V(-; B[m]) \in \text{Val}_{n-m}(E)$, where $B \in \mathcal{K}(S)$ satisfies $\text{vol}_S(B) > 0$, then the $(n-i)$ -th relative degree of g is defined by*

$$\text{reldeg}_{n-i}(g) = (g \cdot \psi) \tilde{*} \phi \tilde{*} \tau_B.$$

Definition 2.4.1.12. *The $(n-i)$ -th relative dynamical degree of g is defined by*

$$\text{reld}_{n-i}(g) = \lim_{k \rightarrow \infty} (\text{reldeg}_{n-i}(g^k))^{1/k}.$$

Similar to Theorem 2.4.1.7, we have :

Theorem 2.4.1.13. *The relative dynamical degree $\text{reld}_{n-i}(g)$ exists and is independent of the choices of $\psi \in \mathcal{P}_i, \phi \in \mathcal{P}_{n-i}$ (which are strictly \mathcal{P} -positive), and $B \in \mathcal{K}(S)$ with non-empty interior.*

Proof. The proof is similar to Theorem 2.4.1.7, so we omit the details. The only extra ingredient is the following reduction formula for mixed volumes (see [Sch14, Theorem 5.3.1]).

Lemma 2.4.1.14. *Let k be an integer satisfying $1 \leq k \leq n-1$, let $H \subset \mathbb{R}^n$ be a k -dimensional linear subspace and let $L_1, \dots, L_k, K_1, \dots, K_{n-k}$ be convex bodies with $L_i \subset H$ for $i = 1, \dots, k$. Then*

$$\binom{n}{k} V(L_1, \dots, L_k, K_1, \dots, K_{n-k}) = V_H(L_1, \dots, L_k) V_{H^\perp}(p_{H^\perp}(K_1), \dots, p_{H^\perp}(K_{n-k})),$$

where $V_H(\cdot)$ and $V_{H^\perp}(\cdot)$ denote the mixed volume in H and H^\perp , and $p_{H^\perp} : \mathbb{R}^n \rightarrow H^\perp$ is the projection map. \square

Remark 2.4.1.15. Similar to the complex geometry setting (see e.g. [DN11b], [Dan17]), one could also establish a product formula between the dynamical degrees and the relative dynamical degrees.

2.4.2 Evaluation of dynamical degrees

In this section, we give a formula for $d_{n-i}(g)$ using the eigenvalues of g . The key point is the formula

$$d_{n-i}(g) = |\det g|^{-1} \lim_{k \rightarrow \infty} (V(g^k(B)[n-i], B[i]))^{1/k}.$$

Theorem 2.4.2.1. *Let $g \in \mathrm{GL}(E)$, and assume that ρ_1, \dots, ρ_n are the eigenvalues of g satisfying*

$$|\rho_1| \geq |\rho_2| \geq \dots \geq |\rho_n|,$$

then the $(n-i)$ -th dynamical degree $d_{n-i}(g) = |\det g|^{-1} \prod_{k=1}^{n-i} |\rho_k|$.

It is clear that we only need to check the equality

$$\widehat{d}_{n-i}(g) := \lim_{k \rightarrow \infty} (V(g^k(B)[n-i], B[i]))^{1/k} = \prod_{k=1}^{n-i} |\rho_k|.$$

Remark 2.4.2.2. In the study of dynamics of monomial maps, the above formula was first obtained in [Lin12, FW12]. The proof of [Lin12] is algebraic, and the proof of [FW12] applies some ideas from integral geometry. We present a different (and simpler) approach to the calculation of $d_i(g)$, by using positivity results.

Simple case : $d_1(g)$

We first discuss the simple calculation for $d_1(g)$. We need to verify the formula

$$\lim_{k \rightarrow \infty} V(g^k(B), B[n-1])^{1/k} = |\rho_1(g)|.$$

By Theorem 2.4.1.7, for any $L, M \in \mathcal{K}(E)$ with non-empty interior, we have

$$d_1(g) = |\det g|^{-1} \lim_{k \rightarrow \infty} V(g^k(L), M[n-1])^{1/k}.$$

First, we prove $d_1(g) \leq |\det g|^{-1} |\rho_1(g)|$. To this end, we fix a Euclidean structure on E and assume that $0 \in L$ is an interior point. Then for any point $x \in \partial L$ we have $|g(x)| \leq \|g\| |x|$, thus

$$g(L) \subset c \|g\| \mathbf{B}$$

where \mathbf{B} is the unit ball and $c = \max_{x \in \partial L} |x|$. In particular, applying the observation to g^k implies

$$g^k(L) \subset c \|g^k\| \mathbf{B}.$$

Thus,

$$\begin{aligned} d_1(g) &\leq |\det g|^{-1} \lim_{k \rightarrow \infty} \|g^k\|^{1/k} V(c \mathbf{B}, M[n-1])^{1/k} \\ &= |\det g|^{-1} |\rho_1(g)|. \end{aligned}$$

Next, we prove the reverse inequality $d_1(g) \geq |\det g|^{-1} |\rho_1(g)|$. For any k , we can take a unit vector x_k such that $|g^k(x_k)| = \|g^k\|$. We take $L = 2\mathbf{B}$ and take $M = \mathbf{B}$. Then the segment $S_k := [0, x_k] \subset L$, yielding

$$V(g^k(S_k), M[n-1]) \leq V(g^k(L), M[n-1]).$$

Note that

$$V(g^k(S_k), M[n-1]) = \|g^k\| V(\|g^k\|^{-1} g^k(S_k), M[n-1]).$$

Next we take $\mathbf{r} = \mathbf{t} = (1, \dots, 1)$ and compute $V(g^p(K_1)[k], K_1[n-k])$. To this end, we note that

$$g^p(K_1) = K_{\mathbf{r}_p},$$

where $\mathbf{r}_p = (|\lambda_1|^p, \dots, |\lambda_s|^p, |\lambda_{s+1}|^p, \dots, |\lambda_n|^p)$. Then a direct computation shows that

$$\widehat{d}_k(g) = \prod_{i=1}^k |\rho_i(g)|.$$

□

Remark 2.4.2.4. The calculations in Lemma 2.4.2.3 are inspired by the calculations in [FW12, Section 5.1], where the authors did the computations for diagonalizable maps over \mathbb{R} and also gave a remark for diagonalizable maps over \mathbb{C} .

Next we show that the dynamical degree function

$$d_k : \mathrm{GL}(E) \rightarrow \mathbb{R}, \quad g \mapsto d_k(g)$$

is continuous.

Theorem 2.4.2.5. *The dynamical degree $d_k(\cdot)$ is a continuous function on $\mathrm{GL}(E)$. More precisely, let $\{g_l\}_{l \geq 1}, g \in \mathrm{GL}(E)$ endowed with the topology induced by the L^2 -norm of $E \times E$, then*

$$\lim_{g_l \rightarrow g} d_k(g_l) = d_k(g).$$

Proof. It is sufficient to prove that

$$\lim_{g_l \rightarrow g} \widehat{d}_k(g_l) = \widehat{d}_k(g).$$

By Theorem 2.4.1.7, the dynamical degree is independent of the choices of ϕ, ψ . In the following we take $K = \mathbf{B}$ to be the unit ball with 0 as its center. We have

$$\widehat{d}_k(g) = \lim_{k \rightarrow \infty} V(g^p(K)[k], K[n-k])^{1/p}.$$

We first prove $\lim_{l \rightarrow \infty} \widehat{d}_k(g_l) \geq \widehat{d}_k(g)$. We consider the *inradius* of $g_l^p(K)$ relative to $g^p(K)$, which is defined by

$$r(g_l^p(K), g^p(K)) := \max\{\lambda > 0 \mid \lambda g^p(K) \subset g_l^p(K) \text{ up to some translation}\}.$$

Applying the Diskant inequality to $g_l^p(K), g^p(K)$, we get

$$r(g_l^p(K), g^p(K)) \geq \frac{\mathrm{vol}(g_l^p(K))}{nV(g_l^p(K)[n-1], g^p(K))}.$$

We next estimate the mixed volume $V(g_l^p(K)[n-1], g^p(K))$. Note that

$$\begin{aligned} V(g_l^p(K)[n-1], g^p(K)) &= |\det(g_l)|^p V(K[n-1], (g_l^{-p} \circ g^p)(K)) \\ &= |\det(g_l)|^p \int_{\mathbb{S}^{n-1}} h_{(g_l^{-p} \circ g^p)(K)}(x) dS(K^{n-1}; x), \end{aligned}$$

where $h_{(g_l^{-p} \circ g^p)(K)}$ is the support function of the convex body $(g_l^{-p} \circ g^p)(K)$, and $dS(K^{n-1}; \cdot)$ is the surface area measure. For any linear map $A : E \rightarrow E$, by the definition of support function we have

$$h_{A(K)}(x) = \max\{x \cdot y \mid y \in A(K)\} = \max\{A^T x \cdot y \mid y \in K\}.$$

Thus $h_{A(K)}(x) = h_K(A^T x)$. Since $K = \mathbf{B}$, we have $h_K(x) = h_{\mathbf{B}}(x) = |x|$. Then we get

$$\begin{aligned} h_{(g_l^{-p} \circ g^p)(K)}(x) &= h_K((g_l^{-p} \circ g^p)^T x) = |(g_l^{-p} \circ g^p)^T x| \\ &\leq \|g_l^{-p} \circ g^p\| |x| = \|g_l^{-p} \circ g^p\| h_K(x). \end{aligned}$$

Applying the above inequality to $V(g_l^p(K)[n-1], g^p(K))$ implies

$$V(g_l^p(K)[n-1], g^p(K)) \leq |\det(g_l)|^p (\|g_l^{-p} \circ g^p\|) \text{vol}(K).$$

Then we have

$$\begin{aligned} V(g_l^p(K)[k], K[n-k])^{1/p} &\geq r(g_l^p(K), g^p(K))^{k/p} V(g^p(K)[k], K[n-k])^{1/p} \\ &\geq \left(\frac{\text{vol}(g_l^p(K))}{n V(g_l^p(K)[n-1], g^p(K))} \right)^{k/p} V(g^p(K)[k], K[n-k])^{1/p} \\ &\geq \left(\frac{|\det(g_l)|^p \text{vol}(K)}{n |\det(g_l)|^p (\|g_l^{-p} \circ g^p\|) \text{vol}(K)} \right)^{k/p} V(g^p(K)[k], K[n-k])^{1/p} \\ &= (\|g_l^{-p} \circ g^p\|^{1/p})^{-k} n^{-k/p} V(g^p(K)[k], K[n-k])^{1/p}. \end{aligned}$$

Lemma 2.4.2.6. *For any sequence g_l converging to g , we have*

$$\lim_{l \rightarrow +\infty} \lim_{p \rightarrow +\infty} \|g_l^{-p} \circ g^p\|^{1/p} \leq 1.$$

Proof. We only need to consider the action of $g_l^{-p} \circ g^p$ on invariant subspaces. Assume that $\|x\| = 1$ and $x \in \ker(g - \lambda I)^b$, where b is the multiplicity of the eigenvalue λ . By assumption, we have that :

$$g^p(x) \in \ker(g - \lambda I)^b.$$

By considering the Jordan form of g , there exists a constant $C > 0$ (independent of x , as $\|x\| = 1$) such that :

$$\|g^p(x)\| \leq Cp^b |\lambda|^p.$$

Since g_l converges to g , $g^p(x)$ is in the union of invariant subspaces of g_l which correspond to the eigenvalues converging to λ . Thus for any fixed $\delta > 0$, there exists l_δ such that when $l \geq l_\delta$, we have

$$\|g_l^{-p} \circ g^p(x)\| \leq C' p^{b'} (|\lambda| - \delta)^{-p} |\lambda|^p,$$

where C', b' are uniform constants by considering Jordan forms. Taking the limits gives

$$\lim_{l \rightarrow +\infty} \lim_{p \rightarrow +\infty} \|g_l^{-p} \circ g^p\|^{1/p} \leq 1. \quad \square$$

Using the above lemma, we get $\widehat{d}_k(g) \leq \lim_{l \rightarrow \infty} \widehat{d}_k(g_l)$.

Similarly, by studying the inradius of $g^p(K)$ relative to $g_l^p(K)$, we get $\widehat{d}_k(g) \geq \lim_{l \rightarrow \infty} \widehat{d}_k(g_l)$. This finishes the proof of the continuity. \square

Remark 2.4.2.7. The complex analog of Theorem 2.4.2.5 implies the following interesting continuity result for dynamical degrees of holomorphic maps :

Let X be a compact Kähler manifold of dimension n . Assume that f_l, f are dominated holomorphic self-maps of X , and assume that the induced actions

$$f_l^*, f^* : H^{1,1}(X, \mathbb{R}) \rightarrow H^{1,1}(X, \mathbb{R})$$

satisfy $\lim_{l \rightarrow \infty} f_l^* = f^*$, then $\lim_{l \rightarrow \infty} d_k(f_l) = d_k(f)$ holds for any k .

To our knowledge, the previous result is that : if the induced actions on $H^{k,k}(X, \mathbb{R})$ satisfies $\lim_{l \rightarrow \infty} f_l^* = f^*$, then $\lim_{l \rightarrow \infty} d_k(f_l) = d_k(f)$.

Now we can finish the proof of Theorem 2.4.2.1.

Proof of Theorem 2.4.2.1. It is sufficient to prove $\widehat{d}_k(g) = \prod_{i=1}^k |\rho_i(g)|$. Assume that $f \in \text{GL}(E)$ is diagonalizable over \mathbb{C} and has distinct eigenvalues. For any fixed $g \in \text{GL}(E)$, we consider the path

$$g_t := (1 - t)f + tg.$$

By linear algebra (see e.g. [Har95]), there is a sequence g_l such that each g_l has distinct eigenvalues (thus it is diagonalizable over \mathbb{C}), and $\lim_{l \rightarrow \infty} g_l = g$. (Note that this density statement is not true for diagonalizable matrices over \mathbb{R} .)

Since the eigenvalues depend continuously on the entries of a matrix, we get $\lim_{l \rightarrow \infty} |\rho_i(g_l)| = |\rho_i(g)|$. Applying $\widehat{d}_k(g_l) = \prod_{i=1}^k |\rho_i(g_l)|$ and Theorem 2.4.2.5 yields

$$\widehat{d}_k(g) = \lim_{l \rightarrow \infty} \widehat{d}_k(g_l) = \lim_{l \rightarrow \infty} \prod_{i=1}^k |\rho_i(g_l)| = \prod_{i=1}^k |\rho_i(g)|.$$

□

2.4.3 A generalization : multiple dynamical degrees

Actually we can show the existence of some kind of dynamical degrees of multiple linear actions. By the previous discussions for dynamical degrees, for simplicity, we only consider valuations of the type $V(-; B[i])$.

Definition 2.4.3.1. Let $g_1, g_2, \dots, g_k \in \text{GL}(E)$, and let $B \in \mathcal{K}(E)$ be a convex body with non-empty interior. Then we define the degree $\text{deg}(g_1, \dots, g_k)$ as

$$\text{deg}(g_1, \dots, g_k) = (g_1 \cdot \psi_B) \tilde{*} \dots \tilde{*} (g_k \cdot \psi_B) \tilde{*} \phi_B,$$

where $\psi_B = V(-; B)$ and $\phi_B = V(-; B[n - k])$. In particular, if $g_1 = \dots = g_k = g$, then we get the k -th degree $\text{deg}_k(g)$ (up to some scaling).

Proposition 2.4.3.2. If we define the dynamical degree of g_1, \dots, g_k as

$$d(g_1, \dots, g_k) := \limsup_{p \rightarrow \infty} \text{deg}(g_1^p, \dots, g_k^p)^{1/p},$$

then $d(g_1, \dots, g_k)$ exists and does not depend on the choices of B . Moreover, $d(g_1, \dots, g_k)$ is bounded above by $\prod_{i=1}^k d_k(g_i)$.

Proof. This follows directly from Theorem 2.2.2.3. □

An application to Laurent system

We give an application to the solution set of a Laurent system. First recall the famous Bernstein-Khovanskii-Kushnirenko theorem (see e.g. [Ber75], [Kho78], [Kus76]). Let $V = \mathbb{R}^n$. We identify \mathbb{Z}^n with the Laurent monomials, i.e., to each integral point $\mathbf{a} = (a_1, \dots, a_n) \in \mathbb{Z}^n$ we associate the monomial $x^{\mathbf{a}} := x_1^{a_1} x_2^{a_2} \dots x_n^{a_n}$. A Laurent polynomial $P(x) = \sum c_{\mathbf{a}} x^{\mathbf{a}}$ is a finite linear combination of Laurent monomials with coefficients $c_{\mathbf{a}} \in \mathbb{C}$. The support of a Laurent polynomial $P(x) = \sum c_{\mathbf{a}} x^{\mathbf{a}}$ is defined as

$$\text{supp}(P) := \{\mathbf{a} \in \mathbb{Z}^n | c_{\mathbf{a}} \neq 0\}.$$

We denote the convex hull of a finite set $I \subset \mathbb{Z}^n$ by $\Delta_I \subset V$. For each finite set $I \subset \mathbb{Z}^n$, we associate the linear subspace of Laurent polynomials : $L_I = \{P | \text{supp}(P) \subset I\}$.

Theorem 2.4.3.3 (Bernstein-Khovanskii-Kushnirenko theorem). *Let I_1, \dots, I_n be finite sets of \mathbb{Z}^n . Let $N(I_1, \dots, I_n)$ be the number of solutions in $(\mathbb{C}^*)^n$ of a general system of Laurent polynomial equations $P_1 = P_2 = \dots = P_n = 0$ with $P_i \in L_{I_i}$, then*

$$N(I_1, \dots, I_n) = n!V(\Delta_{I_1}, \dots, \Delta_{I_n}).$$

The group $\mathrm{GL}(n, \mathbb{Z})$ has a natural action on \mathbb{Z}^n , which in turn induces an action on the Laurent polynomials :

$$P(x) = \sum c_{\mathbf{a}} x^{\mathbf{a}} \mapsto (g \cdot P)(x) := \sum c_{\mathbf{a}} x^{g(\mathbf{a})},$$

where $g \in \mathrm{GL}(n, \mathbb{Z})$. It is natural to ask the asymptotic behaviour of the number of solutions under this induced action. Note that we have $g(\Delta_I) = \Delta_{g(I)}$.

Proposition 2.4.3.4. *Let I_1, \dots, I_n be finite sets of \mathbb{Z}^n , and let $g_i \in \mathrm{GL}(n, \mathbb{Z})$ with $1 \leq i \leq k$. Let $N(p, g_1, \dots, g_k)$ be the number of solutions in $(\mathbb{C}^*)^n$ of a general system of Laurent polynomial equations $P_1 = P_2 = \dots = P_n = 0$ with $P_i \in L_{g_i^p(I_i)}$ for $i \leq k$ and $P_j \in L_{I_j}$ for $j \geq k+1$, then the limit*

$$\limsup_{p \rightarrow +\infty} \frac{1}{p} \log N(p, g_1, \dots, g_k)$$

exists. In particular, the function $N(\cdot, g_1, \dots, g_k)$ defined over positive integers has polynomial growth.

Proof. Fix a convex body $L \subset V$ with non-empty interior. Then there exists a constant $c > 0$ such that $\Delta_{I_i} \subset cL$ (up to some translation) for any i . This implies

$$\begin{aligned} N(p, g_1, \dots, g_k) &= n!V(\Delta_{g_1^p(I_1)}, \dots, \Delta_{g_k^p(I_k)}, \Delta_{I_{k+1}}, \dots, \Delta_{I_n}) \\ &= n!V(g_1^p(\Delta_{I_1}), \dots, g_k^p(\Delta_{I_k}), \Delta_{I_{k+1}}, \dots, \Delta_{I_n}) \\ &\leq n!c^n V(g_1^p(L), \dots, g_k^p(L), L[n-k]). \end{aligned}$$

Applying Proposition 2.4.3.2 gives the desired result. \square

Remark 2.4.3.5. In the complex geometry setting, for holomorphic self-maps of a compact Kähler manifold, the multiple dynamical degrees control how the multiple maps separate the orbits.

2.5 Positivity of invariant convex valuations

In this section, we focus on the space $\mathrm{Val}(E)$ and the positive cones defined in this space. Let $\phi_\mu \in \mathcal{V}'_{n-i}$, recall that the action of $g \in \mathrm{GL}(E)$ on ϕ_μ (see Example 2.1.3.1) is given by

$$g \cdot \phi_\mu = \frac{1}{|\det g|} \phi_{g \cdot \mu}.$$

2.5.1 Invariant classes in complex dynamics

To motivate the discussions, we first recall some facts from complex dynamics. Let X be a compact Kähler manifold of dimension n , and let $f \in \mathrm{Aut}(X)$ be a holomorphic automorphism of X . Positive invariant classes and invariant currents play an important role in the study of dynamics of f . We consider the following positive cone in $H^{k,k}(X, \mathbb{R})$:

$$\mathcal{P}_k = \{ \{\Theta\} \in H^{k,k}(X, \mathbb{R}) \mid \Theta \text{ is a smooth positive } (k, k) \text{ form} \}.$$

It is clear that \mathcal{P}_k is convex. We denote its closure in $H^{k,k}(X, \mathbb{R})$ by $\overline{\mathcal{P}}_k$. It is clear that $\overline{\mathcal{P}}_k$ is a closed convex cone with non-empty interior, satisfying $\overline{\mathcal{P}}_k - \overline{\mathcal{P}}_k = H^{k,k}(X, \mathbb{R})$. Since f^* preserves $\overline{\mathcal{P}}_k$, the Perron-Frobenius theorem implies that there exists an eigenclass $\Gamma_k \in \overline{\mathcal{P}}_k \setminus \{0\}$ such that

$$f^*\Gamma_k = d_k\Gamma_k,$$

where d_k is the spectral radius of f^* on $H^{k,k}(X, \mathbb{R})$. Moreover, d_k is equal to the k -th dynamical degree of f (see e.g. [DS05a]).

2.5.2 Invariant convex valuations

In this section, we prove a general Theorem (see Theorem 2.5.2.1) which will imply Theorem 8.

Let $g \in \mathrm{GL}(E)$, $\phi \in \mathrm{Val}_{n-i}(E)$, we say that ϕ is *invariant* (or $d_i(g)$ -*invariant*) if $g \cdot \phi = d_i(g)\phi$.

By Proposition 2.4.1.10, the sequence of dynamical degrees $d_i(g)$ is log-concave. In particular, we have

$$d_i(g)^2 \geq d_{i+s}(g)d_{i-s}(g)$$

whenever $i \pm s$ are well defined.

As in [FW12, Section 6, 7], suppose that $d_i(g)^2 > d_{i+1}(g)d_{i-1}(g)$, then the authors show how to obtain a $d_i(g)$ -invariant valuation by methods from dynamics. We focus on the positivity properties of such invariant valuations, but under a weaker condition. Note that by log-concavity,

$$d_{i+1}(g)d_{i-1}(g) \geq d_{i+s}(g)d_{i-s}(g).$$

Thus the condition $d_i(g)^2 > d_{i-s}(g)d_{i+s}(g)$ is in general much weaker than the condition $d_i(g)^2 > d_{i-1}(g)d_{i+1}(g)$.

We show that positive invariant valuations have very weak positivity, if this kind of strict log concavity assumption holds. In the following, let $\gamma \in \{\mathcal{C}, \mathcal{P}\}$.

Theorem 2.5.2.1. *Assume that $2i \leq n$, and $g \in \mathrm{GL}(E)$. Then the following properties are satisfied.*

1. *The subspace of $d_i(g)$ -invariant valuations in $\mathrm{Val}_{n-i}(E)$ is non trivial.*
2. *Assume that the strict log-concavity inequality is satisfied for $s \leq \min(i, n-i)$:*

$$d_i(g)^2 > d_{i-s}(g)d_{i+s}(g),$$

then for any two $d_i(g)$ -invariant convex valuations $\psi_1, \psi_2 \in \mathcal{V}_{n-i}^\gamma$ we have

$$\psi_1 \tilde{*} \psi_2 = 0.$$

3. *Assume that*

$$d_1^2(g) > d_2(g),$$

then there exists a unique (up to a multiplication by a positive constant) $d_1(g)$ -invariant convex valuation $\psi \in \overline{\mathcal{P}}_{n-1}^\gamma$ (the closure of \mathcal{P}_{n-1} in the topology given by $\|\cdot\|_\gamma$), and ψ lies in an extremal ray of $\overline{\mathcal{P}}_{n-1}^\gamma$.

Proof. Let us prove statement (1). Up to a conjugation by an element of $\mathrm{GL}(E)$, we are reduced to the problem of finding a ρ^{i-n} -invariant valuation in \mathcal{P}_{n-i} for $0 \leq i \leq n$, where ρ is the spectral radius of g in each of the following cases :

- (a) The matrix of g in the canonical basis has Jordan form and the only eigenvalue of g is $\rho \in \mathbb{R}$.

(b) One has that $n = 2$ and $g = \rho \text{Id} \circ h$ where h is in the orthogonal group and where $\rho \in]0, +\infty[$.

Suppose we are in the case (a). Fix $i \leq n$. Let (e_1, \dots, e_n) be the canonical basis of E , let B be the unit ball in E and denote by $E_i = \text{Vect}(e_1, \dots, e_i)$. Consider $B_i := B \cap E_i$ and consider the valuation given by :

$$\phi_i(L) := V(B_i[i], L[n-i]).$$

Let us compute $g \cdot \phi_i(L)$ for $L \in \mathcal{K}(E)$:

$$g \cdot \phi_i(L) = V(B_i[i], g^{-1}(L)[n-i]) = \frac{1}{|\det(g)|} V(g(B_i)[i], L[n-i]).$$

By the projection formula for mixed volumes (Lemma 2.4.1.14), since B_i is contained in a subspace of dimension i and since g leaves the subspace E_i invariant, we have :

$$g \cdot \phi_i(L) := \frac{1}{\rho^n} \binom{n}{i}^{-1} \text{vol}_{E_i}(g(B_i)) \text{vol}_{E_i^\perp}(p_i(L)),$$

where $p_i : E \rightarrow E_i^\perp$ is the orthogonal projection onto E_i^\perp . Since $|\det(g|_{E_i})| = \rho^i$, we have that :

$$g \cdot \phi_i = \rho^{i-n} \phi_i,$$

as required.

Suppose we are in the case (b). Then $g = \rho \text{Id} \circ h$ where h is an element of the orthogonal group. If $i = 0$ then the valuation vol is ρ^2 -invariant and if $i = 2$, then the trivial valuation constant equal to 1 is ρ^0 -invariant. Let us find a valuation in \mathcal{P}_1 which is ρ -invariant. There exists a ball K in E such that $h(K) = K$. Consider the valuation $\phi \in \mathcal{P}_1$ given by :

$$\phi(L) := V(K, L),$$

for any $L \in \mathcal{K}(E)$. We have that :

$$g \cdot \phi(L) = \frac{1}{\rho^2} V(g(K), L) = \frac{1}{\rho^2} V(\rho(K), L) = \frac{1}{\rho} V(K, L) = \rho^{-1} \phi(L),$$

as required.

Let us show how statement (1) follows from the previous arguments. Take $g \in \text{GL}(E)$. By construction, there exists a decomposition of E into :

$$E = \oplus E_k,$$

where each E_k is a g -invariant subspace such that $g|_{E_k}$ satisfies condition (a) or (b). Denote by $\lambda_k = \rho(g|_{E_k})$. On each subspace, there exists a convex body $B_k \subset E_k$ such that the valuation given by $V(B_k[j], -[\dim E_k - j])$ is $\lambda_k^{j - \dim E_k}$ -invariant. Considering a well-chosen valuation of the form

$$\phi(L) = V(B_1[i_1], \dots, B_k[i_k], L[n-i]),$$

where $i_1 + \dots + i_k = i$, gives the required invariant valuation.

Let us prove statement (2). First note that it is sufficient to prove

$$\psi_1 \tilde{*} \psi_2 \tilde{*} \phi_B = 0,$$

where $\phi_B(-) = V(-; B[n-2i])$ and $B \in \mathcal{K}(E)$ is a convex body with non-empty interior and smooth boundary.

Note also that if $\psi \in \text{Val}_{n-i}(E)$ is $d_i(g)$ -invariant, then for any $c \neq 0$ and $K \in \mathcal{K}(E)$ we have :

$$\begin{aligned} ((cg) \cdot \psi)(K) &= \psi((cg)^{-1}(K)) = c^{i-n} \psi(g^{-1}(K)) \\ &= c^{i-n} (g \cdot \psi)(K) = c^{i-n} d_i(g) \psi(K) \\ &= d_i(cg) \psi(K), \end{aligned}$$

thus $(cg) \cdot \psi = d_i(cg) \psi$. In particular, ψ is g -invariant if and only if it is cg -invariant. Without loss of generality, to simplify the notations, we can assume that $|\det g| = 1$.

We first consider the case for \mathcal{V}_{n-i}^c .

For $j \in \{1, 2\}$, since $\psi_j \in \mathcal{V}_{n-i}^c$, we can take a sequence $\psi_{j,l} = \psi_{j,l}^+ - \psi_{j,l}^-$ such that $\lim_{l \rightarrow \infty} \psi_{j,l} = \psi_j$ and

$$\psi_{j,l}^+(B) + \psi_{j,l}^-(B) \leq c \quad (2.21)$$

for some uniform constant $c > 0$, where $\psi_{j,l}^+, \psi_{j,l}^- \in \mathcal{P}_{n-i}$.

Since $\psi_1, \psi_2 \in \mathcal{V}_{n-i}^c$ are invariant valuations, we have

$$\begin{aligned} g^k \cdot (\psi_1 \tilde{*} \psi_2) \tilde{*} \phi_B &= (g^k \cdot \psi_1) \tilde{*} (g^k \cdot \psi_2) \tilde{*} \phi_B \\ &= d_i(g)^{2k} \psi_1 \tilde{*} \psi_2 \tilde{*} \phi_B. \end{aligned}$$

The expansion of $(\psi_{1,l} \tilde{*} \psi_{2,l}) \tilde{*} \phi_B$ gives :

$$\begin{aligned} \psi_{1,l} \tilde{*} \psi_{2,l} \tilde{*} \phi_B &= \lim_{l \rightarrow \infty} (\psi_{1,l} \tilde{*} \psi_{2,l}) \tilde{*} \phi_B \\ &= \lim_{l \rightarrow \infty} (\psi_{1,l}^+ \tilde{*} \psi_{2,l}^+ + \psi_{1,l}^- \tilde{*} \psi_{2,l}^- - \psi_{1,l}^+ \tilde{*} \psi_{2,l}^- - \psi_{1,l}^- \tilde{*} \psi_{2,l}^+) \tilde{*} \phi_B. \end{aligned}$$

Since $\psi_{j,l}^+, \psi_{j,l}^- \in \mathcal{P}_{n-i}$, we get :

$$d_i(g)^{2k} (\psi_1 \tilde{*} \psi_2 \tilde{*} \phi_B) \leq \liminf_{l \rightarrow \infty} g^k \cdot (\psi_{1,l}^+ \tilde{*} \psi_{2,l}^+ + \psi_{1,l}^- \tilde{*} \psi_{2,l}^-) \tilde{*} \phi_B. \quad (2.22)$$

Applying Theorem 2.2.2.1 to $\phi := g^k \cdot (\psi_{1,l}^+ \tilde{*} \psi_{2,l}^+)$ (respectively $g^k \cdot (\psi_{1,l}^- \tilde{*} \psi_{2,l}^-)$), $\psi := \phi_B \in \text{Val}_{2i}(E)$ and the convex body $K := g^k(B)$, we obtain

$$\text{vol}(g^k(B)) (g^k \cdot (\psi_{1,l}^\epsilon \tilde{*} \psi_{2,l}^\epsilon) \tilde{*} \phi_B) \leq g^k \cdot (\psi_{1,l}^\epsilon \tilde{*} \psi_{2,l}^\epsilon) (g^k(B)) \phi_B (g^k(B)), \quad (2.23)$$

where $\epsilon \in \{+, -\}$. On the other hand, by Theorem 2.2.2.3, we have

$$\begin{aligned} \phi_B(g^k(B)) &= V(g^k(B)[2i], B[n-2i]) \\ &= V(g^k(B)[i+s], g^k(B)[i-s], B[n-2i]) \\ &\leq C_1 V(g^k(B)[i+s], B[n-i-s]) V(g^k(B)[i-s], B[n-i+s]), \end{aligned}$$

where $C_1 > 0$ is a constant which depends only on B , i and n .

By (2.21) and Theorem 2.2.2.1, we also have

$$\liminf_{l \rightarrow \infty} ((\psi_{1,l}^+ \tilde{*} \psi_{2,l}^+ + \psi_{1,l}^- \tilde{*} \psi_{2,l}^-) \tilde{*} \phi_B) \leq C_3 \quad (2.24)$$

for some constant $C_3 > 0$. Note that there exists a constant $C_2 > 0$ such that

$$g^k \cdot (\psi_{1,l}^\epsilon \tilde{*} \psi_{2,l}^\epsilon) (g^k(B)) = C_2 (\psi_{1,l}^\epsilon \tilde{*} \psi_{2,l}^\epsilon) \tilde{*} \phi_B. \quad (2.25)$$

By (2.22), (2.23), (2.24), (2.25) and the estimate for $\phi_B(g^k(B))$, we deduce that there exists a uniform constant $C_4 > 0$ such that

$$d_i(g)^{2k} (\psi_1 \tilde{*} \psi_2 \tilde{*} \phi_B) \leq C_4 V(g^k(B)[i+s], B[n-i-s]) V(g^k(B)[i-s], B[n-i+s]). \quad (2.26)$$

Next we consider the case for $\mathcal{V}_{n-i}^{\mathcal{P}}$.

We take approximations $\psi_{j,l}$ such that $\lim_{l \rightarrow \infty} \psi_{j,l} = \psi_j$ and

$$|\psi_{j,l}(L_1, \dots, L_{n-i})| \leq cV(\mathbf{B}[n-i]; L_1, \dots, L_{n-i})$$

for some uniform constant $c > 0$, and any L_1, \dots, L_{n-i} . As we are reduced to the situation $|\det g| = 1$, this implies

$$|g^k \cdot \psi_{j,l}(L_1, \dots, L_{n-i})| \leq cV(g^k(\mathbf{B})[n-i]; L_1, \dots, L_{n-i}). \quad (2.27)$$

By the definition of $\tilde{*}$ and (2.27), we get

$$g^k \cdot (\psi_{1,l} \tilde{*} \psi_{2,l}) \tilde{*} \phi_B \leq c^2 V(g^k(\mathbf{B})[2i], B[n-2i]).$$

Then the same arguments as above shows that

$$d_i(g)^{2k} (\psi_1 \tilde{*} \psi_2 \tilde{*} \phi_B) \leq C_5 V(g^k(\mathbf{B})[i+s], B[n-i-s]) V(g^k(\mathbf{B})[i-s], B[n-i+s]). \quad (2.28)$$

In summary, if $\psi_1 \tilde{*} \psi_2 \tilde{*} \phi_B > 0$, after taking k -th root of the above inequality (2.26) or (2.28) and letting k tend to infinity, we get

$$d_i(g)^2 \leq d_{i+s}(g) d_{i-s}(g).$$

This contradicts with our assumption. Thus,

$$\psi_1 \tilde{*} \psi_2 \tilde{*} \phi_B \leq 0.$$

Since the valuations $-\psi_1$ is also invariant, the previous argument holds and we also have :

$$(-\psi_1) \tilde{*} \psi_2 \tilde{*} \phi_B \leq 0.$$

Hence, we must have $\psi_1 \tilde{*} \psi_2 \tilde{*} \phi_B = 0$.

Finally we prove the statement (3). Suppose $i = n - 1$ (thus the assumption is $d_1(g)^2 > d_2(g)$).

We claim that

$$\overline{\mathcal{P}_{n-1}}^{\mathcal{P}} = \overline{\mathcal{P}_{n-1}}^{\mathcal{C}} = \mathcal{P}_{n-1}$$

and that any valuation $\phi \in \overline{\mathcal{P}_{n-1}}^{\mathcal{P}}$ is of the form $V(L; -[n-1])$ for some $L \in \mathcal{K}(E)$.

Take $\phi \in \overline{\mathcal{P}_{n-1}}^{\mathcal{P}}$. By Corollary 2.2.3.9, there exists a sequence of valuations $\phi_j = V(L_j, -[n-1])$ such that $\|\phi_j - \phi\|_{\mathcal{P}} \rightarrow 0$. Then we have that $V(L_j, \mathbf{B}[n-1])$ is uniformly bounded above. By Diskant's inequality (similar to the estimate (2.9)), the convex bodies L_j (up to some translations) are bounded. We can thus extract a subsequence of L_j (up to some translations) converging to a convex body L . In particular, $\phi = V(L, -[n-1])$ as required.

Next let $\psi \in \overline{\mathcal{P}_{n-1}}^{\mathcal{C}}$, we prove that ψ is also of the form $\psi(-) = V(L; -[n-1])$. As $\mathcal{P}_{n-1} \subset \overline{\mathcal{P}_{n-1}}^{\mathcal{P}}$, any valuation in \mathcal{P}_{n-1} is of the form $V(L; -)$. Hence there exists a sequence of convex bodies $L_k \in \mathcal{K}(E)$ such that

$$\|V(L_k; -[n-1]) - \psi\|_{\mathcal{C}} \rightarrow 0.$$

This implies that $V(L_k; \mathbf{B}[n-1])$ is uniformly bounded above. Then the same argument as in the previous step shows that $\psi = V(L; -[n-1])$ for some $L \in \mathcal{K}(E)$, as required.

This finishes the proof of the claim.

Now we have $\psi_1(-) = V(-[n-1]; K)$ and $\psi_2(-) = V(-[n-1]; L)$ for some $K, L \in \mathcal{K}(E)$. Then $\psi_i \tilde{*} \psi_j \tilde{*} \phi_B = 0$ for $i, j \in \{1, 2\}$ implies

$$V(K, L, B[n-2]) = V(K[2], B[n-2]) = V(L[2], B[n-2]) = 0.$$

In particular,

$$V(K, L, B[n-2]) = V(K[2], B[n-2])V(L[2], B[n-2]).$$

Now the uniqueness result follows from [Sch14, Theorem 7.6.8], which we present below as a lemma.

Lemma 2.5.2.2. *If the equality holds in*

$$V(K, L, C_1, \dots, C_{n-2}) \geq V(K[2], C_1, \dots, C_{n-2})V(L[2], C_1, \dots, C_{n-2}),$$

where C_1, \dots, C_{n-2} are smooth convex bodies with non-empty interior, then K, L are homothetic.

As in our setting, B is smooth, this immediately proves the uniqueness of invariant valuations.

The proof for the extremal ray property also follows from the above lemma. Assume that $\psi \in \overline{\mathcal{P}_{n-1}}^\gamma$ is invariant and can be written as

$$\psi = \phi_1 + \phi_2,$$

where $\phi_1 = V(-; K_1), \phi_2 = V(-; K_2)$. We need to verify that ϕ_1, ϕ_2 are proportional. The vanishing of $\psi \tilde{*} \psi \tilde{*} \phi_B$ is equivalent to

$$V(K_1, K_2, B[n-2]) = V(K_1[2], B[n-2]) = V(K_2[2], B[n-2]) = 0,$$

which yields that K_1, K_2 are homothetic. Thus ψ must lie in an extremal ray of the cone $\overline{\mathcal{P}_{n-1}}^\gamma \subset \mathcal{V}_{n-1}^\gamma$. \square

Weak closedness

The above argument for Theorem 2.5.2.1 (3) shows that the cone \mathcal{P}_{n-1} is closed with respect to the topology given by $\|\cdot\|_{\mathcal{P}}$. Actually, this cone is also weakly closed in the following sense. Observe that for any convex body $K \in \mathcal{K}(E)$, the evaluation map induces a continuous linear form on $\mathcal{V}_k^{\mathcal{P}}$:

$$\text{ev}_K : \mathcal{V}_k^{\mathcal{P}} \rightarrow \mathbb{R}, \phi \mapsto \phi(K).$$

The continuity of ev_K follows from

$$|\phi(K)| \leq \|\phi\|_{\mathcal{P}} V(\mathbf{B}[n-k], K[k]).$$

Consider the weak topology, which is the coarsest topology on $\mathcal{V}_k^{\mathcal{P}}$ such that the evaluation maps ev_K are continuous. We first note that the weak topology contains a countable basis of neighborhoods. Consider the finite intersection of neighborhoods of the form:

$$U = \left\{ \phi \in \mathcal{V}_k^{\mathcal{P}} \mid \left| \phi(P) - \sum_{i=1}^N a_i V(P_{1,i}, \dots, P_{n-k,i}, P[k]) \right| < b \right\},$$

where $a_i, b \in \mathbb{Q}$, $N \in \mathbb{N}$ and where P and $P_{j,i}$ are rational polytopes in E . By construction U is an open set of $\mathcal{V}_k^{\mathcal{P}}$ for the weak topology. The fact that such subset U defines a basis of neighborhoods results from the density of rational polytopes inside $\mathcal{K}(E)$.

Proposition 2.5.2.3. *The cone $\mathcal{P}_{n-1} \subset \mathcal{V}_{n-1}^{\mathcal{P}}$ is closed with respect to the weak topology. In particular, one has the following equality :*

$$\overline{\mathcal{P}_{n-1}}^{\mathcal{P}} = \mathcal{P}_{n-1} = \overline{\mathcal{P}_{n-1}}^w,$$

where $\overline{\mathcal{P}_{n-1}}^w$ is the closure of the cone \mathcal{P}_{n-1} with respect to the weak topology and where $\overline{\mathcal{P}_{n-1}}^{\mathcal{P}}$ is the closure of the cone \mathcal{P}_{n-1} with respect to the norm $\|\cdot\|_{\mathcal{P}}$.

Proof. Since the space $\mathcal{V}_{n-1}^{\mathcal{P}}$ endowed with the weak topology is first countable, every point $\phi \in \mathcal{V}_{n-1}^{\mathcal{P}}$ in the weak closure of the cone \mathcal{P}_{n-1} is the weak limit of a sequence $\phi_j \in \mathcal{P}_{n-1}$. Recall that every valuation in \mathcal{P}_{n-1} is of the form $V(M; -[n-1])$ for some convex body $M \in \mathcal{K}(E)$ and one can write each ϕ_j as $\phi_j = V(L_j; -[n-1])$ where $L_j \in \mathcal{K}(E)$. Since ϕ_j converges weakly to ϕ , this implies that :

$$\phi_j(\mathbf{B}) = V(L_j, \mathbf{B}[n-1]) \rightarrow \phi(\mathbf{B}),$$

as j tend to $+\infty$. In particular, the sequence $\{V(L_j, \mathbf{B}[n-1])\}_j$ is bounded. By Diskant's inequality, there exists a subsequence of the sequence $\{L_j\}_{j \in \mathbb{N}}$ (up to translations), which converges to a convex body L . Hence, we have that $\phi = V(L; -[n-1])$ for some $L \in \mathcal{K}(E)$ and $\phi \in \mathcal{P}_{n-1}$ as required. \square

Remark 2.5.2.4. We are not sure about the weak closedness of \mathcal{P}_k when $k \neq n-1$.

Remark 2.5.2.5. In general the invariant valuations are not smooth. The invariant valuations in [FW12] are given by the volume of a projection onto a linear subspace. By the reduction formula for mixed volumes, they are given by mixed volumes, which are elements in \mathcal{P}_i .

Remark 2.5.2.6. For any $g \in \mathrm{GL}(E)$, the action of g satisfies $g(\mathcal{P}_i) \subset \mathcal{P}_i$. Recall that in functional analysis we have the famous Krein-Rutman theorem :

Let X be a Banach space, and let $\mathcal{C} \subset X$ be a closed convex cone such that $\mathcal{C} - \mathcal{C}$ is dense in X . Let $T : X \rightarrow X$ be a non-zero compact operator satisfying $T(\mathcal{C}) \subset \mathcal{C}$, and assume that its spectral radius $\rho(T)$ is strictly positive. Then there is an eigenvector $u \in \mathcal{C} \setminus \{0\}$ such that $T(u) = \rho(T)u$.

If X is of finite dimension, then this is the Perron-Frobenius theorem, which is very useful to construct invariant classes in complex dynamics. In our setting, in general the induced linear operator by g is not compact. However, if we consider the finite dimensional space $\mathrm{Val}^G(E)$ where $G \subset \mathrm{SO}(E)$ is a compact subgroup acting transitively on the unit sphere of E , and consider appropriate cones in this space, then we can apply the result directly.

Remark 2.5.2.7. We remark that the same vanishing result also holds true for the dynamics of dominated holomorphic maps. Furthermore, by Hodge theory (see e.g. [Voi07]), the extremal ray property holds true for invariant $(1, 1)$ classes. More precisely, using the notations in Section 2.5.1, we have :

Let X be a compact Kähler manifold of dimension n . Let $f : X \rightarrow X$ be a dominated holomorphic self-map. Assume $2k \leq n$. If $d_k^2 > d_{k+s}d_{k-s}$, then for any Kähler class ω and any invariant positive classes $\Theta_1, \Theta_2 \in \overline{\mathcal{P}}_k \subset H^{k,k}(X, \mathbb{R})$ we have

$$\Theta_1 \cdot \Theta_2 \cdot \omega^{n-2k} = 0.$$

Moreover, if $d_1^2 > d_2$, then the non-zero invariant class $\Theta \in \overline{\mathcal{P}}_1$ is unique (up to some scaling) and lies in an extremal ray of $\overline{\mathcal{P}}_1$.

The proof of $\Theta_1 \cdot \Theta_2 \cdot \omega^{n-2k} = 0$ is the same as in Theorem 2.5.2.1, where we apply the reverse Khovanskii-Teissier inequality in complex geometry [LX17]. For the uniqueness and extremity of $\Theta \in \overline{\mathcal{P}}_1$, we decompose $\Theta_i, i = 1, 2$ as follows :

$$\Theta_i = a_i \omega + P_i,$$

where $a_i \in \mathbb{R}$, and P_i is a primitive class, i.e., $\omega^{n-1} \cdot P_i = 0$. Since $\Theta_i \cdot \Theta_j \cdot \omega^{n-2} = 0$ for $i, j \in \{1, 2\}$, both P_1 and P_2 can not be zero. Moreover, combining with $\omega^{n-1} \cdot P_i = 0$ implies

$$\begin{aligned} P_1^2 \cdot \omega^{n-2} &= -a_1^2 \omega^n, \\ P_2^2 \cdot \omega^{n-2} &= -a_2^2 \omega^n, \\ P_1 \cdot P_2 \cdot \omega^{n-2} &= -a_1 a_2 \omega^n. \end{aligned}$$

Thus the matrix $[P_i \cdot P_j \cdot \omega^{n-2}]_{i,j}$ is degenerate. By Hodge-Riemann bilinear relations, we have $P_1 = cP_2$ for some non-zero constant c . Then we get $a_1^2 = c^2 a_2^2$. We claim $a_1 = ca_2$, which then implies $\Theta_1 = c\Theta_2$. If some $a_i = 0$, then this is clear; otherwise, if $a_1 = -ca_2$, by considering $\Theta_1 - c\Theta_2$ we get that ω is also an invariant class, which is impossible by the vanishing result. Thus we finish the proof of the uniqueness result. The extremity property follows from the same argument.

Chapitre 3

Degree growth of tame automorphisms preserving an affine quadric threefold

3.1 Introduction

We work over an algebraically closed field k of characteristic zero.

In Chapter 1, we have seen that the degree growth of a rational map is partially encoded by its dynamical degrees. In dimension two, these asymptotic growth rates are known for birational maps ([Giz80],[DF01]), for polynomial maps of the affine plane ([FJ11]), for monomial maps ([Lin12], [FW12]). From the dimension three on, very few examples have been computed and finding large classes of rational maps for which the dynamical degrees can be determined explicitly remains a difficult task. The main reason is that we usually rely on the construction of a good birational model (e.g. an algebraically stable model in the sense of Fornæss and Sibony [FS95]) to find the degree sequences, but the structure of the set of birational models of threefolds is far more complicated than its analog for surfaces.

A first natural choice would be the group of polynomial automorphisms of the three dimensional affine space. Even though there has been some recent progress on the structure of this group ([Wri15], [Lam15], [LP18a]), it still remains quite mysterious. We have thus turned our attention to a simpler situation, namely the subgroup of tame automorphisms of the affine quadric threefold.

We denote by (x, y, z, t) the affine coordinates in \mathbb{A}^4 and consider the affine quadric \mathcal{Q} given by :

$$\mathcal{Q} = V(xt - yz - 1).$$

Observe that the Picard group of the closure $\overline{\mathcal{Q}}$ of \mathcal{Q} in \mathbb{P}^4 is generated by $H = c_1(\mathcal{O}(1)|_{\overline{\mathcal{Q}}})$ so that one can define the algebraic degree of an automorphism by :

$$\deg(f) := \deg_1(f) = (\pi_1^* H^2 \cdot \pi_2^* H),$$

where π_1 and π_2 are the projections of the graph of the birational map induced by f in $\overline{\mathcal{Q}} \times \overline{\mathcal{Q}}$ onto the first and the second factor respectively. Observe that by definition $\deg_2(f) = (\pi_1^* H \cdot \pi_2^* H^2) = \deg(f^{-1})$ since f is an automorphism. The subgroup $\text{Tame}(\mathcal{Q})$ of tame automorphisms is defined as the subgroup generated by affine automorphism and transformations induced by :

$$(x, y, z, t) \mapsto (x, y, z + xP(x, y), t + yP(x, y)),$$

with $P \in k[x, y]$.

Theorem 9. *Let f be a tame automorphism, then one of the following possibilities occur :*

(i) The sequence $(\deg(f^n), \deg(f^{-n}))$ is bounded and f is conjugated to linear map; or f^2 is conjugated to an automorphism of the form

$$(x, y, z, t) \mapsto (ax, by + xR(x), b^{-1}z + xP(x, y), a^{-1}(t + yP(x, y) + zR(x) + xR(x)P(x, y)))$$

with $a, b \in k^*$, $P \in k[x, y]$ and $R \in k[x]$.

(ii) There exists a constant $C > 0$ such that :

$$\frac{1}{C}n \leq \deg(f^{\epsilon n}) \leq Cn,$$

for all $\epsilon \in \{+1, -1\}$ and f is conjugated to an automorphism of the form :

$$(x, y, z, t) \mapsto (ax, b^{-1}(z + xR(x)), b(y + xP(x)z), a^{-1}(t + z^2P(x) + yR(x) + xzP(x)R(x))),$$

with $a, b \in k^*$, $R \in k[x]$ and $P \in k[x] \setminus k$.

(iii) The sequences $\deg(f^n)$ and $\deg(f^{-n})$ grow at least exponentially and there exists a constant $C(f) > 0$ such that :

$$\min(\deg(f^{-n}), \deg(f^n)) \geq C(f) \left(\frac{4}{3}\right)^n.$$

Theorem 9 is a first step towards an understanding of the dynamical degrees of tame automorphisms.

Corollary 1. *The following inclusion is satisfied :*

$$\{\lambda_1(f) \mid f \in \text{Tame}(\mathbb{Q})\} \subset \{1\} \cup [4/3, +\infty[.$$

This result is reminiscent of a theorem of Blanc and Cantat [BC16, Corollary 2.7] stating that the set of first dynamical degrees of any birational surface maps is included in $\{1\} \cup [\lambda_L, \infty)$ where $\lambda_L \simeq 1.176280$ denotes the Lehmer number

Another immediate consequence of Theorem 9 is the following corollary.

Corollary 2. *Any tame automorphism $f \in \text{Tame}(\mathbb{Q})$ satisfying $\lambda_1(f) = 1$ preserves a fibration or belongs to O_4 and both sequences $\deg(f^n), \deg(f^{-n})$ are either bounded or linear.*

This corollary gives a positive answer to a question by Urech [Ure16, Question 4] in a special situation.

Our strategy of proof of Theorem 9 exploits extensively the structure of the group of tame automorphisms. We use the natural action of $\text{Tame}(\mathbb{Q})$ on a square complex \mathcal{C} which was introduced and studied by Bisi-Furter-Lamy in [BFL14]. This action is faithful, transitive on squares, and isometric. The complex \mathcal{C} plays the same role for $\text{Tame}(\mathbb{Q})$ as the Bass-Serre tree for $\text{Aut}[k^2]$.

One of the main result of [BFL14] is that \mathcal{C} is a geodesic space which is both CAT(0) and Gromov-hyperbolic. As a result, a tame automorphism induces an action on the complex which is rather constrained : either it is elliptic and fixes a vertex in the complex \mathcal{C} ; or it is hyperbolic and acts by translation on an invariant geodesic line.

Using an explicit description of the stabilizer subgroups of each vertices, we compute the degree sequences of elliptic tame automorphisms.

The crucial point of the proof is the study in Section 3.6 of the degree growth of hyperbolic automorphisms. When the invariant geodesic line remains in a band (i.e a subset of \mathcal{C} isometric to $[0, 2] \times \mathbb{R}^2$), the degree of the iterates is multiplicative and the dynamical degree is an integer.

When the invariant geodesic leaves a band, the multiplicativity of the degrees of the iterates fails in general. The core of the proof is to show that in this case the sequence of degrees is bounded from below by $C(4/3)^n$ for some positive constant $C > 0$. Let us explain how this is done.

To simplify the discussion denote by v_0 the unique vertex of \mathcal{C} which is fixed by all linear transformations preserving the quadric and by $d_{\mathcal{C}}$ the distance in the complex \mathcal{C} . Let $f \in \text{Tame}(\mathbb{Q})$ be any hyperbolic automorphism. First we show that by conjugating with an appropriate automorphism, we can suppose that v_0 lies at distance ≤ 2 of an f -invariant geodesic line. Suppose that v_0 is contained in an invariant geodesic of f . Our goal is to prove that

$$\deg(f^n) \geq (4/3)^{d_{\mathcal{C}}(v_0, f^n \cdot v_0)} \text{ for all } n \in \mathbb{N}. \quad (3.1)$$

The sequence of 2×2 squares cut by the geodesic segment $[v_0, f^n \cdot v_0]$ allows us to write

$$f^n = g_p \circ g_{p-1} \cdots \circ g_1 \quad (3.2)$$

as a composition of elementary automorphisms and affine transformations preserving the quadric. This decomposition is not unique in general and ideally, one would hope to prove that the degree is multiplicative so that $\deg(f^n) \geq \prod_{i=1}^p \deg(g_i)$. The obstruction to this property is the presence of resonances, which are explained as follows. Two regular functions $P, R \in \mathbb{k}[Q]$ are *resonant* if there exists $\lambda \in \mathbb{k}^*$ and two integers p, q such that $\deg(P^p - \lambda R^q) < p \deg(P) = q \deg(R)$ and they are called *critical* if $p = 1$ or $q = 1$.

In the case these resonances are not *critical*, then we show that one can apply the so-called parachute inequalities (recalled in Section 3.4.6) to deduce (3.1). These inequalities are elementary valuative estimates on the values of partial derivatives of suitable polynomials, and are derived from the proof of Nagata's conjecture by Shestakov-Umirbaev (see [SU03], [Kur16], [LV13]).

To get around the appearance of critical resonances, we prove that f^n always admits an appropriate factorization for which the parachute inequalities can be applied inductively. In other words, we write $f^n = g'_p \circ \dots \circ g'_1$ where g'_i are tame automorphisms such that for each $i \leq p$, g'_{i+1} and $(g'_i \circ \dots \circ g'_1)$ do not have critical resonances.

Denote by S_0, \dots, S_p the 2×2 squares cut by the geodesic segment $[v_0, f^n \cdot v_0]$. We fix a valuation ν of monomial type (see §3.4.2 for a precise definition) such that one of the vertex of S_0 has ν -value strictly less than the three others. This dissymmetry induced by ν on these vertices appears to be crucial when we apply our key Proposition (see 3.6.1.2) to find an alternative sequence of squares. Arguing by induction, we then show that we can modify the sequence of squares to obtain a family $\mathcal{S} := \{S_0, S'_1, \dots, S'_p\}$ such that every consecutive edge has no critical resonances. To construct \mathcal{S} we exploit in a deep way the geometry of the link of the vertices of the complex. The induction argument is detailed in §3.6.1 to §3.6.6. The proof of Theorem 9 and 10 are given in §3.6.7 and §3.6.8 respectively.

Our methods also yield the next result of independent interest.

Theorem 10. *Consider the vertex v_0 in the complex which is fixed by all affine transformations preserving the quadric, then for any tame automorphisms $f \in \text{Tame}(\mathbb{Q})$ for which f is not affine, the following inequality holds :*

$$\log(\deg(f)) \geq \frac{\log(4/3)}{2\sqrt{2}} d_{\mathcal{C}}(f \cdot v_0, v_0) - 2 \log(4/3),$$

where $d_{\mathcal{C}}$ denotes the distance in the complex.

This phenomenon already appears in the case of plane automorphisms since one can bound from below the logarithm of the degree of a plane automorphism by $\log(2)$ multiplied by the distance between two vertices in the Bass-Serre tree associated to the group $\text{Aut}(\mathbb{A}^2)$. Also in the case of $\text{Bir}(\mathbb{P}^2)$, there is a relationship between the degree and the distance on a suitable hyperbolic space.

3.2 General facts on the tame group of the quadric

We work over an algebraically closed field k of characteristic zero. We fix some affine coordinates $(x, y, z, t) \in \mathbb{A}^4$ and consider the smooth affine quadric threefold \mathcal{Q} given by :

$$\mathcal{Q} := V(xt - yz - 1) \subset \mathbb{A}^4.$$

We also fix an open embedding $\mathbb{A}^4 \subset \mathbb{P}^4$ so that $\mathbb{A}^4 = V(w)$ in the homogeneous coordinates $[x, y, z, t, w] \in \mathbb{P}^4$.

In this section, we briefly describe the geometry of the affine quadric and give some preliminary properties of its elementary and orthogonal group of automorphism.

3.2.1 The geometry of a quadric threefold and its compactification in \mathbb{P}^4

The affine variety $\mathcal{Q} \subset \mathbb{A}^4$ is a smooth quadric threefold. The Zariski closure $\overline{\mathcal{Q}}$ of the affine quadric is also smooth in \mathbb{P}^4 and has Picard rank one by Lefschetz hyperplane theorem. A birational map from $\overline{\mathcal{Q}}$ to \mathbb{P}^3 is given by choosing a point $p_0 \in \overline{\mathcal{Q}}$ and sending a point $p \in \overline{\mathcal{Q}}$ to the intersection of the line (pp_0) with a hyperplane in \mathbb{P}^4 which does not contain p_0 .

We denote by $H_\infty := \overline{\mathcal{Q}} \setminus \mathcal{Q}$ the hyperplane section at infinity. It is a smooth quadric surface given in homogeneous coordinates by :

$$H_\infty := V(xt - yz) \subset \mathbb{P}^4.$$

We identify H_∞ with $\mathbb{P}^1 \times \mathbb{P}^1$ by the isomorphism induced by the composition of the Segre embedding $\mathbb{P}^1 \times \mathbb{P}^1 \hookrightarrow \mathbb{P}^3$ with the inclusion $\mathbb{P}^3 = V(w) \hookrightarrow \mathbb{P}^4$. In homogeneous coordinates, it is given by :

$$([\xi_0, \xi_1], [\eta_0, \eta_1]) \mapsto [\xi_0\eta_0, \xi_0\eta_1, \xi_1\eta_0, \xi_1\eta_1, 0]. \tag{3.3}$$

Any line in H_∞ of the form $\{\lambda\} \times \mathbb{P}^1$ (resp. $\mathbb{P}^1 \times \{\lambda\}$) where $\lambda \in \mathbb{P}^1$ is said to be vertical (resp. horizontal).

$$([0, 1], [1, 0]) = [0, 0, 1, 0, 0]$$

$$([1, 0], [1, 0]) = [1, 0, 0, 0, 0]$$

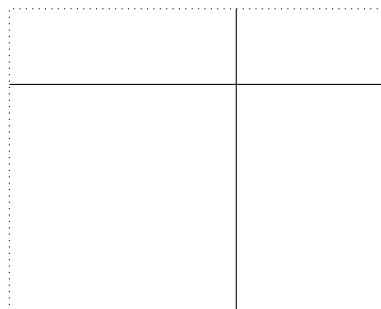

horizontal line $\mathbb{P}^1 \times \{\lambda\}$

$$([0, 1], [0, 1]) = [0, 0, 0, 1, 0] \in \overline{\mathcal{Q}}$$

$$\text{vertical line } \{\lambda\} \times \mathbb{P}^1 \quad ([1, 0], [0, 1]) = [0, 1, 0, 0, 0]$$

The two projection maps $\pi_x : \mathcal{Q} \rightarrow \mathbb{A}^1$ and $\pi_y : \mathcal{Q} \rightarrow \mathbb{A}^1$ given by :

$$\begin{aligned}\pi_x : (x, y, z, t) \in \mathcal{Q} &\mapsto x, \\ \pi_y : (x, y, z, t) \in \mathcal{Q} &\mapsto y,\end{aligned}$$

induce algebraic fibrations which are trivial over $\mathbb{A}^1 \setminus \{0\}$ such that $\pi_x^{-1}(\mathbb{A}^1 \setminus \{0\})$ and $\pi_y^{-1}(\mathbb{A}^1 \setminus \{0\})$ are isomorphic to $\mathbb{A}^1 \setminus \{0\} \times \mathbb{A}^2$. Observe that the fibers over 0 are both isomorphic to $\mathbb{A}^1 \times \mathbb{A}^1 \setminus \{0\}$ so that the fibrations are not locally trivial over a neighborhood of the origin. Observe that the intersection with H_∞ of the closure of the fiber over 0 in $\overline{\mathcal{Q}}$ is the union of a vertical line and a horizontal line. The projection on the two components :

$$\pi_{x,y} : (x, y, z, t) \rightarrow (x, y)$$

induces a surjective morphism $\pi_{x,y} : \mathcal{Q} \rightarrow \mathbb{A}^2 \setminus (0, 0)$ which is also trivial over $\mathbb{A}^2 \setminus \{x = 0\}$.

The affine quadric \mathcal{Q} carries naturally a volume form Ω which is the Poincaré residue of the rational 4-form $dx \wedge dy \wedge dz \wedge dt/f$ along \mathcal{Q} . More explicitly, Ω is defined by :

$$\Omega = \frac{dx \wedge dy \wedge dz}{x} \Big|_{\mathcal{Q}} = \frac{dy \wedge dz \wedge dt}{t} \Big|_{\mathcal{Q}} = \frac{dx \wedge dz \wedge dt}{z} \Big|_{\mathcal{Q}}.$$

One checks that Ω extends as a rational 3-form $\overline{\Omega}$ on $\overline{\mathcal{Q}}$ such that its divisors of poles and zeros satisfies

$$\operatorname{div}(\overline{\Omega}) = -3[H_\infty].$$

3.2.2 The orthogonal group

A regular automorphism f of \mathcal{Q} is determined by a morphism f^\sharp of the k -algebra $k[\mathcal{Q}]$ and hence by its image on the four regular functions x, y, z, t . If we denote by $f_x, f_y, f_z, f_t \in k[\mathcal{Q}]$ the image of x, y, z, t by f^\sharp , it is convenient to adopt a matrix-like notation for f as follows :

$$f = \begin{pmatrix} f_x & f_y \\ f_z & f_t \end{pmatrix}.$$

Observe that $f_x f_t - f_z f_y = 1$ since f^\sharp is a morphism of the k -algebra $k[\mathcal{Q}]$ and that any such automorphism preserves the volume form Ω (up to a constant).

Denote by $q(x, y, z, t) = xt - yz$ the quadratic form defined on the vector space $V = k^4$. The group O_4 is the subgroup of linear automorphisms of k^4 which leave the quadratic form q invariant :

$$O_4 = \{f \in \operatorname{GL}_4(k) \mid q \circ f = q\}.$$

An element of O_4 naturally defines an automorphism of the quadric hypersurface \mathcal{Q} . As a consequence, we have that for any $f \in O_4$,

$$f^* \Omega = \epsilon(f) \Omega,$$

where $\epsilon : O_4 \rightarrow k^*$ is a morphism of groups. Since Ω is the Poincaré residue of the form $dx \wedge dy \wedge dz \wedge dt/(xt - yz - 1)$ to \mathcal{Q} , this implies that for any $f \in O_4$, $\epsilon(f)$ is equal to the determinant of the endomorphism of k^4 associated to f , hence $\epsilon(f) \in \{+1, -1\}$. The subgroup SO_4 is the kernel of ϵ and has index 2 in O_4 .

Observe that every element of O_4 extends as regular automorphism of $\overline{\mathcal{Q}}$ which leaves the hyperplane at infinity invariant. In particular, the restriction map onto H_∞ induces a morphism of groups from O_4 onto $\operatorname{Aut}(\mathbb{P}^1 \times \mathbb{P}^1)$.

The main properties of O_4 and SO_4 are summarized in the following proposition.

Proposition 3.2.2.1. *The following properties are satisfied :*

- (i) *The group SO_4 acts transitively on the set of horizontal and vertical lines at infinity respectively, and on the set of points at infinity.*
- (ii) *Any element of $f \in \mathrm{O}_4$ which does not belong to SO_4 exchanges the horizontal lines at infinity with the vertical lines at infinity.*
- (iii) *The following sequence is exact.*

$$1 \longrightarrow \{+1, -1\} \longrightarrow \mathrm{O}_4 \longrightarrow \mathrm{Aut}(\mathbb{P}^1 \times \mathbb{P}^1) \longrightarrow 1.$$

- (iv) *For any element $f \in \mathrm{O}_4$, we have :*

$$f^*\Omega = \epsilon(f)\Omega,$$

where $\epsilon(f) \in \{+1, -1\}$ and $\mathrm{Ker}(\epsilon) = \mathrm{SO}_4$.

Proof. Observe that (iii) follows directly from the following exact sequence :

$$1 \longrightarrow \{+1, -1\} \longrightarrow \mathrm{O}_4 \longrightarrow \mathrm{PSO}_4 \longrightarrow 1,$$

and the fact that $\mathrm{PSO}_4 \simeq \mathrm{PGL}_2 \times \mathrm{PGL}_2$ which is given in [FH91, Section 23.1].

In particular, (iii) directly implies (i). □

3.2.3 Elementary transformations

The group E_V (resp. E_H) of vertical (resp. horizontal) elementary transformations is defined by

$$\begin{aligned} \mathrm{E}_V &:= \left\{ \begin{pmatrix} ax & by \\ b^{-1}(z + xP(x, y)) & a^{-1}(t + yP(x, y)) \end{pmatrix} \mid P \in \mathbb{k}[x, y], a, b \in \mathbb{k}^* \right\}, \\ \mathrm{E}_H &:= \left\{ \begin{pmatrix} ax & b(y + xP(x, z)) \\ b^{-1}z & a^{-1}(t + zP(x, z)) \end{pmatrix} \mid P \in \mathbb{k}[x, y], a, b \in \mathbb{k}^* \right\}. \end{aligned}$$

The terminology comes from the fact that these transformations are restrictions to the quadric of transformations of \mathbb{A}^4 of the form

$$(x, y, z, t) \rightarrow (x, y + P(x), z + R(x, y), t + S(x, y, z))$$

where $P \in \mathbb{k}[x]$, $R \in \mathbb{k}[x, y]$, $S \in \mathbb{k}[x, y, z]$, which are elementary in the sense of [SU03].

Any automorphism in E_V fix the two fibrations $\pi_x : (x, y, z, t) \rightarrow x$ and $\pi_y : (x, y, z, t) \rightarrow y$ and this geometric property characterizes the group E_V (see Proposition 3.2.3.1 below). An explicit computation proves that any elementary automorphism f preserves the volume form Ω :

$$f^*\Omega = \Omega.$$

Proposition 3.2.3.1. *An automorphism $f \in \mathrm{Aut}(\mathcal{Q})$ belongs to the subgroup E_V (resp. E_H) if and only if f fixes the two fibrations $\pi_x, \pi_y : \mathcal{Q} \rightarrow \mathbb{A}^1$ (resp. $\pi_x, \pi_z : \mathcal{Q} \rightarrow \mathbb{A}^1$).*

Before proving this Proposition, we shall need the following lemma :

Lemma 3.2.3.2. *Take $f \in \mathbb{k}[Q]$ a regular function which is nowhere vanishing on Q , then $f \in \mathbb{k}^*$.*

Proof. Denote by I the ideal generated by $(q-1)$ and (f) , then one has $V(I) = V((q))$ and by the Nullstellensatz we obtain :

$$\sqrt{I} = (q-1),$$

where \sqrt{I} is the radical of I . In particular, there exists an integer n such that $q-1$ divides f^n and f^n belongs to k^* . □

Proof. If f belongs to E_V then f clearly preserves the two fibrations π_x and π_y . Let us prove the converse implication. Take $f \in \text{Aut}(\mathcal{Q})$ such that f preserves both fibrations π_x and π_y .

Step 1 : Since the fibers of π_x and π_y over $\mathbb{A}^1 \setminus \{0\}$ are isomorphic to \mathbb{A}^2 and the fibers over 0 are isomorphic to $\mathbb{A}^1 \times \mathbb{A}^1 \setminus \{0\}$, we deduce that f must fix the fibers $\pi_x^{-1}(0)$ and $\pi_y^{-1}(0)$. In particular, this implies that there exists $a, b \in k^*$ such that the maps induced by f on the base are given by $x \mapsto ax$ and $y \mapsto by$.

Step 2 : Observe that

$$\varphi : (x, y, s) \mapsto \left(x, y, s, \frac{1+ys}{x}\right)$$

is an isomorphism from $\mathbb{A}^2 \setminus \{x=0\} \times \mathbb{A}^1$ to $\mathcal{Q} \setminus \pi_x^{-1}(0)$ and that $\varphi^{-1} \circ f \circ \varphi$ is an automorphism of $\mathbb{A}^2 \setminus \{x=0\} \times \mathbb{A}^1$ which fixes the fibration induced by the first projection. As a consequence, there exists $A \in k[x, y][x^{-1}]$ and $B \in k[x, y][x^{-1}]$ such that :

$$\varphi^{-1} \circ f \circ \varphi : (x, y, s) \mapsto (ax, by, b^{-1}(A(x, y)s + B(x, y))).$$

In particular, this implies that f is given by :

$$f = \begin{pmatrix} ax & by \\ b^{-1}(A(x, y)z + B(x, y)) & a^{-1} \left(\frac{1+yzA}{x} + \frac{yB(x, y)}{x} \right) \end{pmatrix}$$

Step 3 : We prove that $A = 1$ and that B is of the form xP where $P \in k[x, y]$. Since f is an automorphism of the quadric, by Lemma 3.2.3.2, there exists a constant $c \in k^*$ such that :

$$f^* \Omega = c \Omega,$$

where Ω is the volume form on \mathcal{Q} . A straightforward computation implies that $A = c$. Moreover, the map f expressed in the chart $y \neq 0$ is of the form :

$$(x, t, y) \mapsto \begin{pmatrix} ax & by \\ b^{-1} \left(\frac{c(xt-1)}{y} + B(x, y) \right) & a^{-1} \left(\frac{1+(xt-1)c}{x} + \frac{yB(x, y)}{x} \right) \end{pmatrix}.$$

Since the fourth component must be a regular function on the quadric, in particular, the function $(1+(xt-1)c)/x + yB/x$ must be regular at $x=0$. This condition implies that $c=1$ and that $x|B$. In particular, $B = xP$ where $P \in k[x, y]$ as required. We have thus :

$$f = \begin{pmatrix} ax & by \\ b^{-1}(z + xP(x, y)) & a^{-1}(t + yP(x, y)) \end{pmatrix} \in E_V,$$

which concludes the proof. □

Let us now focus on the properties of the action of these elementary transformations on the compactification $\overline{\mathcal{Q}}$. Recall that the indeterminacy locus $\text{Ind}(f) \subset \overline{\mathcal{Q}}$ of a rational map $f : \overline{\mathcal{Q}} \dashrightarrow \overline{\mathcal{Q}}$ is the set of critical values of the morphism $\pi_1 : \Gamma_f \rightarrow \overline{\mathcal{Q}}$ where π_1 is the projection of the graph of f in $\overline{\mathcal{Q}} \times \overline{\mathcal{Q}}$ onto the first component.

For the proof of our next result, we need to introduce some technical terminologies on Newton polygons (see [CLS11, Section 2.3]). Recall that the Newton polygon $\Delta(P)$ of a polynomial $P \in k[u, w]$ is the convex hull of points $(i, j) \in \mathbb{N}^2$ appearing in the power series expansion of P . Observe that the Newton polygon of a polynomial is a rational polytope.

Given a polynomial $P \in k[x, y]$ of degree p and $\lambda \in \mathbb{P}^1$, we define the polynomial $P_\lambda \in k[u, w]$ by the formula :

$$P_\lambda(u, w) := \begin{cases} w^p P\left(\frac{1}{w}, \frac{\eta + u}{w}\right) & \text{if } \lambda = [1, \eta] \text{ where } \eta \in k, \\ w^p P\left(\frac{u}{w}, \frac{1}{w}\right) & \text{if } \lambda = [0, 1]. \end{cases} \quad (3.4)$$

The polygon $\Delta_{(P, \lambda)}$ associated to the pair (P, λ) is the Newton polygon of the polynomial $P_\lambda \in k[u, w]$.

Definition 3.2.3.3. A pair (P, λ) where $P \in k[x, y]$ is a polynomial of degree p and $\lambda \in \mathbb{P}^1$ is special if the following conditions are satisfied.

- (i) We have $\bar{P}(\lambda) = 0$ where \bar{P} is the homogeneous component of P of maximal degree in x, y .
- (ii) There exists a Puiseux series $u(w)$ such that $\text{ord}_w u(w) > 0$ and such that :

$$\text{ord}_w P_\lambda(u(w), w) \geq p. \quad (3.5)$$

Theorem 3.2.3.4. Consider the elementary transformation $e \in E_V$ given by :

$$e = \begin{pmatrix} ax & by \\ b^{-1}(z + xP(x, y)) & a^{-1}(t + yP(x, y)) \end{pmatrix},$$

where $P \in k[x, y] \setminus k[x]$.

- (i) The indeterminacy set of e is contained in H_∞ and is given by (under the identification $H_\infty \simeq \mathbb{P}^1 \times \mathbb{P}^1$) :

$$\text{Ind}(e) := (\{[0, 1]\} \times \mathbb{P}^1) \cup \left(\bigcup_n \mathbb{P}^1 \times \{\lambda_n\} \right),$$

where $\lambda_n \in \mathbb{P}^1$ describes all the values for which the pair (P, λ_n) is special.

- (ii) The image of a point in $m \in H_\infty \setminus \text{Ind}(e)$ is the intersection of the horizontal line passing through m with the vertical passing through $[0, 0, 0, 1, 0] \in \bar{\mathcal{Q}}$.

Remark 3.2.3.5. By symmetry, an element of E_H contracts the hyperplane at infinity $H_\infty \cap \bar{\mathcal{Q}}$ to the line $\mathbb{P}^1 \times \{[0, 1]\}$.

We have the following picture.

Example 3.2.3.6. Consider the polynomial $P \in k[x, y]$ given by :

$$P = 2x^2y - 3xy^2 + y^3 - 2xy + 2y^2 - 2x + 2y + 3,$$

and let e be the elementary morphism given by :

$$e = \begin{pmatrix} x & y \\ z + xP(x, y) & t + yP(x, y) \end{pmatrix}.$$

The zeros of \bar{P} are the points $[1, 0]$, $[1, 1]$ and $[1, 2] \in \mathbb{P}^1$ and only $(P, [1, 0])$ is special. We have thus :

$$\text{Ind}(e) = \{[0, 1]\} \times \mathbb{P}^1 \cup \mathbb{P}^1 \times \{[1, 0]\}.$$

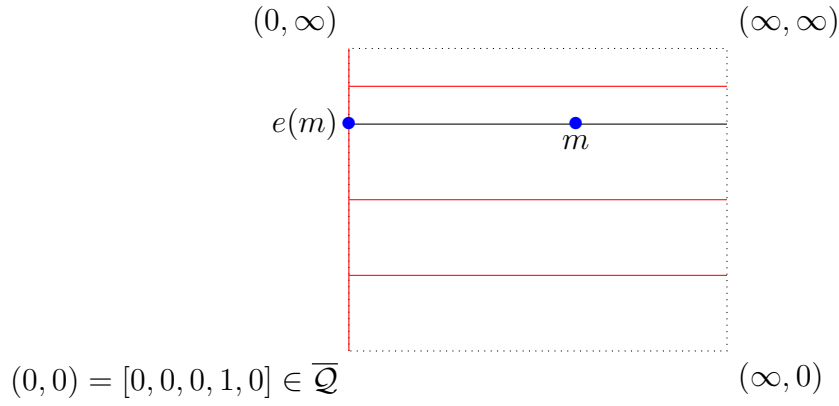

FIGURE 3.1 – Indeterminacy set of an elementary transformation (in red) which satisfies condition (3.5) on the hyperplane at infinity $H_\infty \simeq \mathbb{P}^1 \times \mathbb{P}^1$.

Proof. Take $P \in \mathbb{k}[x, y] \setminus \mathbb{k}[x]$ so that $e \in E_V$ is given by :

$$e = \begin{pmatrix} ax & by \\ b^{-1}(z + xP(x, y)) & a^{-1}(t + yP(x, y)) \end{pmatrix},$$

where $a, b \in \mathbb{k}^*$. Since we can always consider $g \circ e$ where g a linear automorphism of the form

$$\begin{pmatrix} a^{-1}x & b^{-1}y \\ bz & at \end{pmatrix},$$

we can suppose that $a = b = 1$. Denote by F the closed subset in H_∞ given by :

$$F = \{[0, 1]\} \times \mathbb{P}^1 \cup \left(\bigcup_n \mathbb{P}^1 \times \{\lambda_n\} \right)$$

where $\lambda_n \in \mathbb{P}^1$ are the zeros of the section \bar{P} .

Step 1 : e is the restriction to \mathcal{Q} of the birational map of \mathbb{P}^4

$$E : [x, y, z, t, w] \mapsto [xw^p, yw^p, zw^p + xw^pP(x/w, y/w), tw^p + yw^pP(x/w, y/w), w^{p+1}].$$

In particular, we obtain :

$$E([x, y, z, t, 0]) = [0, 0, x\bar{P}(x, y), y\bar{P}(x, y), 0],$$

so that the indeterminacy locus of E is contained in

$$(\bar{P}(x, y) = 0) \cap (w = 0) \subset \mathbb{P}^4.$$

This implies that

$$\text{Ind}(e) \subset \text{Ind}(E) \cap H_\infty.$$

Moreover, the image of a point $m \in H_\infty \setminus F$ by e is exactly the intersection of the horizontal line passing by m with the vertical line $\{[0, 1]\} \times \mathbb{P}^1$ proving (ii). The hyperplane at infinity is thus contracted to the vertical line $[0, 1] \times \mathbb{P}^1$ at infinity, in particular we have that :

$$\{[0, 1]\} \times \mathbb{P}^1 \subset \text{Ind}(e).$$

We have proven that

$$\text{Ind}(e) \subset F.$$

Step 2 : Suppose that the pair (P, λ) is special. Up to a conjugation by the involution

$$(x, y, z, t) \rightarrow (-y, x, -t, z)$$

which exchanges the lines $\mathbb{P}^1 \times \{[0, 1]\}$ and $\mathbb{P}^1 \times \{[1, 0]\}$ at infinity, we can suppose that $\lambda \in \mathbb{P}^1 \setminus \{[0, 1]\}$ and $\lambda = [1, \eta]$ where $\eta \in k$. Take a point $m \in \mathbb{P}^1 \setminus \{[0, 1]\} \times \{\lambda\}$ on that line and suppose by contradiction that e is regular at this point. Then e must map m to the point of intersection $m' = [0, 0, 1, \eta, 0] \in H_\infty$ of the horizontal line $\mathbb{P}^1 \times \{\lambda\}$ with the vertical line $[0, 1] \times \mathbb{P}^1$. Let $m = [1, \eta, \xi, \xi\eta, 0]$ be the homogeneous coordinates of m where $\xi \in k$. A coordinate chart near m is given by :

$$\varphi_m : (u, v, w) \rightarrow [1, u + \eta, v + \xi, (v + \xi)(u + \eta) + w^2, w].$$

Since $\overline{P}(1, \eta) = 0$, the map $e \circ \varphi_m$ is given in coordinate charts by :

$$(u, v, w) \rightarrow [w^p, (\eta + u)w^p, (\xi + v)w^p + P_\lambda(u, w), ((\xi + v)(\eta + u) + w^2)w^p + (\eta + u)P_\lambda(u, w), w^{p+1}].$$

In the previous expression, we notice that the third and fourth component in the homogeneous coordinates contain a term of the form P_λ where $\lambda = [1, \eta]$ as in (3.4).

Choose a Puiseux series u for which condition (3.5) is satisfied. Consider the local branch $c : (\mathbb{A}^1, 0) \rightarrow (\mathbb{A}^3, 0)$ given by

$$c : s \rightarrow (u(s), v(s) = s, w(s) = s).$$

An explicit computation proves that the composition $e \circ \varphi_m \circ c$ defines a local branch near the point $m'' \in \overline{\mathcal{Q}}$ given in homogeneous coordinates by $m'' = [1, \eta, \xi', \xi'\eta, 0]$ where $\xi' \in k$ is the coefficient in the leading term in the Taylor expansion of $P(1/w, (\eta + u)/w)w^p$. This contradicts our assumption since the two points m' and m'' are distinct. We have thus proved that

$$\{[0, 1]\} \times \mathbb{P}^1 \cup (\mathbb{P}^1 \times \{\lambda\}) \subset \text{Ind}(e).$$

Step 3 : Conversely, suppose that $\lambda \in \mathbb{P}^1$ such that $\overline{P}(\lambda) = 0$ but the pair (P, λ) is not special. We prove that e is regular at any point $m \in \mathbb{P}^1 \setminus \{[0, 1]\} \times \{\lambda\}$ at infinity. By the same argument as in the previous step, we suppose that $\lambda \in \mathbb{P}^1 \setminus \{[0, 1]\}$. Let $\lambda = [1, \eta]$, $m = [1, \eta, \xi, \xi\eta, 0]$ in homogeneous coordinates where $\eta, \xi \in k$ and let φ_m be the chart near the point m previously defined. We prove that for any morphism $c' : (\mathbb{A}^1, 0) \rightarrow (\overline{\mathcal{Q}}, m)$, the composition $e \circ c'$ induces a homomorphism of local rings from $\mathcal{O}_{\mathbb{A}^1, 0}$ to $\mathcal{O}_{\overline{\mathcal{Q}}, m'}$ where $m' = [0, 0, 1, \eta, 0]$ is the intersection at infinity of the lines $\mathbb{P}^1 \times \{\lambda\}$ and $\{[0, 1]\} \times \mathbb{P}^1$. Suppose that the local morphism $\varphi_m \circ c' : (\mathbb{A}^1, 0) \rightarrow (\mathbb{A}^3, 0)$ is given by :

$$\varphi_m \circ c' : s \rightarrow (u(s), v(s), w(s)),$$

where $u, v, w : (\mathbb{A}^1, 0) \rightarrow (\mathbb{A}^1, 0)$ are regular functions at 0. Let p_1, p_2, p_3 be the order of vanishing along the maximal ideal in $\mathcal{O}_{\mathbb{A}^1, 0}$ of u, v and w respectively. Observe that we can suppose that the germ c' does not belong to H_∞ and this implies that $p_3 > 0$. In particular, there exists two Puiseux series f and g such that $u(s) = f(w(s))$ and $v(s) = g(w(s))$.

Since the pair (P, λ) is not special, the Puiseux series f does not satisfy condition (3.5). This implies that :

$$\text{ord}_w w^p P \left(\frac{1}{w}, \frac{\eta + f(w)}{w} \right) < p,$$

whereas $\text{ord}_w w^p = p \leq \text{ord}_w((\eta + u)w^p)$. Consider the local branch c'' near the point 0 in \mathbb{A}^3 given by :

$$c'' : \tau \mapsto (u = f(\tau), v = g(\tau), \tau),$$

then an explicit computation in coordinates proves that the composition $e \circ \varphi_m \circ c''$ is given by :

$$\tau \mapsto [O(\tau^{p-r}), O(\tau^{p-r}), 1 + O(\tau), \eta + O(\tau), \tau^{p+1-r}],$$

where $r = \text{ord}_w w^p P(1/w, (\eta + f(w))/w)$ and where $O(\tau^l)$ denote a term which vanishes with order larger or equal than l . In particular, the composition $e \circ \varphi_m \circ c''$ defines a local branch near the point $m' = [0, 0, 1, \eta, 0]$. This implies that the morphism $e \circ c$ maps $(\mathbb{A}^1, 0)$ to $(\overline{\mathcal{Q}}, m')$, as required. □

Condition (3.5) can be expressed combinatorially. Recall that if $\Delta_{(P,\lambda)}$ is 2-dimensional, the normal fan of the Newton polytope $\Delta_{(P,\lambda)}$ is a fan where the one dimensional rays are the inner normal vectors of the polytope (i.e the normal vector which pointing to the interior of the polytope). We thus have the following characterization.

Proposition 3.2.3.7. *Let $Q = \sum_{i,j} a_{ij} u^i w^j \in k[u, w]$ be a polynomial of degree q and let $\Delta(Q)$ be the Newton polygon of Q . Then the following assertions are equivalent.*

(i) *There exists a Puiseux series $u(w)$ such that $\text{ord}_w u(w) > 0$ and such that :*

$$\text{ord}_w Q(u(w), w) \geq q.$$

(ii) *Either the Newton polygon $\Delta(Q)$ does not contain any point on the segment $\{0\} \times [0, q[$, or $\Delta(Q)$ is 2-dimensional and there exists two integers $(p_1, p_2) \in \mathbb{N} \times \mathbb{N}^*$ which satisfy the following conditions :*

(a) *The vector (p_1, p_2) is an inner normal vector of the polygon $\Delta(Q)$.*

(b) *The line $\{(x, y) \in \mathbb{R}^2 \mid p_1 x + p_2 y = p_2 q\}$ which passes through the point $(0, q)$ and which is normal to (p_1, p_2) intersects the polygon $\Delta(Q)$.*

(c) *There exists $(u_0, w_0) \in (k^*)^2$ such that for any integer $l < qp_2$:*

$$\sum_{p_1 i + p_2 j = l} a_{ij} u_0^i w_0^j = 0.$$

Remark 3.2.3.8. This proposition provides an effective way to compute the indeterminacy locus of an elementary automorphism.

Proof. We prove (i) \Rightarrow (ii) : Let $u(w)$ be a Puiseux series which satisfies (i). By definition, there exists an integer $q \in \mathbb{N}^*$ such that $u \in k((w^{1/q}))$. Let us consider $p_2 = q$ and $p_1 = \text{ord}_w u(w) \cdot q$. If the polygon $\Delta(Q)$ belongs to the half space

$$\{(x, y) \mid p_1 x + p_2 y \geq p_2 q\},$$

then (ii) is satisfied since the segment $\{0\} \times [0, q[$ does not intersect the Newton polygon $\Delta(Q)$.

Suppose that $\Delta(P)$ is 2-dimensional and contains a point in the segment $\{0\} \times [0, q[$. Let us prove that assertion (a) must be satisfied. Suppose that (p_1, p_2) is not an inner normal vector of the polygon $\Delta(Q)$, then this implies that $\text{ord}_w(Q(u(w), w)) < q$ which contradicts our assumption.

Suppose that condition (b) is not satisfied, then we have that $\Delta(Q)$ is contained in the half-space $\{(x, y) \in \mathbb{R}^2 \mid p_1x + p_2y < p_2q\}$. In particular, this implies that :

$$\text{ord}_w(Q(u(w), w)) < q,$$

which contradicts our assumption.

Let us prove that condition (c) is satisfied. Write $u(w) = u_0w^{p_1/p_2}(1 + \sum_{i=1} b_iw^{\gamma_i})$ where $b_i \in \mathbb{k}$, (γ_i) is a strictly increasing sequence of positive rational numbers and $u_0 \in \mathbb{k}^*$, then the condition that $\text{ord}_w(Q(u(w), w)) \geq q$ implies that $(u = u_0, v = 1)$ satisfies :

$$\sum_{ip_1 + jp_2 = l} a_{ij}u_0^i = 0$$

for any $l < p_2q$. We have thus proven that condition (c) is satisfied.

Let us prove $(ii) \Rightarrow (i)$. Suppose that the Newton polygon $\Delta(Q)$ does not contain any point in the segment $\{0\} \times [0, q[$, then there exists two integers $(p_1, p_2) \in \mathbb{N} \times \mathbb{N}^*$ such that the polygon $\Delta(Q)$ is contained in the half plane :

$$\{(x, y) \in \mathbb{R}^2 \mid p_1x + p_2y \geq p_2q\}.$$

In particular, this implies that any Puiseux series $u(w)$ of the form :

$$u(w) = u_0w^{p_1/p_2},$$

where u_0 is generic, satisfies (i).

Suppose that the Newton polygon is 2-dimensional but intersects the segment $\{0\} \times [0, q[$. Consider (p_1, p_2) satisfying the conditions (a), (b) and (c). Consider $(u_0, w_0) \in \mathbb{k}^*$ which satisfy condition (c) and the Puiseux series $u(w)$ given by :

$$u(w) = u_0 \left(\frac{w}{w_0} \right)^{p_1/p_2}.$$

By construction, every term of order strictly smaller than q vanishes, hence :

$$\text{ord}_w P(u(w), w) \geq q.$$

We have thus proven (i). □

3.3 The square complex associated to the tame group

The tame group, denoted $\text{Tame}(Q)$, is the subgroup of $\text{Aut}(Q)$ generated by E_V and O_4 . It is naturally included in $\text{Bir}(\mathbb{P}^3)$ since the variety \overline{Q} is rational.

Lemma 3.3.0.1. *Any tame automorphism fixes the volume form Ω up to a sign, i.e there exists a group morphism $\epsilon : \text{Tame}(Q) \rightarrow \{+1, -1\}$ such that :*

$$f^*\Omega = \epsilon(f)\Omega,$$

for all $f \in \text{Tame}(Q)$.

The subgroup $\text{STame}(\mathcal{Q})$ is the kernel of ϵ , it is generated by SO_4 and E_V and has index 2 in $\text{Tame}(\mathcal{Q})$.

The tame group $\text{Tame}(\mathcal{Q})$ is a strict subgroup of $\text{Aut}(\mathcal{Q})$. The proof of the strict inclusion is due to Lamy-Vénereau who adapted the ideas from [SU03] to prove that the automorphism given by

$$\begin{pmatrix} x - y(x - t)^n & y \\ z + (x - t)(x + t)^n - y(x + t)^{2n} & t + y(x + t)^n \end{pmatrix}$$

is not tame (see [LV13, Section 5.1]). Bisi-Furter-Lamy went further in the study of this group and proved that this group satisfies the Tits alternative (see [BFL14, Theorem C]). Their proof relies on the construction of a square complex on which the group acts by isometry which we now recall.

3.3.1 Construction of the square complex

The square complex, denoted \mathcal{C} , is a 2-dimensional polyhedral complex where the cells of dimension 2 are squares and where the cells of dimension 0 and 1 have some special markings.

We say that a regular function $f_1 \in k[\mathcal{Q}]$ is a component of an automorphism if there exists $f_2, f_3, f_4 \in k[\mathcal{Q}]$ such that $f = (f_1, f_2, f_3, f_4)$ defines an automorphism of the quadric. One similarly defines the notion of components for a pair (f_1, f_2) or for a triple (f_1, f_2, f_3) of regular functions on \mathcal{Q} when they can be completed to a 4-tuple defining an automorphism of the affine quadric.

We distinguish three types of vertices for the complex \mathcal{C} :

- Type I vertices are equivalence classes of components $f_1 \in k[\mathcal{Q}]$ of an automorphism, where two components f_1 and f_2 are identified if there exists an element $a \in k^*$ such that $f_1 = af_2$. A vertex induced by a component $f_1 \in k[\mathcal{Q}]$ is denoted by $[f_1]$.
- Type II vertices are equivalence class of components (f_1, f_2) of an automorphism where $f_1 = x \circ f, f_2 = y \circ f \in k[\mathcal{Q}]$ for $f \in \text{Tame}(\mathcal{Q})$ and where one identifies two components (f_1, f_2) with (g_1, g_2) if $(g_1, g_2) = (af_1 + bf_2, cf_1 + df_2)$ for some matrix :

$$\begin{pmatrix} a & b \\ c & d \end{pmatrix} \in \text{GL}_2.$$

A vertex induced by a component (f_1, f_2) is denoted by $[f_1, f_2]$. Denote by $f_3 = z \circ f$ and $f_4 = t \circ f$, the vertices $[f_1, f_2], [f_1, f_3], [f_2, f_4], [f_3, f_4]$ are well-defined since the automorphisms $(f_1, f_3, f_2, f_4), (-f_2, -f_4, f_1, f_3)$ and $(-f_3, f_4, -f_1, f_2)$ are also tame.

Moreover, given a component (f_1, f_2) and an invertible matrix $\begin{pmatrix} a & b \\ c & d \end{pmatrix} \in \text{GL}_2$, there exists an automorphism g such that $x \circ g = af_1 + bf_2$ and $y \circ g = cf_1 + df_2$. Let us insist on the fact that on the contrary, there are no vertices of the form $[f_1, f_4]$ or $[f_2, f_3]$. Indeed, suppose that $f_1 = x \circ g$ and $f_4 = y \circ g$ where g is tame, then the automorphism $f^{-1} \circ g$ satisfies $x \circ f^{-1} \circ g = x, y \circ f^{-1} \circ g = t$. Using the fact that the volume form Ω is preserved, we arrive at a contradiction.

- Type III vertices are equivalence classes of automorphisms $f \in \text{Tame}(\mathcal{Q})$ where two tame automorphisms f and g are equivalent if there exists $h \in \text{O}_4$ such that $f = h \circ g$. An equivalence class of $f \in \text{Tame}(\mathcal{Q})$ is denoted by $[f]$.

The edges of the complex \mathcal{C} are of two types :

- Type I edges join a vertex of type I of the form $[f_1]$ with a vertex of type II of the form $[f_1, f_2]$ where (f_1, f_2) are the components of a tame automorphism.

- Type III edges join a vertex of type II of the form $[f_1, f_2]$ with a vertex of type III $[f]$ where (f_1, f_2) are the components of the automorphism given by f .

The cells of dimension 2 are squares containing two type II vertices of the form $[f_1, f_2]$, $[f_1, f_3]$, one vertex of type I given by $[f_1]$ and one vertex of type III given by $[f]$ where (f_1, f_2, f_3) are the components of the automorphism $f \in \text{Tame}(\mathcal{Q})$. We have the following figure of a square. As in [BFL14], we adopt the following convention for the pictures : the vertices of type I, II and III are represented by the symbol \circ , \bullet and \blacksquare respectively.

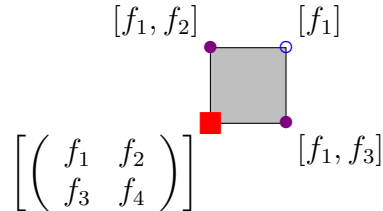

The square complex \mathcal{C} is obtained by the quotient of the disjoint union of all cells by the equivalence relation \sim where any two cells C_1, C_2 are identified along $C_1 \cap C_2$.

Each square of the complex is endowed with the euclidean metric d so that each square is isometric to $[0, 1] \times [0, 1]$. For any points p and q in \mathcal{C} , define by :

$$d_{\mathcal{C}}(p, q) = \inf \left\{ \sum_{i=0}^N d(p_i, p_{i+1}) \right\},$$

where the infimum is taken over all sequence of points $p_0 = p, \dots, p_N = q$ where p_i and p_{i+1} lie on the same square in \mathcal{C} . As any cell of the complex \mathcal{C} has only finitely many isometries, we may apply a general result from [BH99, Section I.7] and we conclude that the function $d_{\mathcal{C}}$ induces a metric on the complex and turns $(\mathcal{C}, d_{\mathcal{C}})$ into a complete metric space. We will explain in section 3.5 the global properties on the complex induced by this metric.

We recall the action of the tame group $\text{Tame}(\mathcal{Q})$ on the complex \mathcal{C} . Pick any two automorphisms $f, g \in \text{Tame}(\mathcal{Q})$. We define the action of g on the components of f by setting :

$$\begin{aligned} g \cdot [f_1] &:= [f_1 \circ g^{-1}], \\ g \cdot [f_1, f_2] &:= [f_1 \circ g^{-1}, f_2 \circ g^{-1}], \\ g \cdot [f] &:= [f \circ g^{-1}]. \end{aligned}$$

The action on vertices induces a morphism of the square complex which preserves the type of vertices and edges and preserves the distance.

Recall that the subgroup $\text{STame}(\mathcal{Q})$ generated by SO_4 and elementary transformations has index 2 in $\text{Tame}(\mathcal{Q})$.

Definition 3.3.1.1. *An edge E of the complex is called horizontal (resp. vertical) if there exists an element $f \in \text{STame}(\mathcal{Q})$ such that $f \cdot E$ is equal to the edge joining $[x, y]$ with $[x]$ (resp. $[x, z]$ with $[x]$) or to the edge between $[\text{Id}]$ and $[x, z]$ (resp. $[\text{Id}]$ and $[x, y]$).*

We will show that the set of vertical and horizontal edges form a partition of the set of edges (see (iii) and (iv) of Proposition 3.3.2.3).

We shall explain the properties of this action by exploiting the local geometry near each vertex of the complex.

3.3.2 Stabilizer of vertices of type III

The link of a vertex v is by definition the graph $\mathcal{L}(v)$ constructed as follows. The vertices are in bijection with the vertices v' such that $[v, v']$ is an edge of the complex \mathcal{C} . And we draw an edge joining v' and v'' in $\mathcal{L}(v)$ if the vertices v, v', v'' belong to the same square.

Observe that the action of the tame group on the vertices of type III is transitive. As a result, we shall focus on the stabilizer subgroup of the vertex $[\text{Id}]$. Observe that the subgroup O_4 fixes the vertex $[\text{Id}]$ and its action on the complex induces naturally an action on the link $\mathcal{L}([\text{Id}])$.

Proposition 3.3.2.1. *The link $\mathcal{L}([\text{Id}])$ is a complete bipartite graph and there exists an O_4 -equivariant bijection between the set of vertices of the link $\mathcal{L}([\text{Id}])$ to the set of lines at infinity such that the vertices which belong to a vertical (resp. horizontal) edge of type III are mapped to vertical (resp. horizontal) lines at infinity in H_∞ . Moreover, this bijection induces an O_4 -equivariant bijection from the edges of $\mathcal{L}([\text{Id}])$ to the set of points at infinity H_∞ .*

Remark 3.3.2.2. Observe that Proposition 3.2.2.1 and Proposition 3.3.2.1 imply that the group O_4 acts faithfully and transitively on the link $\mathcal{L}([\text{Id}])$.

Proof. We identify two types of vertices in the link of $[\text{Id}]$, the vertices which belong to a horizontal edge containing $[\text{Id}]$ or those which are contained in a vertical edge containing $[\text{Id}]$.

We define a map φ from the vertices of the link $\mathcal{L}([\text{Id}])$ to the set of lines in H_∞ . Take a vertex v in the link $\mathcal{L}([\text{Id}])$ and a component (f_1, f_2) such that $[f_1, f_2] = v$. By definition, there exists an element $f \in O_4$ such that $f_1 = x \circ f$ and $f_2 = y \circ f$ since the stabilizer of $[\text{Id}]$ is O_4 . The zero locus $V(f_1) \cap V(f_2) \cap H_\infty$ in $\overline{\mathcal{Q}}$ is the line at infinity corresponding to the preimage of $\{x = y = 0\} \cap \overline{\mathcal{Q}}$ by f . Observe that the line $V(f_1) \cap V(f_2) \cap H_\infty$ does not depend on the choice of representative of the equivalence class v since any two other component in the same class defines the same homogeneous ideal $\langle f_1, f_2, xt - yz - w^2 \rangle$. We thus define $\varphi(v)$ to be the line $V(f_1) \cap V(f_2) \cap H_\infty$. Observe that if v is a vertex of type II such that the edge containing v and $[\text{Id}]$ is vertical, then $f \in \text{SO}_4$. Hence the line at infinity $V(x \circ f) \cap V(y \circ f) \cap H_\infty$ is vertical. Observe also that φ is naturally O_4 -equivariant. The same argument holds for the vertices of type II which belong to horizontal edges containing $[\text{Id}]$.

Let us prove that the map φ is surjective. Consider a vertical line $L \subset H_\infty$ at infinity, then there exists by Proposition 3.2.2.1.(i) an automorphism f in SO_4 such that the image of the vertical line at infinity given by $[0, 1] \times \mathbb{P}^1$ is L . Since $\varphi([x, y])$ corresponds to the line $[0, 1] \times \mathbb{P}^1$, the vertex of type II $[x \circ f, y \circ f]$ defines a component of an automorphism which belongs to the link $\mathcal{L}([\text{Id}])$ such that $\varphi([x \circ f, y \circ f]) = L$. Hence, φ is surjective.

Let us prove that φ is injective. Consider two vertices v_1, v_2 such that their image by φ is equal, we prove that $v_1 = v_2$. Consider two components $(f_1, f_2), (g_1, g_2)$ such that $[f_1, f_2] = v_1$ and $[g_1, g_2] = v_2$. We must prove that (f_1, f_2) and (g_1, g_2) belong to the same equivalence class. By symmetry, we can suppose that the line $\varphi(v_1)$ is vertical. Hence, there exists $f, g \in \text{SO}_4$ such that $f_1 = x \circ f, g_1 = x \circ g, f_2 = y \circ f$ and $g_2 = y \circ g$. In particular, this implies that $f \circ g^{-1}$ fixes the vertical line at infinity given by $\{[0, 1]\} \times \mathbb{P}^1$. Using Proposition 3.2.2.1.(iii), we conclude that $f \circ g^{-1}$ is of the form

$$f \circ g^{-1} = \begin{pmatrix} ax + by & cx + dy \\ a'z + b't & c'z + d't \end{pmatrix},$$

where the matrices $\begin{pmatrix} a & b \\ c & d \end{pmatrix}, \begin{pmatrix} d' & -b' \\ -c' & a' \end{pmatrix} \in M_2(k)$ satisfy

$$\begin{pmatrix} a & b \\ c & d \end{pmatrix} \cdot \begin{pmatrix} d' & -b' \\ -c' & a' \end{pmatrix} = \begin{pmatrix} 1 & 0 \\ 0 & 1 \end{pmatrix}.$$

In particular, this implies that the components (f_1, f_2) and (g_1, g_2) are equivalent since $f_1 = ag_1 + bg_2, f_2 = cg_1 + dg_2$.

One similarly defines a bijection from the edges of the link $\mathcal{L}([\text{Id}])$ to H_∞ . The link is complete since a horizontal and a vertical line in H_∞ always intersect at a point in H_∞ , hence for any vertices v_1, v_2 in $\mathcal{L}([\text{Id}])$ which are mapped by φ to a vertical and a horizontal line respectively, there exists an edge joining v_1 and v_2 . □

Proposition 3.3.2.1 implies the following statement on the properties of the action on the complex.

Proposition 3.3.2.3. *The tame group $\text{Tame}(\mathcal{Q})$ acts by isometry on the complex \mathcal{C} and satisfies the following properties.*

- (i) *The action preserves the types of vertices and the types of edges.*
- (ii) *The action is faithful and transitive on the set of vertices of type I, II and III respectively.*
- (iii) *The subgroup $\text{STame}(\mathcal{Q})$ acts transitively on the set of vertical (resp. horizontal) edges of type I and III.*
- (iv) *Any automorphism $f \in \text{Tame}(\mathcal{Q})$ which does not belong to the subgroup $\text{STame}(\mathcal{Q})$ sends a vertical edge to a horizontal edge of the same type.*
- (v) *The subgroup $\text{STame}(\mathcal{Q})$ acts transitively on the set of 1×1 squares.*
- (vi) *The group $\text{Tame}(\mathcal{Q})$ acts transitively on the union of 4 squares which is isometric to $[0, 2] \times [0, 2]$ and which contains a common vertex of type III.*

Proof. We prove successively assertions (i), (ii), (v), (iii), (iv) and (vi). Assertion (i) follows from the definition of the action, as for assertion (ii), the transitivity on the set of vertices of type III is straightforward. As a consequence, we are thus reduced to check the transitivity on the set of vertices of type II and type I which belong to a square containing $[\text{Id}]$ which results from the transitivity of the action of O_4 on the link $\mathcal{L}([\text{Id}])$ by Proposition 3.3.2.1 and Proposition 3.2.2.1.

Let us prove the faithfulness of the action. Observe that if a tame automorphism fixes every vertices of type III, or type II or type I, then it fixes the whole complex since every vertex of type III (resp. type II or I) is the middle point of a geodesic segment joining type I or type II points. The faithfulness also follows from the faithfulness of the action on the link $\mathcal{L}([\text{Id}])$.

We prove assertion (v). Since the group $\text{STame}(\mathcal{Q})$ acts transitively on the vertices of type III, we are reduced to prove that the action of $\text{STame}(\mathcal{Q})$ is transitive on the squares which contain the vertex $[\text{Id}]$. Observe that a square containing $[\text{Id}]$ corresponds to a edge in the link $\mathcal{L}([\text{Id}])$ which in turns corresponds uniquely a point at infinity by Proposition 3.3.2.1. Since the group SO_4 acts transitively on the points at infinity by Proposition 3.2.2.1.(i), it also acts transitively on the squares containing $[\text{Id}]$, as required.

Assertion (iii) and (iv) also follow from the transitivity of $\text{STame}(\mathcal{Q})$ on the vertices of type III and Proposition 3.3.2.1. Finally, we prove assertion (vi). By (ii), we are reduced to prove the transitivity on the union of 4 squares containing $[\text{Id}]$. By Proposition 3.3.2.1, any such union is in bijection with the union of 4 lines at infinity in $H_\infty = \mathbb{P}^1 \times \mathbb{P}^1$ forming a chain of \mathbb{P}^1 . We thus conclude using the transitivity of the action of $\text{O}_4 \simeq \text{PGL}_2 \times \text{PGL}_2$ on these chains of 4 lines at infinity. □

Another consequence of Proposition 3.3.2.1 is the following description of stabilizer subgroups.

Proposition 3.3.2.4. *The following properties are satisfied.*

- (i) The stabilizer of a vertex of type III in $\text{STame}(\mathcal{Q})$ is conjugated in $\text{STame}(\mathcal{Q})$ to SO_4 .
 (ii) The stabilizer of an edge of type III is conjugated in $\text{Tame}(\mathcal{Q})$ to the subgroup :

$$\begin{pmatrix} ax + by & cx + dy \\ a'z + b't & c'z + d't \end{pmatrix}$$

where the matrices $\begin{pmatrix} a' & b' \\ c' & d' \end{pmatrix} \in \text{GL}_2$ and

$$\begin{pmatrix} a & b \\ c & d \end{pmatrix} = \frac{1}{a'd' - b'c'} \begin{pmatrix} a' & b' \\ c' & d' \end{pmatrix}.$$

- (iii) The stabilizer of a 1×1 square is conjugated in $\text{Tame}(\mathcal{Q})$ to :

$$\left\{ \begin{pmatrix} ax & b(y + cx) \\ b^{-1}(z + dx) & a^{-1}(t + cz + dy + dcx) \end{pmatrix} \mid (a, b, c, d) \in \mathbf{k}^* \times \mathbf{k}^* \times \mathbf{k} \times \mathbf{k} \right\} \rtimes \left\{ \begin{pmatrix} x & z \\ y & t \end{pmatrix}, \text{Id} \right\}$$

- (iv) The pointwise stabilizer of the union of the four squares containing $[\text{Id}]$ and $[x], [y], [z]$ and $[t]$ respectively is equal to :

$$\left\{ \begin{pmatrix} ax & by \\ b^{-1}z & a^{-1}t \end{pmatrix} \mid a, b \in \mathbf{k}^* \right\}$$

Remark 3.3.2.5. Observe that the stabilizer of an edge of type III is isomorphic to GL_2 which is obtained using the O_4 -equivariant bijection given by Proposition 3.3.2.1.

Proof. One checks directly that the stabilizer of a vertex of type III is conjugated in $\text{Tame}(\mathcal{Q})$ to O_4 and assertion (i) follows directly by definition of the subgroup $\text{STame}(\mathcal{Q})$.

Let us prove assertion (ii). By transitivity on type III and type II vertices of the action and by conjugating with an appropriate element in $\text{Tame}(\mathcal{Q})$, we are reduced to compute the stabilizer of the edge joining $[\text{Id}]$ and $[x, y]$. By Proposition 3.3.2.1.(i), this implies that this stabilizer is a subgroup of SO_4 which acts on the hyperplane H_∞ at infinity by fixing the vertical line $\{[0, 1]\} \times \mathbb{P}^1$. Hence any such element is of the form :

$$\begin{pmatrix} ax + by & cx + dy \\ a'z + b't & c'z + d't \end{pmatrix}$$

where the matrices $\begin{pmatrix} a & b \\ c & d \end{pmatrix}, \begin{pmatrix} d' & -b' \\ -c' & a' \end{pmatrix} \in \text{M}_2(\mathbf{k})$ satisfy

$$\begin{pmatrix} a & b \\ c & d \end{pmatrix} \cdot \begin{pmatrix} d' & -b' \\ -c' & a' \end{pmatrix} = \begin{pmatrix} 1 & 0 \\ 0 & 1 \end{pmatrix},$$

as required.

One proves assertion (iii) and (iv) similarly using the same arguments. \square

3.3.3 Stabilizers of vertices of type II

We focus on the stabilizer subgroups of vertices of type II.

Proposition 3.3.3.1. *The following properties are satisfied.*

- (i) The stabilizer of a vertex of type II in $\text{Tame}(\mathcal{Q})$ is conjugated in $\text{Tame}(\mathcal{Q})$ to the semi-direct product $E_V \rtimes \text{GL}_2$ where the group GL_2 is identified with the stabilizer of the edge of type III joining $[\text{Id}]$ and $[x, y]$.
- (ii) The stabilizer of a vertical edge of type I is conjugated in $\text{STame}(\mathcal{Q})$ to the subgroup :

$$E_H \rtimes \left\{ \left(\begin{array}{cc} ax & d^{-1}y \\ dz + cx & at + ca^{-1}d^{-1}y \end{array} \right) \mid (a, c, d) \in k^* \times k \times k^* \right\}.$$

- (iii) The pointwise stabilizer of the geodesic segment of length 2 joining the vertices $[f_1]$, $[f_3]$ and $[f_1, f_3]$ where $f = (f_1, f_2, f_3, f_4) \in \text{STame}(\mathcal{Q})$ is conjugated in $\text{STame}(\mathcal{Q})$ to :

$$E_H \rtimes \left\{ \left(\begin{array}{cc} ax & by \\ b^{-1}z & a^{-1}t \end{array} \right), a, b \in k^* \right\}.$$

Proof. Let us prove assertion (i). Since the group $\text{Tame}(\mathcal{Q})$ acts transitively on the set of vertices of type II, we are reduced to find the stabilizer of the vertex of type II given by $[x, y]$. It is clear that $E_V \rtimes \text{GL}_2 \subset \text{Stab}([x, y])$. Let us prove the reverse inclusion. Take an element f in the stabilizer $\text{Stab}([x, y])$ of this vertex. By definition, f is of the form :

$$f = \left(\begin{array}{cc} ax + by & cx + dy \\ f_3 & f_4 \end{array} \right),$$

where $\begin{pmatrix} a & b \\ c & d \end{pmatrix} \in \text{GL}_2(k)$ and where $f_2, f_4 \in k[\mathcal{Q}]$. Since the action of $\text{PGL}_2(k)$ is 2-transitive on \mathbb{P}^1 and since the vertices of type I contained in a square containing $[\text{Id}]$ are in bijection with the edges in the link $\mathcal{L}([\text{Id}])$ which in turn correspond to the points in H_∞ by Proposition 3.3.2.1, we can apply an automorphism $g \in \text{SO}_4$ which fixes the vertical line $\{[0, 1]\} \times \mathbb{P}^1$ at infinity such that $g \circ f$ is of the form :

$$g \circ f = \left(\begin{array}{cc} ax & by \\ f'_3 & f'_4 \end{array} \right),$$

where $a, b \in k^*$ and $f'_3, f'_4 \in k[\mathcal{Q}]$. We then apply Proposition 3.2.3.1, and $g \circ f \in E_V$. By construction g belongs to the stabilizer of the edge of type III joining $[\text{Id}]$ and $[x, y]$. By Proposition 3.3.2.4.(ii), this subgroup is isomorphic to GL_2 , hence we have an inclusion $\text{Stab}([x, y]) \subset E_V \rtimes \text{GL}_2$ as required.

Assertions (ii) and (iii) follow from the same arguments. □

3.3.4 Bass-Serre tree associated to plane automorphisms

We consider the field $K = k(x)$. We define the graph $\mathcal{T}_{k(x)}$ which is a bipartite metric graph.

1. Vertices of type I are equivalence classes of components $f_1 \in k(x)[y, z]$ of plane automorphisms where one identifies two components f_1 and g_1 if there exists $a \in k(x)^*$ and $b \in k(x)$ such that $f_1 = ag_1 + b$. An equivalence class induced by a component f_1 is denoted $[f_1]$.
2. Vertices of type II are equivalence classes of automorphisms f where one identifies two automorphisms f and g if there exists an affine automorphism h such that $f = h \circ g$ i.e there exists a matrix $M \in \text{GL}_3(k(x))$ of the form :

$$M = \begin{pmatrix} a & b & c \\ a' & b' & c' \\ 0 & 0 & 1 \end{pmatrix}$$

such that $(f_1, f_2) = (ag_1 + bg_2 + c, a'g_1 + b'g_2 + c)$ where $f = (f_1, f_2)$ and $g = (g_1, g_2)$. An equivalence class induced by a plane automorphism $f = (f_1, f_2)$ is denoted $[f_1, f_2]$

3. Edges link a point of type I v_1 with a point of type II v_2 if there exists a polynomial automorphism $f = (f_1, f_2)$ such that $[f_1] = v_1$ and $[f_1, f_2] = v_2$.

We endow this graph $\mathcal{T}_{k(x)}$ with the distance such that each edge is of length 1. This graph $\mathcal{T}_{k(x)}$ is thus a complete geodesic metric space.

The action of an automorphism $g \in \mathbb{A}_{k(x)}^2$ on $\mathcal{T}_{k(x)}$ is defined as follows :

$$g \cdot [f_1] = [f_1 \circ g^{-1}],$$

and

$$g \cdot [f_1, f_2] = [f_1 \circ g^{-1}, f_2 \circ g^{-1}]$$

for any automorphism $f = (f_1, f_2) \in \text{Aut}(\mathbb{A}_{k(x)}^2)$.

A classical theorem from Jung ([Jun42]) proves that the graph $\mathcal{T}_{k(x)}$ is a tree and that the group of plane automorphism acts faithfully, by isometry and transitively on the set of type I and II vertices respectively.

3.3.5 Link over a vertex of type I

In this subsection, we study the link over the vertex of type I given by $[x]$.

Observe that the stabilizer subgroup of the vertex $[x]$ acts naturally in the link of the vertex $[x]$.

Lemma 3.3.5.1. *The group $\text{Stab}([x])$ acts transitively, faithfully in the link of $[x]$.*

Proof. By Proposition 3.3.2.3.(v), the group $\text{STame}(\mathcal{Q})$ acts transitively on the set of 1×1 squares and since a 1×1 square containing $[x]$ defines an edge in the link $\mathcal{L}([x])$, the induced action of $\text{Stab}([x])$ is transitive on the edges of the link $\mathcal{L}([x])$. Observe also that the involution $\sigma : (x, y, z, t) \mapsto (x, z, y, t)$ induces an action on the link which exchanges the vertices $[x, y]$, $[x, z]$ in the link and fixes the edge between these two vertices. This proves that the action of the stabilizer $\text{Stab}([x])$ is transitive on the link of $[x]$.

Let us prove that the action is faithful. Suppose $f \in \text{Stab}([x])$ acts by the identity map in the link over $[x]$, then in particular, f must fix pointwise the square containing $[\text{Id}]$ and $[x]$. By Proposition 3.3.2.4.(iii), f is of the form :

$$f = \begin{pmatrix} ax & d^{-1}(y + bx) \\ d(z + cx) & a^{-1}(t + cy + bz + bcx) \end{pmatrix},$$

where $a, d \in k^*$ and $b, c \in k$. Since f must also fix the vertices of type II $[x, y + xP(x)]$ and $[x, z + xP(x)]$ where $P \in k[x]$, we have that $a = d = 1$ and $c = b = 0$ as required. \square

In the following arguments, we will use the fact that the link $\mathcal{L}([x])$ is connected ([BFL14, Lemma 3.2]), which is a highly non-trivial argument which relies deeply on the reduction theory inspired by the work of Shostakov-Umirbaev (see [BFL14, Corollary 1.5]).

Recall that the general fiber of the projection $\pi_x : \mathcal{Q} \rightarrow \mathbb{A}^1$ defined in Section 3.2.3 is isomorphic to \mathbb{A}^2 . We fix an identification of $\pi_x^{-1}(\mathbb{A}^1 \setminus \{0\})$ with $\mathbb{A}^1 \setminus \{0\} \times \mathbb{A}^2$ given by :

$$(x, y, z) \mapsto (x, y, z, (yz + 1)/x). \tag{3.6}$$

The relationship between the stabilizer of the vertex $[x]$ and $\text{Aut}(\mathbb{A}_{k(x)}^2)$ is realized explicitly as follows.

Denote by $\mathcal{L}([x])'$ the first barycentric division of $\mathcal{L}([x])$. We shall define a simplicial map $\pi : \mathcal{L}([x])' \rightarrow \mathcal{T}_{\mathbf{k}(x)}$ as follows.

Let v be a vertex of type II in \mathcal{C} which defines a vertex in the link of $[x]$, then since the action of $\text{Stab}([x])$ on the link $\mathcal{L}([x])$ is transitive by Lemma 3.3.5.1, there exists an element $f \in \text{Stab}([x])$ such that $f \cdot [x, y] = v$. Since f naturally fixes the fibration π_x , under the identification $\pi_x^{-1}(\mathbb{A}^1 \setminus \{0\}) \simeq \mathbb{A}^1 \setminus \{0\} \times \mathbb{A}^2$ given by (3.6), the regular map f is given by :

$$(x, y, z) \mapsto (x \circ f, y \circ f, z \circ f).$$

Under this identification, $(y \circ f, z \circ f)$ induces an element of $\mathbb{A}_{\mathbf{k}(x)}^2$. We thus define

$$\pi(v) = [y \circ f] \in \mathcal{T}_{\mathbf{k}(x)}.$$

Observe that $\pi(v)$ does not depend on the choice of f . Indeed, if $g \in \text{Stab}([x])$ is another automorphism such that $g \circ [x, y] = v$, then by Proposition 3.3.2.4.(ii), the composition $g \circ f^{-1}$ satisfies :

$$g \circ f^{-1} \in E_{\mathbb{H}} \rtimes \left\{ \left(\begin{array}{cc} ax & d^{-1}y \\ dz + cx & at + ca^{-1}d^{-1}y \end{array} \right) \mid (a, c, d) \in \mathbf{k}^* \times \mathbf{k} \times \mathbf{k}^* \right\},$$

hence $[y \circ g] = [y \circ f] \in \mathcal{T}_{\mathbf{k}(x)}$.

Let $m \in \mathcal{L}([x])'$ be the middle point of an edge E of $\mathcal{L}([x])$ and let m_0 be the middle point of the geodesic joining $[x, y]$ and $[x, z]$ in $\mathcal{L}([x])'$. Since the action of $\text{Stab}([x])$ in the link $\mathcal{L}([x])$ is transitive by Lemma 3.3.5.1, there exists an element $f \in \text{Stab}([x])$ such that $f \circ m_0 = m$. Since f naturally fixes the fibration π_x , it induces an automorphism of $\pi_x^{-1}(\mathbb{A}^1 \setminus \{0\})$ and under the identification given by (3.6), it is of the form

$$(x, y, z) \mapsto (x \circ f, y \circ f, z \circ f).$$

We thus define :

$$\pi(m) = [y \circ f, z \circ f].$$

Observe also that $\pi(m)$ does not depend on the choice of f . If $g \in \text{Stab}([x])$ such that $g \cdot m_0 = m$, then g and f differ by an element which belongs to the subgroup :

$$\left\{ \left(\begin{array}{cc} ax & b(y + cx) \\ b^{-1}(z + dx) & a^{-1}(t + dy + cz + cdx) \end{array} \right) \mid a, b \in \mathbf{k}^*, c, d \in \mathbf{k} \right\} \rtimes \left\{ \text{Id}, \left(\begin{array}{cc} x & z \\ y & t \end{array} \right) \right\},$$

hence $[y \circ g, z \circ g] = [y \circ f, z \circ f] \in \mathcal{T}_{\mathbf{k}(x)}$ and $\pi(m)$ is well-defined.

If E is an edge of $\mathcal{L}([x])'$ of length 1, then we define the image of E by π as the geodesic joining the image of the endpoints of E by π . As a result, the map π is a simplicial map between $\mathcal{L}([x])'$ and $\mathcal{T}_{\mathbf{k}(x)}$ such that the action of $\text{Stab}([x])$ descends into an action on $\mathcal{T}_{\mathbf{k}(x)}$ (one can prove that $\pi : \mathcal{L}([x])' \rightarrow \mathcal{T}_{\mathbf{k}(x)}$ is the unique $\text{Stab}([x])$ -equivariant map for which $\pi([x, y]) = [y]$ and $\pi([x, z]) = [z]$).

Definition 3.3.5.2. *The subgroup $A_{[x]}$ is the intersection of $\text{STame}(\mathcal{Q})$ with the kernel of the morphism induced by the $\text{Stab}([x])$ -equivariant simplicial map $\pi : \mathcal{L}([x])' \rightarrow \mathcal{T}_{\mathbf{k}(x)}$.*

Remark 3.3.5.3. Equivalently,

Proposition 3.3.5.4. *Denote by $m \in \mathcal{L}([x])'$ the middle point between the point $[x, y]$ and $[x, z]$. The simplicial map $\pi : \mathcal{L}([x])' \rightarrow \mathcal{T}_{\mathbf{k}(x)}$ satisfies the following properties.*

- (i) *The image of the edge between the point $[x, y]$ and m by π is a fundamental domain of $\mathcal{T}_{\mathbf{k}(x)}$.*

- (ii) The image $\pi(\mathcal{L}([x])')$ is a subtree of $\mathcal{T}_{k(x)}$.
- (iii) The preimage by π of the segment of length 2 joining $[z]$ and $[y]$ is a bipartite graph.
- (iv) The subgroup $A_{[x]} \subset \text{Stab}([x]) \cap \text{STame}(\mathcal{Q})$ is generated by elements of the form :

$$\left(\begin{array}{cc} ax & b(y + xP(x)) \\ b^{-1}(z + xS(x)) & a^{-1}(t + zP(x) + yS(x) + xP(x)S(x)) \end{array} \right),$$

where $P, S \in k[x]$ and $a, b \in k^*$.

Proof. Let us prove assertion (i). The image of m is the point of type II given by [Id] and the image of $[x, y]$ is the point of type I given by $[y]$. Since the edge between [Id] and $[y]$ is a fundamental domain of the Bass-Serre tree, assertion (i) holds.

Since π is a simplicial map and since the link $\mathcal{L}([x])$ is connected, its image by π is a subtree of $\mathcal{T}_{k(x)}$, hence assertion (ii) holds.

We prove assertion (iii). Denote by E the segment joining $[y]$ and $[z]$ in $\mathcal{T}_{k(x)}$. We distinguish two type of vertices in $\mathcal{L}([x])$. For any vertex $v \in \mathcal{L}([x])$, either the edge joining $[x]$ and v is vertical, either it is horizontal. Take two vertices $[x, f_2], [x, f_3]$ of $\mathcal{L}([x])$ such that $\pi([x, f_2]) = [y]$ and $\pi([x, f_3]) = [z]$. We prove that there is an edge between $[x, f_2]$ and $[x, f_3]$ in the link. By definition, there exists $P, S \in k(x)$ and $a, b \in k(x)^*$ such that

$$f_2 = a(x)y + P(x),$$

$$f_3 = b(x)z + S(x).$$

Since $f_2, f_3 \in k[\mathcal{Q}]$ are regular functions, this implies that $a, b \in k[x]$ and $P, S \in k[x]$. Moreover, since (x, f_2) is a component of an automorphism, there exists $g_3, g_4 \in k[\mathcal{Q}]$ such that the component (x, f_2, g_3, g_4) defines a tame automorphism. Since the volume form Ω must be fixed, this implies that :

$$a(x)\partial_z g_3 = 1.$$

This implies in particular that $a \in k^*$ and $g_3 = a^{-1}z + h$ where $h \in k[\mathcal{Q}]$ where $\partial_z h = 0$. This implies that the function g_4 is given by :

$$g_4 = t + a^{-1}z \frac{P(x)}{x} + ay \frac{h}{x}.$$

In particular, since g_4 is regular, we have that x must divide P and f_2 is of the form :

$$f_2 = ay + xR(x),$$

where $R \in k[x]$. We have thus proven that the vertex $[x, f_2]$ is of the form $[x, y + xR(x)]$. Similarly, one proves that the vertex $[x, f_3]$ is of the form $[x, z + xS'(x)]$ where $S' \in k[x]$.

Clearly, the morphism given by :

$$f = \left(\begin{array}{cc} x & y + xR(x) \\ z + xS'(x) & t + zR(x) + yS'(x) + xR(x)S'(x) \end{array} \right)$$

defines a tame automorphism and there is an edge between $[x, f_2]$ and $[x, f_3]$ as required.

Let us prove the statement (iv). Let us denote by $\phi : \text{Stab}([x]) \rightarrow \text{Aut}(\mathbb{A}_{k(x)}^2)$ the morphism of groups induced by the simplicial map $\pi : \mathcal{L}([x])' \rightarrow \mathcal{T}_{k(x)}$. It is clear that any element of the form :

$$\left(\begin{array}{cc} ax & b(y + xP(x)) \\ b^{-1}(z + xS(x)) & a^{-1}(t + zP(x) + yS(x) + xP(x)S(x)) \end{array} \right),$$

where $P, S \in k[x]$ and $a, b \in k^*$ induces the identity on $\mathcal{T}_{k(x)}$. Conversely, we prove that any element of $A_{[x]}$ has this form. Pick $g \in A_{[x]}$, since $\phi(g)$ fixes every vertices of $\mathcal{T}_{k(x)}$, $\phi(g)$ is an affine automorphism of $\mathbb{A}^2(k(x))$. As $\phi(g)$ fixes every vertex of type I and since it belongs to the image of ϕ , the plane automorphism $\phi(g)$ must be of the form :

$$\phi(g) = (y, z) \rightarrow (b(y + xP(x)), c(z + xS(x))),$$

where $P, S \in k[x]$ and where $b, c \in k^*$. In particular, as $g \in \text{Tame}(\mathbb{Q})$, $b = c^{-1}$ and g is of the form :

$$\left(\begin{array}{cc} ax & b(y + xP(x)) \\ b^{-1}(z + xS(x)) & a^{-1}(t + zP(x) + yS(x) + xP(x)S(x)) \end{array} \right),$$

proving (iv). □

3.3.6 2×2 squares centered along each vertices

We say that a subset $S \subset \mathcal{C}$ is a 2×2 square of \mathcal{C} if S is the union of four distinct 1×1 squares such that S isometric to $[0, 2] \times [0, 2]$. Moreover, we say that a 2×2 square is centered on a vertex v if the vertex v corresponds to the image of the point $(1, 1)$ by an isometry from $[0, 2] \times [0, 2]$ to S .

Two 1×1 (resp. 2×2) squares S, S' are said to be **adjacent** if their union $S \cup S'$ is isometric to $[0, 2] \times [0, 1]$ (resp. $[0, 4] \times [0, 2]$). Two 1×1 squares S and S' are adjacent along a vertical (resp. horizontal) edge if they are adjacent and their intersection $S \cap S'$ is a vertical edge (resp. horizontal).

Two 1×1 (resp. 2×2) squares S_1 and S_2 are said to be **adherent** if they are not adjacent but their intersection is reduced to a vertex which does not belong to the interior of each square. If a vertex $v \in \mathcal{C}$ belongs to the intersection of two adherent squares $S_1 \cap S_2$, then S_1 and S_2 are said to be adherent along the vertex v .

We say that two 1×1 (resp. 2×2) squares S, S' are **flat** if there exists two 1×1 (resp. 2×2) squares S_1, S_2 such that the union $S_1 \cup S_2 \cup S \cup S'$ is isometric to $[0, 2] \times [0, 2]$ (resp. $[0, 4] \times [0, 4]$). Similarly, three 1×1 (resp. 2×2) squares are flat if we can find another 1×1 (resp. 2×2) square such that their union is isometric to $[0, 2] \times [0, 2]$ (resp. $[0, 4] \times [0, 4]$).

We will prove that three 1×1 squares S_1, S_2, S_3 such that S_1 and S_2, S_2 and S_3 are adjacent and contain a common vertex of type II or III are necessarily flat (see Lemma 3.3.6.2 and Lemma 3.3.6.1 below). However, this property fails when the squares contain a common vertex of type I (see Lemma 3.3.6.3 below). Therefore, we need to give an appropriate terminology.

A collection (S, S') of 1×1 or 2×2 squares is **vertically gallery connected** if they contain a common vertex v of type I and there exists a sequence of adjacent squares $S_1 = S, \dots, S_k = S'$ such that the following conditions are satisfied :

1. for all integer $i \leq k - 1$, the squares S_i and S_{i+1} are alternatively adjacent along a vertical or horizontal edge containing v ;
2. the first two squares S_1 and S_2 are adjacent along a vertical edge containing v ;

One also defines **horizontally gallery connected** squares by symmetry.

A collection (S, S') of 1×1 or 2×2 squares is contained in a **vertical spiral staircase** (see 3.3.6.5 for an example) if the collection (S, S') is vertically gallery connected and such that in any minimal the sequence $S_1 = S, \dots, S_k = S'$ of squares connecting S to S' , any three consecutive squares (S_i, S_{i+1}, S_{i+2}) for $i \leq k - 2$ is not flat. When two squares S, S' are flat, then the collection (S, S') is not contained in a spiral staircase.

We will see that two squares S, S' which are adherent along a vertex of type I are either flat or the pair (S, S') is contained in a vertical or horizontal spiral staircase (see Lemma 3.3.6.4).

The next lemmas describe when three squares containing a common vertex are flat.

Lemma 3.3.6.1. *Let v be a vertex of type III and let S_1, S_2, S_3 be three distinct 1×1 squares such that S_1 is adjacent to S_2 along an edge containing v , and S_2 is adjacent to S_3 along an edge containing v . Then the three squares can be completed into a 2×2 square centered along v .*

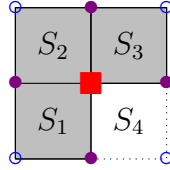
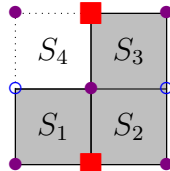

FIGURE 3.2 –

Proof. Since the group acts transitively on the vertices of type III by Proposition 3.3.2.3, we can suppose that the vertex $[\text{Id}]$ is a common point of the three squares. By Proposition 3.3.2.1.(i) and (ii), the three squares determine 3 distinct points p_1, p_2, p_3 at infinity such that p_1 and p_2 are on a same line at infinity L_{12} , and p_2, p_3 lie on another line L_{23} which is transverse to L_{12} . The point p_4 is the intersection of the line L passing through p_1 which is transverse to the line L_{12} with the line L' which is passes through p_3 and which is transverse to the line L_{23} . This point determines a unique square S_4 containing $[\text{Id}]$ by Proposition 3.3.2.1.(ii) and the union $S_1 \cup S_2 \cup S_3 \cup S_4$ is isometric to $[0, 2] \times [0, 2]$ as required. \square

Lemma 3.3.6.2. *Let v be a vertex of type II and let S_1, S_2, S_3 be three distinct 1×1 squares such that S_1 is adjacent to S_2 along an edge containing v , and S_2 is adjacent to S_3 along an edge containing v . Then the three squares can be completed into a 2×2 square centered along v .*



Proof. By transitivity on the vertices of type III and since the group PGL_2 acts 2 transitively on \mathbb{P}^1 , we reduce to the case where the squares S_1 and S_2 contain $[\text{Id}]$ and the points $[x]$ and $[y]$ respectively. Let f be a the tame automorphism such that the vertex $[f]$ belongs to S_3 . By composing with an element of SO_4 , we can suppose that f is of the form :

$$f = \begin{pmatrix} ax & by \\ f_3 & f_4 \end{pmatrix},$$

where $a, b \in k^*$ and $f_3, f_4 \in k[\mathcal{Q}]$. By Proposition 3.2.3.1, $f \in E_V$ is of the form :

$$f = \begin{pmatrix} ax & by \\ b^{-1}(z + xP(x, y)) & a^{-1}(t + yP(x, y)) \end{pmatrix},$$

where $P \in k[x, y]$. We are thus in the following situation :

If σ is the involution $\sigma : (x, y, z, t) \rightarrow (y, x, -t, -z)$, then $f \circ \sigma = \sigma \circ f$, and this proves that S_4 is the square containing the points $[x, y]$, $[y]$, $[f']$ and $[y, t + yP(x, y)]$ and the union $S_1 \cup S_2 \cup S_3 \cup S_4$ is isometric to $[0, 2] \times [0, 2]$, as required. \square

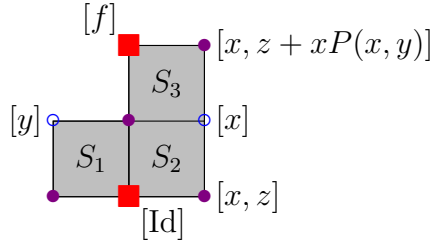

Lemma 3.3.6.3. *Let v be a vertex of type I and let S, S_1, S_2 be three distinct 1×1 squares such that S is adjacent to S_1 along an edge containing v , and S is adjacent to S_2 along an edge containing v . Let g_1 and $g_2 \in \text{STame}(\mathcal{Q})$ such that $g_1S = S_1$ and $g_2S = S_2$. Then the three squares can be completed into a 2×2 square centered along v if and only if g_1 or g_2 belongs to A_v .*

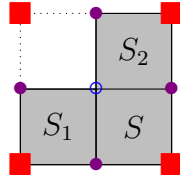

Proof. Since the group $\text{STame}(\mathcal{Q})$ is transitive on the set of 1×1 squares, we can suppose that the common vertex v is $[x]$ and that S_2 contains the vertex $[\text{Id}]$. We are thus in the following situation :

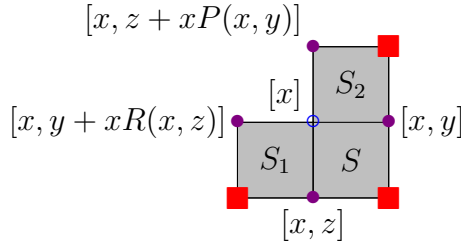

where $P, R \in k[x, y]$.

Let us prove the first implication (\Rightarrow). Suppose that the squares S_1, S_2, S_3 are flat. Then there exists a component $f_4 \in k[\mathcal{Q}]$ such that the element f given by :

$$f = \begin{pmatrix} x & y + xR(x, z) \\ z + xP(x, y) & f_4 \end{pmatrix}$$

belongs to $\text{Tame}(\mathcal{Q})$. In particular, it must fix the volume form Ω , this implies that :

$$\partial_y P(x, y) \partial_z R(x, z) = 0 \in k[\mathcal{Q}].$$

This implies that $\partial_y P(x, y) = 0$ or $\partial_z R(x, z) = 0$ hence g_1 or g_2 belongs to $A_{[x]}$ as required.

We prove the reverse implication (\Leftarrow). By symmetry, we can suppose that $g_1 \in A_{[x]}$ and $R \in k[x]$. Consider the automorphism $h \in \text{Tame}(\mathcal{Q})$ given by :

$$h = \begin{pmatrix} x & y + xR(x) \\ z + xP(x, y) & t + xP(x, y)R(x) + yP(x, y) + zR(x) \end{pmatrix},$$

then $[h]$ defines a vertex of type III and is contained in a square S_4 such that the union $S_1 \cup S_2 \cup S_3 \cup S_4$ is isometric to the euclidean square $[0, 2] \times [0, 2]$ as required. \square

Lemma 3.3.6.4. *Take S and S' two 2×2 squares centered at a vertex of type III which are adherent along a vertex of type I. Then S and S' satisfy one of the following properties.*

- (i) *Either the pair (S, S') is flat.*
- (ii) *Either the pair of squares (S, S') is contained in a horizontal or vertical spiral staircase.*

Proof. Consider two squares S, S' such that the pair of square (S, S') is not flat. Up to a conjugation by an element of $\text{STame}(\mathcal{Q})$, we can suppose that S and S' are adherent along $[x]$. Since the group $\text{Tame}(\mathcal{Q})$ acts transitively the set of 2×2 squares centered on type III vertices by Proposition 3.3.2.3.(vi), there exists an element $g \in \text{STame}(\mathcal{Q})$ such that $g \cdot S = S'$. Choose a minimal sequence S_i of adjacent 2×2 squares centered along a vertex of type III containing $[x]$ such that $S_1 = S, \dots, S_k = S'$. Since the sequence of square is minimal, the square S_i and S_{i+2} are adherent along the vertex $[x]$ but not flat. Moreover, the squares S_i and S_{i+1} are alternatively adjacent along vertical and horizontal edges. Hence the pair (S, S') is contained in a horizontal or vertical spiral staircase, as required. \square

Example 3.3.6.5. Consider $P_1, P_2, P_3 \in \mathbb{k}[x, y] \setminus \mathbb{k}[x]$, denote by S the square containing $[x]$ and $[\text{Id}]$ and S' the square containing $[x]$ and $[f]$ where $f \in \text{Tame}(\mathcal{Q})$ is given by :

$$f = \begin{pmatrix} x & y + xP_1(x, y) + xP_3(x, z + xP_2(x, y + xP_1(x, y))) \\ z + xP_2(x, y + xP_1(x, y)) & f_4 \end{pmatrix},$$

where $f_4 = t + y(P_1(x, y) + P_3(x, z + xP_2(x, y + xP_1(x, y)))) + yP_2(x, y + xP_1(x, y)) + x(P_1(x, y) + P_3(x, z + xP_2(x, y + xP_1(x, y))))P_2(x, y + xP_1(x, y))$. Then the pair (S, S') is contained in a horizontal spiral staircase and one has the following figure :

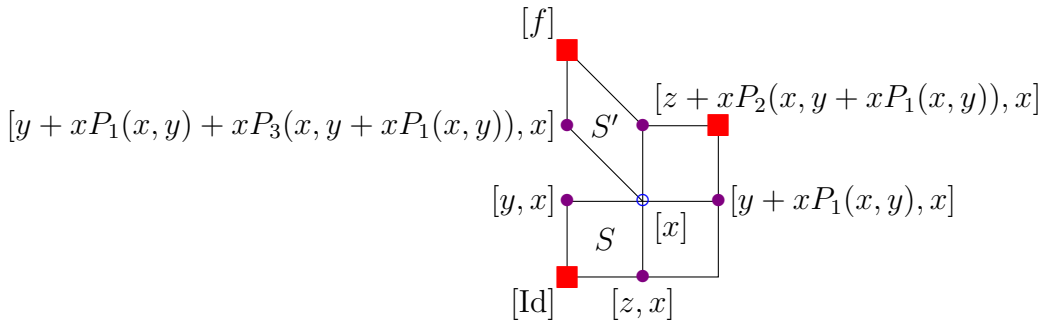

FIGURE 3.3 – Example of spiral staircase.

In practice, we will need the following technical lemma :

Lemma 3.3.6.6. *Consider two 2×2 adjacent squares S_1, S_2 along a horizontal edge containing $[x_1], [y_1]$ and a polynomial $P \in \mathbb{k}[x, y] \setminus \mathbb{k}$. Denote by $[z_1], [t_1]$ the other vertices of S_1 such that $[x_1], [z_1]$ belong to a vertical edge of S_1 and by $[z_1 + x_1P(x_1, y_1)], [t_1 + y_1P(x_1, y_1)]$ the vertices of S_2 . Let g be the tame automorphism defined by*

$$g = \begin{pmatrix} x & y \\ z + xP(x, y) & t + yP(x, y) \end{pmatrix}$$

so that $g \cdot S_1 = S_2$.

The following assertions hold.

- (i) *We have $g \in A_{[x_1]}$ if and only if $P \in \mathbb{k}[x] \setminus \mathbb{k}$.*

(ii) For any square S' adjacent to S_1 along the vertical edge containing $[x_1], [z_1]$, the squares S_1, S', S_2 are flat if and only if $P \in \mathbb{k}[x] \setminus \mathbb{k}$.

The following figure summarizes the situation :

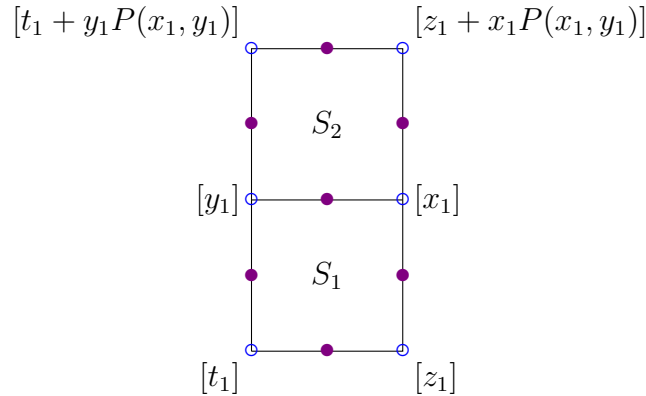

Proof. By conjugation, we can suppose that $x_1 = x, y_1 = y, z_1 = z$ and $t_1 = t$. Assertion (i) follows directly from the definition of $A_{[x]}$.

Let us prove assertion (ii). Choose a square S' such that $g'S_1 = S'$ where $g' \notin A_{[x]}$. Lemma 3.3.6.3 implies that the squares S_1, S_2, S' are flat if and only if $g \in A_{[x]}$. And $g \in A_{[x]}$ is equivalent to the fact that $P \in \mathbb{k}[x] \setminus \mathbb{k}$ by assertion (i). \square

3.4 Valuative estimates

This section is devoted to the generalization of the so-called parachute inequalities (see [BFL14, Minoration A.2]). Our proof extends the method of [LV13] to more general valuations.

3.4.1 Valuations on affine and projective varieties

Let X be an affine variety of dimension n over \mathbb{k} . By convention for us, a valuation on X is a map $\nu : \mathbb{k}[X] \rightarrow \mathbb{R} \cup \{+\infty\}$ which satisfies the following properties.

1. We have $\nu^{-1}(\{+\infty\}) = \{0\}$.
2. The function ν is not constant on $\mathbb{k}[X] \setminus \{0\}$.
3. For any $a \in \mathbb{k}^*$, one has $\nu(a) = 0$.
4. For any $f_1, f_2 \in \mathbb{k}[X]$, one has $\nu(f_1 f_2) = \nu(f_1) + \nu(f_2)$.
5. For any $f_1, f_2 \in \mathbb{k}[X]$, one has $\nu(f_1 + f_2) \geq \min(\nu(f_1), \nu(f_2))$.

When the subset $\nu^{-1}(\{+\infty\})$ is not reduced to $\{0\}$, we say that ν is a semi-valuation.

We endow the space of valuations with the coarsest topology for which all evaluation maps $\nu \mapsto \nu(f)$ are continuous where $f \in \mathbb{k}[X]$.

The group \mathbb{R}_+^* naturally acts on the set of valuations by multiplication.

The main examples of valuations are monomial valuations. We recall their definition below. Fix a point p on X , an algebraic system of coordinates $u = (u_0, \dots, u_{n-1})$ at this point and some weights $\alpha = (\alpha_1, \dots, \alpha_n) \in \mathbb{R}^n$. We shall denote by $u^I = \prod_{j=0}^{n-1} u_j^{i_j}$ when $I = (i_0, \dots, i_{n-1}) \in \mathbb{N}^n$ and by $\langle I, \alpha \rangle = \alpha_0 i_0 + \dots + \alpha_{n-1} i_{n-1}$ the usual scalar product. The monomial valuation ν with weight α with respect to the system of coordinates u is defined by :

$$\nu \left(\sum_{I \in \mathbb{N}^n} a_I u^I \right) = \min \{ \langle I, \alpha \rangle \mid a_I \neq 0 \},$$

where $a_I \in k$.

When $f \in \mathcal{O}_{p,X}$ is a regular function at the point p , then one defines $\nu(f)$ as :

$$\nu(f) = \nu\left(\sum a_I(f)u^I\right),$$

where $\sum a_I(f)u^I$ is a formal expansion of f near p . The fact that $\nu(f)$ does not depend on the choice of the formal expansion of f near p is proved in [JMta12, Proposition 3.1].

Observe that when $\alpha = (1, 0, \dots, 0)$, then the associated valuation coincides with the order of vanishing along $\{u_0 = 0\}$. Observe also that when $X = \text{Spec}(k[x, y, z, t])$, the valuation $-\text{deg}$ coincides with the monomial valuation with weight $(-1, -1, -1, -1)$ with respect to (x, y, z, t) .

Consider a regular morphism $f : X \rightarrow Y$ where Y is an affine variety and a valuation ν on X . The pushforward of the valuation ν on X by f is denoted $f_*\nu$ is given by the formula :

$$f_*\nu = \nu \circ f^\#,$$

where $f^\#$ denotes the morphism of k -algebra corresponding to f .

We also recall the notion of center of a valuation ν .

When $\nu|_{k[X]} \geq 0$, then the center of ν in X , denoted $Z(\nu)$, is the scheme theoretic point corresponding to the prime ideal $\{f_1 \in k[X] \mid \nu(f_1) > 0\}$. When this condition does not hold, there exists a regular function f_1 such that $\nu(f_1) < 0$ and we say that ν is centered at infinity. In the latter case, for any projective variety \bar{X} containing X as a Zariski open subset, the center of ν in \bar{X} is a non-empty Zariski closed irreducible subset which is contained in $\bar{X} \setminus X$. Denote by R_ν the valuation ring and by \mathcal{M}_ν its maximal ideal, then the center $Z(\nu)$ of ν in \bar{X} can be defined as follows :

$$Z(\nu) = \{p \in \bar{X} \mid \mathcal{O}_{p,\bar{X}} \subset R_\nu, \mathcal{M}_{p,\bar{X}} = \mathcal{M}_\nu \cap \mathcal{O}_{p,\bar{X}}\},$$

where $\mathcal{O}_{p,\bar{X}}$ denotes the local ring of regular functions at the point p and where $\mathcal{M}_{p,\bar{X}}$ is its maximal ideal. The fact that $Z(\nu)$ is non-empty follows from the valuative criterion of properness and we shall refer to [Vaq00] for the general properties of this set.

Example 3.4.1.1. The center of the valuation $-\text{deg} : k[\mathcal{Q}] \rightarrow \mathbb{R}^- \cup \{+\infty\}$ in $\bar{\mathcal{Q}}$ is the hyperplane $H_\infty = \bar{\mathcal{Q}} \setminus \mathcal{Q}$ at infinity.

3.4.2 Valuations \mathcal{V}_0 on the quadric

We denote by $q \in k[x, y, z, t]$ the polynomial $q = xt - yz$ and by $\pi : k[x, y, z, t] \rightarrow k[\mathcal{Q}]$ the canonical projection. Our objective is to define a subset of the set of all valuations on the quadric \mathcal{Q} .

Take a point $p = (x_0, y_0, z_0, t_0) \in \mathbb{A}^4$ and a weight $\alpha = (\alpha_0, \alpha_1, \alpha_2, \alpha_3) \in (\mathbb{R}^-)^4$, we write by ν_p^α the monomial valuation on $k[x, y, z, t]$ with weight α with respect to the system of coordinates $(x - x_0, y - y_0, z - z_0, t - t_0)$.

Proposition 3.4.2.1. *For any point $p \in \mathbb{A}^4$ and any weight $\alpha = (\alpha_0, \alpha_1, \alpha_2, \alpha_3) \in (\mathbb{R}^- \setminus \{0\})^4$ such that $\alpha_0 + \alpha_3 = \alpha_2 + \alpha_1$, the map $\nu : k[\mathcal{Q}] \rightarrow \mathbb{R}^- \cup \{+\infty\}$ given by :*

$$\nu(f) := \sup \{ \nu_p^\alpha(R) \mid R \in k[x, y, z, t], \pi(R) = f \},$$

for any $f \in k[\mathcal{Q}]$ is a valuation on the quadric which is centered at infinity.

Moreover, suppose $p = (x_0, y_0, z_0, t_0) \in \mathbb{A}^4$ and $\nu' : k[\mathcal{Q}] \rightarrow \mathbb{R}^- \cup \{+\infty\}$ is a valuation such that $\nu(\pi(x - x_0)) = \nu'(\pi(x - x_0))$, $\nu(\pi(y - y_0)) = \nu'(\pi(y - y_0))$, $\nu(\pi(z - z_0)) = \nu'(\pi(z - z_0))$ and $\nu(\pi(t - t_0)) = \nu'(\pi(t - t_0))$, then

$$\nu'(f) \geq \nu(f),$$

for any regular function $f \in k[\mathcal{Q}]$.

Definition 3.4.2.2. The set \mathcal{V}_0 is set of all valuations $\nu : k[\mathcal{Q}] \rightarrow \mathbb{R}^- \cup \{+\infty\}$ defined by

$$\nu(f) := \sup\{\nu_p^\alpha(R) \mid \pi(R) = f\},$$

for any $f \in k[\mathcal{Q}]$ where $p \in k^4$ and where $\alpha = (\alpha_0, \alpha_1, \alpha_2, \alpha_3) \in (\mathbb{R}^- \setminus \{0\})^4$ is a multi-index for which $\alpha_0 + \alpha_3 = \alpha_1 + \alpha_2$.

Recall also that the group $\mathbb{R}^{+,*}$ acts naturally by multiplication on the set of valuations on the quadric. This action induces an action on \mathcal{V}_0 and we thus define the normalized subset of valuations $\hat{\mathcal{V}}_0$ as follows :

$$\hat{\mathcal{V}}_0 = \{\nu \in \mathcal{V}_0 \mid \min(\nu(\pi(x)), \nu(\pi(y)), \nu(\pi(z)), \nu(\pi(t))) = -1\}.$$

By construction, $\hat{\mathcal{V}}_0$ can be identified with the image of \mathcal{V}_0 by the quotient map by the action of the group $\mathbb{R}^{+,*}$.

Remark 3.4.2.3. Observe that for $x_0 = y_0 = z_0 = t_0 = 0$ and $\alpha_1 = \alpha_2 = \alpha_3 = \alpha_4 = -1$, the corresponding valuation on the quadric is the order of vanishing along the hyperplane at infinity.

Example 3.4.2.4. Consider $p = (0, 0, 0, 0)$ and $\alpha = (-1/2, -3/5, -9/10, -1)$, then the associated valuation ν is the monomial valuation at the point $[0, 0, 0, 1, 0] \in \overline{\mathcal{Q}}$ with weight $(2/5, 1/10, 1)$ with respect to the coordinate chart $(u, v, w) \mapsto [w^2 + uv, u, v, 1, w] \in \overline{\mathcal{Q}}$. In particular, its center is the point $[0, 0, 0, 1, 0] \in \overline{\mathcal{Q}}$.

Example 3.4.2.5. Consider $p = (1, 2, 3, 4)$ and $\alpha = (-1/2, -3/5, -9/10, -1)$, then the associated valuation ν is the monomial valuation at the point $[6, 2, 3, 1, 0] \in \overline{\mathcal{Q}}$ with weight $(2/5, 1/10, 1)$ with respect to the coordinate chart $(u, v, w) \mapsto [w^2 + (2+u)(3+v), 2+u, 3+v, 1, w] \in \overline{\mathcal{Q}}$. In particular, its center is the point $[6, 2, 3, 1, 0] \in \overline{\mathcal{Q}}$.

To prove the proposition, we shall need the following technical lemma.

Lemma 3.4.2.6. Let $\nu' : k[x, y, z, t] \rightarrow \mathbb{R}^- \cup \{+\infty\}$ be a valuation such that $\nu'_{|_{k[x,y,z,t] \setminus k}} < 0$. For any polynomial $R \in k[x, y, z, t]$ given by

$$R = \sum_{ijkl} a_{ijmn} x^i y^j z^m t^n,$$

with $a_{ijmn} \in k$, the following assertions are equivalent :

- (i) There exists a polynomial $R_1 \in k[x, y, z, t]$ such that $\pi(R_1) = \pi(R) \in k[\mathcal{Q}]$ and such that $\nu'(R_1) > \nu'(R)$.
- (ii) The polynomial q divides R^w where R^w is the homogeneous polynomial given by :

$$R^w = \sum_{i\nu'(x)+j\nu'(y)+m\nu'(z)+n\nu'(t)=\nu'(R)} a_{ijmn} x^i y^j z^m t^n.$$

Proof. The implication (ii) \Rightarrow (i) is straightforward. If $q|R^w$ then we can decompose R as :

$$R = qR_1 + S,$$

where $R_1, S \in k[x, y, z, t]$ such that $\nu'(S) > \nu'(qR_1)$. Hence $\pi(R_1 + S) = \pi(R)$ and $\nu'(R_1 + S) \geq \min(\nu'(R_1), \nu'(S)) > \nu'(R)$ as required.

Let us prove the implication (i) \Rightarrow (ii). Take a polynomial R_1 which satisfies (i). Then we can write :

$$R_1 = R + (q-1)S,$$

where $S \in k[x, y, z, t]$. Let us prove that $R^w + qS^w = 0$. Observe that $\nu'(R_1) > \nu'(R)$ implies that $\nu'(qS) = \nu'(R)$. Let us suppose by contradiction that $R^w + qS^w \neq 0$. This implies that $\nu'(R_1^w) = \nu'(R^w + qS^w) = \nu'(R^w)$ which also contradicts our assumption. Hence $R^w + qS^w = 0$ and $q|R^w$ as required. \square

Observe that Lemma 3.4.2.6 implies that the supremum $\nu(f)$ in Proposition 3.4.2.1 is a maximum which is reached on a value $R \in \mathbb{k}[x, y, z, t]$ such that $\pi(R) = f$ and such that q does not divide R^w .

Proof of Proposition 3.4.2.1. Fix $p \in \mathbb{k}^4$ and $\alpha \in (\mathbb{R}^- \setminus \{0\})^4$. Observe that for any $f_1 \in \mathbb{k}[\mathcal{Q}]$, the value $\nu(f_1)$ is smaller or equal than 0. If $a \in \mathbb{k}^*$, the above remark proves that $\nu(a) = \nu'(a) = 0$.

Fix $f_1, f_2 \in \mathbb{k}[\mathcal{Q}]$ and let us prove that $\nu(f_1 + f_2) \geq \min(\nu(f_1), \nu(f_2))$. Take $R_1, R_2 \in \mathbb{k}[x, y, z, t]$ such that $\nu'(R_1) = \nu(\pi(R_1))$ and $\nu'(R_2) = \nu(\pi(R_2))$.

As ν_p^α is a valuation on $\mathbb{k}[x, y, z, t]$, we have by definition :

$$\nu'(R_1 + R_2) \geq \min(\nu'(R_1), \nu'(R_2)) = \min(\nu(\pi(R_1)), \nu(\pi(R_2))).$$

In particular, the maximal value in the right hand side yields :

$$\nu(f_1 + f_2) \geq \min(\nu(f_1), \nu(f_2)).$$

We prove that $\nu(\pi(f_1 f_2)) = \nu(\pi(f_1)) + \nu(\pi(f_2))$. Take two polynomials R_1 and $R_2 \in \mathbb{k}[x, y, z, t]$ such that $\pi(R_1) = f_1$, $\pi(R_2) = f_2$ and $\nu(f_1) = \nu_p^\alpha(R_1)$, $\nu(f_2) = \nu_p^\alpha(R_2)$. Observe that $(R_1 R_2)^w = R_1^w R_2^w$. As the polynomial q does not divide either R_1^w or R_2^w , it does not divide $(R_1 R_2)^w$ since the ideal generated by q is a prime ideal. Hence by Lemma 3.4.2.6, one has $\nu(f_1 f_2) = \nu_p^\alpha(R_1 R_2) = \nu_p^\alpha(R_1^w) + \nu_p^\alpha(R_2^w) = \nu(f_1) + \nu(f_2)$ as required.

Observe that ν is by definition centered at infinity since $\nu(\pi(x)) < 0$.

Let us prove that the valuation ν is minimal, take another valuation $\nu' : \mathbb{k}[\mathcal{Q}] \rightarrow \mathbb{R}^- \cup \{+\infty\}$ such that $\nu'(\pi(x - x_0)) = \nu(x - x_0)$, $\nu'(\pi(y - y_0)) = \nu(\pi(y - y_0))$, $\nu'(\pi(z - z_0)) = \nu(\pi(z - z_0))$ and $\nu'(\pi(t - t_0)) = \nu(\pi(t - t_0))$. Then the map $\hat{\nu}' : R \in \mathbb{k}[x, y, z, t] \rightarrow \nu'(\pi(R))$ defines a semi-valuation on $\mathbb{k}[x, y, z, t]$. Since the monomial valuation ν_p^α is minimal, in the sense that for any $R \in \mathbb{k}[x, y, z, t]$:

$$\hat{\nu}'(R) \geq \nu_p^\alpha(R).$$

Take $f \in \mathbb{k}[\mathcal{Q}]$ and choose a polynomial $R \in \mathbb{k}[x, y, z, t]$ such that $\nu_p^\alpha(R) = \nu(f)$, the above inequality implies :

$$\nu'(f) \geq \nu(f),$$

as required. □

3.4.3 Valuations in \mathcal{V}_0 and the geometry at infinity

We provide a geometric interpretation of the valuations in \mathcal{V}_0 and we prove that this subset is closely related to the link over the vertex [Id] in the complex \mathcal{C} .

Fix a point $p \in H_\infty$ at infinity in $\overline{\mathcal{Q}}$ and let C_1, C_2 be the vertical and horizontal lines at infinity respectively passing through p . We say an algebraic system of local coordinates $u = (u_0, u_1, u_2)$ at the point p is compatible with the geometry at infinity if

$$H_\infty = \{u_0 = 0\},$$

$$C_1 = \{u_0 = 0\} \cap \{u_1 = 0\}$$

and

$$C_2 = \{u_0 = 0\} \cap \{u_2 = 0\}.$$

We denote by T the set given by

$$T = \{(\alpha_0, \alpha_1, \alpha_2) \in \mathbb{R}_+^3 \mid \alpha_1 + \alpha_2 < \alpha_0\}.$$

Observe that the subset T is convex, its closure in \mathbb{R}^3 is the convex cone generated by $(1, 0, 0)$, $(1, 1, 0)$ and $(1, 0, 1)$. The group \mathbb{R}_+^* acts naturally on T by multiplication and the quotient of T by this action is naturally identified with

$$\hat{T} = \{(1, \alpha_1, \alpha_2) \in \mathbb{R}_+^3 \mid \alpha_1 + \alpha_2 < 1\}.$$

Proposition 3.4.3.1. *For any compatible algebraic system of local coordinates at $p \in H_\infty$, the monomial valuation with weight $\alpha \in T$ at p belongs to \mathcal{V}_0 .*

Conversely, any $\nu \in \mathcal{V}_0$ whose center contains p is a monomial valuation with weight $\alpha \in T$ with respect to a compatible algebraic system of local coordinates.

Proof. Step 1 : Fix $p \in H_\infty$. Consider a valuation ν which is monomial with weight $\alpha = (\alpha_0, \alpha_1, \alpha_2)$ with respect to a compatible algebraic system of local coordinates u near p . We prove that ν does not depend on the choice of an algebraic system of coordinates at the point $p \in H_\infty$. Suppose first that $\alpha_0 > 0, \alpha_1 > 0, \alpha_2 > 0$ and that $\alpha_0, \alpha_1, \alpha_2$ are \mathbb{Q} -independent. By symmetry, we can suppose that p is the point $[1, y_0, z_0, t_0, 0] \in \overline{\mathcal{Q}} \subset \mathbb{P}^4$ where $t_0 = y_0 z_0$ and that the lines C_1 and C_2 are given by :

$$C_1 = \{[\xi_0, \xi_0 y_0, \xi_1, \xi_1 y_0, 0] \mid [\xi_0, \xi_1] \in \mathbb{P}^1\} \subset \overline{\mathcal{Q}}.$$

$$C_2 = \{[\eta_0, \eta_1, z_0 \eta_0, z_0 \eta_1, 0] \mid [\eta_0, \eta_1] \in \mathbb{P}^1\} \subset \overline{\mathcal{Q}}.$$

Let us choose an affine chart (v_0, v_1, v_2) at the point p given by :

$$\begin{aligned} v_0 &= 1/x, \\ v_1 &= (y - y_0)/x, \\ v_2 &= (z - z_0)/x. \end{aligned}$$

The coordinate chart (v_0, v_1, v_2) satisfies the conditions of the proposition. Let us prove that ν is also equal to the monomial valuation with weight $(\alpha_0, \alpha_1, \alpha_2)$ with respect to the chart (v_0, v_1, v_2) . By definition, we can write

$$\begin{aligned} u_0 &= h_0(v_0, v_1, v_2)v_0, \\ u_1 &= v_1 + v_0^a h_1(v_0, v_1, v_2) \\ u_2 &= v_2 + v_0^b h_2(v_0, v_1, v_2), \end{aligned}$$

where $a, b > 0$ are positive integers, h_0, h_1 and h_2 are regular functions at the point $(0, 0, 0)$ and $h_0(0, 0, 0) \neq 0$. Since h_0 is a unit, we have that $\nu(x_0) = \nu(y_0) = \alpha_0$ and the conditions $\alpha_i < \alpha_0$ for $i = 1, 2$ imply that $\nu(u_1) = \nu(v_1)$ and $\nu(u_2) = \nu(v_2)$. We have thus proven that when $\alpha_0, \alpha_1, \alpha_2$ are \mathbb{Q} -independent, ν does not depend on the choice of the compatible algebraic system of coordinates. We conclude then by density since for a general weight α , one can find a sequence of \mathbb{Q} -independent weight which converges to α .

Step 2 : Assume ν is a monomial valuation with weight $\alpha = (\alpha_0, \alpha_1, \alpha_2)$ with respect to a compatible algebraic system of local coordinates u near p . Let us prove that $\nu \in \mathcal{V}_0$. Consider the weight $\alpha' = (-\alpha_0, \alpha_1 - \alpha_0, \alpha_2 - \alpha_0, \alpha_1 + \alpha_2 - \alpha_0)$ and $p' = (0, y_0, z_0, t_0) \in \mathbb{k}^4$. Take $\nu' : \mathbb{k}[\mathcal{Q}] \rightarrow \mathbb{R}$ the valuation given by :

$$\nu'(f) := \sup\{\nu_p^{\alpha'}(R) \mid \pi(R) = f\},$$

for any $f \in \mathbb{k}[\mathcal{Q}]$. We prove that $\nu = \nu'$. Since $\nu(x) = -\alpha_0 < 0$, $\nu(y - y_0) = \alpha_1 - \alpha_0 < 0$ and $\nu(z - z_0) = \alpha_2 - \alpha_0 < 0$ and $\nu(t - t_0) = \alpha_1 + \alpha_2 - \alpha_0 < 0$ then by Proposition 3.4.2.1, we have that :

$$\nu(f) \geq \nu'(f)$$

for any $f \in \mathbb{k}[\mathcal{Q}]$.

Since ν is the monomial valuation with weight α with respect to the algebraic system of local coordinates u near p , we also have that :

$$\nu'(f) \geq \nu(f)$$

for any $f \in k[\mathcal{Q}]$, hence $\nu' = \nu$ and $\nu \in \mathcal{V}_0$.

Step 3 : Conversely, if $\nu \in \mathcal{V}_0$ such that its center contains the point $p = [1, y_0, z_0, t_0, 0] \in \overline{\mathcal{Q}} \setminus \mathcal{Q}$ at infinity where $y_0 z_0 = t_0$. We prove that ν is monomial with respect to a compatible algebraic system of local coordinates near the point $p \in \overline{\mathcal{Q}}$. By definition, there exists a valuation $\nu' : k[x, y, z, t] \rightarrow \mathbb{R}^- \cup \{+\infty\}$ such that

$$\nu(f) = \sup\{\nu'(R) \mid \pi(R) = f\},$$

for any $f \in k[\mathcal{Q}]$. Consider $u = (u_0, u_1, u_2)$ the compatible system of local coordinates at the point p where $u_0 = 1/x$, $u_1 = (y - y_0)/x$, $u_2 = (z - z_0)/x$. Since $p \in Z(\nu)$, this implies that $\nu'(x) < 0$ and $\nu'(y - y_0) \geq \nu'(x)$, $\nu'(z - z_0) \geq \nu'(x)$ and $-\nu'(x) + \nu'(y - y_0) + \nu'(z - z_0) \geq 0$. Consider $\alpha_0 = -\nu'(x)$, $\alpha_1 = -\nu'(x) + \nu'(y - y_0)$, $\alpha_2 = -\nu'(x) + \nu'(z - z_0)$ and μ the monomial valuation with weight $(\alpha_0, \alpha_1, \alpha_2)$ with respect to the system of local coordinates u . By Proposition 3.4.2.1, one has the inequality $\nu \leq \mu$ and since the valuation μ is also minimal and since $\nu(u_i) = \mu(u_i)$ for $i = 0, 1, 2$, we have that $\mu \leq \nu$. Hence, $\nu = \mu$ and ν is monomial with weight $(\alpha_0, \alpha_1, \alpha_2)$ with respect to the affine chart (u_0, u_1, u_2) , as required. \square

We now provide a geometric characterization of the subset \mathcal{V}_0 .

Consider $\mathcal{V}_{\mathcal{C}}$ the union of all the 1×1 squares containing [Id] with all the edges of type I removed.

Proposition 3.4.3.2. *There exists a continuous bijection $\varphi : V_{\mathcal{C}} \rightarrow \hat{\mathcal{V}}_0$. In particular, this map induces a continuous bijection from $V_{\mathcal{C}} \times \mathbb{R}_+^*$ to \mathcal{V}_0 .*

Remark 3.4.3.3. Observe that φ is not a homeomorphism since $\hat{\mathcal{V}}_0$ is compact but $V_{\mathcal{C}}$ is not.

Proof. Step 1 : Let us define φ . For each 1×1 square S in \mathcal{C} containing [Id], there exists a canonical isometry $j_S : S \rightarrow [0, 1] \times [0, 1]$ such that $j_S([\text{Id}]) = (0, 0)$ and the horizontal and vertical edges of type III are mapped to $[0, 1] \times \{0\}$ and $\{0\} \times [0, 1]$ respectively. Using Proposition 3.3.2.1, each square S determines uniquely a point $p(S)$ at infinity. Fix a square S and a compatible algebraic system of coordinates u_S at $p(S)$. For any point $m \in S \cap V_{\mathcal{C}} \setminus \{[\text{Id}]\}$, we define $\varphi|_S(m)$ to be the monomial valuation at $p(S)$ with respect to u_S with weight

$$\alpha = \left(1, \max(\beta_0, \beta_1) \frac{\beta_0}{\beta_0 + \beta_1}, \max(\beta_0, \beta_1) \frac{\beta_1}{\beta_0 + \beta_1} \right) \in \hat{\mathcal{V}}$$

with $(\beta_0, \beta_1) = j_S(m) \in [0, 1]^2 \setminus \{(0, 0)\}$.

We define $\varphi([\text{Id}])$ to be the order of vanishing at infinity ord_{H_∞} .

One checks directly that φ is well-defined and has values in $\hat{\mathcal{V}}_0$. Moreover, if $m_n \in V_{\mathcal{C}}$ is a sequence of points which converges to [Id], then $\varphi(m_n)$ converges to ord_{H_∞} since the weights converge to $(1, 0, 0)$.

Step 2 : We claim that the map φ is injective, indeed, consider two points $m_1, m_2 \in V_{\mathcal{C}}$ such that $\varphi(m_1) = \varphi(m_2)$. Then since the valuation $\varphi(m_i)$ have the same center and this implies that they belong to a common square S . The injectivity follows then from the injectivity of the map :

$$(\beta_0, \beta_1) \in [0, 1]^2 \setminus \{(0, 0)\} \mapsto \left(\max(\beta_0, \beta_1) \frac{\beta_0}{\beta_0 + \beta_1}, \max(\beta_0, \beta_1) \frac{\beta_1}{\beta_0 + \beta_1} \right).$$

Let us prove that φ is surjective. Take $\nu \in \hat{\mathcal{V}}_0$, then by Proposition 3.4.3.1, ν is a monomial valuation with respect to a compatible algebraic system of coordinates at a point p with weight $\alpha = (1, \alpha_0, \alpha_1) \in \mathbb{R}_+^3$ such that $\alpha_0 + \alpha_1 < 1$. Since the point p determines a 1×1 square S by Proposition 3.3.2.1 and since the map :

$$(\beta_0, \beta_1) \in [0, 1]^2 \mapsto \left(1, \max(\beta_0, \beta_1) \frac{\beta_0}{\beta_0 + \beta_1}, \max(\beta_0, \beta_1) \frac{\beta_1}{\beta_0 + \beta_1} \right)$$

has values in \hat{T} , the map φ is surjective.

The preimage of a closed subset of $\hat{\mathcal{V}}_0$ is naturally a closed subset of $V_{\mathcal{C}}$. Indeed, for any regular function f near the point p , the function $m \in V_{\mathcal{C}} \mapsto \varphi(m)(f)$ defines a continuous, convex, piecewise affine function. In particular, this implies that for any rational function $f \in k(\mathcal{Q})$, the function $m \mapsto \varphi(m)(f)$ is continuous. Hence the preimage of a closed set by φ is also closed. We have thus proved that φ is continuous, as required. □

Example 3.4.3.4. Consider the following chain of rational curves (C_1, C_2, C_3, C_4) at infinity in $\overline{\mathcal{Q}} \setminus \mathcal{Q}$. We have the following picture :

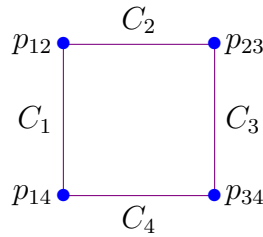

We denote by p_{ij} the intersection point corresponding to $C_i \cap C_j$ for all $i, j \in \{1, 2, 3, 4\}$. Consider F the set of valuations $\nu \in \hat{\mathcal{V}}_0$ whose center is either one of the curves C_1, C_2, C_3, C_4 or one of the points $p_{12}, p_{23}, p_{34}, p_{41}$. Then F corresponds to the following square :

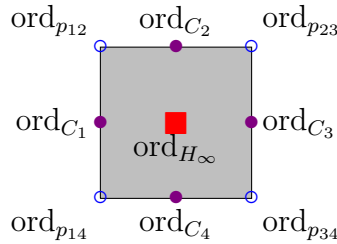

where ord_{C_i} corresponds to the pushforward by $\pi_i : \text{Bl}_{C_i} \overline{\mathcal{Q}} \rightarrow \overline{\mathcal{Q}}$ of the divisorial valuation associated to the exceptional divisor of the blow-up of the curve C_i in $\overline{\mathcal{Q}}$ and where the black point is the valuation order of vanishing along H_∞ . Moreover, when $p_{14} = [0, 0, 0, 1, 0]$, $p_{12} = [0, 0, 1, 0, 0]$, $p_{23} = [1, 0, 0, 0, 0]$ and $p_{34} = [0, 1, 0, 0, 0]$, the bijection φ^{-1} previously defined maps $F \in \hat{\mathcal{V}}_0$ to the 2×2 square in \mathcal{C} containing $[x], [y], [z], [t]$ and $[\text{Id}]$ such that :

$$\varphi^{-1}(\text{ord}_{p_{23}}) = [x], \varphi^{-1}(\text{ord}_{p_{34}}) = [z], \varphi^{-1}(\text{ord}_{p_{14}}) = [t], \varphi^{-1}(\text{ord}_{p_{12}}) = [y],$$

$$\varphi^{-1}(\text{ord}_{C_1}) = [y, t], \varphi^{-1}(\text{ord}_{C_2}) = [x, y], \varphi^{-1}(\text{ord}_{C_3}) = [x, z], \varphi^{-1}(\text{ord}_{C_4}) = [z, t],$$

and $\varphi^{-1}(\text{ord}_{H_\infty}) = [\text{Id}]$.

3.4.4 Parachute

In this subsection, we define the parachute associated to a component of a tame automorphism.

We write by $q = xt - yz \in \mathbb{k}[x, y, z, t]$ and by $\pi : \mathbb{k}[x, y, z, t] \rightarrow \mathbb{k}[\mathcal{Q}]$ the canonical restriction map. For any 4-tuple $(R_1, R_2, R_3, R_4) \in \mathbb{k}[x, y, z, t]$ of polynomials, we write :

$$dR_1 \wedge dR_2 \wedge dR_3 \wedge dR_4 = \text{Jac}(R_1, R_2, R_3, R_4)dx \wedge dy \wedge dz \wedge dt,$$

with $\text{Jac}(R_1, R_2, R_3, R_4) \in \mathbb{k}[x, y, z, t]$.

Definition 3.4.4.1. *The pseudo-jacobian of a triple (f_1, f_2, f_3) of regular functions on \mathcal{Q} is defined by*

$$j(f_1, f_2, f_3) := \text{Jac}(q, R_1, R_2, R_3)|_{\mathcal{Q}},$$

where $R_i \in \mathbb{k}[x, y, z, t]$ are polynomials such that $\pi(R_i) = f_i$ for $i = 1, 2, 3$.

Observe that the pseudo-jacobian $j(f_1, f_2, f_3)$ is well-defined since any two representatives $R_1, R_2 \in \mathbb{k}[x, y, z, t]$ of the same equivalence class in $\mathbb{k}[\mathcal{Q}]$ are equal modulo $(q - 1)$.

Remark 3.4.4.2. Geometrically, the Poincaré residue of the map induced by the rational map $(x, y, z, t) \mapsto f_1, f_2, f_3, f_4$ for $f_i \in \mathbb{k}[\mathcal{Q}]$ is given by $1/j(f_1, f_2, f_3)df_1 \wedge df_2 \wedge df_3$. In other words, $j(f_1, f_2, f_3)$ controls how the volume form Ω on the quadric is changed by the induced rational map.

Lemma 3.4.4.3. *Let $\nu \in \mathcal{V}_0$ be a valuation. For any $f_1, f_2, f_3 \in \mathbb{k}[\mathcal{Q}]$, we have :*

$$\nu(j(f_1, f_2, f_3)) \geq \nu(f_1) + \nu(f_2) + \nu(f_3) - \nu(xt)$$

Proof. Fix $f_1, f_2, f_3 \in \mathbb{k}[\mathcal{Q}]$ and a valuation $\nu \in \mathcal{V}_0$. By definition, there exists a valuation $\nu' : \mathbb{k}[x, y, z, t] \rightarrow \mathbb{R}^- \cup \{+\infty\}$ such that $\nu(P) = \sup\{\nu'(R) | \pi(R) = P\}$ for any $P \in \mathbb{k}[\mathcal{Q}]$ where $\pi : \mathbb{k}[x, y, z, t] \rightarrow \mathbb{k}[\mathcal{Q}]$ is the canonical projection. Take $R_1, R_2, R_3, R_4 \in \mathbb{k}[x, y, z, t]$. We first claim that :

$$\nu'(\text{Jac}(R_1, R_2, R_3, R_4)) \geq \nu'(R_1) + \nu'(R_2) + \nu'(R_3) + \nu'(R_4) - \nu'(xyzt).$$

Let $a_I^{(k)} \in \mathbb{k}$ be the coefficients of R_k for $k = 1, 2, 3, 4$ so that :

$$R_k = \sum_{I=(i_1, i_2, i_3, i_4)} a_I^{(k)} x^{i_1} y^{i_2} z^{i_3} t^{i_4}.$$

One obtains by linearity that $\text{Jac}(R_1, R_2, R_3, R_4)$ is a sum of monomials where the valuation of each term is greater or equal to :

$$\nu'(R_1) + \nu'(R_2) + \nu'(R_3) + \nu'(R_4) - \nu'(xyzt).$$

Hence :

$$\nu'(\text{Jac}(R_1, R_2, R_3, R_4)) \geq \nu'(R_1) + \nu'(R_2) + \nu'(R_3) + \nu'(R_4) - \nu'(xyzt).$$

In particular, we apply to $R_4 = q$ and obtain :

$$\nu'(\text{Jac}(R_1, R_2, R_3, q)) \geq \nu'(R_1) + \nu'(R_2) + \nu'(R_3) - \nu'(xt),$$

since $\nu'(q) = \nu'(xt) = \nu'(yz)$.

Take $f_1, f_2, f_3 \in k[\mathcal{Q}]$, by Lemma 3.4.2.6, there exists $R_1, R_2, R_3 \in k[x, y, z, t]$ such that $\pi(R_i) = f_i \in k[\mathcal{Q}]$ and $\nu(f_i) = \nu'(R_i)$ for all $i = 1, 2, 3$, the above inequality implies :

$$\nu(j(f_1, f_2, f_3)) \geq \nu'(\text{Jac}(q, R_1, R_2, R_3)) \geq \nu'(R_1) + \nu'(R_2) + \nu'(R_3) - \nu'(xt),$$

where the first inequality follows from the definition of ν . Observe that $\nu'(xt) = \nu(xt)$ by Lemma 3.4.2.6, hence we have proven that :

$$\nu(j(f_1, f_2, f_3)) \geq \nu(f_1) + \nu(f_2) + \nu(f_3) - \nu(xt),$$

as required. □

Observe that the regular function $j(f_1, f_2, f_3)$ may vanish so that $\nu(j(f_1, f_2, f_3))$ may be equal to $+\infty$, even if $\nu \in \mathcal{V}_0$.

Lemma 3.4.4.4. *For any algebraically independent functions $f_1, f_2 \in k[\mathcal{Q}]$, one of the four regular functions $j(x, f_1, f_2), j(y, f_1, f_2), j(z, f_1, f_2), j(t, f_1, f_2)$ is not identically zero. In particular,*

$$\min(\nu(j(x, f_1, f_2)), \nu(j(y, f_1, f_2)), \nu(j(z, f_1, f_2)), \nu(j(t, f_1, f_2))) < +\infty,$$

for any valuation $\nu \in \mathcal{V}_0$.

Proof. Consider two algebraically independent regular functions $f_1, f_2 \in k[\mathcal{Q}]$ and suppose by contradiction that $j(x, f_1, f_2) = j(y, f_1, f_2) = j(z, f_1, f_2) = j(t, f_1, f_2) = 0$. We need the following result on the dimension of the k -vector space of derivations ([Lan02, Section VIII.5, Proposition 5.5]). If $K \subset L$ is a subfield of characteristic zero, then

$$\text{trdeg}_K L = \dim_L \text{Der}_K(L). \quad (3.7)$$

By the above equation applied to $K = k(f_1, f_2)$ and $L = k(\mathcal{Q})$, we have that any two $k(f_1, f_2)$ -derivations are proportional. Since $j(x, f_1, \cdot), j(y, f_1, \cdot), j(z, f_1, \cdot)$ and $j(t, f_1, \cdot)$ are $k(f_1, f_2)$ -derivations, this implies that :

$$j(x, f_1, x)j(y, f_1, y) - j(x, f_1, y)j(y, f_1, x) = 0 \in k[\mathcal{Q}],$$

Hence,

$$j(x, f_1, y) = 0 \in k(\mathcal{Q}).$$

Similarly, we have that :

$$j(f_1, x, y) = j(f_1, x, z) = j(f_1, x, t) = j(f_1, y, z) = j(f_1, y, t) = j(f_1, z, t) = 0.$$

Hence the maps $j(x, y, \cdot), j(x, z, \cdot), j(y, z, \cdot)$ are also $k(f_1)$ -derivations. By (3.7) applied to $K = k(f_1)$ and to $L = k(\mathcal{Q})$, we have that the space of $k(f_1)$ derivations is 2-dimensional. In particular, there exists $a, b, c \in k(\mathcal{Q})$ such that :

$$aj(x, y, \cdot) + bj(x, z, \cdot) + cj(y, z, \cdot) = 0,$$

where a, b and c are not all equal to zero. Suppose that $a \neq 0$, we have that :

$$aj(x, y, z) = 0 \in k(\mathcal{Q}),$$

hence $j(x, y, z) = x = 0 \in k[\mathcal{Q}]$ which is impossible. □

Definition 3.4.4.5. *For any monomial valuation $\nu \in \mathcal{V}_0$ and for any algebraically independent regular functions $f_1, f_2 \in k[\mathcal{Q}]$, the parachute $\nabla(f_1, f_2)$ with respect to the valuation ν is defined by the following formula :*

$$\nabla(f_1, f_2) = \min(\nu(j(x, f_1, f_2)), \nu(j(y, f_1, f_2)), \nu(j(z, f_1, f_2)), \nu(j(t, f_1, f_2))) - \nu(f_1) - \nu(f_2).$$

Observe that Lemma 3.4.4.4 and Lemma 3.4.4.3 imply that $\nabla(f_1, f_2)$ is finite and is strictly greater than zero.

For any polynomial $R \in k[x, y]$, we write by $\partial_2 R \in k[x, y]$ the partial derivative with respect to y . The next identity is similar to [LV13, Lemma 5] and is one of the main ingredient to find an upper bound on the value of a valuation.

Lemma 3.4.4.6. *Let $\nu \in \mathcal{V}_0$, let $R \in k[x, y]$ and let $f_1, f_2 \in k[\mathcal{Q}]$ be two algebraically independent elements. Suppose that there exists an integer n such that $\nu(\partial_2^n R(f_1, f_2))$ is equal to the value on $\partial_2^n R$ of the monomial valuation in two variables having weight $\nu(f_1)$ and $\nu(f_2)$ on x and y respectively. Then*

$$\nu(R(f_1, f_2)) < \deg_y(R)\nu(f_2) + n\nabla(f_1, f_2).$$

Proof. We observe that $j(x, f_1, \cdot)$ is a derivation in $k[\mathcal{Q}]$. And since $j(x, f_1, f_2) \geq \nu(f_1) + \nu(f_2) - \nu(xt)$ for any $f_1, f_2 \in k[\mathcal{Q}]$, we have that :

$$\nu(\partial_2 R(f_1, f_2)j(x, f_1, f_2)) = \nu(j(x, f_1, R(f_1, f_2))) \geq \nu(f_1) + \nu(R(f_1, f_2)) + \nu(x) - \nu(xt).$$

In particular since $\nu(x) - \nu(xt) = -\nu(t) > 0$, this gives :

$$\nu(\partial_2 R(f_1, f_2)) > -(\nu(j(x, f_1, f_2)) - \nu(f_1) - \nu(f_2)) + \nu(R(f_1, f_2)) - \nu(f_2).$$

A similar argument with y, z and t gives :

$$\nu(\partial_2 R(f_1, f_2)) > -\nabla(f_1, f_2) + \nu(R(f_1, f_2)) - \nu(f_2). \quad (3.8)$$

We apply (3.8) inductively and obtain :

$$\begin{aligned} \nu(\partial_2 R(f_1, f_2)) &> -\nabla(f_1, f_2) + \nu(R(f_1, f_2)) - \nu(f_2), \\ \nu(\partial_2^2 R(f_1, f_2)) &> -\nabla(f_1, f_2) + \nu(\partial_2 R(f_1, f_2)) - \nu(f_2), \\ &\dots \\ \nu(\partial_2^n R(f_1, f_2)) &> -\nabla(f_1, f_2) + \nu(\partial_2^{n-1} R(f_1, f_2)) - \nu(f_2). \end{aligned}$$

This implies that :

$$\nu(\partial_2^n R(f_1, f_2)) > -n\nabla(f_1, f_2) - n\nu(f_2) + \nu(R(f_1, f_2)).$$

Since $\nu(\partial_2^n R(f_1, f_2))$ is equal to the value of the monomial valuation with weight $(\nu(f_1), \nu(f_2))$ applied to $\partial_2^n(R)$, we have that :

$$(\deg_y R - n)\nu(f_2) > \nu(\partial_2^n R(f_1, f_2)) \geq -n\nabla(f_1, f_2) - n\nu(f_2) + \nu(R(f_1, f_2)).$$

Hence,

$$\nu(R(f_1, f_2)) < \deg_y(R)\nu(f_2) + n\nabla(f_1, f_2),$$

as required. □

3.4.5 Key polynomials

We explain when one can find a polynomial which satisfies the hypothesis of Lemma 3.4.4.6.

Consider $\mu : k[x, y] \rightarrow \mathbb{R}^- \cup \{+\infty\}$ any valuation and $\mu_0 : k[x, y] \rightarrow \mathbb{R}^- \cup \{+\infty\}$ the monomial valuation having weight $\mu(x)$ and $\mu(y)$ on x and y respectively. For any polynomial $R \in k[x, y]$, we write by $\bar{R} \in k[x, y]$ the homogeneous polynomial given by :

$$\bar{R} = \sum_{i\mu(x) + j\mu(y) = \mu_0(R)} a_{ij}x^i y^j,$$

with $a_{ij} \in k$ such that $R = \sum_{ij} a_{ij}x^i y^j$.

Proposition 3.4.5.1. *Consider $\mu : k[x, y] \rightarrow \mathbb{R}^- \cup \{+\infty\}$ any valuation and μ_0 the monomial valuation having weights $\mu(x)$ and $\mu(y)$ on x and y respectively. The following properties are satisfied.*

- (i) *For any $R \in k[x, y]$, one has $\mu(R) \geq \mu_0(R)$.*
- (ii) *If $\mu \neq \mu_0$, then there exists two coprime integers s_1, s_2 satisfying $s_1\mu(x) = s_2\mu(y)$ and a unique constant $\lambda \in k$ for which the polynomial $H = x^{s_1} - \lambda y^{s_2}$ satisfies $\mu(H) > \mu_0(H)$.*
- (iii) *For any $R \in k[x, y]$, one has $\mu(R) > \mu_0(R)$ if and only if $H \mid \overline{R}$.*

The polynomial H associated to μ is called a key polynomial associated to μ .

Proof. Let us prove assertion (i). Write $R \in k[x, y]$ as $R = \sum a_{ij}x^i y^j$ where $a_{ij} \in k$. Recall that the fact that μ_0 is monomial implies that :

$$\mu_0(R) = \min\{i\mu_0(x) + j\mu_0(y) \mid a_{ij} \neq 0\}.$$

Also, μ is a valuation, hence :

$$\mu(R) \geq \min\{i\mu_0(x) + j\mu_0(y) \mid a_{ij} \neq 0\} = \mu_0(R).$$

We have thus proved that $\mu(R) \geq \mu_0(R)$, as required.

Step 1 : Fix s_1, s_2 two coprime integers and $\lambda \in k$. Suppose that $s_1\mu(x) = s_2\mu(y)$ and that the polynomial $H = x^{s_1} - \lambda y^{s_2}$ satisfies $\mu(H) > \mu_0(H)$, we prove that λ is unique. Take $\lambda' \neq \lambda \in k$, then

$$\mu(x^{s_1} - \lambda' y^{s_2}) = \mu(H + (\lambda - \lambda')y^{s_2}) = s_2\mu(y),$$

since $\mu(H) > \mu((\lambda - \lambda')y^{s_2})$. Hence $\mu(x^{s_1} - \lambda' y^{s_2}) = \mu_0(x^{s_1} - \lambda' y^{s_2})$ for any $\lambda' \neq \lambda$.

Step 2 : Choose two integers s_1, s_2 such that $s_1\mu(x) = s_2\mu(y)$. We prove that there exists $\lambda \in k^*$ such that $\mu(x^{s_1} - \lambda y^{s_2}) > s_1\mu(x) = s_2\mu(y)$. Suppose by contradiction that for any $\lambda \in k$, one has $\mu(x^{s_1} - \lambda y^{s_2}) = s_1\mu(x)$. We claim that $\mu(R) = \mu_0(R)$ for any polynomial $R \in k[x, y]$. Fix $R \in k[x, y]$. Observe that if R is a homogeneous polynomial with respect to the weight $(\mu(x), \mu(y))$, then R is of the form :

$$R = \alpha x^{k_0} \prod_i (x^{s_1} - \lambda_i y^{s_2})$$

where $\alpha, \lambda_i \in k^*$ and $k_0 \in \mathbb{N}$. Our assumption implies that $\mu(R) = \mu_0(R)$ for any homogeneous polynomial R .

If R is a general polynomial, then R can be decomposed into $R = \sum_i R_i$ where each polynomial R_i is homogeneous. Since $\mu(R_i) = \mu_0(R_i)$ for each i , this proves that $\mu(R) = \mu_0(R)$ for any $R \in k[x, y]$, which contradicts our assumption. We have thus proven assertion (ii).

Step 3 : We prove assertion (iii). Suppose that $\mu(R) = \mu(\overline{R})$, we claim that H does not divide \overline{R} . Observe that $\mu_0(\overline{R}) = \mu_0(R)$, hence $\mu(R) = \mu(\overline{R}) = \mu_0(\overline{R})$. The equality $\mu(\overline{R}) = \mu_0(\overline{R})$ implies that H does not divide \overline{R} by the previous argument.

Conversely, suppose that H does not divide \overline{R} , we prove that $\mu(R) = \mu_0(R)$. Since H does not divide \overline{R} , we have that $\mu(\overline{R}) = \mu_0(\overline{R})$. Decompose R into $R = \overline{R} + S$ where $S \in k[x, y]$ such that $\mu_0(S) > \mu_0(R)$. We have that :

$$\mu(R) \geq \min(\mu(\overline{R}), \mu(S)).$$

Since $\mu(S) \geq \mu_0(S) > \mu_0(\overline{R}) = \mu(\overline{R})$, we have thus :

$$\mu(R) = \mu(\overline{R}) = \mu_0(\overline{R}),$$

as required. We have proven that $\mu(R) = \mu_0(R)$ if and only if H does not divide \overline{R} which is equivalent to assertion (iii). \square

3.4.6 Parachute inequalities

We introduce various notions of resonances of components of a tame automorphism. These notions will play an important role in the theorem below. Consider a valuation $\nu \in \mathcal{V}_0$ and a component (f_1, f_2) of a tame automorphism. We are interested in the value of ν on $R(f_1, f_2)$ where $R \in \mathbb{k}[x, y]$. The estimates of the value $\nu(R(f_1, f_2))$ will depend on the possible values of the pair $(\nu(f_1), \nu(f_2))$. We shall distinguish the following three cases :

1. The family $(\nu(f_1), \nu(f_2))$ is \mathbb{Q} -independent and we say that the component (f_1, f_2) is **non resonant** with respect to ν .
2. There exists two coprime integers s_1, s_2 such that $s_1 > s_2 \geq 2$ or $s_2 > s_1 \geq 2$ such that $s_1\nu(f_1) = s_2\nu(f_2)$ and we say in this case that the component (f_1, f_2) is **properly resonant** with respect to ν .
3. Either $\nu(f_1)$ is a multiple of $\nu(f_2)$ or $\nu(f_2)$ is a multiple of $\nu(f_1)$ and there exists a polynomial $H \in \mathbb{k}[x, y]$ of the form $x - \lambda y^k$ where $k \in \mathbb{N}^*$, $\lambda \in \mathbb{k}^*$ such that $\nu(H(f_1, f_2)) > \nu(f_1) = k\nu(f_2)$. In this case, the component (f_1, f_2) is called **critically resonant** with respect to ν .

Example 3.4.6.1. When $\nu = -\deg : \mathbb{k}[Q] \rightarrow \mathbb{R}^- \cup \{+\infty\}$, the family (x, y) is not critically resonant, but it is neither properly resonant nor non resonant (in particular there is no alternative). However, (x, y) is non resonant for the monomial valuation with weight $(-\sqrt{2}, -\sqrt{3}, -\sqrt{2}, -\sqrt{3})$ on (x, y, z, t) .

Example 3.4.6.2. Take $f_1 = x, f_2 = y + x^2 \in \mathbb{k}[Q]$, then (f_1, f_2) is critically resonant with respect to the valuation $\text{ord}_{H_\infty} = -\deg$.

Example 3.4.6.3. Take $f_1 = z + x^2, f_2 = y + x^3 \in \mathbb{k}[Q]$, then (f_1, f_2) is properly resonant with respect the valuation $\text{ord}_{H_\infty} = -\deg$.

For $\nu \in \mathcal{V}_0$ and (f_1, f_2) a component of a tame automorphism, the following theorem allows us to estimate the value of ν on $R(f_1, f_2)$ only when (f_1, f_2) is not critically resonant.

Theorem 3.4.6.4. *Let $\nu \in \mathcal{V}_0$ be a valuation and let ν_0 be the monomial valuation on $\mathbb{k}[x, y]$ with weight $(\nu(f_1), \nu(f_2))$ with respect to (x, y) . The following assertions hold.*

- (i) *For any polynomial $R \in \mathbb{k}[x, y]$, one has the lower bound $\nu(R(f_1, f_2)) \geq \nu_0(R(x, y))$.*
- (ii) *If the component (f_1, f_2) is non resonant with respect to ν , then for any polynomial $R \in \mathbb{k}[x, y]$, one has $\nu(R(f_1, f_2)) = \nu_0(R(x, y))$.*
- (iii) *Suppose that the component (f_1, f_2) is properly resonant with respect to ν and let s_1, s_2 be two coprime integers such that $s_1\nu(f_1) = s_2\nu(f_2)$, then for any polynomial $R \in \mathbb{k}[x, y]$, either $\nu(R(f_1, f_2)) = \nu_0(R(x, y))$ or $\nu(R(f_1, f_2)) > \nu_0(R(x, y))$ and we have :*

$$\nu(R(f_1, f_2)) < \min \left\{ \left(s_1 - 1 - \frac{s_1}{s_2} \right) \nu(f_1), \left(s_2 - 1 - \frac{s_2}{s_1} \right) \nu(f_2) \right\}.$$

Remark 3.4.6.5. Observe that in assertion (iii), only one inequality is relevant. Suppose for example that $\nu(f_1) < \nu(f_2)$, then $s_1 < s_2$ and the value $(s_2 - 1 - s_2/s_1)\nu(f_2)$ is greater or equal to 0 whereas $\nu(R(f_1, f_2)) < 0$.

Before giving the proof of Theorem 3.4.6.4, we state two consequences of this theorem below.

Corollary 3.4.6.6. *Let $\nu \in \mathcal{V}_0$ be a monomial valuation and let $f = (f_1, f_2, f_3, f_4)$ be an element of $\text{Tame}(\mathbb{Q})$. We suppose that $\nu(f_1) < \nu(f_2)$ and that (f_1, f_2) is not critically resonant with respect to ν . Then for any polynomial $R \in \mathbb{k}[x, y] \setminus \mathbb{k}[y]$, we have :*

$$\nu(f_2 R(f_1, f_2)) < \nu(f_1).$$

Proof. Two cases appear. Either $\nu(R(f_1, f_2)) = \nu_0(R(x, y))$ where ν_0 is the monomial valuation with weight $(\nu(f_1), \nu(f_2))$ with respect to (x, y) , and we are finished since $R \in \mathbb{k}[x, y] \setminus \mathbb{k}[y]$. Or $\nu(R(f_1, f_2)) > \nu_0(R(x, y))$ and there exists some integers s_1, s_2 such that $s_1\nu(f_1) = s_2\nu(f_2)$ where $s_2 > s_1 \geq 2$. Using Theorem 3.4.6.4.(iii) and the fact that $s_1 \geq 2$, we have thus :

$$\nu(f_2 R(f_1, f_2)) < (s_1 - 1)\nu(f_1) < \nu(f_1),$$

as required. \square

We state the second corollary for which the constant $4/3$ appears naturally.

Corollary 3.4.6.7. *Let $\nu \in \mathcal{V}_0$ be a valuation and let (f_1, f_2) a properly resonant component with respect to ν such that $\nu(f_1) < \nu(f_2)$. Then for any polynomial $R \in \mathbb{k}[x, y] \setminus \mathbb{k}[y]$, one has :*

$$\nu(f_1 R(f_1, f_2)) < \frac{4}{3}\nu(f_1).$$

Proof. Denote by $\nu_0 : \mathbb{k}[x, y] \rightarrow \mathbb{R}^- \cup \{+\infty\}$ be the monomial valuation with weight $(\nu(f_1), \nu(f_2))$ with respect to (x, y) . Two cases appear, either $\nu(R(f_1, f_2)) = \nu_0(R(x, y))$ and we are done since $\nu(R(f_1, f_2)) \leq 2\nu(f_1)$ as $R \in \mathbb{k}[x, y] \setminus \mathbb{k}[y]$ or $\nu(R(f_1, f_2)) > \nu_0(R(x, y))$. In the latter case, consider two coprime integers s_1, s_2 such that $s_1\nu(f_1) = s_2\nu(f_2)$. Since $\nu(f_1) < \nu(f_2)$ and the component (f_1, f_2) is properly resonant, one has the inequality $s_2 > s_1 \geq 2$. Using Theorem 3.4.6.4.(iii), we have that :

$$\nu(f_1 R(f_1, f_2)) < \left(s_1 - \frac{s_1}{s_2}\right)\nu(f_1).$$

Suppose $s_1 \geq 3$, then $s_1 - s_1/s_2 \geq 2$ as $s_1/s_2 \leq 1$. Hence, we have that :

$$\nu(f_1 R(f_1, f_2)) \leq 2\nu(f_1) < \frac{4}{3}\nu(f_1).$$

The only remaining case is when $s_1 = 2$ and $s_2 > s_1 = 2$. Then $s_1/s_2 \leq 2/3$ and we obtain :

$$\nu(f_1 R(f_1, f_2)) < \left(2 - \frac{2}{3}\right)\nu(f_1) = \frac{4}{3}\nu(f_1).$$

\square

Proof of Theorem 3.4.6.4. Let us denote by $R = \sum a_{ij}x^i y^j$. Consider the projection $\pi_{xy} : \mathcal{Q} \rightarrow \mathbb{A}^2$ induced by the embedding of \mathcal{Q} into \mathbb{A}^4 composed with the projection onto \mathbb{A}^2 of the form :

$$\pi_{xy} : (x, y, z, t) \in \mathcal{Q}(\mathbb{k}) \mapsto (x, y).$$

Choose an automorphism f such that $f = (f_1, f_2, f_3, f_4)$ where $f_3, f_4 \in \mathbb{k}[\mathcal{Q}]$. We denote by μ the valuation on $\mathbb{k}[x, y]$ given by $\mu = \pi_{xy*} f_* \nu$.

Observe that for any polynomial $R \in \mathbb{k}[x, y]$, we have $\nu(R(f_1, f_2)) = \mu(R(x, y))$ and assertion (i) follows directly from Proposition 3.4.5.1.(i). Observe also that assertion (ii) follows immediately from the fact that $\nu(f_1)$ and $\nu(f_2)$ are \mathbb{Q} -independent.

Let us prove assertion (iii). We can suppose by symmetry that $\nu(f_1) < \nu(f_2)$. Since the component (f_1, f_2) is properly-resonant, there exists two coprime integers s_1, s_2 such that $s_1\nu(f_1) = s_2\nu(f_2)$ and such that $s_2 > s_1 \geq 2$.

By Proposition 3.4.5.1 applied to μ , there exists $\lambda \in \mathbb{k}^*$ such that the polynomial $H = x^{s_1} - \lambda y^{s_2}$ satisfies

$$\mu(H(x, y)) = \nu(H(f_1, f_2)) > \nu_0(H) = s_1\nu(f_1).$$

For any polynomial $R \in k[x, y]$, denote by \overline{R} be the polynomial given by :

$$\overline{R} = \sum_{i\mu(x)+j\mu(y)=\nu_0(R(x,y))} a_{ij}x^i y^j.$$

By construction, we have that there exists an integer $n \geq 1$ such that $\overline{R} \in (H^n) \setminus (H^{n+1})$.

We shall use the following lemma (proved at the end of this section) :

Lemma 3.4.6.8. *Let $R \in k[x, y]$ such that $H \nmid \overline{R}$. Consider the integer $n = \max\{k \mid H^k \text{ divides } \overline{R}\} \geq 1$. Then the following properties are satisfied.*

- (i) *For any integer $k \leq n$, we have $\partial_2^k(\overline{R}) = \partial_2^k \overline{R}$.*
- (ii) *For any integer $k \leq n$, we have $H^{n-k} \mid \partial_2^k \overline{R}$ but $H^{n-k+1} \nmid \partial_2^k \overline{R}$.*

The above lemma implies that $\partial_2^k \overline{R} = \partial_2^k \overline{R}$ and that $H^{n-k} \mid \partial_2^k \overline{R}$ but $H^{n-k+1} \nmid \partial_2^k \overline{R}$ for any k . In particular, H does not divide $\partial_2^n \overline{R}$ and Proposition 3.4.5.1.(iii) implies that :

$$\mu(\partial_2^n R(x, y)) = \nu_0(\partial_2^n R) = \nu_0(\partial_2^n \overline{R}).$$

The previous equation translates as :

$$\nu((\partial_2^n R)(f_1, f_2)) = \nu_0(\partial_2^n R)$$

and R satisfies the conditions of Lemma 3.4.4.6 (for the same integer n), which in turn implies that :

$$\nu(R(f_1, f_2)) < \deg_y(R)\nu(f_2) + n\nabla(f_1, f_2),$$

Since $H^n \mid \overline{R}$, one has $\deg_y(R) \geq \deg_y(\overline{R}) = s_2 n$, hence :

$$\nu(R(f_1, f_2)) < n(s_2\nu(f_2) + \nabla(f_1, f_2)).$$

Since $n \geq 1$ and since $\nabla(f_1, f_2) \leq -\nu(f_1) - \nu(f_2)$, we have

$$\nu(R(f_1, f_2)) < s_2\nu(f_2) - \nu(f_1) - \nu(f_2).$$

Since $s_1\nu(f_1) = s_2\nu(f_2)$, we get :

$$\nu(R(f_1, f_2)) < \nu(f_1) \left(s_1 - 1 - \frac{s_1}{s_2} \right),$$

as required. □

Proof of Lemma 3.4.6.8. Consider a monomial valuation $\nu_0 : k[x, y] \rightarrow \mathbb{R}^- \cup \{+\infty\}$ with weight $(\alpha, \beta) \in (\mathbb{R}^-, *)^2$ with respect to (x, y) and $H = x^{s_1} - \lambda y^{s_2}$ where s_1, s_2 are coprime integers such that $s_1\alpha = s_2\beta$.

Let us prove assertion (i) for $k = 1$. Fix $R \in k[x, y]$ and write R as :

$$R = \sum_{ij} a_{ij}x^i y^j,$$

where $a_{ij} \in k$. The partial derivative is given explicitly by :

$$\partial_2 R = \sum_{i \geq 0, j \geq 1} j a_{ij} x^i y^{j-1}.$$

Since $H \mid \overline{R}$, one has $\overline{R} \in k[x, y] \setminus k[x]$ and $\nu_0(R) = \nu_0(\overline{R})$. Take (i, j) such that $a_{ij} \neq 0$ and $i\alpha + (j-1)\beta = \nu_0(\partial_2 R)$. Then $i\alpha + j\beta = \nu_0(\partial_2 R) + \nu_0(y) \leq \nu_0(R)$. Conversely, since $H \mid \overline{R}$, there

exists (i, j) such that $i\alpha + j\beta = \nu_0(R)$ where $j \geq 1$, hence we have that $i\alpha + (j-1)\beta \geq \nu_0(\partial_2 R)$. Hence, $\nu_0(\partial_2 R) = \nu_0(R) - \beta$ and $\partial_2 \bar{R} = \partial_2 R$.

Let us prove assertion (ii) for $k = 1$. We have that $H^n | \bar{R}$ but $H^{n+1} \nmid \bar{R}$, then we have :

$$\bar{R} = H^n S,$$

where $S \in \mathbb{k}[x, y]$ is a homogeneous polynomial such that $H \nmid S$. By definition,

$$\partial_2 \bar{R} = n s_2 H^{n-1} y^{s_2-1} S + H^n \partial_2 S.$$

Hence $H^{n-1} | \partial_2 \bar{R}$. Suppose by contradiction that $H^n | \partial_2 \bar{R}$, then this implies that $H | y^{s_2-1} S$ which is impossible since H does not divide S . We have thus proven that $H^{n-1} | \partial_2 R$ but $H^n \nmid \partial_2 R$, as required.

We conclude by an immediate induction on $k \leq n$ to prove assertion (i) and (ii). \square

3.5 Global geometry of the complex

In this section, we first review the results due to Bisi-Furter-Lamy regarding the global geometric properties of the metric square complex $(\mathcal{C}, d_{\mathcal{C}})$ introduced in Section 3.3. We then describe the degree of iterates of a tame automorphism fixing a vertex of the complex. Subsection 3.5.3 contains a discussion on bands. In Subsection 3.5.4 we introduce an important graph and show that it is equivalent to the complex \mathcal{C} . This information plays a crucial role in the proof of Theorem 10.

3.5.1 Gromov curvature and Gromov-hyperbolicity

Recall that a map $\gamma : [0, l] \rightarrow (\mathcal{C}, d_{\mathcal{C}})$ defines a geodesic segment of length l if γ induces an isometry from $[0, l]$ to $\gamma([0, l])$. A map $\gamma : \mathbb{R} \rightarrow \mathcal{C}$ which is an isometry onto its image is called a geodesic line and a map $\gamma : \mathbb{R}^+ \rightarrow \mathcal{C}$ which is an isometry onto its image is called a geodesic half-line. Recall also that $\gamma : [0, l] \rightarrow \mathcal{C}$ is a quasi-geodesic if there exists $\lambda > 0, M > 0$ such that for any $s, s' \in [0, l]$, the following inequality is satisfied :

$$\frac{1}{\lambda} |s - s'| - M \leq d_{\mathcal{C}}(\gamma(s), \gamma(s')) \leq \lambda |s - s'| + M.$$

Observe that a geodesic is by definition a quasi-geodesic.

We say that a metric space is a geodesic metric space if any two points can be joined by a geodesic segment.

A geodesic space (X, d) is CAT(0) (see [BH99, Section II.1]) if its triangles are thinner than euclidian triangles. In other words, (X, d) satisfies the following condition. For any three points p, q, r in X , take a triangle in the euclidean plane $(\mathbb{R}^2, \|\cdot\|)$ with vertices $\bar{p}, \bar{q}, \bar{r} \in \mathbb{R}^2$ such that $d(p, q) = \|\bar{p} - \bar{q}\|$, $d(q, r) = \|\bar{q} - \bar{r}\|$ and $d(r, p) = \|\bar{r} - \bar{p}\|$. Then for any point $m_1 \in X$ and $m_2 \in X$ in the geodesic segment $[p, q]$ and $[q, r]$ respectively, one has :

$$d(m_1, m_2) \leq \|\bar{m}_1 - \bar{m}_2\|,$$

where \bar{m}_1 and \bar{m}_2 are the unique points on the segments $[\bar{p}, \bar{q}]$ and $[\bar{q}, \bar{r}]$ respectively such that $d(m_1, p) = \|\bar{p} - \bar{m}_1\|$ and $d(r, m_2) = \|\bar{r} - \bar{m}_2\|$.

Let us recall the notion of Gromov-hyperbolic metric space. Let $\delta > 0$ be a positive real number. A metric space (X, d) is δ -hyperbolic if for any geodesic triangle $T = [p, q] \cup [q, r] \cup [r, p]$ in X and for any point $m \in [p, q]$, we have :

$$d(m, [q, r] \cup [r, p]) \leq \delta$$

Theorem 3.5.1.1. (*[BFL14, Theorem A]*) *The square complex \mathcal{C} , endowed with the distance $d_{\mathcal{C}}$, is a geodesic metric space which is simply connected, CAT(0) and Gromov-hyperbolic.*

Sketch of Proof. The simple connectedness of the complex is a consequence of the reduction theory, which in turns relies heavily on the parachute inequalities that we shall describe extensively in Section 3.4 below.

Given a loop in \mathcal{C} , a first step is to prove that the given loop is homotopic to a loop which passes only through vertices of type III and II. This can be done since every square contains one vertex of type III and two vertices of type II. Then, given such a loop γ , one proves that γ is homotopic to the trivial loop by induction on the maximal degree of the vertices of type III contained in γ (the degree is defined since the vertices of type III are equivalence classes modulo O_4). To prove such a statement, one uses the following formulation of the reduction theory (see [BFL14, Theorem A.1]). Any tame automorphism f is equal to the composition :

$$f = e_1 \circ \dots \circ e_k \circ g,$$

where e_1, \dots, e_k are automorphisms conjugated to E_V by an element of O_4 and where $g \in O_4$. As a consequence, if a vertex $[f]$ of type III is a vertex with maximal degree on γ , there exists an automorphism e conjugated to E_V by an element of O_4 such that the degree of $e \circ f$ is strictly smaller. Then a closer study proves that one can find a local homotopy near $[f]$ and loop γ' which is homotopic γ and which passes through the vertex $[e \circ f]$.

The Gromov-hyperbolicity property follows from the simple connectedness and the so-called "thin-bigon criterion" applied to the 1-skeleton of \mathcal{C} (see [Pap95]). The authors prove that the complex \mathcal{C} does not contain any subset which is isometric to $[0, 6] \times [0, 6]$ which in turns imply that the 1-skeleton of \mathcal{C} satisfies the thin bigon criterion, i.e there exists a large number M such that for any two geodesics on the 1-skeleton joining the same points, their distance is bounded by M . This statement is enough to conclude that the triangles in \mathcal{C} are thin.

Finally, the study of the geometry near each vertex of \mathcal{C} provides an upper bound on the local curvature on a neighborhood of each vertex, which implies the CAT(0) property using a theorem due to Gromov (see [BH99, II.Theorem 5.2]). \square

The previous result has important consequences on the behavior of the isometries of the complex, i.e distance preserving maps. Recall that the translation length, denoted $l(f)$, of an isometry $f : \mathcal{C} \rightarrow \mathcal{C}$ is defined by :

$$l(f) = \inf_{v \in \mathcal{C}} d_{\mathcal{C}}(v, f(v)).$$

Observe that for any isometry f , the points in the complex where the infimum is reached is invariant by f . We denote by $\text{Min}(f)$ the subset of \mathcal{C} on which the infimum is reached.

Theorem 3.5.1.2. *Let $f : \mathcal{C} \rightarrow \mathcal{C}$ be an isometry of \mathcal{C} which is also a morphism of complex. Then either $l(f) = 0$ and f fixes a vertex in the complex, either $l(f) > 0$ and one can find f -invariant geodesic line on which f acts by translation by $l(f)$.*

Proof. Take f an isometry of the complex \mathcal{C} . Then $\text{Min}(f)$ is non-empty by [BH99, II.6.6.(2)]. Suppose that $l(f) > 0$, then f satisfies the hypothesis of [BH99, II.Theorem 6.8]. More precisely, [BH99, II.Theorem 6.8.(1)] asserts that an isometry f of a CAT(0) space satisfies $l(f) > 0$ if and only if f translates by $l(f)$ on an invariant geodesic line, as required. Otherwise $l(f) = 0$, we prove that there exists a vertex which is fixed by f . Take a sequence of points v_p in \mathcal{C} such that the distance $d_{\mathcal{C}}(v_p, f^2 \cdot v_p)$ tends to 0. If these points belong to the interior of a square, their image will also be in the interior of a square. Since the distance between v_p and $f^2 \cdot v_p$ is

arbitrarily small, they should belong to two squares S_p, S'_p which intersect, the only solution is that the intersection is fixed by f^2 , hence f^2 fixes a vertex or an edge or a square. Since each edge is joined by two vertices of different type and since f^2 preserves the type of vertices, we conclude that f^2 fixes a vertex in the complex. Similarly, if f^2 fixes a square, then it also fixes the unique vertex of type III on the given square. A similar argument also holds if the sequence v_p are contained in the edges of \mathcal{C} . In any of these cases, we conclude that f must also preserve a vertex in the complex \mathcal{C} , as required. \square

3.5.2 Application to the degree growths of elliptic automorphisms

In this section, we apply the results of the previous section to study the degree growth of particular tame automorphisms. We call an isometry of \mathcal{C} which is also a morphism of complex **elliptic** if its translation length is zero, otherwise we say it is **hyperbolic**. As the tame group acts by isometry on the complex \mathcal{C} and as a morphism of complex, we say similarly that a tame automorphism is elliptic or hyperbolic if its action on the complex is elliptic or hyperbolic respectively.

We now compute the degree growth of elliptic tame automorphisms.

Theorem 3.5.2.1. *Let $f \in \text{Tame}(\mathcal{Q})$ be any tame automorphism of \mathcal{Q} fixing a vertex in the square complex. Then we are in one of the following situations :*

- (i) *The sequence $(\deg(f^n), \deg(f^{-n}))$ is bounded and f is linear or f^2 is conjugated in $\text{Bir}(\mathbb{P}^3)$ to an automorphism of the form $(x, y, z) \mapsto (ax, by + xR(x), b^{-1}z + xP(x, y))$ with $a, b \in k^*$, $P \in k[x, y]$ and $R \in k[x]$.*
- (ii) *There exists a constant $C > 0$ such that :*

$$\frac{1}{C}n \leq \deg(f^{\epsilon n}) \leq Cn,$$

where $\epsilon \in \{+1, -1\}$ and f is conjugated in $\text{Bir}(\mathbb{P}^3)$ to an automorphism of the form :

$$(x, y, z) \mapsto (ax, b^{-1}(z + xR(x)), b(y + xP(x)z)),$$

with $a, b \in k^*$, $R \in k[x]$ and $P \in k[x] \setminus k$.

- (iii) *There exists a constant $C > 0$ and an integer d such that :*

$$\frac{1}{C}d^n \leq \deg(f^{\epsilon n}) \leq Cd^n,$$

where $\epsilon \in \{+1, -1\}$ and f is conjugated in $\text{Bir}(\mathbb{P}^3)$ to a composition of elements of the form :

$$(x, y, z) \mapsto (ax, b(z + xP(x, y)), b^{-1}(y + xR(x))),$$

where $a, b \in k^*$, $R \in k[x]$ and $P \in k[x, y]$ such that $\deg_y(P) \geq 2$.

Remark 3.5.2.2. In case (iii) of the previous Theorem, suppose f is a normal form, then $\deg(f^p) = Cd^p + C_0$ where $C > 0$ and $C_0 \in \mathbb{Z}$.

Remark 3.5.2.3. We summarize the growth of the degree of elliptic automorphisms.

Fixed vertex	Action on the link	Fibration	Behavior on the fiber	$\deg(f^n)$
Type III				bounded
Type II		over \mathbb{P}^2	Flow of a vector field	bounded
Type I	trivial on the Bass-Serre tree	over \mathbb{P}^1	Flow of a vector field	bounded
Type I	involution on the Bass-Serre tree	over \mathbb{P}^1	Affine	linear
Type I	hyperbolic on the Bass-Serre tree	over \mathbb{P}^1	Composition of Henon	exponential

Proof. Take $f \in \text{Tame}(\mathcal{Q})$ an elliptic automorphism. Since f fixes a vertex on the complex, we will distinguish three cases depending on the type of vertices f fixes. Moreover, recall that the degree growth is an invariant of conjugation and that by Proposition 3.3.2.3, the tame group acts transitively on the set of vertices of type I, II and III respectively. We are thus reduced to compute the degree growth for f in the subgroups $\text{Stab}([\text{Id}])$, $\text{Stab}([x, z])$ and $\text{Stab}([x])$ respectively.

First case : If $f \in \text{Stab}([\text{Id}]) = O_4$, the sequence $(\deg(f^n), \deg(f^{-n}))$ is bounded.

Second case : Suppose that $f \in \text{Stab}([x, z])$. By Proposition 3.3.3.1, one has :

$$\text{Stab}([x, z]) = E_{\mathbb{H}} \rtimes \left\{ \begin{pmatrix} ax + bz & a'y + b't \\ cx + dz & c'y + d't \end{pmatrix} \mid \begin{pmatrix} a & b \\ c & d \end{pmatrix} \begin{pmatrix} d' & -b' \\ -c' & a' \end{pmatrix} = I_2 \in M_2(k) \right\}.$$

Denote by $\pi_{xz} : \mathcal{Q} \rightarrow \mathbb{A}^2 \setminus \{(0, 0)\}$ the map induced by the projection

$$(x, y, z, t) \rightarrow (x, z).$$

Using Proposition 3.2.2.1 and the fact that the vertices of type I contained in a square containing $[\text{Id}]$ are in one to one correspondance with the hyperplane at infinity by Proposition 3.3.2.1, we can conjugate by an element of SO_4 so that f also fixes the vertices $[x], [z]$. By Proposition 3.2.3.1, f is then of the form :

$$\begin{pmatrix} ax & b(y + xP(x, z)) \\ b^{-1}z & a^{-1}(t + zP(x, z)) \end{pmatrix},$$

where $a, b \in k^*$ and $P \in k[x, y]$. Recall that $\pi_{xz}^{-1}(\mathbb{A}^2 \setminus (\{0\} \times \mathbb{A}^1))$ is isomorphic to $\mathbb{A}^2 \setminus (\{0\} \times \mathbb{A}^1) \times \mathbb{A}^1$. We fix an isomorphism, since f fixes the fibration π , it induces a regular automorphism on $\mathbb{A}^2 \setminus (\{0\} \times \mathbb{A}^1) \times \mathbb{A}^1$ of the form :

$$f : (x, z, y) \mapsto (ax, b^{-1}z, b(y + xP(x, z))).$$

In particular, the sequence $(\deg(f^n), \deg(f^{-n}))$ is bounded and f satisfies assertion (i).

Third case : Consider $f \in \text{Stab}([x])$ such that $f \notin \text{Stab}([x, y]) \cup \text{Stab}([x, z])$. Since f preserves the fibration $\pi_x : \mathcal{Q} \rightarrow \mathbb{A}^1$ and since $\pi_x^{-1}(\mathbb{A}^1 \setminus \{0\})$ is isomorphic to $\mathbb{A}^1 \setminus \{0\} \times \mathbb{A}^2$, the automorphism f is of the form :

$$f : (x, y, z) \rightarrow (x, f_1, f_2),$$

where (f_1, f_2) defines an element of $\text{Aut}(\mathbb{A}_{k[x]}^2)$.

By Proposition 3.3.5.4, f induces an action on the subtree of the Bass-Serre tree associated to $\text{Aut}(\mathbb{A}_{k(x)}^2)$. If f induces an action on this subtree which fixes every point of the tree, then f belongs to $A_{[x]}$. By Proposition 3.3.5.4.(iv), f is then of the form :

$$\begin{pmatrix} ax & b(y + xP(x)) \\ b^{-1}(z + xS(x)) & a^{-1}(t + zP(x) + yS(x) + xP(x)S(x)) \end{pmatrix}$$

where $P, S \in k[x] \setminus k$. In particular, the sequences $(\deg(f^n))$ and $(\deg(f^{-n}))$ are bounded and f satisfies assertion (i) since in the fixed trivialization, f is of the form $(x, y, z) \mapsto (x, by + xP(x), z + xS(x))$.

Recall that the vertices of type II in the Bass-Serre tree $\mathcal{T}_{k(x)}$ were equivalence classes of components (f_1, f_2) of automorphisms in $\text{Aut}(\mathbb{A}_{k(x)}^2)$ where two components $(f_1, f_2) \simeq (g_1, g_2)$ if and only if there exists $\begin{pmatrix} a & b \\ c & d \end{pmatrix} \in \text{GL}_2(k(x))$ such that $(g_1, g_2) = (af_1 + bf_2, cf_1 + df_2)$.

Suppose that $f, f^2 \notin A_{[x]}$ and the action of f on the subtree of $\mathcal{T}_{k(x)}$ fixes a vertex. If the fixed vertex in the tree $\mathcal{T}_{k(x)}$ is of type II, then we can suppose that f fixes the vertex given by $[y, z]$. In particular, this implies that f is conjugated to

$$\left(\begin{array}{cc} ax & b(y + xP(x)z) \\ b^{-1}(z + xR(x)) & a^{-1}(t + z^2P(x) + yR(x)) \end{array} \right) \text{ or } \left(\begin{array}{cc} ax & b^{-1}(z + xR(x)) \\ b(y + xP(x)z) & a^{-1}(t + z^2P(x) + yR(x)) \end{array} \right)$$

with $P \in k[x] \setminus k$ and $R \in k[x]$. In particular, the sequences $\deg(f^n)$ and $\deg(f^{-n})$ are bounded in the first case and grow linearly in the second. In the first case, f satisfies assertion (i) and f satisfies assertion (ii) in the second.

If $f, f^2 \notin A_{[x]}$ and the action f on $\mathcal{T}_{C(x)}$ fixes a vertex of type I but no vertices of type II, then f is conjugated to an element which fixes the vertex $[y]$, in particular it is conjugated to

$$\left(\begin{array}{cc} ax & b(y + xP(x, z)) \\ b^{-1}(z + xR(x)) & a^{-1}(t + z^2P(x) + yR(x)) \end{array} \right)$$

with $P, R \in k[x] \setminus k$. In this case, the degrees are both bounded and f satisfies assertion (i).

The remaining case is when the action on the tree $\mathcal{T}_{k(x)}$ is hyperbolic and using the amalgamated product structure, we deduce that f is conjugated to a composition of elements of the form :

$$\left(\begin{array}{cc} ax & b(z + xP(x, y)) \\ b^{-1}(y + xR(x)) & a^{-1}(t + zR(x) + yP(x, y) + xP(x, y)R(x)) \end{array} \right),$$

where $R \in k[x]$ and $P \in k[x, y]$ such that $\deg_y(P) \geq 2$. In this case, the degree sequences $(\deg(f^n)), (\deg(f^{-n}))$ are both equivalent to d^n and f satisfies assertion (iii). \square

3.5.3 Bands and regions

Let us define the notion of **band** in the complex.

Recall that a vertical (resp. horizontal) **region** of \mathcal{C} is a connected component of \mathcal{C} minus all vertical (resp. horizontal) edges. One can understand the geometry of a region as follows. Observe that on each 1×1 square, the orthogonal projection onto the symmetry axis of the square which permutes the vertical edges defines a strong deformation retraction on the square. The retraction on each square induces a retraction of a region on a graph denoted T_V where V stands for vertical. Observe that the graph T_V does not depend on the choice of the region since the group $\text{STame}(\mathcal{Q})$ acts transitively on the 1×1 square, hence on vertical regions. One can also similarly define the graph T_H .

The complement $\mathcal{C} \setminus T_V$ of the graph T_V contains two geodesically convex connected components (see [BS99, Lemma 3.2]). We briefly explain the proof of this result. Fix a vertical region R which retracts to the graph T_V . We claim that $\mathcal{C} \setminus T_V$ has at least 2 geodesically connected components. Take two points p, q in a common square S which belong to two different connected components of $S \setminus T_V$. We prove that p and q do not belong to the same connected component in $\mathcal{C} \setminus T_V$. Indeed, suppose that there exists a geodesic path γ in $\mathcal{C} \setminus T_V$ joining p and q , then this defines a loop γ' by adding γ to the segment in S joining q to p . By construction, γ' intersects T_V at a unique point, but since \mathcal{C} is simply connected, γ' is homotopic to a trivial loop and the number of generic transversal intersection points with T_V is always even. This contradicts the fact that the number of generic transversal intersection points of γ' with T_V is odd. Fix a point $p_0 \in \mathcal{C} \setminus T_V$, define a map $\varphi : \mathcal{C} \setminus T_V \rightarrow \mathbb{Z}/2\mathbb{Z}$ which maps a point $q \in \mathcal{C} \setminus T_V$ to the number of generic transversal intersection points modulo 2 of any path γ joining p_0 to q with T_V . The previous argument proves that φ is well-defined and continuous. In particular, $\mathcal{C} \setminus T_V$ has exactly 2 connected components.

The graph T_V is a tree. Indeed, the fact that the complement $\mathcal{C} \setminus T_H$ of a given graph T_H has two connected components implies that $T_V \setminus T_H$ also has two connected components. Hence, for any point $p \in T_V$ which belongs to the interior of a square, the complement $T_V \setminus \{p\}$ has also two connected components, and since T_V is a one dimensional complex, it must be a tree.

Definition 3.5.3.1. *A vertical (resp. horizontal) band is the closure in \mathcal{C} of $]0, 1[\times \gamma$ where γ is a geodesic line in T_V (resp. T_H).*

Definition 3.5.3.2. *A vertical (resp. horizontal) band of width 2 is a subset of \mathcal{C} which contains a band and which is isometric to $[0, 2] \times \mathbb{R}$.*

3.5.4 Function on the vertices of the complex and the graph \mathcal{C}' associated to a valuation

Fix a valuation $\nu \in \mathcal{V}_0$. Given any automorphism $f = (f_1, f_2, f_3, f_4) \in \text{Tame}(\mathbb{Q})$, we remark that $\nu(f_1)$ does not depend on the choice of representative of the class $[f_1]$ so that ν induces a function on the vertices of type I of \mathcal{C} .

We say that a vertex $v \in \mathcal{C}$ of type I is ν -**minimal** (resp. ν -**maximal**) in a 2×2 square S if $\nu(v)$ is strictly smaller (resp. greater) than the value of the valuation ν on every other vertices of type I of S . Observe that for some valuations, two vertices of type I can have the same value on ν , hence there can be no ν -minimal or ν -maximal vertices.

We now define a graph \mathcal{C}_ν associated to a valuation $\nu \in \mathcal{V}_0$ as follows :

1. the vertices are the vertices of \mathcal{C} type I ;
2. one draws an edge between two vertices v_1 and v_2 of \mathcal{C}' if there exists a 2×2 square S centered at a vertex of type III in \mathcal{C} containing v_1, v_2 such that the vertices v_1, v_2 belong to an edge of S or v_1 and v_2 are the ν -minimal and ν -maximal vertices of S respectively.

Observe that whenever there is no ν -maximal or minimal vertex in a 2×2 square S centered at a point of type III, then we only draw the four edges of the square S .

The graph \mathcal{C}' is endowed with the distance d_ν such that its the edges have length 1.

Lemma 3.5.4.1. *The graph \mathcal{C}' is a connected metric graph.*

Proof. This follows from the fact that the 1-skeleton of \mathcal{C} is connected. □

Since we will exploit the properties of this function on the vertices of type I, we introduce the following convention on the figures. Take an edge of length 2 between two type I vertices v_1, v_2 , then we put an arrow pointing to v_2 if $\nu(v_2) < \nu(v_1)$ as in the following figure.



Lemma 3.5.4.2. *Let $\nu : k[\mathcal{Q}] \rightarrow \mathbb{R} \cup \{+\infty\}$ be a valuation which is trivial over k^* and such that $\nu(x), \nu(y), \nu(z), \nu(t) < 0$. Let S be a 2×2 square of the complex \mathcal{C} centered at a type III vertex. Suppose S has a unique ν -maximal vertex (resp. ν -minimal), then there exists a unique ν -minimal (resp. ν -maximal) vertex and the ν -minimal and ν -maximal vertices are at distance $2\sqrt{2}$ in \mathcal{C} .*

Let S be a 2×2 square centered at a vertex of type III which satisfies the conditions of Lemma 3.5.4.2. and let ϕ be the associated isometry. Denote by $[x_1], [y_1], [z_1]$ and $[t_1]$ the vertices

of type I of the square S where $x_1, y_1, z_1, t_1 \in k[\mathcal{Q}]$ such that the vertex $[x_1]$ is ν -minimal and $[t_1]$ is ν -maximal in S . Then there exists a unique isometry $\phi : S \rightarrow [0, 1]^2$ such that :

$$\phi([x_1]) = (2, 2),$$

and

$$\phi([t_1]) = (0, 0),$$

and such that the horizontal edges of S are given the geodesic segments between $[x_1]$ and $[y_1]$, and between $[z_1]$ and $[t_1]$.

Using this convention, Lemma 3.5.4.2 implies that we are in the following situation :

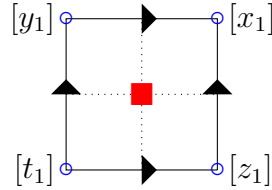

In particular, the subgraph of \mathcal{C}' containing the vertices of S looks as follows :

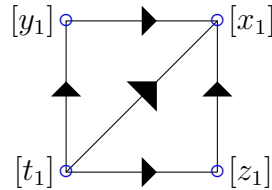

Proof of Lemma 3.5.4.2. Let S be a 2×2 square satisfying the hypothesis of the Lemma. Denote $[t_1]$ the ν -maximal vertex of S . Denote also by $[z_1], [y_1], [x_1]$ the type I vertices of S such that the edges between $[t_1]$ and $[z_1]$, between $[t_1]$ and $[y_1]$ are horizontal and vertical respectively.

Observe that $\nu(x_1), \nu(y_1), \nu(z_1), \nu(t_1) < 0$ and that :

$$\nu(x_1 t_1 - y_1 z_1) = \nu(1) = 0.$$

This implies that :

$$\nu(x_1) + \nu(t_1) = \nu(y_1) + \nu(z_1).$$

In particular, $\nu(t_1) > \nu(y_1)$ implies that :

$$\nu(x_1) < \nu(z_1).$$

By symmetry, we also prove that $\nu(x_1) < \nu(y_1)$ and this implies that $[x_1]$ is the unique ν -minimal vertex of S , as required. \square

Observe that for two distinct valuations $\nu_1, \nu_2 \in \mathcal{V}_0$, the graphs \mathcal{C}_{ν_1} and \mathcal{C}_{ν_2} are not in general equal.

Lemma 3.5.4.3. *Fix any valuation $\nu \in \mathcal{V}_0$, and any two adjacent 2×2 squares S, S' centered at a vertex of type III. Suppose that v is a vertex in $S \cap S'$ which is ν -minimal in S .*

Then the unique vertex $v' \in S' \setminus S$ which belongs to an edge containing v is also ν -minimal in S' .

One has the following figure :

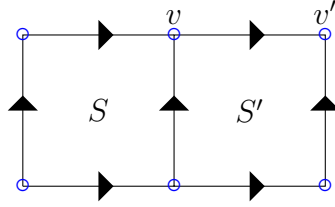

Proof of Lemma 3.5.4.3. Take $x_1, y_1, z_1, t_1 \in k[\mathcal{Q}]$ such that $v = [x_1], [z_1] \in S \cap S'$ and $[y_1], [t_1] \in S$ are the four distinct vertices of S . We claim that we are in the following situation :

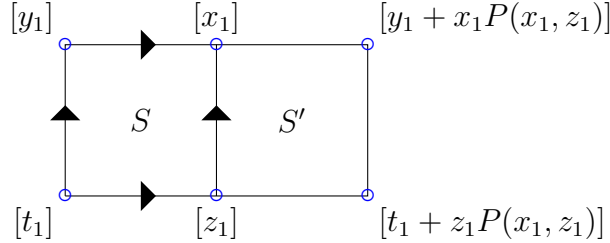

where $P \in k[x, y] \setminus k$. Indeed, recall that the tame group acts as $g \cdot [f] = [f \circ g^{-1}]$. In particular, if S_0 is the standard 2×2 square containing $[x], [y], [z], [t]$ and $[\text{Id}]$ and if $f = (x_1, y_1, z_1, t_1)$, then $S = f^{-1} \cdot S_0$. Since S and S' are adjacent along an two edges of type I, there exists an element $e \in E_{\mathbb{H}}$ such that $S' = (f^{-1} \circ e \circ f) \cdot S$. This proves that $S' = (f^{-1} \circ e) \cdot S_0$, and the vertex v' is given by :

$$v' = [y \circ e^{-1} \circ f],$$

as required.

Since $\nu(x_1) < \nu(y_1)$ and since $\nu(P(x_1, z_1)) < 0$, this implies that :

$$\nu(y_1 + x_1 P(x_1, z_1)) = \nu(x_1 P(x_1, z_1)) < \nu(x_1).$$

Similarly, one has :

$$\nu(t_1 + z_1 P(x_1, z_1)) = \nu(z_1 P(x_1, z_1)) < \nu(z_1).$$

Hence since the vertex $[z_1]$ is ν -maximal, we have that $v' = [y_1 + x_1 P(x_1, z_1)]$ is the ν -minimal vertex in S' by Lemma 3.5.4.2, as required. \square

The following proposition compares the distance d_ν with the distance $d_{\mathcal{C}}$.

Proposition 3.5.4.4. *The distance d_ν and the distance $d_{\mathcal{C}}$ are equivalent, i.e there exists a constant $C > 0$ such that for any vertices $v_1, v_2 \in \mathcal{C}$ of type I, one has :*

$$\frac{1}{2\sqrt{2}} d_{\mathcal{C}}(v_1, v_2) \leq d_\nu(v_1, v_2) \leq 3d_{\mathcal{C}}(v_1, v_2).$$

Proof. For each 2×2 square S centered at a vertex of type III in \mathcal{C} , the restriction to $S \cap \mathcal{C}_\nu$ of the distance in \mathcal{C}_ν and the distance $d_{\mathcal{C}}$ are bi-lipschitz equivalent. More precisely, for any $v_1, v_2 \in S \cap \mathcal{C}_\nu$, the following inequality holds :

$$\frac{d_{\mathcal{C}}(v_1, v_2)}{2\sqrt{2}} \leq d_\nu(v_1, v_2) \leq 3d_{\mathcal{C}}(v_1, v_2).$$

Hence, if we apply the previous inequality to a chain of points which belong successively to the same square, we obtain the distance in \mathcal{C} is equivalent to the distance d_ν and for any vertices v_1, v_2 of type I in \mathcal{C} , we have :

$$\frac{d_{\mathcal{C}}(v_1, v_2)}{2\sqrt{2}} \leq d_\nu(v_1, v_2) \leq 3d_{\mathcal{C}}(v_1, v_2),$$

as required. \square

3.6 Degree estimates in the graph \mathcal{C}_ν

In this section, we prove the following theorem, which is a refinement of [BFL14, Theorem A.1] where the authors proved that the distance between two vertices of type III $[f]$ and $[g]$ where $f, g \in \text{Tame}(\mathcal{Q})$ is smaller than the degree of $f \circ g^{-1}$.

Fix a valuation $\nu \in \mathcal{V}_0$ and consider the graph \mathcal{C}_ν associated to ν . The main theorem of this section allows one to compare the distance in \mathcal{C}_ν with the logarithm of ν on the vertices of \mathcal{C}_ν . We recall that the standard 2×2 square S_0 is the square whose vertices are $[x], [y], [z]$ and $[t]$.

Theorem 3.6.0.1. *Pick any valuation $\nu \in \mathcal{V}_0$ satisfying :*

$$\max(\nu(y) + \nu(t), \nu(z) + \nu(t)) < \nu(x) < \min(\nu(y), \nu(z), \nu(t)). \quad (3.9)$$

Consider any geodesic segment of \mathcal{C} joining $[\text{Id}]$ to a vertex v of type I which intersects an edge of the square S_0 , then the following assertions hold.

1. *We have :*

$$\nu(v) \leq \left(\frac{4}{3}\right)^{d_\nu([t], v) - 1} \max(\nu(x), \nu(y), \nu(z), \nu(t)).$$

2. *For any valuation $\nu' \in \mathcal{V}_0$ satisfying (3.9), we have :*

$$d_\nu([t], v) = d_{\nu'}([t], v).$$

Observe that condition (3.9) implies that the vertex $[x]$ is ν -minimal in S_0 .

The proof of Theorem 4.6.0.4 basically proceeds by induction on the distance between $[t]$ and v . To be able to prove the induction step we will need to prove our key Proposition given Section 3.6.1.

In Section 3.6.2, we prove the main estimates on the degrees on a spiral staircase. The method use extensively the Parachute inequalities and the geometry of the link of a vertex of type I.

Then Section 3.6.3, Section 3.6.4 and Section 3.6.5 provide three consequences of these estimates.

As a result, in §3.6.6, we prove Theorem 3.6.0.1 by induction using purely combinatorial arguments based on the statements proved in §3.6.2, §3.6.3, §3.6.5 and §3.6.4.

Finally, Theorem 3.6.0.1 allows us to deduce Theorem 9 and Theorem 10. In §3.6, we will consider only 2×2 squares of the complex which are centered on a vertex of type III and we will adopt the convention on the figures defined in Section 3.5.4, where an arrow point to a vertex on which the valuation is strictly smaller.

3.6.1 Choice of squares with non-critically resonant edges

The proof amounts to prove inductively that the value of a given valuation on the vertices behaves at least multiplicatively. To do so, we will need to consider non-critically resonant edges.

Fix a valuation $\nu \in \mathcal{V}_0$ and fix a 2×2 square S . Consider a vertex $[x_1]$ of type I in S which is ν -minimal in S where $x_1 \in k[\mathcal{Q}]$ and denote by $[z_1]$ another vertex of type I in S such that $[x_1]$ and $[z_1]$ belong to a vertical edge of the square S . For any square S' which is adjacent to S along the edge containing $[x_1]$ and $[z_1]$, Lemma 3.5.4.3 implies that the function induced by ν on the vertices is as follows,

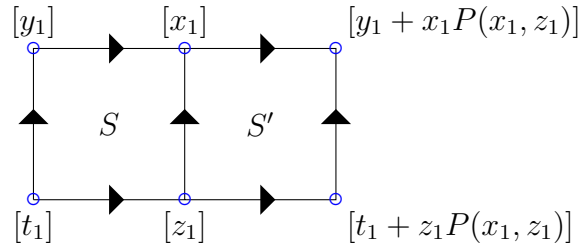

where $y_1, t_1, \in k[\mathcal{Q}]$ and $P \in k[x, y] \setminus k$. Observe that if the component (x_1, z_1) is not critically resonant with respect to ν , then by Corollary 3.4.6.7, one has :

$$\max(\nu(y_1 + x_1P(x_1, z_1), \nu(t_1 + z_1P(x_1, z_1))) < \frac{4}{3}\nu(z_1).$$

Moreover, Corollary 3.4.6.6 implies also :

$$\max(\nu(y_1 + x_1P(x_1, z_1), \nu(t_1 + z_1P(x_1, z_1))) < \nu(x_1)$$

When the component (x_1, z_1) is critically resonant, then the previous inequality does not necessarily hold since we cannot apply Corollary 3.4.6.7.

Our key observation is that the previous inequality remains valid whenever there exists a square S_1 adjacent to S along the edge containing $[t_1], [z_1]$ and such that its other edge containing $[z_1]$ is not critically resonant. If we choose S_1 so that the squares S_1, S, S' are flat, we arrive at the following situation where a blue edge means that the corresponding component is not critically resonant and a red edge that the component is critically resonant :

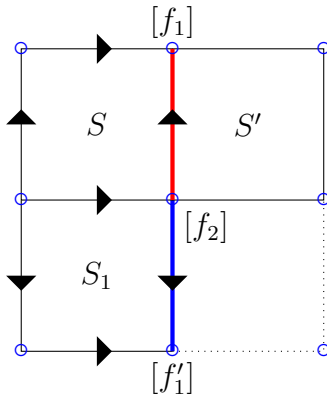

We now illustrate our argument in the following lemma.

Lemma 3.6.1.1. *Fix $\nu \in \mathcal{V}_0$ and S, S' two adjacent 2×2 squares. Consider v_1, v_2 two vertices of the common edge of these squares and suppose that v_1 is ν -minimal in S . Suppose that the edge joining v_1 and v_2 corresponds to a component (f_1, f_2) which is not critically resonant. Then for any vertex $v' \in S'$ distinct from v_1, v_2 , we have :*

$$\nu(v') < \min\left(\frac{4}{3}\nu(v_2), \nu(v_1)\right).$$

Proof. Observe that this lemma follows immediately from Corollary 3.4.6.7 and Corollary 3.4.6.6. □

The Proposition below is the key ingredient in our proof and explains how one can find a square which has an edge which is not critically resonant.

Proposition 3.6.1.2. *Fix a valuation $\nu \in \mathcal{V}_0$. Let S be any 2×2 square having a unique ν -minimal vertex, and let $[f_1], [f_2]$ be any horizontal (resp. vertical) edge of S . Suppose that $\nu(f_1) < \nu(f_2)$, that (f_1, f_2) is critically resonant and that for any polynomial $R \in k[x] \setminus k$, one has :*

$$\nu(f_1 - f_2R(f_2)) < \nu(f_2).$$

Then there exists a square S_1 adjacent to S along the vertical (resp. horizontal) edge containing $[f_2]$ which satisfies the following properties.

- (i) *For any square S_2 adjacent to S along the edge containing $[f_1], [f_2]$, the squares S_1, S, S_2 are flat.*
- (ii) *The horizontal (resp. vertical) edge in S_1 containing $[f_2]$ is not critically resonant.*
- (iii) *There exists an element $g \in A_{[f_2]}$ such that $g \cdot S = S_1$.*

Proof. Statement (i) and (iii) follow from Lemma 3.3.6.6.(ii) and Lemma 3.3.6.6.(i) respectively. Indeed pick any polynomial $R \in k[x] \setminus k$, and let S_R be the square containing $[f_2], [f_1 - f_2R(f_2)]$ which is adjacent to S along the vertical edge containing $[f_2]$. Since R depends on a single variable, it follows that for any square S_2 adjacent to S along the edge containing $[f_1], [f_2]$, the squares S_R, S_2, S are flat.

We now prove (ii), and produce a polynomial $R \in k[x] \setminus k$ such that the component $(f_2, f_1 - f_2R(f_2))$ is not critically resonant. Since the component (f_1, f_2) is critically resonant, there exists a constant $\lambda \in k^*$ and an integer $n \geq 1$ such that

$$\nu(f_1 - \lambda f_2^n) > \nu(f_1) = n\nu(f_2).$$

Since $\nu(f_1) < \nu(f_2)$, we get $n \geq 2$ so that $R_1 := \lambda x^{n-1} \in k[x] \setminus k$.

If the component $(f_2, f_1 - f_2R_1(f_2))$ is not critically resonant, then the square S_1 containing $[f_2], [f_1 - f_2R_1(f_2)]$ which is adjacent to S along the vertical edge containing $[f_2]$ satisfies assertion (ii) and we are done. Otherwise, $(f_2, f_1 - f_2R_1(f_2))$ is critically resonant. Observe that by assumption, we have

$$\nu(f_1 - f_2R_1(f_2)) < \nu(f_2) ,$$

so that $\nu(f_1 - f_2R_1(f_2)) = n_2\nu(f_2)$ for some $n_2 \geq 1$, and $\nu(f_1 - f_2R_2(f_2)) > n_2\nu(f_2)$ for some polynomial $R_2 \in k[x] \setminus k$ of the form $R_2(x) = R_1(x) + \lambda'x^{n_2-1}$. Repeating this argument we get a sequence of polynomials $R_i \in k[x] \setminus k$, and either $(f_2, f_1 - f_2R_i(f_2))$ is not critically resonant for some index i ; or $(f_2, f_1 - f_2R_i(f_2))$ is critically resonant for all i . However in the latter case, the sequence $(\nu(f_1 - f_2R_i(f_2)))$ is strictly increasing and $(\nu(f_1 - f_2R_i(f_2)))$ are all multiples of $\nu(f_2)$ which yields a contradiction. The proof is complete. □

3.6.2 Degree estimates at a ν -maximal vertex

In this section, we analyze the situation of two 2×2 squares adherent at a vertex of type I .

Recall from Section 3.3.6 that a pair of adherent squares (S, S') is contained in a spiral staircase if there exists a sequence of squares $S_0 = S, \dots, S_p = S'$ connecting S and S' which are adjacent alternatively along vertical and horizontal edges and such that any three consecutive squares S_i, S_{i+1}, S_{i+2} are not flat for $i \leq p - 2$. When the intersection between S_0 and S_1 is a horizontal (resp. vertical) edge, we say that the staircase is vertical (resp. horizontal).

Theorem 3.6.2.1. *Fix a valuation $\nu \in \mathcal{V}_0$.*

Consider three 2×2 squares S, S_1 and S' having a vertex $[x_1]$ of type I in common. We assume that S and S_1 have a common horizontal edge $[x_1], [y_1]$, and that the pair (S, S') is

contained in a vertical spiral staircase containing S_1 . Denote by $[z_1]$ the vertex in S_1 which forms a vertical edge with $[x_1]$.

Assume that $[x_1]$ is ν -maximal in S_1 , that the component (x_1, z_1) is not critically resonant, that $\nu(z_1) < \nu(y_1)$ and $\nu(z_1) < (4/3)\nu(x_1)$. Then for any vertex $v \in S'$ distinct from $[x_1]$, one has :

$$\nu(v) < \frac{4}{3}\nu(x_1).$$

The following figure summarizes the situation of the Theorem.

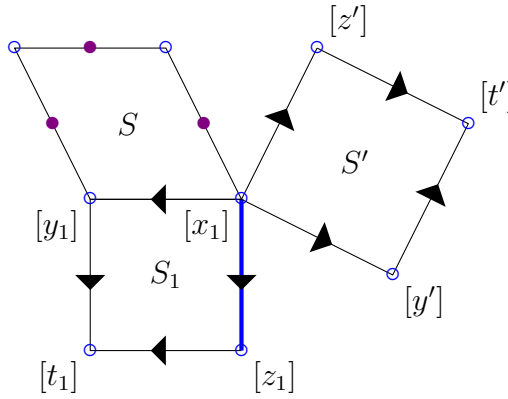

We shall use repeatedly the following lemma, whose proof is given at the end of this section.

Recall from Section 3.3.5 the definition of the subgroup A_v of the stabilizer of a vertex v of type I.

Lemma 3.6.2.2. *Take three 2×2 squares S_1, S_2, S_3 containing $[x_1]$ and which are adjacent alternatively along vertical and horizontal edges. Suppose that S_1, S_2 and S_3 are not flat. Then the following assertions hold.*

- (i) *Suppose that S'_1 is a 2×2 square which is adjacent to S_2 along $S_1 \cap S_2$ such that there exists an element $g \in A_{[x_1]}$ for which $g \cdot S_1 = S'_1$. Then the squares S'_1, S_2, S_3 are not flat.*
- (ii) *For any 2×2 squares S'_1, S'_2 such that S_1, S_2, S'_1, S'_2 are flat, the squares S'_1, S'_2, S_3 are not flat. Moreover, given any $g_1, g_2 \in \text{Stab}([x_1]) \cap \text{STame}(\mathcal{Q})$ such that $g_1 S_1 = S'_1$, and $g_2 S_2 = S'_2$, we have $g_1, g_2 \in A_{[x_1]}$.*

This lemma will allow us to consider alternative spiral staircase around the vertex $[x_1]$. We thus have the following figures in each situation.

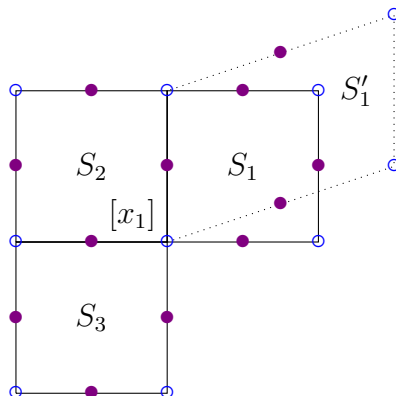

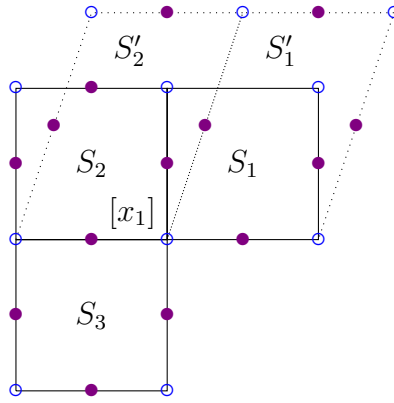

Proof of Theorem 3.6.2.1. Take a valuation $\nu \in \mathcal{V}_0$ and three squares S, S_1, S' satisfying the conditions of the theorem. By assumption, there exists an integer $p \geq 2$ and a sequence of adjacent squares S_2, \dots, S_{p-1} such that $S_0 = S, S_1, S_2, \dots, S_p = S'$ forms a vertical staircase.

We denote by $[y_1], [z_1], [t_1], [x_1]$ and $[z'], [y'], [t']$ the vertices of S_1 and S' respectively so that the edges $[x_1], [y_1]$ and $[x_1], [y']$ are horizontal and the edges $[x_1], [z_1]$ and $[x_1], [z']$ are vertical. We are thus in the following situation.

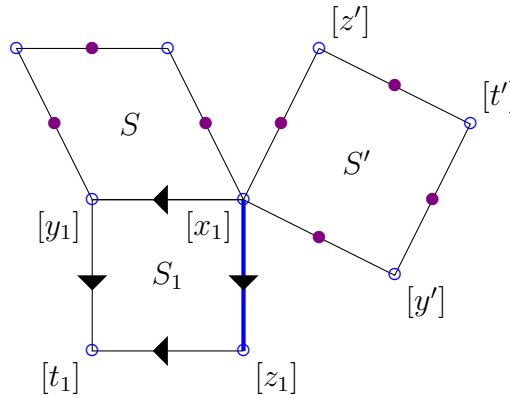

Recall that S and S' are connected by a vertical staircase $S = S_0, S_1, \dots, S_{p-1}, S_p = S'$.

Lemma 3.6.2.3. *The theorem holds whenever the edges $S_i \cap S_{i+1}$ are not critically resonant for all $i \geq 1$.*

Lemma 3.6.2.4. *For any vertex v such that $[x_1], v$ is an edge of S' , there exists a vertical staircase $S = S_0, \tilde{S}_1, \tilde{S}_2, \dots, \tilde{S}_{q-1}, \tilde{S}_q$ such that*

- $\tilde{S}_1 = S_1$;
- \tilde{S}_q and S' are adjacent along the edge $[x_1], v$;
- the edges $\tilde{S}_i \cap \tilde{S}_{i+1}$ are not critically resonant for all $i \geq 1$.

Take any vertex v of S' such that $[x_1], v$ is an edge of S' . By Lemma 3.6.2.4 we get a sequence of squares \tilde{S}_i connecting S to \tilde{S}_q and satisfying the assumptions of Lemma 3.6.2.3. This proves $\nu(v) < \frac{4}{3}\nu(x_1)$ as required. □

Proof of Lemma 3.6.2.3. We prove by induction on i the following two properties :

(\mathcal{P}_1) For any vertex $v \neq [x_1]$ in $S_i \setminus S_0$, one has :

$$\nu(v) < \frac{4}{3}\nu(x_1).$$

(\mathcal{P}_2) Let $v_1 \neq [x_1]$ be the unique vertex which is contained in the edge $S_i \cap S_{i-1}$ and let v_2 be the other vertex in S_i which belongs to an edge containing $[x_1]$. Then one has :

$$\nu(v_2) < \nu(v_1).$$

Observe that (\mathcal{P}_1) and (\mathcal{P}_2) are satisfied when $i = 1$ by our standing assumption on S_1 .

Let us prove the induction step. For all i , denote by t_i the unique vertex of S_i which does not lie in $S_{i-1} \cup S_{i+1}$; by y_i the vertex in $S_i \cap S_{i-1}$ distinct from x_1 . We also write z_i for the vertex in $S_i \cap S_{i+1}$ distinct from x_1 (so that $y_{i+1} = z_i$). We thus have the following picture :

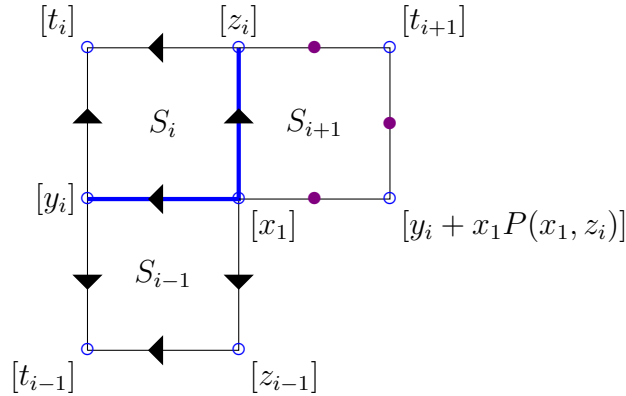

By our induction hypothesis, we have :

$$\nu(z_i) < \nu(y_i) < \nu(x_1) .$$

Observe that y_{i+1} is given by :

$$y_{i+1} = y_i + x_1 P(x_1, z_i).$$

for some polynomial $P \in k[x, y]$. Since the squares (S_{i-1}, S_i, S_{i+1}) is not flat, Lemma 3.3.6.6.(i) and Lemma 3.3.6.3 imply that that $P \notin k[x]$.

Since the component (x_1, z_i) is not critically resonant, Corollary 3.4.6.6 and Corollary 3.4.6.7 applied to $f_1 = z_i$ and $f_2 = x_1$ imply :

$$\nu(x_1 P(x_1, z_i)) < \min \left(\frac{4}{3} \nu(x_1), \nu(z_i) \right) ,$$

hence :

$$\nu(y_{i+1}) = \nu(y_i + x_1 P(x_1, z_i)) = \nu(x_1 P(x_1, z_i)) < \min \left(\frac{4}{3} \nu(x_1), \nu(z_i) \right) .$$

This proves that $[x_1]$ is ν -maximal in S_{i+1} , hence $[t_{i+1}]$ is ν -minimal in S_{i+1} by Lemma 3.5.4.2 and assertion (\mathcal{P}_1) and (\mathcal{P}_2) hold for $i + 1$, as required. \square

Proof of Lemma 3.6.2.4. We prove by induction on the length of the vertical staircase, i.e. on p the following stronger version of the lemma. For any vertex v such that $[x_1], v$ is an edge of S' , there exists a vertical staircase $S = S_0, \tilde{S}_1, \tilde{S}_2, \dots, \tilde{S}_{q-1}, \tilde{S}_q$ such that

- $\tilde{S}_1 = S_1$;
- \tilde{S}_q and S' are adjacent along the edge $[x_1], v$, and there exists an element $g \in A_{[x_1]}$ for which $g \cdot \tilde{S}_q = S'$.
- the edges $\tilde{S}_i \cap \tilde{S}_{i+1}$ are not critically resonant for all $i \geq 1$.

For $p = 2$, we may choose $\tilde{S}_1 = S_1$, $\tilde{S}_2 = S'$, and there is nothing to prove since $[x_1], [z_1]$ is not critically resonant by our standing assumption.

Let us prove the induction step. Suppose that the claim is true for any staircase of length p , and pick a staircase $(S = S_0, S_1, \dots, S_{p+1} = S')$ joining S to S' . By the induction step applied to the vertex $v_p \in S_p \cap S_{p+1}$ distinct from x_1 , we may find another vertical spiral staircase $(S = S_0, S_1 = \tilde{S}_1, \tilde{S}_2, \dots, \tilde{S}_q)$ such that the edges $\tilde{S}_i \cap \tilde{S}_{i+1}$ are not critically resonant for all $1 \leq i \leq q$, and there exists an element $g \in A_{[x_1]}$ for which $g \cdot \tilde{S}_q = S_p$.

Observe that the \tilde{S}_q and S_{p+1} are adjacent along the edge containing $[x_1], v_p$. Since S_{p-1}, S_p, S_{p+1} are not flat, Lemma 3.6.2.2.(ii) implies that the squares $\tilde{S}_{q-1}, \tilde{S}_q, S_{p+1}$ are also not flat.

If the edge $S_{p+1} \cap \tilde{S}_q$ is not critically resonant, the proof is complete. Otherwise, the edge $\tilde{S}_q \cap S_{p+1}$ is critically resonant. Denote by $[z_q]$ and v' the vertices in \tilde{S}_q distinct from x_1 and lying in S' and \tilde{S}_{q-1} respectively. By Lemma 3.6.2.3, we have $\nu(z_q) < \nu(v') < \nu(x_1)$, and we have the following picture.

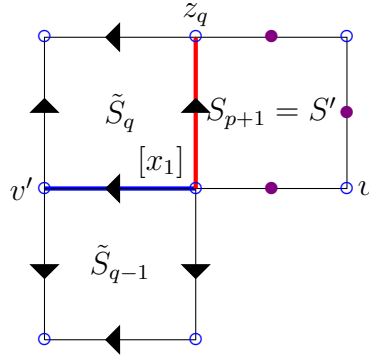

We claim that

$$\nu(z_q - x_1 R(x_1)) < \nu(x_1).$$

for any polynomial $R \in k[x] \setminus k$. Taking this claim for granted we conclude the proof of the lemma. By Proposition 3.6.1.2, we may find a square S''_q adjacent to \tilde{S}_q along the edge containing $[x_1], v'$ whose edges containing $[x_1]$ are not critically resonant and such that the triple $\tilde{S}_q, S''_q, S_{p+1}$ is flat. Let \tilde{S}_{q+1} be the 2×2 square completing the 4×4 square containing $\tilde{S}_q, S''_q, S_{p+1}$.

Since the squares $\tilde{S}_{q-1}, \tilde{S}_q$ and S_{p+1} are not flat, Lemma 3.6.2.2.(ii) implies that the triple \tilde{S}_{q-1}, S''_q and S'_{p+1} is also not flat, so that the sequence $(S_1, \tilde{S}_2, \dots, \tilde{S}_{q-1}, S''_q, \tilde{S}_{q+1})$ is contained in a spiral staircase such that any edge lying in two consecutive squares is not critically resonant. Lemma 3.6.2.2.(ii) applied to $\tilde{S}_{q-1}, \tilde{S}_q, S_{p+1}$ implies the existence of an element $g \in A_{[x_1]}$ such that $g \cdot \tilde{S}_{q+1} = S_{p+1}$. This finishes the proof of the induction step.

We now prove our claim. Fix a polynomial $R \in k[x] \setminus k$, and consider the square S_R containing $[x_1], [z_p - x_1 R(x_1)]$ and v' . Since $xR(x) \in k[x]$, the squares S_R, \tilde{S}_q and S_{p+1} are flat by Lemma 3.3.6.6.(ii). We thus have the following picture.

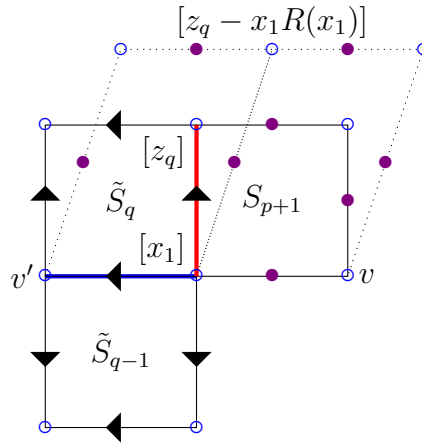

By Lemma 3.3.6.6, there exists an element $g \in A_{[x_1]}$ such that $g \cdot \tilde{S}_q = S_R$. By Lemma 3.6.2.2.(i) the triple $\tilde{S}_{q-2}, \tilde{S}_{q-1}, S_R$ are not flat since $\tilde{S}_{q-2}, \tilde{S}_{q-1}, \tilde{S}_q$ are not flat. We have thus proven that the sequence $(S, S_1, \tilde{S}_2, \dots, \tilde{S}_{q-1}, S_R)$ is contained in a spiral staircase for which any edge lying in two consecutive squares is not critically resonant. By Lemma 3.6.2.3 the vertex $[x_1]$ is ν -maximal in S_R , hence :

$$\nu(z_q - x_1 R(x_1)) < \nu(x_1),$$

as required. □

Proof of Lemma 3.6.2.2. By transitivity of the action of $\text{STame}(\mathcal{Q})$ on the 2×2 squares, we can suppose that S_2 is the standard 2×2 square containing $[x], [t], [y], [z]$ and that S_1 and S_3 are adjacent along the vertical and horizontal edge containing $[x]$ respectively. Take $g_1, g_3 \in \text{Stab}([x]) \cap \text{STame}(\mathcal{Q})$ such that $g_1 \cdot S_2 = S_1$ and $g_3 S_2 = S_3$.

Let us prove assertion (i). Since S_1, S_2, S_3 are not flat, Lemma 3.3.6.3 implies that $g_1, g_3 \notin A_{[x]}$. Observe that $g g_1 \cdot S_2 = S'_1$ and $g_3 \cdot S_2 = S_3$ where $g \circ g_1 \notin A_{[x]}$, hence the squares S'_1, S_2, S_3 are also not flat by Lemma 3.3.6.3.

Let us prove assertion (ii).

Consider $g, g' \in \text{Stab}([x]) \cap \text{STame}(\mathcal{Q})$ such that $g \cdot S_1 = S'_1, g' \cdot S_2 = S'_2$. Since $g_1 \notin A_{[x]}$ but the squares S'_1, S_1, S_2 are flat, Lemma 3.3.6.3 implies that $g, g' \in A_{[x]}$. Observe that $g g_1 g'^{-1} \cdot S'_2 = S'_1$ and $g_3 g'^{-1} \cdot S'_2 = S_3$ and that $g \circ g_1 \circ g'^{-1}, g_3 \circ g'^{-1} \notin A_{[x]}$, hence the squares S'_1, S'_2, S_3 are not flat by Lemma 3.3.6.3. □

3.6.3 Degree at a non-extremal vertex

Theorem 3.6.3.1. *Take a valuation $\nu \in \mathcal{V}_0$. Consider two 2×2 adherent squares S and S' at a vertex of type I given by $[x_1]$ with $x_1 \in k[\mathcal{Q}]$ such that the pair (S, S') is contained in a vertical spiral staircase. Denote by $[y_1]$ the unique vertex in S distinct from $[x_1]$ which belongs to the horizontal edge containing $[x_1]$. Suppose that the edge containing $[x_1], [y_1]$ is not critically resonant. Then for any vertex v distinct from $[x_1]$ in S' one has :*

$$\nu(v) < \frac{4}{3}\nu(x_1).$$

One has the following picture :

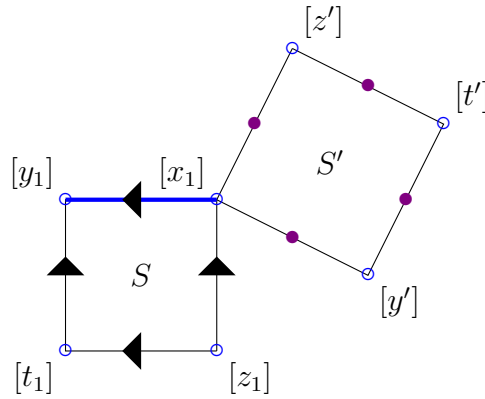

Remark 3.6.3.2. By symmetry, observe that the same assertion holds if \$[z_1]\$ is \$\nu\$-minimal in \$S\$ and the pair \$(S, S')\$ is contained in a horizontal spiral staircase.

Proof. Consider two squares \$S, S'\$ and the vertices \$[x_1], [y_1] \in S\$ satisfying the conditions of the Theorem. By definition, there exists an integer \$p\$ and \$p\$ adjacent squares \$S_0 = S, \dots, S_p = S'\$ containing \$[x_1]\$ connecting \$S\$ and \$S'\$.

Since \$S_0 = S\$ and \$S_1\$ are adjacent, the vertex \$[x_1]\$ is \$\nu\$-maximal in \$S_1\$ by Lemma 3.5.4.3.

Denote by \$[z_1]\$ the vertex in \$S_1\$ such that the vertices \$[x_1]\$ and \$[z_1]\$ are contained in the vertical edge of \$S_1\$ so that we are in the following situation :

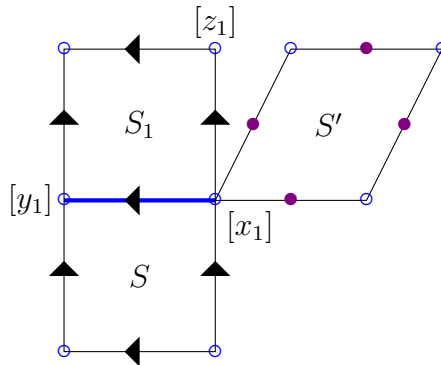

Fix any polynomial \$R \in k[x] \setminus k\$. Consider \$S_R\$ the square containing \$[x_1], [y_1]\$ and \$[z_1 - x_1R(x_1)]\$. By Lemma 3.3.6.6, the squares \$S_1, S_R, S_2\$ are flat. Take \$\tilde{S}_R\$ the \$2 \times 2\$ square completing the \$4 \times 4\$ square containing \$S_1, S_R, S_2\$. Lemma 3.6.2.2.(ii) implies that \$S, S_R, \tilde{S}_R\$ are not flat since \$S, S_1, S_2\$ are not flat. This proves in particular that the vertex \$[x_1]\$ is \$\nu\$-maximal in \$S_R\$, hence :

$$\nu(z_1 - x_1R(x_1)) < \nu(x_1).$$

By Proposition 3.6.1.2, there exists a square \$S'_1\$ adjacent to \$S\$ along \$[x_1], [y_1]\$ such that the squares \$S'_1, S_1, S_2\$ are flat and such that the vertical edge in \$S'_1\$ containing \$[x_1]\$ is not critically resonant. Consider the square \$S'_2\$ completing the \$4 \times 4\$ square containing \$S'_1, S_1, S_2\$. By construction, the edge \$S'_1 \cap S'_2\$ is not critically resonant. Observe also that Lemma 3.6.1.1 implies that for any vertex \$v \in S'_1\$ distinct from \$[x_1]\$ and \$[y_1]\$, one has :

$$\nu(v) < \max \left(\nu(y_1), \frac{4}{3}\nu(x_1) \right).$$

Suppose that \$p \geq 3\$, then the triple \$(S, S'_1, S')\$ satisfies the assumptions of Theorem 3.6.2.1 and we conclude that for any vertex \$v\$ distinct from \$[x_1]\$ in \$S'\$:

$$\nu(v) < \frac{4}{3}\nu(x_1).$$

We have thus proven the theorem.

Suppose that $p = 2$ and the squares S' and S_1 are adjacent. We are thus in the following situation :

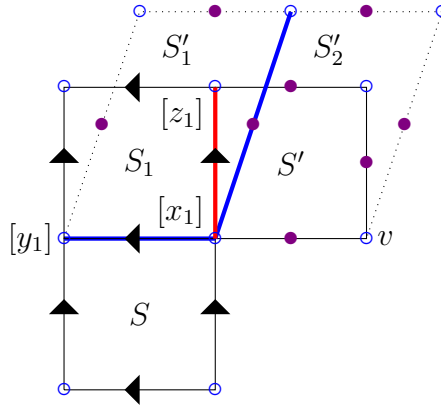

where v is the unique vertex in S' distinct from $[x_1]$ which belongs to the horizontal edge containing $[x_1]$. By Theorem 3.6.2.1, $[x_1]$ is ν -maximal in S'_2 , hence it is also ν -maximal in S' and $\nu(v) < 4/3\nu(x_1)$. Observe also that Lemma 3.6.1.1 implies that :

$$\nu(z_1) < \frac{4}{3}\nu(x_1).$$

This proves that for any $v \in S'$ distinct from $[x_1]$, one has :

$$\nu(v) < \frac{4}{3}\nu(x_1),$$

and the theorem holds. □

3.6.4 Degree estimates on a band

We investigate the behavior of the degree on a band of width 2.

Theorem 3.6.4.1. *Take a valuation $\nu \in \mathcal{V}_0$. Let v be any ν -maximal vertex of a 2×2 square S . Suppose that for any square \tilde{S} adjacent to S along the horizontal edge containing v , the vertex v is also ν -maximal in S . Let $S = S_0, S_1, \dots, S_p$ be a sequence of squares such that*

- S_1 is adjacent to S along the vertical edge of S not containing v ;
- S_i is adjacent to S_{i+1} along a vertical edge for all $0 \leq i \leq p - 1$;
- $S_i \cap S_{i-1} \cap S_{i+1} = \emptyset$ for all $1 \leq i \leq p - 1$.

Then S_p admits unique ν -minimal vertex and for any vertex $v' \notin S_{p-1}$, we have

$$\nu(v') < \left(\frac{4}{3}\right)^p \nu(v_2) ,$$

where v_2 is the vertex in $S \cap S_1$ which is not ν -minimal.

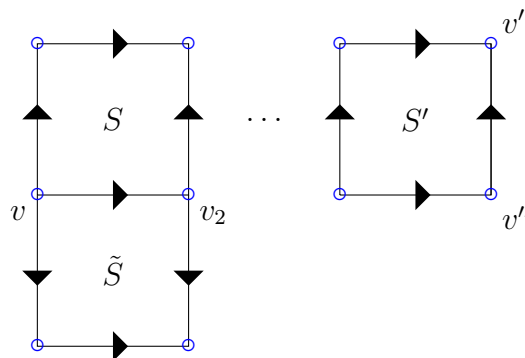

Proof. Lemma 3.5.4.3 and a straightforward induction shows that each square S_i has a ν -maximal vertex lying in $S_i \cap S_{i-1}$, and a ν -minimal vertex lying in $S_i \setminus S_{i-1}$. For each $0 \leq i \leq p$, we denote by $[x_i]$ the ν -minimal vertex in S_i and by $[z_i] \in S_i$ the vertex forming the edge $S_i \cap S_{i+1}$ with $[x_i]$, see the figure below. Observe that $v = [z_0]$ and $v_2 = [z_1]$.

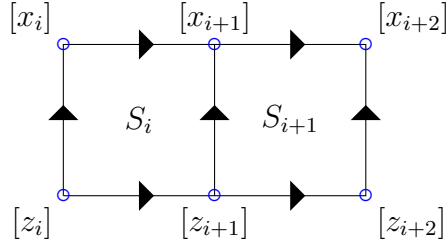

Let us introduce the following three properties :

(A_i) One has :

$$\nu(z_{i+1}) \leq \left(\frac{4}{3}\right)^i \nu(z_1).$$

(B_i) For any square \tilde{S} adjacent to S_i along $[z_i], [z_{i+1}]$, the vertex $[z_i]$ is ν -maximal in \tilde{S} .

(C_i) If the edge containing $[x_{i+1}], [z_{i+1}]$ is critically resonant, then there exists a square \tilde{S} adjacent to S_i along $[z_i], [z_{i+1}]$ such that the squares S_i, \tilde{S}, S_{i+1} are flat and the vertical edge in \tilde{S} containing $[z_{i+1}]$ is not critically resonant.

Observe that (A₀) is true trivially, and (B₀) is true by assumption. Our theorem will be proved if we are able to show the implications (B_i) \implies (C_i), (A_i)&(B_i)&(C_i) \implies (A_{i+1}) and (B_i)&(C_i) \implies (B_{i+1}) for all $1 \leq i \leq p-1$.

— (B_i) \implies (C_i)

Fix a polynomial $R \in k[x] \setminus k$, and let S_R be the adjacent square containing $[z_{i+1}], [z_i]$ and $[x_{i+1} - z_{i+1}R(z_{i+1})]$. The square S_R is adjacent to S_i along $[z_i], [z_{i+1}]$, hence by (B_i) the vertex $[z_i]$ is ν -maximal in S_R , and

$$\nu(x_{i+1} - z_{i+1}R(z_{i+1})) < \nu(z_{i+1}).$$

By Proposition 3.6.1.2 applied to the edge $[x_{i+1}], [z_{i+1}]$, there exists a square \tilde{S} adjacent to S_i along $[z_i], [z_{i+1}]$ which satisfies the required conditions. We have thus proven (C_i).

— (A_i)&(B_i)&(C_i) \implies (A_{i+1})

Suppose that (x_{i+1}, z_{i+1}) is not critically resonant, then Lemma 3.6.1.1 (i) applied to S_i, S_{i+1} implies $\nu(z_{i+2}) < 4/3\nu(z_{i+1})$ hence by (A_i)

$$\nu(z_{i+2}) < \left(\frac{4}{3}\right)^{i+1} \nu(z_1),$$

proving (A_{i+1}) as required.

Suppose that the component (x_{i+1}, z_{i+1}) is critically resonant, then by assertion (C_i) and (B_i), we can find a square \tilde{S} adjacent to S_i along $[z_i], [z_{i+1}]$ such that S_i, S_{i+1}, \tilde{S} are flat and the vertical edge containing $[z_{i+1}]$ is not critically resonant. Observe that assertion (B_i) implies that $[z_i]$ is ν -maximal in \tilde{S} and we have the following picture :

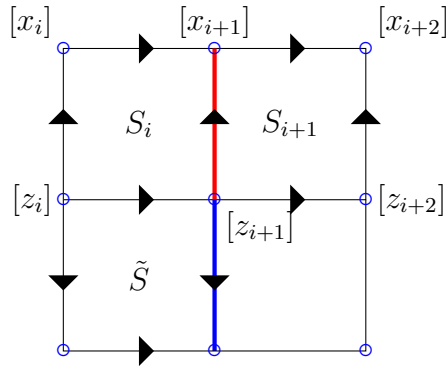

By Lemma 3.6.1.1 (i) applied to \tilde{S} , we get

$$\nu(z_{i+2}) < \frac{4}{3}\nu(z_{i+1}) < \left(\frac{4}{3}\right)^{i+1} \nu(z_1),$$

as required.

$$- (B_i) \& (C_i) \implies (B_{i+1})$$

Fix a square \tilde{S} which is adjacent to S_{i+1} along $[z_{i+1}], [z_{i+2}]$. We need to prove that $[z_{i+1}]$ is ν -maximal in \tilde{S} . If the squares S_i, S_{i+1}, \tilde{S} are flat, denote by \tilde{S}_i the 2×2 squares completing the 4×4 square containing S_i, S_{i+1}, \tilde{S} . Then assertion (B_i) implies that $[z_i]$ is ν -maximal in \tilde{S}_i , hence by Lemma 3.5.4.3 applied to the adjacent squares \tilde{S}_i, \tilde{S} , the vertex $[z_{i+1}]$ is also ν -maximal in \tilde{S} , as required.

Otherwise the squares (S_i, \tilde{S}) are contained in a horizontal spiral staircase. Suppose first that the component (x_{i+1}, z_{i+1}) is not critically resonant. Then the squares (S_i, \tilde{S}) satisfy the assumptions of Theorem 3.6.3.1, hence $[z_{i+1}]$ is ν -maximal in \tilde{S} , proving (B_{i+1}) as required (see the figure below).

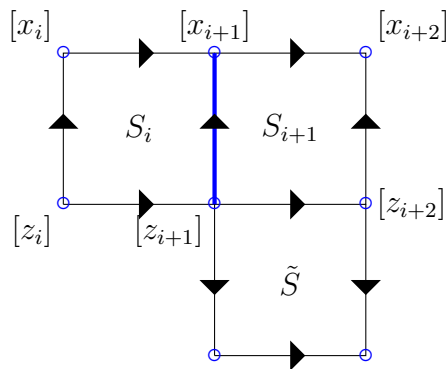

Suppose that the component (x_{i+1}, z_{i+1}) is critically resonant. By assertion (C_i) , we can find a square \tilde{S}_i adjacent to S_i along $[z_i], [z_{i+1}]$ such that $\tilde{S}_i, S_i, S_{i+1}$ are flat and the vertical edge in \tilde{S} containing $[z_{i+1}]$ is not critically resonant. Take \tilde{S}_{i+1} the 2×2 square completing the 4×2 square containing $S_i, S_{i+1}, \tilde{S}_i$. By Lemma 3.6.2.2.(ii), the squares $\tilde{S}_i, \tilde{S}_{i+1}, \tilde{S}$ are not flat since the squares S_i, S_{i+1}, \tilde{S} are not flat (see the figure below). We have thus proven that (\tilde{S}_i, \tilde{S}) is contained in a horizontal spiral staircase, and the edge $\tilde{S}_i \cap \tilde{S}_{i+1}$ is not critically resonant. This implies by Theorem 3.6.3.1 that $[z_i]$ is ν -maximal in \tilde{S} , proving (B_{i+1}) as required.

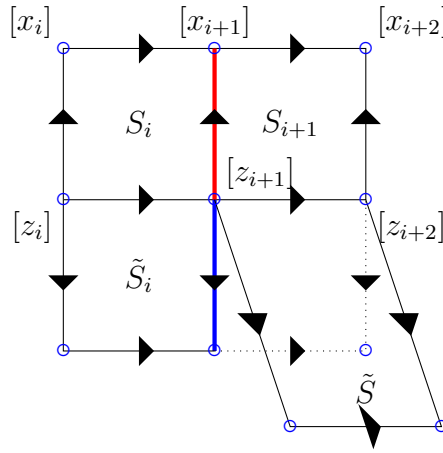

□

3.6.5 Degree estimates at a ν -minimal vertex

Theorem 3.6.5.1. *Consider any valuation $\nu \in \mathcal{V}_0$. Let S and S' be two adjacent 2×2 squares intersecting at a vertex v which is ν -minimal in S . Then the following holds.*

- (i) *The vertex v is the ν -maximal vertex of S' .*
- (ii) *If v' is a vertex in S' which does not belong to any band containing S , then we have :*

$$\nu(v') < \frac{4}{3}\nu(v)$$

Remark 3.6.5.2. Suppose that the vertex $v \in S'$ belongs in a band containing S , then we will apply the estimates in Theorem 3.6.4.1 instead.

Proof. Let us prove assertions (i) and (ii).

Suppose first that S and S' belong to a 4×4 squares containing S, S', S_1 and S_2 as in the figure below. Since S, S_1 and S, S_2 are adjacent along an edge containing v , Lemma 3.5.4.3 implies that we are in the following situation :

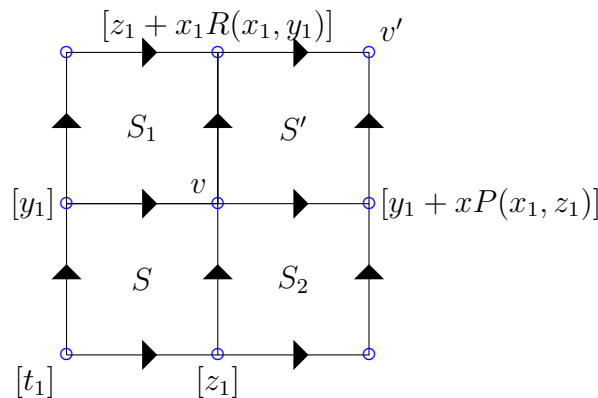

where $v = [x_1], [y_1], [z_1], [t_1] \in S$ and $P, R \in k[x, y] \setminus k$. Observe that v is ν -maximal in S' and we have proved assertion (i). Since the squares S, S_1, S_2 are flat, Lemma 3.3.6.6 and Lemma 3.3.6.3 imply that $P \in k[x] \setminus k$ or $R \in k[x] \setminus k$. Suppose that $P \in k[x] \setminus k$, then we have $(4/3)\nu(x_1) > \nu(y_1 + x_1 P(x_1)) = (\deg(P) + 1)\nu(x_1) > \nu(v')$ proving (ii) as required.

Suppose next that (S, S') is contained in a spiral staircase. Choose a sequence of squares $S_0 = S, \dots, S_p = S'$ of squares containing v and connecting S and S' such that each triple of consecutive squares is not flat. By symmetry, we can suppose that S_0 and S_1 are adjacent

along a horizontal edge containing v . Observe that Lemma 3.5.4.3 applied to S, S_1 implies that the edge $S_1 \cap S_2$ contains the ν -minimal vertex in S_1 .

If the edge $S_1 \cap S_2$ is not critically resonant, then the pair (S_1, S') is contained in a horizontal staircase so that one has the following picture :

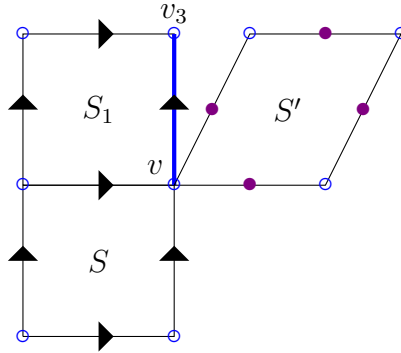

By Theorem 3.6.3.1, the vertex v is ν -minimal in S' and one has $\nu(v') < (4/3)\nu(v)$ for all $v' \neq v$ in S' . We have thus proved assertion (i) and (ii).

We now suppose that the edge $S_1 \cap S_2$ is critically resonant. Denote by $[f_1]$ the ν -minimal vertex in S_1 and by $v = [f_2]$. Fix any polynomial $R \in k[x] \setminus k$ and take S_R the square containing $[f_1 - f_2R(f_2)], [f_2]$ and the edge $S_1 \cap S_0$. Lemma 3.3.6.6.(ii) implies that the squares S_1, S_R, S_2 are flat. Take S'_R the 2×2 square completing the 4×4 square containing S_1, S_R, S_2 . Since the squares S, S_1, S_2 are not flat, Lemma 3.6.2.2 implies that S, S_R, S'_R are also not flat. In particular, the squares S and S_R intersect along an edge containing v , Lemma 3.5.4.3 implies that

$$\nu(f_1 - f_2R(f_2)) < \nu(f_2).$$

By Proposition 3.6.1.2 applied to the edge $[f_1], [f_2]$, we can find a square S'_1 adjacent to S along $S \cap S_1$ and $g \in A_v$ such that $g \cdot S_1 = S'_1$ and such that the vertical edge containing v in S_1 is not critically resonant. By Lemma 3.3.6.3, the squares S_1, S'_1, S_2 are flat. Take S'_2 the 2×2 square completing the 4×4 square containing S_1, S_2, S'_1 . As the three squares S, S_1, S_2 are not flat, Lemma 3.6.2.2 implies that the squares S, S'_1, S'_2 are also not flat.

If $p \geq 3$, then the pair (S'_1, S_p) is contained in a horizontal spiral staircase and the edge $S'_1 \cap S'_2$ is not critically resonant. Hence, by Theorem 3.6.3.1, the vertex v is ν -maximal in S' and for any vertex v' distinct from v in S' , one has :

$$\nu(v') < \frac{4}{3}\nu(v),$$

proving (i) and (ii) as required.

Suppose that $p = 2$ so that $S_2 = S'$. Observe that S'_2 and S' are adjacent along a horizontal edge containing v . Since v is ν -maximal in S'_2 , it is also ν -maximal on the edge $S'_2 \cap S'$. Since v is ν -maximal on the vertical edge $S_1 \cap S'$, we have thus proven that v is ν -maximal in S' and assertion (i) holds. Take v_2 the vertex contained in $S' \cap S'_2$ distinct from v . Since the edge $S'_1 \cap S'_2$ is not critically resonant, Lemma 3.6.1.1 implies that $\nu(v_2) < 4/3\nu(v)$. Hence, for any vertex $v' \in S'$ not contained in the same band as S , one has $\nu(v') < (4/3)\nu(v)$ proving (ii) as required.

□

3.6.6 Proof of Theorem 3.6.0.1

Take S_0 the standard square containing $[x], [y], [z], [t]$. Fix a valuation $\nu \in \mathcal{V}_0$ such that :

$$\max(\nu(y) + \nu(t), \nu(z) + \nu(t)) < \nu(x) < \min(\nu(y), \nu(z), \nu(t)).$$

Pick any vertex v of type I such that the geodesic segment in \mathcal{C} joining [Id] to v intersects an edge of the standard square. Choose any geodesic segment $\gamma : [0, n] \rightarrow \mathcal{C}_\nu$ joining $[t]$ to v such that the sequence $(\nu(\gamma(i)))_{0 \leq i \leq n}$ is maximal for the lexicographic order in \mathbb{R}^{n+1} among all geodesic segments joining $[t]$ to v . Pick any sequence $\tilde{S}_0, \dots, \tilde{S}_{n-1}$ of 2×2 squares such that $\gamma(i), \gamma(i+1) \in \tilde{S}_i$ for all $i \leq n-1$. We claim that the following properties hold.

- (A) The vertex $\gamma(i)$ is the unique ν -maximal vertex in \tilde{S}_i for all $0 \leq i \leq n-1$.
- (B) We have $\nu(\gamma(i+1)) < \frac{4}{3}\nu(\gamma(i))$ for all $1 \leq i \leq n-1$.
- (C) For any other valuation $\nu' \in \mathcal{V}_0$ satisfying (3.9), the vertex $\gamma(i)$ is also ν' -maximal in \tilde{S}_i for all $0 \leq i \leq n-1$.

Observe first that these properties (A), (B) and (C) imply Theorem (i) and (ii).

Observe the slight discrepancy in the indices between (A), (C) and (B). We do not claim that $\nu(\gamma(1)) < \frac{4}{3}\nu([t])$ in general. This claim is however sufficient to imply Theorem 3.6.0.1 (1) and (2).

Observe that assertion (C) implies that $d_\nu([t], v) \geq d_{\nu'}([t], v)$ and we conclude by symmetry that $d_\nu([t], v) = d_{\nu'}([t], v)$ for any other valuation $\nu' \in \mathcal{V}_0$ satisfying (3.9). This proves that assertion 2 of the theorem holds.

We shall prove the claim by induction on $n \geq 1$. Fix another valuation $\nu' \in \mathcal{V}_0$ satisfying (3.9).

Suppose $n = 1$. There is only one square \tilde{S}_0 containing $[t]$ and v (it may not be the standard square). Since $n = 1$, we only need to prove assertions (A) and (C).

Lemma 3.6.6.1. *Take any 2×2 square S adjacent to the standard square S_0 along an edge containing $[t]$. Then the vertex $[t]$ is ν -maximal in S .*

Moreover, denote by v_1 the vertex in $S \cap S_0$ distinct from $[t]$ in S and by v_2 the vertex distinct from v_1 for which the vertices $[t], v_2$ form an edge of S . Then one has $\nu(v_2) < \nu(v_1)$.

Grant this lemma. If \tilde{S}_0 and S_0 are adjacent along an edge containing $[t]$ Lemma 3.6.6.1 implies assertions (A) and (C) immediately. Suppose now that \tilde{S}_0 and S_0 are adherent at $[t]$. If the squares \tilde{S}_0 and S_0 are flat, then Lemma 3.6.6.1 applied to the two squares adjacent to both S_0 and \tilde{S}_0 again implies that $[t]$ is also ν -maximal and ν' -maximal in \tilde{S}_0 .

Otherwise (S_0, \tilde{S}_0) are contained in a spiral staircase. Take an integer $p \geq 2$ and a sequence of squares $S_0, S'_1, \dots, S'_p = \tilde{S}_0$ connecting S_0 to \tilde{S}_0 such that each three consecutive squares are not flat. If the edge $S_0 \cap S'_1$ is not critically resonant, take $[f_1]$ the vertex distinct from $[t]$ of the edge $S'_2 \cap S'_1$. Denote by $[f_2]$ the vertex in $S_0 \cap S'_1$ distinct from $[t]$. By Lemma 3.6.6.1, one has $\nu(f_1) < \nu(t)$ and $\nu(f_1) < \nu(f_2)$. Take any polynomial $R \in k[x] \setminus k$, denote by S_R the square containing $[f_1 - tR(t)], [t], [f_2]$. By construction, S_R is adjacent to S_0 and Lemma 3.6.6.1 implies that $\nu(f_1 - tR(t)) < \nu(t)$. By Proposition 3.6.1.2, we can find a square $S''_1 = g \cdot S'_1$ with $g \in A_{[t]}$ such that S''_1, S''_1, S''_2 are flat and the edge containing $[t]$ in S''_1 distinct from $S_0 \cap S'_1$ is not critically resonant. Take S''_2 the 2×2 square completing the 4×4 square containing S''_1, S''_2, S''_1 .

If $p \geq 3$, the triple S_0, S''_1, S''_2 is not flat by Lemma 3.6.2.2.(ii), hence S_0, S''_1, S''_2 are also not flat. The squares $(S_0, S''_1, \tilde{S}_0)$ thus satisfy the conditions of Theorem 3.6.2.1, and $[t]$ is ν -maximal in \tilde{S}_0 . If $p = 2$, then $S''_2 = \tilde{S}_0$ and by Theorem 3.6.2.1 applied to (S_0, S''_1, S''_2) , the vertex is ν -maximal in S''_2 . Since S''_2 and \tilde{S}_0 are adjacent along an edge containing $[t]$ and $[t]$ is also ν -maximal in S''_1 , it is also ν -maximal in \tilde{S}_0 , proving assertion (A) as required. Observe that the same argument also applies for $\nu' \in \mathcal{V}_0$, hence assertion (C) also holds.

We have thus proven the claim for $n = 1$.

Let us suppose that the claim is true for $n \geq 1$. We shall prove it for $n + 1$. Choose any geodesic $\gamma : [0, n + 1] \rightarrow \mathcal{C}_\nu$ joining $[t]$ to a vertex v for which the sequence $(\nu(\gamma(i)))_{0 \leq i \leq n}$ is maximal. Denote by $v_i = \gamma(i)$. Take any sequence of squares $\tilde{S}_0, \dots, \tilde{S}_n$ for which $v_i, v_{i+1} \in \tilde{S}_i$.

By our induction hypothesis applied to the vertex v_n , the sequence $\tilde{S}_0, \dots, \tilde{S}_{n-1}$ satisfy assertions (A), (B) and (C).

Suppose first that \tilde{S}_{n-1} and \tilde{S}_n are adjacent or equal. Observe that assertion (A) implies that $v = \gamma_{n+1}$ cannot belong to the square \tilde{S}_{n-1} , otherwise it would contradict the fact that γ is a geodesic in \mathcal{C}_ν (recall that in this graph we draw an edge joining the ν -maximal to the ν -minimal edge). This implies that \tilde{S}_{n-1} and \tilde{S}_n are adjacent along an edge containing the ν -minimal vertex in \tilde{S}_{n-1} . Lemma 3.5.4.3 shows that the vertex in $\tilde{S}_{n-1} \cap \tilde{S}_n$ which is not ν -minimal in \tilde{S}_{n-1} is ν -maximal in \tilde{S}_n . By the maximality of the sequence $(\nu(\gamma(i)))_{0 \leq i \leq n}$ the vertex v_n cannot be ν -minimal in \tilde{S}_{n-1} , hence is ν -maximal in \tilde{S}_n , proving assertion (A). The following figure summarizes the situation :

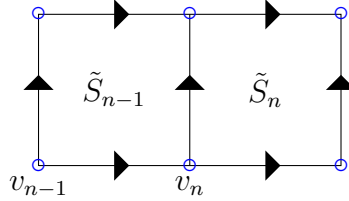

Since v_{n-1} is also ν' -maximal in \tilde{S}_{n-1} , the vertex v_n is also ν' -maximal in \tilde{S}_n by Lemma 3.5.4.3. We have thus proven assertion (C).

Let us check that \tilde{S}_{n-1} satisfies the condition of Theorem 3.6.4.1. Take another square \tilde{S} adjacent to \tilde{S}_{n-1} containing v_{n-1}, v_n . Observe that the sequence $\tilde{S}_0, \dots, \tilde{S}_{n-2}, \tilde{S}$ satisfies the conditions of the theorem and contains v_n which is at distance n . We apply our induction hypothesis to the vertex v_n and to the sequence of squares $\tilde{S}_0, \dots, \tilde{S}_{n-2}, \tilde{S}$. Assertion (A) implies that the vertex v_{n-1} is ν -minimal in \tilde{S} , as required.

We may thus apply Theorem 3.6.4.1 to the band $\tilde{S}_{n-1} \cup \tilde{S}_n$ which yields

$$\nu(v_{n+1}) < \frac{4}{3}\nu(v_n),$$

proving (B), as required.

Suppose that the squares $\tilde{S}_{n-1}, \tilde{S}_n$ are adherent and flat. If v_n, v_{n-1} form an edge of \tilde{S}_{n-1} , then we can find a band of two squares containing v_{n-1}, v_n, v_{n+1} , which corresponds to the previous situation. Otherwise (v_n, v_{n-1}) is not an edge of \tilde{S}_{n-1} , and since v_{n-1} is ν -maximal and ν' -maximal in \tilde{S}_{n-1} by assertions (A) and (C), the vertex v_n is ν -minimal and ν' -minimal in \tilde{S}_{n-1} . Observe that the vertex v_{n+1} cannot belong to a band containing v_n, v_{n-1} since we have chosen a geodesic γ for which the sequence $(\nu(\gamma(i)))_{0 \leq i \leq n}$ is maximal. We thus arrive at the following situation :

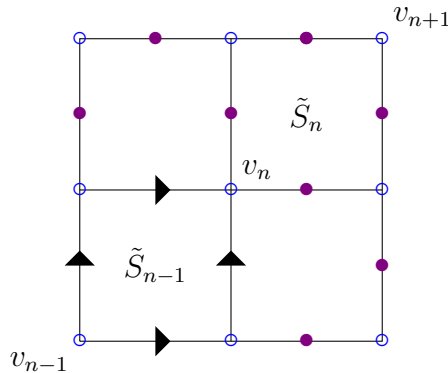

By Theorem 3.6.5.1 (i) and (ii) applied to \tilde{S}_{n-1} and \tilde{S}_n , the vertex v_n is ν -maximal and ν' -maximal in \tilde{S}_n (hence (A), (C) hold), and one has $\nu(v_{n+1}) < 4/3\nu(v_n)$, and assertion (B) holds.

Suppose that the squares $\tilde{S}_{n-1}, \tilde{S}_n$ are contained in a spiral staircase.

Let us suppose first that the vertices v_{n-1}, v_n do not belong to the same edge of \tilde{S}_{n-1} . By assertions (A) and (C) applied to v_{n-1} , the vertex v_{n-1} is ν -maximal and ν' -maximal in \tilde{S}_{n-1} , hence v_n is ν -minimal and ν' -minimal in \tilde{S}_{n-1} . We thus have the following figure :

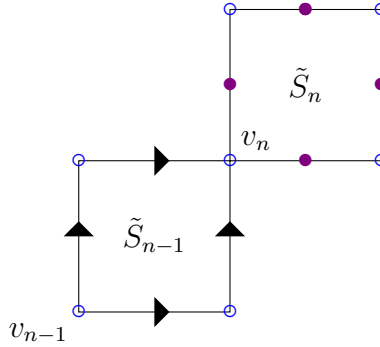

In particular, by Theorem 3.6.5.1.(i) applied to the squares $\tilde{S}_{n-1}, \tilde{S}_n$ implies that v_n is ν -maximal and ν' -maximal in \tilde{S} , proving (A) and (C). Observe that v_{n+1} cannot belong to a band containing v_{n-1}, v_n since we have chosen the geodesic such that $\nu(\gamma(i))$ is maximal. In particular, Theorem 3.6.5.1.(ii) implies that :

$$\nu(v_{n+1}) < \frac{4}{3}\nu(v_n),$$

proving (B) as required.

Let us suppose that the vertices v_{n-1}, v_n belong to an edge of \tilde{S}_{n-1} . Since the argument are similar for horizontal edges, we can suppose that the edge joining v_{n-1}, v_n is vertical, and the pair $(\tilde{S}_{n-1}, \tilde{S}_n)$ belongs to a vertical spiral staircase.

Write by $v_n = [f_2]$ and let $[f_1]$ be the vertex distinct from v_n in \tilde{S}_{n-1} which belongs to the horizontal edge containing v_n . For any polynomial $R \in k[x] \setminus k$, denote by S_R the 2×2 containing $[f_2], [f_1 - f_2R(f_2)], v_{n-1}$. We thus have the following figure :

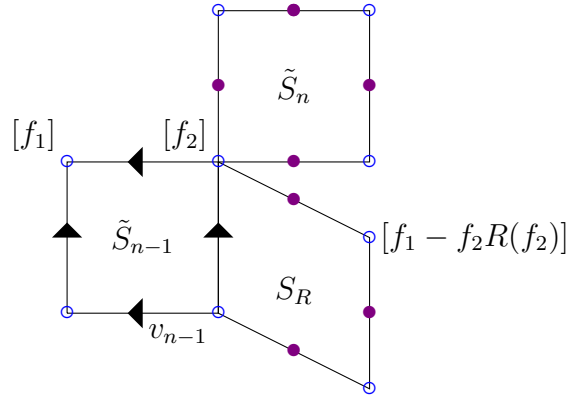

Using our induction hypothesis for the vertex v_n and to the sequence of squares $\tilde{S}_0, \dots, \tilde{S}_{n-2}, S_R$, assertions (A) and (C) imply that the vertex v_{n-1} is ν -maximal and ν' -maximal in S_R , hence $\nu(f_1 - f_2R(f_2)) < \nu(f_1)$ and $\nu'(f_1 - f_2R(f_2)) < \nu'(f_1)$. By Proposition 3.6.1.2, we can find a square S' containing v_{n-1}, v_n for which the horizontal edge containing v_n is not critically resonant and such that there exists $g \in A_{v_n}$ such that $g \cdot S' = \tilde{S}_{n-1}$. By Lemma 3.6.2.2, since $(\tilde{S}_{n-1}, \tilde{S}_n)$ is contained in a vertical spiral staircase, this implies that the pair (S', \tilde{S}_n) is also contained in a vertical spiral staircase. Since v_n is neither ν -maximal nor ν -minimal in S' , the pair (S', \tilde{S}_n) satisfies the conditions of Theorem 3.6.3.1.

One has the following figure :

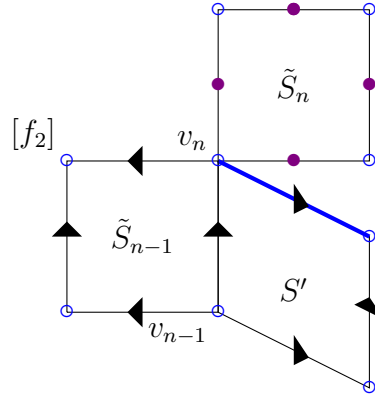

Observe that the same argument applies for ν' and we can find another square S'' adjacent to \tilde{S}_{n-1} along v_n, v_{n-1} such that S'', \tilde{S}_{n-1} is contained in a vertical spiral staircase and such that the horizontal edge in S'' containing v_n is not critically resonant for ν' . By Theorem 3.6.3.1, the vertex v_n is ν -maximal and ν' -maximal in \tilde{S}_n and $\nu(v_{n+1}) < (4/3)\nu(v_n)$, proving (A), (B) and (C) as required.

We have thus proven that our induction step is valid, and the theorem is proved.

Proof of Lemma 3.6.6.1 . Fix a valuation $\nu \in \mathcal{V}_0$ satisfying (3.9) and take a square S adjacent to S_0 along an edge containing $[t]$.

Observe that the edge $S \cap S_0$ is either vertical or horizontal. Since the proof is similar for both cases, we can suppose that $S \cap S_0$ is vertical so that S and S_0 intersect along the edge containing $[y], [t]$. Remark that in this case, we have $v_1 = [y]$ and v_2 is the vertex distinct from $[t]$ which belongs to the horizontal edge in S containing $[t]$.

We are thus in the following situation :

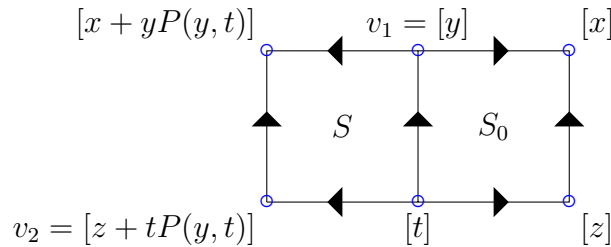

where $P \in k[x, y] \setminus k$.

Observe also that the edge $S \cap S_0$ is not critically resonant.

Since $\nu(P(y, t)) \leq \min(\nu(y), \nu(t))$ and since (3.9) implies that $2\nu(t) < \nu(z)$ and $\nu(y) + \nu(t) < \nu(z)$, we get :

$$\nu(tP(y, t)) < \nu(z),$$

hence $\nu(z + yP(y, t)) < \nu(z)$ and the vertex $[z + tP(y, t)]$ is ν -maximal in S . Observe also that the component (y, t) is not critically resonant. By Corollary 3.4.6.6, we obtain :

$$\nu(z + tP(y, t)) < \nu(y),$$

hence $\nu(v_2) < \nu(v_1)$, as required. □

3.6.7 Proof of Theorem 9

Consider a tame automorphism $f \in \text{Tame}(\mathbb{Q})$. Since the complex \mathcal{C} is CAT(0) and since the action of f is an isometry and a morphism of complex, the action of f on the complex

either fixes a vertex or a geodesic line. In the first case, f is elliptic and by Theorem 3.5.2.1, the sequences $(\deg(f^n))$, $(\deg(f^{-n}))$ are either both bounded, both linear or both equivalent to Cd^n where $C > 0$ and $d \in \mathbb{N}$.

We are thus reduced to prove the theorem in the case where f induces an action which fixes a geodesic line $\gamma : \mathbb{R} \rightarrow \mathcal{C}$. Take an hyperbolic automorphism f and a geodesic line $\gamma : \mathbb{R} \rightarrow \mathcal{C}$ fixed by f . Denote by S_0 the standard 2×2 square containing $[x]$, $[y]$, $[z]$ and $[t]$. Since for any tame automorphism $h \in \text{Tame}(\mathbb{Q})$, there exists a constant $C > 0$ such that :

$$\frac{1}{C} \leq \frac{\deg(f^n)}{\deg(h^{-1}f^n h)} \leq C,$$

by taking an appropriate conjugate of f , we can suppose that γ starts in S_0 and intersects an edge of S_0 . Consider the geodesic segment γ'_n joining $[\text{Id}]$ and $[x \circ f^{-n}]$. By construction, γ'_n intersects an edge of the standard square S_0 as γ starts in S_0 .

Fix any valuation ν such that (3.9) is satisfied. There are infinitely many valuations in \mathcal{V}_0 satisfying (3.9) arbitrarily close to $-\deg$. Indeed, consider the sequence of weight $\alpha_i = (-1, -1 + 3/i, -1 + 5/i, -1 + 7/i)$, then by Proposition 3.4.2.1, there exists a sequence of valuations ν_i with weight α_i on (x, y, z, t) which converges to $-\deg$.

All assumptions of Theorem 3.6.0.1 are then satisfied and we get :

$$\nu_i(f^n \cdot [x]) = \nu_i(x \circ f^{-n}) \leq \left(\frac{4}{3}\right)^{d_{\nu_i}([t], [x \circ f^{-n}]) - 1} \max(\nu_i(y), \nu_i(z), \nu_i(x), \nu_i(t)).$$

Observe that ν_i tends to $-\deg$, moreover, assertion (2) of Theorem 3.6.0.1 implies that the distance $d_{\nu_i}([t], [x \circ f^{-n}])$ are all equal for all i which implies :

$$\deg(f^{-n}) \geq \left(\frac{4}{3}\right)^{d_{\nu}([t], [x \circ f^{-n}]) - 1},$$

for a given valuation ν satisfying (3.9).

We now prove that the sequence $(d_{\nu}([t], [x \circ f^{-n}]))_n$ grows at least linearly. Indeed since the invariant geodesic γ passes through S_0 , then it passes through all the squares $f^i \cdot S_0$ for all $i \leq n$. Observe that all the squares $f^i \cdot S_0$ are distinct and there are at least n squares. Consider a geodesic segment γ_{1n} in \mathcal{C}_{ν} joining $[t]$ and $[x \circ f^{-n}]$ and a shortest path γ_{2n} in \mathcal{C}_{ν} contained in a sequence of squares containing the geodesic γ between these two vertices. The hyperbolicity of \mathcal{C} implies that the lengths $l(\gamma_{1n}), l(\gamma_{2n})$ in \mathcal{C}_{ν} of γ_1 and γ_2 are comparable as n tends to infinity :

$$\lim_{n \rightarrow +\infty} \frac{l(\gamma_{1n})}{l(\gamma_{2n})} = 1.$$

Since the length in \mathcal{C}_{ν} of γ_{2n} is larger or equal than n , we have proven that :

$$\lim_{n \rightarrow +\infty} \frac{1}{n} d_{\nu}([t], [x \circ f^{-n}]) \geq 1.$$

Hence

$$\deg(f^{-n}) \geq C \left(\frac{4}{3}\right)^{n-1},$$

where $C > 0$. Since the argument is similar for $\deg(f^n)$, we have thus proven that :

$$\min(\deg(f^n), \deg(f^{-n})) \geq C \left(\frac{4}{3}\right)^n$$

where $C > 0$.

3.6.8 Proof of Theorem 10

Take $f, g \in \text{Tame}(\mathbb{Q})$. Since the tame group acts by isometries on the complex, we can suppose that $g = \text{Id}$. Consider γ the geodesic in \mathcal{C} joining $[\text{Id}]$ to $[x \circ f]$. Since the stabilizer of $[\text{Id}]$ is the group O_4 by Proposition 3.3.2.3 and since the group O_4 acts transitively on the 1×1 squares containing $[\text{Id}]$ by Proposition 3.3.2.1, we can suppose that the geodesic γ intersects an edge of type I containing $[x]$ of the 1×1 square containing $[x]$, $[\text{Id}]$, $[z, x]$ and $[x, y]$. In particular, the geodesic γ intersects an edge of the standard square S_0 . We have proved that the vertex $v = [x \circ f]$ satisfies the conditions of Theorem 3.6.0.1, and by considering a sequence of valuations $\nu_p \in \mathcal{V}_0$ converging to $-\text{deg}$ satisfying (3.9), we have :

$$\nu_p(x \circ f) \leq \left(\frac{4}{3}\right)^{d_{\nu_p}([t], [x \circ f]) - 1} \max(\nu_p(y), \nu_p(z), \nu_p(x), \nu_p(t)).$$

By Proposition 3.5.4.4, we have for all integer p :

$$\frac{1}{2\sqrt{2}} d_{\mathcal{C}}(v_1, v_2) \leq d_{\nu_p}(v_1, v_2).$$

for any vertices v_1, v_2 of type I. Since $d_{\mathcal{C}}([t], [x \circ f]) \geq d_{\mathcal{C}}([\text{Id}], [f]) - 2\sqrt{2}$, we thus obtain after taking the limit as $p \rightarrow +\infty$:

$$\log \deg(f) \geq C d_{\mathcal{C}}([f], [\text{Id}]) - C',$$

where $C' = 2 \log(4/3)$ and $C = \log(4/3)/(2\sqrt{2})$ so that :

$$\log \deg(f^{-1} \circ g) \geq \frac{\log(4/3)}{2\sqrt{2}} d_{\mathcal{C}}(f \cdot [\text{Id}], g \cdot [\text{Id}]) - 2 \log(4/3),$$

as required.

Chapitre 4

Perspectives

Dans ce dernier chapitre, nous proposons quelques perspectives de recherche directement inspirées des résultats présentés dans cette thèse.

4.1 Degrés dynamiques des automorphismes modérés de la quadrique

Le Théorème principal du chapitre 3 montre que le premier degré dynamique de tout automorphisme modéré de \mathcal{Q} appartient à $\{1\} \cup [4/3, +\infty[$. Dans tous les exemples pour lesquels nous avons su mener à leur terme les calculs de degré, nous avons trouvé un degré dynamique *entier*. Nous ne savons cependant pas si $\lambda_1(f) \in \mathbb{N}^*$ pour tout automorphisme modéré f .

La détermination de l'ensemble $\{\lambda_1(f), f \in \text{Tame}(\mathcal{Q})\}$ s'inscrit naturellement dans la lignée des travaux de Friedland-Milnor [FM89] dans le cas des automorphismes polynomiaux du plan, et de Blanc-Cantat [BC16] pour les applications birationnelles de surfaces, mais reste totalement ouverte. Il est en effet compliqué de produire des modèles algébriquement stables pour les automorphismes modérés en ne connaissant que leur action sur le complexe carré \mathcal{C} . Pour la construction de tel modèle, il apparaît crucial d'étudier plus avant l'action d'un tel automorphisme sur un espace de valuations adéquat.

Nous pensons cependant que les méthodes développées au Chapitre 3 permettent de montrer que $\{\lambda_1(f), f \in \text{Tame}(\mathcal{Q})\} \subset \{1\} \cup [2, +\infty[$ ce qui serait déjà intéressant. L'idée serait de classifier les automorphismes hyperboliques tels que $\lambda_1(f) \leq 2$, puis d'estimer leur degré dynamique.

4.2 Produits aléatoires d'automorphismes dans $\text{Tame}(\mathcal{Q})$

Le Théorème 10 permet d'obtenir un analogue en dimension 3 de résultats dus à Maher et Tiozzo concernant les produits aléatoires d'applications birationnelles de surfaces.

Pour simplifier la discussion, fixons une mesure μ de probabilité et de support G fini dans $\text{Tame}(\mathcal{Q})$, et considérons la marche aléatoire associée à cette mesure. Plus précisément on regarde la mesure produit $\mu^{\mathbb{N}}$ sur l'espace $G^{\mathbb{N}}$, et on note $r_n(\omega) = g_1 \cdots g_n$ pour tout élément $\omega = (g_1, \dots, g_n, \dots) \in G^{\mathbb{N}}$. On cherche alors à comprendre la croissance des degrés $\deg(r_n(\omega))$ pour $n \rightarrow \infty$, et ω typique.

Par le théorème de Kingman, et la sous-multiplicativité des degrés on peut montrer l'existence d'un réel $\lambda \geq 0$, décrivant la croissance des degrés d'un produit aléatoire. Ce nombre est

appelé exposant de Lyapunov de la marche aléatoire et est défini comme limite

$$\lambda := \lim_{n \rightarrow \infty} \frac{1}{n} \int_{g \in G^n} \log(\deg(r_n(g))) d\mu^{\otimes n}(g) .$$

Notre résultat sur le trou spectral et les méthodes de Maher-Tiozzo permettent de montrer que $\lambda > 0$ dès que G contient deux éléments hyperboliques qui ne commutent pas.

On peut généraliser la définition ci-dessus aux cas de mesure à support dénombrable sous une hypothèse d'intégrabilité adéquate. Dans cette situation, il serait intéressant de déterminer les mesures μ pour lesquels l'exposant de Lyapunov est nul.

4.3 Croissance des degrés des automorphismes modérées de \mathbb{A}^3

Il serait intéressant de démontrer une version du Théorème 6 pour les automorphismes de l'espace affine, et plus particulièrement pour le groupe $\text{Tame}(\mathbb{A}^3)$ des automorphismes de \mathbb{A}^3 engendrés par les applications affines et les applications élémentaires de la forme $(x, y, z) \mapsto (x, y + P(x), z + Q(x, y))$.

Lamy [Lam15] a introduit un complexe triangulaire \mathcal{C}_3 sur lequel $\text{Tame}(\mathbb{A}^3)$ agissait par isométries, et a montré que \mathcal{C}_3 est simplement connexe. Ce complexe est de plus Gromov-hyperbolique ([LP16]) mais n'est pas $\text{CAT}(0)$, ce qui ne permet pas de décrire l'action d'un automorphisme de manière assez précise pour pouvoir estimer le degré de ses itérés. Récemment cependant Lamy et Przytycki [LP18b] ont construit un espace \mathbb{X}_3 géodésique et $\text{CAT}(0)$ sur lequel $\text{Tame}(\mathbb{A}^3)$ agissait librement, transitivement et par isométries.

Il est probable que l'étude de l'action simultanée de $\text{Tame}(\mathbb{A}^3)$ sur \mathcal{C}_3 et \mathbb{X}_3 permette d'obtenir des estimations sur la croissance des degrés des automorphismes modérés.

Bibliographie

- [AAdB⁺99] N. Abarenkova, J.-Ch. Anglès d’Auriac, S. Boukraa, S. Hassani, and J.-M. Maillard, *From Yang-Baxter equations to dynamical zeta functions for birational transformations*, Statistical physics on the eve of the 21st century, Ser. Adv. Statist. Mech., vol. 14, World Sci. Publ., River Edge, NJ, 1999, pp. 436–490. MR 1704016
- [AAdBM99] N. Abarenkova, J.-Ch. Anglès d’Auriac, S. Boukraa, and J.-M. Maillard, *Growth-complexity spectrum of some discrete dynamical systems*, Phys. D **130** (1999), no. 1-2, 27–42. MR 1694727
- [AB12] Semyon Alesker and Andreas Bernig, *The product on smooth and generalized valuations*, Amer. J. Math. **134** (2012), no. 2, 507–560. MR 2905004
- [AB17] ———, *Convolution of valuations on manifolds*, J. Differential Geom. **107** (2017), no. 2, 203–240. MR 3707644
- [ADM99] Semyon Alesker, Sean Dar, and Vitali Milman, *A remarkable measure preserving diffeomorphism between two convex bodies in \mathbb{R}^n* , Geom. Dedicata **74** (1999), no. 2, 201–212 (English).
- [AdMV06] J.-Ch. Anglès d’Auriac, J.-M. Maillard, and C. M. Viallet, *On the complexity of some birational transformations*, J. Phys. A **39** (2006), no. 14, 3641–3654. MR 2220002
- [AF14] Semyon Alesker and Joseph H. G. Fu, *Integral geometry and valuations*, Advanced Courses in Mathematics. CRM Barcelona, Birkhäuser/Springer, Basel, 2014, Lectures from the Advanced Course on Integral Geometry and Valuation Theory held at the Centre de Recerca Matemàtica (CRM), Barcelona, September 6–10, 2010, Edited by Eduardo Gallego and Gil Solanes. MR 3380549
- [Ale38] Aleksandr Danilovich Alexandrov, *On the theory of mixed volumes of convex bodies III. extension of two theorems of Minkowski on convex polyhedra to arbitrary convex bodies.*, Mat. Sbornik **3** (1938), no. 45, 27–46 (Russian).
- [Ale01] Semyon Alesker, *Description of translation invariant valuations on convex sets with solution of P. McMullen’s conjecture*, Geom. Funct. Anal. **11** (2001), no. 2, 244–272. MR 1837364
- [Ale04] ———, *The multiplicative structure on continuous polynomial valuations*, Geom. Funct. Anal. **14** (2004), no. 1, 1–26. MR 2053598
- [Ale07] ———, *Theory of valuations on manifolds : a survey*, Geom. Funct. Anal. **17** (2007), no. 4, 1321–1341. MR 2373020
- [Ale11] ———, *A Fourier-type transform on translation-invariant valuations on convex sets*, Israel J. Math. **181** (2011), 189–294. MR 2773042
- [BC16] Jérémy Blanc and Serge Cantat, *Dynamical degrees of birational transformations of projective surfaces*, J. Amer. Math. Soc. **29** (2016), no. 2, 415–471. MR 3454379

- [BdFFU15] Sébastien Boucksom, Tomasso de Fernex, Charles Favre, and Stefano Urbinati, *Valuation spaces and multiplier ideals on singular varieties*, Recent advances in algebraic geometry, London Math. Soc. Lecture Note Ser., vol. 417, Cambridge Univ. Press, Cambridge, 2015, pp. 29–51. MR 3380442
- [Ber75] David N. Bernstein, *The number of roots of a system of equations*, Funkcional. Anal. i Priložen. **9** (1975), no. 3, 1–4. MR 0435072
- [Ber12] Andreas Bernig, *Algebraic integral geometry*, Global Differential Geometry, Springer, 2012, pp. 107–145.
- [BF06] Andreas Bernig and Joseph H. G. Fu, *Convolution of convex valuations*, Geom. Dedicata **123** (2006), 153–169. MR 2299731
- [BF11] ———, *Hermitian integral geometry*, Ann. of Math. (2) **173** (2011), no. 2, 907–945. MR 2776365
- [BF16] Andreas Bernig and Dmitry Faifman, *Generalized translation invariant valuations and the polytope algebra*, Adv. Math. **290** (2016), 36–72. MR 3451918
- [BFJ08a] Sébastien Boucksom, Charles Favre, and Mattias Jonsson, *Degree growth of meromorphic surface maps*, Duke Math. J. **141** (2008), no. 3, 519–538. MR 2387430
- [BFJ08b] Sébastien Boucksom, Charles Favre, and Mattias Jonsson, *Degree growth of meromorphic surface maps*, Duke Mathematical Journal **141** (2008), no. 3, 519–538.
- [BFL14] Cinzia Bisi, Jean-Philippe Furter, and Stéphane Lamy, *The tame automorphism group of an affine quadric threefold acting on a square complex*, J. Éc. polytech. Math. **1** (2014), 161–223. MR 3322787
- [BH99] Martin R. Bridson and André Haefliger, *Metric spaces of non-positive curvature*, Grundlehren der Mathematischen Wissenschaften [Fundamental Principles of Mathematical Sciences], vol. 319, Springer-Verlag, Berlin, 1999. MR 1744486
- [Bia16] Federico Lo Bianco, *On the primitivity of birational transformations of irreducible symplectic manifolds*, arXiv preprint arXiv :1604.05261 (2016).
- [Bre91] Yann Brenier, *Polar factorization and monotone rearrangement of vector-valued functions*, Communications on Pure and Applied Mathematics **44** (1991), no. 4, 375–417.
- [BS99] Werner Ballmann and Jacek Swiatkowski, *On groups acting on nonpositively curved cubical complexes*, Enseign. Math. (2) **45** (1999), no. 1-2, 51–81. MR 1703363
- [CC15] Dawei Chen and Izzet Coskun, *Extremal higher codimension cycles on moduli spaces of curves*, Proc. Lond. Math. Soc. (3) **111** (2015), no. 1, 181–204. MR 3404780
- [CLO16] Izzet Coskun, John Lesieutre, and John Christian Ottem, *Effective cones of cycles on blow-ups of projective space*, arXiv preprint 1603.04808 (2016).
- [CLS11] David A. Cox, John B. Little, and Henry K. Schenck, *Toric varieties*, Graduate Studies in Mathematics, vol. 124, American Mathematical Society, Providence, RI, 2011. MR 2810322
- [CO15] Serge Cantat and Keiji Oguiso, *Birational automorphism groups and the movable cone theorem for Calabi-Yau manifolds of Wehler type via universal Coxeter groups*, Amer. J. Math. **137** (2015), no. 4, 1013–1044. MR 3372313
- [Cut15] Steven Dale Cutkosky, *Teissier’s problem on inequalities of nef divisors*, J. Algebra Appl. **14** (2015), no. 9, 1540002, 37. MR 3368254
- [CWZ14] Frederic Campana, Fei Wang, and De-Qi Zhang, *Automorphism groups of positive entropy on projective threefolds*, Trans. Amer. Math. Soc. **366** (2014), no. 3, 1621–1638. MR 3145744

- [Dan17] Nguyen-Bac Dang, *Degrees of iterates of rational maps on normal projective varieties*, arXiv :1701.07760 (2017).
- [Deb01] Olivier Debarre, *Higher-dimensional algebraic geometry*, Universitext, Springer-Verlag, New York, 2001. MR 1841091
- [DELV11a] Olivier Debarre, Lawrence Ein, Robert Lazarsfeld, and Claire Voisin, *Pseudoeffective and nef classes on abelian varieties*, *Compos. Math.* **147** (2011), no. 6, 1793–1818. MR 2862063
- [DELV11b] ———, *Pseudoeffective and nef classes on abelian varieties*, *Compositio Mathematica* **147** (2011), no. 06, 1793–1818.
- [Dem12a] Jean-Pierre Demailly, *Analytic methods in algebraic geometry*, *Surveys of Modern Mathematics*, vol. 1, International Press, Somerville, MA ; Higher Education Press, Beijing, 2012. MR 2978333
- [Dem12b] ———, *Complex analytic and differential geometry. online book*, available at www-fourier.ujf-grenoble.fr/~demailly/manuscripts/agbook.pdf, Institut Fourier, Grenoble (2012).
- [DF01] Jeffrey Diller and Charles Favre, *Dynamics of bimeromorphic maps of surfaces*, *Amer. J. Math.* **123** (2001), no. 6, 1135–1169. MR 1867314
- [Din05] Tien-Cuong Dinh, *Suites d'applications méromorphes multivaluées et courants laminaires*, *J. Geom. Anal.* **15** (2005), no. 2, 207–227. MR 2152480
- [DN11a] Tien-Cuong Dinh and Viêt-Anh Nguyễn, *Comparison of dynamical degrees for semi-conjugate meromorphic maps*, *Comment. Math. Helv.* **86** (2011), no. 4, 817–840. MR 2851870
- [DN11b] Tien-Cuong Dinh and Viêt-Anh Nguyễn, *Comparison of dynamical degrees for semi-conjugate meromorphic maps*, *Comment. Math. Helv.* **86** (2011), no. 4, 817–840. MR 2851870
- [DNT12] Tien-Cuong Dinh, Viêt-Anh Nguyễn, and Tuyen Trung Truong, *On the dynamical degrees of meromorphic maps preserving a fibration*, *Communications in Contemporary Mathematics* **14** (2012), no. 06, 1250042.
- [DS04a] Tien-Cuong Dinh and Nessim Sibony, *Regularization of currents and entropy*, *Ann. Sci. École Norm. Sup. (4)* **37** (2004), no. 6, 959–971. MR 2119243
- [DS04b] ———, *Regularization of currents and entropy*, *Annales scientifiques de l'École normale supérieure* **37** (2004), no. 6, 959–971.
- [DS05a] ———, *Green currents for holomorphic automorphisms of compact Kähler manifolds*, *J. Amer. Math. Soc.* **18** (2005), no. 2, 291–312. MR 2137979
- [DS05b] ———, *Une borne supérieure pour l'entropie topologique d'une application rationnelle*, *Ann. of Math. (2)* **161** (2005), no. 3, 1637–1644. MR 2180409
- [DS05c] ———, *Une borne supérieure pour l'entropie topologique d'une application rationnelle*, *Annals of mathematics* (2005), 1637–1644.
- [Eis95] David Eisenbud, *Commutative algebra*, *Graduate Texts in Mathematics*, vol. 150, Springer-Verlag, New York, 1995, With a view toward algebraic geometry. MR 1322960
- [FGI⁺05] B. Fantechi, L. Göttsche, L. Illusie, S. Kleiman, N. Nitsure, and A. Vistoli, *Fundamental algebraic geometry : Grothendieck's fga explained*, *Mathematical Surveys and Monographs*, 2005.
- [FH91] William Fulton and Joe Harris, *Representation theory*, *Graduate Texts in Mathematics*, vol. 129, Springer-Verlag, New York, 1991, A first course, Readings in Mathematics. MR 1153249

- [FJ11] Charles Favre and Mattias Jonsson, *Dynamical compactifications of \mathbf{C}^2* , Ann. of Math. (2) **173** (2011), no. 1, 211–248. MR 2753603
- [FL14a] Mihai Fulger and Brian Lehmann, *Kernels of numerical pushforwards*, arXiv preprint 1407.6455 (2014).
- [FL14b] ———, *Positive cones of dual cycle classes*, arXiv preprint 1408.5154 (2014).
- [FM89] Shmuel Friedland and John Milnor, *Dynamical properties of plane polynomial automorphisms*, Ergodic Theory Dynam. Systems **9** (1989), no. 1, 67–99. MR 991490
- [FS95] John Erik Fornæss and Nessim Sibony, *Complex dynamics in higher dimension. II*, Modern methods in complex analysis (Princeton, NJ, 1992), Ann. of Math. Stud., vol. 137, Princeton Univ. Press, Princeton, NJ, 1995, pp. 135–182. MR 1369137
- [Ful93] William Fulton, *Introduction to toric varieties*, Annals of Mathematics Studies, vol. 131, Princeton University Press, Princeton, NJ, 1993, The William H. Roever Lectures in Geometry. MR 1234037
- [Ful98] ———, *Intersection theory*, second ed., Ergebnisse der Mathematik und ihrer Grenzgebiete. 3. Folge. A Series of Modern Surveys in Mathematics [Results in Mathematics and Related Areas. 3rd Series. A Series of Modern Surveys in Mathematics], vol. 2, Springer-Verlag, Berlin, 1998. MR 1644323
- [FW12] Charles Favre and Elizabeth Wulcan, *Degree growth of monomial maps and McMullen’s polytope algebra*, Indiana Univ. Math. J. **61** (2012), no. 2, 493–524. MR 3043585
- [Gar00] Elvira Muñoz García, *Fibrés d’intersection*, Compositio Math. **124** (2000), no. 3, 219–252. MR 1809336
- [GGJ⁺16] José Ignacio Burgos Gil, Walter Gubler, Philipp Jell, Klaus Kuennemann, and Florent Martin, *Differentiability of non-archimedean volumes and non-archimedean monge-amp\ere equations (with an appendix by robert lazarsfeld)*, arXiv preprint 1608.01919 (2016).
- [Giz80] Marat Kharisovitch Gizatullin, *Rational G -surfaces*, Izv. Akad. Nauk SSSR Ser. Mat. **44** (1980), no. 1, 110–144, 239. MR 563788
- [Gro87] Misha Gromov, *Entropy, homology and semialgebraic geometry*, Astérisque (1987), no. 145-146, 5, 225–240, Séminaire Bourbaki, Vol. 1985/86. MR 880035
- [Gro90] Misha Gromov, *Convex sets and Kähler manifolds*, Advances in Differential Geometry and Topology, ed. F. Triccerri, World Scientific, Singapore (1990), 1–38.
- [Har77] Robin Hartshorne, *Algebraic geometry*, vol. 52, Springer Science & Business Media, 1977.
- [Har95] Darald J. Hartfiel, *Dense sets of diagonalizable matrices*, Proc. Amer. Math. Soc. **123** (1995), no. 6, 1669–1672. MR 1264813
- [HS95] Birkett Huber and Bernd Sturmfels, *A polyhedral method for solving sparse polynomial systems*, Math. Comp. **64** (1995), no. 212, 1541–1555. MR 1297471
- [JMta12] Mattias Jonsson and Mircea Musta_tă, *Valuations and asymptotic invariants for sequences of ideals*, Ann. Inst. Fourier (Grenoble) **62** (2012), no. 6, 2145–2209 (2013). MR 3060755
- [Jon96] Aise Johan De Jong, *Smoothness, semi-stability and alterations*, Publications Mathématiques de l’IHÉS (1996).
- [Jun42] Heinrich W. E. Jung, *über ganze birationale Transformationen der Ebene*, J. Reine Angew. Math. **184** (1942), 161–174. MR 0008915

- [Kho78] Askold Georgievich Khovanskiĭ, *Newton polyhedra, and the genus of complete intersections*, Funktsional. Anal. i Prilozhen. **12** (1978), no. 1, 51–61. MR 487230
- [KM98] János Kollár and Shigefumi Mori, *Birational geometry of algebraic varieties*, Cambridge Tracts in Mathematics, vol. 134, Cambridge University Press, Cambridge, 1998, With the collaboration of C. H. Clemens and A. Corti, Translated from the 1998 Japanese original. MR 1658959
- [Kur16] Shigeru Kuroda, *Weighted multidegrees of polynomial automorphisms over a domain*, J. Math. Soc. Japan **68** (2016), no. 1, 119–149. MR 3454556
- [Kus76] Anatolii Georgievich Kushnirenko, *Polyèdres de Newton et nombres de Milnor*, Invent. Math. **32** (1976), no. 1, 1–31. MR 0419433
- [Lam15] Stéphane Lamy, *Combinatorics of the tame automorphism group*, arXiv preprint arXiv :1505.05497 (2015).
- [Lan02] Serge Lang, *Algebra*, third ed., Graduate Texts in Mathematics, vol. 211, Springer-Verlag, New York, 2002. MR 1878556
- [Laz04] Robert Lazarsfeld, *Positivity in algebraic geometry. I*, Ergebnisse der Mathematik und ihrer Grenzgebiete. 3. Folge. A Series of Modern Surveys in Mathematics [Results in Mathematics and Related Areas. 3rd Series. A Series of Modern Surveys in Mathematics], vol. 48, Springer-Verlag, Berlin, 2004, Classical setting : line bundles and linear series. MR 2095471
- [Lef53] Solomon Lefschetz, *Algebraic geometry*, Princeton University Press, Princeton, N. J., 1953. MR 0056950
- [Les15] John Lesieutre, *Some constraints on positive entropy automorphisms of smooth threefolds*, arXiv preprint arXiv :1503.07834 (2015).
- [Lin12] Jan-Li Lin, *Algebraic stability and degree growth of monomial maps*, Math. Z. **271** (2012), no. 1-2, 293–311. MR 2917145
- [LP16] Stéphane Lamy and Piotr Przytycki, *Acylindrical hyperbolicity of the three-dimensional tame automorphism group*, arXiv preprint arXiv :1610.05457 (2016).
- [LP18a] ———, *Presqu'un immeuble pour le groupe des automorphismes mod\ 'er\ 'es*, arXiv preprint arXiv :1802.00481 (2018).
- [LP18b] ———, *Presqu'un immeuble pour le groupe des automorphismes mod\ 'er\ 'es*, arXiv preprint arXiv :1802.00481 (2018).
- [LV13] Stéphane Lamy and Stéphane Vénéreau, *The tame and the wild automorphisms of an affine quadric threefold*, J. Math. Soc. Japan **65** (2013), no. 1, 299–320. MR 3034406
- [LX15a] Brian Lehmann and Jian Xiao, *Convexity and Zariski decomposition structure*, arXiv :1507.04316v1 (2015).
- [LX15b] ———, *Convexity and zariski decomposition structure*.
- [LX16] ———, *Convexity and Zariski decomposition structure*, Geom. Funct. Anal. **26** (2016), no. 4, 1135–1189. MR 3558307
- [LX17] ———, *Correspondences between convex geometry and complex geometry*, Épijournal de Géométrie Algébrique (EPIGA), Volume 1, Article Nr. 6, arXiv :1607.06161. (2017).
- [McC95] Robert J. McCann, *Existence and uniqueness of monotone measure-preserving maps.*, Duke Math. J. **80** (1995), no. 2, 309–323 (English).
- [McM77] Peter McMullen, *Valuations and Euler-type relations on certain classes of convex polytopes*, Proc. London Math. Soc. (3) **35** (1977), no. 1, 113–135. MR 0448239

- [McM80] ———, *Continuous translation-invariant valuations on the space of compact convex sets*, Arch. Math. (Basel) **34** (1980), no. 4, 377–384. MR 593954
- [McM93] ———, *Valuations and dissections*, Handbook of convex geometry, Vol. A, B, North-Holland, Amsterdam, 1993, pp. 933–988. MR 1243000
- [Mil13] James S. Milne, *Lectures on étale cohomology (v2.21)*, 2013, Available at www.jmilne.org/math/.
- [MS83] Peter McMullen and Rolf Schneider, *Valuations on convex bodies*, Convexity and its applications, Birkhäuser, Basel, 1983, pp. 170–247. MR 731112
- [OT14] Keiji Oguiso and Tuyen Trung Truong, *Salem numbers in dynamics on Kähler threefolds and complex tori*, Math. Z. **278** (2014), no. 1-2, 93–117. MR 3267571
- [OT15] ———, *Explicit examples of rational and Calabi-Yau threefolds with primitive automorphisms of positive entropy*, J. Math. Sci. Univ. Tokyo **22** (2015), no. 1, 361–385. MR 3329200
- [Pap95] P. Papasoglu, *Strongly geodesically automatic groups are hyperbolic*, Invent. Math. **121** (1995), no. 2, 323–334. MR 1346209
- [Pop15] Dan Popovici, *Volume and self-intersection of differences of two nef classes*, 2015, arXiv preprint arXiv :1505.03457.
- [Pop16a] ———, *Sufficient bigness criterion for differences of two nef classes*, Math. Ann. **364** (2016), no. 1-2, 649–655. MR 3451400
- [Pop16b] Dan Popovici, *Sufficient bigness criterion for differences of two nef classes.*, Math. Ann. **364** (2016), no. 1-2, 649–655 (English).
- [PW13] Lukas Parapatits and Thomas Wannerer, *On the inverse Klain map*, Duke Math. J. **162** (2013), no. 11, 1895–1922. MR 3090780
- [RS97] Alexander Russakovskii and Bernard Shiffman, *Value distribution for sequences of rational mappings and complex dynamics*, Indiana Univ. Math. J. **46** (1997), no. 3, 897–932. MR 1488341
- [Sch14] Rolf Schneider, *Convex bodies : the Brunn-Minkowski theory.*, 2nd expanded ed. ed., Cambridge : Cambridge University Press, 2014 (English).
- [Siu93] Yum Tong Siu, *An effective Matsusaka big theorem*, Ann. Inst. Fourier (Grenoble) **43** (1993), no. 5, 1387–1405.
- [SU03] Ivan P Shestakov and Ualbai U Umirbaev, *The nagata automorphism is wild*, Proceedings of the National Academy of Sciences **100** (2003), no. 22, 12561–12563.
- [SZ16] Ivan Soprunov and Artem Zvavitch, *Bezout inequality for mixed volumes*, Int. Math. Res. Not. IMRN (2016), no. 23, 7230–7252. MR 3632081
- [Tru15] Tuyen Trung Truong, *(relative) dynamical degrees of rational maps over an algebraic closed field*, arXiv preprint 1501.01523 (2015).
- [Tru16a] ———, *Relative dynamical degrees of correspondance over a field of arbitrary characteristic*, arXiv (2016).
- [Tru16b] Tuyen Trung Truong, *Some dynamical properties of pseudo-automorphisms in dimension 3*, Trans. Amer. Math. Soc. **368** (2016), no. 1, 727–753. MR 3413882
- [Tru17] ———, *Automorphisms of blowups of threefolds being Fano or having Picard number 1*, Ergodic Theory Dynam. Systems **37** (2017), no. 7, 2255–2275. MR 3693127
- [Ure16] Christian Urech, *Remarks on the degree growth of birational transformations*, arXiv preprint 1606.04822 (2016).

- [Vaq00] Michel Vaquié, *Valuations*, Resolution of singularities (Obergrugl, 1997), Progr. Math., vol. 181, Birkhäuser, Basel, 2000, pp. 539–590. MR 1748635
- [Voi07] Claire Voisin, *Hodge theory and complex algebraic geometry. I*, english ed., Cambridge Studies in Advanced Mathematics, vol. 76, Cambridge University Press, Cambridge, 2007, Translated from the French by Leila Schneps. MR 2451566
- [Wri15] David Wright, *The generalized amalgamated product structure of the tame automorphism group in dimension three*, Transform. Groups **20** (2015), no. 1, 291–304. MR 3317803
- [Xia15a] Jian Xiao, *Weak transcendental holomorphic Morse inequalities on compact Kähler manifolds*, Ann. Inst. Fourier (Grenoble) **65** (2015), no. 3, 1367–1379. MR 3449182
- [Xia15b] ———, *Weak transcendental holomorphic Morse inequalities on compact Kähler manifolds*, Ann. Inst. Fourier (Grenoble) **65** (2015), no. 3, 1367–1379. MR 3449182
- [Xia17] ———, *Bézout type inequality in convex geometry*, Int. Math. Res. Not. IMRN, to appear, arXiv :1704.00883, (2017).
- [Zha09] De-Qi Zhang, *Dynamics of automorphisms on projective complex manifolds*, J. Differential Geom. **82** (2009), no. 3, 691–722. MR 2534992
- [Zha10] ———, *Automorphism groups of positive entropy on minimal projective varieties*, Adv. Math. **225** (2010), no. 5, 2332–2340. MR 2680167

Titre : Croissance des degrés d'applications rationnelles en dimension trois.

Mots clés : Géométrie algébrique, dynamique algébrique, positivité des cycles algébriques, géométrie convexe, valuations, convolution, automorphismes modérés.

Résumé : Cette thèse comporte trois chapitres indépendants portant sur l'itération des applications rationnelles sur des variétés projectives et plus spécifiquement sur l'étude du comportement de la suite des degrés des itérés de telles applications. Dans le premier chapitre, nous prouvons l'existence d'invariants fondamentaux que sont les degrés dynamiques dans un cadre très général, et ce sans hypothèse ni sur la caractéristique du corps de base ni sur les singularités de l'espace ambiant. Cette preuve repose sur des propriétés de positivité des cycles algébriques, et propose une alternative aux approches analytiques de Dinh et Sibony ou algébriques de Truong. Le second chapitre est issu d'un article écrit en commun avec Jian Xiao. Notre contribution porte sur des objets centraux en géométrie convexe

appelés valuations. Nous transférons à l'espace des valuations des notions de positivité des cycles algébriques récemment introduites par Lehmann et Xiao, ce qui nous permet d'étendre l'opération de convolution originellement définie par Bernig et Fu à une sous-classe de valuations suffisamment positives. Le troisième chapitre constitue le coeur de la thèse, et porte sur des estimations des degrés dynamiques des automorphismes dit modérés de la quadrique affine de dimension 3. Nos arguments sont de natures variées, et s'appuient sur l'action du groupe modéré sur un complexe carré $CAT(0)$ et Gromov hyperbolique récemment introduite par Bisi, Furter et Lamy. Nous avons finalement collecté dans un dernier et court chapitre quelques pistes de recherche directement inspirées des travaux présentés ici.

Title : Degree growth of rational maps in dimension three.

Keywords : Algebraic geometry, algebraic dynamics, positivity of algebraic cycles, convex geometry, valuations, convolution, tame automorphisms.

Abstract : This thesis is divided into three independent chapters on the iterates of rational maps on projective varieties and more specifically on the study of the growth of the degree sequences of the iterates of such maps. In the first chapter, we give a construction of the fundamental invariants called dynamical degrees. Our method holds in a very general setting, without any conditions on the characteristic of the base field or on the singularities of the ambient space. Our argument is based on the study of positivity properties of algebraic cycles and gives an alternative approach to the analytical technics of Dinh and Sibony or to the algebraic arguments of Truong. The second chapter is taken from an article written in joint work

with Jian Xiao. Our paper focuses on central objects in convex geometry called valuations. We transfer some positivity notions of algebraic cycles recently introduced by Lehmann and Xiao, this allows us to extend the convolution operation defined by Bernig and Fu to a subspace of sufficiently positive valuations. The third chapter is the core of this thesis and focuses on the dynamical degrees of the so-called tame automorphisms of an affine quadric threefold. Our arguments are of various nature and rely on the action of the tame group on a $CAT(0)$, Gromov hyperbolic square complex recently introduced by Bisi, Furter and Lamy. Finally, we have collected in the last chapter a few perspectives directly inspired by this work.

