



**HAL**  
open science

# Channel Allocation in Mobile Wireless Networks

Roni Shigueta

► **To cite this version:**

Roni Shigueta. Channel Allocation in Mobile Wireless Networks. Library and information sciences. Université Paris Saclay (COMUE); Pontificia universidade católica do Paraná (Curitiba, Brésil), 2018. English. NNT : 2018SACLX037 . tel-01891855

**HAL Id: tel-01891855**

**<https://pastel.hal.science/tel-01891855>**

Submitted on 10 Oct 2018

**HAL** is a multi-disciplinary open access archive for the deposit and dissemination of scientific research documents, whether they are published or not. The documents may come from teaching and research institutions in France or abroad, or from public or private research centers.

L'archive ouverte pluridisciplinaire **HAL**, est destinée au dépôt et à la diffusion de documents scientifiques de niveau recherche, publiés ou non, émanant des établissements d'enseignement et de recherche français ou étrangers, des laboratoires publics ou privés.

# Channel allocation in mobile wireless networks

Thèse de doctorat de l'Université Paris-Saclay et de  
Pontifical Catholic University of Parana  
préparée à École Polytechnique

Ecole doctorale n°580 Sciences et technologies de l'information et de la  
communication (STIC)

Spécialité de doctorat : Réseaux, information et communications

Thèse présentée et soutenue à Paris, le 13 juillet 2018, par

**M. Roni SHIGUETA**

Composition du Jury :

Artur ZIVIANI Senior Researcher, Laboratory for Scientific Computing (LNCC)	Président
Marcelo DIAS DE AMORIM Research Director, Sorbonne Université (LIP6)	Rapporteur
Yacine GHAMRI-DOUDANE Professor, University of La Rochelle (ENSIIE)	Rapporteur
Hakima CHAOUCHI Professor, Telecom Sud Paris (Institut Mines Telecom)	Examineur
Nadjib ACHIR Maître de Conférence, Université Paris 13 (L2TI)	Examineur
Aline CARNEIRO VIANA Research Scientist, Université Paris-Saclay (INRIA)	Directeur de thèse
Mauro FONSECA Professor, UTFPR (CPGEI)	Co-directeur de thèse
Marcelo PELLEZZI Professor, PUCPR (PPGIA)	Co-directeur de thèse

Roni Francis Shigueta: *Channel Allocation in Mobile Wireless Networks,*

**SUPERVISORS:**

Aline Carneiro Viana

Mauro Fonseca

Marcelo Pellenz

**LOCATION:**

Palaiseau, France



## RÉSUMÉ EN FRANÇAIS

---

L'utilisation intensive des services de données mobiles a de plus en plus augmenté la consommation de ressources sur les réseaux sans fil tels que processeur, mémoire, buffer, and spectre de fréquences. La ressource principale utilisée pour la communication sans fil et le plus rare est le spectre de fréquence.

À mesure que le trafic de données augmente brusquement, de nouvelles bandes du spectre de fréquences ne sont pas disponibles dans la même proportion, ce qui rend le spectre de fréquence de plus en plus rare et saturé.

Plusieurs propositions ont été présentées pour optimiser l'allocation des canaux de fréquences afin d'atténuer les interférences entre les liaisons proches qui transmettent des données. Beaucoup d'entre eux utilisent un critère unique, tels que l'interférence et l'occupation de canaux, et ne considèrent pas un ensemble de caractéristiques le comportement de l'utilisateur pour guider le processus d'allocation de canaux.

Les utilisateurs ont des cycles de routine et un comportement social. Ils passent au travail, à l'école, utilisent leurs appareils mobiles générant du trafic de données, et rencontrent des amis formant des groupes. Ces caractéristiques peuvent être explorées pour optimiser le processus d'allocation des canaux. Dans ce contexte, cette thèse présente une stratégie d'allocation de canaux pour les réseaux sans fil, basée sur le comportement de l'utilisateur.

Notre contribution principale consiste à considérer certaines caractéristiques du comportement de l'utilisateur, telles que la mobilité, le trafic et la popularité dans le processus d'allocation des canaux. De cette façon, nous priorisons l'allocation de canaux pour les nœuds qui resteront dans le réseau dans une fenêtre de temps future, avec un trafic plus élevé dans le réseau, et avec plus de popularité.

Nous adoptons une approche distribuée qui permet de limiter le nombre de messages échangés dans le réseau tout en répondant rapidement aux changements de la topologie du réseau. Nous avons adopté un modèle d'interférence à deux sauts. Dans ce modèle, deux liens sont considérés comme interférant s'ils sont à deux sauts éloignés l'un de l'autre.

Chaque nœud du réseau possède deux interfaces sans fil. Une interface est responsable de l'échange de messages de contrôle, tels que les messages Hello, l'interaction et le routage. L'autre interface est chargée d'envoyer les paquets de données et de changer de canal en fonction de l'algorithme d'attribution de canal.

Dans notre stratégie, les nœuds de réseau échangent périodiquement des informations sur les canaux disponibles et la mobilité (position et vitesse), en utilisant des messages Hello. Un nœud voisin reçoit les messages Hello et vérifie la stabilité de la topologie. La stabilité est importante pour qu'un nœud détecte tous ses voisins. La topologie est considérée comme stable si elle ne change pas après l'échange consécutif de deux messages Hello.

Si la topologie n'est pas stable, les nœuds continuent à recevoir des messages Hello jusqu'à ce qu'il devienne stable. Si la topologie est stable, le nœud obtient une liste de canaux communs. Cette liste est obtenue à partir de l'intersection entre les canaux obtenus à partir du message Hello pour chaque lien et la liste des canaux locaux. Cette liste contient les canaux qui peuvent être sélectionnés par l'algorithme d'allocation des canaux.

L'algorithme commande les liens d'un nœud en fonction de la priorité de chaque lien et sélectionne un canal qui interfère moins avec ses voisins par deux sauts. La priorité de chaque lien est fonction de la mobilité, du trafic et de la popularité du nœud voisin appartenant au lien.

En séquence, un nœud notifie les canaux alloués dans ses liens et leur priorité aux nœuds voisins. Cette notification est effectuée à l'aide de messages d'interaction. Un nœud voisin reçoit un message d'interaction et compare sa priorité locale à la priorité contenue dans le message d'interaction. Si la priorité du message est plus petite, le nœud ignore le message. Si la priorité est supérieure, le nœud accepte l'attribution de canal du nœud voisin au lien qui a reçu le message d'interaction, commande ses liens en fonction de ses priorités et alloue un canal qui interfère moins avec les canaux contenus dans le message d'interaction (moins interférer avec deux sauts).

Dans notre évaluation des performances, nous considérons des scénarios dans des réseaux ad hoc et véhiculaires, et nous utilisons des modèles de mobilité synthétique, tels que SLAW et Manhattan Grid, et l'ensemble de données de traces de ville de Cologne, Allemagne.

Dans les scénarios, nous comparons notre mécanisme avec différents types d'approches, un centralisé (nommé TABU), un aléatoire (nommé RANDOM), un avec la plus grande distance spectrale (appelé LD), et un avec un seul canal (appelé SC).

Nous évaluons les métriques telles que le débit agrégé, le débit de livraison des paquets et le délai de bout en bout. Les simulations envisageant un scénario ad hoc avec un routage mono diffusion montrent que notre stratégie présente des améliorations en termes de débit de l'ordre de 14,81% par rapport à RANDOM et de 16,28% par rapport à l'allocation de canal LD.

Dans le scénario véhicule, notre stratégie montre des gains de taux de livraison de paquets de l'ordre de 11,65% et de 17,18% par rapport aux méthodes RANDOM et SC, respectivement. Dans les deux scénarios, la performance de notre stratégie est proche de la recherche de la limite supérieure de l'approche centralisée de TABU, mais avec des frais généraux moins élevés.





I dedicate this thesis to God,  
for the faith that keeps me alive,  
to my family  
who knew how to understand my absence,  
my friends and all the people  
who contributed to the development of this work.



## PUBLICATIONS

---

### PUBLISHED

- Roni Francis Shigueta, Aline Carneiro Viana, Mauro Fonseca. "A Mobility-Aware Channel Allocation Strategy for Clustered Ad hoc Network". *IEEE 85th Vehicular Technology Conference (VTC)*, 2017. Sydney, Australia.
- Roni Francis Shigueta, Aline Carneiro Viana, Mauro Fonseca. "User Behavior-Aware Channel Allocation Scheme for Mobile Ad hoc Networks". *IEEE 35th International Performance Computing and Communications Conference*, 2016. Las Vegas, United States.
- Roni Francis Shigueta, Aline Carneiro Viana, Mauro Fonseca, Artur Ziviani, and Anelise Munaretto. "A Strategy for Opportunistic Cognitive Channel Allocation in Wireless Internet of Things". *IFIP Wireless Days*, 2014. Rio de Janeiro, Brazil.



*Our greatest weakness lies in giving up.  
The most certain way to succeed is  
always to try just one more time.*

— Thomas A. Edison [1]

## ACKNOWLEDGMENTS

---

I would like to thank PUC/PR and INRIA by the reception during the development period of this thesis. I would like to thank the PUC/PR and INRIA colleagues for their help and cooperation and to all the people who contributed directly and indirectly with this work. Special thanks to my family and friends, for the moral and emotional support, without which I was nothing. Finally, I am deeply grateful to Mauro Fonseca, and Aline Viana for their supervision, advice, patience, and inspiration.

To all my thanks.



# CONTENTS

---

1	INTRODUCTION	1
1.1	Context and Motivation	1
1.2	Problem Statement	3
1.2.1	Can the frequency spectrum be better allocated according to the user behavior?	3
1.2.2	Can a channel allocation mechanism be easily deployable?	4
1.3	Contribution of this thesis	4
1.4	Organization	6
2	BACKGROUND AND RELATED WORK	7
2.1	Wireless Channel Allocation: The Background	7
2.1.1	Criteria to channel allocation	8
2.1.2	Approaches in Channel Allocation	11
2.1.3	Techniques used to model and solve the channel allocation problem	12
2.1.4	Interference models	15
2.1.5	Mobility model	18
2.2	Wireless Channel Allocation: The Related Work	21
2.2.1	Related Work in Ad Hoc network	21
2.2.2	Related Work in VANET network	25
2.3	Conclusion	29
3	CHANNEL ALLOCATION STRATEGY IN AD HOC NETWORKS	31
3.1	Formulation of the problem	31
3.1.1	Channel model	31
3.1.2	Network model	32
3.1.3	Interference model	33
3.1.4	Problem Statement	33
3.2	The Channel Allocation Mechanism	34
3.2.1	State1 (Scheduler)	35
3.2.2	State2 (Topology Manager)	36
3.2.3	State3 (Allocation Mechanism)	37
3.2.4	State4 (Interaction Mechanism)	45
3.3	Computational Complexity Analysis of the Algorithm	47
3.4	Evaluation Scenarios	49
3.4.1	Scenario1: Grid topology	49

3.4.2	Scenario2: SLAW mobility model	56
3.5	Conclusion	62
4	CHANNEL ALLOCATION STRATEGY IN VEHICULAR NETWORKS	65
4.1	Formulation of the problem	65
4.1.1	Channel model	65
4.1.2	Network and interference model	66
4.1.3	Problem Statement	66
4.2	The Channel Allocation Mechanism	66
4.3	Performance Evaluation	68
4.3.1	Scenario1: Manhattan Grid Scenario	69
4.3.2	Scenario2: Traces of the Cologne City with DTN protocol	72
4.4	Conclusion	77
5	CONCLUSIONS AND FUTURE HORIZONS	79
5.1	Summary of the Thesis	79
5.2	Future Horizons	80
	BIBLIOGRAPHY	83



## LIST OF FIGURES

---

Figure 1	Growth of connected IoT devices	1
Figure 2	Growth of mobile data traffic in the world	2
Figure 3	Criteria, approaches, and techniques used in channel allocation	8
Figure 4	Hidden terminal problem	9
Figure 5	Communication and conflict graph	14
Figure 6	Interference models	15
Figure 7	Interference model at 2 hops	17
Figure 8	Mobility models	19
Figure 9	Channels overlapping in Wireless Fidelity (WIFI) spectrum [98]	32
Figure 10	State machine	34
Figure 11	Sending Hello message	35
Figure 12	Hello message	36
Figure 13	Example of network graph	37
Figure 14	Example of velocity vector	41
Figure 15	Example of link priority	43
Figure 16	Allocated channels	44
Figure 17	Example of Interaction message	45
Figure 18	Node receiving an Interaction message	46
Figure 19	Node B recalculating channels	47
Figure 20	Aggregated throughput, packet delivery rate, and end-to-end delay in grid topology	52
Figure 21	Aggregated throughput, number of channels and number of flows	54
Figure 22	End-to-end delay, packet delivery rate, and number of flows	55
Figure 23	Aggregated throughput, packet delivery rate, and mobility	56
Figure 24	Network topology for SLAW mobility model	58
Figure 25	Aggregated throughput and overhead in SLAW	59
Figure 26	Spectral distance and packet delivery rate in SLAW	60
Figure 27	End-to-end delay and mobility in SLAW	61
Figure 28	Throughput and packet delivery rate according to the number of nodes	62

Figure 29	Channels of IEEE 802.11p standard	65
Figure 30	Packet delivery rate, end-to-end delay, and hops count in Manhattan Grid	71
Figure 31	Density of vehicles at 6:00 a.m. and 7:00 a.m. in Cologne	74
Figure 32	Packet delivery rate, end-to-end delay, and hops count in VDTN	75
Figure 33	TABU, MobiCA, RANDOM and SPRAY AND WAIT in DTN scenario	76

## LIST OF TABLES

---

Table 1	Criteria to channel allocation	11
Table 2	Approaches in channel allocation	12
Table 3	Techniques used to solve the channel allocation problem	15
Table 4	Comparison among related work in ad hoc networks.	24
Table 5	Comparison among MobiCA and related work.	28
Table 6	Interference factor in 802.11b/g spectrum channels	32
Table 7	Terms used in the equations	39
Table 8	Scenario configuration parameters for Cologne city mobility model	50
Table 9	Scenario configuration parameters for SLAW mobility model	58
Table 10	Configuration parameters for Manhattan Grid Scenario	70
Table 11	Configuration parameters for Cologne city scenario	73
Table 12	DTN configuration parameters	73

## LISTINGS

---

## ACRONYMS

---

ACO	Ant Colony Optimization
AP	Access Point
AU	Application Unit
BER	Bit Error Rate
BLP	Binary Linear Program
CBR	Constant Bit Rate
CCC	Common Control Channel
CCH	Control Channel
CDMA	Code Division Multiple Access
CSMA/CA	Carrier Sense Multiple Access with Collision Avoidance
CQ	Channel Quality
CTS	Clear to Send
DCAS	Distributed Channel Assignment Scheme
DSCA	Dynamic Service Channel Allocation
DSRC	Dedicated Short-Range Communication
DTN	Delay-Tolerant Networking
EA	Evolutionary Algorithm
EP	EPIDEMIC
FCC	Federal Communication Commission

FTP	File Transfer Protocol
GA	Genetic Algorithm
GPS	Global Positioning System
IoT	Internet of Things
LD	Largest Distance
MAC	Media Access Control
MANET	Mobile Ad hoc Network
M2M	Machine-to-Machine
MILP	Mixed-Integer Linear Programming
MIMO	Multiple Input Multiple Output
MobiCA	Mobility-aware Channel Allocation
MOCOPo	Measuring and Modelling Congestion and Pollution
NCCC	No Common Control Channel
ND	Not Defined
NS	Network Simulator
OBU	On Board Unit
OFDM	Orthogonal Frequency Division Multiplexing
OFDMA	Orthogonal Frequency Division Multiple Access
P2P	Peer to Peer
QoS	Quality of Service
RF	Radio Frequency
RSU	Road Side Unit
RTS	Request to Send
SC	Single Channel
SCH	Service Channel
SLAW	Self-similar Least Action Walk
SINR	Signal-to-Interference-plus-Noise-Ratio

SNR	Signal-to-Noise Ratio
SW	SPRAY AND WAIT
TDMA	Time Division Multiple Access
VANET	Vehicular Ad Hoc Network
VDTN	Vehicular Delay-Tolerant Networking
VoIP	Voice over Internet Protocol
WIFI	Wireless Fidelity



## INTRODUCTION

---

### 1.1 CONTEXT AND MOTIVATION

The popularization of mobile devices (laptops, smartphones, and tablets) and the growing use of services (web, e-mail, video on demand, and social networks) over the wireless network have increasingly consumed frequency spectrum resources.

According to [2], the global number of smartphone users grew from 1.57 billion in 2014 to 2.32 billion in 2017 (growth of 47.7%), and it is forecasted to grow to 2.87 billion in 2020. With this growth, the number of mobile Internet users surpassed desktop ones: e.g., mobile devices represent 52.7% of global Internet connections [3] and 75.1% of Internet connections in USA. This growth in smartphone connections is followed by Machine-to-Machine (M2M) and Internet of Things (IoT) connections, which are increasingly saturating the frequency spectrum.

Figure 1 shows the growth of connected IoT devices [2].

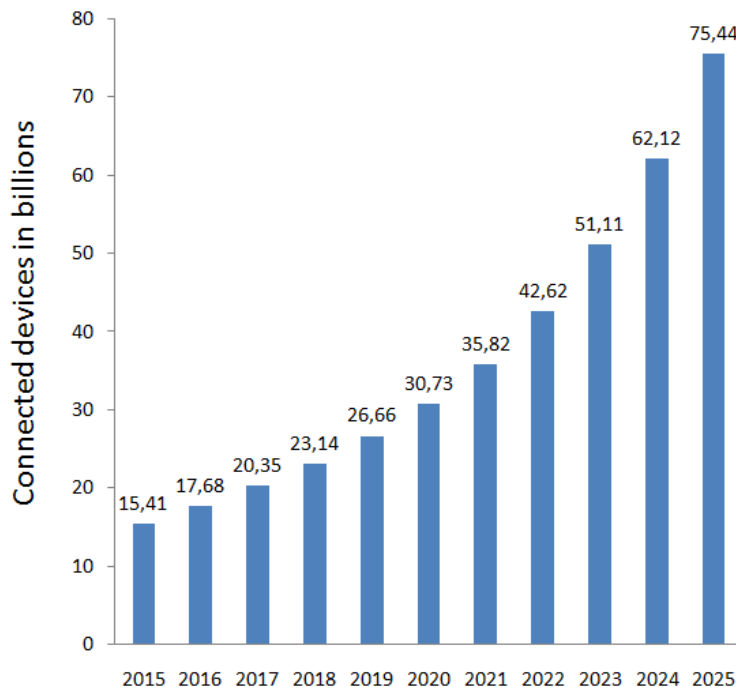

Figure 1: Growth of connected IoT devices [2]

As we can see, the growth of installed IoT devices is exponential and the forecast for 2025 is 75 billions in connected devices.

In addition to the increased use of smartphones and IoT devices installed in the network, we have the development of mobile applications and their increasing consumption. According to ERICSSON Mobility report [4], the growth of mobile data traffic is exponential and as can be seen in Figure 2, it was of 50% between Q3 2015 and Q3 2016.

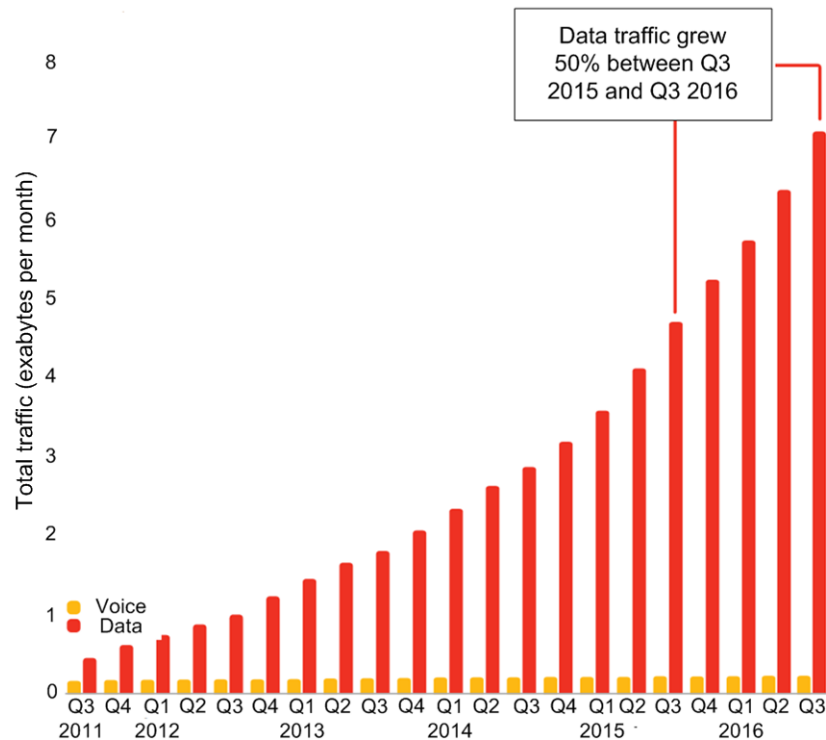

Figure 2: Growth of mobile data traffic in the world [4]

The burst of mobile network traffic increasingly consumes resources, such as processor, memory, buffer, power, and spectrum. Contrarily to processor, memory, buffer, and power, the spectrum is more difficult to be scalable. Spectrum is a limited resource, with high concurrency, and with strong regulation. In this context, we concentrate our focus on the spectrum resource, more specifically in channel allocation.

Besides that, another challenge to be considered is the impact that user behavior brings to the network usage and consequently, to the channel allocation management. Users have routine-based and social behavior, what translates into the establishment of clusters or communities [5]. In addition, their



mobility results in many connections/disconnections, requiring a quick and optimal channel allocation management.

In this context, the purpose of this thesis is to present a strategy that leverages characteristics of user behavior for channel allocation in both, ad hoc and vehicular networks.

## 1.2 PROBLEM STATEMENT

### 1.2.1 *Can the frequency spectrum be better allocated according to the user behavior?*

Considering the large number of devices, the growing number of network services, and the mobility of people, the network connections are increasingly subject to intermittency, having transient characteristics that are dictated by people's social behavior.

Although many studies address channel allocation, they consider only aspects such as interference, traffic, and channel occupation and often in isolation. In this way, they are oblivious to behaviors inherent of users. We advocate that user behavior knowledge can be taken into account while reducing the impact of disconnectivity, densification, and traffic overload in channel allocation. Users have several characteristics that define their behavior, such as mobility, points of interest, popularity, generated traffic, energy level, applications running, and so on. In our work, we concentrate in three characteristics: mobility, traffic, and node popularity.

#### 1.2.1.1 *Mobility*

Users move between points of interest by connecting and disconnecting their devices across several different networks throughout their journey. Vehicles communicate with each other using ad hoc connections or a Road Side Unit (RSU), and the high speed of vehicles degrades quickly the signal. In this way, if there is no mechanism to prioritize the channel allocation in the network, many devices that are leaving, that have connections with high intermittency or low time of permanence in the network can allocate channels of higher quality. On the other hand, devices with a higher time of permanence allocate the channels with lower quality, underutilizing network resources.

#### 1.2.1.2 *Traffic*

Another issue regarding user behavior is the generated traffic. The resulting signal from the generated traffic may cause interference on the neighboring links if they are using the same channel. High traffic links (such as backbone links) may experience interference from neighboring link's traffic or have to share the same channel with other links. In this case, the performance of the high traffic links decreases if an efficient channel selection mechanism is not used. In addition, links with lower traffic can allocate channels with high quality, underutilizing the use of the channel.

#### 1.2.1.3 *Popularity*

Finally, people have a social behavior and have the tendency to live in communities or clusters. Clusters with highly popular people naturally attract more people, resulting in higher density if compared with clusters having less or no popular people. Nodes more popular can act as influential spreader that propagates information to a large portion of the network. In this way, it is possible to prioritize the channel allocation for the most popular nodes.

#### 1.2.2 *Can a channel allocation mechanism be easily deployable?*

Many references in the literature present solutions for channel allocation related to physical parameters requiring the development of new hardware or the adaptation of the Media Access Control (MAC) layer. Thus, the development of a hardware-independent solution allows its use with existing standards, simplifying thus its deployment.

### 1.3 CONTRIBUTION OF THIS THESIS

This thesis presents a channel allocation mechanism for wireless networks that leverage user behavior knowledge. We consider three characteristics of user behavior: node mobility, traffic generated, and node popularity. The contribution of this thesis consists of the following characteristics:

- Our strategy allows allocating channels of higher quality (i.e., with less interference) for the nodes that have the longest time of permanence in the network. In this way,

nodes who tend to leave the network in a future time window do not allocate the best network channels, saving network resources.

- Devices with higher traffic on the network have a higher channel allocation priority over devices with lower traffic. This allows to reduce the contention on high traffic links and increases the network performance.
- Our mechanism allows clusters, formed due to mobility and the popularity of devices, to receive channels with less interference. Besides, the links created by the devices within a cluster can receive different channels, allowing the parallel communication of devices within a cluster (intra-cluster communication).
- We use a distributed approach, limited to two hops, which allows estimating the interference in the neighborhood of a node, without the need to know the entire topology of the network. That allows reducing the number of messages exchanged in the network and consequently, the overhead.
- Our proposal is based on Carrier Sense Multiple Access with Collision Avoidance (CSMA/CA), maintaining compatibility with current networks, being hardware independent and easy to implement. Many proposals in the literature are based on Time Division Multiple Access (TDMA) and require hardware modification.
- In our simulations, we use several synthetic mobility models or trace-based datasets, describing mobility of hand-held devices or vehicles.

We analyze the channel allocation regarding the following scenarios:

- Ad hoc mobility networks: we use the IEEE 802.11b/g/n/ac spectrum, considering the interference of the adjacent channels and a mobility model that represents the behavior of the user's movement.
- Vehicular networks: we use the IEEE 802.11p spectrum in a scenario considering the Manhattan Grid mobility model. In addition, we consider a Delay-Tolerant Networking (DTN) scenario using the traces dataset of the vehicles in the city of Cologne, Germany.

## 1.4 ORGANIZATION

This thesis is organized in the following chapters:

- Chapter 2 presents the background and related work in channel allocation process. In this chapter, we present the main criteria, approaches, and techniques found in the literature to solve the channel allocation problem, some interference and mobility models and traces dataset. In addition, we address the related work in channel allocation for Ad Hoc and Vehicular Ad Hoc Network ([VANET](#))s networks.
- Chapter 3 presents the formulation of the problem, the channel allocation mechanism, and the performance evaluation in ad hoc network. In our evaluation, we consider two scenarios, one based on a grid topology and the other based on Self-similar Least Action Walk ([SLAW](#)) mobility model.
- Chapter 4 addresses our channel allocation strategy in vehicular ad hoc network. We present the formulation of the problem, the channel allocation mechanism, and the performance evaluation considering two scenarios, one based on a synthetic model (Manhattan grid) and other based on traces (Cologne dataset with [DTN](#) protocol).
- Finally, Chapter 5 presents our conclusions and future horizons.

## BACKGROUND AND RELATED WORK

---

This chapter presents the background and the related work in Ad hoc and VANET networks. In background, we present how the channel allocation problem is addressed, some interference and mobility models and traces dataset used in network simulation. In related work we compare our strategy with different solutions proposed in the literature, considering different aspects of channel allocation such as interference, mobility, traffic, and popularity.

### 2.1 WIRELESS CHANNEL ALLOCATION: THE BACKGROUND

The process for solving the channel allocation problem usually involves three parts. In the first are defined the criteria to channel allocation. The criteria represent the factors to be considered in the channel allocation process, such as, occupation or interference on channel, traffic in the links, mobility, or fairness. In the second part are defined the approaches to be adopted, e.g., centralized or distributed, and with/without control channel. In the third part is defined the technique used to model and solve the channel allocation problem.

Some of the techniques may be simple. For example, a node locally monitors the occupation of the channels in its transmission radius and selects the channel with lower occupation. In this case, if several nodes select the same channel with lower occupation, they compete to the channel at the time of transmission.

Other techniques may be more complex because they involve different channel allocation criteria associated simultaneously, or a larger volume of data processing. In the last case, for example, the adoption of heuristic or evolutionary algorithms can be more efficient to find a feasible solution to solve the problem.

Figure 3 shows the parts that represent the process for solving the channel allocation problem and which will be detailed in the next subsection. The check mark (in green) indicates the criteria, approaches and the techniques that we will use in our proposal of channel allocation.

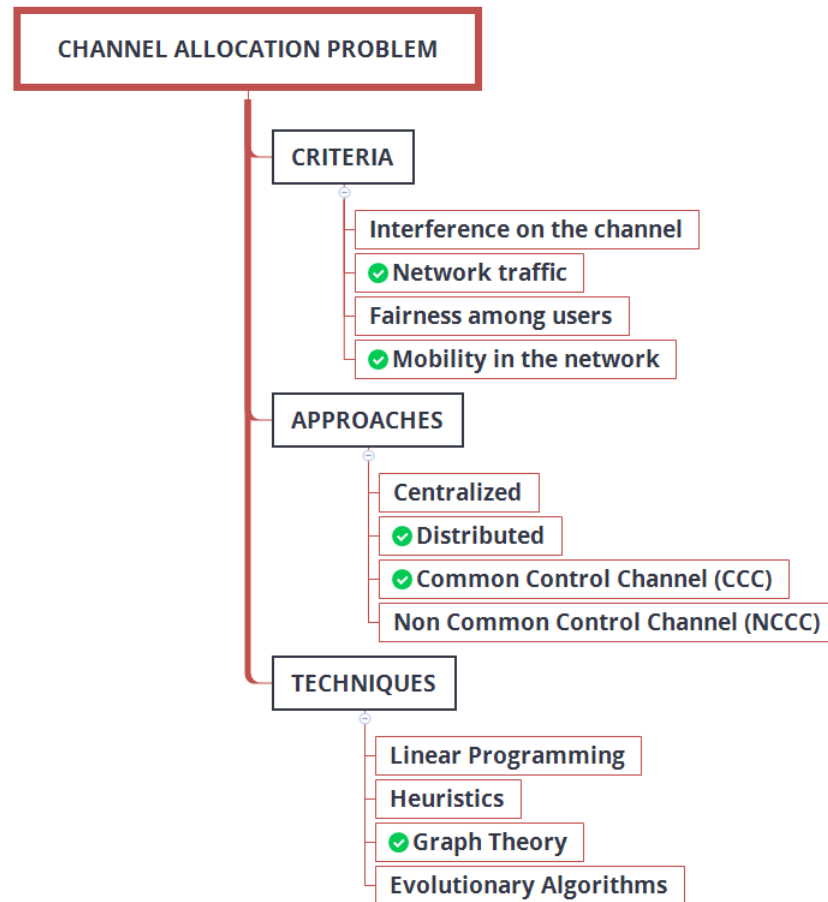

Figure 3: Criteria, approaches, and techniques used to solve the channel allocation problem

### 2.1.1.1 *Criteria to channel allocation*

Although there are several types of criteria used in channel allocation, they can be used with more or less emphasis depending on the type of optimization sought in the network. In this subsection, we address some criteria such as based on channel interference, network traffic, fairness, and user mobility.

#### 2.1.1.1.1 *Selection criterion based on channel interference*

In this criterion, the channels are periodically scanned and the least used or less interfering channel is selected. The use of the channel is represented by the signal level or the number of frames transported by a channel.

The criterion based on channel interference is used by both operation modes: infrastructure and ad hoc. In infrastructure

mode, an Access Point (AP) is used to scan the channels, evaluate their use or the interference level and allocate the best channel, as shown in [6] and [7].

In ad hoc networks, the channel allocation is not performed by a central unit, as an AP. Instead, the decisions of channel allocation are made by the nodes independently, selecting the less interfering channel.

Most ad hoc networks operate as a cluster. A cluster is a set of nodes consisting of a cluster head (responsible for allocating resources) and cluster members (that determine the boundary of the cluster). The cluster head usually is elected dynamically by the cluster members. In the work presented by [8], the cluster head is represented by a channel coordinator that continuously monitor the power level in all channels. If the load on the channel increases beyond the capacity, the channel coordinator change to an additional channel with the lowest power level measurement.

The problem of the channel allocation considering only the monitoring and selection of channels with less activity/interference is that a device receives the signals only from others devices within its communication range. They do not detect the interference at 2 hops (interference among neighboring links). For example, in Figure 4, the AP receives beacons of device1. Device3 receives beacons of device2. Since AP does not see device3 (and vice versa), the channel allocation mechanism can allocate the same channel to the two links (AP-device1 and device2-device3). This will cause interference between the two links and this problem is known as hidden terminal problem.

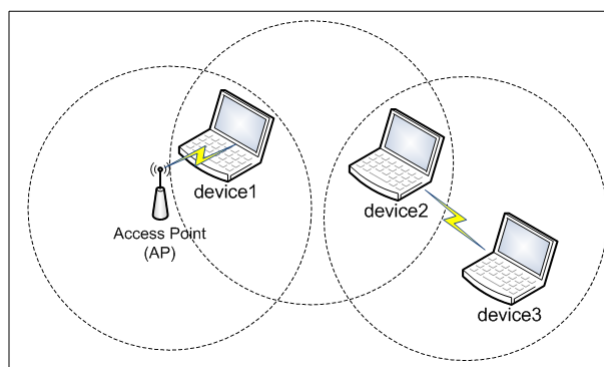

Figure 4: Hidden terminal problem

To mitigate the hidden terminal problem, [9] proposed a centralized client-driven channel allocation approach. In that pro-

posal, the client that is under the transmission range of several APs is associated to an AP that has a channel with fewer users.

#### 2.1.1.2 *Selection criterion based on network traffic*

The solution proposed by [9] is known as traffic-agnostic and the channel allocation process occurs without to consider the traffic in the links. Thus, a non-interfering channel can be allocated to an inactive link (without traffic), underutilizing the channel. A channel allocation mechanism using traffic as selection criterion allows allocating non-interfering channels (or with lower interference level) to links with higher traffic. Thus, shared channels may be allocated to links with lower traffic load. Several authors in the literature have proposed channel allocation mechanisms considering the traffic as a decision criterion, as presented in [10], [11], [12], and [13].

#### 2.1.1.3 *Selection criterion based on fairness*

In the selection criterion based on fairness, the objective is to allocate channels or increase the network performance in a fair way. In [14] is proposed a method to maximize the network throughput and, at the same time, to enhance fairness. In [15] is presented a mechanism for maximizing the use of per-flow bandwidth with fairness. In [16], the authors present a strategy to maximize the minimal channel gain to achieve relative fairness.

#### 2.1.1.4 *Selection criterion based on user mobility*

The channel allocation related to user mobility has been studied mainly in cellular systems. In [17] and [18], the authors propose mobility-aware resource allocation schemes for femtocell networks. The objective is to associate the best spectrum set of frequency/time while considering the user's mobility.

In [19] and [20] the authors present strategies for cognitive and VANET networks. In [19], the channels change when a node joins or leaves the network. In [20], the nodes use the relative velocity of nodes to determine the cluster centroid and the position of the nodes. The nearest node of the cluster centroid is designed as the cluster head and allocates the channels for cluster members.

Table 1 summarizes the criteria previously seen and which are addressed in the literature.



Table 1: Criteria to channel allocation.

CRITERION	OBJECTIVES	REFERENCES
Interference	Allocate less interfering channel	[6], [7], [8], [9]
Traffic	Protect links with higher traffic	[10], [11], [12], [13]
Fairness	Fair channel allocation	[14], [15], [16]
Mobility	Allocation according to mobility	[17], [18], [19], [20]

### 2.1.2 Approaches in Channel Allocation

In channel allocation, the approaches can be classified as centralized or distributed and with common control channel or without common control channel.

#### 2.1.2.1 Centralized and Distributed Approach

In a centralized approach, a central unit is responsible for the channel allocation for each node/link in the network. In the literature, several authors have used a centralized approach to the channel allocation in wireless networks, as presented in [21], [22], [23], and [24].

In the distributed approach, the decision about channel allocation is taken locally in a manner fast, adaptative, but not always optimally. The distributed approach has been used in several types of networks. In [25] and [26] are presented distributed channel allocation mechanisms for IEEE 802.11 networks and in [27] and [28] for cognitive radio networks.

#### 2.1.2.2 Common Control Channel and Not Common Control Channel

The Common Control Channel (CCC) is a dedicated channel which allows maintaining a minimum connectivity among nodes and to exchange control messages.

Several previous works in the literature, such as in [29], [30], [31], and [28], address the channel allocation problem using a dedicated CCC. In that cases, the network nodes use two interfaces, one operating as CCC interface and other as data interface, simplifying the coordination process between the nodes.

Others works, such as [32] and [33], do not use a CCC in channel allocation process. In [32], for example, is used a single interface and the channels with less occupancy are selected. The information about the channel is passed to all other devices

Table 2: Approaches in channel allocation.

APPROACH	DESCRIPTION	REFERENCES
Centralized	Central unit allocates channel	[21], [22], [23], [24]
Distributed	Any node can allocate channel	[25], [26], [27], [28]
CCC	Control channel shared	[29], [30], [31], [28]
Not CCC	No control channel shared	[32], [33]

through the channel that is being shared by control and data plane.

Table 2 summarizes the approaches used in the channel allocation process.

### 2.1.3 *Techniques used to model and solve the channel allocation problem*

In this subsection, we address some techniques used to model and solve the channel allocation problem, such as linear programming, heuristics, evolutionary algorithms, and graph theory.

#### 2.1.3.1 *Linear programming*

Linear Programming is a technique very used in channel allocation in wireless networks. Usually, the channel allocation is described as an NP-hard problem, meaning that the optimal solution grows exponentially with the size of the network. To simplify the resolution of the problem, the channel allocation mechanism can be modeled as a Binary Linear Program (BLP) that can be solved in polynomial time [34]. Several authors address the channel allocation problem as a linear programming problem as in [35], [36], [37]. A survey about techniques based on Linear Programming for resource allocation in wireless networks can be found in [38].

#### 2.1.3.2 *Heuristics*

In problems involving linear programming, it is common the difficulty of quickly finding a feasible solution in computational time. A heuristic method allows finding a near-optimal solution quickly in cases where an exhaustive search is impractical. In

a heuristic method, the algorithm is interactive and in each interaction, it searches a good solution, as, the channels with less interference level. Several heuristics techniques are presented in the literature to solve the channel allocation problem.

In [39] and [40] is used Simulated Annealing. In [41], [42], and [43] are proposed Greedy heuristic. In [44] and [45] are presented TABU heuristic.

TABU heuristic [46] starts with an initial solution according to some criterion (e.g., less interfering channels) and at each iteration, the best solution in the neighborhood is sought. Each selected solution is stored in a list (TABU list) and it is not allowed to repeat moves that lead to an already selected solution. The list remains in memory for a certain amount of time or number of interactions. The final result is expected to be a global optimum or the nearest solution. In our work, we compared our channel allocation strategy with TABU heuristic.

### 2.1.3.3 *Evolutionary Algorithms*

Evolutionary Algorithm (EA) is a term used to describe population-based stochastic search algorithms that in some sense mimic natural evolution [47].

Several authors in the literature address the channel allocation using evolutionary algorithms. In [48], Genetic Algorithm (GA) is applied to channel allocation in OFDMA system. In [49], authors propose an algorithm based on ant colony intelligence to solve the problem of channel allocation in Peer to Peer (P2P) links. In [50], authors present a particle swarm optimization method to assign conflict free channel in mobile wireless networks. In [51], neural network is used for dynamic channel allocation in mobile multimedia networks, considering the handoff and traffic mobility.

Although the Evolutionary algorithm is a technique widely used in channel allocation, it is an extensive topic that is not part of our scope. Surveys about Evolutionary algorithms are presented by [52], [53], and [54].

### 2.1.3.4 *Graph theory*

In Graph theory, the network is represented as a graph where the vertices correspond to the mobile devices (nodes) and the edges correspond to the links between devices. This type of graph is known as communication graph. A technique widely used to solve problems of channel allocation based on a graph

is graph coloring. In this technique, the objective is to assign a minimum set of different colors (one corresponding to each available channel) for the edges of a graph in a manner that two adjacent nodes do not use the same color (channel). This technique is addressed in [55], [56], and [57].

A derivation of communication graph that is used to capture the interference among concurrent transmissions within the same interference range is known as conflict graph [45].

In conflict graph, each vertex represents a communication link (and no more a device as in communication graph) and the objective is to allocate a different or less interfering channel for each vertex of the graph.

Figure 5 illustrates a communication and conflict graph.

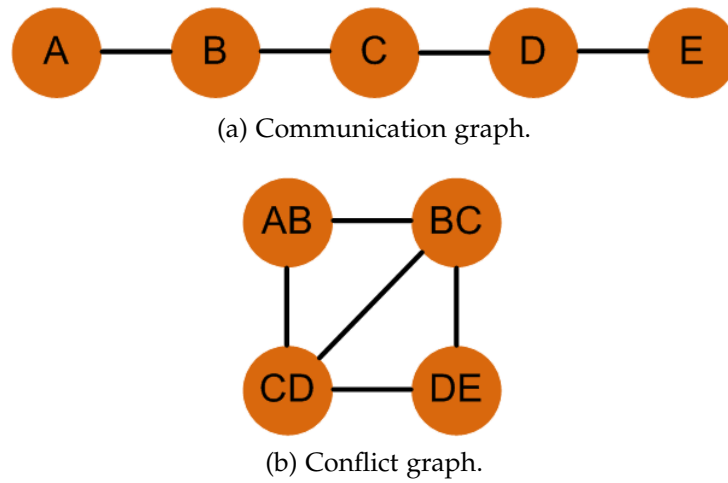

Figure 5: Communication and conflict graph.

In Figure 5b, the vertex AB in a conflict graph represents the link between the node A and B in the communication graph (Figure 5a). The vertices BC, CD, and DE (Figure 5b) represent the links between the nodes B and C, C and D, D and E (Figure 5a), respectively. The vertex AB in conflict graph interferes with the vertices BC, and CD, but not with DE. Thus, the objective is to allocate a different or less interfering channel for each vertex of the graph which interferes with each other.

In our work, we represent the network as a communication graph with the objective of allocating a less interfering channel for edges (links) at 2 hops. For this, we adopt an interference model at 2 hops that will be addressed in the next subsection.

Table 3 summarizes some techniques used to solve the channel allocation problem.

Table 3: Techniques used to solve the channel allocation problem.

APPROACH	DESCRIPTION	REFERENCES
Linear	Based on mathematics	[21], [22], [23], [24]
Heuristics	Search by sub-optimal solutions	[25], [26], [27], [28]
Evolutionary	Inspired by biological evolution	[48], [49], [50], [51]
Graph	Network is represented by a graph	[55], [56], [57], [45]

#### 2.1.4 Interference models

As one of the objectives of channel allocation is to mitigate network interference, this subsection presents some interference models that are commonly used in the channel allocation process. Interference mitigation allows optimizing network performance as it improves channel conditions.

Figure 6 shows some interference models presented in the literature.

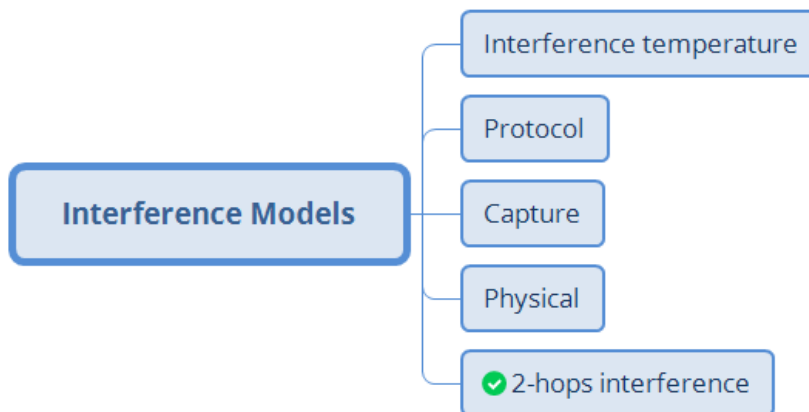

Figure 6: Interference models

##### 2.1.4.1 Interference temperature model

The interference temperature was recommended by Federal Communication Commission (FCC) [58] as a metric to quantify and manage the interference so that it remains at acceptable levels at the receiver. It is a measure of the Radio Frequency (RF) power of the transmitters or sources of noise that is present in the receiving antenna [59].

The interference temperature model is widely used in channel allocation in cognitive radio networks where the level of in-

interference caused by an unlicensed transmitter must be below an interference threshold on a licensed neighbor node.

#### 2.1.4.2 Protocol model

The protocol model is based on the relative positions of the nodes when they are transmitting. In this model, the transmission is successfully received when [60]:

$$|X_k - X_j| \geq (1 + \Delta)|X_i - X_j| \quad (1)$$

and

$$|X_k - X_j| \leq R_c \quad (2)$$

where:

$X_i$  position of the node  $i$

$X_j$  position of the node  $j$

$X_k$  position of the node  $k$  when it transmits on the same channel as  $i$  and  $j$

$R_c$  communication range

$\Delta$  guard band to prevent a neighboring node to use the same channel

#### 2.1.4.3 Capture model

The capture model [61] is a binary interference model (two links interfere totally or not with each other), used by the Network Simulator (NS)-2.

It uses three threshold values: reception, capture, and detection of carrier. In this model, a packet is successfully received if the power received on a link and the Signal-to-Noise Ratio (SNR) on the packet are higher than the threshold of reception and the threshold of capture, respectively. The channel will be considered busy if the power received is higher than threshold of detection of carrier.

In [61] is demonstrated that for the isotropic path loss (when all nodes use the same transmission power) the capture model is equivalent to the protocol model.

#### 2.1.4.4 Physical model

The physical model [62] (also known as Signal-to-Interference-plus-Noise-Ratio (SINR) model) is based on SINR and Bit Error Rate (BER). If the SINR value is high enough, greater than the acceptable SINR threshold (antenna gain), the packet is transmitted with a high probability of success.

#### 2.1.4.5 Interference model at 2 hops

In the interference model at 2 hops, two links are considered interfering if they are at most 2 hops away from each other and they use the same channel. This model can be used to predict if a channel allocated to a link will interfere or not at neighbors until 2 hops.

Figure 7 shows an example of the interference among links in the interference model at 2 hops. In the example, node B sends data to node A (through link  $l_{AB}$ ) using the channel 6. When node B sends data to node A, the signal also propagates in the direction of node C (right dashed red arrow) and it interferes in the transmission of node C to node D (link  $l_{CD}$ ) due to the use of the same channel than link  $l_{AB}$ . In the transmission between node C and node D, the signal also propagates in direction of node B (left dashed green arrow), causing interference in the transmission of node B.

In the Figure 7, link  $l_{BC}$  is a neighbor at 1 hop of the link  $l_{AB}$  and link  $l_{CD}$  is a neighbor at 2-hops of the link  $l_{AB}$ .

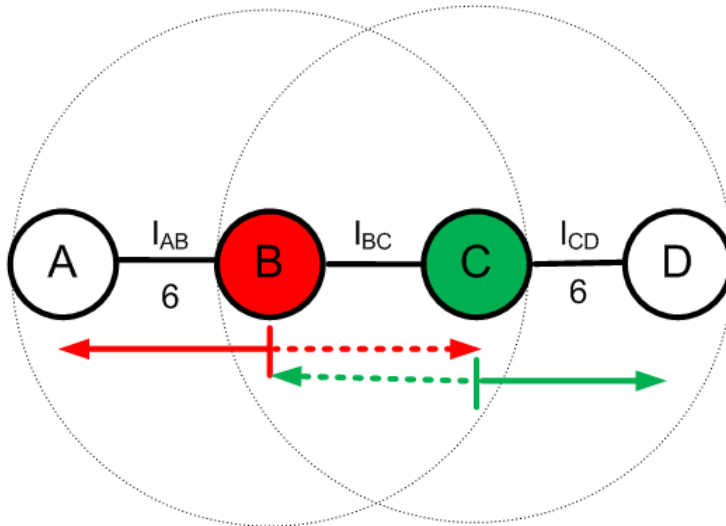

Figure 7: Interference model at 2 hops

In our work, we consider the interference model at 2 hops because while the others models only measure the interference generated by the 1 hop neighbors, the interference model at 2 hops is able to estimate the interference generated by the neighbors of the node that is receiving the packet (neighbors at 2 hops).

Thus, the initial objective in our strategy is to allocate a channel to a link in a manner that the channel is different (or less

interfering) of its neighbors at 2 hops. In this way, the exchange of control messages on the network is limited to 2 hops away.

The use of the interference model at 2 hops allows defining a Channel Quality (CQ) metric, based on the number of neighbors at 2 hops using the same channel. This metric is given by [63]:

$$CQ = 1/(1 + I_{i,c}) \quad (3)$$

where:

$I_{i,c}$  is the number of neighbors at 2 hops from a node  $i$  using the channel  $c$

A smaller number of occurrences of neighbors at 2 hops using the same channel results in a lower interference level and in a higher channel quality.

### 2.1.5 Mobility model

Mobility models [64] represent the movement of devices describing how the position, velocity and the connectivity changing over the time.

The mobility models can be classified according to their movement dependency characteristics as [65]: random models, temporal and spatial dependency models, geographic restriction models, and hybrid models.

In random models, the velocity of a mobile node is a memoryless random process, i.e., the velocity at the current time is independent of the previous time. The behavior of the node can be extreme, such as sudden stop, accelerate or sharp turn. Random models, do not represent real life scenarios where the speed of vehicles and pedestrians will accelerate incrementally and the direction change is smooth.

In temporal dependency, the current velocity of a mobile depends on its previous velocity. Unlike random models, in temporal dependency, the velocities of a node at different time slots are correlated.

In spatial dependency, the movement pattern of a mobile node may be influenced by an another node, as for example, in scenarios of battlefield communications. In spatial dependency, the mobility of various nodes is correlated.

In geographic restriction, the nodes move in a pseudo-random way on predefined pathways and others characteristics, as obstacles and light traffic, can be integrated into the model.

Some models can present more than one dependency (hybrid models). For example, Manhattan Mobility Model [66] presents



temporal dependency and geographic restriction. Freeway mobility model [67] presents temporal and spatial dependency and geographic restriction.

Another mobility model based on social context is the *SLAW* [5]. The social context are typically common gathering places where most people visit during their daily lives such as student unions, dormitory, street mall and restaurants. *SLAW* was created from real Global Positioning System (*GPS*) traces collected from social context of five outdoor sites (two campuses, a metro, Disney World and a state fair scenario) in U.S.

*SLAW* considers some fundamental statistical properties of human mobility: 1) straight line trips without directional change or pause have a truncated power-law distribution; 2) people mostly move only within their own confined areas of mobility and different people have different mobility areas; 3) times elapsed between two successive contacts of the same person can be modeled by a truncated power law distribution; 4) waypoints of humans can be modeled by fractal points (people are more attracted to more popular places); 5) people more likely visit destinations nearer to their current waypoint when visiting multiple destinations in succession.

Figure 8 shows some examples of mobility models.

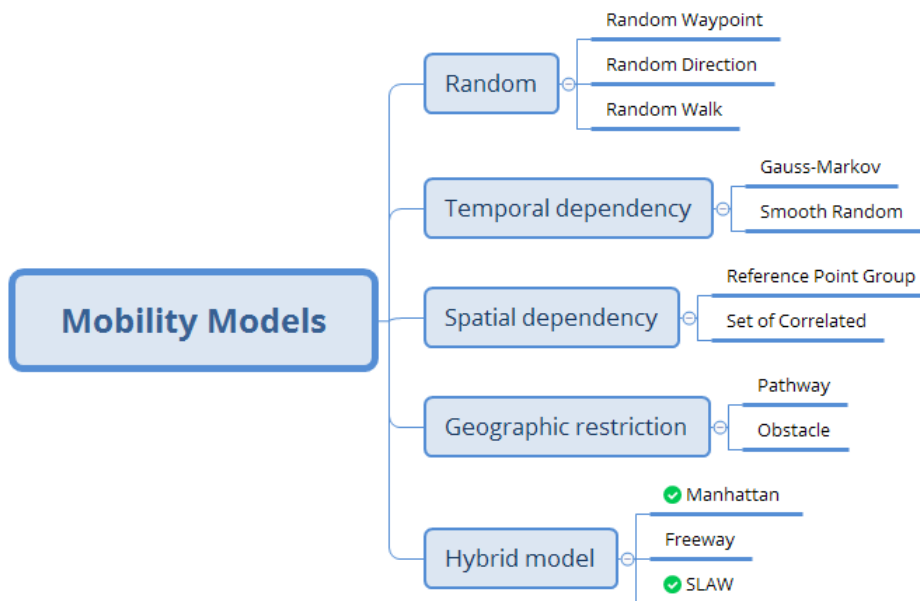

Figure 8: Mobility models

Traces are used to analyze the mobility patterns in real life situations allowing to extract new mobility models. They present accurate information, registering the user's movement for a long duration of time. Some traces datasets available for analysis of mobility are: San Francisco cab, Geolife [GPS](#) trajectory, Measuring and Modelling Congestion and Pollution ([MOCOPo](#)), and city of Cologne.

San Francisco dataset [\[68\]](#) contains [GPS](#) coordinates of approximately 500 taxis collected over 30 days in the San Francisco Bay area.

Geolife dataset [\[69\]](#) was created by collecting the trajectory of 182 users in a period of over five years. The dataset contains 17,621 trajectories with a total of about 1,2 million kilometers and a total duration of 48,000+ hours. The trajectory in the dataset is represented by a sequence of time-stamped points, each of which contains the information of latitude, longitude, and altitude.

[MOCOPo \[70\]](#) is a French project aiming to improve the modeling of congestion and pollutant in urban highways in the Grenoble city. The highways were filmed by three high-definition cameras for several hours and the videos were processed to be transformed into trajectories. The dataset of trajectories is composed of 619 vehicles in a 60-minute time window with an interval of 0.1 s between each trajectory.

Cologne dataset [\[71\]](#) was created, aimed at reproducing, with the highest level of realism possible, car traffic in the greater urban area of the city of Cologne, in German. The dataset covers a region of 400 square kilometers for a period of 24 hours in a typical working day, and comprises more than 700.000 individual car trips.

A food survey on trace-based mobility modeling is presented by [\[72\]](#).

In our work, we consider for ad hoc networks, the [SLAW](#) mobility model, that capture several characteristics of human mobility behavior. For [VANETs](#), we consider the Manhattan Grid mobility model and the traces dataset of the city of Cologne, Germany.

## 2.2 WIRELESS CHANNEL ALLOCATION: THE RELATED WORK

### 2.2.1 *Related Work in Ad Hoc network*

An ad hoc network is a dynamic network where the nodes can communicate directly with each other. Operating in ad hoc mode allows all wireless devices within the range of each other to discover and communicate in peer-to-peer fashion [73].

In the literature, several authors address the channel allocation problem in ad hoc networks.

In [74], the authors propose a distributed channel allocation strategy using a conflict graph. In the strategy, each node is initialized with a random channel number. This strategy has the limitation that the nodes do not have priority in the channel allocation process.

In [75], the authors present a meta-heuristic based on Ant Colony Optimization (ACO). The network is modeled as a graph where each node represents a cluster and the edges corresponds to the links among cluster. The prioritization of the channel allocation occurs in nodes that have the higher number of neighbors (node degree). In the work, the mobility and the data traffic in the nodes are ignored, and MAC layer is not defined.

In [76], the authors propose a channel assignment scheme based on Orthogonal Frequency Division Multiple Access (OFDMA). In the scheme, the nodes hear the signals in all channels and then compare the received signal power with a predetermined threshold. This strategy only considers the local interference being susceptible to interference from hidden terminals.

In [77] is proposed a channel allocation method based on the power level. The method associates different power values to different channels, calculates the transmit power between the nodes and then selects the corresponding channel to the link. In this method, the channels are allocated considering only the power level according to the distance between the nodes.

In [78], the authors present a scheme based on polling where each cluster head learns the traffic pattern of its cluster members and coordinates the transmissions to avoid collisions. This scheme does not consider the node mobility in the channel allocation process and at each cluster is allocated only a shared channel.

In [79] is proposed an energy efficient multichannel MAC protocol using TDMA. In the protocol, the nodes compete for

the access to a control window, and the winner can select a communication channel. The limitation of this protocol is that the channel allocation is only based on contention in the control window.

In [80], the authors present a scheme of channel allocation considering the conflicts of channels. In the work are used control and data channels, and the data channels are assigned randomly. If two senders assign the same channel concurrently to their receivers, then they are required to re-assign the scheduling of the transmission. This scheme selects the channels randomly and it does not consider any other criterion for channel allocation.

In [8], the authors propose a scheme in which a cluster head monitors the power level in all channels. This scheme has the limitation of only detecting the interference in the transmitter, and not in the receptor node. Although the scheme considers the traffic, it does not consider the node mobility in the channel allocation process.

In [81], the authors present a centralized MAC protocol for channel allocation and cooperative load balancing. In the protocol, the channel selection is based on the power level, and it does not consider the node mobility. Besides that, the node only detects the local interference.

In [82] is proposed a centralized model for channel allocation in cluster-based Mobile Ad hoc Network (MANET)s. The channel controllers (cluster head) regularly scan the signal level and select the channel with the lower value. However, the detection of the interference is limited to the local nodes.

In [83] is proposed a centralized hybrid Code Division Multiple Access (CDMA) and TDMA scheme based on learning automata. TDMA is used in intra-cluster communication, and the TDMA slot is proportional to the traffic load. CDMA is used in inter-cluster communication. The scheme does not consider the node mobility in the channel allocation process.

In [84] is proposed a distributed load-aware channel hopping protocol for mobile ad hoc networks. In the work, the nodes dynamically adjust their channel schedules based on their traffic load. To perform a transmission is chosen a channel hopping sequence. The protocol does not consider the node mobility in the channel allocation process.

In [85] is proposed a load balancing and a centralized channel assignment mechanism for cluster-based MANET in heterogeneous networks. The cluster head evaluates the occupation

in all channels and selects the one with less occupation, but it does not consider the node mobility in the channel allocation process.

#### 2.2.1.1 Comparison among related work in ad hoc network

Table 4 shows the comparison among related work in ad hoc networks and our channel allocation mechanism, named Mobility-aware Channel Allocation (MobiCA).

The table has the following attributes:

- Reference: identification of the related work.
- Criteria: corresponds to the criteria for channel allocation.
- Approach: represents the type of approach (centralized or distributed, with or without common control channel).
- Technique: is the technique used to solve the channel allocation problem. Some techniques are elementary, for example, consider the highest SINR or the lowest power and other more complex as Learning Automat.
- Parameters: are the attributes used to guide the channel allocation process.

In Table 4, the interference among links represents the interference among communication links inside a cluster. The interference among nodes represents the interference among cluster heads. This is due to each node in the graph to represent a cluster head.

Many works in the literature, such as [76], [77], [8], [81], [82], and [85], use physical parameters (e.g., signal power level) as criteria for channel allocation and the technique more used is to select the channel with lower power level.

The limitation of measuring physical parameters locally and using them as a decision criterion for channel allocation is to restrict the detection of interference at 1-hop. Thus, the node remains susceptible to interference at 2 hops (as seen in subsection 2.1.1.1).

According to Table 4, most authors use a centralized approach in a cluster head. In this way, all decision of the channel allocation in the cluster depends on a centralized controller. Some works ([74], [77], [80], and [84]) present a distributed channel allocation, in a manner that, the channel allocation decision is taken by nodes independently.

Table 4: Comparison among related work in ad hoc networks

Reference	Criteria	Approach	Technique	Parameters
[74]	interference among links	distributed/ CCC	lower interference	
[75]	interference among nodes	centralized/ ND	optimization by ant colony	popularity
[76]	power level	centralized/ NCCC	lower power level	
[77]	power level	distributed/ CCC	classes of power	mobility
[78]	coordination based on traffic	centralized/ NCCC	learning automat	traffic
[79]	available time slot	centralized/ NCCC	TDMA	
[80]	interference among links	distributed/ CCC	RANDOM/ contention	
[8]	power level	centralized/ NCCC	lower power level	traffic
[81]	power level	centralized	lower power level	
[82]	power level	centralized/ ND	lower power level	
[83]	available time slot	centralized/ CCC	learning automat, TDMA	traffic
[84]	channel hopping sequence	distributed/ NCCC	transmission scheduling	traffic
[85]	power level	centralized/ ND	lower power level	
MobiCA	interference among links	distributed/ CCC	graph with lower interference	mobility, traffic, popularity

Some works, such as [79] and [83], use a channel allocation mechanism based on TDMA where the criterion is to select a available time slot.

Some authors, such as [78], [8], [83], and [84] use the traffic information to guide the channel allocation process. This allows prioritizing the channel allocation in links with higher activity, by selecting a less interfering channel, decreasing the contention in those links.

Few references in ad hoc networks use the mobility ([77]) or node popularity ([75]) to guide the channel allocation process.

Finally, Table 4 shows that parameters of mobility, traffic, and node popularity of the previous works are considered separately in the channel allocation process. In our work (MobiCA), we adopt a distributed approach, limiting the exchange of control messages at 2 hops and we use the parameters of mobility, traffic, and node popularity simultaneously to guide the channel allocation process.

### 2.2.2 Related Work in VANET network

VANET is a vehicular network which has an architecture consisting of three components [86], [87]: RSU, On Board Unit (OBU), and Application Unit (AU).

RSU is a device fixed along the road side or in dedicated locations equipped with one network device based on IEEE 802.11p standard or other network devices for communication within the network infrastructure. RSU allows extending the communication range by distributing the information to other vehicles and by sending the information to other RSU. It acts as an information source allowing notify vehicles about accidents, work zone, congestion, road problems, etc. In addition, RSU allows vehicles to have access to the Internet.

OBU is a device mounted on-board in a vehicle, used to exchange information with RSUs or other OBUs.

AU is the device within the vehicle that runs the applications and uses the communication capabilities of the OBU. AU can be connected to the OBU through a wireless or wired connection and may reside with the OBU in the same box.

In the literature, several authors propose channel allocation for vehicular networks.

In [88], the authors propose a centralized channel access scheme for vehicular ad hoc networks, considering the time (deadline) that the vehicles are going to leave the RSU range. The scheme

prioritizes the mobility and emergency services in the channel allocation process, but it does not consider the network traffic.

In [89], the authors present a channel allocation mechanism that selects the channels with lower usage, and it does not consider the mobility and traffic in the channel allocation process.

In [90], the authors present a cognitive scheme for dynamic channel allocation in the adjacent band of Dedicated Short-Range Communication (DSRC). The scheme only uses the channel occupation as a criterion of channel allocation.

In [91] is presented a channel allocation mechanism for VANETS using TDMA. The scheme is cluster-based where the cluster members request a time slot to the cluster head. In this mechanism, the vehicles do not have priority, and the channels are allocated according to the request of the time slot.

In [36] is proposed a channel allocation mechanism for cognitive VANET that represents the links between vehicles in a conflict graph and formulates the channel allocation problem as a Mixed-Integer Linear Programming (MILP) problem. The mechanism does not consider others parameters as traffic and mobility in the channel allocation.

In [92], the authors present a cluster-based multi-channel scheme using IEEE 802.11p. In communication intra-cluster is used a non-competition scheme based on TDMA that select a available time slot to the OBU .

In [93], the authors propose a Distributed Channel Assignment Scheme (DCAS) using IEEE 802.11p standard considering a highway scenario. DCAS is based on TDMA and to avoid interference among links are selected different time slots for links at 2 hops and the channel allocation priority is only for emergency messages.

In [94], the authors present a Dynamic Service Channel Allocation (DSCA) mechanism for vehicular network. The objective is to assign a Service Channel (SCH) for each vehicle using access categories to improve the network throughput. The mechanism uses the historical of service announcement messages sent by vehicles and selects the highest capacity channel but, it does not prioritize the node that will use the channel.

In [95], the authors propose a channel allocation scheme based on node position for VANETS. In the scheme, each cluster selects a node as a coordinator, responsible for TDMA slots assignment inside the cluster, in a manner that, vehicles at starting position can get more bandwidth when compared to the end position (near the edge of the cluster). Although the scheme uses the



node mobility, it does not consider the traffic as a criterion of channel allocation.

In [96] is proposed an *RSU* centric channel allocation protocol to minimize channel allocation time and overhead. The *RSU* divides the region into clusters, and the channel in each cluster is divided into time slots. A time slot is allotted to a vehicle considering only the priority of the service type and availability of the channel.

In [97], the author presents an adaptive multi-channel allocation mechanism that selects opportunistically a service channel among all six service channels of the IEEE 802.11p standard. The channel selection is only based on the channel occupation, and it does not consider others parameters and the node priority.

In [19], the authors present a mobility-aware *OBU* protocol, where the changing of the channel due spatial mobility occurs when the node joins or leave the network. In the work, other parameters as traffic or node priority are not considered.

#### 2.2.2.1 Comparison among related work in VANET network

Table 5 shows the comparison among the related work in *VANETs* and our channel allocation mechanism (*MobiCA*).

In Table 5, we can observe that:

- In the literature, most of the work use an approach centralized in the *RSU*, and they do not use a common control channel. In this last case, the authors use part of Control Channel (*CCH*) time to notify the neighbors about the channel to use.
- Most of the techniques consist of selecting a channel with the lower occupation or using a *TDMA* scheme.
- In *VANETs*, some works consider only the mobility parameter for channel allocation, and sometimes only at the edge of the network. They do not consider other parameters as traffic or popularity, to guide the channel allocation process.

Our work differs from previous ones because we do not use a *TDMA*-based channel allocation scheme. In some previous work ([91], [88], [93], [95], [96]), using a single network interface requires time synchronization mechanisms (e.g., based on *TDMA*) for use of the interface as control or data interface. This increases the complexity and requires hardware modification. In

Table 5: Comparison among related work in VANETs networks

Reference	Criteria	Approach	Technique	Parameters
[88]	shorter time deadline	centralized/ NCCC	classes of priority	mobility
[89]	channel occupation	distributed/ NCCC	lower channel occupation	
[90]	channel occupation	distributed/ ND	lower channel occupation	
[91]	available time slot	centralized/ NCCC	TDMA	
[36]	interference among links	centralized/ CCC	MILP	
[92]	available time slot	centralized/ NCCC	TDMA	
[93]	interference among links	distributed/ NCCC	TDMA	
[94]	channel capacity	centralized/ ND	higher channel capacity	
[95]	position	centralized/ NCCC	TDMA	mobility
[96]	available time slot	centralized/ NCCC	classes of priority	
[97]	channel occupation	distributed/ ND	lower channel occupation	
[19]	channel occupation	centralized/ CCC	lower channel occupation	mobility
MobiCA	interference among links	distributed/ CCC	graph with lower interference	mobility, traffic, popularity

our approach, we use two network interfaces, one for control operations and other to transmit/receive data, not requiring time synchronization mechanisms and hardware modifications. In addition, we consider the profile of mobility, traffic history, and node popularity to allocate the channel, and not only the power level, the number of users, or messages on the channel.

### 2.3 CONCLUSION

In this chapter, we presented some criteria, approaches, and techniques used to solve the channel allocation problem in wireless networks. Many of the criteria presented in the literature are used in isolation, they are subject to the hidden terminal problem and only change the channel when a node joins or leaves the network.

In scenarios where the topology and density of the network are constantly changing, a distributed approach is more recommended because it allows channel allocation to be made quickly, adaptively, although not always optimally.

In addition, the use of the same channel for the exchange of control and data messages presents a greater complexity of implementation due to the necessity of clock synchronization mechanisms.

The literature presents several techniques used to solve the channel allocation problem. As channel allocation is described as a hard NP problem, the linear programming technique is often simplified for a BLP, which requires that several assumptions be made to be solved in polynomial time.

For scenarios where the exhaustive search is impractical, heuristic methods are used to find a solution near to the optimal, quickly.

Evolutionary Algorithms search for solutions by performing the evaluation of populations based on natural evolution. Its main disadvantage is the time to find an optimal solution with the risk of finding a minimal local solution.

Another widely used technique for channel allocation is based on graph coloring technique, where two adjacent nodes receive a different channel.

One variation of the graph-based technique is the use of conflict graphs. This technique allows capturing the interference among competing transmissions that are in the same interference range. We use a technique based on communication graph considering the interference at 2 hops. We use this technique be-

cause we do not need to use physical parameters such as (SNR) or (SINR) and is possible to estimate the interference among links at 2 hops, avoiding the hidden terminal problem.

We also discussed some interference models that are used in the channel allocation process. Many of these models use physical parameters of the network such as received power, signal-to-noise ratio, and bit error rate. In addition, they only allow estimating the interference generated by neighboring nodes at 1-hop, while in our work we use a model that allows estimation of interference at 2 hops.

We have seen that mobility models represent the behavior of the node movement in function of different temporal, spatial, and geographical conditions. The models can be extracted from traces dataset that store information about node mobility in real life situations.

We compared the works in the literature and observed that the criterion more used in channel allocation is the power level and channel occupation. Although some works consider others parameters for channel allocation, they use them in an isolated manner. In ad hoc networks the parameter more used is the traffic, while in VANET is the mobility. In our work, we use a distributed approach with a common channel, considering the mobility, traffic, and node popularity simultaneously, to guide the channel allocation process. In the next chapter, we present our channel allocation strategy for ad hoc network.

## CHANNEL ALLOCATION STRATEGY IN AD HOC NETWORKS

---

In this chapter, we address the channel allocation strategy in [MANET](#) using [WIFI](#) Direct. We present the formulation of the problem, the channel allocation mechanism, and the complexity analysis of the algorithm. We evaluate the performance of our strategy analyzing two scenarios: grid topology and using a human mobility model ([SLAW](#) mobility model).

### 3.1 FORMULATION OF THE PROBLEM

In this section, we present the channel, network, and interference models for the channel allocation problem statement.

#### 3.1.1 *Channel model*

We consider the IEEE 802.11b/g standard. The spectrum of this standard operates on the 2.4-GHz band and the available number of channels depend on the country operation. American and European countries are allowed to use 11 and 13 channels, respectively while in Japan 14 channels are used.

[Figure 9](#) shows an example of the IEEE 802.11b/g spectrum with 13 channels [\[98\]](#). The channels have a bandwidth of 22 MHz, but they are separated by a spectral distance of 5 MHz. This spectral distance shorter than the bandwidth results in a frequency overlapping among adjacent channels. For example, channels 1 and 2 have a high overlapping factor. Channels 1 and 5 have a low overlapping factor (as shown in grayscale in [Figure 9](#)). The interference due to the use of neighbor channels in the spectrum is known as adjacent channel interference. Channels without any overlap are considered to be orthogonal (e.g., channels 1 and 6 in [Figure 9](#)). Thus, the IEEE 802.11b/g operating in American and European countries provides only 3 non-interfering channels (i.e., channels 1, 6, and 11).

Authors in [\[56\]](#) show an experiment on the adjacent channel interference related to [SNR](#). This metric represents the signal level with respect to the noise (higher [SNR](#) values represent higher quality signals). In the experiment, a transmitting sta-

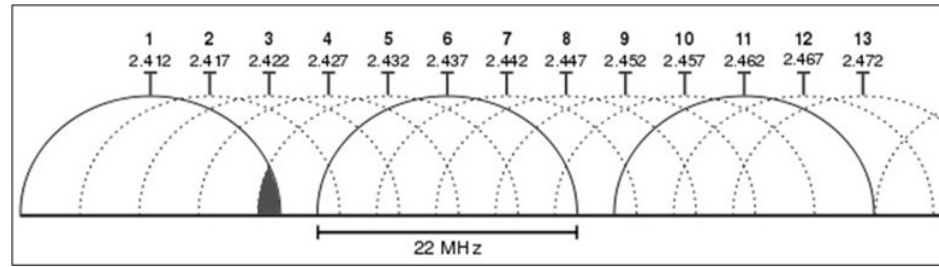

Figure 9: Channels overlapping in WIFI spectrum [98]

Table 6: Interference factor in 802.11b/g spectrum channel [56].

Channel	1	2	3	4	5	6	7	8	9	10	11
I-factor	0.0	0.22	0.6	0.72	0.77	1.0	0.96	0.77	0.66	0.39	0.0

tion is placed on channel 6, and a receiving station is moved from channel 1 through 11. The normalized values of SNR at the receiving station are measured and results are presented as an interference factor (I-Factor) in Table 6.

In Table 6, channel 1 has interference factor (I-Factor) of 0.0 with respect to channel 6. Channel 2 has an I-Factor of 0.22 relative to channel 6. As the channel number approaches to 6, the I-Factor increases. When a neighboring node uses channel 6, the I-Factor is maximum (1.0), resulting in a co-channel interference. The I-Factor is an important parameter to consider in the channel allocation process because it allows allocating channels with lower adjacent channel interference.

### 3.1.2 Network model

We consider a graph representation of an ad hoc network, where the devices are the nodes and the communication links are the edges in the graph. For each link is allocated a channel.

Each node in the network has two network interfaces: the control and the data interface.

The control interface uses a Common Control Channel (CCC) to insure the connectivity among nodes. We use a CCC due to its simplicity and to its lack of a synchronization need between nodes for the exchange of control messages. The control interface is responsible for the exchanges of information about nodes' available channels, mobility information (e.g., position

and velocity), routing messages, and channel switching request messages to a neighbor node.

Data interface sends and receives data packets and switches among channels according to the channel allocation strategy.

### 3.1.3 *Interference model*

In a wireless scenario, one of the key factors that limit network performance is the interference. If two or more links are in the same signal transmission range and use the same channel at the same time, the links will interfere with each other. The interference occurs because several simultaneous transmissions in the same channel result in collisions or contentions, reducing the network performance.

In this work, we consider an interference model at 2 hops [45], used to predict if a channel allocated to a link will interfere or not with its neighbors at 2 hops. In this model, two links are considered interfering if they are at 2 hops away from each other and use the same channel, as was shown in subsection 2.1.4.5. We consider the interference at 1 hop as contention and it is managed by the sending Request to Send (RTS)/ Clear to Send (CTS) control messages. The interference level is measured by using Eq. 3 and I-factor addressed in subsection 3.1.1.

### 3.1.4 *Problem Statement*

In our work, the channel allocation problem consists in selecting a channel for each link, so that it is different or less interfering than the channels used in the links at 2 hops.

For small networks that do not present variations of network topology or density, it is possible to use a centralized approach. In that case, a central node collects information of the network, allocates the channels that generate the lower interference among the links, and then notify the network nodes which channels they should use. However, in a scenario in which node mobility constantly changes the network topology and its density, a distributed approach is more appropriate. This approach considers local interference and avoids the collection of all network information, resulting in a smaller amount of exchanged messages.

In addition, node mobility opens the question of how to prioritize the channel allocation to nodes that will remain in the network in a future time window, preventing channels from be-

ing allocated to nodes that will no longer be connected to the network. More specifically to our work, we prioritize user behavior features regarding mobility, traffic, and popularity to the channel allocation problem discussed above.

Another problem is the hardware dependence. Many proposals in the literature such as [76], [78], [79], [83], and [84] require changes in the hardware and MAC layer to implement the channel allocation algorithm. Our proposal is independent of hardware modifications and it is compatible with IEEE standard. Thus, in the MAC layer can be used [WIFI](#) or IEEE 802.11p standard.

### 3.2 THE CHANNEL ALLOCATION MECHANISM

In this section, we present the channel allocation mechanism represented as a state machine. We detail the types of messages (named Hello and Interaction messages) exchanged among the nodes as well as the behavioral parameters and the algorithm used in the channel allocation mechanism.

[Figure 10](#) shows the channel allocation mechanism represented as a state machine, composed by 4 states: 1) Scheduler, 2) Topology Manager, 3) Allocation Mechanism, and 4) Interaction Mechanism.

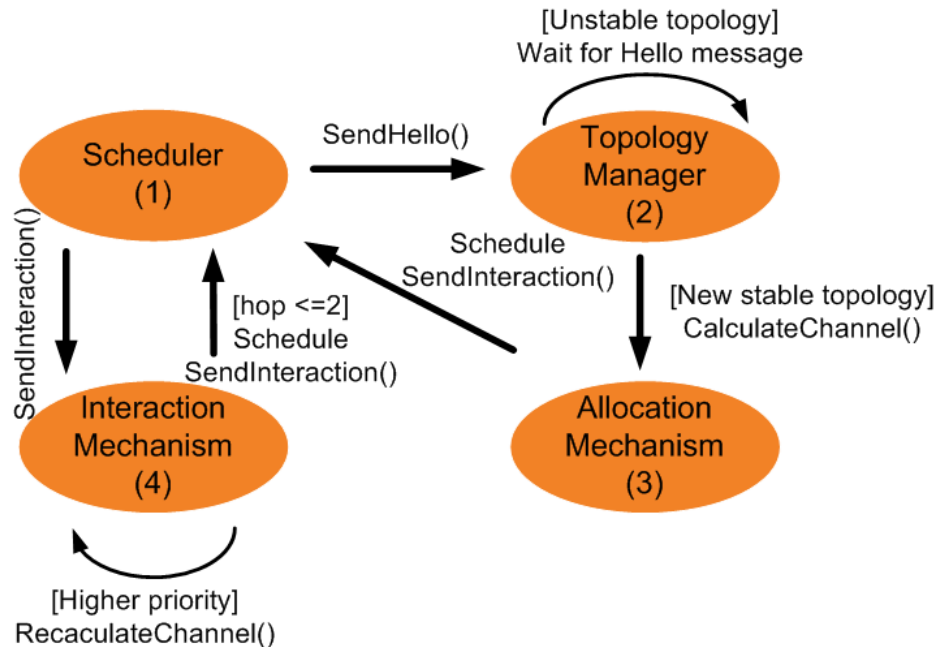

Figure 10: State machine.



### 3.2.1 State1 (Scheduler)

The Scheduler is responsible for sending Hello and Interaction messages.

Hello messages are sent periodically and allow a node to exchange information about available channels, mobility (position and velocity), popularity, and to notify its neighborhood that it is active.

Figure 11 shows the neighboring nodes of node A sending Hello messages.

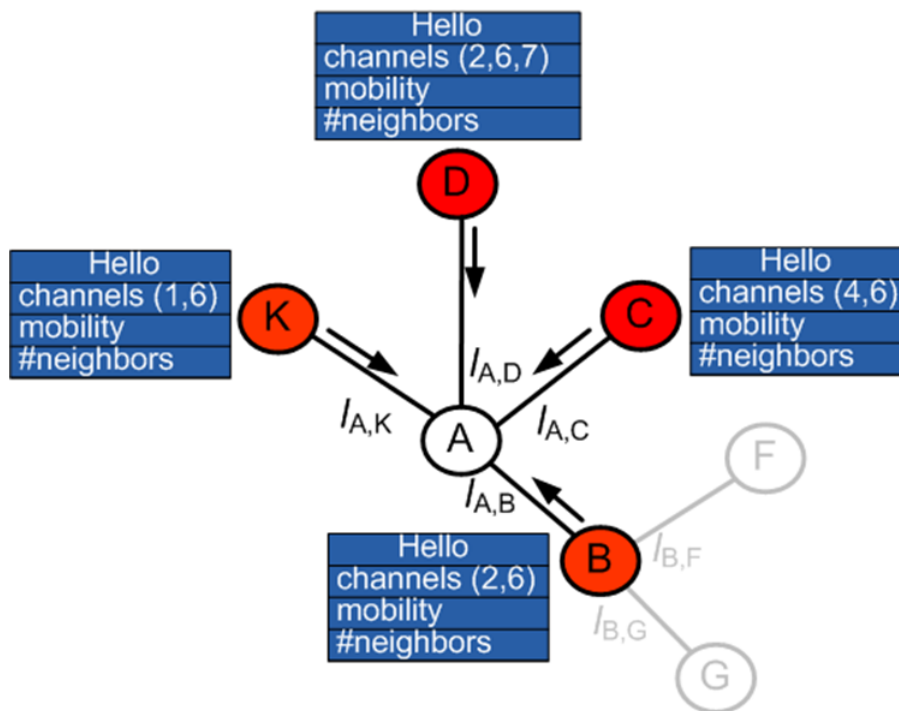

Figure 11: Sending Hello message.

In the Hello message, channels represent the available channels by a node.

Mobility information is used to calculate the future position of a node. This information is used as a parameter to guide the channel allocation process.

Neighbors correspond to the node popularity (number of neighbors of the node).

Figure 12 shows the structure of the Hello message.

The structure is composed by the following fields:

- *ChannelSize*: corresponds to the size (in bits) of the channel fields (*ChannelNumber*).

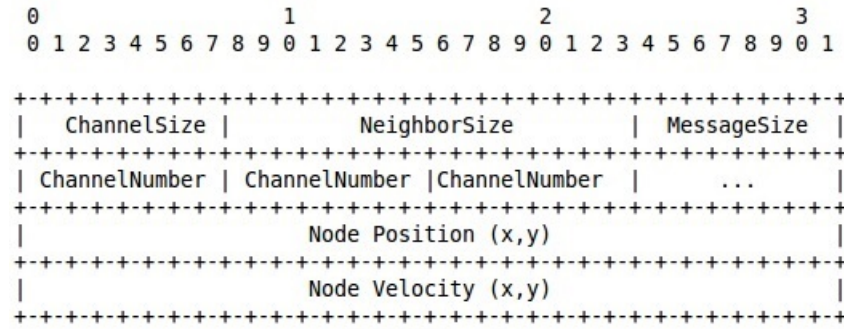

Figure 12: Hello message.

- *NeighborSize*: is the number of neighboring nodes.
- *MessageSize*: is the size of the Hello message (in bytes).
- *ChannelNumber*: is the number of each available channel to the node. The amount of *ChannelNumber* fields varies dynamically according to the number of available channels.
- *NodePosition*, *NodeVelocity*: represent the values (in Cartesian coordinates) of position and velocity, respectively.

In addition to Hello messages, the Scheduler sends Interaction messages. These messages are sent to neighboring nodes to notify the allocated channels by a node. A node that receives an Interaction message can accept or reject the channel allocation according to its priority as will be seen in the State 4 (Interaction Mechanism).

### 3.2.2 State2 (Topology Manager)

The topology manager is responsible for verifying the stability of the network topology and creating a list of channels that can be allocated to links of a node.

The stability of the topology is important for a node to detect all its neighbors. The topology is considered stable when it does not change after two consecutive exchanges of Hello messages among a node and its neighbors. If the topology is unstable, the node remains in State2, receiving the Hello messages, until the stability condition is found.

After obtaining the stability, the node extracts the channels of the Hello message and stores them in an available channel list.

The intersection between the available channels list and local channels list results in a common channels list. This last list contains the channels that are common to a node and its neighbors and are selected by the channel allocation algorithm.

### 3.2.3 State3 (Allocation Mechanism)

State3 is executed whenever a node obtains the common channels list after the network topology becomes stable. In this state, the channel allocation mechanism is executed based on the local knowledge of the node.

Figure 13 shows an example of a network graph in which a node A has four links ( $l_{A,B}$ ,  $l_{A,C}$ ,  $l_{A,D}$ , and  $l_{A,K}$ ).

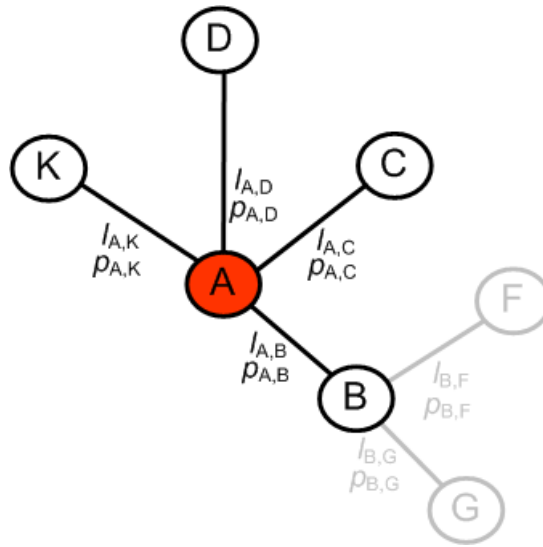

Figure 13: Example of network graph with link priority

The neighboring nodes of the node A (at 1-hop) have characteristics that represent user behavior such as mobility, traffic, and node popularity. These characteristics are associated to a link behavior function that is used to define the link priority. Thus, node A has a link priority function ( $p_{A,B}$ ,  $p_{A,C}$ ,  $p_{A,D}$ , and  $p_{A,K}$ ) for each link associated to a neighboring node.

#### 3.2.3.1 Behavioral parameters

This subsection presents the behavioral parameters represented by the mobility ( $M$ ), traffic ( $T$ ), and node popularity ( $D$ ).

The mobility parameter corresponds to an estimation of the Cartesian distance between a node and its neighbor node which

belongs to one of its links. This parameter is calculated using the mobility information obtained of the Hello messages and considering a future time window. Thus, it is possible to estimate if a neighbor node will be in the coverage radius or not at a future time and to prioritize the channel allocation.

The traffic parameter represents the throughput measured in the last time window in the buffer of a link. This parameter allows to detect the activities of the links. Active links generate interference in their neighbors at 2 hops if they use the same channel. Thus, it is possible to allocate less interfering channels to the links with higher activities and allocate a shared channel to the link at 2 hops with lower activities.

The popularity parameter is related to the number of nodes connected to a neighbor node. For example, in [Figure 13](#) the node A has a neighbor node B that belongs to link  $l_{A,B}$ . The amount of neighbors nodes of B (node degree of B) represents the node popularity of the node B. We consider this parameter because the nodes with higher degree values tend to attract and to be more active than other nodes. These nodes are located in regions where the node density and the competition by channels are higher. Also, nodes with the higher degree values can act as influential spreader that can propagate information to a large portion of the network, to ensure efficient information diffusion [99].

The association of the mobility, traffic, and node popularity parameters, results in a link behavior function. The terms used in the equations of this section are shown in the [Table 7](#).

For a link consisting of a node A and a neighbor node K ( $l_{A,K}$ ), the behavior function is given by:

$$b_{A,K}(t+\Delta) = \alpha * (1 - M_{A,K}(t+\Delta)) + \beta * T_{A,K}(t) + \gamma * D_K(t) \quad (4)$$

$$\text{s.t.} \quad \left\{ \begin{array}{l} 0 \leq \alpha \leq 1, \\ 0 \leq \beta \leq 1, \\ 0 \leq \gamma \leq 1, \\ \alpha + \beta + \gamma = 1. \end{array} \right.$$

where:

$t$  is the current time and  $\Delta$  is a future time window;

$\alpha$ ,  $\beta$ ,  $\gamma$  are weights applied to each behavioral parameters and depend on the network scenario;

$M_{A,K}(t+\Delta)$  is the normalized parameter that represents the estimation of the distance between the node A and the neighbor node K, at time  $t+\Delta$ ;

Table 7: Terms used in the equations

Terms	Meaning
$t$	current time
$\Delta$	future time window
$p_{A,K}(t+\Delta)$	priority function of link $l_{A,K}$ at time $(t+\Delta)$
$d_{A,K}(t+\Delta)$	distance between nodes A and K at time $(t+\Delta)$
$r_m$	maximum transmission radius
$b_{A,K}(t+\Delta)$	behavior function of the link $l_{A,K}$ at time $(t+\Delta)$
$M_K(t+\Delta)$	mobility parameter of the link $l_{A,K}$ at time $(t+\Delta)$
$T_K(t)$	traffic parameter of the link $l_{A,K}$ at time $t$
$D_K(t)$	node degree parameter of the node K at time $t$
$\alpha, \beta, \gamma$	weights applied to each behavioral parameter
$\Delta x(t+\Delta)$	difference of position in the coordinate x between local and neighbor node at time $(t+\Delta)$
$\Delta y(t+\Delta)$	difference of position in the coordinate y between local and neighbor node at time $(t+\Delta)$
$x_A(t+\Delta)$	position in the coordinate x of the node A at time $(t+\Delta)$
$x_K(t+\Delta)$	position in the coordinate x of the node K at time $(t+\Delta)$
$y_A(t+\Delta)$	position in the coordinate y of the node A at time $(t+\Delta)$
$y_K(t+\Delta)$	position in the coordinate y of the node K at time $(t+\Delta)$
$x_{oA}(t)$	initial position in the coordinate x of the node A at time $t$
$y_{oA}(t)$	initial position in the coordinate y of the node A at time $t$
$x_{oK}(t)$	initial position in the coordinate x of the node K at time $t$
$y_{oK}(t)$	initial position in the coordinate y of the node K at time $t$
$v_{xA}(t)$	velocity of the node A in the coordinate x at time $t$
$v_{yA}(t)$	velocity of the node A in the coordinate y at time $t$
$v_{xK}(t)$	velocity of the node K in the coordinate x at time $t$
$v_{yK}(t)$	velocity of the node K in the coordinate y at time $t$
$U_{A,K}(t)$	throughput of the link $l_{A,K}$ at time $t$
$W_{A,K}$	bandwidth of the link $l_{A,K}$
$g_K(t)$	number of neighbors of the node K at time $t$
$P_A(t+\Delta)$	priority of node A at time $(t+\Delta)$
$n$	number of links associated to a node

$T_{A,K}(t)$  is the normalized parameter that represents the traffic in the link  $l_{A,K}$ , at time  $t$ .

$D_K(t)$  is the parameter that represents the popularity of the node  $K$ , at time  $t$ .

In Eq. 4, the value of the behavior function increases with the decrease of the mobility parameter and the increase of traffic and node degree (popularity) parameters.

In the following, we detail the parameters of mobility, traffic, and popularity.

- Mobility Parameter

The normalized mobility parameter at time  $t + \Delta$  will be given by:

$$M_{A,K}(t + \Delta) = |d_{A,K}(t + \Delta)|/r_m \quad \text{s.t.} \quad r_m > 0 \quad (5)$$

where:

$d_{A,K}(t + \Delta)$  is the estimated distance between the node  $A$  and node  $K$ , considering the nodes positions at time  $t + \Delta$ ;

$r_m$  is the maximum transmission radius.

The distance  $d_{A,K}(t + \Delta)$  is given by:

$$d_{A,K}(t + \Delta) = \sqrt{(\Delta x(t + \Delta)_{A,K})^2 + (\Delta y(t + \Delta)_{A,K})^2} \quad (6)$$

The terms  $\Delta x(t + \Delta)_{A,K}$  and  $\Delta y(t + \Delta)_{A,K}$  represent the differences of Cartesian coordinates  $x$  and  $y$  between the local node position  $(x_A(t+\Delta), y_A(t+\Delta))$  and the position of its neighbor  $(x_K(t+\Delta), y_K(t+\Delta))$  at time  $t + \Delta$ , as the following:

$$\Delta x(t + \Delta)_{A,K} = x_A(t + \Delta) - x_K(t + \Delta) \quad (7)$$

$$\Delta y(t + \Delta)_{A,K} = y_A(t + \Delta) - y_K(t + \Delta) \quad (8)$$

The nodes coordinates change according to the speed, displacement direction, and time. At time  $t + \Delta$ , it will be given by:

$$x_A(t + \Delta) = x_{oA}(t) \pm v_{xA}(t) * \Delta \quad (9)$$

$$y_A(t + \Delta) = y_{oA}(t) \pm v_{yA}(t) * \Delta \quad (10)$$

$$x_K(t + \Delta) = x_{oK}(t) \pm v_{xK}(t) * \Delta \tag{11}$$

$$y_K(t + \Delta) = y_{oK}(t) \pm v_{yK}(t) * \Delta \tag{12}$$

where:

$x_{oA}(t), y_{oA}(t)$  and  $x_{oK}(t), y_{oK}(t)$  are the initial positions coordinates of the local node A and neighbor node K, respectively, at time  $t$ ;

$v_{xA}(t), v_{yA}(t)$  and  $v_{xK}(t), v_{yK}(t)$  are the velocity components (in terms of coordinates x and y) of the local node A and neighbor node K, respectively, at time  $t$ ;

$\Delta$  is the node displacement time.

The signal  $\pm$  represents the displacement direction and it is determined by the angle of the velocity vector given by:

$$\theta[\text{degree}] = \arctan(v_y/v_x) * 180/\text{PI} \tag{13}$$

where:

$v_y$  and  $v_x$  are the components of the velocity vector in the axis y and x, respectively.

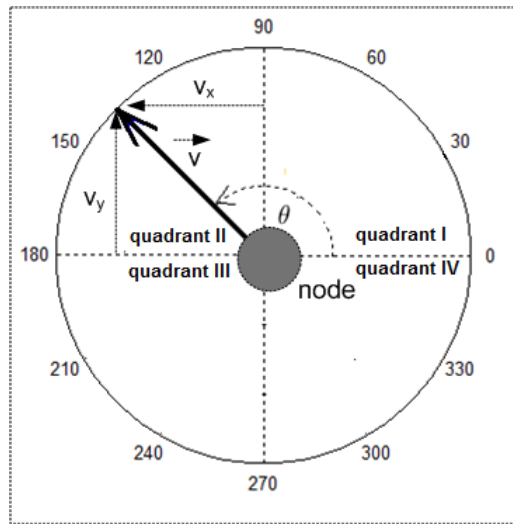

Figure 14: Example of velocity vector

Figure 14 shows an example of the velocity vector and the displacement angle  $\theta$ . The angle  $\theta$  allows getting the direction of the velocity vector. In this case, the velocity vector is in the

second quadrant. If the node in question is the local node, then the operation signal in coordinate  $x$  in Eq. 9 will be negative, and the operation signal in coordinate  $y$  in Eq. 10 will be positive.

The velocity vector information can be obtained using a magnetic sensor as discussed in [100] or after calculating the slope between two consecutive positions obtained from a GPS device as presented in [101]. In our work, we obtain the velocity vector information of the mobility model used in the simulation scenarios.

- Traffic Parameter

The normalized traffic parameter between the node  $A$  and neighbor node  $K$  (link  $l_{A,K}$ ) is given by:

$$T_{A,K}(t) = U_{A,K}(t)/W_{A,K} \quad \text{s.t.} \quad U_{A,K}(t) \leq W_{A,K} \quad (14)$$

where:

$U_{A,K}(t)$  is the throughput measured in the last time window in the buffer of the link  $l_{A,K}$ , at time  $t$ ;

$W_{A,K}$  is the bandwidth of the link  $l_{A,K}$ , considering the last time window. For example, the bandwidth for the IEEE 802.11g standard is 54 Mbps for a time window of 1 second.

- Node Popularity Parameter

The node popularity parameter represents the social feature that a node tends to move toward the most densely populated regions [5]. Thus, links located in dense regions have priority in channel allocation when compared to less dense regions. In our algorithm, the node popularity parameter is associated with the node degree. Higher node degree values increase the value of the node popularity parameter.

The node popularity parameter is calculated by:

$$D_K(t) = 1 - 1/g_K(t) \quad \text{s.t.} \quad g_K(t) > 0 \quad (15)$$

where:

$g_K(t)$  is the degree of the node  $K$ .

### 3.2.3.2 Link priority

After calculating the behavior function ( $b_{A,K}(t+\Delta)$ ), the node calculates the link priority function. This function is used to determine which links have priority in the channel allocation. The



link priority function for a node A with a neighbor node K is given by:

$$p_{A,K}(t + \Delta) = \begin{cases} 0 & , \text{ if } |d_{A,K}(t + \Delta)| > r_m, \\ b_{A,K}(t + \Delta), & \text{ if } |d_{A,K}(t + \Delta)| \leq r_m \end{cases} \quad (16)$$

where:

$t$  is the current time and  $\Delta$  is the future time window;

$r_m$  is the maximum node transmission radius;

$d_{A,K}(t+\Delta)$  is the foreseen distance, at time  $t+\Delta$ , between the local node A and the neighbor node K which belongs to the link  $l_{A,K}$ ;

$b_{A,K}(t+\Delta)$  is the behavior function of the link  $l_{A,K}$ , at time  $t+\Delta$ , given by Eq. 4.

In Eq. 16,  $p_{A,K}(t+\Delta)$  is calculated at time  $t$ , but it is a function of  $t+\Delta$  because the priority depends on the foreseen distance between two nodes at time  $t+\Delta$ .

When the distance between the nodes will be larger than their maximum transmission radius, the link priority function receives zero priority. Otherwise, the value of the link priority function will depend of the behavior function.

After calculating the priority of all links of a node, they are inversely sorted according to their priority.

Figure 15 shows an example where the link priorities of the links  $l_{A,D}$ ,  $l_{A,C}$ ,  $l_{A,K}$  and  $l_{A,B}$  are 0.6, 0.5, 0.4, and 0.3, respectively.

After ordering the links, node A calculates the channel for each link.

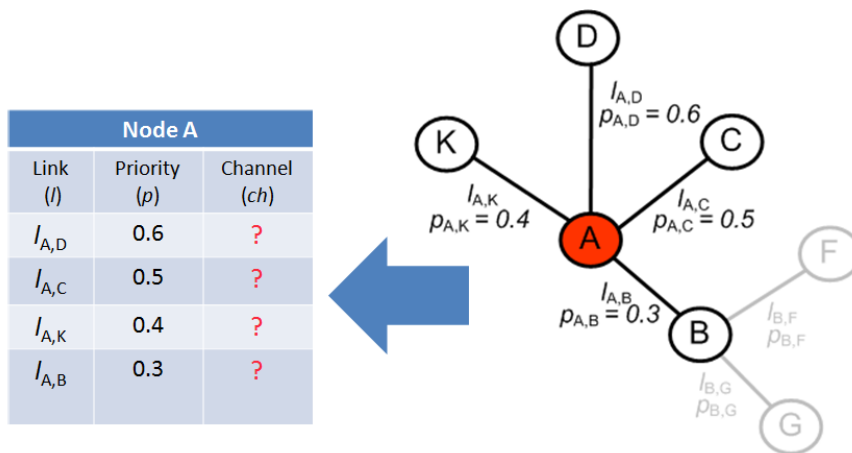

Figure 15: Ordering the links

The links with higher priority will receive the channels with higher quality, calculated according to Eq.3 (in Chapter 2), while considering the largest spectral distance (cf. Subsec. 3.1.1).

Figure 16 shows an example of allocated channels for each link according to their priorities.

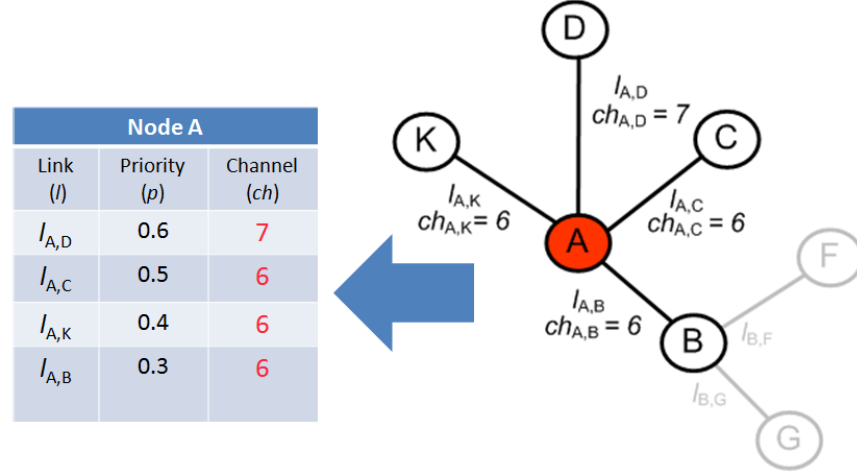

Figure 16: Allocated channels

### 3.2.3.3 Node priority

In addition to performing the channel allocation, a node calculates its priority. The node priority is used to assign a channel allocation acceptance order among neighbors. The node priority is represented by the average value of the links priorities. The node priority for a node A, considering its n links is calculated by:

$$P_A(t + \Delta) = \frac{\sum_{i=1}^n p_{A,i}(t + \Delta)}{n} \quad \text{s.t. } n > 0 \quad (17)$$

where:

$p_{A,i}(t + \Delta)$  is the priority of the link  $l_{A,i}$ , at time  $t + \Delta$ , given by Eq.16 .

The channel allocation for each link and the value of the node priority are sent to neighboring nodes by Interaction messages, as shown in Figure 17.

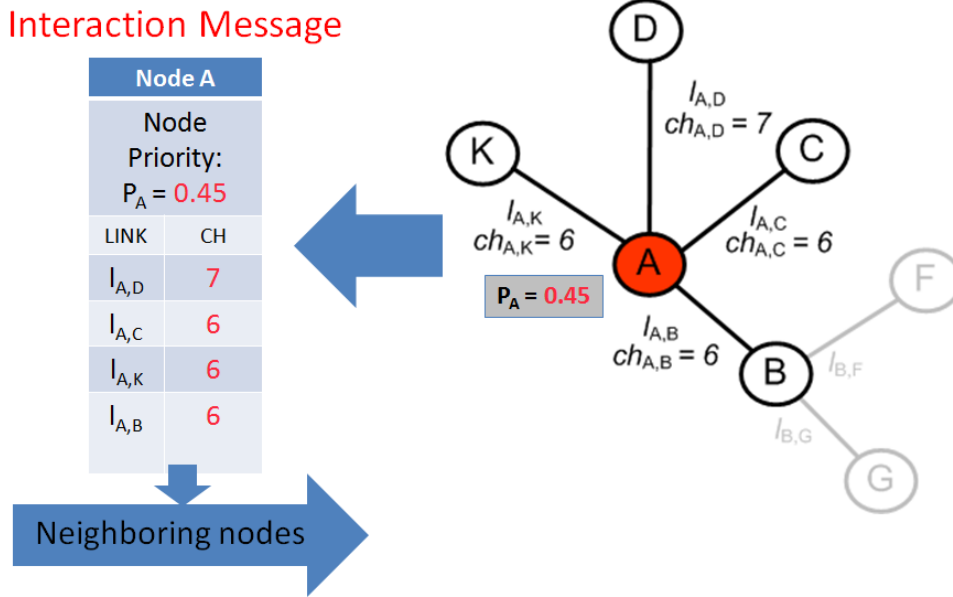

Figure 17: Interaction message

3.2.4 State4 (Interaction Mechanism)

When a node receives an Interaction message, it first compares the priority of the neighbor node with its local priority. If the received message priority is less than or equal to the local priority, the message is dropped. Otherwise, the node accepts the channel assignment proposed by the neighbor node to the link that received the message, sorts the links, and recalculates the channel allocation for its other links (searching for a channel not allocated with largest spectral distance or, in the case that all channels are allocated, searching for a channel with the smallest number of allocation occurrences). The channel allocation occurs in the sequence in that the links were sorted.

Figure 18 shows an example of a node B receiving an Interaction message from the node A.

The Interaction message contains the value of the priority of the node A ( $P_A=0.45$ ) and the channels proposed to each link of the node A. In the example, node A proposed the channel 6 for the links  $I_{A,B}$ ,  $I_{A,C}$ , and  $I_{A,K}$  and the channel 7 for the link  $I_{A,D}$ .

Node B proposed the channel 2 for the link  $I_{B,A}$ , and the channel 6 for the links  $I_{B,F}$  and  $I_{B,G}$ .

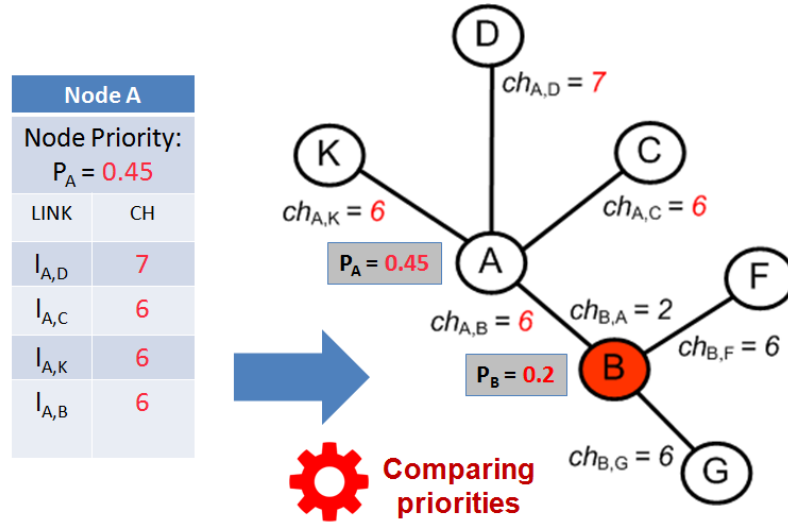

Figure 18: Node receiving an Interaction message

Upon receiving the Interaction message, node B compares its priority ( $P_B=0.2$ ) with the priority of the node A ( $P_A=0.45$ ). As the priority of the node A is greater, node B sorts the links according to the link priority ( $p_{B,A}$ ,  $p_{B,G}$ , and  $p_{B,F}$ ), it accepts the channel allocation proposal to the link  $l_{A,B}$  and it recalculates the channels for the links  $l_{B,G}$  and  $l_{B,F}$ .

Figure 19 shows the node B accepting the channel 6 proposed by the node A to link  $l_{A,B}$  and recalculating the channels for the links  $l_{B,G}$  and  $l_{B,F}$ . In this case, the node B selected the channel 11 for the links  $l_{B,G}$  and  $l_{B,F}$ .

Thus, the links of node B ( $l_{B,G}$ ,  $l_{B,F}$ ) do not interfere with the links at 2 hops ( $l_{A,C}$ ,  $l_{A,D}$ , and  $l_{A,K}$ ). The link  $l_{A,B}$  can use the same channel of  $l_{A,C}$ ,  $l_{A,D}$ , and  $l_{A,K}$  because it is a link at 1-hop.

The Interaction message processing is performed by the Algorithm 1 which starts after sorting all links.

The algorithm has the following lists as input:

- 1) *InterferingLinkList*: list of interfering links ( $l_{A,C}$ ,  $l_{A,D}$ , and  $l_{A,K}$ ) at 2 hops;
- 2) *InterferingChannelList*: list of interfering channels ( $ch_{A,C}$ ,  $ch_{A,D}$ , and  $ch_{A,K}$ ) associated to the links of *InterferingLinkList* list;
- 3) *LinkList*: list of links ( $l_{A,B}$ ,  $l_{B,F}$ , and  $l_{B,G}$ ) of the local node;
- 4) C: list that contains the channels that will be allocated to links of *LinkList* list.

The algorithm returns as output:

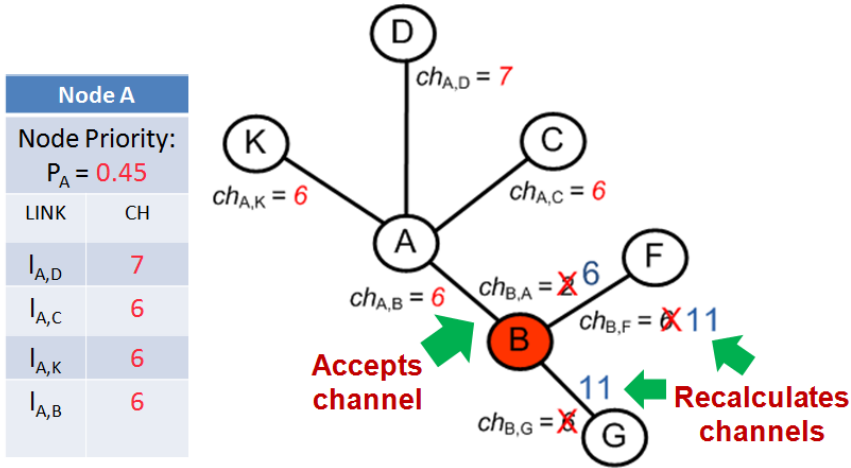

Figure 19: Node B recalculating channels

1) *AssignedLinkList*: list of the links of the local node ( $l_{A,B}$ ,  $l_{B,F}$ , and  $l_{B,G}$ );

2) *AssignedChannelList*: list of channels assigned ( $ch_{A,B}$ ,  $ch_{B,F}$ , and  $ch_{B,G}$ ) to links of *AssignedLinkList*.

In the algorithm, for each sorted link  $i$  of  $L$  (line 1), if it is the link that received the Interaction message (line 3), it accepts the channel proposed by the neighbor node (line 4). Otherwise (line 5), if the channel of  $C$  is not interfering with *InterferingChannelList* (line 8), the algorithm selects the channel in  $C$  with largest spectral distance (line 9). If all channels in  $C$  are interfering (line 11), the algorithm selects the channel with the lowest number of occurrences in *InterferingChannelList* (line 12). The link and the channel are assigned to *AssignedLinkList* (line 18) and *AssignedChannelList* (line 19) lists, respectively.

The exchange of Interaction messages is limited to 2 hops.

### 3.3 COMPUTATIONAL COMPLEXITY ANALYSIS OF THE ALGORITHM

The most significant computational complexity of our algorithm is in the Interaction mechanism (State 4), where occurs the channel calculation. The other states require less processing power and will not be addressed in this analysis. The channel calculation process involves 3 nested repeat loops.

The first one corresponds to the number of links that will be allocated to a channel (represented by  $L$ ). The second corresponds to the number of channels (represented by  $C$ ) that

---

**Algorithm 1** Channel Allocation in Ad hoc network
 

---

**Input:** *InterferingLinkList, InterferingChannelList, C, LinkList*
**Output:** *AssignedLinkList, AssignedChannelList*

$L \leftarrow$  ordered links of *LinkList*  
 $InterferingLinkList \leftarrow$  interfering links at 2 hops  
 $InterferingChannelList \leftarrow$  interfering channels at 2 hops  
1: **for** each element  $i \in L$  **do**  
2:    $link \leftarrow$  element  $i$   
3:   **if**  $link$  is the link that received the Interaction message  
   **then**  
4:      $ch \leftarrow$  channel received by the Interaction message  
5:   **else**  
6:     **for** each element  $j \in C$  **do**  
7:       **for** each element  $k \in InterferingChannelList$  **do**  
8:         **if** element  $j$  in  $C$  is not in *InterferingChannelList*  
   **then**  
9:          $ch \leftarrow$  channel of  $C$  with largest spectral distance  
10:       **else**  
11:         **if** all elements in  $C$  are in *InterferingChannelList*  
   **then**  
12:          $ch \leftarrow$  interfering channel with the lowest number of occurrences in *InterferingChannelList*  
13:       **end if**  
14:       **end if**  
15:       **end for**  
16:     **end for**  
17:   **end if**  
18:    $AssignedLinkList \leftarrow link$   
19:    $AssignedChannelList \leftarrow ch$   
20: **end for**

---

will be compared with the interfering channels allocated to the links at 2 hops. The third loop corresponds to the number of interfering channels (represented by  $N$ ) at 2 hops.

The computational complexity for our algorithm is given by:

$$O(|LxCxN|) \quad (18)$$

where:

$L$  is the number of links that will be assigned to a channel.

$C$  is the number of common channels that can be allocated to a link and depends on the network scenario. For **WIFI** networks, the maximum value of  $C$  is 10 (American standard). For IEEE 802.11p networks, the maximum value of  $C$  is 6.

$N$  is the number of interfering channels at 2 hops.

Thus, the computational complexity of the algorithm grows with the number of neighbors, however, it is limited to 2 hops, being independent of the total number of nodes of the network. In this way, there are no problems of scalability from the point of view of complexity.

### 3.4 EVALUATION SCENARIOS

This section describes the simulation experiments we have conducted using NS-v3 simulator [102] in order to assess the performance of our approach. The goal of our evaluation is to show how the design of our distributed user behavior-aware channel allocation strategy enables flexibility in static environments and with varying network topologies due to mobility.

For the performance evaluation, we considered two network scenarios where the metrics and the simulation setup depends on each scenario considered.

The first corresponds to a grid topology where the nodes are initially static, and then we add mobility. In this scenario, the interference occurs among parallel links which can interfere completely with each other.

The second uses a human mobility model. In this case, the links disposition depends on the trajectories of the nodes determined by the mobility model.

#### 3.4.1 Scenario1: Grid topology

We initially simulated a static grid scenario where the destination nodes of the traffic are the neighboring nodes. We assume

Table 8: Configuration parameters for Grid topology.

PARAMETER	DESCRIPTION / VALUE
Number of vehicles	49
Area	600 m x 600 m
Transmission range	100 m
Number of flows	4
Velocity	0 / 1 m/s
Number of packets	1000
Packet size	1KBytes
Time	20 sec

that the routing tables are already known, and the performance we measure does not involve any path discovery overhead.

Then, we add mobility to the nodes to evaluate the coefficients of the link priority function since one of its parameters ( $\alpha$ ) depends on mobility (cf. Subsec. 3.2.3).

#### SIMULATION SETUP:

We simulate a network consisting of 49 nodes distributed in an area of 600 m<sup>2</sup> and having nodes with a transmission range of 100 m. The nodes are distributed in a grid topology with a distance of 100 m among nodes. We installed the traffic sources on the nodes at the left edge of the grid, and we defined the neighboring nodes at the right side as the traffic destination. Then, we generated 4 parallel flows simultaneously to activate the links, and we evaluated the performance due to interfering links when using the same channel.

Each flow transmits 1000 data packets and each packet has a size of 1 KBytes. The flows of traffic are generated at each 20 seconds. We ran 1000 simulations and showed results in terms of mean values and confidence intervals, at a 95% confidence level (which is less than 2% around the mean). The configuration parameters are shown in Table 8.

#### COMPARED APPROACHES:

We compared our proposal (MobiCA) with three other methods: centralized channel allocation (TABU) [45], randomly channel allocation (RANDOM), and Single Channel (SC) allocation.



In TABU, the channel allocation is realized by a central unity in a heuristic manner. TABU algorithm is considered to provide the upper performance limit.

In a RANDOM algorithm, each node usually selects a channel randomly and to establish a communication link is necessary that both nodes in the link use the same channel. Hence, an increase in the number of available channels decreases the number of connections due to the lower probability of having nodes selecting the same channel to communicate.

In our implementation of RANDOM algorithm, the transmitter is able to notify the receiver what channel will be used in the communication link, mitigating the above described disconnection issue.

In a single channel allocation (SC), the same channel is allocated to all links in the network and it is considered to provide the lowest performance limit.

#### PERFORMANCE METRICS:

To evaluate the efficiency of the approach, we use three metrics: (1) aggregated throughput, which is the sum of packets delivered to all destination nodes per unit of time, (2) packet delivery rate, which is the number of packets received in relation to the number of packets sent, and (3) end-to-end delay, which is the time interval that a packet takes to reach its destination.

#### SIMULATION RESULTS:

Figure 20a illustrates the aggregated throughput according to the number of channels.

We observe that the number of available channels impacts the performance of the TABU, MobiCA, and RANDOM methods due to the higher amount of links transmitting simultaneously without interference. MobiCA presents very close performance in terms of aggregated throughput when compared to the upper bound approach, TABU. For a number of channels lower or equal to 4, the difference in performance between the two strategies is of 4%, 2%, and 0.7%, respectively. When compared to RANDOM and SC, the observed gain is about 8%-10% when compared to RANDOM and 21.12%-29.8% when compared to SC. As expected the number of channels does not impact the performance of SC.

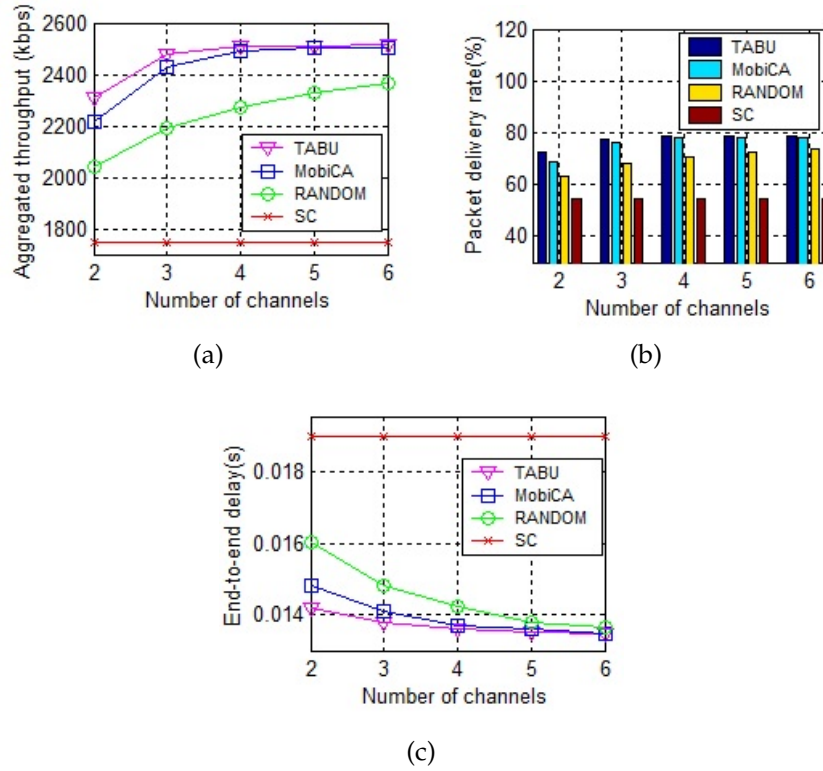

Figure 20: (a) Aggregated throughput, (b) packet delivery rate, and (c) end-to-end delay.

Figure 20b shows the packet delivery rate for each method according to the number of channels.

We observe that a higher amount of available channels increases the packet delivery rate because more packets are received due to the lower transmission delay and fewer errors due to collisions. MobiCA has a very close performance to TABU with a decrease of packet delivery rate from 3.69% to 0.66%. When compared to RANDOM the observed gain is about 5.61%-8.1%, and 14.62%-23.64%, when compared to SC.

Figure 20c shows the end-to-end delay for TABU, MobiCA, RANDOM, and SC algorithms.

MobiCA presents very close performance in terms of end-to-end delay when compared to TABU with an increase of end-to-end delay from 0.72% to 4.05%. When compared to RANDOM the decrease of end-to-end delay is about 7.67%-3.58%, and 25.15%-15.63%, when compared to SC. In the case of RANDOM, as the channel allocation is blind, the same channel can be used in neighbors links resulting in contention to transmission of the packets. As the number of channels increases the contention decreases (due to the higher channel diversity) and

the end-to-end delay become closer for all algorithms. When is used a single channel for all the links, the end-to-end delay is of 19 ms. In this case, the contention is maximum, resulting in the highest delay in the network.

#### ANALYSIS OF THE BEHAVIOR FUNCTION COEFFICIENTS

Initially, we add uniform linear motion (speed of 1 m/s) to the nodes because the coefficient  $\alpha$  is associated with the mobility parameter. The motion is added in a manner that the nodes remain within the coverage radius of the node transmitting the traffic.

We analyze the coefficients of the behavior function (Eq. 6) changing the values of the  $\alpha$ ,  $\beta$ , and  $\gamma$  coefficients that are associated with the values of mobility, traffic, and popularity parameters. The coefficients receive values of high ( $Hi$ ), medium ( $Md$ ), and low ( $Lo$ ),

$$\text{s.t.} \quad \begin{cases} Lo < Md < Hi, \\ Hi + Md + Lo = 1. \end{cases} \quad (19)$$

We vary and test (through simulations) the values of  $Hi$ ,  $Md$ ,  $Lo$  and consider only the values that lead to best results. The best results are found when  $Hi = 0.6$ ,  $Md = 0.3$ , and  $Lo = 0.1$ . Other values did not result in an increase of performance.

Figure 21a shows the aggregated throughput according to the number of channels. In the figure (due to space), we considered only the coefficient values that generated the 4 best results. The coefficients  $\alpha$ ,  $\beta$ , and  $\gamma$  with values of  $Md$ ,  $Lo$ , and  $Hi$ , respectively, presented the lowest aggregated throughput with average value (considering all the channels) of 2569,99 kbps. This occurs, due to the node degree parameter to receive the highest weight, while the traffic parameter receives the lowest weight. Thus, inactive nodes (without traffic) but with high node degree could have priority in the channel allocation process, decreasing the throughput. The highest average aggregated throughput is 2647 kbps and it is obtained with the values of the coefficients  $\alpha$ ,  $\beta$ , and  $\gamma$ , configured as  $Md$ ,  $Hi$ , and  $Lo$ , respectively. This is due to the traffic parameter to receive higher weight. Thus, links with higher traffic are allocated to the less interfering channel, increasing the throughput.

In Figure 21b, we changed the number of flows and measured the aggregated throughput, considering 2 channels. We

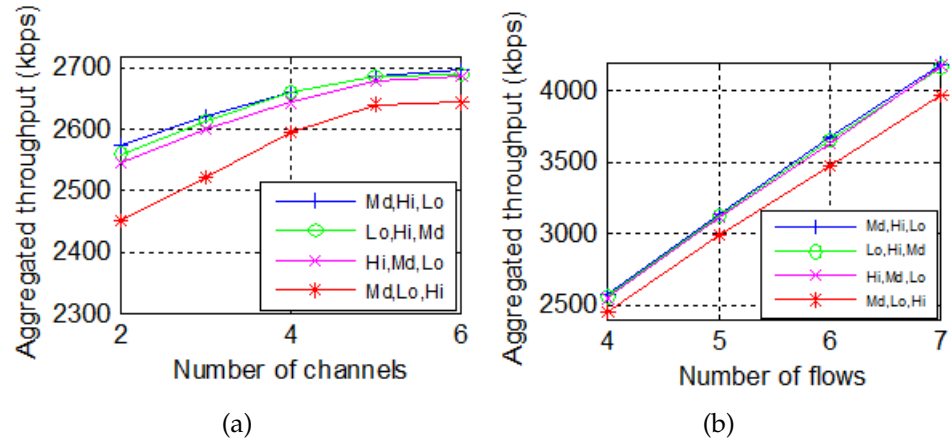

Figure 21: (a) Aggregated throughput x number of channels, (b) Aggregated throughput x number of flows.

considered 2 channels because the number of available channels is minimum (not considering a single channel) and the concurrency by channels is higher. In this case, the influence in the performance due to interfering links is higher. We increased the number of flows adding new traffic sources, in the next parallel link of the grid. Each traffic source generates the same amount of packets and with the same packet size of the others traffic sources. The results show a linear gain, according to the number of flows, due to the channel allocation algorithm to select a different channel for each parallel link. Thus, the interference among parallel links is minimal, increasing the aggregated throughput. Besides that, the average aggregated throughput is higher with the coefficients  $\alpha$ ,  $\beta$  and  $\gamma$  configured as  $Md$ ,  $Hi$ , and  $Lo$  due to the higher weight to be assigned to the coefficient of the traffic parameter.

Figure 22a shows the end-to-end delay as a function of number of flows.

We can observe that, as the number of flows increases, the end-to-end delay also increases. However, the end-to-end delay variation is low (order of 1 ms), considering the coefficients configured as  $Md$ ,  $Hi$ , and  $Lo$  and a number of flows from 4 to 7 flows. This is due to the higher weight assigned to the traffic parameter, prioritizing the channel allocation in the links with higher traffic.

The packet delivery rate is shown in Figure 22b as a function of number of flows. The increase in the number of flows, considering the coefficients configured as  $Md$ ,  $Hi$ , and  $Lo$ , maintains the packet delivery rate with values very close. This is be-

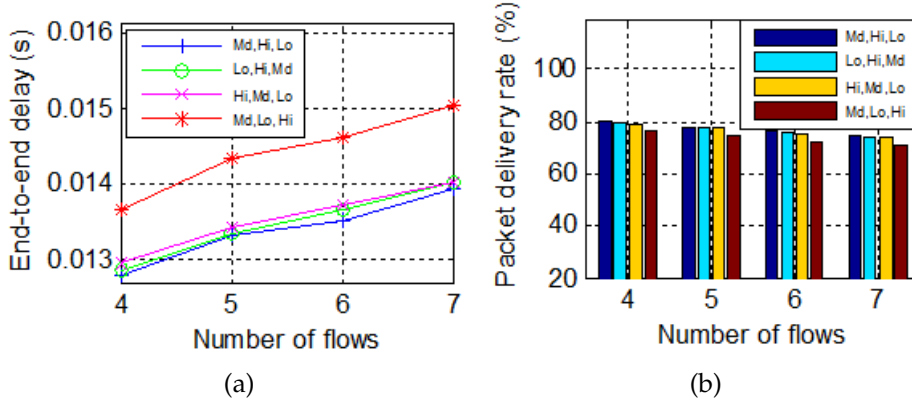

Figure 22: (a) End-to-end delay x number of flows, (b) Packet delivery rate x number of flows.

cause the neighboring flows are using different channels. The decrease of packet delivery rate for coefficients  $Md$ ,  $Hi$ , and  $Lo$ , considering 4 and 7 flows is about 1%.

In Figure 23, we show the aggregated throughput, packet delivery rate, and end-to-end delay as a function of mobility.

In Figure 23a, the aggregated throughput using the coefficients configured as  $Md$ ,  $Hi$ , and  $Lo$  presents again the highest value. The aggregated throughput remains approximately constant (average value of 2549.52 kbps) up to the value of velocity of 4 m/s, since the nodes remain within the coverage radius of the transmitting node, during the period of analysis. For velocity of 5 m/s the node leaves the coverage radius, decreasing the aggregate throughput rate (1851.68 kbps). Considering the node mobility, the configuration of the coefficients as  $Md$ ,  $Lo$ , and  $Hi$  presents the lowest aggregated throughput (average value of 2443.81 kbps).

Figure 23b presents the packet delivery rate as a function of the mobility. When the mobility is lower or equal to 4 m/s, the packet delivery rate presents values near (about 80%) for coefficients configured as  $Md$ ,  $Hi$ , and  $Lo$ . When the mobility is 5 m/s the packet delivery rate decreases for all values of the coefficients due to disconnection of the nodes.

In Figure 23c the configuration  $Md$ ,  $Lo$ , and  $Hi$  has the longest average delay (0.013705 ms) and the other settings have a lower delay with very close values. In addition, we can observe that above 4 m/s, the delay increases for all configurations of coefficients due to the node leaving the network coverage radius.

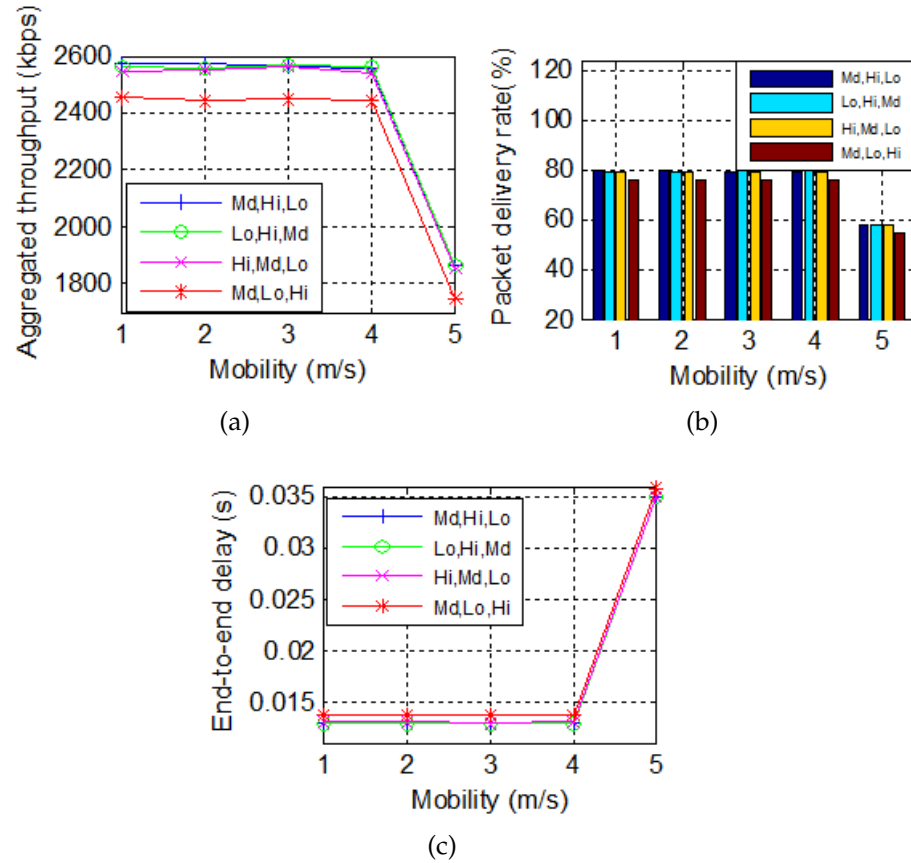

Figure 23: (a) Aggregated throughput x mobility, (b) Packet delivery rate x mobility, (c) end-to-end delay x mobility.

As seen in the Figure 21, Figure 22, and Figure 23 the best performances for the alpha, beta, and gamma coefficients are: *Md, Hi, and Lo*; *Lo, Hi, and Md*; and *Hi, Md, and Lo*.

This means that a good performance occurs when the traffic parameter has the highest weight, mobility has an average weight and popularity has the lowest weight.

Although the coefficient of the popularity parameter presents lower performance when configured with high values, it will still increase the value of the link priority function when the traffic is located in the regions with higher node concentration.

In the next section, we will evaluate our channel allocation strategy using the SLAW mobility model which considers some statistical properties of human mobility.

### 3.4.2 Scenario2: SLAW mobility model

In this scenario, we use a more realistic mobility model called Self-Similar Least-Action Human Walk (SLAW) [5]. This model

is based on real [GPS](#) traces collected from five outdoor sites (two campuses, a metro, Disney World, and a state fair scenario) in US. This model considers five fundamental statistical properties of human mobility: 1) straight line trips without directional change or pause have a truncated power-law distribution; 2) people mostly move only within their own confined areas of mobility and different people have different mobility areas; 3) times elapsed between two successive contacts of the same person can be modeled by a truncated power law distribution; 4) way-points of humans can be modeled by fractal points (people are more attracted to more popular places); 5) people more likely visit destinations nearer to their current waypoint when visiting multiple destinations in succession. In this model, every mobile node chooses a set of clusters and a fraction of waypoints to visit from each of the selected clusters. The node visits all of the selected waypoints, pausing in every waypoint. After traveling all the waypoints, the node randomly select another cluster and a new subset of waypoints, starting another trip.

#### SIMULATION SETUP:

The evaluation scenario corresponds to a simulated network consisting of 40 nodes distributed in an area of 800m x 1000m and having a transmission range of 100m. The nodes distribution and mobility information are obtained from the [SLAW](#) mobility model and the node velocity ranges from 0 to 1 m/s. The [SLAW](#) mobility model divides the area into clusters and in each cluster, sets the way nodes will move inside the cluster. [Figure 24a](#) and [Figure 24b](#) show the network topology in the instants of 20 s and 40 s, respectively, due to node mobility.

In order to investigate the interference among links after channel allocation is performed, we randomly selected 5 sources and destinations nodes in the most populated cluster. We then simultaneously generated traffic flows at each 20 s. Each flow transmits 1000 data packets and each packet has a size of 1 KBytes. We ran 1000 simulations and showed results in terms of mean values and confidence intervals, at a 95% confidence level (which is less than 2% around the mean).

[Table 9](#) shows the simulation parameters.

#### COMPARED APPROACHES:

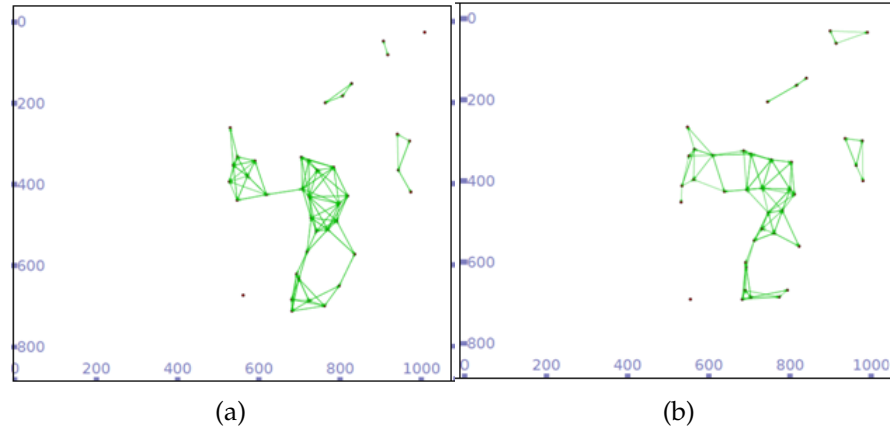

Figure 24: (a) Network topology in 20 s, (b) network topology in 40 s for SLAW mobility model.

Table 9: Scenario configuration parameters for SLAW mobility model.

Parameter	Description/Value
Number of nodes	40
Area	800m x 1000m
Mobility model	SLAW
Routing protocol	OLSR
Number of flows	5
Number of packets	1KB
Packet size	1KB
Node velocity	0 to 1m/s
Time	20sec

We compared our proposal (*MobiCA*), with three other methods: centralized channel allocation (*TABU*) [45], randomly channel allocation (*RANDOM*), and Largest Distance (*LD*) among channels [103].

In *LD* algorithm, the criterion for channel allocation is based only on the largest spectral distance among a candidate channel for the allocation and the channels allocated to the neighbors at 2 hops. In *LD*, candidate channels with largest spectral distance have higher priority in the channel allocation process.

#### PERFORMANCE METRICS:

To evaluate the efficiency of the approach, we use five metrics: (1) aggregated throughput, (2) overhead, which is the number of bytes transmitted in the control channel, (3) spectral dis-



tance, which is the average distance in the spectrum among an allocated channel and the others channels allocated in the 2 hops neighbors, (4) packet delivery rate, and (5) end-to-end delay.

#### SIMULATION RESULTS:

Figure 25a illustrates the aggregated throughput according to the number of channels.

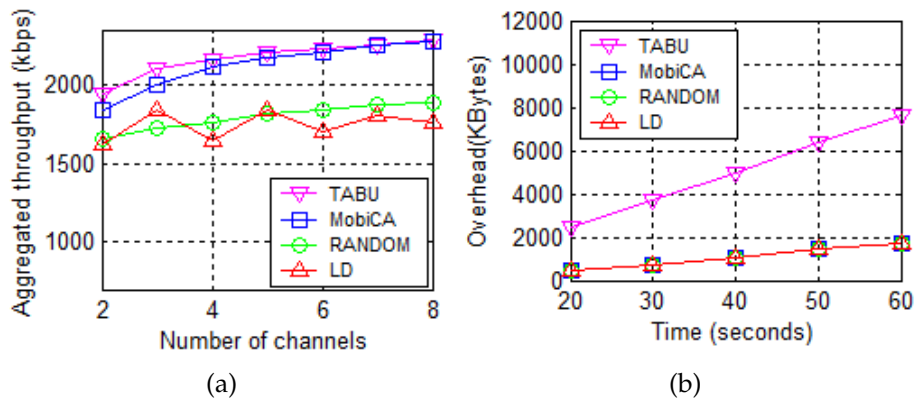

Figure 25: (a) Aggregated throughput x number of channels, (b) overhead x time.

MobiCA presents a slightly lower result than TABU for a lower number of channels while its performance is equivalent than TABU for more than 5 channels. As the number of channels increases, MobiCA maintains (for 6 channels) a higher average aggregated throughput compared to RANDOM (14.81%) and LD algorithms (16.28%).

Figure 25b shows the overhead in the control channel varying with the time (considering 6 channels). We analyzed the overhead in bytes (and not in packets) because there are several types of control messages (routing, RTS/CTS, Hello) with different sizes. TABU presents the highest overhead (an average of 5 MB in the 40-second interval) due to the central unit (running TABU) to exchange messages with all nodes in the network.

MobiCA, RANDOM, and LD algorithms present the same overhead (an average of 1.1 MB in the 40 seconds interval) because they use the same mechanism for exchanging messages (it only changes the channel number) and their overhead is lower because the exchange of messages is limited to 2 hops.

Figure 26a shows the comparison among TABU, MobiCA, RANDOM, and LD algorithms considering the spectral distance. On average (considering 6 channels), TABU algorithm presents the highest spectral distance (1.59), followed by LD (1.45), MobiCA (1.17), and RANDOM (1.08), respectively. Although LD algorithm uses as decision criterion the highest spectral distance, its simulation demonstrated that there is no throughput gain (Figure 25a) when compared with a hybrid criterion (i.e., selecting a channel with largest spectral distance if it was not allocated to a neighbor at 2 hops, or selecting the channel with the smallest number of occurrences if all channels are allocated to a neighbor at 2 hops), as used in MobiCA algorithm.

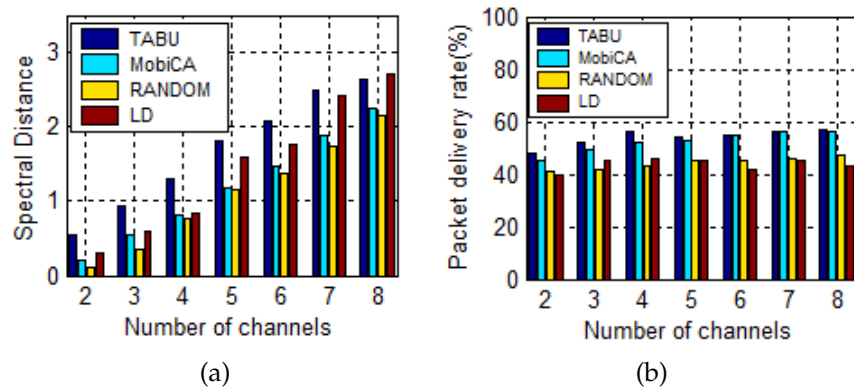

Figure 26: (a) Spectral distance x number of channels, (b) packet delivery rate x number of channels.

Thus, a larger spectral distance does not guarantee an aggregated throughput gain because it also depends on the number of times that the channel with larger spectral distance is allocated.

Figure 26b shows the average packet delivery rate. Considering the average value, MobiCA presents the packet delivery rate very close to TABU, about 2.2%. Compared to RANDOM and LD the average gain is about 7.6% and 9.4%, respectively.

Figure 27a illustrates the average end-to-end delay. For 3 channels, RANDOM presented the highest end-to-end delay (17.66 ms) among all algorithms. With the increasing of the number of channels, the end-to-end delay values between RANDOM and LD became closer (an average difference of 1.22% for 6 channels), decreasing the end-to-end delay. This is due to a greater number of available channels which increases the spectral distance and decreases the number of occurrences of interferences. The lower average end-to-end delay is presented by

TABU (15.16 ms) and MobiCA (15.35 ms) algorithms, respectively. For few channels, the end-to-end delay value is higher due to the contention and higher waiting time in the transmission buffer. As the number of channels increases, the number of contention is decreased and consequently, is so the packet delivery delay.

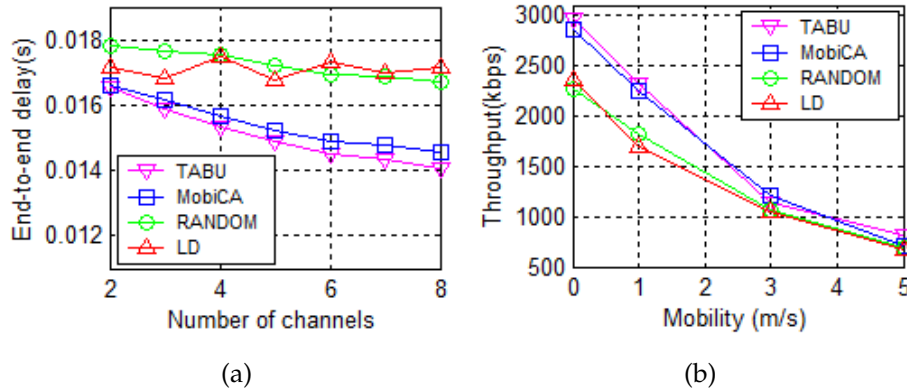

Figure 27: (a) End-to-end delay x number of channels, (b) mobility.

Figure 27b shows the aggregated throughput variation in function of the mobility. In this scenario, we varied the node velocity from 0 m/s to 5 m/s. The higher aggregated throughput for all algorithms is obtained for the static position (speed of 0 m/s) because there is not disconnection due to the mobility.

For low speed (1 m/s), MobiCA and TABU algorithms present values of aggregated throughput very close, with a difference of 4.92 %. Compared to RANDOM and LD, MobiCA presents a gain of 18.9% and 24.7%, respectively.

For higher speed, the node disconnection frequency increases and the network aggregated throughput decreases rapidly.

In the simulation, we varied the number of nodes in the network, from 30 to 80 nodes considering 3 available channels and the same parameters of the previous scenario.

Figure 28a shows the aggregated throughput according to the number of nodes. For lower nodes density, all algorithms present higher aggregated throughput. MobiCA algorithm presents the aggregated throughput close to TABU, and higher than LD, and RANDOM algorithms. By doubling the network density (from 30 to 60 nodes), the aggregated throughput of MobiCA and TABU decreased about 15% and 15.85%, respectively. By increasing the density (from 40 to 80 nodes), the performance

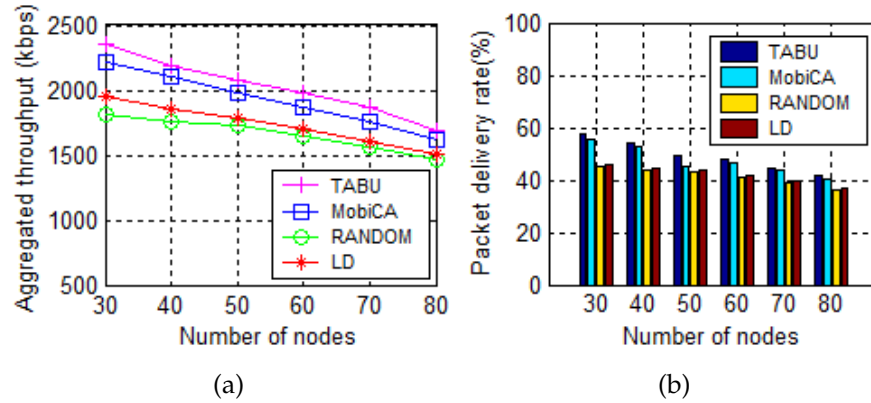

Figure 28: (a) Aggregated throughput  $\times$  number of nodes, (b) packet delivery rate  $\times$  number of nodes.

of MobiCA and TABU decreased about 23% and 23.84%. Thus, the decrease of the performance is very close for both, MobiCA and TABU, in low and high network density. However, MobiCA uses a distributed channel allocation mechanism with lower exchange of messages in the network.

Figure 28b illustrates the comparison of the packet delivery rate for the 4 algorithms. Again, MobiCA presents the packet delivery rate close to TABU, for lower and higher nodes density.

Although MobiCA has slightly lower performance than TABU (about 2.43% for 30 nodes and 1% for 60 nodes), it has a lower cost because the exchange of messages is limited to 2 hops. On the other hand, TABU has high cost that increases with the number of nodes due to the exchange of messages with all the nodes of the network.

### 3.5 CONCLUSION

In this chapter, we presented a user behavior-aware channel allocation strategy for ad hoc networks. In evaluating our mechanism, we initially used a static grid scenario and measured the aggregated throughput, packet delivery rate, and end-to-end delay, regardless of the influence of routing between nodes. We compared our method with TABU heuristic, RANDOM, and single channel methods and we observed that our approach presented results close to TABU search and better than RANDOM and single channel.

We evaluated the weights applied to mobility, traffic, and popularity parameters used as channel allocation criteria. We

obtained the best results when the mobility parameters have the following values of weight: medium for mobility, high for traffic, and low for popularity.

In addition, we evaluated our channel allocation mechanism with the SLAW human mobility model and we compared it with the TABU, RANDOM, and LD algorithms. The results showed that our mechanism leads to values of aggregate throughput, packet delivery rate, and end-to-end delay better than RANDOM and LD, and very close to TABU, with a cost of lower overhead. In addition, we have verified that channel allocation with higher spectral distance does not always lead to higher performance because it depends on the number of times that the channel is allocated.



## CHANNEL ALLOCATION STRATEGY IN VEHICULAR NETWORKS

In this chapter, we address our channel allocation strategy adapted for VANETs scenarios. We present the formulation of the problem and the our channel allocation mechanism. We evaluated the performance of our strategy considering two scenarios: one using a synthetic model (Manhattan Grid mobility model) and other based on trace (Cologne city trace).

### 4.1 FORMULATION OF THE PROBLEM

This section presents the problem formulation for the channel allocation in VANETs. We present the channel model, the network and interference models and the problem specification for the channel allocation.

#### 4.1.1 Channel model

In the IEEE 802.11p standard, the 75 MHz spectrum (between 5.855 GHz and 5.925 GHz) is divided into seven channels (from 172 to 184) [104]. The capacity of each channel is 10 MHz. Channel 178 is a CCH used for safety communications. The other six channels (SCH) can be used for both safety and non-safety applications.

Figure 29 illustrates the control and service channels of the IEEE 802.11p standard.

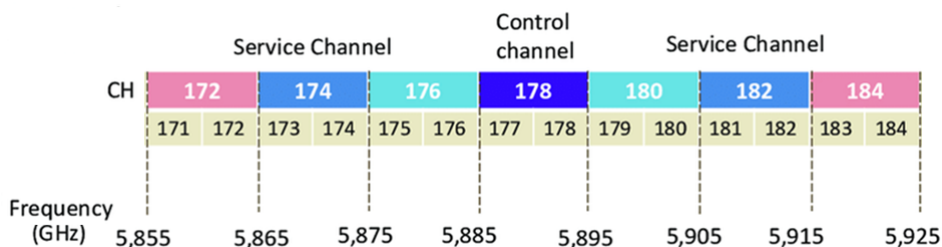

Figure 29: Channels of IEEE 802.11p standard.

#### 4.1.2 *Network and interference model*

The network model considered is an urban vehicular ad hoc network. In the model, each vehicle is represented by a node (in our work, vehicle and node terms are used interchangeably) and the network is represented by a graph. The model uses two network interfaces: one to keep minimum connectivity with neighboring nodes, using a CCC and other to transmit/receive data. These two interfaces are located in OBU of the vehicle. The CCC control interface allows to exchange available channels messages, channel assignment messages, request messages for channel switching (RTS/CTS), and routing messages. The second interface is used to transmit data and switches of channel according to the channel allocation algorithm. The channels used are of the 5.855-5.925 spectrum (ranging from channel 172 to channel 184). The interference model is the 2 hops interference model as discussed in subsection 2.1.4.5 .

#### 4.1.3 *Problem Statement*

The channel allocation problem in VANETs is similar to ad hoc networks (seen in subsection 3.1.4) and the main objective is to mitigate the interference in the links at 2 hops. However, in this scenario, the intermittency and change of topology in the network occurs more quickly due to the higher speed of the nodes. In this way, the channel allocation mechanism must respond quickly to network topology variations, with lower overhead and with a shorter delay time.

In our solution, we use a channel model, based on the IEEE 802.11p protocol, which is more robust against fading and multipath propagation effects of signals in a vehicular environment [105].

In addition, in scenarios of VANETs networks that are sensitive to delays and interruptions and that the delivery of messages to the destinations is a priority, are required mechanisms that allow the storage and forward of the messages when the nodes establish contacts with each other.

## 4.2 THE CHANNEL ALLOCATION MECHANISM

For VANET, we consider the same ad hoc channel allocation mechanism (section 4-3) but with an adaptation in the algorithm for IEEE 802.11p channels. In the algorithm, we use the same interference model at 2 hops but we do not consider the



---

**Algorithm 2** Channel Allocation in VANET
 

---

**Input:** *InterferingLinkList*, *InterferingChannellist*, *C*, *LinkList*

**Output:** *AssignedLinkList*, *AssignedChannellist*

$L \leftarrow$  ordered links of *LinkList*  
 $InterferingLinkList \leftarrow$  interfering links at 2 hops  
 $InterferingChannellist \leftarrow$  interfering channels at 2 hops  
 1: **for** each element  $i \in L$  **do**  
 2:    $link \leftarrow$  element  $i$   
 3:   **if**  $link$  is the link that received the Interaction message  
    **then**  
 4:      $ch \leftarrow$  channel received by the Interaction message  
 5:   **else**  
 6:     **for** each element  $j \in C$  **do**  
 7:       **for** each element  $k \in InterferingChannellist$  **do**  
 8:          $ch \leftarrow$  channell with the lowest number of occur-  
        rences in *InterferingChannellist*  
 9:       **end for**  
 10:     **end for**  
 11:      $AssignedLinkList \leftarrow link$   
 12:      $AssignedChannellist \leftarrow ch$   
 13:   **end if**  
 14: **end for**

---

channel overlapping and spectral distance because the IEEE 802.11p channels are orthogonal.

The nodes exchange information about available channels and mobility using Hello messages. Each node calculates a channel allocation proposal for its links, according to its mobility, traffic, and node popularity parameters (Eq. 6). In addition, the node calculates its priority (Eq. 20) and sends the channel allocation proposal using Interaction message. A node receives the Interaction message and compares its priority with neighbor node priority (contained in Interaction message). If the local node priority is less than or equal to neighbor node priority, the message is dropped. Otherwise, Algorithm 2 is executed.

The Algorithm 2 has the following lists as input:

- 1) *InterferingLinkList*: list of interfering links at 2 hops;
- 2) *InterferingChannellist*: list of interfering channels associated to the links of *InterferingLinkList* list;
- 3) *LinkList*: list of links of the local node;
- 4) *C*: list that contains the channels that will be allocated to links of *LinkList* list.

The algorithm returns as output:

- 1) *AssignedLinkList*: list of the links of the local node;
- 2) *AssignedChannellist*: list of channels assigned to links of *AssignedLinkList*.

In Algorithm 2, for each ordered link in  $L$  (line 1), if the link is the link that received the Interaction message (line 3), it accepts the channel proposed by the Interaction message (line 4). Otherwise (line 5), for each *link* of the *InterferentList*, the algorithm selects a channel that has the least number of occurrences in the *InterferingChannellist* (lines 6-10). A smaller number of occurrences results in a lower level of interference.

### 4.3 PERFORMANCE EVALUATION

In this section, we describe the experiments using NS-v3 simulator considering two scenarios. The first corresponds to a vehicular network using a synthetic mobility model (Manhattan Grid Mobility Model). The second represents a vehicular network considering the DTN protocol [106] using a real trace describing 1 hour of vehicles mobility in Cologne city.

#### 4.3.1 Scenario1: Manhattan Grid Scenario

In Manhattan Grid scenario, the nodes are allowed to move along a grid of horizontal and vertical streets. At an intersection of a horizontal and a vertical street, the node can turn left, right or go straight with a certain probability. In our simulations, we consider the model presented in [107]. That model adds three extra parameters, allowing to define the minimum velocity, the pause probability, and the maximum pause time of the vehicles.

##### SIMULATION SETUP:

The evaluation scenario corresponds to a network simulation consisting of 40 vehicles distributed in an area of 600 m x 600 m with a transmission range of 120 m. The road topology is composed of 6 blocks in the x and y axis of a Cartesian plane. The values of the minimum velocity, pause probability, and maximum pause time are 0 m/s, 0.3, and 30 seconds, respectively. Vehicle speed varies from 0 m/s to 5 m/s. The probability of the vehicle to change its direction is 0.3. The distribution and mobility of the vehicles are determined by Manhattan grid mobility model. In the simulation, four Constant Bit Rate (CBR) data flows were generated (each having 3000 packets) with the pair source and destination determined randomly, following a uniform distribution. The packet size used was 1000 bytes and the simulation time was 72 seconds. We ran 1000 simulations and showed results in terms of mean values and confidence intervals, at a 95% confidence level (which is less than 2% around the mean).

Table 10 shows the parameters used in this scenario.

##### COMPARED APPROACHES:

We compared our proposal (MobiCA) with three other methods: centralized channel allocation (TABU) [45], randomly channel allocation (RANDOM) and single channel (SC). In VANETs, RANDOM is a channel allocation method widely used by RSUs and OBUs to advertise their services.

##### PERFORMANCE METRICS:

Table 10: Configuration parameters for Manhattan Grid Scenario

PARAMETER	DESCRIPTION / VALUE
Number of vehicles	40
Area	600m x 600m
Transmission range	120 m
Mobility model	Manhattan Grid
Minimum velocity	0 m/s
Pause probability	0.3
Maximum pause time	30 sec
Velocity	0 m/s to 5 m/s
Probability of the vehicle to change of direction	0.3
Routing protocol	OLSR
Number of flows	4
Number of packets	3KB
Size of packet	1KB
Time	72 sec

To evaluate the efficiency of the approach, we used four metrics: aggregated throughput, packet delivery rate, end-to-end delay, and overhead.

#### SIMULATION RESULTS:

Figure 30a illustrates the aggregated throughput according to the number of channels. Among RANDOM and SC, MobiCA presents closer results to the centralized approach, having from 4.4% to 2.98% of performance decrease when the number of channels varies between 2 to 4. The impact in MobiCA and TABU is linear for 2, 3, and 4 channels and when compared to RANDOM the observed gain in MobiCA is from 9.2% to 12.61% and from 21.15% to 28.25% when compared to SC. Above 4 channels occurs the aggregated throughput saturation for MobiCA and TABU because all links at 2 hops are using a different channel. As expected, the performance of the SC method is not impacted by the number of channels.

Figure 30b shows the average packet delivery rate. MobiCA presents values of average packet delivery rate very close to TABU with a decrease of 2,9 %. Compared to RANDOM, the gain is about 11.65 % and 17.18 % when compared with SC.

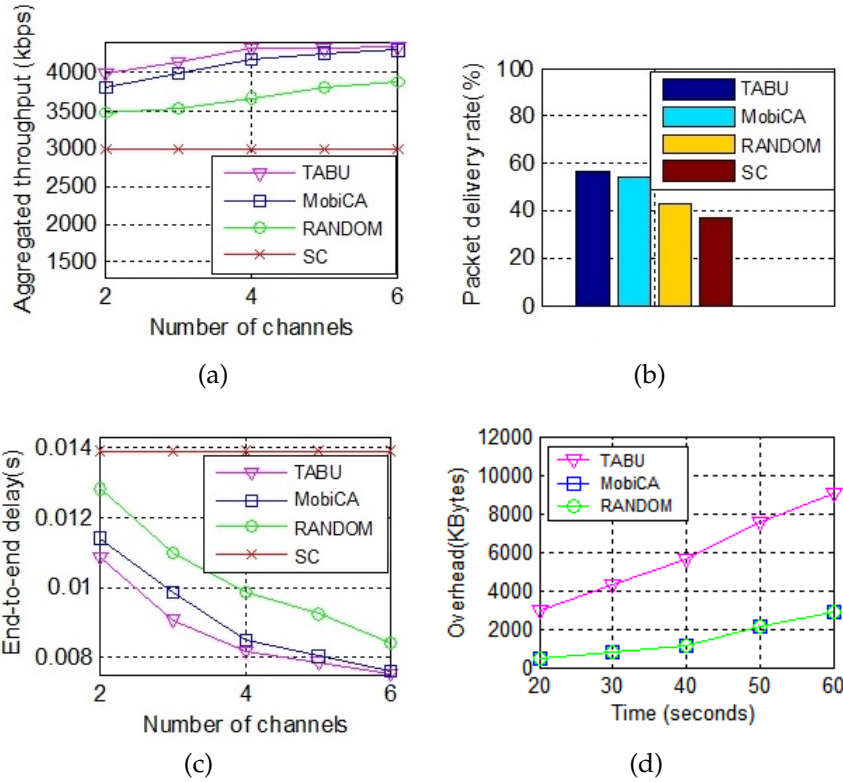

Figure 30: (a) Aggregated throughput, (b) packet delivery rate, (c) end-to-end delay, (d) overhead.

Figure 30c presents the end-to-end delay. MobiCA presents end-to-end delay very close to TABU, with an increase from 3.59% to 4.82% for a number of channels between 2 and 4. Compared to RANDOM and SC, MobiCA presents a decrease of end-to-end delay from 14.13% to 11.22% and from 39.10 % to 18.05 %, respectively. As the number of channels increases, the end-to-end delay decreases due to the lower contention among the neighbors at 2 hops. The highest end-to-end delay is presented by SC because in this method the contention is maximum.

Figure 30d shows the overhead in the control channel changing with the time. We consider the overhead in bytes due to the different sizes of the control messages. TABU presents the highest overhead because it exchanges messages with all nodes in the network. MobiCA and RANDOM present the same overhead because they use the same mechanism for exchanging messages, changing only the number of the channel. They present the lower overhead than TABU centralized approach because the exchange of messages is limited to 2 hops. In the time 40 seconds, the overhead increases because the traffic sources start transmitting, increasing the exchange of RTS/CTS control mes-

sages. In the graph, we do not present the SC mechanism because it does not use a channel control.

#### 4.3.2 Scenario2: Traces of the Cologne City with DTN protocol

The movement of vehicles in VANETs causes excessive delays and retransmissions due to the long periods without connection between the vehicles. In these high disconnection scenarios, conventional routing protocols do not support end-to-end connections, and some message storage and routing mechanism are required, such as those supported by DTNs. In this context, we evaluated our channel allocation mechanism in Vehicular Delay-Tolerant Networking (VDTN) [108].

#### SIMULATION SETUP:

The evaluation scenario corresponds to a simulated network consisting of 50 nodes distributed in an area of 7500 m x 7500 m and having a transmission range of 100 m. The nodes distribution and mobility are obtained from the real-world vehicular trace of Cologne city. We take the corresponding of 1 hour (from 6:00 a.m. to 7:00 a.m.) of the vehicular traffic registered in the dataset and we selected an area of 7500 m x 7500 m with the higher density of vehicles. We ran 100 simulations and showed the results at a 95% confidence level.

Figure 31a and Figure 31b show the density of vehicles at 6:00 a.m. and 7:00 a.m [71], respectively.

In the Figure, the blue points mean the vehicles in highway (higher velocity) and the red points mean the vehicles in the urban center (low velocity). We selected the central area where the concentration of vehicles is higher.

The configuration parameters of the scenario and DTN protocol are shown in the Table 11 and Table 12, respectively.

#### COMPARED APPROACHES:

Initially, we evaluated our proposal considering the use of two DTN routing protocol: EPIDEMIC (EP) [109] and SPRAY AND WAIT (SW) [110].

In EPIDEMIC routing, there is no limit on the number of messages sent in the network. In this case, a message (bundle) is copied to all nodes that do not yet have a copy. In SPRAY AND WAIT routing, the number of copies of messages is limited. In

Table 11: Configuration parameters for Cologne city scenario.

PARAMETER	DESCRIPTION / VALUE
Number of vehicles	50
Area	7500 m x 7500 m
Transmission range	100 m
Mobility model	given by Cologne city trace
Velocity	obtained from trace file
Routing protocol	epidemic and spray-and-wait
Time	3600 sec

Table 12: DTN configuration parameters.

PARAMETER	DESCRIPTION / VALUE
Bundle generated	each 10 sec
Bundle size	1 KB
Hello message interval	100 ms
Bundle lifetime	750 sec
Bundle retransmission timeout	1000 sec
Number of bundle retransmissions:	3
Bundle drop strategy:	drop tail
Bundle buffer size:	1 MB

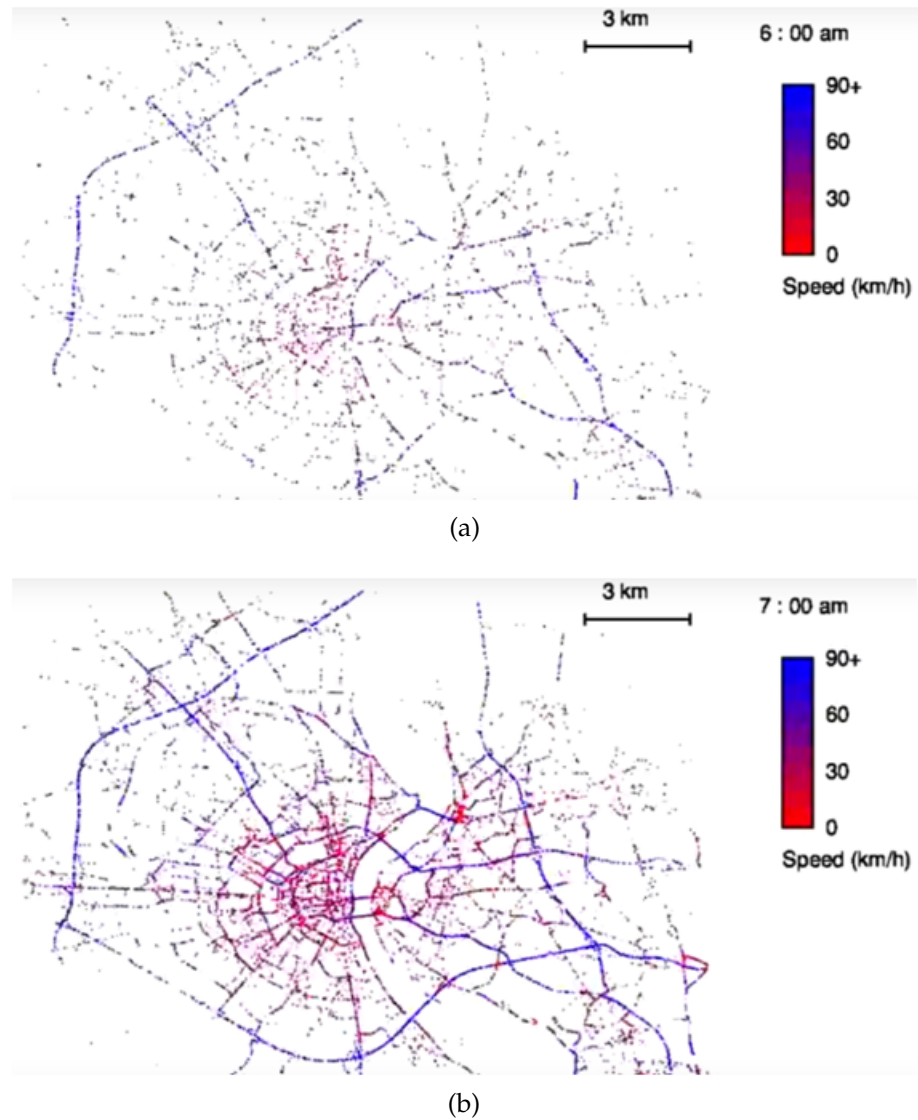

Figure 31: (a) Density of vehicles at 6:00 a.m. , (b) density of vehicles at 7:00 a.m. [71]

our case, we use the default value of 8 i.e., a bundle can be forward to a maximum of 8 nodes.

In addition, we tested our proposal using congestion control in DTN. In this case, if the bundle storage occupancy in the neighbor node is above the congestion control threshold, the bundles are not forward to the neighbor node. We configured a threshold of 0.7, 0.8, and 0.9 for EPIDEMIC routing (represented in the graphs as EP0.7, EP0.8, and EP0.9, respectively). Thus, a bundle is not sent if the buffer is occupied more than 70%, 80%, and 90%, respectively. In SPRAY AND WAIT, as the number of messages is limited, we used a threshold of 0.8 (represented as SW0.8).



## PERFORMANCE METRICS:

To evaluate the performance of our approach considering DTN routing protocol, we use two metrics: packet delivery rate and end-to-end delay.

## SIMULATION RESULTS:

Figure 32a illustrates the packet delivery rate for EPIDEMIC, EPIDEMIC with congestion control (EP0.7, EP0.8, and EP0.9), SPRAY AND WAIT and SPRAY AND WAIT with congestion control (SW0.8). In the Figure 32a, we can observe that using congestion control or limiting the number of the messages lead to a better packet delivery rate. SPRAY AND WAIT and EPIDEMIC routing with congestion control present values closer to packet delivery rate (about 50%), while EPIDEMIC routing without congestion control presents a lower packet delivery rate (about 45%).

The low packet delivery rate for SPRAY AND WAIT and EPIDEMIC is due to the bundle does not find its destination during the bundle lifetime. In our simulation setup, the bundle lifetime is configured as 750 sec. When this value is reached, the bundle expires and it is dropped.

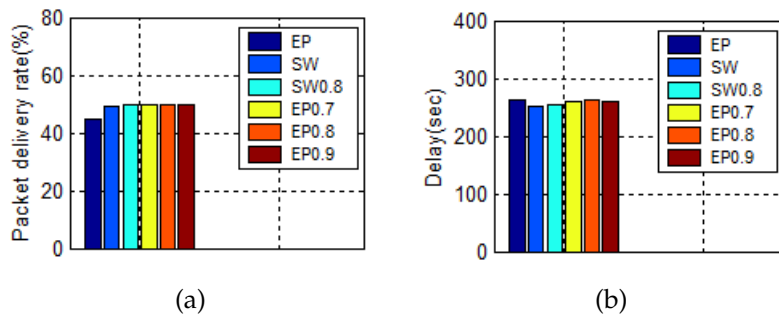

Figure 32: (a) Packet delivery rate, (b) end-to-end delay.

Figure 32b shows the end-to-end delay. The lower end-to-end delay is obtained for SPRAY AND WAIT (252 sec) and SPRAY AND WAIT with the congestion control threshold of 0.8 (254 sec.), although the values among them are close (263 sec for EP, 259 sec for EP0.7, 263 sec. for EP0.8, and 259 for EP0.9). SPRAY AND WAIT presents lower end-to-end delay due to the lower number of messages disseminated, resulting in lower congestion and contention in the network.

As SPRAY AND WAIT presents less dissemination and better performance than EPIDEMIC routing, we consider it as the routing protocol to compare with TABU and RANDOM channel allocation methods. Figure 33 shows the results considering packet delivery rate, end-to-end delay, and overhead.

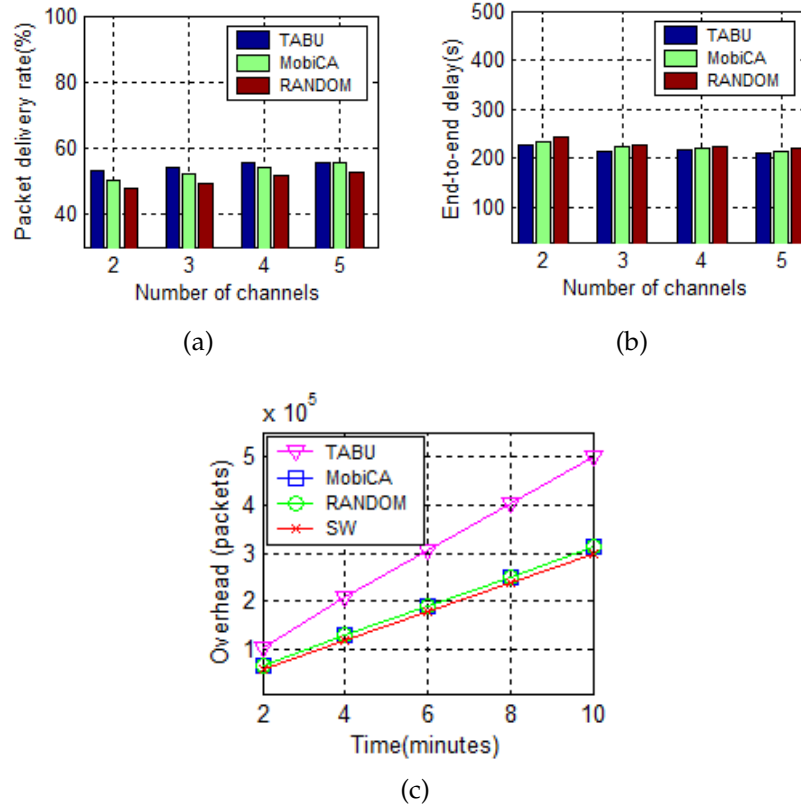

Figure 33: (a) Packet delivery rate, (b) end-to-end delay, (c) overhead.

Figure 33a shows the packet delivery rate considering 5 channels of the IEEE 802.11p standard. MobiCA presents very close performance when compared to upper bound approach, TABU, with a difference of about 3% and 2.1% for 2 and 3 channels, respectively. For 4 channels, the difference is about 1.3%. For 5 channels, the throughput saturates and MobiCA and TABU present the same performance. We can observe that the gains of performance according to the number of channels are close, because the nodes are in movements, and the performance depends on the interfering links and the spatial distance among the nodes. Thus, due to the velocity, a node can quickly leave the coverage area of a interfering node and to use the same channel to communicate with another node.

Figure 33b shows the end-to-end delay. Considering 2 channels, where the contention is higher, MobiCA presents lower end-to-end delay than RANDOM (about 10 sec.) and lightly higher than TABU (about 6 sec.). According to the number of channels increases, the end-to-end delay decreases due to greater availability of channels and lower contention. Analyzing all channels, we observe that all algorithms present high values of end-to-end delay (in the order of 200 sec.) due to the delay when the bundles are stored in the buffers of the nodes, waiting for a contact to forward the bundles.

Figure 33c shows the overhead according to time. In the Figure 33c, SW represents the overhead due only to the SPRAY AND WAIT protocol. MobiCA and RANDOM algorithms present the same overhead because they use the same mechanism to distribute channel information (only the channel number changes). MobiCA and RANDOM present overhead very close to SPRAY and WAIT because the exchange of messages is limited to 2 hops. TABU presents the highest overhead due to its centralized processing requires the exchange of messages with all nodes of the network.

#### 4.4 CONCLUSION

In this chapter, we presented our channel allocation mechanism in the context of vehicular networks. We considered two scenarios, the first using the Manhattan mobility model and the second using a real-world vehicular trace of Cologne city. We performed an adaptation of our algorithm to the 802.11p spectrum, considering the channels as orthogonal. In the Manhattan grid scenario, we compared our channel allocation mechanism with TABU, RANDOM, and single channel allocation. The results show that our mechanism presents performance close to TABU search and values of aggregate throughput and packet delivery rate higher than RANDOM and SC allocation. When compared to RANDOM and SC algorithms, the gain of packet delivery rate is about 11.65% and 17.18%, respectively.

In the scenario considering the Cologne dataset, we evaluated our mechanism using two DTN routing protocols: EPIDEMIC and SPRAY AND WAIT. We have observed that protocols with congestion control or with a smaller number of messages (as SPRAY AND WAIT protocol) lead to a higher packet delivery rate and lower end-to-end delay. Our strategy presented a packet delivery rate close to TABU, with a differ-

ence of 3 %, but with a lower overhead, and with a end-to-end delay about 10 sec. lower than RANDOM.

## CONCLUSIONS AND FUTURE HORIZONS

---

In this chapter, we summarize our thesis addressing the main points and results. After that, we outline the future research directions.

### 5.1 SUMMARY OF THE THESIS

Literature presents several criteria, approaches, and techniques to solve the channel allocation problem in several types of wireless network. Although the literature presents different types of solution to channel allocation, none of them consider together several aspects of the user behavior in the channel allocation process.

In this way, this thesis proposed a channel allocation strategy in ad hoc and vehicular networks, considering aspects of user behavior such as mobility, traffic, and popularity.

We used a distributed approach and we adopted an interference model at 2 hops that allows predicting the interference in the neighbors at 2 hops. In this way, it is possible to mitigate the interference in that links and to avoid the hidden terminal problem. In addition, our strategy allows prioritizing the channel allocation, avoiding to allocate a high-quality channel for a node that will be out of the coverage area in a future time window.

We evaluated our model in two scenarios: ad-hoc and vehicular networks. The results showed that depending on the coefficients configuration, the performance of the throughput, packet delivery rate and, an end-to-end delay may vary. The performance is better when the coefficients of the mobility, traffic, and popularity parameters are configured with values of medium, high, and low, respectively, where medium = 0.3, high = 0.6, and low = 0.1.

We compared our algorithm with three others, TABU, LD, and RANDOM, in a scenario considering the SLAW mobility model. This model is based on the social context that considers some fundamental statistical properties of human mobility. The results showed that our channel allocation mechanism presents the better performance of throughput, packet delivery rate, and

end-to-end delay when compared with LD and RANDOM algorithms. The results are very close when compared with TABU algorithm, but with a lower overhead cost.

We changed the velocity of the nodes, and we observed that according to mobility increases the throughput decreases and with 5 m/s the throughput of all algorithms are very close. In addition, the results show that to use the higher spectral distance as a criterion of channel allocation not always lead to higher throughput because it depends on the number of times the channel is allocated.

We also adapted our algorithm for VANET scenario considering the 6 service channels of the IEEE 802.11p standard. We used the Manhattan Grid mobility model and compared our algorithm with TABU, RANDOM and single channel. The results showed that our algorithm presented lower end-to-end delay than RANDOM (decrease from 14.13% to 11.22%) and single channel (decrease from 39.10% to 18.05%) considering the number of channels between 2 and 4.

We simulated our algorithm considering [VANET DTN](#) scenario using the real-world vehicular trace of Cologne city. We used Epidemic and Spray and Wait as routing protocol and the results showed that protocols with congestion control or with a smaller number of messages lead to a better packet delivery rate. In addition, SPRAY AND WAIT, and SPRAY AND WAIT with congestion control lead to a shortest end-to-end delay. Thus, we considered the SPRAY AND WAIT routing protocol to compare our strategy with TABU and RANDOM channel allocation mechanism. The results showed that our strategy presents values of packet delivery rate very close to upper bound approach, TABU, with a difference of 3%, but with lower overhead, and with an end-to-end delay about 10 sec. lower than RANDOM algorithm.

## 5.2 FUTURE HORIZONS

In this section, we discuss the potential research perspectives in the context of channel allocation.

**UTILIZATION OF CONTEXTUAL INFORMATION:** Many social network-based services store user information that contains various types of features such as mobility, traffic, applications running, places of interest, battery level, preferences, routines, and so on. These information can contribute to a deep under-

standing of the network allowing the development of new mobility models and channel allocation mechanism based on other behavioral parameters.

**NEW MODULATION TECHNIQUES:** Due to increasing demand for higher data rates, better quality of service, and the spectrum scarcity, new modulation techniques will be required to increase the bit rate and spectral efficiency as is occurring with index modulation (IM) in 5G networks [111]. Index modulation can be efficiently implemented for the subcarriers of an Orthogonal Frequency Division Multiplexing (OFDM) system. In this case, information is conveyed not only by M-ary signal constellations as in classical OFDM, but also by the indices of the subcarriers, which are activated according to the incoming information bits. Index modulation can also be used with the Multiple Input Multiple Output (MIMO) system to improve the spectral efficiency. In this case, the information is conveyed by the M-ary signal constellations and by the indices of the transmit antennas of the MIMO system [112]. In the future, index modulation technique can be extended to OFDM in IEEE 802.11 communication standard.

**MACHINE LEARNING:** With machine learning is possible to extract knowledge from the system and gradual learning in the presence of inherent uncertainties and the lack of complete channel and network state information. The channel allocation mechanism can use machine learning to learn and to predict the user behavior and the availability of the channels. In this case, it is possible to dynamically increase the interval of exchange of control messages after the learning period, decreasing the overhead in the network. Some works use machine learning but only consider the traffic parameter to predict the channel state. However, machine learning can be used to predict other factors such as: resource usage, estimation of response times, data traffic monitoring, and optimal scheduling.

**CROSS-LAYER DESIGN:** This is another issue to be considered because network performance depends on not only the resource allocation and access algorithms but also the outage probability of the communication between the nodes. Thus, it is possible to combine channel allocation strategy with routing considering several factors that impact the network perfor-

mance, such as multi-path fading, interference on the channel, user behavior, QoS requirements, and so on.

**CHANNEL ALLOCATION BASED ON QoS APPLICATIONS:** Another open question is the channel allocation based on the Quality of Service (QoS) applications. Many channel allocation mechanisms consider only a single criterion, such as throughput to allocate the channels in the network. However, several applications can have different QoS requirements. For example, File Transfer Protocol (FTP) applications can require high throughput while Voice over Internet Protocol (VoIP) applications can require a small jitter. Thus, it is possible to allocate channels that lead to higher throughput for FTP applications while allocating a channel that presents a small jitter for VoIP applications. Other applications can require different QoS requirements, simultaneously. For example, in M-Health (referring to mobile computing, medical sensor, and communications technologies for health care) [113], applications of telediagnosis requires high throughput, small delay, and is sensitive to context. In that case, the channel allocation mechanism can evaluate and select the channels that best meet those requirements simultaneously.



## BIBLIOGRAPHY

---

- [1] Thomas A. Edison. *Brain Quote*. <https://www.brainyquote.com/quotes/quotes/t/thomasaed149049.html/>. Brain Quote, 2017.
- [2] Statista. *Number of smartphone users worldwide from 2014 to 2020*. <https://www.statista.com/statistics/330695/number-of-smartphone-users-worldwide/>. Statista, 2018.
- [3] John Stevens. *Mobile Internet statistics and facts 2016*. <https://hostingfacts.com/internet-facts-stats-2016/>. Hosting Facts, 2016.
- [4] Ericsson. *Mobile Traffic Q3 2016*. <https://www.ericsson.com/assets/local/mobility-report/documents/2016/ericsson-mobility-report-november-2016.pdf>. Ericsson, 2016.
- [5] K. Lee et al. "SLAW: Self-Similar Least-Action Human Walk." In: *IEEE/ACM Transactions on Networking*. IEEE, 2012, pp. 515–529.
- [6] J. Geier. "Assigning 802.11b access point channels." In: *WiFi Planet Conference*. 2012.
- [7] B. Kauffmann et al. "Measurement-based self organization of interfering 802.11 wireless access networks." In: *Proceedings of the 26th IEEE international Conference on Computer Communications*. IEEE, 2007, pp. 1451–1459.
- [8] B. Karaoglu and W. Heinzelman. "Cooperative Load Balancing and Dynamic Channel Allocation for Cluster-Based Mobile Ad Hoc Networks." In: *IEEE Transactions on Mobile Computing*. IEEE, 2015, pp. 951–963.
- [9] A. Mishra et al. "A Client-driven Approach for Channel Management in Wireless LANs." In: *IEEE INFOCOM*. IEEE, 2007, pp. 1–13.
- [10] S. Zhuo, Z. Wang, and Y. Q. Song. "A traffic adaptive multi-channel MAC protocol with Dynamic Slot Allocation for WSNs." In: *IEEE Transactions on Mobile Computing*. IEEE, 2016, pp. 1600–1613.

- [11] G. Athanasiou, I. Broustis, and L. Tassiulas. "Efficient Load-aware channel allocation in Wireless Access Networks." In: *Journal of Computer Networks and Communications*. Hindawi. 2011, pp. 1–13.
- [12] X. Zhou et al. "Traffic-driven dynamic spectrum auctions." In: *Sensor, mesh and ad hoc communications and networks workshops*. IEEE. 2008, pp. 1–6.
- [13] E. Rozner et al. "Traffic-aware channel assignment in Enterprise Wireless LANs." In: *IEEE International Conference on Network Protocols*. IEEE. 2007, pp. 1–11.
- [14] J. Tang, G. Xue, and W. Zhang. "Maximum throughput and fair bandwidth allocation in multi-channel wireless mesh networks." In: *IEEE International Conference on Computer Communications*. IEEE. 2006, pp. 1–10.
- [15] B. Bakhshi and S. Khorsandi. "A maximum fair bandwidth approach for channel assignment in wireless mesh networks." In: *IEEE Wireless Communications and Networking Conference*. IEEE. 2008, pp. 1–6.
- [16] Y. Kim, F. Baccelli, and G. Veciana. "Spatial reuse and fairness of ad hoc networks with channel-aware csma protocols." In: *IEEE Transactions on Information Theory*. IEEE. 2014, pp. 4139–4157.
- [17] N. Oyie, P. Langat, and S. Musyoki. "A mobility-aware resource allocation scheme in femtocell networks." In: *Scientific Conference Proceedings*. 2013, pp. 1–9.
- [18] Y. Liang, Y. Tsai, and K. Chiang. "A dynamic resource allocation scheme in femtocell networks considering user mobility." In: *Asia-Pacific Conference on Communications*. IEEE. 2016, pp. 1–9.
- [19] M. Zareei et al. "CMCS: a cross-layer mobility-aware MAC protocol for cognitive radio sensor networks." In: *EURASIP Journal on Wireless Communications and Networking*. EURASIP. 2016, pp. 1–15.
- [20] N. Gupta, A. Prakash, and R. Tripathi. "Adaptive Beaconing in Mobility Aware Clustering Based MAC Protocol for Safety Message Dissemination in VANET." In: *Wireless Communications and Mobile Computing*. WCMC. 2017, pp. 1–15.

- [21] H. Balbi et al. "Centralized channel allocation algorithm for IEEE 802.11 networks." In: *Global Information Infrastructure and Networking Symposium*. IEEE. 2012, pp. 1–7.
- [22] T. Lim, W. Jeon, and D. Jeong. "Centralized channel allocation scheme in densely deployed IEEE 802.11 wireless LANs." In: *18th International Conference on Advanced Communication Technology*. IEEE. 2016, pp. 249–253.
- [23] S. Avallone and I. F. Akyildiz. "A Channel Assignment Algorithm for Multi-Radio Wireless Mesh Network." In: *International Conference on Computer Communications and Networks*. IEEE. 2007, pp. 1034–1039.
- [24] M. Parsapoor and U. Bilstrup. "A centralized channel assignment algorithm for clustered ad hoc networks." In: *IEEE Conference on Wireless Sensor*. IEEE. 2013, pp. 73–78.
- [25] B. Ko et al. "Distributed Channel Assignment in Multi-Radio 802.11 Mesh Networks." In: *IEEE Wireless Communications and Networking Conference*. IEEE. 2007, pp. 3978–3983.
- [26] D. M. Shrestha, A. Ranjitkar, and Y. Ko. "A Distributed Channel Assignment for 802.11-based Multi-Radio Wireless Mesh Networks." In: *International Conference on Communications and Networking in China*. IEEE. 2007, pp. 932–936.
- [27] A. Plummer, T. Wu, and S. Biswas. "A localized and distributed channel assignment framework for cognitive radio networks." In: *International Workshop on Cognitive Wireless Networks*. ACM. 2007, pp. 932–936.
- [28] H. Kaur and N. Gupta. "Localized Algorithm for Channel Assignment in Cognitive Radio Networks." In: *International Journal of Engineering Research and Applications*. 2015, pp. 171–176.
- [29] L. Ding et al. "Cross-layer Routing and Dynamic Spectrum Allocation in Cognitive Radio Ad Hoc Networks." In: *IEEE Transactions on Vehicular Technology*. IEEE. 2010, pp. 1969–1979.
- [30] S. Kamruzzaman and E. Kim. "An energy efficient QoS routing protocol for cognitive radio ad hoc networks." In: *IEEE International Conference on Advanced Communication Technology*. IEEE. 2011, pp. 344–349.

- [31] P. R. Walenga Junior et al. "ZAP: a distributed channel assignment algorithm for cognitive radio networks." In: *EURASIP Journal on Wireless Communications and Networking*. EURASIP. 2011, pp. 1–11.
- [32] D. Carrillo. "Cognitive wireless mesh network without common control channel evaluated in NS-3." In: *17th Conference of Open Innovations Association*. IEEE. 2015, pp. 22–27.
- [33] H. M. Almasaeid and A. E. Kamal. "Receiver-Based Channel Allocation for Wireless Cognitive Radio Mesh Networks." In: *IEEE Symposium on New Frontiers in Dynamic Spectrum*. IEEE. 2010, pp. 1286–1299.
- [34] H. A. B. Salameh. "Throughput-oriented channel assignment for opportunistic spectrum access networks." In: *Mathematical and Computer Modelling*. IEEE. 2011, pp. 2108–2118.
- [35] Y. Han et al. "Throughput-efficient channel allocation algorithms in multi-channel cognitive vehicular networks." In: *IEEE Transactions on Wireless Communications*. IEEE. 2017, pp. 757–770.
- [36] M. Tabassum et al. "Interference-aware high-throughput channel allocation mechanism for CR-VANETs." In: *Eurasip Journal on Wireless Communications and Networking*. EURASIP. 2016, pp. 1–15.
- [37] C. Yin, R. Yang, and W. Zhu. "Improving channel assignment in wireless mesh network with linear programming." In: *International Conference on Electronics Information and Emergency Communication*. IEEE. 2016, pp. 113–116.
- [38] A. S. Alfa et al. "Mixed-integer programming based techniques for resource allocation in underlay cognitive radio networks: a survey." In: *Journal of Communications and Networks*. IEEE. 2016, pp. 744–761.
- [39] J. Chen, S. Olafsson, and X. Gu. "Observations on Using Simulated Annealing for Dynamic Channel Allocation in 802.11 WLANs." In: *IEEE Vehicular Technology Conference*. IEEE. 2008, pp. 1801–1805.
- [40] J. Chen, S. Olafsson, and X. Gu. "Observations on Using Simulated Annealing for Dynamic Channel Allocation in 802.11 WLANs." In: *IEEE Vehicular Technology Conference*. IEEE. 2008, pp. 1801–1805.

- [41] S. Middha and P. Singh. "Channel Assignment with Greedy Algorithm for Wireless Mesh Network." In: *Journal of Computer Science and Applications*. 2015, pp. 1–6.
- [42] J. Xu, C. Guo, and J. Yang. "Interference-aware greedy channel assignment in multi-radio multi-channel WMS." In: *Wireless and Optical Communication*. IEEE. 2016, pp. 1–4.
- [43] I. Dolinska et al. "A Minimum-Spanning-Tree-Inspired Algorithm for Channel Assignment in 802.11 Networks." In: *Journal of Electronics and Telecommunications*. IEEE. 2016, pp. 379–388.
- [44] S. Varone and N. Zufferey. "Three tabu search methods for the MI-FAP applied to 802.11 networks." In: *Conference on Combinatorial Optimization*. 2009, pp. 501–514.
- [45] A. Subramanian. "Minimum Interference Channel Assignment in Multiradio Wireless Mesh Networks." In: *IEEE Transactions on Mobile Computing*. IEEE. 2008, pp. 1459–1473.
- [46] F. Glover and M. Laguna. "Tabu Search." In: *Academic Publishers Norwell*. ACM. 1997, pp. 1–382.
- [47] T. Bartz-Beielstein et al. "Evolutionary Algorithms." In: *WIREs Data Mining and Knowledge Discovery*. Wires. 2014, pp. 178–195.
- [48] Z. Wang et al. "Application of Improved Genetic Algorithm in the Channel Allocation of OFDMA System." In: *IEEE Symposium on Computer, Consumer and Control*. IEEE. 2016, pp. 942–947.
- [49] Z. Li et al. "Improved dynamic channel allocation algorithm based on ant colony intelligence for P2P service." In: *IEEE Computing, Communications and IT Applications Conference*. IEEE. 2014, pp. 167–172.
- [50] S. Ghosh, A. Konar, and A. Nagar. "Dynamic Channel Assignment Problem in Mobile Networks Using Particle Swarm Optimization." In: *IEEE European Symposium on Computer Modeling and Simulation*. IEEE. 2008, pp. 64–69.
- [51] S. Kumar, K. Kumar, and A. K. Pandey. "Dynamic Channel Allocation in Mobile Multimedia Networks Using Error Back Propagation and Hopfield Neural Network." In: *Procedia Computer Science*. ELSEVIER. 2016, pp. 107–116.

- [52] E. R. Hruschka et al. "A Survey of Evolutionary Algorithms for Clustering." In: *IEEE Transactions on Systems, Man, and Cybernetics*. IEEE. 2009, pp. 133–155.
- [53] D. G. Reina et al. "A Survey on the Application of Evolutionary Algorithms for Mobile Multihop Ad Hoc Network Optimization Problems." In: *International Journal of Distributed Sensor Networks*. Hindawi. 2016, pp. 1–13.
- [54] C. V. Lucken, B. Baran, and C. Brizuela. "A Survey on multi-objective evolutionary algorithms for many-objective problems." In: *Computational Optimization and Applications*. Springer. 2014, pp. 707–756.
- [55] J. Riihijarvi, M. Petrova, and P. Mahonen. "Frequency Allocation for WLANs using Graph Colouring Techniques." In: *IEEE Conference on Wireless On-demand Network Systems and Services*. IEEE. 2005, pp. 216–222.
- [56] A. Mishra, S. Banerjee, and W. Arbaugh. "Weighted coloring based channel assignment for WLANs." In: *ACM SIGMOBILE Mobile Computing and Communications*. ACM. 2005, pp. 19–31.
- [57] T. A. Sohan et al. "A graph coloring based dynamic channel assignment algorithm for cognitive radio vehicular ad hoc networks." In: *International Conference on Networking Systems and Security*. IEEE. 2016, pp. 1–8.
- [58] Federal Communications Commission Spectrum Policy Task Force. "Report of the Interference Protection Working Group." In: FCC. 2002.
- [59] P.J. Kolodzy. "Interference temperature: a metric for dynamic spectrum utilization." In: *International Journal of Network Management*. Wiley. 2006, pp. 103–113.
- [60] P. Gupta and P.R. Kumar. "The capacity of wireless networks." In: *IEEE Transactions on Information Theory*. IEEE. 2000, pp. 388–404.
- [61] A. Iyer, C. Rosenberg, and A. Karnik. "What is the right model for wireless channel interference." In: *IEEE Transactions on Wireless Communications*. IEEE. 2009, pp. 2662–2671.
- [62] C. Avin et al. "SINR diagrams: towards algorithmically usable SINR models of wireless networks." In: *Proceedings of the 28th ACM Symposium on Principles of Distributed Computing*. ACM. 2009, pp. 200–209.

- [63] Y. Saleem, A. Bashir, and E. Ahmed. "Spectrum-aware Dynamic Channel Assignment in Cognitive Radio Networks." In: *International Conference on Emerging Technologies*. 2012, pp. 1–6.
- [64] S. Batabyal and P. Bhaumik. "Mobility models, traces and impact of mobility on opportunistic routing algorithms: a survey." In: *IEEE Communications Surveys e Tutorials*. IEEE. 2015, pp. 1679–1707.
- [65] C. Puttamadappa S. K. Sarkar T.G. Basavaraju. *Ad hoc Mobile Wireless Networks. Principles, Protocols, and Applications*. 1nd. Boca Raton, FL, USA: Auerbach Publications, 2007.
- [66] A. Hanggoro and R. F. Sari. "Performance evaluation of the manhattan mobility model in vehicular ad-hoc networks for high mobility vehicle." In: *IEEE International Conference on Communication, Networks and Satellite*. IEEE. 2013, pp. 31–36.
- [67] B. Ramakrishnan et al. "Comprehensive analysis of highway, manhattan and freeway mobility models for vehicular ad hoc network." In: *International Journal of Wireless and Mobile Computing*. IEEE. 2015, pp. 78–89.
- [68] Cabspotting. "San Francisco taxi cab trace." In: <http://cabspotting.org>. Cabspotting. 2016.
- [69] Microsoft. "GeoLife GPS Trajectories." In: <https://www.microsoft.com/en-us/research/publication/geolife-gps-trajectory-dataset-user-guide/>. Microsoft. 2016.
- [70] L. Rivoirard et al. "Using real-world car traffic dataset in vehicular ad hoc network performance evaluation." In: *International Journal of Advanced Computer Science and Applications*. 2016, pp. 390–398.
- [71] TAPASCologne project. "Vehicular mobility trace of the city of Cologne, Germany." In: <http://kolntrace.project.citilab.fr/>. TAPAS. 2016, pp. 390–398.
- [72] N. Aschenbruck, A. Munjal, and T. Camp. "Trace-based mobility modeling for multi-hop wireless networks." In: *Computer Communications*. Elsevier. 2011, pp. 704–714.
- [73] C. Sreedhar et al. "A Survey on Security Issues in Wireless Ad hoc Network Routing Protocols." In: *International Journal on Computer Science and Engineering*. 2010, pp. 224–232.

- [74] D. Deng, Y. Chen, and Y. Wong. "Adaptive channel allocation strategy for mobile ad hoc networks." In: *Mathematical and Computer Modelling*. Elsevier. 2013, pp. 2720–2730.
- [75] M. Parsapoor and U. Bilstrupand. "Ant colony optimization for channel assignment problem in a clustered mobile ad hoc network." In: *Proceedings of the 4th International Conference on Swarm Intelligence*. 2013, pp. 314–322.
- [76] K. N. Quang, V. D. Nguyen, and H. Choo. "Dynamic subchannel assignment-based cross-layer MAC and network protocol for multihop ad hoc networks." In: *Journal of Computer Networks and Communications*. Hindawi. 2013, pp. 1–9.
- [77] Y. Yao et al. "Power Control Based Channel Allocation Method for Ad Hoc Networks." In: *Applied Mechanics and Materials*. 2014, pp. 299–302.
- [78] S. S. Dehkordi and J. Torkestani. "Channel assignment scheme based on learning automata for clustered wireless ad hoc networks." In: *Journal of Computer Science and Information Technology*. 2014, pp. 149–172.
- [79] M. Nivetha and C. Rajinikanth. "An energy efficient multichannel MAC provisioning In MANETs." In: *International Journal of Engineering And Computer Science*. 2015, pp. 12176–12180.
- [80] Y. Wang and J.J. Garcia-Luna-Aceves. "A Distributed Cross-layer Routing Protocol with Channel Assignment in Multi-Channel MANET." In: *IEEE: International Conference on Computing, Networking and Communications*. IEEE. 2015, pp. 1–5.
- [81] M. Jothilakshmi et al. "Dynamic channel allocation for cluster-based mobile ad hoc networks." In: *International Journal of Innovative Research in Computer and Communication Engineering*. 2016, pp. 8727–8733.
- [82] K. Shahina and Y. B. Jinila. "An Improved Model For Load Balancing and Dynamic Channel Allocation In Cluster Based MANETs." In: *Journal of Engineering and Applied Sciences*. ARPN. 2016, pp. 8094–8099.
- [83] A. Fathinavid. "A dynamic hybrid CDMA/TDMA scheme in mobile ad hoc networks based on learning automat." In: *International Journal of Computer Science and Network Security*. Springer. 2017, pp. 1–12.



- [84] C. Chao, H. Tsai, and C. Huang. "Load-aware channel hopping protocol design for mobile ad hoc networks." In: *Wireless Networks*. Springer. 2017, pp. 89–101.
- [85] G. Bhuvaneshwari and K. Vaitheki. "Load balancing and channel assignment for cluster based MANET in heterogeneous network." In: *International Journal of Advanced Research in Electrical, Electronics and Instrumentation Engineering*. 2017, pp. 168–175.
- [86] W. Liang et al. "Vehicular ad hoc networks: architecture, research issues, methodologies, challenges, and trends." In: *International Journal of Distributed Sensor Networks*. IEEE. 2015, pp. 1–11.
- [87] R. S. Hande and A. Muddana. "Comprehensive survey on clustering-based efficient data dissemination algorithms for VANET." In: *International Conference on Signal Processing, Communication, Power and Embedded System*. SCOPES. 2016, pp. 629–632.
- [88] S. A. Hussain et al. "An efficient channel access scheme for vehicular ad hoc networks." In: *Mobile Information Systems*. Hindawi. 2017, pp. 1–10.
- [89] T. Zhao et al. "A connectivity resilient dynamic multi-channel assignment method for VANET." In: *Journal of Security and Communication Networks*. ACM. 2015, pp. 1855–1864.
- [90] N. Gupta, Arun Prakash, and R. Tripathi. "Clustering based cognitive MAC protocol for channel allocation to prioritize safety message dissemination in vehicular ad-hoc network." In: *Vehicular Communications*. ELSEVIER. 2016, pp. 44–54.
- [91] V. Nguyen, M. A. Kazmi, and C. S. Hong. "ECCT: An efficient-cooperative ADHOC MAC for cluster-based TDMA system in VANETs." In: *International Journal of Distributed Sensor Networks*. Hindawi. 2015, pp. 1–12.
- [92] H. Peng et al. "CM-MAC: A cluster-based multi-channel MAC protocol for VANET." In: *Journal of Computer Research and Development*. ELSEVIER. 2014, pp. 502–510.
- [93] I. Chu, P. Chen, and W. Chen. "An IEEE 802.11p based distributed channel assignment scheme considering emergency message dissemination." In: *Vehicular Technology Conference (VTC Spring)*. IEEE. 2012, pp. 1–5.

- [94] S. Park et al. "Dynamic service-channels allocation (DSCA) in vehicular ad hoc networks." In: *IEEE Consumer Communications and Networking Conference*. IEEE. 2013, pp. 351–357.
- [95] A. Reddy and M. Reddy. "PBMAC - Position based channel allocation for vehicular ad hoc networks." In: *Journal of Advanced Networking and Applications*. 2017, pp. 3156–3160.
- [96] R. S. Tomar and S. Verma. "RSU centric channel allocation in Vehicular Ad hoc Networks." In: *Sixth International Conference on Wireless Communication and Sensor Networks*. IEEE. 2011, pp. 1–6.
- [97] M. Frigau. "Social-based forwarding in multi-channel vehicular networks." In: *IEEE International Workshop on Smart City and Ubiquitous Computing Applications*. IEEE. 2015, pp. 166–173.
- [98] S. Chiochan, E. Hossain, and J. Diamond. "Channel Assignment Schemes for Infrastructure-based 802.11 WLANs: A Survey." In: *IEEE Communications Surveys and Tutorials*. IEEE. 2010, pp. 124–136.
- [99] F. D. Malliaros et al. "Locating influential nodes in complex networks." In: *Scientific Reports* 1 (2016).
- [100] B. Lee and J. Kim. "Algorithm for finding the moving direction of a vehicle using magnetic sensor." In: *IEEE Symposium on Computational Intelligence in Control and Automation*. IEEE. 2011, pp. 74–79.
- [101] H. Y. Song and J. S. Lee. *Detecting Positioning Errors and Estimating Correct Positions by Moving Window*. [http://journals.plos.org/plosone/article?id=10.1371/journal.pone.0143618/](http://journals.plos.org/plosone/article?id=10.1371/journal.pone.0143618). PLoS ONE, 2017.
- [102] T. R. Henderson, M. Lacage, and G. F. Riley. "Network simulations with the NS-3 simulator." In: *ACM SIGCOMM*. IEEE. 2008, pp. 527–527.
- [103] E. G. Villegas et al. "Effect of adjacent-channel interference in IEEE 802.11 WLANs." In: *International Conference on Cognitive Radio Oriented Wireless Networks and Communications*. IEEE. 2007, pp. 118–125.
- [104] L. Miao et al. "Evaluation and enhancement of IEEE 802.11p standard: a survey." In: *Mobile Computing*. IEEE. 2012, pp. 15–30.

- [105] W. Lin et al. "A comparison of 802.11a and 802.11p for V-to-I Communication: a measurement study." In: *International Conference on Heterogeneous Networking for Quality, Reliability, Security and Robustness*. 2010, pp. 559–570.
- [106] L. Wan et al. "Routing protocols for delay tolerant networks: survey and performance evaluation." In: *International Journal of Wireless and Mobile Networks*. 2015, pp. 1–16.
- [107] N. Aschenbruck. *BonnMotion - A Mobility Scenario Generation and Analysis Tool*. <https://sys.cs.uos.de/bonnmotion/doc/README.pdf>. University of Osnabruck, 2016.
- [108] J. G. Filho et al. "A systematic technical survey of DTN and VDTN routing protocols." In: *Computer Standards and Interfaces*. Elsevier. 2016, pp. 139–159.
- [109] T. Choksatid Wan, W. Narongkhachavana, and S. Prabhavat. "An efficient spreading Epidemic Routing for Delay-Tolerant Network." In: *Consumer Communications and Network Conference*. IEEE. 2016, pp. 473–476.
- [110] G. Wang et al. "A routing scheme based on Spray-and-Wait and Connecting-Capability of Node." In: *International Conference on Progress in Informatics and Computing*. IEEE. 2016, pp. 577–580.
- [111] E. Basar. "Index modulation techniques for 5G wireless networks." In: *IEEE Communication Magazine*. IEEE. 2016, pp. 168–175.
- [112] X. Cheng et al. "Index Modulation for 5G: Striving to Do More with Less." In: *IEEE Communications Magazine* 54 (2016), p. 8.
- [113] I. Martinez, J. Garcia, and E. Viruete. "Resources variability in M-health services: an adaptive method for QoS control." In: *IEEE Consumer Communications and Networking Conference*. IEEE. 2008, pp. 829–822.

**Titre :** Allocation de canaux sur les réseaux sans fils mobiles

**Mots clés :** Allocation de Canaux Distribués, Accès Dynamique au Spectre, Modèle de Mobilité SLAW, Comportement de l'utilisateur

**Résumé :**

Cette thèse présente une stratégie d'allocation de canaux pour les réseaux sans fil, basée sur le comportement de l'utilisateur. Notre contribution principale est de considérer certaines caractéristiques du comportement de l'utilisateur, comme la mobilité, le trafic et la popularité dans le processus d'allocation des canaux. De cette façon, nous priorisons l'allocation de canaux pour les nœuds qui resteront dans le réseau dans une fenêtre temporelle future, avec un trafic plus élevé et avec plus de popularité. Nous adoptons une approche distribuée qui permet de limiter le nombre de messages échangés dans le réseau tout en répondant rapidement aux changements de la topologie. Dans notre évaluation des performances, nous considérons des scénarios dans des réseaux ad hoc et véhiculaires et nous utilisons des modèles

de mobilité synthétique, tels que SLAW et Manhattan Grid, et l'ensemble de données de traces de ville de Cologne, Allemagne. Nous comparons notre stratégie avec une stratégie centralisée (TABU), la plus grande distance spectrale (LD), une aléatoire (RANDOM) et à un seul canal (SC). Nous évaluons les métriques de débit agrégé, le débit de livraison des paquets, le délai de bout en bout et le frais. Dans le scénario véhiculaire, nous considérons les métriques liées au retard, telles que le débit de distribution de paquets et le délai de bout en bout. Les simulations prenant en compte des scénarios ad hoc et véhiculaires montrent que notre stratégie présente de meilleurs résultats que les stratégies RANDOM, LD et l'allocation à un seul canal, avec des valeurs proches de la recherche TABU, mais avec des frais généraux moins élevés.

**Title :** Channel Allocation in Mobile Wireless Networks

**Keywords :** Distributed Channel Allocation, Dynamic Spectrum Access, SLAW Mobility Model, User behavior

**Abstract :**

This thesis presents a channel allocation strategy for wireless networks based on user behavior. Our main contribution is to consider some characteristics of the user behavior, such as mobility, traffic, and popularity in the channel allocation process. In this way, we prioritize the channel allocation for the nodes that will remain in the network in a future time window, with higher traffic, and with more popularity. We adopt a distributed approach that allows limiting the number of messages exchanged in the network while quickly responding to changes in the topology. In our performance evaluation, we consider scenarios in ad hoc and vehicular networks and we use some synthe-

tic mobility models, such as SLAW and Manhattan Grid and trace-based such as Cologne city dataset, in Germany. We compare our strategy with a centralized strategy (TABU), with the largest spectral distance (LD), with a random (RANDOM), and with a single channel allocation strategy (SC). We evaluate metrics of aggregated throughput, packet delivery rate, end-to-end delay, and overhead. In a vehicular environment, we consider metrics related to delay such as packet delivery rate and end-to-end delay. Simulations considering ad hoc and vehicular scenarios show that our strategy presents better results than RANDOM, LD strategies, and single channel allocation, with values close to TABU search, but with lower overhead.

