



HAL
open science

A tropical geometry and discrete convexity approach to bilevel programming: application to smart data pricing in mobile telecommunication networks

Jean-Bernard Eytard

► **To cite this version:**

Jean-Bernard Eytard. A tropical geometry and discrete convexity approach to bilevel programming: application to smart data pricing in mobile telecommunication networks. Optimization and Control [math.OC]. Université Paris-Saclay, 2018. English. NNT : 2018SACLX089 . tel-01972391

HAL Id: tel-01972391

<https://pastel.hal.science/tel-01972391>

Submitted on 7 Jan 2019

HAL is a multi-disciplinary open access archive for the deposit and dissemination of scientific research documents, whether they are published or not. The documents may come from teaching and research institutions in France or abroad, or from public or private research centers.

L'archive ouverte pluridisciplinaire **HAL**, est destinée au dépôt et à la diffusion de documents scientifiques de niveau recherche, publiés ou non, émanant des établissements d'enseignement et de recherche français ou étrangers, des laboratoires publics ou privés.

THÈSE DE DOCTORAT

de

L'UNIVERSITÉ PARIS-SACLAY

École doctorale de mathématiques Hadamard (EDMH, ED 574)

Établissement d'inscription : Ecole polytechnique

Laboratoire d'accueil : Centre de mathématiques appliquées de Polytechnique, UMR 7641 CNRS

Spécialité de doctorat : Mathématiques appliquées

Jean-Bernard EYTARD

A tropical geometry and discrete convexity approach to bilevel
programming
Application to smart data pricing in mobile telecommunication networks

Date de soutenance : 12 novembre 2018

Après avis des rapporteurs : LUCE BROTCORNE (INRIA Lille)
JOSEPHINE YU (Georgia Institute of Technology)

Jury de soutenance :

MARIANNE AKIAN	(INRIA et École polytechnique) Codirecteur de thèse
MUSTAPHA BOUHTOU	(Orange Labs) Examineur
LUCE BROTCORNE	(INRIA) Rapporteur
STÉPHANE GAUBERT	(INRIA et École polytechnique) Directeur de thèse
CHARLES HORVATH	(Université de Perpignan) Examineur
GLEB KOSHEVOY	(Russian Academy of Science) Examineur
BRUNO TUFFIN	(INRIA) Examineur/Président du jury
JOSEPHINE YU	(Georgia Institute of Technology) Rapporteur

Remerciements

Le travail effectué durant ces trois années, et exposé dans ce manuscrit, n'aurait pas été possible sans le concours et l'appui de nombreuses personnes, que je tiens à remercier.

Mes premiers mots vont pour mes directeurs de thèse, Marianne Akian et Stéphane Gaubert. J'ai beaucoup appris à vos côtés pendant ces trois ans. Vous m'avez permis de découvrir des pans entiers des mathématiques dont je ne soupçonnais pas l'existence, et encore moins l'application à des problèmes concrets. C'est aussi grâce à vous que ce travail a pu être conduit, malgré toutes les embûches qui jalonnent le parcours d'un doctorant.

Je remercie tout particulièrement Mustapha Bouhtou qui est à l'origine du problème étudié dans cette thèse, et plus généralement Orange Labs qui m'a permis de réaliser ce travail. Je remercie également Gleb Koshevoy, avec lequel j'ai eu plaisir à collaborer et dont l'expérience et la connaissance m'ont très largement permis d'éclaircir et d'approfondir bon nombre de concepts, notamment au sujet de la convexité discrète. Un grand merci à Luce Brotcorne et Josephine Yu d'avoir accepté de relire ce travail, et dont les remarques m'ont été très utiles pour l'améliorer. Je remercie aussi Charles Horvath et Bruno Tuffin d'avoir accepté de faire partie du jury de cette thèse.

Il est absolument impossible de mener à bien une thèse sans un environnement propice au travail et des personnes dévouées pour répondre à nos questions, rendre service et améliorer les choses. Je remercie Anne de Bouard, directrice du CMAP, de m'avoir permis d'effectuer cette thèse dans son laboratoire. Je remercie également Frédéric Paulin et Thierry Bodineau pour leur implication au sein de l'Ecole Doctorale de Mathématiques Hadamard. J'adresse une mention toute particulière à l'équipe administrative du CMAP. Nasséra Naar, pour son écoute et ses très bons conseils au moindre souci. Bien que le sujet des bureaux soit parfois épineux et fastidieux, ça a été pour moi un plaisir de travailler avec toi. Alexandra Noiret, pour son investissement dans le bon fonctionnement du laboratoire et qui a toujours à coeur de résoudre les problèmes des doctorants. Egalement à Manoëlla, Maud, Wilfried et Vincent, tous très investis et disponibles. J'adresse de sincères remerciements aux différentes assistantes de l'équipe TROPICAL qui se sont succédées durant mes trois ans : Jessica Gameiro, Corinne Petitot et Hanadi Dib. Vous avez toujours été disponibles et efficaces pour gérer toutes sortes de problèmes, administratifs ou non, que j'ai pu rencontrer pendant toute la durée de ma thèse, et m'avez été d'un grand soutien.

Je remercie enfin Sylvain Ferrand et Pierre Straebler pour leur précieuse aide concernant tout problème informatique.

Je tiens également à remercier l'ensemble de mes professeurs et encadrants qui m'ont donné le goût des mathématiques tout au long de mon parcours et m'ont amené à la rédaction de cette thèse. Je pense en particulier à Nicolas Petit, pour m'avoir accueilli au sein de son laboratoire en stage de recherche en deuxième année des Mines et pour m'avoir toujours soutenu, ainsi qu'à Laurent Praly qui a encadré ce stage de recherche et avec lequel j'ai eu grand plaisir à collaborer. Cela reste pour moi une formidable expérience. Je remercie également Pierre Berest pour m'avoir fait partager son expérience et pour les conseils qu'il m'a prodigués. Je remercie enfin Mohamed Kerrich, pour notre collaboration lors de mon stage de fin d'études et pour les échanges enrichissants que nous avons eus.

A priori, une thèse est un travail personnel, mené conjointement avec ses directeurs. Mais il est essentiel d'avoir des collègues (qui au fil du temps deviennent plus que ça d'ailleurs ...) avec lesquels on peut apprendre, échanger, partager nos galères, se divertir, parler (ce n'est pas mon genre), boire un verre (ça non plus), jouer au foot ou au badminton, participer à un 10 kilomètres voire à un marathon en équipes (tout le monde sait que je suis un grand sportif), faire des mots fléchés, regarder "Des chiffres et des lettres" ou faire un Scrabble (oui oui, il y a un club du troisième âge au sein des doctorants)... Vous fûtes également source d'une grande motivation pour venir dans les contrées lointaines du plateau de Saclay, et m'apportâtes le courage nécessaire pour ne rien lâcher lorsque je dus finir à plus de 2 heures du matin les trois nuits précédentes, pour le rendu d'un article ou du présent manuscrit.

Je remercie en premier lieu ceux qui m'ont accueilli lorsque je suis arrivé. Aymeric, pour nos nombreuses discussions sur des sujets divers et variés. Etienne, pour ton organisation du séminaire ainsi que de sa version 2.0 qui était très conviviale (et qui s'est hélas perdue depuis...) Simona, pour m'avoir encouragé au foot, pour nos échanges sur l'athlétisme italien et pour m'avoir appris les paroles de Fratelli di Italia. J'ai ensuite une pensée amicale pour tous les doctorants du bureau 2016 (étant données mes nombreuses tentatives de déstabilisation et de déconcentration en parlant de sport, d'histoire ou de politique, ils auront tous un grand mérite à finir leur thèse dans les trois ans impartis). Perle, qui fut toujours partante pour une grande partie des activités sus-citées (désolé, je balance). Merci en particulier pour tes encouragements pendant les moments difficiles, et pour ta relecture de l'introduction de cette thèse. Paul, pour ton écoute, ta très grande culture sportive, ton enthousiasme à proposer de nombreuses activités et ton chocolat. Cédric, qui est d'entre tous celui que j'ai rencontré en premier, du temps où il était piauleur à la Meuh (les initiés comprendront cette phrase énigmatique...), pour tes bons conseils et pour les instants passés à suivre les matchs du Brésil et de la France en coupe du monde à la terrasse d'un bar bordelais ou dans un TGV. Hadrien, pour ta grande connaissance, tes "JPP" et "choqué et déçu". J'espère de tout coeur que les quelques conseils juridiques que je t'ai prodigués n'auront pas définitivement ruiné ta carrière. Paul, pour ta bonne humeur, ton intérêt pour l'application des mathématiques au sport, pour m'avoir replongé dans la topologie après six ans de latence et m'avoir fait découvrir le Stade Français. Mathieu, pour m'avoir convaincu qu'on nous ment perpétuellement, y compris lorsqu'on nous assène tout petit que la géométrie euclidienne est celle qui régit le monde. Cheikh, pour ta joie de vivre, ton record du monde à l'épreuve du 10 kilomètres avec sac en bandoulière, et pour m'avoir fait prendre conscience qu'il m'arrivait de parler trop vite sans articuler. Florian, pour ta pédagogie et ton sens inimitable du calembour. Julie, pour ton sens de la répartie et pour avoir réintroduit le

principe des horaires décalés vers le matin, que j'ai ardemment défendu durant ma première année et que j'ai lâchement abandonné ensuite. Raphaël, pour ta sympathie et ta co-organisation du séminaire des doctorants. Jingjing, pour m'avoir appris quelques mots en chinois et pour ton sens de la réflexion inattendue. Je remercie également Emile, Nicolas, Pierre et Pamela pour la bonne humeur qu'ils ont apportée au bureau. Je pense également aux anciens du bureau 2003 dans lequel j'ai passé un an. Vianney, pour nos discussions et tes explications quand je suis arrivé. Antoine, pour m'avoir initié à la théorie des jeux. Gustaw, Alexei et Alain, pour avoir largement contribué au rayonnement du Real Matrice.

Je remercie également tous les doctorants de mon équipe. Outre Antoine et Vianney, cités ci-dessus, je remercie Mateusz avec qui j'ai eu plaisir à voyager lors des différentes conférences auxquelles nous avons participé. Merci pour ta grande culture et tes nombreuses explications, et j'espère que tu trouveras un jour un excellent Positivstellensatz tropical. Nikolas, pour tes conseils avant et pendant ma thèse. Marin, à qui je souhaite bonne chance pour les trois années à venir. Enfin, Paulin et Maxime pour les échanges que nous avons eu, notamment en conférence. Je n'oublie pas tous les autres doctorants du CMAP avec lesquels j'ai passé de très bons moments durant ces trois ans. Ludovic, mon voisin réginaurbourgeois, pour nos nombreuses discussions et nos matches de badminton. Tristan, pour avoir partagé avec moi les différents problèmes relatifs à la fin de thèse. Céline, pour avoir accepté de reprendre la prise en charge des bureaux quand la rédaction de cette thèse devenait trop chronophage. Belhal, pour ta bonne humeur et tes conseils en longboard. Romain, pour nos échanges sur l'avenir des docteurs dans les entreprises françaises. Je remercie naturellement Hélène, Mathilde, Geneviève, Massil, Martin, Luca, Othmane, Rémi, Fedor, Lucas, Lucas et Joon qui avec bon nombre des doctorants précédemment mentionnés, ont accepté de me laisser toucher la balle lors des entraînements de foot, même s'ils étaient assurés que l'équipe adverse marque dans ces conditions. Je pense également à Corentin, Loïc et Nicolas qui ont eux aussi fait partie de la "team badminton". Enfin, je remercie Aline, Juliette, Kevish, Arthur, Heythem, Antoine, Raphaël, Mohamed, Benjamin, Nicolas, Guilherme et tous ceux que j'ai malheureusement oubliés (j'espère que vous me pardonnerez...) pour tout ce que vous m'avez apporté pendant trois ans.

Tout le monde n'a pas la chance lors de sa thèse d'avoir son père travaillant dans un laboratoire voisin. Bien que bon nombre des membres du LMS m'aient connu il y a très longtemps (certains lorsque j'étais encore dans le berceau, d'autres lors de mon stage de troisième effectué il y a plus de onze ans...), ils m'ont accueilli et considéré comme un des leurs par filiation. Je les remercie chaleureusement pour tous les instants que nous avons partagés lors des déjeuners et pauses cafés, et pour l'attention qu'ils m'ont toujours portée. Hakim, pour nos longs débats sur le football et la politique qui vont assurément me manquer. Vincent, pour m'avoir fait courir au badminton comme jamais. Erik, pour nos discussions diverses et variées, et Philippe pour nos dissertations tennistiques. Catherine, pour ta disponibilité et ta sympathie. Pascal et François, pour m'avoir expliqué le fonctionnement d'un atelier de mécanique. Alexandra, Anna, Christiane et Danielle pour la bonne humeur que vous avez apportée lors des déjeuners. Audrey, pour ta connaissance de la variété française. Laurence et Jean-Marc, pour vos précieux conseils de chercheurs d'un domaine extérieur au mien. Je remercie également Eva, Alexandre, Simon, Sylvain, Ali, William ainsi que tous les autres membres et chercheurs du laboratoire pour leur accueil et leur bienveillance. Je n'oublie pas Jean-Pierre, Alexandre, Laurant et tous les doctorants du LMS avec lesquels j'ai eu des contacts chaleureux et d'intéressantes discussions, que ce soit dans les couloirs, en salle café ou sur le terrain de football. Enfin, je remercie toutes les personnes de l'Ecole Polytechnique que je connus alors que je n'étais pas bien grand (Roselyne, Pascale et

tous ceux qui se reconnaîtront) pour la bienveillance qu'ils eurent toujours à mon égard.

Je tiens désormais à remercier tous mes amis pour leur soutien inconditionnel. Je commencerai naturellement par ceux qui ont partagé les joies et difficultés du doctorat avec moi. Jean, pour ton aide précieuse à tout instant, pour la qualité de nos discussions, et pour ton partage des ressources gastronomiques du sud ouest de la France et de la Réunion. François, pour les interrogations que nous avons pu partager étant donnée la proximité de nos thèmes de recherche, ainsi que pour les sympathiques moments passés en conférence. Clément, pour m'avoir fait découvrir le monde branonique. Mike, pour ton rôle de pilier sur lequel on peut toujours compter. Ricardo, pour ton partage de la culture et de l'ambiance chilienne. Jean-Maurice, pour m'avoir supporté depuis de longues années et pour ces soirées au restaurant chinois.

Je remercie également ceux que les sirènes de la recherche n'ont pas réussi à attirer. Philippe, pour ton soutien sans faille et pour avoir toujours été partant dans mes activités habituellement associées au troisième âge. Rémi, pour la confiance que tu m'as accordée et pour m'avoir fait découvrir Marseille. Adrien, pour ta gentillesse, pour m'avoir fait découvrir le tournoi de coinche du mercredi soir et pour tes tours de magie tous aussi bluffants les uns que les autres. Thibaut, pour nos soirées crêpes et pour avoir su résister à toutes les épreuves arméniennes. Laure, pour tes messages attentionnés. Marine, pour tes bons plans, ton robot et ta jacqueline. Olivier, pour avoir pris en charge l'organisation des soirées. Grégoire, pour nos passionnantes discussions historiques et politiques. Clément, pour m'avoir fait visiter le coin de Paris le plus insolite, à savoir ta colocation. Guillaume, pour ton amour du FC Metz et ton autographe de Gilles Muller. Arthur, Bastien, Julien, Mathieu, Edouard, Samuel et tous ceux que j'ai oubliés pour tous les bons moments que l'on a passés ensemble.

Je remercie par ailleurs François, Thomas et Matthieu, ma "famille" des Mines, pour vous être tous orientés vers les mathématiques appliquées. Enfin, merci à Guillaume et toute la team vélo pour les week-ends sympathiques dans les Alpes auxquels j'ai pu participer en tant qu'accompagnateur.

J'en viens maintenant au plus important : la famille. Vous avez tous, tantes, oncles, cousines et cousins, su être présents quand cela fut nécessaire. J'ai une pensée particulière pour ma grand-tante Marie-Christine et mon grand-oncle André, pour les séances bridge et les vacances et week-ends passés en votre compagnie en terre tourangelle ou berrichonne qui m'ont notamment permis de décompresser. Je remercie mes grands-parents pour les valeurs et le savoir qu'ils ont pu m'apporter et me transmettre.

Enfin, je remercie tout particulièrement mes parents. Ma mère, pour m'avoir transmis le goût des mathématiques, pour la disponibilité dont tu as toujours fait preuve et pour faire partie des rares personnes qui liront en intégralité les pages qui suivront. Mon père, pour m'avoir toujours soutenu, pour avoir accepté le fait que la géologie et l'électronique ne soient pas mes principaux centres d'intérêt et pour avoir eu la chance de travailler à tes côtés pendant trois ans. Je n'aurais certainement pas réussi à en arriver jusque là sans vous ; ce travail vous est dédié.

Contents

1	Introduction	11
1.1	Presentation of the problem	11
1.1.1	Congestion in mobile data networks	11
1.1.2	Bilevel programming for pricing problems	12
1.1.3	Tropical geometry for economic problems	13
1.2	Main contributions	14
1.2.1	A tropical approach to bilevel programming	15
1.2.2	An application to a congestion problem in mobile data networks	18
2	Introduction (version française)	21
2.1	Présentation du problème	21
2.1.1	Congestion dans les réseaux de données mobiles	21
2.1.2	La programmation bi-niveau appliquée à la tarification	22
2.1.3	Géométrie tropicale appliquée à l'économie	23
2.2	Principales contributions	24
2.2.1	Une approche tropicale de la programmation bi-niveau	25
2.2.2	Une application à un problème de congestion dans les réseaux de données mobiles	29
3	Preliminaries	33
3.1	Bilevel programming	33
3.2	Polyhedra, polyhedral complexes and subdivisions	37
3.3	Tropical geometry	38
3.4	Discrete convexity	46
I	Tropical approach to bilevel programming	51
4	Tropical representation of bilevel programs	53
4.1	A special class of bilevel problems	53

4.2	A tropical approach for the bilevel problem	57
4.2.1	Low-level problem as a tropical polynomial	57
4.2.2	Tropical interpretation of Problem 4.1	62
4.2.3	Tropical interpretation of Problem 4.2	69
4.2.4	Tropical interpretation of Problem 4.3	73
4.2.5	An example	75
4.3	Generalization of the tropical approach	77
4.3.1	Generalization of the low-level problem	77
4.3.2	Generalization of the high-level problem	79
5	Cell enumeration applied to bilevel programming: general complexity results	81
5.1	Enumerating the cells	84
5.1.1	Determining the epigraph	84
5.1.2	Algorithm for enumerating the cells of \mathcal{S}	85
5.2	Counting the number of cells	87
5.2.1	General upper bounds	87
5.2.2	Specific upper bounds for the simplex	89
5.3	Fixed-parameter tractability	92
5.4	Discussion of the results	94
6	Structured classes of bilevel problems	97
6.1	Arrangement of tropical hypersurfaces	98
6.1.1	Bilevel problem with separable low-levels	98
6.1.2	Number of apices of a tropical hypersurface	101
6.1.3	Upper bounds on the number of cells	102
6.2	A particular case: f does not depend on y	103
6.3	A balancing problem in economics	107
6.3.1	A congestion problem	107
6.3.2	Generalization of the congestion problem	108
6.4	Comparison with a competitive equilibrium problem	111
6.4.1	The problem of competitive equilibrium	111
6.4.2	Comparison between the competitive equilibrium problem and the congestion problem	112
6.4.3	Congestion problem as a limit of competitive equilibrium problems	113
II	Application to a telecom problem	119
7	A bilevel model for price incentives in telecommunications network	121
7.1	Introduction	121
7.2	A bilevel model	123
7.3	A polynomial time algorithm for solving the first model	126
7.3.1	A tropical interpretation	128
7.3.2	Decomposition theorem	130
7.4	An efficient algorithm for solving the bilevel problem	137
7.4.1	A polynomial time algorithm for the bilevel problem	137
7.4.2	A particular case : theory of majorization	143
7.5	The general algorithm	148

7.6	Experimental results	152
7.7	Conclusion	153
8	Perspectives	157
8.1	A branch-and-bound algorithm for a class of bilevel problems	157
8.2	Best possible upper bounds for the number of cells	158
8.3	Bounded price incentives for the congestion problem	158
8.4	A stochastic model for the congestion problem	159
A	Compactification of a polyhedron to enumerate its faces	161
A.1	Enumerating the faces	161
A.2	Estimating the number of faces	167
B	Proof of Theorem 6.5	169
B.1	Sketch of the proof	169
B.2	Proof	170
C	Congestion problem with bounded prices	175
	Bibliography	181

CHAPTER 1

Introduction

1.1 Presentation of the problem

1.1.1 Congestion in mobile data networks

The development of new mobile data technologies (3G, 4G, and in a coming future 5G) offers new possibilities for mobile data usage, owing to faster rates. As a consequence, the demand for using the Internet with mobile phones has increased rapidly. Cisco claims in its annual report ([Cis17]) that the mobile data traffic in the world was $7,2 \times 10^{18}$ bytes per month at the end of 2016. It grew 63 % since the end of 2015 and 1700 % since the end of 2011. Consequently, *mobile service providers* (MSP) have to confront and to anticipate congestion problems in the networks, in order to guarantee a sufficient *quality of service* (QoS).

Several approaches have been developed to improve the QoS, coming from different fields of the telecommunication engineering and economics. For instance, one can refer to Bonald and Feuillet [BF13] for some models of performance analysis to optimize the network to improve the quality of service (QoS). One of the promising alternatives to solve such problems consists of using efficient pricing schemes that encourages customers to shift their mobile data consumption. In [MT06], Maillé and Tuffin describe a mechanism of auctions based on game-theoretic methods for pricing an Internet network, see also [MT14]. In [ABEA⁺06], Altman et al. study how to price different services by using a noncooperative game. These different approaches are based on congestion games. In the present work, we are interested in how a MSP can improve the QoS by balancing the traffic in the network. We wish to determine in which locations, and at which time instants, it is relevant to propose price incentives, and to evaluate the influence of these

incentives on the quality of service.

This kind of problem belongs to smart data pricing. We refer the reader to the survey of Sen et al. [SJWHC13] and also to the collection of articles [SJWHC14]. Finding efficient pricing schemes is a revenue management issue. The first approach consists of usage-based pricing; the prices are fixed monthly by analyzing the use of the former months. It is possible to improve this scheme. The MSP identifies peak hours and non-peak hours. He proposes discounts in non-peak hours to incite the users to consume during these hours. This decreases the demand at peak hours. The MSP balances hence the network and uses better the network capacity at non-peak hours. This leads to time-dependent pricing. Such a scheme for mobile data is developed by Ha et al. in [HSJW⁺12]. The prices are determined at different time slots and based on the usage of the previous day to maximize the utility of the customers and the revenue of the provider. This pricing scheme was concretely implemented by AT&T, showing the relevance of such a model. In another approach, Tadrous et al. propose a model in which the MSP anticipates peak hours and determines incentives for proactive downloads [TEEG13].

The latter models concern only the time aspects. One must also take into account the spatial aspect to optimize the demand between the different locations. In [MLH14], Ma, Liu and Huang present a model depending on time and location of the customers where the MSP proposes prices and optimizes his profit taking into account the utility of the customers.

1.1.2 Bilevel programming for pricing problems

Similarly as in [MLH14], we assume that the MSP proposes incentives at different time and places. Then, customers optimize their data consumption by knowing these incentives and the MSP optimizes a measure of the QoS. In this way, we introduce a bilevel model in which the provider proposes incentives to balance the traffic in the network and to avoid as much as possible the congestion (high level problem), and customers optimize their own consumption for the given incentives (low level problem).

Bilevel programming deals with nested optimization problems involving two players. A leader announces a decision to a follower, who responds by selecting a solution of an optimization problem whose data depend on this decision (low level problem). The optimal decision of the leader is the solution of another optimization problem whose data depend on the follower's response (high level problem). When the follower's response is not unique, one distinguishes between optimistic and pessimistic bilevel problems, in which the leader takes into account the best or worst possible response of the follower.

Bilevel programming problems represent an important class of pricing problems in sense that they model a leader wanting to maximize his profit and proposing prices to some followers who maximize themselves their own utility. Labbé et al. ([LMS98]) and Brotcorne et al. ([BLMS01]) propose a bilevel model for a taxation scheme, which is used for a toll-setting problem in a multicommodity transportation network. Brotcorne et al. ([BLMS00]) present an application for a freight tariff-setting problem. Larsson and Patriksson ([LP98]) present a bilevel model to limit the traffic congestion. For energy pricing, Bard et al. ([BPS00]) propose a bilevel model for the minimization of tax credits a government allows to biofuel producers. In telecommunications networks, Ma et al. ([MLH14]) consider a bilevel model for smart data pricing in mobile networks, depending on the mobility of the users.

Bilevel programming is a well-studied topic in optimization. Bard ([Bar13]) and Dempe ([Dem02]) devote books to bilevel programming, presenting the main theoretical aspects, algorithms and applications. In [Dem03a], Dempe wrote an annotated bibliography on methods and

applications concerning bilevel optimization. Moreover, different surveys ([CMS07], [SMD17]) present also these aspects.

Most classes of bilevel programs are nevertheless known to be NP-hard. Jeroslow ([Jer85]) shows that even when the leader's and the follower's optimization problems are linear programs, bilevel problems are generally NP-hard, and if we deal with mixed-integer programs, bilevel problems can be Σ_2^P -hard. Several methods have been introduced to solve such problems. For instance, if the low-level program is convex, it can be replaced by its Karush-Kuhn-Tucker optimality conditions (see [BV04, Section 5.5.3]) and the bilevel problem is replaced by a classical one-stage optimization problem, which is nevertheless generally non convex. If some variables are binary or discrete, and the objective function is linear, the global bilevel problem can be rewritten as a mixed integer program, as in Brotcorne et al. [BLMS00].

In the present work, we optimize the consumption of each customer in a large area (large urban agglomerations) during typically one day divided in time slots of one hour, taking into account the different types of customers and of applications that they use. Therefore, we have to confront both with the difficulties inherent to bilevel programming and with the large number of variables (around 10^7). Hence, we need to find polynomial time algorithms, or fast approximate methods, for classes of large-scale problems. If these problems were treated directly, they would lead to mixed integer linear or nonlinear programming formulations beyond the capacities of current off-the-shelf solvers.

1.1.3 Tropical geometry for economic problems

The difficulty to solve bilevel problems motivates us to introduce a different approach, based on tropical geometry. Tropical mathematics refers to the study of the max-plus semifield \mathbb{R}_{\max} , that is the set $\mathbb{R} \cup \{-\infty\}$ endowed with two laws \oplus and \odot defined by $\forall a, b \in \mathbb{R}_{\max}, a \oplus b = \max(a, b)$ and $a \odot b = a + b$. The reader can refer to [BCOQ92, But10] for more details about max-plus algebra and its application to discrete event systems, and to [IMS09, MS15] for detailed introductions of tropical geometry.

The tropical analogue to the classical polynomial functions correspond to the convex piecewise linear functions with integer slopes. The set of points in which such a function is not differentiable is called a tropical hypersurface. The epigraph of a tropical polynomial in n variables is then a $n + 1$ -dimensional polyhedron, and the projection of the graph of a tropical polynomial over the n first coordinates defines a polyhedral complex, which subdivides \mathbb{R}^n in different cells. We recall some essential notions of tropical geometry in Section 3.3.

Tropical geometry methods have been recently applied by Baldwin and Klemperer in [BK12] to the product-mix auction (see also [BK15]). This has been further developed by Tran and Yu [TY15]. Product-mix auctions (introduced by Klemperer [Kle10]) can be formulated as follows. Some agents have preferences for buying a set of bundles of differentiate goods. The price of the goods is the same for all agents. We assume that the total supply is fixed. Then, the sum of purchases of all the agents has to be equal to the total supply. The problem is to know whether there exists a price vector for the goods such that the sum of purchases of the different agents is equal to the total supply, when each agent chooses his purchase by maximizing his own preferences. Such a price is called a competitive equilibrium. In the approach of Baldwin and Klemperer, the value of the preference maximization problem of each agent corresponds to the evaluation of a tropical polynomial. Hence, the response of an agent to a price is represented by a certain polyhedral complex (arrangement of tropical hypersurfaces). This approach is intuitive since it allows one to visualize geometrically the behavior of the agents: each cell of the complex

corresponds to the set of prices leading to a given response. Then, we visualize the collective response of a group of customers by "superposing" (refining) the polyhedral complexes attached to every agent in this group. Baldwin and Klemperer [BK12], and further Tran and Yu [TY15] give a necessary and sufficient condition on the preference cost function of the different agents for the existence of a competitive equilibrium. This result is related with earlier work of Danilov, Koshevoy and Murota [DKM01], who obtained the same result for a competitive equilibrium in Walrasian economy with discrete convexity methods.

There exist many other applications of tropical geometry to economics and game theory. Crowell and Tran [CT16] use tropical algebra and geometry for mechanism design. It consists for an institution in incentivizing the economic agents to reveal truthfully their preferences, to attain an equilibrium for all agents. Recently, the Ricardian trade theory was related with tropical algebra [Shi15], and Joswig [Jos17] describes the problem in terms of arrangement of tropical hypersurfaces by using the Cayley trick. Bricc and Horvath [BH08] study the existence of Nash equilibria for games in which the players have \mathbb{B} -convex utility functions. \mathbb{B} -convexity is an analogue of tropical convexity. In more recent work, Bricc and Horvath [BHL13] study Nash equilibrium existence for other classes of utility functions, called quasi-Leontief, which are additive in tropical algebra. Tropical geometry is a relevant approach to study other game theoretical problems. For instance, Akian, Guterman and Gaubert [AGG12] show the equivalence between zero-sum two player stochastic games and the external representation of tropical convex sets.

1.2 Main contributions

In the present work, we study a class of bilevel problems in which the low-level problem can be interpreted as a tropical polynomial. We use similar techniques as Baldwin, Klemperer [BK12], Tran and Yu [TY15] to describe the response of the low-level optimizer to the high-level decision variable as a polyhedral complex. Such an approach applies in particular to the congestion problem in mobile data networks presented earlier. In this case, the low-level problem corresponds to the optimization problem of the different users. Hence, the low-level dimension (linear in the number of users) can be very large.

We provide algorithms whose time complexity is polynomial in the low-level dimension.

- We first develop a general *decomposition method* to study our class of bilevel problems. In this method, the value of the bilevel problem corresponds to the minimum value of a large number of optimization subproblems, each of this subproblem corresponding to a cell of a polyhedral complex.
- We next show that this method leads to an algorithm for solving the different bilevel problems. By using classical results about the combinatorics of polyhedral subdivisions, we provide some upper bounds about the time complexity of the algorithm. We show that this complexity is polynomial in the low-level dimension and in certain metric estimates when the high-level dimension is fixed.
- We next introduce some subclasses in which the enumeration of the cells of a complex polyhedral is not required. It leads to other algorithms which run in *polynomial time* in both high-level and low-level dimensions.
- We finally study the congestion problem in mobile data networks, and show it belongs to the previous subclass. We use the specific structure of this problem to propose *polynomial*

time algorithms which are efficient for large values of the low-level dimension. We propose a heuristic based on these algorithms for realistic telecom models, and validate our results on real data provided by Orange.

In Chapter 3, we recall some classical notions for background. We present bilevel problems and their relation with Stackelberg equilibria. We recall standard complexity results, and present the classical methods to solve them. Next, we deal with the notions of polyhedron, polyhedral complex and polyhedral subdivisions. We mention some definitions and study the combinatorics of such objects, that is we recall some classical relations between the number of faces of each dimension in polyhedra, or equivalently between the number of cells of polyhedral complexes. In a third part, we present tropical geometry. We explain the notion of tropical polynomial together with its associated tropical hypersurface. We recall the definition of Newton polytopes and the bijection between the polyhedral complex defined by a tropical hypersurface and a regular subdivision of the associated Newton polytope. We mention some results about these subdivisions. We focus on the case of arrangement of tropical hypersurfaces, and recall a classical result of algebraic geometry called the BKK theorem. Finally, we deal with discrete convexity and in particular with M -convex functions. We recall the equivalence between local and global optimality for M -convex functions. We recall also that the minimization of M -convex functions can be done in polynomial time. We also give some examples of classical classes of M -convex functions.

1.2.1 A tropical approach to bilevel programming

Chapter 4 is devoted to the study of a specific class of bilevel problems, which corresponds to a real economic situation. A producer wants to sell n different goods to a customer. The price of each good is denoted by $-y \in \mathbb{R}^n$, where $-y_j$ (for each $j \in [n]$) is the price of good j . However, he sells the different goods in k different bundles. We define the matrix $C \in \mathcal{M}_{k,n}(\mathbb{R})$ such that for each $i \in [k]$, $j \in [n]$, c_{ij} is the quantity of good j in bundle i . Hence, the price vector of the different bundles is $-Cy \in \mathbb{R}^k$. We denote by $x \in \mathbb{R}^k$ the purchase of the customer, that is $x_i \in \mathbb{R}$ denotes the quantity of bundle i bought by the customer. The constraints of the customer are linear, and we modeled them by $x \in \mathcal{P}$, where \mathcal{P} is a polytope of \mathbb{R}^k . The quantity of goods sold by the producer corresponds consequently to the vector $C^T x$. For a fixed price vector $-y \in \mathbb{R}^n$, the customer maximizes his utility. He has a preference vector $\rho \in \mathbb{R}^k$ ($\rho_i \in \mathbb{R}$ is a measure of the preference of the customer for buying the bundle i). He determines his consumption $x^* \in \mathbb{R}^k$ such that:

$$x^* \in \arg \max_{x \in \mathcal{P}} \langle \rho + Cy, x \rangle$$

The producer desires to minimize his costs, depending on the quantity $C^T x^*$ of sales and on the proposed price. He solves:

$$\min_{y \in \mathbb{R}^n} f(C^T x^*, y)$$

where x^* is the consumption of the customer. The latter corresponds to a *continuous bilevel problem*. We also study a *discrete bilevel problem*, corresponding the case of indivisible goods. This means that the matrix C has integer coefficients, and the consumption x of the customer is constrained to belong to the integer points of \mathcal{P} . In this sense, the low-level decision variable x is discrete, and the high-level decision variable y is continuous. We deal with both optimistic and pessimistic versions of the different bilevel problems we introduced.

The low-level problem of this bilevel program corresponds to a tropical polynomial Q defined by $Q(y) = \max_{x \in C^T \mathcal{P}} \langle y, C^T x \rangle + \langle \rho, x \rangle$. Similarly to what is done in the work of Baldwin and Klemperer [BK12] and Tran and Yu [TY15], the response of the customer defines a polyhedral complex \mathcal{S} . This complex is dual to a regular subdivision \mathcal{S}' of the Newton polytope of Q , in sense that there exists a bijection ϕ between the cells of \mathcal{S} and \mathcal{S}' . This bijection means that for each $\mathcal{C} \in \mathcal{S}$, the elements of $\phi(\mathcal{C})$ attains the maximum in $Q(y)$ for each $y \in \mathcal{C}$. This decomposition of the response of the customers into a polyhedral complex leads us to the following result.

Theorem 1.1 (Reduction of optimistic bilevel programming to cell enumeration). *Assume that for every $y \in \mathbb{R}^n$, the function $z \mapsto f(z, y)$ is lower semicontinuous. Then, the optimistic version of the continuous bilevel programming problem 4.1 is equivalent to the following problem:*

$$\min_{\mathcal{C} \in \mathcal{S}} \left[\inf_{y \in \mathcal{C}} \min_{z \in \phi(\mathcal{C})} f(z, y) \right].$$

Moreover, if the function f is jointly lower semicontinuous in (z, y) , and is inf-compact over each set $\phi(\mathcal{C}) \times \mathcal{C}$, then an optimistic solution exists.

A similar result for the pessimistic version can be written. However, the pessimistic solution of a bilevel problem is not always feasible. One can guarantee approximate solutions. We say that a feasible solution of an optimization problem is an ε -solution if the difference between the value function at this feasible solution and the optimal value of the problem is less than or equal to ε .

Theorem 1.2 (Reduction of pessimistic bilevel programming to cell enumeration). *Suppose that for each $\mathcal{C} \in \mathcal{S}$, the function f is continuous over $\phi(\mathcal{C}) \times \mathcal{C}$. Then, the value of the pessimistic version of the continuous bilevel problem 4.1 is given by:*

$$\min_{\mathcal{C} \in \mathcal{S}} \left[\inf_{y \in \mathcal{C}} \max_{z \in \phi(\mathcal{C})} f(z, y) \right]. \quad (1.1)$$

If f is additionally inf-compact, then the problem defined by (1.1) has an optimal solution, and there exists an ε -solution of the pessimistic version of Problem 4.1.

For the discrete bilevel problem, we prove similar theorems under a total unimodularity assumption of the matrix C and the polytope \mathcal{P} . To conclude this chapter, we present two generalizations of the class of studied bilevel problems. We show that some results remain for discrete problems when the weight function of the tropical polynomial Q is any concave function, and we study also how we can generalize the high-level function by removing the dependance on the matrix C .

In Chapter 5, we study how the different reductions established in Theorem 1.1 and Theorem 1.2 lead to an algorithm for solving both continuous and discrete bilevel problems. We have first to enumerate the different cells of the polyhedral complex associated to the tropical polynomial defined by the low-level problem. Next, we have to determine the dual cells, belonging to a regular subdivision of the associated Newton polytope. Finally, we solve an optimization problem associated to each cell. We show that the enumeration of the cells of such a polyhedral complex is equivalent to the enumeration of the faces of a polyhedron. By using a classical algorithm developed by Fukuda, Liebling and Margot [FLM97], we write an algorithm which enumerates the cells of \mathcal{S} and give the corresponding dual cells in \mathcal{S}' . The complexity of this algorithm depends on combinatorial parameters of the polyhedral complex, such that its

number of faces of each dimension. We next find some upper bounds to these different combinatorial parameters, and mention particular cases for which we find optimal upper bounds. As a consequence, the time complexity of our algorithm depends polynomially of the dimension of the low-level problem and of a metric estimate of the polytope $C^T\mathcal{P}$ (typically the radius of the polyhedral sphere), when the dimension of the high-level problem is fixed. Then, if each subproblem is fixed-parameter tractable, meaning that it can be solved in polynomial time when the high-level problem dimension is fixed, we prove the following result:

Theorem 1.3 (Fixed parameter tractability of bilevel problems). *Assume that an ε -solution of each subproblem can be obtained in polynomial time when the high-level dimension is fixed. Then, an ε -solution of both continuous and discrete bilevel problems can be obtained in polynomial time in the low-level dimension and a metric estimate of $C^T\mathcal{P}$, when the high-level dimension is fixed.*

In Chapter 6, we deal with some particular subclasses of the problem studied in Chapter 4. First, we show that our problem can model a situation in which the producer sells his products to a large set of customers. The previous results make sense for this problem because the low-level dimension is much larger than the high-level dimension, if the number of customers is large. This problem has a particular structure in which \mathcal{P} can be decomposed as a cartesian product of polytopes, each one being the feasible set of one customer. The sales of the producer are just the sum of the consumptions of all the customers, meaning that the polytope $C^T\mathcal{P}$ is the Minkowski sum of the polytopes corresponding to the feasible set of the customers. As a consequence, the polyhedral complex defined by the low-level corresponds to an arrangement of tropical hypersurfaces, each being associated to the response of a particular customer, and the dual subdivision of the Newton polytope is a mixed subdivision. We use this structure to improve an upper bound given in Chapter 4 by using the notion of mixed volume. Then, we deal with another particular subclass, in which the profit of the producer does not depend on the price. This means that the high-level function f becomes $f(C^T x^*)$. We prove the following theorem concerning the optimistic solution of the bilevel problem.

Theorem 1.4 (Decomposition theorem for the continuous bilevel problem). *Assume that f is lower semicontinuous. Then, the optimistic version of the continuous bilevel problem 4.1 is equivalent to:*

- Find $z^* \in \arg \min_{z \in C^T\mathcal{P}} f(z)$.
- Find $x^* \in \arg \max_{x \in \mathcal{P}, C^T x = z} \langle \rho, x \rangle$.
- Find $y^* \in \phi^{-1}(C'_{z^*})$, where C'_{z^*} is the intersection of all the cells of the dual subdivision \mathcal{S}' containing z^* .

This theorem means that the optimistic value of the bilevel problem can be obtained by solving three optimization problems, instead of taking the minimum value of a large number of subproblems associated to the cells of a polyhedral complex. The second part is a linear programming problem, which can be solved in polynomial time in the low-level dimension thanks to interior point methods (see the original work of Karmarkar [Kar84] and also the article of Renegar [Ren88]). The third part consists of finding a point in the subdifferential of a piecewise-linear convex map at z^* . This point can be obtained by solving a dual linear program, which can be done in polynomial time by interior point methods or by ellipsoid methods (see the article of Grötschel, Lovasz and Schrijver [GLS81], which reformulates the original work of Khachiyan [Kha79]). If the function f is linear or convex, then an ε -solution of the first part can also

be obtained in polynomial time by the ellipsoid method. Hence, the global optimistic bilevel problem can be solved in polynomial time.

Such a theorem is still valid for the discrete problem under a total unimodularity assumption. Both second and third parts of the previous theorem are integer linear programs whose value is equal to their continuous relaxations. They can consequently be solved in polynomial time. We show that if f belongs to a certain class of discrete convex functions, called M^{\natural} -convex functions, the first part can also be solved in polynomial time.

Finally, we study an economic situation corresponding to a balancing problem, in which a producer proposes rewards to the different customers to balance his sales of the different goods. This corresponds to both subclasses studied in this chapter, in the discrete case. We generalize the low-level cost functions of the customers to discrete concave functions instead of linear ones. This refers to the unimodularity theorem of Baldwin and Klemperer [BK12]. We show that we can solve this problem in polynomial time in both low-level and high-level dimensions problem. We recall the competitive equilibrium problem for indivisible goods introduced by Danilov, Koshevoy and Murota [DKM01], and define a class of parametrized competitive equilibrium problems of this type. We show that the bilevel problem we deal with can be interpreted as a competitive equilibrium in which the profit of the producer does not depend on the price he proposes. We also show that the bilevel solution is a limit of the competitive equilibria belonging to the parametric class we introduced, when the parameter goes to zero.

1.2.2 An application to a congestion problem in mobile data networks

In Chapter 7, we deal with the congestion problem in mobile data networks we presented earlier. We consider a cellular network that we divide in L cells (to avoid any confusion with the notion of cells of a polyhedral complex, we use the term "location" instead of "cell"). We divide the day in T time slots. A mobile service provider (MSP) proposes in advance the discount vector y , that is $y(t, l) \in \mathbb{R}$ is the reward offered by the provider to the K different users of the network. at time t and in location l . We model the consumption of user $k \in [K]$ by a binary vector $u_k \in \{0; 1\}^{T \times L}$, with $u_k(t, l) = 1$ if user k does a request at time t in location l and $u_k(t, l) = 0$ otherwise. We assume he wants to do a fixed number of requests R_k . We also assume he has a fixed trajectory, meaning that $u_k(t, l) = 0$ if the location l is not visited by user k at time t . Moreover, we assume that he is unavailable at certain time slots. Then, there is a set \mathcal{J}_k of couples (t, l) such that $u_k(t, l)$ is constrained to be equal to 0. It means that the feasible set of consumptions of each user is $F_k = \{u_k \in \{0; 1\}^{T \times L} \mid \sum_{t,l} u_k(t, l) = R_k, \forall (t, l) \in \mathcal{J}_k, u_k(t, l) = 0\}$. It corresponds to both integer of extreme points of $(n - \#\mathcal{J}_k)$ -dimensional hypersimplex. Each user has a preference vector $\rho_k \in \mathbb{R}^{T \times L}$ which measures his utility to consume at time t and location l . Hence, he determines his optimal consumption u_k^* such that:

$$u_k^* \in \arg \max_{u_k \in F_k} \langle \rho_k + y, u_k \rangle.$$

The MSP desires to balance the network, that is to minimize a measure of congestion in the network. He determines the global consumption $N = \sum_k u_k^*$. This represents the number of active users at each time and in each place. We hence suppose that f is a concave function depending only on N , and more precisely we consider $f(N) = \sum_{t,l} f_{t,l}(N(t, l))$, that is f is a sum of univariate concave functions depending on the number of active users at each time t and in each place l . Then, the provider proposes the discounts to minimize the congestion, that is

he solves the following maximization problem.

$$\max_{y \in \mathbb{R}^{T \times L}} f(N),$$

with $N = \sum_k u_k^*$ and u_k^* is the response of user k to the discounts announced by the Internet service provider.

This defines a discrete bilevel programming problem, that we call the *congestion problem*. More precisely, this corresponds to a particular subclass studied in Chapter 6. The high-level function does not depend on the rewards of the provider. There is a large set of customers, and the response of each customer to the reward is a tropical polynomial. Finally, the possible consumptions of each customers are the integer points of an integer polytope. The decomposition theorem 1.4, proved in Chapter 6, can be applied to the congestion problem.

Theorem 1.5 (Decomposition theorem for a congestion problem). *The optimistic congestion problem can be solved as follows:*

1. Find an optimal solution N^* to the high level problem with unknown N :

$$\max_{N \in \sum_k F_k} \sum_{t,l} f_{t,l}(N(t,l)) \quad s.t. \quad \forall(t,l), N(t,l) \leq N^C(t,l) .$$

2. Find vectors (u_1^*, \dots, u_K^*) solutions of the following problem:

$$\max_{\substack{u_1 \in F_1, \dots, u_K \in F_K \\ \sum_k u_k = N^*}} \sum_k \langle \rho_k, u_k \rangle .$$

3. Find a vector y^* such that $\forall k, u_k^*$ is a solution of the low level problem.

The results of Chapter 6 show that this problem can be solved in polynomial time. However, to apply this model to networks with a large number of users, we have to limit the power of K (the number of users) in the complexity of the algorithm we propose to solve this problem. We show that the high-level problem corresponds to a minimization of an M -convex function. To compute a minimum, we use a greedy algorithm proposed by Murota [Mur03]. It consists of finding the minimal value and a minimizer of the function in a certain neighborhood of an initial point. If the obtained minimal value is less than the value of the function at the initial point, we take the minimizer as new initial point. If not, then the initial point is a global minimizer of the function. However in our problem, we have to know if an integer point $N \in \mathbb{Z}^{T \times L}$ belongs to $\sum_k F_k$ or not. This problem, as well as the problem of finding an optimal discount vector y^* when the optimal consumptions u_k^* of each user are known, is a very large dimensional linear feasibility problem, It can be solved in polynomial time. However, it is not efficient in practice since the dimension is very large.

Nevertheless, we show that we can solve our problem more efficiently. We assume that we know an initial point $N \in \sum_k F_k$ with its optimal decomposition in users consumptions $N = \sum_k u_k^*$. We consider a point N' of the neighborhood of N (same neighborhood as Murota's algorithm). We show that by solving a shortest path problem in a graph, we can decide whether N' belongs to $\sum_k F_k$ or not, and if it does, the optimal consumptions u_k^* of each user and the discount vector y^* that the provider has to propose to have a total number of users equal to N' . This comes essentially from the special structure (integer points of hypersimplices) of the

feasible set of each user. It leads to a polynomial time algorithm for solving the bilevel problem, which can be adapted to models with a large number of users. Moreover, we study a particular case in which we accelerate the previous algorithm by using the theory of majorization (see Marshall and Olkin [OM79]).

Next, we deal with a more realistic telecom model, taking into account different kinds of applications used by the customers, and different types of users depending on their contracts with the Internet service provider. We show that in a simple case with one type of applications and one type of user, this telecom model corresponds to the bilevel problem studied previously in this chapter. We propose an approximate method: for each application and each type of user, we solve the previous bilevel problem by fixing all the variables which concern other types of applications or users, and repeat this as long as possible

We finally present the application of this model on real data from Orange and show how price incentives can improve the QoS by balancing the number of active customers in an urban agglomeration during one day. These results indicate that a price incentive mechanism can effectively improve the satisfaction of the users by displacing their consumption from the most loaded regions of the space-time domain to less loaded regions.

In Chapter 8, we present to conclude some perspectives of this work. We suggest to develop branch-and-bound algorithms to make the method presented in Chapter 4 efficient in practice. The idea is to avoid to explore all the cells of the polyhedral complex. Next, we come back to our congestion problem in telecom networks and propose to add lower and upper bounds to the set of possible discounts, to reduce the expenses of the provider. Finally, we explain why stochastic models could also be considered for the congestion problem in mobile data networks, to propose real-time incentives.

In Appendix A, we present another method to enumerate the faces of a polyhedron. We compare this method to the approach developed in Chapter 5. Appendix B is devoted to a proof of one theorem dealing with providing an upper bound to the number of apices of arrangements of tropical hypersurfaces. Finally, in Appendix C, we provide some results concerning a variant of the congestion problem in telecommunications presented in Chapter 8 (bounded price incentives).

CHAPITRE 2

Introduction (version française)

2.1 Présentation du problème

2.1.1 Congestion dans les réseaux de données mobiles

Le développement de nouvelles technologies (la 3G, 4G, et dans un futur proche la 5G) offre de nouvelles possibilités pour l'usage des données mobiles, permettant d'atteindre des débits plus élevés. Par conséquent, la demande pour l'usage d'Internet par les smartphones a rapidement augmenté. Cisco établit dans son rapport annuel ([Cis17]) que le trafic mondial de données mobiles s'élevait à $7,2 \times 10^{18}$ octets par mois à la fin de l'année 2016. Ce trafic avait augmenté de 63 % depuis la fin de l'année 2015 et de 1700 % depuis la fin de l'année 2011. Par conséquent, les *opérateurs de réseaux mobiles* (MNO) sont confrontés à des problèmes de congestion dans les réseaux qu'ils doivent anticiper afin de garantir une *qualité de service* (QoS) suffisante.

Différentes approches ont été développées pour améliorer la QoS, provenant de différents domaines de l'économie et de l'ingénierie des télécommunications. Par exemple, on peut se référer à Bonald et Feuillet [BF13] pour des modèles d'analyse de performance afin d'optimiser le réseau pour améliorer la qualité de service (QoS). Une des alternatives les plus prometteuses pour résoudre de tels problèmes consiste à utiliser des schémas de tarifications efficaces qui encouragent les utilisateurs à déplacer leur consommation de données mobiles. Dans [MT06], Maillé et Tuffin décrivent un mécanisme d'enchères basé sur des méthodes issues de la théorie des jeux pour tarifier le réseau Internet, voir aussi [MT14]. Dans [ABEA⁺06], Altman et al. étudient comment tarifier différents services via un jeu noncoopératif. Ces différentes approches sont basées sur des jeux de congestion. Dans le présent travail, nous nous intéressons à comment

un opérateur de réseau mobile peut améliorer la qualité de service en équilibrant le trafic dans le réseau. Nous souhaitons déterminer en quels lieux et à quels instants il est pertinent de proposer des incitations tarifaires, ainsi qu'évaluer l'influence d'un tel schéma sur la qualité de service.

Il s'agit d'un problème de tarification intelligente des données. Le lecteur peut se référer au survol de Sen et al. [SJWHC13], ainsi qu'à la collection d'articles [SJWHC14]. Trouver des schémas efficaces de tarification est un problème de *revenue management*. Une première approche est le pricing basé sur la consommation ; les prix sont fixés mensuellement en analysant la consommation des mois précédents. Il est possible d'améliorer ce schéma en identifiant des heures pleines (présentant un pic de consommation) et des heures creuses. L'opérateur propose alors des réductions en heures creuses afin d'inciter les usagers à consommer durant ces heures là. Ainsi, la demande aux heures pleines diminue et les pics sont réduits. L'opérateur équilibre donc le réseau et utilise mieux sa capacité aux heures creuses. Cela amène à une tarification dépendante du temps. Un tel schéma pour les données mobiles a été développé par Ha et al. in [HSJW⁺12]. Les prix sont déterminés à différents instants pour maximiser l'utilité des usagers et le revenu de l'opérateur. Ils sont basés sur la consommation des clients le jour précédent. Ce schéma tarifaire a été implémenté par AT&T sur des données réelles, montrant la pertinence d'un tel modèle. Dans une autre approche, Tadrous et al. proposent un modèle dans lequel l'opérateur prévoit les pics de consommation et incite les usagers à anticiper leurs téléchargements par des réductions [TEEG13].

Ces différents modèles ne traitent que d'aspects temporels. Cependant, nous devons prendre en compte la mobilité des usagers pour optimiser la demande entre les différents lieux. Dans [MLH14], Ma, Liu et Huang présentent un modèle dépendant du temps et des positions des usagers dans lequel l'opérateur propose des prix et maximise son profit ainsi que l'utilité des clients.

2.1.2 La programmation bi-niveau appliquée à la tarification

De la même manière que dans [MLH14], nous supposons que l'opérateur propose des incitations tarifaires en divers pas de temps et divers lieux. Ainsi, les clients optimisent leur consommation de données en connaissant ces incitations et l'opérateur optimise une mesure de la qualité de service. En ce sens, nous introduisons un modèle bi-niveau dans lequel l'opérateur propose des réductions destinées à équilibrer le trafic dans le réseau et d'éviter la congestion autant que possible (problème de niveau haut). Les clients optimisent leur propre consommation pour des réductions données (problème de niveau bas).

La programmation bi-niveau se réfère à l'étude de problèmes d'optimisation "emboîtés" impliquant deux joueurs. Un meneur annonce sa décision au suiveur, qui répond en choisissant une solution d'un problème d'optimisation dont les données dépendent de la décision du meneur (problème de niveau bas). La décision optimale du meneur est la solution d'un autre problème d'optimisation dont les données dépendent de la réponse du suiveur (problème de niveau haut). Lorsque la réponse du suiveur n'est pas unique, on distingue les problèmes bi-niveau optimistes et pessimistes, dans lesquels le meneur considère respectivement la meilleure et la pire réponse possible du suiveur.

Les problèmes de programmation bi-niveau représentent une classe importante des problèmes de pricing car ils modélisent un meneur cherchant à maximiser son profit et proposant des prix à certains suiveurs qui maximisent eux-mêmes leur utilité. Labbé et al. ([LMS98]), ainsi que Brotcorne et al. ([BLMS01]), proposent un modèle bi-niveau pour un schéma de taxation dans les réseaux de transports multicommodité afin de prévoir où installer des péages. Brotcorne et

al. ([BLMS00]) présentent une application de ce schéma pour la tarification du fret. Larsson et Patriksson ([LP98]) proposent un modèle bi-niveau pour limiter la congestion du trafic. Dans l'énergie, Bard et al. ([BPS00]) proposent un modèle bi-niveau pour la minimisation des crédits d'impôts qu'un gouvernement peut allouer aux producteurs de biocarburants. Dans les réseaux de télécommunications, Ma et al. ([MLH14]) considèrent un modèle bi-niveau pour la tarification intelligente des données dans les réseaux mobiles, dépendant de la mobilité des usagers.

La programmation bi-niveau est un domaine bien étudié en optimisation. Bard ([Bar13]) et Dempe ([Dem02]) ont dédié des livres à ce domaine, présentant les principaux aspects théoriques, des algorithmes de résolution et des applications. Dans [Dem03a], Dempe a écrit une bibliographie annotée des méthodes et applications de l'optimisation bi-niveau. De plus, différents survols ([CMS07], [SMD17]) présentent également ces aspects.

La plupart des classes de problèmes bi-niveau sont néanmoins NP-difficiles. Jeroslow ([Jer85]) a montré que même lorsque les problèmes du meneur et du suiveur sont des programmes linéaires, les problèmes bi-niveau sont généralement NP-durs, et s'il s'agit de programmes linéaires en variables mixtes, les problèmes bi-niveau peuvent être Σ_2^P -difficiles. Plusieurs méthodes ont été introduites pour résoudre de tels problèmes. Par exemple, si le problème de niveau bas est convexe, il peut être remplacé par ses conditions d'optimalité de Karush-Kuhn-Tucker (voir [BV04, Section 5.5.3]) et le problème bi-niveau devient un problème d'optimisation classique à un niveau qui n'est cependant pas convexe de manière générale. Si certaines variables sont binaires ou discrètes, et que la fonction objectif du meneur est linéaire, le problème bi-niveau global peut être réécrit comme un problème en variables mixtes, comme le font Brotcorne et al. [BLMS00].

Dans ce travail, nous optimisons la consommation de chaque client dans une large zone (grandes agglomérations urbaines) pendant une journée divisée en intervalles d'une heure, en prenant en considération les différents types de clients et les différentes applications qu'ils utilisent. Nous avons ainsi à affronter à la fois les difficultés inhérentes à la programmation bi-niveau et le très grand nombre de variables (environ 10^7). Ainsi, nous avons besoin de trouver des algorithmes pour résoudre exactement ou de manière approximative des classes de problèmes bi-niveau en grande dimension en temps polynomial. Si nous traitons directement cette classe de problèmes par des méthodes usuelles, cela mènerait à des reformulations en variables mixtes, linéaires ou non, des problèmes bi-niveau qui ne sont pas traitables par les solveurs actuellement sur le marché.

2.1.3 Géométrie tropicale appliquée à l'économie

La difficulté à résoudre de tels problèmes bi-niveau nous incite à introduire une approche différente basée sur la géométrie tropicale. Les mathématiques tropicales désignent l'étude du semi-corps max-plus \mathbb{R}_{\max} , c'est-à-dire l'ensemble $\mathbb{R} \cup \{-\infty\}$ muni de deux lois \oplus et \odot définies par $\forall a, b \in \mathbb{R}_{\max}, a \oplus b = \max(a, b)$ et $a \odot b = a + b$. Le lecteur peut se référer à [BCOQ92, But10] pour plus de détails sur l'algèbre max-plus et ses applications à l'étude des systèmes à événements discrets, ainsi qu'à [IMS09, MS15] pour une introduction plus détaillée à la géométrie tropicale.

Les fonctions polynomiales classiques ont pour analogue tropical les fonctions convexes, affines par morceaux à pentes entières. L'ensemble des points en laquelle une telle fonction n'est pas différentiable est appelé une hypersurface tropicale. L'épigraphe d'un polynôme tropical en n variables est un polyèdre en dimension $n + 1$, et la projection du graphe d'un polynôme tropical sur les n premières coordonnées définit un complexe polyédral qui subdivise \mathbb{R}^n en différentes

cellules. Nous rappelons certaines notions essentielles de géométrie tropicale en Section 3.3.

La géométrie tropicale a récemment été appliquée par Baldwin et Klemperer dans [BK12] à des enchères pour l'assortiment de produits (see also [BK15]). Cela a ensuite été développé par Tran et Yu [TY15]. Un tel problème d'enchères (introduit par Klemperer [Kle10]) peut être formulé de la manière suivante. Différents agents économiques ont des préférences pour acheter un certain ensemble de biens. Le prix des biens est le même pour tous les agents. Nous supposons que la demande totale est fixée. Ainsi, la somme des achats des agents doit être égale à la demande totale. Le problème est de savoir s'il existe un vecteur de prix pour les différents biens tel que la somme des achats des différents agents est égale à la demande totale, lorsque chaque agent détermine ses achats en maximisant son utilité. Un tel prix est appelé un équilibre compétitif. Dans l'approche de Baldwin et Klemperer, la valeur du problème de maximisation de l'utilité de chaque agent correspond à l'évaluation d'un polynôme tropical. Ainsi, la réponse des agents à un certain prix est représentée par un certain complexe polyédral (arrangement d'hypersurfaces tropicales). Cette approche est intuitive puisqu'elle permet de visualiser géométriquement le comportement des différents agents : chaque cellule du complexe correspond à un ensemble de prix menant à une réponse donnée. Ainsi, il est possible de visualiser la réponse collective d'un groupe de clients en "superposant" les complexes polyédraux associés à chaque agent du groupe. Baldwin et Klemperer [BK12], puis Tran et Yu [TY15] ont donné une condition nécessaire et suffisante sur la fonction d'utilité des différents agents pour garantir l'existence d'un équilibre compétitif. Ce résultat est relié à un travail plus ancien de Danilov, Koshevoy et Murota [DKM01], qui obtinrent le même résultat pour un équilibre compétitif en économie Walrasienne grâce à des méthodes de convexité discrète.

Il existe beaucoup d'autres applications de la géométrie tropicale à l'économie et à la théorie des jeux. Crowell et Tran [CT16] ont utilisé l'algèbre et la géométrie tropicales pour les mécanismes d'incitation. Cela consiste pour une institution à inciter les agents économiques à révéler en toute confiance leurs préférences, afin d'obtenir un équilibre entre tous les agents. Plus récemment, la théorie ricardienne du commerce a été reliée à l'algèbre tropicale [Shi15], et Joswig [Jos17] décrit le problème en termes d'arrangements d'hypersurfaces tropicales en utilisant l'astuce de Cayley. Bricc et Horvath [BH08] ont étudié l'existence d'équilibres de Nash de jeux dans lesquels les joueurs ont des fonctions d'utilité \mathbb{B} -convexes. La \mathbb{B} -convexité est un analogue de la convexité tropicale. Dans un travail plus récent, Bricc et Horvath [BHL13] ont étudié l'existence d'un équilibre de Nash pour d'autres classes de fonctions d'utilité, appelées quasi-Leontief, qui sont additives pour l'algèbre tropicale. La géométrie tropicale est une approche pertinente pour l'étude d'autres problèmes issus de la théorie des jeux. Par exemple, Akian, Guterman et Gaubert [AGG12] ont montré l'équivalence entre jeux stochastiques à deux joueurs et à somme nulle et la représentation externe des ensembles tropicalement convexes.

2.2 Principales contributions

Dans cette thèse, nous étudions une classe de problèmes bi-niveau dans laquelle le problème de niveau bas peut être interprété comme un polynôme tropical. Nous utilisons des techniques semblables à celles de Baldwin, Klemperer [BK12], Tran et Yu [TY15] pour décrire la réponse du suiveur à la décision du meneur en termes de complexe polyédral. Une telle approche s'applique en particulier au problème de congestion dans les réseaux mobiles présenté précédemment. Dans ce cas, le problème de niveau bas correspond au problème d'optimisation des différents usagers. Ainsi, la dimension du niveau bas (linéaire en le nombre d'usagers) peut être très élevée.

Nous proposons des algorithmes dont la complexité en temps est polynomiale en la dimension du problème de niveau bas.

- Nous développons d'abord une *méthode de décomposition* pour étudier une classe générale de problèmes bi-niveaux. Dans cette méthode, la valeur du problème bi-niveau correspond au minimum d'un grand nombre de valeurs de sous-problèmes d'optimisation, chaque sous-problème étant associé à une cellule d'un certain complexe polyédral.
- Nous montrons ensuite que cette méthode mène à un algorithme pour résoudre les différents problèmes bi-niveaux étudiés. En utilisant des résultats classiques sur la combinatoire des subdivisions polyédrales, nous proposons des bornes supérieures sur la complexité temporelle de cet algorithme. Nous montrons que cette complexité est polynomiale en la dimension du problème bas et en une certaine estimation métrique lorsque la dimension du problème haut est fixée.
- Nous introduisons également plusieurs sous-classes de problèmes dans lesquelles l'énumération de toutes les cellules du complexe polyédral n'est pas nécessaire. Cela mène à d'autres algorithmes dont la complexité est *polynomiale* en les dimensions des deux problèmes (de niveau haut et de niveau bas).
- Nous étudions enfin le problème de congestion dans les réseaux de données mobiles, et montrons qu'il appartient à la sous-classe précédente. Nous utilisons la structure spécifique de ce problème pour proposer des *algorithmes polynomiaux* efficaces lorsque la dimension du problème de niveau bas est très élevée. Nous proposons également une heuristique basée sur ces algorithmes pour des modèles réalistes dans les télécommunications, et validons nos résultats sur des données réelles apportées par Orange.

Dans le Chapitre 3, nous rappelons des notions préliminaires essentielles pour la suite de la thèse. Nous présentons les problèmes bi-niveaux et leurs liens avec les équilibres de Stackelberg. Nous rappelons des résultats standards de complexité, et présentons les méthodes classiques pour les résoudre. Ensuite, nous traitons des notions de polyèdre, complexe polyédral et subdivision polyédrale. Nous mentionnons les définitions et étudions la combinatoire de tels objets, rappelant en particulier des relations classiques entre le nombre de faces de chaque dimension d'un polyèdre, ou de manière équivalente entre les nombres de cellules de chaque dimension d'un complexe polyédral. Dans une troisième partie, nous présentons la géométrie tropicale. Nous expliquons la notion de polynôme tropical et d'hypersurface tropicale. Nous rappelons la définition du polytope de Newton et la bijection usuelle entre un complexe polyédral défini par une hypersurface tropicale et une subdivision régulière du polytope de Newton associé. Nous mentionnons également certains résultats au sujet de ces subdivisions. Nous étudions le cas d'arrangements d'hypersurfaces tropicales, et rappelons le théorème de Bernstein-Khovanskii-Kushnirenko (BKK), résultat classique de géométrie algébrique. Enfin, nous exposons des notions élémentaires de convexité discrète, et en particulier la notion de fonctions M -convexes. Nous rappelons l'équivalence entre optimalité locale et globale pour les fonctions M -convexes, qui amène à la minimisation de telles fonctions en temps polynomial. Nous donnons également des exemples classiques de classes de fonctions M -convexes.

2.2.1 Une approche tropicale de la programmation bi-niveau

Le Chapitre 4 est dédié à l'étude d'une classe spécifique de problèmes bi-niveaux, qui correspondent à la situation économique suivante. Un producteur désire vendre n biens distincts à

un client. Le prix des biens correspond au vecteur $-y \in \mathbb{R}^n$, où $-y_j$ (pour tout $j \in [n]$) est le prix du bien j . Cependant, le producteur vend ses différents biens en k lots distincts. Nous définissons la matrice $C \in \mathcal{M}_{k,n}(\mathbb{R})$ telle que pour tous $i \in [k]$, $j \in [n]$, c_{ij} est la quantité du bien j se trouvant dans le lot i . Ainsi, le vecteur de prix des différents lots est $-Cy \in \mathbb{R}^k$. Nous désignons par $x \in \mathbb{R}^k$ l'achat du client, ($x_i \in \mathbb{R}$ est la quantité du lot i achetée par le client). Les contraintes du clients sont linéaires, modélisées par $x \in \mathcal{P}$, où \mathcal{P} est un polytope de \mathbb{R}^k . La quantité de biens vendus par le producteur correspond ainsi au vecteur $C^T x$. Pour un vecteur de prix $-y \in \mathbb{R}^n$ fixé, le client maximise son utilité. Il possède un vecteur "de préférences" $\rho \in \mathbb{R}_k$ ($\rho_i \in \mathbb{R}$ est une mesure de la préférence du client à acheter le lot i). Il détermine ainsi sa consommation $x^* \in \mathbb{R}^k$ telle que :

$$x^* \in \arg \max_{x \in \mathcal{P}} \langle \rho + Cy, x \rangle.$$

Le producteur souhaite minimiser ses coûts, dépendant de la quantité $C^T x^*$ vendue et du prix $-y$ proposé. Il résout donc :

$$\min_{y \in \mathbb{R}^n} f(C^T x^*, y)$$

où x^* est la consommation optimale du client. Ce dernier problème est un *problème bi-niveau continu*. Nous étudions également un *problème bi-niveau discret*, correspondant au cas de biens indivisibles. Cela signifie que la matrice C est à coefficients entiers, et que la consommation x du client est contrainte d'appartenir à l'ensemble des points entiers du polytope \mathcal{P} . La variable de décision de niveau bas x est alors discrète, tandis que la variable de décision de niveau haut y est continue. Pour les différents problèmes bi-niveaux introduits, nous traitons à la fois les versions optimistes et pessimistes des problèmes.

Le problème de niveau bas de ce programme bi-niveau correspond au polynôme tropical Q défini par $Q(y) = \max_{x \in C^T \mathcal{P}} \langle y, C^T x \rangle + \langle \rho, x \rangle$. De manière semblable à ce qui est fait par Baldwin et Klemperer [BK12] puis par Tran et Yu [TY15], la réponse du client définit un complexe polyédral \mathcal{S} . Ce complexe est dual d'une subdivision régulière \mathcal{S}' du polytope de Newton de Q , en sens qu'il existe une bijection ϕ entre les cellules de \mathcal{S} et celles de \mathcal{S}' . Cette bijection signifie que pour chaque cellule $\mathcal{C} \in \mathcal{S}$, les éléments de $\phi(\mathcal{C})$ réalisent le maximum dans $Q(y)$ pour chaque $y \in \mathcal{C}$. Cette décomposition de la réponse du client en un complexe polyédral nous amène au résultat suivant.

Théorème 2.1 (Réduction du problème bi-niveau continu optimiste à l'énumération de cellules). *Supposons que pour tout $y \in \mathbb{R}^n$, la fonction $z \mapsto f(z, y)$ est semi-continue inférieurement. Alors la version optimiste du problème bi-niveau continu 4.1 est équivalente au problème suivant :*

$$\min_{\mathcal{C} \in \mathcal{S}} \left[\inf_{y \in \mathcal{C}} \min_{z \in \phi(\mathcal{C})} f(z, y) \right].$$

De plus, si la fonction f est conjointement semi-continue inférieurement en (z, y) et est inf-compacte sur chaque ensemble $\phi(\mathcal{C}) \times \mathcal{C}$, alors la solution optimiste existe.

Un résultat similaire pour le cas pessimiste peut être établi. Cependant, la solution pessimiste d'un problème bi-niveau n'est pas toujours réalisable. On peut néanmoins garantir l'existence de solutions approchées. Une solution réalisable d'un problème d'optimisation est appelée ε -solution du problème si la différence entre la fonction valeur en cette solution et la valeur optimale du problème est inférieure ou égale à ε .

Théorème 2.2 (Réduction du problème bi-niveau continu pessimiste à l'énumération de cellules). *Supposons que pour chaque $C \in \mathcal{S}$, la fonction f est continue sur $\phi(C) \times C$. Alors la valeur du cas pessimiste du problème bi-niveau continu 4.1 est donnée par :*

$$\min_{C \in \mathcal{S}} \left[\inf_{y \in C} \max_{z \in \phi(C)} f(z, y) \right]. \quad (2.1)$$

Si f est de plus inf-compacte, alors le problème défini par (2.1) admet une solution optimale, et il existe une ε -solution de la version pessimiste du problème 4.1.

Pour le problème discret, nous établissons et prouvons des résultats similaires sous des hypothèses de totale unimodularité de la matrice C et du polytope \mathcal{P} . Pour conclure ce chapitre, nous présentons deux généralisations de la classe de problèmes bi-niveaux étudiée. Nous montrons que certains résultats sont encore valables dans le cas discret lorsque les coefficients du polynôme tropical Q sont définis par n'importe quelle fonction concave, et nous étudions également comment généraliser la fonction de niveau haut en supprimant sa dépendance en la matrice C .

Dans le Chapitre 5, nous étudions comment les diverses réductions établies dans le Théorème 2.1 et le Théorème 1.2 amènent à un algorithme pour résoudre à la fois le problème continu et le problème discret. Nous devons dans un premier temps énumérer les cellules d'un complexe polyédral associé à un polynôme tropical défini à partir du problème de niveau bas. Dans un deuxième temps, nous devons déterminer les cellules duales appartenant à une subdivision régulière du polytope de Newton associé. Enfin, nous résolvons un problème d'optimisation associé à chaque cellule. Nous montrons que l'énumération des cellules d'un tel complexe polyédral est équivalente à l'énumération des faces d'un polyèdre. En utilisant un algorithme classique développé par Fukuda, Liebling et Margot [FLM97], nous écrivons un algorithme énumérant les cellules de \mathcal{S} et donnant les cellules duales de \mathcal{S}' correspondantes. La complexité d'un tel algorithme dépend de paramètres combinatoires du complexe polyédral tel que le nombre de faces de chaque dimension. Nous déterminons ensuite des bornes supérieures de ces paramètres et nous nous intéressons à des cas particuliers pour lesquels on peut trouver les meilleures bornes supérieures possibles. Par conséquent, la complexité temporelle de notre algorithme dépend de manière polynomiale de la dimension du problème de niveau bas et d'une estimation métrique du polytope $C^T \mathcal{P}$ (typiquement le rayon de la sphère polyédrale), lorsque la dimension du problème de niveau haut est fixée. Ainsi, si chaque sous-problème est soluble à paramètre fixé, c'est-à-dire pouvant être résolu en temps polynomial lorsque la dimension du problème de niveau haut est fixée, nous prouvons le résultat suivant :

Théorème 2.3 (Résolution à paramètre fixé des problèmes bi-niveaux). *Supposons qu'une ε -solution de chaque sous-problème peut être obtenue en temps polynomial lorsque la dimension du problème haut est fixée. Alors une ε -solution des problèmes bi-niveaux continu et discret étudiés peut être obtenue en temps polynomial en la dimension du niveau bas et une estimation métrique de $C^T \mathcal{P}$ lorsque la dimension du problème haut est fixée.*

Dans le Chapitre 6, nous traitons de certaines sous-classes particulières du problème étudié dans le Chapitre 4. Tout d'abord, nous montrons que notre problème peut modéliser la situation économique dans laquelle le producteur vend ses produits à un ensemble de clients. Les résultats précédents font sens pour ce problème car la dimension du niveau bas est bien plus grande que celle du niveau haut pour un grand nombre de clients. Ce problème a une structure particulière dans laquelle \mathcal{P} peut être décomposé en un produit cartésien de polytopes, chacun étant l'ensemble réalisable d'un client. Les ventes du producteur sont alors simplement la somme des

consommations de chaque client, ce qui signifie que le polytope $C^T\mathcal{P}$ est la somme de Minkowski de polytopes correspondant aux ensembles réalisables des différents clients. Ainsi, le complexe polyédral défini par le problème de niveau bas correspond à un arrangement d'hypersurfaces tropicales, chacune étant associée à la réponse d'un client. La subdivision duale du polytope de Newton est alors une subdivision mixte. Nous utilisons cette structure pour améliorer une borne supérieure donnée dans le Chapitre 4 grâce à la notion de volume mixte. Nous traitons ensuite d'une autre sous-classe particulière dans laquelle le profit du producteur ne dépend pas du prix. Cela signifie que la fonction f de niveau haut devient $f(C^T x^*)$. Nous prouvons le théorème suivant à propos de la solution optimiste du problème bi-niveau dans ce cas.

Théorème 2.4 (Théorème de décomposition pour le problème bi-niveau continu). *Supposons que f est semi-continue inférieurement. Alors la version optimiste du problème bi-niveau continu 4.1 est équivalente à :*

- Trouver $z^* \in \arg \min_{z \in C^T\mathcal{P}} f(z)$.
- Trouver $x^* \in \arg \max_{x \in \mathcal{P}, C^T x = z} \langle \rho, x \rangle$.
- Trouver $y^* \in \phi^{-1}(C'_{z^*})$, où C'_{z^*} est l'intersection de toutes les cellules de la subdivision duale \mathcal{S}' contenant z^* .

Ce théorème signifie que la valeur optimiste du problème bi-niveau peut être obtenue en résolvant trois problèmes d'optimisation au lieu de considérer la valeur minimale d'un large nombre de sous-problèmes. La deuxième partie est un problème de programmation linéaire ; il peut donc être résolu en temps polynomial en la dimension du niveau bas grâce à des méthodes de points intérieurs (voir le travail original de Karmarkar [Kar84] et également l'article de Renegar [Ren88]). La troisième partie consiste à trouver un point dans le sous-différentiel d'une application convexe affine par morceaux au point z^* . Cela peut être obtenu en résolvant un programme linéaire dual, également par des méthodes de points intérieurs ou par la méthode des ellipsoïdes (voir l'article de Grötschel, Lovasz et Schrijver [GLS81] qui reformule le travail original de Khachiyan [Kha79]). Si la fonction f est linéaire ou convexe, alors une ε -solution de la première partie peut également être obtenue en temps polynomial par la méthode des ellipsoïdes. Ainsi, le problème bi-niveau continu peut être résolu en temps polynomial.

Ce théorème est encore valable dans le cas discret sous des hypothèses de totale unimodularité. Dans ce cas, les deuxième et troisième parties du précédent théorème sont des programmes linéaires en nombres entiers dont la valeur est égale à celle de leur relaxation continue. Ils peuvent donc être résolus en temps polynomial. Nous montrons que si f appartient à une certaine classe de fonctions convexes discrètes appelées fonctions M^{\natural} -convexes, la première partie peut également être résolue en temps polynomial.

Nous étudions finalement une situation économique correspondant à un problème d'équilibre, dans lequel un producteur propose des réductions à ses différents clients pour équilibrer ses ventes entre les différents biens. Cela correspond au cas discret des deux sous-classes de problèmes étudiés dans ce chapitre. Nous généralisons les fonctions coûts des clients au niveau bas à n'importe quelle fonction M^{\natural} -concave. Ceci est en relation avec le théorème d'unimodularité de Baldwin et Klempner [BK12]. Nous montrons que nous pouvons résoudre ce problème en temps polynomial en les dimensions de niveau haut et bas. Après avoir rappelé le problème d'équilibres compétitifs pour des biens indivisibles introduit par Danilov, Koshevoy et Murota [DKM01], nous définissons une classe paramétrée d'équilibres compétitifs de ce type. Nous montrons que le problème bi-niveau que nous traitons peut être interprété comme un équilibre compétitif dans

lequel le profit du producteur ne dépend pas du prix qu'il propose. Nous montrons également que la solution de ce problème est une limite d'équilibres compétitifs appartenant à la classe paramétrée que nous avons introduite lorsque le paramètre tend vers zéro.

2.2.2 Une application à un problème de congestion dans les réseaux de données mobiles

Dans le Chapitre 7, nous étudions le problème de congestion dans les réseaux de données mobiles précédemment présenté. Nous considérons un réseau cellulaire que nous divisons en L cellules. Nous divisons un jour en T intervalles de temps. Un opérateur de réseau mobile propose en avance un vecteur de réductions y , où $y(t, l) \in \mathbb{R}$ est la récompense offerte par l'opérateur aux K différents utilisateurs du réseau au temps t dans la cellule l . Nous modélisons la consommation de l'utilisateur $k \in [K]$ par un vecteur binaire $u_k \in \{0; 1\}^{T \times L}$, où $u_k(t, l) = 1$ si l'utilisateur k effectue une requête au temps t et au lieu l et $u_k(t, l) = 0$ sinon. Nous supposons que l'utilisateur souhaite faire un nombre fixe de requêtes R_k . Nous supposons également qu'il a également une trajectoire fixée ce qui signifie que $u_k(t, l) = 0$ si le lieu l ne se trouve pas sur la trajectoire de l'utilisateur k au temps t . Par ailleurs, nous supposons que l'utilisateur est indisponible à certains intervalles de temps. Ainsi, il existe un ensemble \mathcal{J}_k de couples (t, l) tels que $u_k(t, l)$ est contraint d'être égal à 0. Cela signifie que l'ensemble des consommations de l'utilisateur k est $F_k = \{u_k \in \{0; 1\}^{T \times L} \mid \sum_{t,l} u_k(t, l) = R_k, \forall (t, l) \in \mathcal{J}_k, u_k(t, l) = 0\}$. Cela correspond à la fois aux points entiers et aux points extrêmes d'un hypersimplexe de dimension $(n - \#\mathcal{J}_k)$. Chaque utilisateur a un vecteur de préférence $\rho_k \in \mathbb{R}^{T \times L}$ qui mesure sa propension à consommer au temps t et au lieu l . Ainsi, il détermine sa consommation optimale u_k^* telle que :

$$u_k^* \in \arg \max_{u_k \in F_k} \langle \rho_k + y, u_k \rangle.$$

L'opérateur désire équilibrer le réseau, ce qui peut se modéliser par le fait de minimiser une mesure de congestion du réseau. Il calcule la charge globale du réseau $N = \sum_k u_k^*$. Cela représente le nombre de clients actifs à chaque pas de temps et en chaque lieu. Nous supposons de plus que f est une fonction concave ne dépendant que de N , et nous considérons plus précisément $f(N) = \sum_{t,l} f_{t,l}(N(t, l))$ (f est la somme de fonctions concaves en une variable dépendant du nombre de clients actifs dans le réseau au temps t et au lieu l). Ainsi, l'opérateur propose les réductions de sorte à minimiser la congestion et résout le problème de maximisation suivant :

$$\max_{y \in \mathbb{R}^{T \times L}} f(N),$$

avec $N = \sum_k u_k^*$ et u_k^* est la réponse de l'utilisateur k aux réductions annoncées par l'opérateur.

Cela définit un problème bi-niveau discret que nous appelons *problème de congestion*. Cela correspond plus précisément au problème de congestion étudié au Chapitre 6. La fonction de niveau haut ne dépend pas des réductions annoncées par l'opérateur. Nous considérons un grand nombre de clients, et la réponse de chaque client aux réductions est un polynôme tropical. Finalement, les consommations possibles de chaque client sont les points entiers d'un polytope entier. Le théorème de décomposition 2.4, prouvé dans le Chapitre 6, peut être appliqué au problème de congestion dans les réseaux mobiles.

Théorème 2.5 (Théorème de décomposition pour un problème de congestion). *Le cas optimiste du problème de congestion peut être résolu en :*

1. trouvant une solution optimale N^* du problème suivant d'inconnue N :

$$\max_{N \in \sum_k F_k} \sum_{t,l} f_{t,l}(N(t,l)) \quad \text{s.t. } \forall(t,l), N(t,l) \leq N^C(t,l) .$$

2. trouvant des vecteurs (u_1^*, \dots, u_K^*) solutions du problème suivant :

$$\max_{\substack{u_1 \in F_1, \dots, u_K \in F_K \\ \sum_k u_k = N^*}} \sum_k \langle \rho_k, u_k \rangle .$$

3. trouvant un vecteur y^* tel que $\forall k, u_k^*$ est une solution du problème de niveau bas.

Les résultats du Chapitre 6 montrent que ce problème peut être résolu en temps polynomial. Cependant, pour appliquer ce modèle à des réseaux avec un grand nombre d'utilisateurs, nous devons limiter l'exposant du paramètre K (nombre d'utilisateurs) dans la complexité de l'algorithme que nous proposons pour résoudre ce problème. Nous montrons que le problème de niveau haut correspond à la minimisation d'une fonction M -convexe. Nous obtenons un minimiseur à l'aide d'un algorithme glouton proposé par Murota [Mur03]. Cela consiste à trouver la valeur minimale et un minimiseur de la fonction dans un certain voisinage d'un point initial. Si la valeur minimale obtenue est inférieure ou égale à la valeur de la fonction au point initial, nous prenons le minimiseur comme nouveau point initial. Dans le cas contraire, le point initial est un minimiseur global de la fonction. Cependant dans notre cas, nous devons déterminer si un point initial $N \in \mathbb{Z}^{T \times L}$ appartient ou non à $\sum_k F_k$. Ce problème, ainsi que celui consistant à obtenir un vecteur de réductions optimales y^* lorsque les consommations u_k^* de chaque utilisateur sont connus, est un problème de faisabilité linéaire en grande dimension, qui peut être résolu en temps polynomial. Cette résolution n'est cependant pas efficace en pratique car la dimension du problème est trop grande.

Nous montrons néanmoins qu'il est possible de résoudre ce problème plus efficacement. Nous supposons la connaissance d'un point initial $N \in \sum_k F_k$, ainsi que de sa décomposition optimale en consommations d'utilisateurs $N = \sum_k u_k^*$. Soit N' un point du voisinage N (même voisinage que dans l'algorithme de murota). Nous montrons que nous pouvons décider si N' appartient ou non à $\sum_k F_k$, et si oui, déterminer les consommations optimales u_k^* de chaque utilisateur ainsi que le vecteur de réductions optimales y^* que l'opérateur doit proposer en résolvant un problème de plus court chemin dans un graphe. Cela provient principalement de la structure spécifique de l'ensemble réalisable de chaque utilisateur (points entiers d'hypersimplexes). Cela amène à un algorithme en temps polynomial pour résoudre le problème bi-niveau qui peut être adapté à des réseaux présentant un grand nombre de clients. Nous étudions de plus un cas particulier dans lequel nous accélérons l'algorithme précédent grâce à la théorie de la majorisation (voir Marshall et Olkin [OM79]).

Ensuite, nous nous intéressons à un modèle plus réaliste, prenant en compte les différentes applications utilisées par les utilisateurs et segmentant les clients suivant leur type de contrat. Nous montrons que le cas simple d'un type d'application et un type de clients correspond au problème bi-niveau étudié dans ce chapitre. Dans le cas général, nous proposons une solution approchée : pour chaque application et chaque type d'utilisateur, nous résolvons le problème bi-niveau précédent en fixant toutes les variables concernant les autres applications et autres types de clients, et nous répétons cette procédure aussi longtemps que possible.

Nous présentons finalement une application de ce modèle à des données réelles fournies par Orange et montrons comment des incitations tarifaires peuvent améliorer la qualité de service en

équilibrant à travers le réseau le nombre de clients actifs dans une agglomération urbaine pendant un jour. Ces résultats indiquent qu'un mécanisme d'incitations tarifaires peut effectivement améliorer la satisfaction des utilisateurs en déplaçant leur consommation des régions et des heures les plus chargées à des lieux et instants moins congestionnés.

Pour conclure, nous présentons dans le Chapitre 8 certaines perspectives de ce travail. Nous suggérons de développer des algorithmes de séparation et évaluation pour rendre efficace pratiquement la méthode exposée dans le Chapitre 4. L'idée est d'éviter d'explorer toutes les cellules d'un complexe polyédral. Ensuite, nous revenons au problème de congestion dans les réseaux mobiles et proposons d'ajouter des contraintes de bornes sur les réductions afin de réduire les dépenses de l'opérateur. Enfin, nous expliquons en quoi des modèles stochastiques pourraient être étudiés afin de proposer des incitations en temps réel.

Dans l'Annexe A, nous présentons une autre méthode pour énumérer les faces d'un polyèdre et la comparons à l'approche développée dans le Chapitre 5. L'Annexe B est consacrée à la preuve d'un théorème donnant une borne supérieure sur le nombre d'appexes d'un arrangement d'hypersurfaces tropicales. Enfin, nous mentionnons dans l'Annexe C quelques résultats à propos d'une variante du problème de congestion présenté dans le Chapitre 8 (cas des incitations tarifaires bornées).

CHAPTER 3

Preliminaries

In this chapter, we present different classical notions and results that we will use in the next chapters.

First, we introduce bilevel programming and Stackelberg equilibria. We present classical results of complexity and the standard methods to solve bilevel problems. Next, we recall the notions of polyhedral complexes and subdivisions and mention some results about combinatorics of polyhedra and subdivisions. In Section 3.3, we introduce tropical geometry and standard notions relative to tropical polynomials. Finally, in Section 3.4, we recall the classical results about a certain class of discrete convex functions.

3.1 Bilevel programming

Bilevel programming problems correspond to a class of optimization problems. This notion was introduced by von Stackelberg in game theory [VS34], more precisely to explain duopolies with asymmetric information between the two players. Consider a game with two players X and Y . We denote by \mathcal{X} the set of possible strategies of X and by \mathcal{Y} the set of possible strategies of Y . We suppose that the two players have perfect information, but that they do not play simultaneously.

One player, Y called the *leader*, decides one strategy $y \in \mathcal{Y}$ and announces it to the other one. The other player (X in our case), called the *follower*, chooses his strategy in order to maximize his utility. When the leader announces a strategy y , we assume that the strategies $x \in \mathcal{X}$ of the follower have to satisfy a constraint of the form $g(x, y) \leq 0$. His utility is of the

form $f(x, y)$. Hence, he chooses his optimal strategy x^* in the set \mathcal{X}_y^* defined by:

$$\mathcal{X}_y^* := \arg \max_{x \in \mathcal{X}, g(x, y) \leq 0} f(x, y).$$

Similarly, when the response of the follower is x^* , we assume that the strategy of the leader has to satisfy a constraint of the form $G(x^*, y) \leq 0$. Hence, he determines his strategy $y^* \in \mathcal{Y}$ by solving the following problem:

$$\text{“min”}_{y \in \mathcal{Y}} F(x^*, y) \quad \text{s.t. } G(x^*, y) \leq 0, x^* \in \mathcal{X}_y^*$$

The latter expression is unambiguous when x^* is uniquely determined from y . If not, the problem of the leader is not well-defined. We explain further that two interpretations are possible (called optimistic and pessimistic).

Such a problem is consequently called a *bilevel programming problem*, because it contains two "levels" of optimization. The *high-level* problem corresponds to the optimization problem solved by the leader. Since the leader Y plays first, he knows that when he chooses a strategy $y \in \mathcal{Y}$, the response x^* of X belongs to \mathcal{X}_y^* , that is the response x^* of the follower is an optimal solution of the optimization problem solved by the follower, called the *low-level* problem.

The bilevel problem is feasible if each player can always choose a strategy. This means that for each strategy $y \in \mathcal{Y}$ announced by the leader, there exists a feasible strategy for the follower, that is $\{x \in \mathcal{X}, g(x, y) \leq 0\} \neq \emptyset$. It also means that there exists a strategy $y \in \mathcal{Y}$ of the leader such that, for each possible response x^* of the follower, y belongs to the feasible set of the high-level problem, that is $G(x^*, y) \leq 0$. Hence, a bilevel problem is feasible if:

$$\begin{aligned} \forall y \in \mathcal{Y}, \exists x \in \mathcal{X}, g(x, y) \leq 0 \\ \exists y \in \mathcal{Y}, \forall x^* \in \mathcal{X}_y^*, G(x^*, y) \leq 0. \end{aligned}$$

We recall that the high-level problem is not well-defined if the strategy of the follower x^* is not uniquely determined by the strategy y of the leader. In fact, the strategy of the follower x^* can be any value in \mathcal{X}_y^* , and this choice is not controlled by the leader. However, if for each $y \in \mathcal{Y}$, the set \mathcal{X}_y^* is reduced to a single point, then the leader knows precisely the response of the follower to each strategy $y \in \mathcal{Y}$, and can determine precisely his optimal strategy y^* by solving a well-posed optimization problem.

If \mathcal{X}_y^* is not reduced to a single point, the leader can consider two cases. First, the leader assumes that the follower chooses the best strategy for the leader, that is he takes

$$x^* \in \arg \min_{x \in \mathcal{X}_y^*} \{F(x, y) + \chi_{G(x, y) \leq 0}(y)\},$$

where for $x \in \mathcal{X}_y^*$, $\chi_{G(x, y) \leq 0}(y) = 0$ if $G(x, y) \leq 0$ and $\chi_{G(x, y) \leq 0}(y) = +\infty$ otherwise. In particular, the follower chooses always a feasible strategy for the leader. Hence, the leader can determine his optimal strategy y^* by solving an optimization problem, called the *optimistic bilevel problem*:

$$\min_{y \in \mathcal{Y}} F(x^*, y) \quad \text{s.t.} \quad G(x^*, y) \leq 0$$

and $x^* \in \arg \min_{x \in \mathcal{X}_y^*} \{F(x, y) + \chi_{G(x, y) \leq 0}(y)\}$. The optimistic bilevel problem can be rewritten as an optimization problem over both variables y and x^* . It is equivalent to:

$$\min_{y \in \mathcal{Y}, x^* \in \mathcal{X}} F(x^*, y) + \chi_{G(x^*, y) \leq 0}(y) \quad \text{s.t. } x^* \in \mathcal{X}_y^*. \quad (3.1)$$

Second, the leader assumes that the follower chooses the worst strategy for the leader (see [WTKR13]), that is he takes

$$x^* \in \arg \max_{x \in \mathcal{X}_y^*} \{F(x, y) + \chi_{G(x, y) \leq 0}(y)\}.$$

In particular, the follower chooses always an unfeasible strategy for the leader if possible. The leader can also determine his optimal strategy y^* by solving an optimization problem, called the *pessimistic bilevel problem*:

$$\min_{y \in \mathcal{Y}} F(x^*, y) \quad \text{s.t.} \quad G(x^*, y) \leq 0$$

and $x^* \in \arg \max_{x \in \mathcal{X}_y^*} \{F(x, y) + \chi_{G(x, y) \leq 0}(y)\}$. The pessimistic bilevel is in fact a "min-max" problem. It is equivalent to:

$$\min_{y \in \mathcal{Y}} \max_{x^* \in \mathcal{X}^*} F(x^*, y) + \chi_{G(x^*, y) \leq 0}(y) \quad \text{s.t.} \quad x^* \in \mathcal{X}_y^*. \quad (3.2)$$

The existence of a feasible optimistic and pessimistic solution is studied [Dem02, Ch.4]. Owing to the "min-max" formulation of a pessimistic bilevel problem, the existence of a pessimistic solution is not guaranteed, even both high-level and low-level functions are continuous and defined on compact sets.

Example 3.1. Let $y \in [-1, 1]$ be the decision variable of the leader. The low-level problem is formulated as:

$$x^* \in \arg \max_{x \in [0, 1]} xy.$$

The high-level problem is:

$$\text{"min"}_{y \in [-1, 1]} x^*y - y + x^*.$$

The response set \mathcal{X}_y^* of the leader depends on y . We have:

$$\mathcal{X}_y^* = \{0\} \text{ if } y < 0, \quad \mathcal{X}_y^* = \{1\} \text{ if } y > 0, \quad \mathcal{X}_y^* = [0, 1] \text{ if } y = 0.$$

If the leader chooses $y < 0$, the high-level value is then equal to $-y$. If he chooses $y > 0$, the high-level value is equal to 1. If he chooses $y = 0$, then the high-level function can take any value between 0 and 1, depending on the choice of the follower.

Consequently, the optimistic bilevel problem can be formulated as $\inf_{y \in [-1, 1]} F_{opt}(y)$, with F_{opt} defined by:

$$F_{opt}(y) = -y \text{ for } y < 0, \quad F_{opt}(0) = 0 \quad F_{opt}(y) = 1 \text{ for } y > 0.$$

The optimistic value is then 0 and is attained in $y = 0$, $x^* = 0$.

Moreover, the pessimistic bilevel problem can be formulated as $\inf_{y \in [-1, 1]} F_{pes}(y)$, with F_{pes} defined by:

$$F_{pes}(y) = -y \text{ for } y < 0, \quad F_{pes}(0) = 1 \quad F_{opt}(y) = 1 \text{ for } y > 0.$$

The pessimistic value is then 0, but is not attained. However, for every $\varepsilon > 0$, we have $F_{pes}(-\varepsilon) = \varepsilon$. This means that an approximate pessimistic solution can be obtained.

Bilevel programming is a well-studied topic in optimization. Bard ([Bar13]) and Dempe ([Dem02]) devote books to bilevel programming, presenting the main theoretical aspects, algorithms and applications. In [Dem03a], Dempe gives a large list of references on methods and applications concerning bilevel optimization. Moreover, different surveys ([CMS07], [SMD17]) present also these aspects. It appears that bilevel programming problems are well-adapted to model pricing problems. Labbé et al. ([LMS98]) and Brotcorne et al. ([BLMS01]) propose a bilevel model for a taxation scheme, which is used for a toll-setting problem in a multicommodity transportation network. Brotcorne et al. ([BLMS00]) present an application for a freight tariff-setting problem. Larsson and Patriksson ([LP98]) present a bilevel model to limit the traffic congestion. Bard et al. ([BPS00]) develop an application to energy pricing: they propose a bilevel model for the minimization of tax credits a government allows to biofuel producers. In telecommunications networks, Ma et al. ([MLH14]) consider a bilevel model for smart data pricing in mobile networks, depending on the mobility of the users.

Bilevel programming problems model a large number of real applications. However, they are generally hard to solve, even in the simple case of linear functions and constraints. Jeroslow ([Jer85]) presents a polynomial hierarchy for multi-level linear games. This is based on the classical polynomial-time hierarchy (see [Sto76]) about the time complexity of decision problems. Jeroslow applied these results in the case of two players, that is for optimistic bilevel programs. He proves that to decide whether a rational number is the optimal value of a linear bilevel problem in binary variables is Σ_2^P -hard, whereas the same problem for linear bilevel problems in continuous variables is NP-hard. He also mentions that deciding whether the value of a linear bilevel problem is less or equal to a certain number v is an NP-complete problem. The NP-hardness of bilevel linear programs is also proved by Ben Ayed ([BAB90]) and Bard ([Bar91]). Their proofs are simpler and do not use the polynomial hierarchy, but a reduction of classical NP-hard problems.

Different classical approaches exist to develop algorithms for solving bilevel programs (see [CMS07] and [SMD17] for surveys). The most classical one consists in replacing the low-level problem by its associated Karush-Kuhn-Tucker (KKT) conditions (see [DZ12]). This only applies when the KKT conditions are necessary and sufficient for the optimality of the low-level solution. To simplify, we suppose that $\mathcal{X} = \mathbb{R}^k$, $\mathcal{Y} = \mathbb{R}^n$ and $g : (x, y) \in \mathbb{R}^k \times \mathbb{R}^n \mapsto g(x, y) \in \mathbb{R}^p$. We assume that for each $y \in \mathbb{R}^n$, the function $x \mapsto f(x, y)$ is concave, and that the function $x \mapsto g_j(x, y)$ is convex for each $j \in [p]$. We also assume that the Slater condition is satisfied, that is for each $y \in \mathbb{R}^n$, there exists $x \in \mathbb{R}^k$ such that $g_j(x, y) < 0$ for every $j \in [p]$. Hence, for fixed y , the low-level problem is equivalent to the following one:

$$\max_{x \in \mathbb{R}^k} \min_{\lambda \geq 0} [f(x, y) - \lambda^T g(x, y)].$$

Consequently, a point x^* is an optimal solution of the low-level problem (or equivalently $x^* \in \mathcal{X}_y^*$) if and only if the KKT conditions are satisfied, that is there exists $\lambda^* \in \mathbb{R}^p$ such that:

$$\begin{aligned} \partial_x f(x^*, y) - \sum_{j=1}^p (\lambda_j^*) \partial_x g_j(x^*, y) &= 0 \\ \forall j \in [p], g_j(x^*, y) &\leq 0 \\ \lambda^* &\geq 0 \\ \forall j \in [p], \lambda_j g_j(x^*, y) &= 0. \end{aligned}$$

This allows us to reformulate the optimistic bilevel program as a one-level optimization problem in variables y , x^* and λ^* , and the pessimistic bilevel problem as a "min-max" problem.

However, the complementarity slackness conditions $\lambda_j g_j(x^*, y) = 0$ are generally non-convex. Some branch-and-bound algorithms can be used to treat this difficulty [CMS07, Section 3.3].

For a linear-linear bilevel problem (all the objective functions and constraints are linear), combinatorial approaches exist ([MS05]). The bilevel problem is reformulated in a one-level problem in mixed variables and can be solved with branch-and-bound algorithms.

3.2 Polyhedra, polyhedral complexes and subdivisions

Polyhedra and subdivisions Tropical geometry is related with polyhedral geometry. The *dimension* of a polyhedron Δ of \mathbb{R}^n is defined as the minimum of the dimensions of the subspaces of \mathbb{R}^n which contain Δ . A 0-dimensional polyhedron is a point, a 1-dimensional polyhedral is a segment, a 2-dimensional polyhedron is a polygon, \dots . A polyhedron is *full-dimensional* if and only if its volume is non-zero. The subpolyhedra of Δ are the *faces* of Δ . A $n - 1$ -dimensional face of a polyhedron is called a *facet*, a 1-dimensional face an *edge*, and a 0-dimensional facet is a *vertex*.

A *subdivision* of a polyhedron $\Delta \in \mathbb{R}^n$ is a collection \mathcal{S} of polyhedra, called *cells* of the subdivision, such that:

1. For all cells \mathcal{C}_1 and $\mathcal{C}_2 \in \mathcal{S}$, $\mathcal{C}_1 \subset \mathcal{C}_2$ if and only if \mathcal{C}_1 is a face of \mathcal{C}_2 .
2. For all cells $\mathcal{C}_1, \mathcal{C}_2 \in \mathcal{S}$, then, either $\mathcal{C}_1 \cap \mathcal{C}_2 = \emptyset$ or $\mathcal{C}_1 \cap \mathcal{C}_2$ is a common face of \mathcal{C}_1 and \mathcal{C}_2 .
3. The elements of \mathcal{S} cover Δ , that is $\bigcup_{\mathcal{C} \in \mathcal{S}} \mathcal{C} = \Delta$.

The notion of subdivision can be extended to convex sets (see[PRr04, Def.1]). Notice that the intersection of two cells of a subdivision is either empty or defines another cell of the subdivision. A subdivision containing only simplices is called a *triangulation*. A subdivision obtained as a projection over the n first coordinates of the faces of a polyhedron of \mathbb{R}^{n+1} is called *regular*. More details about triangulations and subdivisions can be found in [DLRS10].

Faces of a simplex and of a simplicial complex In this paragraph, we introduce some elements about the combinatorics of simplices and simplicial complexes, as defined in [DLRS10], ch.2.6. Let K be a n -dimensional simplicial complex. We denote by $f(K)$ its f -vector, that is for all $i \in \{-1, \dots, n\}$, $f_i(K)$ is the number of i -dimensional faces of K .

The h -vector of K is $h(K) = (h_0(K), \dots, h_{n+1}(K))$ with:

$$\forall 0 \leq i \leq n + 1, h_i(K) = \sum_{j=0}^i (-1)^{i-j} \binom{n+1-j}{i-j} f_{j-1}(K)$$

Then, we have:

$$\forall 0 \leq i \leq n + 1, f_{j-1}(K) = \sum_{i=0}^j \binom{n+1-i}{j-i} h_i(K)$$

We denote by ∂K the boundary of K . We next assume that K corresponds topologically to a simplicial n -ball and that ∂K corresponds to a simplicial $n - 1$ -sphere. We can also define the f -vector $f(\partial K)$, with $f_i(\partial K)$ equal to the number of i -dimensional faces of ∂K for $-1 \leq i \leq n - 1$, and the h -vector $h(\partial K)$ as $h(\partial K) = (h_0(\partial K), \dots, h_n(\partial K))$ with:

$$\forall 0 \leq i \leq n, h_i(\partial K) = \sum_{j=0}^i (-1)^{i-j} \binom{n-j}{i-j} f_{j-1}(\partial K)$$

The *Euler characteristic* of K , denoted by $\chi(K)$, is defined by:

$$\chi(K) = \sum_{i=0}^n (-1)^i f_i(K).$$

Similarly, we define $\chi(\partial K) = \sum_{i=0}^{n-1} (-1)^i f_i(\partial K)$.

Lemma 3.2 ([DLRS10], Lemma 2.6.6). *Let K be a n -ball of boundary ∂K . Then, $\chi(K) = 1$ and $\chi(\partial K) = 1 + (-1)^{n-1}$*

Generally, $\lfloor \frac{n+1}{2} \rfloor$ relations can be written between the entries of the h -vector of K and of ∂K . Those relations, which are well-known for the h -vector of a simplicial sphere and called Dehn-Sommerville relations, can be written for ∂K .

Lemma 3.3 ([DLRS10], Lemma 2.6.9, Dehn-Sommerville equations). *Let ∂K be a $(n-1)$ -sphere. Then, the h -vector of ∂K is symmetric, that is $\forall 0 \leq i \leq n$, $h_i(\partial K) = h_{n-i}(\partial K)$.*

We can write relations other relations between the entries of the h -vector of a simplicial ball K and the entries of the h -vector of its boundary.

Theorem 3.4 ([DLRS10], Th.2.6.10). *Let K be a n -ball of boundary ∂K . Then, the h -vectors of K and ∂K satisfy the following equalities:*

$$\forall 0 \leq i \leq n, h_i(\partial K) = \sum_{j=0}^i [h_j(K) - h_{n+1-j}(K)]$$

3.3 Tropical geometry

In this section, we present some classical notions about tropical geometry. see [IMS09], [MS15] and [PR00] for background.

Tropical polynomials We consider the max-plus semifield $\mathbb{R} \cup \{-\infty\}$ with the laws \oplus and \odot defined by:

$$a \oplus b = \max(a, b) \quad a \odot b = a + b \quad (3.3)$$

We denote by $a^{\odot b} = a \times b$ the tropical exponentiation (for example $a^{\odot 2} = a \otimes a = a + a = 2 \times a$). By analogy with the classical polynomial functions, we can define the *tropical polynomial functions* on \mathbb{R}^n by:

$$P(x) = \bigoplus_{i=1}^p c_i \odot x_1^{\odot a_1^i} \odot \cdots \odot x_n^{\odot a_n^i} = \max_{1 \leq i \leq p} [c_i + \langle x, a^i \rangle]$$

with $c_i \in \mathbb{R}$ and $a^i \in \mathbb{N}^n$ for $1 \leq i \leq p$. Each function $x \mapsto c_i + \langle x, a^i \rangle$ is called a *tropical monomial*, the vector a^i is the vector of *exponents* of the tropical monomial, the real c_i is the *coefficient*, whereas the quantity $\sum_{j=1}^n a_j^i$ is called the *degree* of the monomial. A monomial $x \mapsto c_i + \langle a_i, x \rangle$ is said *essential* for P if there exists $x \in \mathbb{R}^n$ such that:

$$c_i + \langle x, a^i \rangle > \max_{j \in [p], j \neq i} [c_j + \langle x, a^j \rangle].$$

Consequently, if a monomial is not essential, it can be removed in the definition of function P . In the following, we assume that all the monomials of P are essential. A monomial $x \mapsto c_i + \langle a_i, x \rangle$ is said *maximal* for P in x if $P(x) = x \mapsto c_i + \langle a_i, x \rangle$. The tropical polynomial functions are precisely the convex piecewise linear functions with integer slopes.

We can extend the notion of tropical polynomial to the case of negative exponents, meaning that $a^i \in \mathbb{Z}^n$ instead of $a^i \in \mathbb{N}^n$; which is the tropical analogue to classical Laurent polynomials. The notion of tropical polynomial can also be extended to real exponents, that is $a^i \in \mathbb{R}^n$, which is the tropical analogue to posynomials. In the following, we use the term "tropical polynomial" to refer to tropical posynomials.

The graph $\text{gph}(P)$ of P is defined by:

$$\text{gph}(P) = \{(x, x_{n+1}) \in \mathbb{R}^n \times \mathbb{R} \mid x_{n+1} = P(x)\}$$

It defines a n -dimensional subset of \mathbb{R}^{n+1} . Let us denote by $\text{epi}(P)$ the epigraph of P , that is $\text{epi}(P) = \{(x, x_{n+1}) \in \mathbb{R}^n \times \mathbb{R} \mid x_{n+1} \geq P(x)\}$. By definition of P , we have $\text{epi}(P) = \{(x, x_{n+1}) \in \mathbb{R}^n \times \mathbb{R} \mid \forall 1 \leq i \leq p, x_{n+1} \geq c_i + \langle x, a_i \rangle\}$. Then, the epigraph of a tropical polynomial is a polyhedron.

Tropical hypersurfaces We define the *tropical hypersurface* $\mathcal{T}(P)$ associated to the tropical polynomial P as the set of points where P is non-differentiable. It corresponds to the set of points in which the maximum is "attained" at least twice (see Figure 3.1).

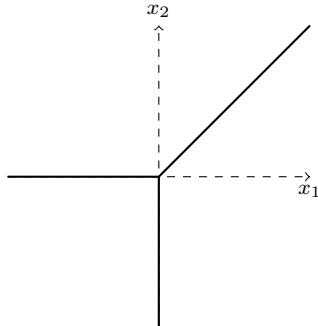

Figure 3.1: Tropical hypersurface associated to the tropical polynomial $\max(x_1, x_2, 0)$. It corresponds to the union of three rays: $\{x \in \mathbb{R}^2 \mid x_1 = x_2 \geq 0\}$, $\{x \in \mathbb{R}^2 \mid x_1 = 0 \geq x_2\}$ and $\{x \in \mathbb{R}^2 \mid x_2 = 0 \geq x_1\}$.

Hence, a tropical hypersurface $\mathcal{T}(P)$ consists in the union of $(n - 1)$ -dimensional polyhedra in \mathbb{R}^n .

Moreover, the tropical hypersurface $\mathcal{T}(P)$ defines a subdivision of \mathbb{R}^n . This subdivision is regular, because it is defined as the projections of the faces of $\text{epi}(P)$ over the n first entries.

For every face F of $\text{epi}(P)$, we define the polyhedron $\mathcal{C}(F)$ by:

$$\mathcal{C}(F) = \{x \in \mathbb{R}^n \mid (x, P(x)) \in F\}.$$

Hence, for every face F of $\text{epi}(Q)$, $\mathcal{C}(F)$ is the projection of F over the n first entries. We define \mathcal{S} as:

$$\mathcal{S} = \{\mathcal{C}(F) \mid F \text{ face of } \text{epi}(P)\}.$$

Proposition 3.5. \mathcal{S} is a subdivision of \mathbb{R}^n .

Proof. Let $x \in \mathbb{R}^n$. Then, $(x, P(x))$ belongs to a face F of $\text{epi}(P)$. So, $x \in \mathcal{C}(F)$. Consequently, $\bigcup_{\mathcal{C} \in \mathcal{S}} \mathcal{C} = \mathbb{R}^n$.

Let $\mathcal{C}_1, \mathcal{C}_2$ be two elements of \mathcal{S} . There exists two faces F_1, F_2 of $\text{epi}(P)$ such that $\mathcal{C}_1 = \mathcal{C}(F_1)$ and $\mathcal{C}_2 = \mathcal{C}(F_2)$. We have $\mathcal{C}_1 \subset \mathcal{C}_2$ if and only if $F_1 \subset F_2$, meaning that F_1 is a face of F_2 , which is equivalent to \mathcal{C}_1 is a face of \mathcal{C}_2 . Finally, if $\mathcal{C}_1 \cap \mathcal{C}_2 \neq \emptyset$, then $\mathcal{C}_1 \cap \mathcal{C}_2 = \mathcal{C}(F_1 \cap F_2) \in \mathcal{S}$. \square

Let $\mathcal{A} \subset [p] := \{1 \dots p\}$ be a non-empty subset of $[p]$. We define the face $F_{\mathcal{A}}$ of $\text{epi}(P)$ by:

$$\begin{aligned} \forall i \in \mathcal{A}, x_{n+1} &= c_i + \langle x, a_i \rangle \\ \forall i \notin \mathcal{A}, x_{n+1} &\geq c_i + \langle x, a_i \rangle \geq c_j + \langle x, a_j \rangle. \end{aligned}$$

We define the polyhedron $\mathcal{C}_{\mathcal{A}} = \{x \in \mathbb{R}^n \mid (x, P(x)) \in F_{\mathcal{A}}\}$. Then, $\mathcal{C}_{\mathcal{A}}$ is defined by the following equalities and inequalities:

$$\begin{aligned} \forall i, j \in \mathcal{A}, c_i + \langle x, a_i \rangle &= c_j + \langle x, a_j \rangle \\ \forall i \in \mathcal{A}, \forall j \notin \mathcal{A}, c_i + \langle x, a_i \rangle &\geq c_j + \langle x, a_j \rangle. \end{aligned}$$

This means that $\mathcal{C}_{\mathcal{A}}$ is the set of points $x \in \mathbb{R}^n$ for which each monomial $x \mapsto c_i + \langle x, a^i \rangle$ for $i \in \mathcal{A}$ is maximal for P in x . Notice that $\{F_{\mathcal{A}} \mid \mathcal{A} \in [p] \setminus \{\emptyset\}\}$ is exactly the set of faces of $\text{epi}(P)$, since every face F of $\text{epi}(P)$ can be written $F = F_{\mathcal{A}}$ for some non-empty subset $\mathcal{A} \in [p]$. Hence, $\mathcal{S} = \bigcup_{\mathcal{A} \in [p] \setminus \{\emptyset\}} \mathcal{C}_{\mathcal{A}}$. This means that the map $\mathcal{A} \in [p] \setminus \{\emptyset\} \mapsto \mathcal{C}_{\mathcal{A}} \in \mathcal{S}$ is surjective. However, this map is not injective. For instance, let $P : x \in \mathbb{R}^2 \mapsto P(x) = \max(x_1, -x_1, x_2, -x_2)$. The set of $x \in \mathbb{R}^2$ in which the monomials $x_1, -x_1$ and x_2 are maximal is the polyhedron defined by $x_1 = -x_1 = x_2 \geq -x_2$. It corresponds to the singleton $\{(0, 0)\}$, and the monomial $-x_2$ is also maximal at this point. For each element $\mathcal{C} \in \mathcal{S}$, we can define the subset $\mathcal{A}(\mathcal{C})$ of the monomials which are maximal for P in every $x \in \mathcal{C}$. Hence, we have:

$$\mathcal{A}(\mathcal{C}) = \bigcup \{\mathcal{A} \in [p] \setminus \{\emptyset\} \mid \mathcal{C} = \mathcal{C}_{\mathcal{A}}\}.$$

Proposition 3.6. Let $x \in \mathbb{R}^n$ and \mathcal{C} a cell of \mathcal{S} such that $x \in \mathcal{C}$ and $\mathcal{C} \neq \{x\}$. If $x \in \text{ri}(\mathcal{C})$, then $\mathcal{A}(\mathcal{C})$ is exactly the set of maximal monomials for P in x , where ri denotes the relative interior.

Proof. Let $x \in \text{ri}(\mathcal{C})$. Then:

$$\begin{aligned} \forall i \in \mathcal{A}(\mathcal{C}), P(x) &= c_i + \langle x, a^i \rangle, \\ \forall i \notin \mathcal{A}(\mathcal{C}), P(x) &\geq c_i + \langle x, a^i \rangle. \end{aligned}$$

Let $i \in \mathcal{A}(\mathcal{C})$. Assume that there exists $j \notin \mathcal{A}(\mathcal{C})$ such that $P(x) = c_j + \langle x, a^j \rangle$. Because $j \notin \mathcal{A}(\mathcal{C})$, the function $y \mapsto c_j - c_i + \langle x, a^j - a^i \rangle$ is not constant over \mathcal{C} . Because $x \in \text{ri}(\mathcal{C})$, there exists x^+ and x^- in $\text{ri}(\mathcal{C})$ such that:

$$\begin{aligned} c_i + \langle x^+, a^i \rangle &> c_j + \langle x^+, a^j \rangle, \\ c_i + \langle x^-, a^i \rangle &< c_j + \langle x^-, a^j \rangle. \end{aligned}$$

Consequently, $x^- \notin \mathcal{C}$. \square

A point x such that $\{x\}$ is a 0-dimensional cell of the subdivision \mathcal{S} is called an *apex*. Note that the full-dimensional cells are the set of points in which one and only one tropical monomial is maximal, whereas the other cells are included in $\mathcal{T}(P)$. For example, the tropical line of Figure 3.1 defines a polyhedral complex with three maximal cells (the polyhedra $\{x \in \mathbb{R}^2 \mid x_1 \geq x_2, x_1 \geq 0\}$, $\{x \in \mathbb{R}^2 \mid x_2 \geq x_1, x_2 \geq 0\}$ and $\{x \in \mathbb{R}^2 \mid 0 \geq x_1, 0 \geq x_2\}$), three 1-dimensional cells (the three rays defining the hypersurface), and one 0-dimensional cell (the point $\{(0, 0)\}$ corresponding to the case $x_1 = x_2 = 0$ in which the three monomials are maximal).

Newton polytope The *Newton polytope* of the polynomial P is the polyhedron $\text{New}(P) \subset \mathbb{R}^n$ defined as:

$$\text{New}(P) = \text{Conv}(a^i, 1 \leq i \leq p),$$

that is the convex hull of the p degree vectors a_i (see Figure 3.2).

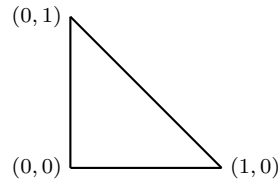

Figure 3.2: Newton polytope associated to the tropical polynomial $\max(x_1, x_2, 0)$. The vertices of this polytope are in one-to-one correspondence with the maximal cells of the subdivision defined by the tropical line.

The following construction, which takes the coefficients c_i into account, and not only the exponents, is also standard. The *extended Newton polytope* $\overline{\text{New}}(P)$ of the polynomial P is the polyhedron defined by:

$$\overline{\text{New}}(P) = \text{Conv}((a_i, r) \in \mathbb{Z}^n \times \mathbb{R}, r \leq c_i)$$

Notice that the polyhedron $\overline{\text{New}}(P)$ is included in \mathbb{R}^{n+1} and is not a polytope, because it is unbounded. Its vertices are included in the p points $(a_i, c_i) \in \mathbb{Z}^n \times \mathbb{R}$. We observe that the union of bounded faces of $\overline{\text{New}}(P)$ corresponds to the set:

$$\{(a, c(a)) \mid a \in \text{New}(P)\},$$

where $c(a)$ is defined by:

$$c = \max_{\substack{\lambda_1, \dots, \lambda_p \geq 0 \\ \sum_{i=1}^p \lambda_i = 1 \\ \sum_{i=1}^p \lambda_i a^i = a}} \sum_{i=1}^p \lambda_i c_i.$$

The union of bounded faces of $\overline{\text{New}}(P)$ corresponds to the graph of the concave function c , and $\overline{\text{New}}(P)$ is the hypograph of c . For every bounded face F' of $\overline{\text{New}}(P)$, we define the polytope $\mathcal{C}'(F')$ by:

$$\mathcal{C}'(F') = \{a \in \text{New}(P) \mid (a, c(a)) \in F'\}.$$

Hence, for every bounded face F' of $\overline{\text{New}}(P)$, $\mathcal{C}'(F')$ is the projection of F' over the n first entries. We define \mathcal{S}' as:

$$\mathcal{S}' = \{\mathcal{C}'(F') \mid F' \text{ bounded face of } \overline{\text{New}}(P)\}.$$

Proposition 3.7. \mathcal{S}' is a subdivision of $\text{New}(P)$.

Proof. Similar as Proposition 3.5. □

Relation between both subdivisions In fact, there exists a one-to-one correspondence between both subdivisions \mathcal{S} and \mathcal{S}' . For each $\mathcal{C} \in \mathcal{S}$, we define $\phi(\mathcal{C})$ by:

$$\phi(\mathcal{C}) = \text{Conv}(a^i \mid i \in \mathcal{A}(\mathcal{C})) = \text{Conv}(\mathcal{A}(\mathcal{C})).$$

Theorem 3.8 ([PR00], Theorem 1). 1. The map ϕ is a bijection between the subdivisions \mathcal{S} and \mathcal{S}' .

2. If \mathcal{C} is a k -dimensional cell of \mathcal{S} , then $\phi(\mathcal{C})$ is a $n - k$ -dimensional polyhedron of the subdivision \mathcal{S}' .

3. For two cells \mathcal{C}_1 and $\mathcal{C}_2 \in \mathcal{S}$, \mathcal{C}_1 is a face of \mathcal{C}_2 if and only if $\phi(\mathcal{C}_2)$ is a face of $\phi(\mathcal{C}_1)$.

The one-to-one correspondence between \mathcal{S} and \mathcal{S}' is illustrated on Figure 3.3.

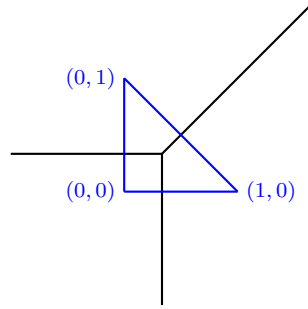

Figure 3.3: One-to-one correspondence between the tropical hypersurface associated to the polynomial $\max(x_1, x_2, 0)$ (in black) and the Newton polytope of this polynomial (in blue). The vertices of this polytope are in one-to-one correspondence with the maximal cells of the subdivision defined by the tropical line.

For every $\mathcal{C}' \in \mathcal{S}'$, the polyhedron $\phi^{-1}(\mathcal{C}')$ is:

$$\phi^{-1}(\mathcal{C}') = \{x \in \mathbb{R}^n \mid P(x) = c_i + \langle x, a^i \rangle \text{ for every } a^i \text{ vertex of } \mathcal{C}'\}.$$

We formulate some properties verified by \mathcal{S} and \mathcal{S}' .

Proposition 3.9. Let $\mathcal{C}_1, \mathcal{C}_2$ be two cells of \mathcal{S} , and $\mathcal{C}'_1, \mathcal{C}'_2$ be two cells of \mathcal{S}' .

1. If $\mathcal{C}_1 \subset \mathcal{C}_2$, then $\phi(\mathcal{C}_2) \subset \phi(\mathcal{C}_1)$.
2. If $\mathcal{C}'_1 \subset \mathcal{C}'_2$, then $\phi^{-1}(\mathcal{C}'_2) \subset \phi^{-1}(\mathcal{C}'_1)$.
3. $\phi(\mathcal{C}_1 \cap \mathcal{C}_2) = \text{Conv}(\phi(\mathcal{C}_1) \cup \phi(\mathcal{C}_2))$.

Proof. The two first statements are direct consequences of Theorem 3.8 because $\mathcal{C}_1 \subset \mathcal{C}_2$ means that \mathcal{C}_1 is a face of \mathcal{C}_2 , and $\mathcal{C}'_1 \subset \mathcal{C}'_2$ means that \mathcal{C}'_1 is a face of \mathcal{C}'_2 . $\mathcal{C}_1 \cap \mathcal{C}_2$ corresponds to the points $x \in \mathbb{R}^n$ for which the monomials $c_i + \langle x, a_i \rangle, i \in \mathcal{A}(\mathcal{C}_1) \cup \mathcal{A}(\mathcal{C}_2)$ are maximal. Hence:

$$\phi(\mathcal{C}_1 \cap \mathcal{C}_2) = \text{Conv}(a^i \mid i \in \mathcal{A}(\mathcal{C}_1) \cup \mathcal{A}(\mathcal{C}_2)) = \text{Conv}(\phi(\mathcal{C}_1) \cup \phi(\mathcal{C}_2)).$$

□

For a point $x \in \mathbb{R}^n$, we define the *minimal cell* of x as the smallest cell of \mathcal{S} containing x , that is $\mathcal{C}_x = \bigcap \{\mathcal{C} \in \mathcal{S} \mid x \in \mathcal{C}\}$. According to Proposition 3.5, \mathcal{C}_x is still a cell of \mathcal{S} and a face of all cells containing x . Moreover, $\phi(\mathcal{C}_x) = \bigcup \{\mathcal{C}' \in \mathcal{S}' \mid x \in \phi^{-1}(\mathcal{C}')\}$.

Proposition 3.10. *Let x be a point of \mathbb{R}^n and \mathcal{C} a cell of \mathcal{S} such that $x \in \mathcal{C}$ and $\mathcal{C} \notin \{x\}$. Then $\mathcal{C} = \mathcal{C}_x$ if and only if $x \in \text{ri}(\mathcal{C})$, where ri denotes the relative interior.*

Proof. Take $\mathcal{C} \in \mathcal{S}$ and $x \in \mathcal{C}$. If $x \notin \text{ri}(\mathcal{C})$, then there exists a face F of \mathcal{C} such that $x \in F$. According to Proposition 3.5, F is still a cell of \mathcal{S} and $\mathcal{C}_x \subset F \subsetneq \mathcal{C}$. Conversely, if $\mathcal{C}_x \neq \mathcal{C}$, then \mathcal{C}_x is a face of \mathcal{C} according to Proposition 3.5. Hence, x belongs to a face of \mathcal{C} , and $x \notin \text{ri}(\mathcal{C})$. \square

Proposition 3.11. *Let $x \in \mathbb{R}^n$, the set of maximal monomials for P in x is exactly $\mathcal{A}(\mathcal{C}_x)$.*

Proof. Let $x \in \mathbb{R}^n$. If $\mathcal{C}_x = \{x\}$, then $\mathcal{A}_{\mathcal{C}_x}$ is the set of monomials which are maximal for every element of \mathcal{C}_x , that is the set of maximal monomials in x . If not, $x \in \text{ri}(\mathcal{C}_x)$ by Proposition 3.10. We conclude by Proposition 3.6. \square

For a point $a \in \text{New}(P)$, we can also define the *minimal cell* of a as the smallest cell \mathcal{C}'_a in \mathcal{S}' containing a , that is $\mathcal{C}'_a = \bigcap \{\mathcal{C}' \in \mathcal{S}' \mid a \in \mathcal{C}'\}$.

Lemma 3.12. *Consider $x \in \mathbb{R}^n$ and $a \in \text{New}(P)$. Let \mathcal{C}_x be the minimal cell of x in \mathcal{S} , and \mathcal{C}'_a be the minimal cell of a in \mathcal{S}' . Then $a \in \phi(\mathcal{C}_x)$ if and only if $x \in \phi^{-1}(\mathcal{C}'_a)$.*

Proof. Suppose that $a \in \phi(\mathcal{C}_x)$. By definition of \mathcal{C}'_a , $\mathcal{C}'_a \subset \phi(\mathcal{C}_x)$. By application of Proposition 3.9, we have $\mathcal{C}_x \subset \phi^{-1}(\mathcal{C}'_a)$, and then $x \in \phi^{-1}(\mathcal{C}'_a)$. The converse proof is the same by application of Proposition 3.9. \square

Arrangement of tropical hypersurfaces and mixed subdivisions An *arrangement* of tropical hypersurfaces is a collection of tropical hypersurfaces. Consider k tropical polynomials P_1, \dots, P_k and their associated tropical hypersurfaces $\mathcal{T}(P_1), \dots, \mathcal{T}(P_k)$. The arrangement of these tropical hypersurfaces is the tropical hypersurface associated to the product of tropical polynomials, that is $\mathcal{T}(P_1) \cup \dots \cup \mathcal{T}(P_k) = \mathcal{T}(P_1 \odot \dots \odot P_k)$. The Newton polytope $\text{New}(P_1 \odot \dots \odot P_k)$ corresponds to the Minkowski sum of the Newton polytopes of each polynomial $\text{New}(P_i)$, that is $\text{New}(P_1 \odot \dots \odot P_k) = \text{New}(P_1) + \dots + \text{New}(P_k)$.

Let $\Delta_1, \dots, \Delta_k$ be k polyhedra. A subdivision \mathcal{S} of $\sum_{i=1}^k \Delta_i$ is called mixed if there exists for every $i \in [k]$ a subdivision \mathcal{S}_i of Δ_i such that the cells of \mathcal{S} are the Minkowski sum of cells of \mathcal{S}_i . A property of arrangements of tropical hypersurfaces is that the subdivision of $\text{New}(P_1 \odot \dots \odot P_k)$ which is dual to the tropical hypersurface $\mathcal{T}(P_1 \odot \dots \odot P_k)$ is mixed.

Cayley trick to study mixed subdivisions The *Cayley trick* is a classical algebraic geometry result. The polyhedral version of this trick was introduced by Sturmfels [Stu94]. Consider k polytopes $\Delta_1, \dots, \Delta_k \subset \mathbb{R}^n$, and let us denote by $(e_i)_{1 \leq i \leq k}$ the canonical basis of \mathbb{R}^k . Let us build k polytopes $\Delta_i \times \{e_i\} \subset \mathbb{R}^n \times \mathbb{R}^k$ for $i \in [k]$. The vector e_i can be considered as a label of each polytope. The *Cayley polytope* $\mathcal{C}(\Delta_1, \dots, \Delta_k)$ is defined as the convex hull of the k polytopes $\Delta_i \times \{e_i\}$ for $i \in [k]$. The Cayley polytope is related with the mixed subdivisions of the Minkowski sum $\Delta_1 + \dots + \Delta_k$ according to the following result, known as Cayley trick:

Theorem 3.13 (Cayley trick [Stu94] [HRS00]). *There exists a bijection between the set of regular subdivisions of the Cayley polytope $\mathcal{C}(\Delta_1, \dots, \Delta_k)$ and the set of mixed subdivisions of the Minkowski sum $\Delta_1 + \dots + \Delta_k$.*

Mixed volumes and BKK theorem Consider again k tropical polynomials P_1, \dots, P_k and the associated subdivision of the Newton polytope $\text{New}(P_1 \odot \dots \odot P_k)$. According to Theorem 3.8, the full-dimensional polyhedra of this subdivision correspond to the vertices of the tropical hypersurface associated to $P_1 \odot \dots \odot P_k$. These vertices correspond to the apices of the tropical hypersurfaces $\mathcal{T}(P_i)$ or to intersection points of the different hypersurfaces. The number of intersection points between the different hypersurfaces is related to the notion of *mixed volume*.

Consider k polyhedra $\Delta_1, \dots, \Delta_k$ in \mathbb{R}^n and k nonnegative real numbers t_1, \dots, t_k . The volume of the polyhedron $t_1\Delta_1 + \dots + t_k\Delta_k$ is a polynomial in the different variable t_1, \dots, t_k . We have:

$$\text{Vol}(t_1\Delta_1 + \dots + t_k\Delta_k) = \sum_{(i_1, \dots, i_n) \in [k]^n} t_{i_1} \dots t_{i_n} V(\Delta_{i_1}, \dots, \Delta_{i_n})$$

Each coefficient $V(\Delta_{i_1}, \dots, \Delta_{i_n})$ is called the *mixed volume* of the n polyhedra $\Delta_{i_1}, \dots, \Delta_{i_n}$. This coefficient is non-negative and satisfies the Alexandrov-Fenchel inequality:

$$V(\Delta_{i_1}, \Delta_{i_2}, \Delta_{i_3}, \dots, \Delta_{i_n}) \geq \sqrt{V(\Delta_{i_1}, \Delta_{i_1}, \Delta_{i_3}, \dots, \Delta_{i_n}) V(\Delta_{i_2}, \Delta_{i_2}, \Delta_{i_3}, \dots, \Delta_{i_n})}$$

We shall use the following lemma, which can be deduced from the latter inequality:

Lemma 3.14. *The mixed volume $V(\Delta_{i_1}, \dots, \Delta_{i_n})$ satisfies:*

$$V(\Delta_{i_1}, \dots, \Delta_{i_n}) \geq \left(\prod_{j=1}^n \text{Vol}(\Delta_{i_j}) \right)^{1/n}.$$

Proof. More generally, we prove by induction over p the following inequality:

$$\forall 1 \leq p \leq n, \quad V(\Delta_{i_1}, \dots, \Delta_{i_n}) \geq \left(\prod_{j=1}^p V(\Delta_{i_j}, \dots, \Delta_{i_j}, \Delta_{i_{p+1}}, \dots, \Delta_{i_n}) \right)^{1/p}.$$

The case $p = 1$ is obvious, whereas the case $p = 2$ corresponds to the classical Alexandrov-Fenchel inequality. Suppose the result holds for $p \in [n]$. Let $j \in [p]$. For $0 \leq k \leq p + 1$, we define $W_k(\Delta_{i_j})$ by:

$$W_k(\Delta_{i_j}) = V(\underbrace{\Delta_{i_j}, \dots, \Delta_{i_j}}_{p+1-k}, \underbrace{\Delta_{i_{p+1}}, \dots, \Delta_{i_{p+1}}}_k, \Delta_{i_{p+2}}, \dots, \Delta_{i_n}).$$

The induction hypothesis can be rewritten as $V(\Delta_{i_1}, \dots, \Delta_{i_n}) \geq \left(\prod_{j=1}^p W_1(\Delta_{i_j}) \right)^{1/p}$. By the Alexandrov-Fenchel inequality, we have for $1 \leq k \leq p$ the inequality

$$W_k(\Delta_{i_j})^2 \geq W_{k-1}(\Delta_{i_j}) W_{k+1}(\Delta_{i_j}),$$

showing that the sequence $\left(\frac{W_k(\Delta_{i_j})}{W_{k-1}(\Delta_{i_j})} \right)$ is nonincreasing. Then:

$$\left(\frac{W_1(\Delta_{i_j})}{W_0(\Delta_{i_j})} \right)^{p+1} \geq \prod_{k=1}^{p+1} \frac{W_k(\Delta_{i_j})}{W_{k-1}(\Delta_{i_j})} = \frac{W_{p+1}(\Delta_{i_j})}{W_0(\Delta_{i_j})},$$

that is $W_1(\Delta_{i_j})^{p+1} \geq W_0(\Delta_{i_j})^p W_{p+1}(\Delta_{i_j})$. Notice that

$$W_{p+1}(\Delta_{i_j}) = V(\Delta_{i_{p+1}}, \dots, \Delta_{i_{p+1}}, \dots, \Delta_{i_n}) := W_0(\Delta_{i_{p+1}})$$

does not depend on j . Consequently:

$$V(\Delta_{i_1}, \dots, \Delta_{i_n}) \geq \left(\prod_{j=1}^p W_1(\Delta_{i_j}) \right)^{1/p} \geq \left(\prod_{j=1}^{p+1} W_0(\Delta_{i_j})^{\frac{p}{p+1}} \right)^{1/p} = \left(\prod_{j=1}^{p+1} W_0(\Delta_{i_j}) \right)^{1/p+1},$$

which proves the result. \square

Corollary 3.15. *Let $\Delta_{i_1}, \dots, \Delta_{i_n}$ be n full-dimensional polytopes. Then $V(\Delta_{i_1}, \dots, \Delta_{i_n})$ is strictly positive.*

Proof. If $\Delta_{i_1}, \dots, \Delta_{i_n}$ are full-dimensional, then for every $j \in [n]$, $\text{Vol}(\Delta_{i_j}) > 0$. Then, by Lemma 3.14,

$$V(\Delta_{i_1}, \dots, \Delta_{i_n}) \geq \left(\prod_{j=1}^n \text{Vol}(\Delta_{i_j}) \right)^{1/n} > 0.$$

\square

Bernstein ([Ber75]) established a relation between the zeros of Laurent polynomials, that is between the intersection of the hypersurfaces defined by these polynomials, and the mixed volume of the Newton polytopes associated to these polynomials. This result known as Bernstein–Khovanskii–Kushnirenko theorem was adapted to tropical polynomials by Sturmfels (see [Stu02], Section 9.1).

Theorem 3.16 (BKK,[Ber75], [Stu02]). *Let P_1, \dots, P_n be n tropical Laurent polynomials in \mathbb{R}^n and $\mathcal{T}(P_1), \dots, \mathcal{T}(P_n)$ the associated tropical hypersurfaces. The number of intersection points of the n tropical hypersurfaces in general position is $n!V(\text{New}(P_1), \dots, \text{New}(P_n))$.*

A corollary of this result is the Bézout theorem for the tropical analogue of classical polynomials.

Corollary 3.17 (Tropical Analogue of Bézout Theorem,[Stu02]). *Let P_1, \dots, P_n be n tropical polynomials (with nonnegative integer exponents) in \mathbb{R}^n of degrees respectively equal to d_1, \dots, d_n , and $\mathcal{T}(P_1), \dots, \mathcal{T}(P_n)$ the associated tropical hypersurfaces. If $\mathcal{T}(P_1), \dots, \mathcal{T}(P_n)$ are in general position, then the number of intersection points of the n tropical hypersurfaces is bounded by the product of degrees $d_1 \dots d_n$.*

This result is an application of Theorem 3.16. Each polynomial P_i has a degree equal to d_i , and nonnegative exponents; this means that its Newton polynomial $\text{New}(P_i)$ is included in $d_i\Delta$, where Δ denotes the classical simplex of \mathbb{R}^n : $\Delta = \{x \in (\mathbb{R}_+)^n \mid \sum_{i=1}^n x_i \leq 1\}$. We have $V(\Delta, \dots, \Delta) = \text{Vol}(\Delta) = \frac{1}{n!}$. Consequently:

$$n!V(\text{New}(P_1), \dots, \text{New}(P_n)) \leq n!V(d_1\Delta, \dots, d_n\Delta) = n!d_1 \dots d_n V(\Delta, \dots, \Delta) = d_1 \dots d_n.$$

3.4 Discrete convexity

In this section, we recall some elements of discrete convexity. Discrete convexity aims to define some analogues of classical properties of convex sets or convex functions to discrete sets or functions defined over \mathbb{Z}^n . This is related to the notions of matroids and submodularity. The role of matroids and submodularity in discrete optimization was explained by Edmonds [Edm70]. Different works state then a relation between submodularity, matroids and a discrete analogue to the notion of convexity (see the introduction of Murota [Mur03], ch.1.1).

In the 1990s, Murota defines some classes of discrete sets and discrete functions with "good" properties of convexity. We focus here on a special one, called M -convex functions, and recall the elementary properties given and proved by Murota, as in his book [Mur03]. A more general theory of discrete convexity was further presented by Danilov and Koshevoy [DK04]. We also recall in this section the notion of laminar sets and laminar functions as exposed in [DK04].

Here, e_i denotes a vector of \mathbb{Z}^n with the i -th coordinate equal to 1 and the other ones equal to 0. We denote by χ_A the convex characteristic function of a set A , that is $\chi_A(x) = 0$ if $x \in A$ and $\chi_A(x) = +\infty$ otherwise.

M-convex functions We introduce first the class of M -convex functions and M -convex sets.

Definition 3.18. Let $f : \mathbb{Z}^n \rightarrow \mathbb{R}$. The *domain* of the function f , denoted by $\text{dom } f$ is:

$$\text{dom } f = \{x \in \mathbb{Z}^n \mid -\infty < f(x) < +\infty\}.$$

Definition 3.19. A function $f : \mathbb{Z}^n \mapsto \mathbb{R}$ is M -convex if for all $x, y \in \text{dom } f$ and for all i such that $x_i > y_i$, there exists j such that $x_j < y_j$ verifying the inequality:

$$f(x) + f(y) \geq f(x - e_i + e_j) + f(y + e_i - e_j)$$

The most important property of M -convex functions is that local optimality and global optimality in sense that:

Theorem 3.20 ([Mur03], th. 6.26). *Consider f a M -convex function and $x \in \text{dom } f$. Then:*

$$\forall y \in \text{dom } f, f(x) \leq f(y) \Leftrightarrow \forall i, j, f(x) \leq f(x - e_i + e_j)$$

This theorem leads to write a greedy algorithm to minimize a M -convex function (see [Mur03], Section.10.1).

Algorithm 1 Murota's algorithm to minimize a M -convex function f .

1. Find $x \in \text{dom } f$;
 2. Find $i, j \in \arg \min_{k, l \in [n]} f(x - e_k + e_l)$;
 3. If $f(x - e_i + e_j) \geq f(x)$ then stop (x is a global minimizer of g);
 4. Else $x := x - e_i + e_j$ and go back to Step 2;
-

By adding a priority rule in Step 2 of Algorithm 1 in the case where $\arg \min_{k, l \in [n]} f(x - e_k + e_l)$ is not reduced to a single point, a global minimizer of f is obtained by Algorithm 1 in pseudo-polynomial time.

Proposition 3.21 ([Mur03], Prop.10.2). *Assume that $\text{dom } f$ is bounded. Let F be the number of arithmetic operations needed to evaluate f and $K_1 = \max(\|x - y\|_1 \mid x, y \in \text{dom } f)$. Then, if a vector in $\text{dom } f$ is given, Algorithm 1 finds a global minimizer of f in $O(Fn^2K_1)$ time.*

However, the minimization of a M -convex function can be achieved in polynomial time.

Proposition 3.22 ([Mur03], Prop.10.4). *Assume that $\text{dom } f$ is bounded. Let F be the number of arithmetic operations needed to evaluate f and $K_\infty = \max(\|x - y\|_\infty \mid x, y \in \text{dom } f)$. Then, if a vector in $\text{dom } f$ is given, a global minimizer of f can be found in $O(Fn^3 \log^2(K_\infty/n))$ time.*

M -convex sets and generalized polymatroids

Definition 3.23. A set $A \subset \mathbb{Z}^n$ is said to be M -convex if χ_A is a M -convex function, that is for all $x, y \in A$ and for all i with $x_i > y_i$, there exists j with $x_j < y_j$ such that $x - e_i + e_j \in A$ and $y + e_i - e_j \in A$.

One of the consequences of this definition is the following property: consider A a M -convex set, there exists $r \in \mathbb{Z}$ such that $A \subset \{x \in \mathbb{Z}^n \mid \sum_{i=1}^n x_i = r\}$. Thanks to this property, we can define another class of discrete convex sets:

Definition 3.24. A set $A \subset \mathbb{Z}^n$ is said to be M^\natural -convex if there exists $r \in \mathbb{Z}$ such that the set $B = \{(x, r - \sum_{i=1}^n x_i) \mid x \in A\} \subset \mathbb{Z}^{n+1}$ is M -convex.

The notion of M^\natural -convex sets is directly connected to the notion of generalized polymatroids. Consider I a subset of $[n]$. We introduce the notation $x(I) := \sum_{i \in I} x_i$.

Definition 3.25 ([Mur03], Section 4.7, eq. (4.36), (4.37)). A polytope $P \subset \mathbb{R}^n$ is said to be a generalized polymatroid (or g -polymatroid) if it can be written as :

$$P = \{x \in \mathbb{R}^n \mid \forall I \subset [n], a(I) \leq x(I) \leq b(I)\}$$

where:

- $a : \mathcal{P}([n]) \rightarrow \mathbb{R} \cup \{-\infty\}$ is supermodular,
- $b : \mathcal{P}([n]) \rightarrow \mathbb{R} \cup \{+\infty\}$ is submodular,
- $\forall I, J \subset [n], b(I) - b(I \setminus J) \geq a(J) - a(J \setminus I)$.

The M^\natural -convex sets correspond to the integer points of the integer generalized polymatroids ([Mur03], Section 4.7.).

Different properties about M -convex and M^\natural -convex sets can be found in [Mur03], ch.4. We mention the following one.

Proposition 3.26 ([Mur03], th.4.23.). *Let $(A_i)_{1 \leq i \leq k}$ be a family of M -convex sets (resp. M^\natural -convex sets) of \mathbb{Z}^n . Then, $\sum_{i=1}^k A_i$ is M -convex (resp. M^\natural -convex).*

Finally, we introduce the notion of M^\natural function by analogy with the notion of M^\natural -convex set.

Definition 3.27. A function $f : \mathbb{Z}^n \mapsto \mathbb{R}$ is M^\natural -convex if $\forall x, y \in \text{dom } f$ and for all i such that $x_i > y_i$, either:

$$f(x) + f(y) \geq f(x - e_i) + f(y + e_i)$$

or there exists j such that $x_j < y_j$ verifying the inequality:

$$f(x) + f(y) \geq f(x - e_i + e_j) + f(y + e_i - e_j)$$

This definition is inherited from the definition of a M -convex function. In fact, let f be a M -convex function defined over $\text{dom } f \subset \mathbb{Z}^{n+1}$. The domain of f is a M -convex set. Then, $\{(x_1, \dots, x_n) \mid x \in \text{dom } f\}$ is a M^{\natural} -convex set of \mathbb{Z}^n . Consider $r \in \mathbb{Z}$ such that $\text{dom } f \subset \{x \in \mathbb{Z}^{n+1} \mid \sum_{i=1}^{n+1} x_i = r\}$. Let us define the function $f_r : \mathbb{Z}^n \mapsto \mathbb{R}$ by $f_r(x_1, \dots, x_n) = f(x_1, \dots, x_n, r - \sum_{i=1}^n x_i)$. The property for f to be M -convex gives exactly for f_r the condition stated in Definition 3.27.

M_2 -convex and M_2^{\natural} -convex functions The class of M -convex functions is not stable under addition but under infimal convolution. However, the sum of two M -convex functions have some interesting properties.

Definition 3.28. A function $f : \mathbb{Z}^n \rightarrow \mathbb{R}$ is said M_2 -convex if there exists two M -convex functions f_1 and f_2 such that $f = f_1 + f_2$.

A function $f : \mathbb{Z}^n \rightarrow \mathbb{R}$ is said M_2^{\natural} -convex if there exists two M^{\natural} -convex functions f_1 and f_2 such that $f = f_1 + f_2$.

Global optimality is still equivalent to local optimality in the following sense:

Theorem 3.29 ([Mur03], th. 8.33). Consider f_1, f_2 two M -convex functions and a point $x \in \text{dom } f_1 \cap \text{dom } f_2$. We have:

$$\forall y \in \mathbb{Z}^n, f_1(x) + f_2(x) \leq f_1(y) + f_2(y)$$

if and only if

$$\sum_{k=1}^p [f_1(x + e_{i_k} - e_{j_k}) - f_1(x)] + \sum_{k=1}^p [f_2(x + e_{i_{k+1}} - e_{j_k}) - f_2(x)] \geq 0$$

for any $i_1, \dots, i_p, j_1, \dots, j_p \subset [n]$ with $\{i_1, \dots, i_p\} \cap \{j_1, \dots, j_p\} = \emptyset$, where $i_{p+1} = i_1$ by convention.

This theorem comes from the interpretation of the minimization of the sum of two M -convex functions as a M -convex submodular flow problem (see [Mur03, Note 9.31]). Therefore, it leads to a polynomial algorithm for the minimization of the sum of two M -convex functions. Nevertheless, it is not applicable for the sum of more or equal than three M -convex functions.

Laminar functions

Definition 3.30. A family (A_1, \dots, A_k) of subsets of $[n]$ is said to be laminar if:

$$\forall i, j \in [k], A_i \subset A_j \text{ or } A_j \subset A_i \text{ or } A_i \cap A_j = \emptyset$$

A function f is laminar if it is of the form:

$$\forall x \in \mathbb{Z}^n, f(x) = \sum_{i=1}^k f_i \left(\sum_{j \in A_i} x_j \right)$$

If all the functions f_i are convex, the function f is laminar convex.

Example: Consider $n = 4$. The family $(\{1, 2\}, \{3\}, \{1, 2, 4\})$ is laminar because $\{1, 2\} \cup \{3\} = \emptyset$, $\{3\} \cup \{1, 2, 4\} = \emptyset$ and $\{1, 2\} \subset \{1, 2, 4\}$. For all convex functions f_1, f_2, f_3 , the function f defined on \mathbb{Z}^4 by $f(x) = f_1(x_1 + x_2) + f_2(x_3) + f_3(x_1 + x_2 + x_4)$ is laminar convex.

The notion of laminarity is interesting owing to the following theorem:

Theorem 3.31 ([Mur03], note 6.11). *A laminar convex function is M^{\natural} -convex.*

Note that the family $(\{i\}_{i=1}^n)$ is laminar, so a separable convex function is laminar convex.

Definition 3.32. A function f is called quasi-separable if it can be written:

$$\forall x \in \mathbb{Z}^n, f(x) = f_0 \left(\sum_{i=1}^n x_i \right) + \sum_{i=1}^n f_i(x_i)$$

A quasi-separable function is a laminar function based on the family (A_0, \dots, A_n) where $A_0 = \{1, \dots, n\}$ and for all $1 \leq i \leq n$, $A_i = \{i\}$. A separable function is a particular case of a quasi-separable function with $f_0 = 0$.

In order to study the sum of two discrete convex functions, the notion of quasi-separability is interesting because of the following theorem:

Proposition 3.33. *Consider $f : \mathbb{Z}^n \rightarrow \mathbb{R}$ a quasi-separable convex function and $g : \mathbb{Z}^n \rightarrow \mathbb{R}$ a laminar convex function. Then, $f + g$ is laminar convex.*

Proof. If f is quasi-separable convex and g laminar convex, then there exist a family (B_1, \dots, B_p) of subsets of $[n]$ and real univariate convex functions f_0, \dots, f_n and g_1, \dots, g_p such that $\forall x \in \mathbb{Z}^n$, $f(x) = f_0(\sum_{i=1}^n x_i) + \sum_{i=1}^n f_i(x_i)$ and $g(x) = \sum_{k=1}^p g_k(\sum_{l \in B_k} x_l)$. Let $A = (A_0, \dots, A_n)$ be the family defined by $A_0 = \{1, \dots, n\}$ and for every $i \in [n]$, $A_i = \{i\}$. Consequently, $f + g$ is laminar if the concatenation of A and B is laminar (with $A_0 = \{1, \dots, n\}$ and for all $1 \leq i \leq n$, $A_i = \{i\}$). For all $1 \leq l \leq p$, B_l is a subset of $[n] = A_0$, then $B_l \subset A_0$. For all $1 \leq i \leq n$, we have either $i \in B_l$ and then $A_i \subset B_l$, or $i \notin B_l$ and then $A_i \cap B_l = \emptyset$. Hence, the concatenation of A and B is a laminar family. \square

Theorem 3.34. *Consider $f : \mathbb{Z}^n \rightarrow \mathbb{R}$ a quasi-separable convex function and $g : \mathbb{Z}^n \rightarrow \mathbb{R}$ a M^{\natural} -convex function. Then, $f + g$ is M^{\natural} -convex.*

Proof. If f is quasi-separable, then there exists real univariate functions f_0, \dots, f_n such that $\forall x \in \mathbb{Z}^n$, $f(x) = f_0(\sum_{i=1}^n x_i) + \sum_{i=1}^n f_i(x_i)$. Then, for all $x \in \mathbb{Z}^n$ and all indices i, j , we have:

$$\begin{aligned} f(x - e_i) &= f(x) + f_i(x_i - 1) - f_i(x_i) + f_0\left(\sum_{k=1}^n x_k - 1\right) - f_0\left(\sum_{k=1}^n x_k\right) \\ f(x + e_i) &= f(x) + f_i(x_i + 1) - f_i(x_i) + f_0\left(\sum_{k=1}^n x_k + 1\right) - f_0\left(\sum_{k=1}^n x_k\right) \\ f(x - e_i + e_j) &= f(x) + f_i(x_i - 1) - f_i(x_i) + f_j(x_j + 1) - f_j(x_j) \end{aligned}$$

Consider $x, y \in \mathbb{Z}^n$ and an index i such that $x_i > y_i$. If $g(x) + g(y) \geq g(x - e_i) + g(y + e_i)$, then:

$$\begin{aligned} f(x - e_i) + g(x - e_i) + f(y + e_i) + g(y + e_i) &\leq [f(x) + g(x) + f(y) + g(y)] \\ &\quad + [f_i(x_i - 1) + f_i(y_i + 1) - f_i(x_i) - f_i(y_i)] \\ &\quad + \left[f_0\left(\sum_{k=1}^n x_k - 1\right) + f_0\left(\sum_{k=1}^n y_k + 1\right) \right. \\ &\quad \left. - f_0\left(\sum_{k=1}^n x_k\right) + f_0\left(\sum_{k=1}^n y_k\right) \right] \\ &\leq f(x) + g(x) + f(y) + g(y) \end{aligned}$$

because f_i and f_0 are convex. Otherwise, there exists j such that $x_j < y_j$ and $g(x) + g(y) \geq g(x - e_i + e_j) + g(y + e_i - e_j)$. Then:

$$\begin{aligned}
 & f(x - e_i + e_j) + g(x - e_i + e_j) + f(y + e_i - e_j) + g(y + e_i - e_j) \\
 & \leq [f(x) + g(x) + f(y) + g(y)] \\
 & \quad + [f_i(x_i - 1) + f_i(y_i + 1) - f_i(x_i) - f_i(y_i)] \\
 & \quad + [f_j(x_j + 1) + f_j(y_j - 1) - f_j(x_j) - f_j(y_j)] \\
 & \leq f(x) + g(x) + f(y) + g(y)
 \end{aligned}$$

because f_i and f_j are convex. □

In order to solve problems of minimization of sums of M -convex or M^{\square} -convex functions, quasi-separability is a very important property.

Part I

Tropical approach to bilevel
programming

CHAPTER 4

Tropical representation of bilevel programs

In this Chapter, we study a specific class of bilevel problems, modeling pricing problems in economics, in which the low-level problem can be interpreted as a tropical polynomial. We are interested in the case in which the low-level problem has a large dimension, whereas the dimension of the high-level one can be small. Hence, classical methods for solving bilevel problems relying on the Karush-Kuhn-Tucker conditions lead to large-scale non-convex optimization. We use the specific structure of this class of bilevel problems to propose a method to solve them. We find the solution of the bilevel problem by taking the minimal value of optimization subproblems. Each subproblem is associated to a different cell of the polyhedral complex associated to the tropical hypersurface defined by the low-level problem. We also prove that this method leads to a polynomial algorithm when the dimension of the high-level problem is fixed. To conclude, we generalize the results to other classes of bilevel problems.

4.1 A special class of bilevel problems

Bilevel programming refers to the study of optimization problems in which the constraint set contains another optimization problem (see Chapter 3, Section 3.1 for background). Bilevel programming problems are particularly well adapted to model pricing problems in economics.

In this chapter, we will study bilevel programming problems of the form:

Problem 4.1 (Continuous problem).

$$\text{“min”}_{y \in \mathbb{R}^n} f(C^T x^*, y) \quad (4.1)$$

where the follower chooses x^* as a solution of:

$$\max_{x \in \mathcal{P}} \langle \rho + Cy, x \rangle \quad (4.2)$$

where \mathcal{P} is a polytope of \mathbb{R}^k , $C \in \mathcal{M}_{k,n}(\mathbb{Z})$ and $\rho \in \mathbb{R}^k$,

and:

Problem 4.2 (Discrete problem).

$$\text{“min”}_{y \in \mathbb{R}^n} f(C^T x^*, y) \quad (4.3)$$

where the follower chooses x^* as a solution of:

$$\max_{x \in \mathcal{I}(\mathcal{P})} \langle \rho + Cy, x \rangle \quad (4.4)$$

where $\mathcal{I}(\mathcal{P})$ is the set of integer points of \mathcal{P} , that is $\mathcal{I}(\mathcal{P}) = \mathcal{P} \cap \mathbb{Z}^k$.

We assume for the latter problem that \mathcal{P} satisfies the following assumption.

Assumption A. The polytope \mathcal{P} considered in Problem 4.2 is an integer polytope, that is the extreme points of \mathcal{P} are integer.

We do not assume anything concerning the function f for the moment. In particular, f can take the $+\infty$ value, encoding some constraints of the high-level problem.

This class of bilevel programming problems corresponds to the following economic situation. Consider a producer which wants to sell n different goods. He has a decision vector $y \in \mathbb{R}^n$ such that the price of each good is $-y_i$ for $i \in [n]$. The producer proposes k different bundles of these different goods. The quantity he sells is modeled by a vector $x = (x_1, \dots, x_k) \in \mathbb{R}^k$, where x_j is the quantity of bundle j he sells. We can constrain the set of possible vectors x to belong to a polytope \mathcal{P} . If we consider indivisible goods, then the vector x is also constrained to be an integer point, that is to belong to the set of integer points of a polytope $\mathcal{I}(\mathcal{P}) = \mathcal{P} \cap \mathbb{Z}^k$. Because of couplings between the different goods in each bundle, the vector of prices of the different bundles is $-Cy \in \mathbb{R}^k$, with $C \in \mathcal{M}_{k,n}(\mathbb{R})$. It means also that the quantity of each good sold by the producer is $C^T x$. The producer sells the bundles to a customer, who has preferences for buying the different bundles. The measure of these preference is a vector $\rho \in \mathbb{R}^k$, meaning that when the price is $-y$, the utility vector of the customer becomes $\rho + Cy$. Hence, he determines his optimal consumption x^* by maximizing his utility $\langle \rho + Cy, x \rangle$ subject to $x \in \mathcal{P}$ (or $x \in \mathcal{I}(\mathcal{P})$ for indivisible goods). The costs of the producer can be considered as a function f depending on his decision vector y and on the quantity of goods he sold $C^T x^*$ and chooses the vector y to minimize his costs.

Sometimes, when the feasible set of the low-level is discrete, it can be viewed as a set of extreme points of a polytope. We will also study this other combinatorial problem, that is the following bilevel programming problem:

Problem 4.3 (Extreme points bilevel problem).

$$\text{“min”}_{y \in \mathbb{R}^n} f(C^T x^*, y) \quad (4.5)$$

where the follower takes x^* as a solution of:

$$\max_{x \in \mathcal{E}(\mathcal{P})} \langle \rho + Cy, x \rangle \quad (4.6)$$

where $\mathcal{E}(\mathcal{P})$ is the set of extreme points of \mathcal{P} .

The low-level values of Problem 4.3 and Problem 4.1 are equal, since the maximum of a linear function over a polytope is the maximal value of this function evaluated in the vertices of this polytope. When Assumption A is satisfied, the extreme points of \mathcal{P} are integer, and the low-level value of Problem 4.2 is also equal to the low-level value of Problem 4.3. However, the sets of solutions of these low-level problems are different. Consequently, Problem 4.1, Problem 4.3 and Problem 4.2 are not equivalent.

Bilevel programming problems are generally NP-hard, even when the high-level and low-level problems are linear programs ([Jer85]).

Different classical approaches exist to develop algorithms for solving bilevel programs (see [CMS07] and [SMD17] for surveys). The most classical ones consist in replacing the low-level problem by its associated Karush-Kuhn-Tucker conditions when it is convex. It reduces the global bilevel problem to an one-level programming problem. However, the complementary slackness constraint introduces a non-convexity. For a linear-linear bilevel problem (all the objective functions and constraints are linear), combinatorial approaches have been developed ([MS05]). The bilevel problem is reformulated in a one-level problem in mixed variables and can be solved with branch-and-bound algorithms. However, in view of the NP-hardness of the problem, we cannot expect an universal efficient method to solve bilevel programming problems.

In the different bilevel problems 4.1 (continuous), 4.2 (discrete) and 4.3 (with extreme points), the low-level problem defines a tropical polynomial in the decision variable of the "leader" (see Chapter 3, Section 3.1 for background). Tropical algebra refers to the study of the max-plus semifield $\mathbb{R} \cup \{-\infty\}$ with the laws \oplus and \odot corresponding respectively to the maximal value and to the classical addition, that is $a \oplus b = \max(a, b)$ and $a \odot b = a + b$. A tropical polynomial, which is the tropical analogue of a classical polynomial, corresponds to a convex and piecewise-linear function with integer slopes.

We present in Section 4.2 the interpretation of the low-level problem in terms of tropical polynomial. This interpretation comes essentially from the discreteness of the feasible sets of the low-level problems in Problem 4.2 and 4.3. For Problem 4.1 (continuous bilevel problem), this interpretation is possible because maximizing a linear function over a polytope is equivalent to maximize it over the set of extreme points of this polytope, which is discrete. It is hence possible to study continuous as well as discrete linear optimization problems for the low-level problem with the point of view of tropical geometry.

We mention the following economic situation which is a particular case of the situation studied in this chapter. A producer sells n goods to a set of q customers. He proposes a price $-y_i$ for good i . Each customer j (for $j \in [q]$) has a consumption vector $x^j \in \mathbb{R}^n$, where $x^j(i)$ denotes the quantity of good i that customer j buys. The consumption x^j is constrained to belong to a polytope \mathcal{P}^j , or to the integer points of \mathcal{P}^j if the goods are indivisible. Customer j has also a preference vector $\rho^j \in \mathbb{R}^n$ for buying the different goods. Hence, each customer j maximizes his utility $\langle \rho^j + y, x^j \rangle$ with the constraint $x^j \in \mathcal{P}^j$ (or $x^j \in \mathcal{P}^j \cap \mathbb{Z}^n$). Denoting by

x^{j*} the optimal consumption of customer j , the producer wants to minimize his costs, modeled by a function f depending on his decision vector y and on the global solds $z = \sum_{j=1}^q x^{j*}$. This leads to the following bilevel problems:

Problem 4.4.

$$\text{“min”}_{y \in \mathbb{R}^n} f\left(\sum_{j=1}^q x^{j*}, y\right) \quad (4.7)$$

with for all $j \in [q]$, x^{j*} solution of:

$$\max_{x^j \in \mathcal{P}^j} \langle \rho^j + y, x^j \rangle \quad (4.8)$$

and:

Problem 4.5.

$$\text{“min”}_{y \in \mathbb{R}^n} f\left(\sum_{j=1}^q x^{j*}, y\right) \quad (4.9)$$

with x^* solution of:

$$\max_{x^j \in \mathcal{P}^j \cap \mathbb{Z}^n} \langle \rho^j + y, x^j \rangle \quad (4.10)$$

In fact, Problems 4.4 and 4.5 are a particular case of the continuous bilevel problems 4.1 and discrete bilevel problem 4.2, where $k = qn$, \mathcal{P} is a polytope of \mathbb{R}^k defined by $\mathcal{P} = \mathcal{P}^1 \times \dots \times \mathcal{P}^q$ and:

$$C = \begin{pmatrix} I_n \\ \dots \\ I_n \end{pmatrix} \quad \text{and} \quad \rho = \begin{pmatrix} \rho^1 \\ \dots \\ \rho^q \end{pmatrix}$$

We are especially interested in the case $n \ll k$, meaning that the number of bundles is much larger than the number of goods, or that the producer sells his different goods to a large number of customers. This hypothesis means that we are concerned with an algorithm whose complexity is not large in k , especially polynomial in k , despite the studied problems are NP-hard.

One of the most classical method for solving Problem 4.1 consists in replacing the low-level problem by its KKT conditions. Suppose that $\mathcal{P} = \{x \in \mathbb{R}^k \mid Ax \leq b\} \neq \emptyset$, with $b \in \mathbb{R}^p$ and $A \in \mathcal{M}_{p,k}(\mathbb{R})$. Then, the low-level of Problem 4.1 is $\max_{x \in \mathbb{R}^k, Ax \leq b} \langle \rho + Cy, x \rangle$. The associated Lagrangian is the function $(x, \lambda) \in \mathbb{R}^k \times \mathbb{R}_+^p \mapsto \langle \rho + Cy, x \rangle - \lambda^T (Ax - b)$. Hence, a point $x^* \in \mathcal{P}$ is an optimal solution of the low-level problem of Problem 4.1 if and only if there exists $\lambda \in \mathbb{R}_+^p$ such that the following KKT conditions are satisfied:

$$\begin{aligned} \rho + Cy - A^T \lambda &= 0 \\ \lambda &\geq 0 \\ \lambda^T (Ax^* - b) &= 0. \end{aligned}$$

Proposition 4.6. *The optimistic version of Problem 4.1 is equivalent to:*

$$\min_{y \in \mathbb{R}^n, x^* \in \mathbb{R}^k} \left\{ f(C^T x^*, y) \mid \exists \lambda \in \mathbb{R}_+^p, \rho + Cy - A^T \lambda = 0, \lambda^T (Ax^* - b) = 0 \right\}.$$

The pessimistic version of Problem 4.1 is equivalent to:

$$\min_{y \in \mathbb{R}^n} \max_{x^* \in \mathbb{R}^k} \left\{ f(C^T x^*, y) \mid \exists \lambda \in \mathbb{R}_+^p, \rho + Cy - A^T \lambda = 0, \lambda^T (Ax^* - b) = 0 \right\}.$$

Proof. It comes straightforwardly from the characterizations of the optimistic (3.1) and pessimistic (3.2) versions of a bilevel programming problem and from replacing the optimality of the low-level problem by its KKT conditions. \square

The one-level reformulations given by Proposition 4.6 are in dimension $n + k + p$ which can be very large. Moreover, because of the complementary slackness condition, these problems are non-linear and non-convex. Hence, they are difficult to solve.

In [DF14], Dempe and Franke study the optimistic version of a bilevel programming problem corresponding to Problem 4.1 with $n = k$, $C = I_n$, $\rho = 0$ and $f(C^T x^*, y) = a_1^T x^* + a_2^T y + \chi_{y \in \Delta}(y)$, where Δ is a polyhedron. They propose an algorithm providing a global optimal solution to the studied bilevel problem. However, no complexity bound is provided for such an algorithm.

We further study in Section 4.3 some generalizations. First, we extend the discrete problem 4.2 to concave low-level objective functions. We then study a generalization of the high-level problem in which the matrix C not appears.

4.2 A tropical approach for the bilevel problem

4.2.1 Low-level problem as a tropical polynomial

The structure of the low-level problem in Problems 4.1, 4.2 and 4.3 can be studied thanks to tropical geometry. Baldwin and Klemperer ([BK12]), and Yu and Tran ([TY15]), already proposed an approach based on tropical geometry to solve economic problems, more precisely auction problems. Here, we use tropical geometry to obtain a combinatorial approach of the bilevel programming problem, and to identify cases solvable in polynomial time.

Let us consider first the continuous bilevel Problem 4.1. The value of the low-level problem corresponds to the evaluation of a tropical polynomial of the variable $Cy \in \mathbb{R}^k$. As in Section 3.3, we call *tropical polynomial* a convex piecewise linear function. We do not require that the slopes are integer vectors. Let P be the tropical polynomial in k variables defined by:

$$\forall u \in \mathbb{R}^k, P(u) = \bigoplus_{x \in \mathcal{E}(\mathcal{P})} \langle \rho, x \rangle \odot u^{\odot x} = \max_{x \in \mathcal{E}(\mathcal{P})} [\langle u, x \rangle + \langle \rho, x \rangle],$$

where $\mathcal{E}(\mathcal{P})$ is the set of extreme points of \mathcal{P} . Because \mathcal{P} is a polytope, the set $\mathcal{E}(\mathcal{P})$ of these extreme points is finite, and the previous definition of P corresponds to a tropical polynomial. Then, we have:

$$\max_{x \in \mathcal{P}} \langle \rho + Cy, x \rangle = \max_{x \in \mathcal{E}(\mathcal{P})} \langle \rho + Cy, x \rangle = P(Cy), \quad (4.11)$$

meaning that the low-level value of Problem 4.1 is the evaluation of the tropical polynomial P at point Cy . Moreover, we can write:

$$\max_{x \in \mathcal{P}} \langle \rho + Cy, x \rangle = \max_{x \in \mathcal{P}} [\langle y, C^T x \rangle + \langle \rho, x \rangle] = \max_{z \in \mathbb{R}^n} [\langle y, z \rangle + \varphi(z)], \quad (4.12)$$

where the function φ is defined on \mathbb{R}^n by:

$$\varphi(z) = \max_{x \in \mathcal{P}, z = C^T x} \langle \rho, x \rangle.$$

The value $\varphi(z)$ is finite if and only if $z \in C^T \mathcal{P}$, that is the polyhedron $C^T \mathcal{P}$ is the domain of the function φ .

Lemma 4.7. *The function φ is polyhedral concave, meaning that the hypograph of φ is a convex polyhedron.*

Proof. For every $y \in \mathbb{R}^n$, we have:

$$P(Cy) = \max_{x \in \mathcal{E}(\mathcal{P})} \langle y, C^T x \rangle + \langle \rho, x \rangle.$$

Then, the function $y \mapsto P(Cy)$ is polyhedral convex. Because for every $y \in \mathbb{R}^n$, we have $P(Cy) = \max_{z \in \mathbb{R}^n} [\langle y, z \rangle + \varphi(z)]$, the function $-\varphi$ is the Legendre-Fenchel transform of $y \mapsto P(Cy)$. Hence, it is a polyhedral convex function [Roc70, Th. 19.2]. \square

The value of the low-level problem of Problem 4.1 corresponds also to the evaluation of another tropical polynomial Q . Let Q be the tropical polynomial in n variables in the variable $y \in \mathbb{R}^n$ defined by:

$$Q(y) = \bigoplus_{z \in C^T \mathcal{E}(\mathcal{P})} \varphi(z) \odot y^{\odot z} = \max_{z \in C^T \mathcal{E}(\mathcal{P})} [\langle y, z \rangle + \varphi(z)].$$

The function Q is a tropical polynomial function since the set $C^T \mathcal{E}(\mathcal{P})$ is finite. For every $y \in \mathbb{R}^n$, we have:

$$Q(y) = \max_{z \in C^T \mathcal{E}(\mathcal{P})} [\langle y, z \rangle + \varphi(z)] = \max_{x \in \mathcal{E}(\mathcal{P})} \langle \rho + Cy, x \rangle = P(Cy), \quad (4.13)$$

meaning that $Q(y)$ is the low-level value of Problem 4.1. In particular, we have $Q^* = -\varphi$, where Q^* denotes the conjugate function of Q .

In the case $n \leq k$, and overall in the case $n \ll k$, to study Q instead of P is equivalent to study the low-level problem in a "small" dimension space (\mathbb{R}^n) instead of a "large" dimension one (\mathbb{R}^k). It is even possible to draw the tropical hypersurface associated to Q in some examples (see Example 4.11 further).

The different monomials $y \mapsto \langle y, z \rangle + \varphi(z)$ for $z \in C^T \mathcal{E}(\mathcal{P})$ are not essential for Q . We denote by $V(Q)$ the subset of essential monomials for Q , that is:

$$V(Q) = \{z \in C^T \mathcal{E}(\mathcal{P}) \mid \exists y \in \mathbb{R}^n, \langle y, z \rangle + \varphi(z) > \max_{z' \in C^T \mathcal{E}(\mathcal{P}) \setminus \{z\}} \langle y, z' \rangle + \varphi(z')\}.$$

The epigraph of Q is the $(n+1)$ -dimensional polyhedron defined by the following inequalities:

$$\text{epi}(Q) = \{(y, y_{n+1}) \in \mathbb{R}^n \times \mathbb{R} \mid \forall z \in V(Q), y_{n+1} \geq \langle y, z \rangle + \varphi(z)\}.$$

Lemma 4.8. *The function φ is the concave closure of its restriction to $V(Q)$.*

Proof. The function φ is polyhedral and concave according to Lemma 4.7. Moreover, $-\varphi = Q^*$, where Q^* is the Legendre-Fenchel transform of Q . This statement comes from the equality:

$$\forall y \in \mathbb{R}^n, Q(y) = \max_{z \in \mathbb{R}^n} [\langle y, z \rangle + \varphi(z)].$$

By definition of $V(Q)$, we have for every $y \in \mathbb{R}^n$:

$$Q(y) = \max_{z \in V(Q)} [\langle y, z \rangle + \varphi(z)] = \max_{z \in \mathbb{R}^n} [\langle y, z \rangle + \varphi(z) - \chi_{V(Q)}(z)],$$

where $\chi_{V(Q)}$ is the convex characteristic function of $V(Q)$, that is $\chi_{V(Q)}(z) = 0$ if $z \in V(Q)$ and $\chi_{V(Q)}(z) = +\infty$ otherwise. Then, we have $Q = (-\varphi + \chi_{V(Q)})^*$, that is $-\varphi = (-\varphi + \chi_{V(Q)})^{**}$. Since the convex closure of a function is equal to its biconjugate, we deduce the statement of the lemma. \square

Corollary 4.9. *The Newton polytope of Q is $\text{New}(Q) = C^T \mathcal{P}$.*

Proof. By Lemma 4.8, the function φ is the concave closure of $\varphi - \chi_{V(Q)}$. Hence, $\varphi(z)$ is finite if and only if z belongs to the convex hull of $V(Q)$, that is $\text{New}(Q)$. We conclude by the definition of φ . \square

The extended Newton polytope of Q is:

$$\overline{\text{New}}(Q) = \text{Conv}(\{(z, r) \in V(Q) \times \mathbb{R} \mid r \leq \varphi(z)\}).$$

Since φ is the concave closure of $\varphi - \chi_{V(Q)}$, the extended Newton polytope of Q is also $\text{Conv}(\{(z, r) \in C^T \mathcal{P} \times \mathbb{R} \mid r \leq \varphi(z)\})$.

Lemma 4.10. *For every cell $\mathcal{C}' \in \mathcal{S}'$, the restriction of φ to \mathcal{C}' is affine.*

Proof. By definition of \mathcal{S}' , a cell $\mathcal{C}' \in \mathcal{S}'$ is a projection of a bounded face F' of $\overline{\text{New}}(Q)$. By definition of $\overline{\text{New}}(Q)$, we have:

$$F' = \{(z, \varphi(z)) \mid z \in \mathcal{C}'\}.$$

Then, ϕ is affine over \mathcal{C}' . \square

As explained in Section 3.3, the tropical polynomial Q defines a regular subdivision \mathcal{S} of \mathbb{R}^n , which is the collection of the projection of the faces of $\text{epi}(Q)$ over the n first entries. For each $\mathcal{C} \in \mathcal{S}$, there exists a non-empty subset \mathcal{A} of $V(Q)$ such that $\mathcal{C} = \mathcal{C}_{\mathcal{A}}$, where $\mathcal{C}_{\mathcal{A}}$ is the set of vectors $y \in \mathbb{R}^n$ which satisfy:

$$\begin{aligned} \forall z, z' \in \mathcal{A}, \langle y, z \rangle + \varphi(z) &= \langle y, z' \rangle + \varphi(z'), \\ \forall z \in \mathcal{A}, \forall z' \in C^T \mathcal{E}(\mathcal{P}) \setminus \mathcal{A}, \langle y, z \rangle + \varphi(z) &\geq \langle y, z' \rangle + \varphi(z'). \end{aligned}$$

We define the subset $\mathcal{A}(\mathcal{C})$ of $V(Q)$ by:

$$\mathcal{A}(\mathcal{C}) = \bigcup \{\mathcal{A} \mid \mathcal{C} = \mathcal{C}_{\mathcal{A}}\}.$$

Moreover, the subdivision \mathcal{S} is dual to a regular subdivision \mathcal{S}' of $C^T \mathcal{P}$, which is the collection of the projection of the bounded faces of $\overline{\text{New}}(Q)$ over the n first entries. For each $\mathcal{C} \in \mathcal{S}$, there exists a non-empty subset \mathcal{A} of $V(Q)$ such that \mathcal{C} is the set of vectors $z \in C^T \mathcal{P}$ which satisfy:

$$\mathcal{C}' = \text{Conv}(z \mid z \in \mathcal{A}).$$

There exists a bijection ϕ between \mathcal{S} and \mathcal{S}' (Theorem 3.8). The map ϕ is defined over \mathcal{S} by:

$$\forall \mathcal{C} \in \mathcal{S}, \phi(\mathcal{C}) = \text{Conv}(z \mid z \in \mathcal{A}(\mathcal{C})) = \text{Conv}(\mathcal{A}(\mathcal{C})).$$

Conversely, for each $\mathcal{C}' \in \mathcal{S}'$, the polyhedron $\phi^{-1}(\mathcal{C}')$ is the set of vectors $y \in \mathbb{R}^n$ such that :

$$\begin{aligned} \forall z, z' \in \mathcal{A}(\phi^{-1}(\mathcal{C}')), \langle y, z \rangle + \varphi(z) &= \langle y, z' \rangle + \varphi(z'), \\ \forall z \in \mathcal{A}(\phi^{-1}(\mathcal{C}')), \forall z' \in C^T \mathcal{E}(\mathcal{P}) \setminus \mathcal{A}(\phi^{-1}(\mathcal{C}')), \langle y, z \rangle + \varphi(z) &\geq \langle y, z' \rangle + \varphi(z'), \end{aligned}$$

where $\mathcal{A}(\phi^{-1}(\mathcal{C}'))$ is the set of vertices of \mathcal{C}' . For every $y \in \mathbb{R}^n$, we define the minimal cell \mathcal{C}_y in \mathcal{S} as the intersection of all cells of \mathcal{S} containing y , that is:

$$\mathcal{C}_y = \bigcap \{\mathcal{C} \in \mathcal{S} \mid y \in \mathcal{C}\}.$$

Similarly, we define for every $z \in C^T \mathcal{P}$ the minimal cell \mathcal{C}'_z in \mathcal{S}' as the intersection of all cells of \mathcal{S} containing y , that is:

$$\mathcal{C}'_z = \bigcap \{\mathcal{C}' \in \mathcal{S}' \mid z \in \mathcal{C}'\}.$$

Finally, we consider the partition of \mathcal{S} and \mathcal{S}' obtained by grouping the polyhedra according to their dimension. Thus, for $0 \leq d \leq n$, we define \mathcal{S}_d as:

$$\mathcal{S}_d = \{\mathcal{C} \in \mathcal{S} \mid \mathcal{C} \text{ is a } d\text{-dimensional polyhedron}\},$$

and \mathcal{S}'_d as:

$$\mathcal{S}'_d = \{\mathcal{C}' \in \mathcal{S}' \mid \mathcal{C}' \text{ is a } d\text{-dimensional polyhedron}\}.$$

According to Theorem 3.8, ϕ defines a bijection between \mathcal{S}_d and \mathcal{S}'_{n-d} for every $d \in [n]$.

Example 4.11. Let us take $n = 2$ and $k = 4$. We define the polytope \mathcal{P} by $\mathcal{P} = \{x \in \mathbb{R}^4 \mid \forall i, 0 \leq x_i \leq 1 \text{ and } x_1 + x_3 \leq 1\}$. We consider $\rho \in \mathbb{R}^4$ and $C \in \mathcal{M}_{4,2}(\mathbb{Z})$ defined by:

$$\rho = \begin{pmatrix} -2 \\ -1 \\ 0 \\ 1 \end{pmatrix} \quad \text{et} \quad C = \begin{pmatrix} 1 & 0 \\ 0 & 1 \\ 1 & 0 \\ 0 & 1 \end{pmatrix}$$

So, we have $C^T \mathcal{E}(\mathcal{P}) = \{(0, 0); (1, 0); (0, 1); (1, 1); (0, 2); (1, 2)\}$, that is $\text{New}(Q) = C^T \mathcal{P} = [0, 1] \times [0, 2]$. Consequently, the tropical polynomial Q is defined by $Q(y) = \max(0, y_1, y_2 + 1, y_1 + y_2 + 1, 2y_2, y_1 + 2y_2)$. We can draw in \mathbb{R}^2 the tropical hypersurface associated to Q (see Figure 4.1). As we are in dimension 2, the hypersurface is actually a (tropical) curve.

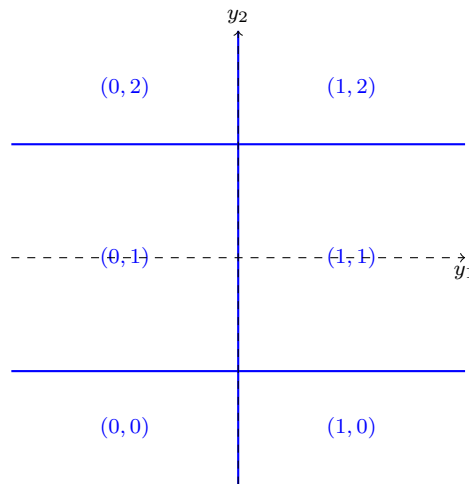
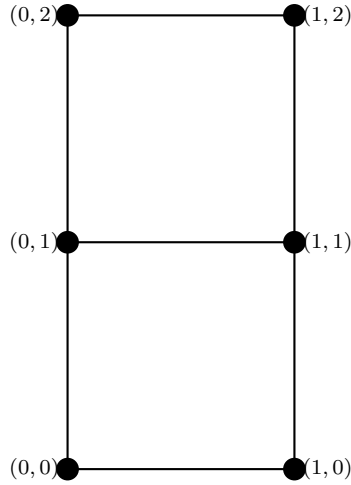

Figure 4.1: Tropical hypersurface $\mathcal{T}(Q)$ associated to the polynomial Q . It subdivides \mathbb{R}^2 in different cells. The degree of the monomial which attains the maximum in Q is mentioned in each full-dimensional cell.

We observe that all the monomials $\langle y, z \rangle + \varphi(z)$ for $z \in C^T \mathcal{E}(\mathcal{P})$ are essential. The tropical hypersurface $\mathcal{T}(Q)$ subdivides \mathbb{R}^n in different cells. This defines the subdivision \mathcal{S} . We can also draw the dual subdivision \mathcal{S}' of the Newton polytope (see Fig. 4.2).

Figure 4.2: Dual subdivision \mathcal{S}' of the Newton polytope $\text{New}(Q) = [0, 1] \times [0, 2]$.

Then, we can enumerate the cells of \mathcal{S} together with the cells of \mathcal{S}' . The map ϕ defines a bijection between the d -dimensional cells of \mathcal{S} and the $(2-d)$ -dimensional cells of \mathcal{S}' . Each cell $\mathcal{C}' \in \mathcal{S}'$ can be written $\mathcal{C}' = \phi(\mathcal{C})$, where $\mathcal{C} \in \mathcal{S}$. $\phi(\mathcal{C})$ is the convex hull of the points $z \in C^T \mathcal{E}(\mathcal{P})$ such that the monomial $\langle y, z \rangle + \varphi(z)$ is maximal for every $y \in \mathcal{C}$. We list in Table 4.1 all the cells of \mathcal{S} and their dual cells $\phi(\mathcal{C})$.

	\mathcal{C}	$\phi(\mathcal{C})$
$\mathcal{C} \in \mathcal{S}_2 \Leftrightarrow \phi(\mathcal{C}) \in \mathcal{S}'_0$	$\{(y_1, y_2) \in \mathbb{R}^2 \mid y_1 \leq 0, y_2 \leq -1\}$ $\{(y_1, y_2) \in \mathbb{R}^2 \mid y_1 \geq 0, y_2 \leq -1\}$ $\{(y_1, y_2) \in \mathbb{R}^2 \mid y_1 \leq 0, -1 \leq y_2 \leq 1\}$ $\{(y_1, y_2) \in \mathbb{R}^2 \mid y_1 \geq 0, -1 \leq y_2 \leq 1\}$ $\{(y_1, y_2) \in \mathbb{R}^2 \mid y_1 \leq 0, y_2 \geq 1\}$ $\{(y_1, y_2) \in \mathbb{R}^2 \mid y_1 \geq 0, y_2 \geq 1\}$	$\{(0, 0)\}$ $\{(1, 0)\}$ $\{(0, 1)\}$ $\{(1, 1)\}$ $\{(0, 2)\}$ $\{(1, 2)\}$
$\mathcal{C} \in \mathcal{S}_1 \Leftrightarrow \phi(\mathcal{C}) \in \mathcal{S}'_1$	$\{(y_1, y_2) \mid y_1 = 0, y_2 \leq -1\}$ $\{(y_1, y_2) \mid y_1 \leq 0, y_2 = -1\}$ $\{(y_1, y_2) \mid y_1 \geq 0, y_2 = -1\}$ $\{(y_1, y_2) \mid y_1 = 0, -1 \leq y_2 \leq 1\}$ $\{(y_1, y_2) \mid y_1 \leq 0, y_2 = 1\}$ $\{(y_1, y_2) \mid y_1 \geq 0, y_2 = 1\}$ $\{(y_1, y_2) \mid y_1 = 0, y_2 \geq 1\}$	$\text{Conv}((0, 0), (1, 0))$ $\text{Conv}((0, 0), (0, 1))$ $\text{Conv}((1, 0), (1, 1))$ $\text{Conv}((0, 1), (1, 1))$ $\text{Conv}((0, 1), (0, 2))$ $\text{Conv}((1, 1), (1, 2))$ $\text{Conv}((0, 2), (1, 2))$
$\mathcal{C} \in \mathcal{S}_0 \Leftrightarrow \phi(\mathcal{C}) \in \mathcal{S}'_2$	$\{(0, -1)\}$ $\{(0, 1)\}$	$\text{Conv}((0, 0), (0, 1), (1, 0), (1, 1))$ $\text{Conv}((0, 1), (1, 1), (0, 2), (1, 2))$

Table 4.1: List of cells of \mathcal{S} and of dual cells of \mathcal{S}' , classed by their dimensions.

4.2.2 Tropical interpretation of Problem 4.1

In this section, we study Problem 4.1 (continuous bilevel problem). We show that the tropical approach presented in Section 4.2.1 leads to a reduction of both optimistic and pessimistic versions of Problem 4.1 into a collection of optimization subproblems. Each subproblem is associated to a cell of the subdivision \mathcal{S} induced by the tropical polynomial Q .

First, we characterize the set of possible solutions of the low-level stage of Problem 4.1 (continuous bilevel problem).

Proposition 4.12. *For all $z^* \in C^T\mathcal{P}$, there exists a vector $y \in \mathbb{R}^n$ such that z^* is a solution of $\max_{z \in C^T\mathcal{P}} [\langle y, z \rangle + \varphi(z)]$,*

Proof. By Lemma 4.7, the function φ is polyhedral concave. Then, the condition:

$$z^* \in \arg \max_{z \in C^T\mathcal{P}} [\langle y, z \rangle + \varphi(z)]$$

is equivalent to $y \in \partial(-\varphi)(z^*)$ where ∂ denotes the subdifferential of a convex function. Moreover, $\partial(-\varphi)(z^*) \neq \emptyset$ if and only if $(-\varphi)(z^*) < +\infty$ ([Roc70, Th. 23.10]). Because the domain of the function $-\varphi$ is the polyhedron $C^T\mathcal{P}$, we deduce that for all $z^* \in C^T\mathcal{P}$, there exists a vector $y \in \mathbb{R}^n$ such that $y \in \partial(-\varphi)(z^*)$. \square

Lemma 4.13. *The continuous bilevel programming problem 4.1 is equivalent to:*

$$\text{“min”}_{y \in \mathbb{R}^n} f(z^*, y)$$

with z^* solution of $\max_{z \in C^T\mathcal{P}} [\langle y, z \rangle + \varphi(z)]$.

Proof. We have the following equality:

$$\max_{x \in \mathcal{P}} \langle \rho + Cy, x \rangle = \max_{x \in \mathcal{P}} \langle y, C^T x \rangle + \langle \rho, x \rangle = \max_{z \in C^T\mathcal{P}} \left[\langle y, z \rangle + \max_{x \in \mathcal{P}, C^T x = z} \langle \rho, x \rangle \right] \quad (4.14)$$

$$= \max_{z \in C^T\mathcal{P}} [\langle y, z \rangle + \varphi(z)] \quad (4.15)$$

Then, $x^* \in \arg \max_{x \in \mathcal{P}} \langle \rho + Cy, x \rangle$ implies that $C^T x^* \in \arg \max_{z \in C^T\mathcal{P}} [\langle y, z \rangle + \varphi(z)]$. Conversely, if $z^* \in \arg \max_{z \in C^T\mathcal{P}} [\langle y, z \rangle + \varphi(z)]$, then for all $z \in C^T\mathcal{P}$, we have $\langle y, z^* \rangle + \varphi(z^*) \geq \langle y, z \rangle + \varphi(z)$. Consider $x^* \in \mathcal{P}$ such that $z^* = C^T x^*$ and $\varphi(z^*) = \langle \rho, x^* \rangle$. Then for all $x \in \mathcal{P}$, we have:

$$\langle \rho + Cy, x \rangle = \langle y, C^T x \rangle + \langle \rho, x \rangle \leq \langle y, C^T x \rangle + \varphi(C^T x) \leq \langle y, z^* \rangle + \varphi(z^*) = \langle \rho + Cy, x^* \rangle.$$

Then, $x^* \in \arg \max_{x \in \mathcal{P}} \langle \rho + Cy, x \rangle$. Consequently, the two conditions

$$z^* \in \arg \max_{z \in C^T\mathcal{P}} [\langle y, z \rangle + \varphi(z)]$$

and

$$z^* = C^T x^* \quad \text{with} \quad x^* \in \arg \max_{x \in \mathcal{P}} \langle \rho + Cy, x \rangle$$

are equivalent. The result follows straightforwardly. \square

The tropical interpretation of the low-level problem leads to a new approach for solving Problem 4.1 (the continuous bilevel problem). The cells of the subdivision \mathcal{S}' of the Newton polytope of the tropical polynomial defined by the low-level problem correspond exactly to the possible values of the solutions of the low-level problem, i.e, to the "combinatorial type" of the response of the follower. For every $y \in \mathbb{R}^n$, we recall that $\mathcal{C}_y = \cap\{\mathcal{C} \in \mathcal{S} \mid y \in \mathcal{C}\}$. By Proposition 3.11, the non-empty subset $\mathcal{A}(\mathcal{C}_y)$ of $V(Q)$ is the set of maximal monomials for Q in y . By definition of the map ϕ , we have:

$$\phi(\mathcal{C}_y) = \text{Conv}(\mathcal{A}(\mathcal{C}_y)).$$

Lemma 4.14. *Consider a vector $y \in \mathbb{R}^n$. Then:*

$$z^* \in \arg \max_{z \in \mathcal{C}^T \mathcal{P}} [\langle y, z \rangle + \varphi(z)] \Leftrightarrow z^* \in \phi(\mathcal{C}_y).$$

Proof. Let y be a vector of \mathbb{R}^n . The set of maximal monomials for Q in y is $\mathcal{A}(\mathcal{C}_y)$.

Let $z^* \in \phi(\mathcal{C}_y)$. Then, there exist $z_1, \dots, z_q \in \mathcal{A}(\mathcal{C}_y)$ and nonnegative reals $\lambda_1, \dots, \lambda_q$ such that $\sum_{i=1}^q \lambda_i = 1$ and $\sum_{i=1}^q \lambda_i z_i = z^*$. We have for every $i \in [q]$, $Q(y) = \langle y, z_i \rangle + \varphi(z_i)$ since each z_i belongs to $\mathcal{A}(\mathcal{C}_y)$. $\phi(\mathcal{C}_y)$ is a cell of \mathcal{S}' , as the image by ϕ of a cell of \mathcal{S} . Then, φ is affine over $\phi(\mathcal{C}_y)$ according to Lemma 4.10. Consequently:

$$\langle y, z^* \rangle + \varphi(z^*) = \sum_{i=1}^q \lambda_i [\langle y, z_i \rangle + \varphi(z_i)] = Q(y),$$

and $z^* \in \arg \max_{z \in \mathcal{C}^T \mathcal{P}} [\langle y, z \rangle + \varphi(z)]$.

Conversely, if $z^* \in \arg \max_{z \in \mathcal{C}^T \mathcal{P}} [\langle y, z \rangle + \varphi(z)]$, then $\langle y, z^* \rangle + \varphi(z^*) = Q(y)$. Consider the minimal cell $\mathcal{C}'_{z^*} \in \mathcal{S}'$ of z^* (it is the intersection of all the cells of \mathcal{S}' containing z^*). We denote by z_1, \dots, z_q the extreme points of \mathcal{C}'_{z^*} . Then, $z_1, \dots, z_q \in V(Q)$. There exist nonnegative reals $\lambda_1, \dots, \lambda_q$ with $\sum_{i=1}^q \lambda_i = 1$ such that $z^* = \sum_{i=1}^q \lambda_i z_i$. Because $\mathcal{C}'_{z^*} \in \mathcal{S}'$, the function φ is affine over \mathcal{C}'_{z^*} . Then:

$$Q(y) = \langle y, z^* \rangle + \varphi(z^*) = \sum_{i=1}^q \lambda_i [\langle y, z_i \rangle + \varphi(z_i)].$$

By definition of Q , we have for every $i \in [q]$, $Q(y) \geq \langle y, z_i \rangle + \varphi(z_i)$. Then, for every $i \in [q]$, $Q(y) = \langle y, z_i \rangle + \varphi(z_i)$. Consequently, $z_i \in \mathcal{A}(\mathcal{C}_y)$ for every $i \in [q]$ and $z^* \in \text{Conv}(\mathcal{A}(\mathcal{C}_y)) = \phi(\mathcal{C}_y)$. \square

Lemma 4.14 gives a characterization of the low-level problem using the subdivision induced by the tropical polynomial Q .

It leads to the following statement.

Corollary 4.15. *1. Assume that for every $y \in \mathbb{R}^n$, the function $z \mapsto f(z, y)$ is lower semi-continuous. Then, the optimistic version of the continuous bilevel programming problem 4.1 is equivalent to the following problem:*

$$\inf_{y \in \mathbb{R}^n} \min_{z^* \in \phi(\mathcal{C}_y)} f(z^*, y).$$

2. Assume that for every $y \in \mathbb{R}^n$, the function $z \mapsto f(z, y)$ is upper semicontinuous. Then, the pessimistic version of the continuous bilevel programming problem 4.1 is equivalent to the following problem:

$$\inf_{y \in \mathbb{R}^n} \max_{z \in \phi(\mathcal{C}_y)} f(z, y).$$

Proof. The optimistic version of the continuous problem 4.1 is equivalent to:

$$\inf_{y \in \mathbb{R}^n} \inf_{z \in \phi(\mathcal{C}_y)} f(z, y),$$

by using the characterization of an optimistic bilevel programming problem (3.1, see Section 3.1) and by applying Lemma 4.13. If the function $z \mapsto f(z, y)$ is lower semicontinuous for every y , a minimum is attained in $\inf_{z \in \phi(\mathcal{C}_y)} f(z, y)$ since $\phi(\mathcal{C}_y)$ is compact (it is included in $C^T \mathcal{P}$ which is a bounded polyhedron of \mathbb{R}^n). The proof holds also for the pessimistic case by replacing "lower semicontinuous" by "upper semicontinuous". \square

Corollary 4.15 provides a reformulation of the bilevel programming problem 4.1 by characterizing the set of feasible z^* for each $y \in \mathbb{R}^n$. We can also be concerned by the set of feasible y for each possible value of z^* .

Corollary 4.16. *The optimistic version of the continuous bilevel programming problem 4.1 is equivalent to the following problem:*

$$\inf_{z^* \in C^T \mathcal{P}} \inf_{y \in \phi^{-1}(\mathcal{C}'_{z^*})} f(z^*, y)$$

Proof. According to Proposition 4.12, the set of possibles z^* is equal to $C^T \mathcal{P}$. Lemma 4.14 states that for each $y \in \mathbb{R}^n$, the feasible set of values of z^* is equal to $\phi(\mathcal{C}_y)$. However, $z^* \in \phi(\mathcal{C}_y) \Leftrightarrow y \in \phi^{-1}(\mathcal{C}'_{z^*})$ according to Lemma 3.12. \square

For the pessimistic version, the order of the minimization over y and the maximization over z^* cannot be generally changed without any additional assumption.

Corollary 4.15 gives a characterization of the bilevel programming problem 4.1 using the tropical algebraic structure of the low-level problems. This characterization enables to obtain the value of the optimistic and pessimistic versions of Problem 4.1 together with their optimal solutions. The following result goes further and gives a method to solve the optimistic version of Problem 4.1 by solving an optimization subproblem over each cell of \mathcal{S} . It is a key result of this chapter, as it reduces the optimistic bilevel problem to the enumeration of the cells of the tropical hypersurface \mathcal{S} . Then, for each cell, an auxiliary minimization problem must be solved. The latter problem is generally tractable: the feasible set, of the form $\mathcal{C} \times \phi(\mathcal{C})$, is convex, and in many applications, the function f will be convex.

We recall that a function f is *inf-compact* over $\phi(\mathcal{C}) \times \mathcal{C}$ means that for every $r \in \mathbb{R}$, the set $\{(z, y) \in \phi(\mathcal{C}) \times \mathcal{C} \mid f(z, y) \leq r\}$ is compact.

Theorem 4.17 (Reduction of optimistic bilevel programming to cell enumeration). *Assume that for every $y \in \mathbb{R}^n$, the function $z \mapsto f(z, y)$ is lower semicontinuous. Then, the optimistic version of the continuous bilevel programming problem 4.1 is equivalent to the following problem:*

$$\min_{\mathcal{C} \in \mathcal{S}} \left[\inf_{y \in \mathcal{C}} \min_{z^* \in \phi(\mathcal{C})} f(z^*, y) \right].$$

Moreover, if the function f is jointly lower semicontinuous in (z, y) , and is *inf-compact* over each set $\phi(\mathcal{C}) \times \mathcal{C}$, then an optimistic solution exists.

Proof. According to Corollary 4.15, the optimistic version of the continuous bilevel problem 4.1 is equivalent to $\inf_{y \in \mathbb{R}^n} \min_{z^* \in \phi(\mathcal{C}_y)} f(z^*, y)$.

To conclude, we have to show the following equality:

$$\bigcup_{\mathcal{C} \in \mathcal{S}} \{(z^*, y) \mid y \in \mathcal{C}, z^* \in \phi(\mathcal{C})\} = \{(z^*, y) \mid y \in \mathbb{R}^n, z^* \in \phi(\mathcal{C}_y)\}.$$

Consider (z', y') such that $z' \in \phi(\mathcal{C}_{y'})$. Then, $y' \in \mathcal{C}_{y'}$, and because $\mathcal{C}_{y'} \in \mathcal{S}$, we deduce $(z', y') \in \bigcup_{\mathcal{C} \in \mathcal{S}} \{(z^*, y) \mid y \in \mathcal{C}, z^* \in \phi(\mathcal{C})\}$. Consider now $\mathcal{C}' \in \mathcal{S}$ and (z', y') such that $y' \in \mathcal{C}'$ and $z' \in \phi(\mathcal{C}')$. Because $\mathcal{C}_{y'} \subset \mathcal{C}'$, we have $\phi(\mathcal{C}') \subset \phi(\mathcal{C}_{y'})$, so that $(z', y') \in \{(z^*, y) \mid z^* \in \phi(\mathcal{C}_y)\}$.

If f is lower semicontinuous and inf-compact, then the minimum of f is attained over each closed set $\phi(\mathcal{C}) \times \mathcal{C}$. □

To have a similar result as Theorem 4.17 for the pessimistic version of Problem 4.1 (continuous bilevel problem), we have to compare the pessimistic problem with:

$$\min_{\mathcal{C} \in \mathcal{S}} \left[\min_{y \in \mathcal{C}} \max_{z^* \in \phi(\mathcal{C})} f(z^*, y) \right]$$

according to the characterization (3.2) of the pessimistic version of a bilevel programming problem. As discussed in Example 3.1 in Section 3.1, the pessimistic value of a bilevel programming problem can not be attained, even if this value is finite than $-\infty$ and if the high-level and low-level functions are continuous. However, assume that the function f is continuous. Then, for every $y \in \mathbb{R}^n$ and each $\mathcal{C} \in \mathcal{S}$, the maximum is attained in $\sup_{z \in \phi(\mathcal{C})} f(z, y)$ since $f(\cdot, y)$ is upper semicontinuous and $\phi(\mathcal{C})$ is compact. Moreover, for every $z \in C^T \mathcal{P}$, the function $y \mapsto \max_{z \in \phi(\mathcal{C})} f(z, y)$ is lower semicontinuous, as a supremum of lower semicontinuous functions. and defined over a compact set. Hence, if f is additionally inf-compact, the minimum is attained in $\inf_{y \in \mathcal{C}} \max_{z^* \in \phi(\mathcal{C})} f(z^*, y)$. Hence, if this function is bounded from below, the minimum is also attained. Because \mathcal{S} has a finite number of cells, the problem $\min_{\mathcal{C} \in \mathcal{S}} \left[\min_{y \in \mathcal{C}} \max_{z^* \in \phi(\mathcal{C})} f(z^*, y) \right]$ is well-defined, and if the minimum value is finite, there exist z^* and y that attain the minimum value.

Although we do not have a strict equivalence between both problems, we can write an approximation result. Consider an optimization problem $\min_{x \in \mathcal{X}} F(x)$. We denote by F^* the optimal value, that is $F^* = \inf_{x \in \mathcal{X}} F(x)$. For $\varepsilon > 0$, we say that x_ε is an ε -optimal solution of the optimization problem if $x_\varepsilon \in \mathcal{X}$ and $F(x_\varepsilon) \leq F^* + \varepsilon$.

Theorem 4.18 (Reduction of pessimistic bilevel programming to cell enumeration). *Suppose that for each $\mathcal{C} \in \mathcal{S}$, the function f is continuous over $\phi(\mathcal{C}) \times \mathcal{C}$. Then, the value of the pessimistic version of the continuous bilevel problem 4.1 is given by:*

$$\min_{\mathcal{C} \in \mathcal{S}} \left[\inf_{y \in \mathcal{C}} \max_{z \in \phi(\mathcal{C})} f(z, y) \right]. \quad (4.16)$$

If f is additionally inf-compact, then the problem defined by (4.16) has an optimal solution, and there exists an ε -solution of the pessimistic version of Problem 4.1.

Proof. If f is continuous, then in particular for every $y \in \mathbb{R}^n$, the maximum of the function $z \mapsto f(z, y)$ over every compact set is attained. According to Corollary 4.15, the pessimistic

version of the continuous bilevel problem 4.1 is equivalent to $\inf_{y \in \mathbb{R}^n} \max_{z^* \in \phi(\mathcal{C}_y)} f(z, y)$. We can write $\mathbb{R}^n = \cup_{\mathcal{C} \in \mathcal{S}} \mathcal{C}$. Then, we have to prove the following equality:

$$\min_{\mathcal{C} \in \mathcal{S}} \left[\inf_{y \in \mathcal{C}} \max_{z \in \phi(\mathcal{C})} f(z, y) \right] = \min_{\mathcal{C} \in \mathcal{S}} \left[\inf_{y \in \mathcal{C}} \max_{z \in \phi(\mathcal{C}_y)} f(z, y) \right]. \quad (4.17)$$

Let $\mathcal{C} \in \mathcal{S}$ and $y \in \mathcal{S}$. Then $\mathcal{C}_y \subset \mathcal{C}$ and $\phi(\mathcal{C}) \subset \phi(\mathcal{C}_y)$ by Proposition 3.9. Then, for every $y \in \mathbb{R}^n$:

$$\max_{z \in \phi(\mathcal{C})} f(z, y) \leq \max_{z \in \phi(\mathcal{C}_y)} f(z, y).$$

Moreover, if $y \in \text{ri}(\mathcal{C})$, then $\mathcal{C}_y = \mathcal{C}$ and:

$$\max_{z \in \phi(\mathcal{C})} f(z, y) = \max_{z \in \phi(\mathcal{C}_y)} f(z, y)$$

We denote by F_1 and F_2 the following functions:

$$\begin{aligned} \forall y \in \mathcal{C}, F_1(y) &= \max_{z \in \phi(\mathcal{C})} f(z, y) \\ \forall y \in \mathcal{C}, F_2(y) &= \max_{z \in \phi(\mathcal{C}_y)} f(z, y). \end{aligned}$$

Then, $F_1(y) \leq F_2(y)$ for $y \in \mathcal{C}$ with $F_1(y) = F_2(y)$ if $y \in \text{ri}(\mathcal{C})$. If f is continuous, then F_1 is continuous over \mathcal{C} . Then, for every sequence $(y_n)_{n \in \mathbb{N}}$ with $y_n \in \text{ri}(\mathcal{C})$ and such that $\lim_{n \rightarrow +\infty} y_n = y$, we have:

$$F_1(y) = \lim_{n \rightarrow +\infty} F_1(y_n) = \lim_{n \rightarrow +\infty} F_2(y_n) \geq \text{lsc}(F_2 |_{\mathcal{C}})(y),$$

where $\text{lsc}(F_2 |_{\mathcal{C}})$ is the lower semicontinuous closure of the function F_2 restricted to \mathcal{C} , defined by:

$$\text{lsc}(F_2 |_{\mathcal{C}})(y) = \liminf_{z \rightarrow y, z \in \mathcal{C}} F_2(z).$$

Then, since \mathcal{C} is closed:

$$\inf_{y \in \mathcal{C}} F_2(y) \geq \inf_{y \in \mathcal{C}} F_1(y) \geq \inf_{y \in \mathcal{C}} \text{lsc}(F_2)(y) = \inf_{y \in \mathcal{C}} F_2(y).$$

Equation (4.17) comes straightforwardly.

Moreover, if f is inf-compact, then the minimum is attained in $\inf_{y \in \mathcal{C}} F_1(y)$ since F_1 is lower semicontinuous over \mathcal{C} . Then, the problem defined by (4.16) has an optimal solution. Consider (z^*, y^*) an optimal solution of the problem defined by (4.16). Then, there exists $\mathcal{C}^* \in \mathcal{S}$ such that:

$$\begin{aligned} f(z^*, y^*) &= \max_{z \in \phi(\mathcal{C}^*)} f(z, y^*), \quad f(z^*, y^*) = \min_{y \in \mathcal{C}^*} \max_{z \in \phi(\mathcal{C})} f(z, y), \\ f(z^*, y^*) &= \min_{\mathcal{C} \in \mathcal{S}} \left[\min_{y \in \mathcal{C}} \max_{z \in \phi(\mathcal{C})} f(z, y) \right]. \end{aligned}$$

If $\mathcal{C}_{y^*} = \mathcal{C}^*$, then (z^*, y^*) is also an optimal solution of the pessimistic version of Problem 4.1. If $\mathcal{C}_{y^*} \neq \mathcal{C}^*$, then $y^* \notin \text{ri}(\mathcal{C}^*)$. Then, y^* belongs to a face of \mathcal{C}^* . We define the function F_1^* over \mathcal{C}^* by:

$$\forall y \in \mathcal{C}^*, F_1^*(y) = \max_{z \in \phi(\mathcal{C}^*)} f(z, y).$$

The function F_1^* is continuous over \mathcal{C}^* , since f is continuous. Then, for each $\varepsilon > 0$, there exists a point y_ε in the relative interior of \mathcal{C}^* such that $F_1^*(y_\varepsilon) \leq F_1^*(y^*) + \varepsilon$. The maximum is attained in the definition of F_1^* , then we consider z_ε such that:

$$z_\varepsilon \in \arg \max_{z \in \phi(\mathcal{C}^*)} f(z, y_\varepsilon).$$

Because y_ε belongs to $\text{ri}(\mathcal{C}^*)$, we have $\mathcal{C}_{y_\varepsilon} = \mathcal{C}^*$ and $z_\varepsilon \in \phi(\mathcal{C}_{y_\varepsilon})$. Hence, $(z_\varepsilon, y_\varepsilon)$ is a feasible solution of the pessimistic version of Problem 4.1. We recall that:

$$f(z^*, y^*) = \min_{\mathcal{C} \in \mathcal{S}} \left[\min_{y \in \mathcal{C}} \max_{z \in \phi(\mathcal{C})} f(z, y) \right] = \inf_{y \in \mathbb{R}^n} \max_{z \in \phi(\mathcal{C}_y)} f(z, y).$$

Then, we have:

$$\begin{aligned} f(z^*, y^*) &= \inf_{y \in \mathbb{R}^n} \max_{z \in \phi(\mathcal{C}_y)} f(z, y) \leq \max_{z \in \phi(\mathcal{C}_{y_\varepsilon})} f(z, y_\varepsilon) = \max_{z \in \phi(\mathcal{C}^*)} f(z, y_\varepsilon) = F_1^*(y_\varepsilon) = f(z_\varepsilon, y_\varepsilon) \\ &\leq F_1^*(y^*) + \varepsilon = f(z^*, y^*) + \varepsilon. \end{aligned}$$

Then $(z_\varepsilon, y_\varepsilon)$ is an ε -solution of the pessimistic version of the continuous bilevel problem 4.1. \square

Notice that Theorem 4.18 provides also a method for obtaining an ε -solution of the pessimistic version of the continuous problem 4.1.

According to Theorem 4.17 and Theorem 4.18, the different versions of the bilevel programming problem 4.1 can be solved by solving different subproblems on each cell of the subdivision \mathcal{S} . Because of the bijection between \mathcal{S} and a subdivision \mathcal{S}' of the Newton polytope of Q , we have the following result:

Because of the bijection between \mathcal{S} and the dual subdivision \mathcal{S}' of the Newton polytope of Q , we have the following result, in which we now reduce the bilevel programming problem to the enumeration of cells of the *dual* subdivision.

Corollary 4.19 (Reduction of bilevel programming to dual cell enumeration).

1. Assume that for every $y \in \mathbb{R}^n$, the function $z \in C^T \mathcal{P} \mapsto f(z, y)$ is lower semicontinuous. Then, the optimistic version of the continuous bilevel programming problem 4.1 is equivalent to the following problem:

$$\min_{\mathcal{C}' \in \mathcal{S}'} \left[\inf_{y \in \phi^{-1}(\mathcal{C}')} \min_{z \in \mathcal{C}'} f(z, y) \right].$$

2. Assume that for every $\mathcal{C}' \in \mathcal{S}'$, the function f is continuous over $\mathcal{C}' \times \phi(\mathcal{C}')$. Then, the pessimistic value of Problem 4.1 is the optimal value of the following problem:

$$\min_{\mathcal{C}' \in \mathcal{S}'} \left[\inf_{y \in \phi^{-1}(\mathcal{C}')} \max_{z \in \mathcal{C}'} f(z, y) \right]$$

Proof. The function ϕ defines a bijection between the cells of \mathcal{S} and those of \mathcal{S}' . So, it is possible to enumerate the cells of \mathcal{S}' instead of those of \mathcal{S} , and the result comes straightforwardly from Theorems 4.17 and 4.18. \square

It follows from Theorem 4.17 that the bilevel programming problem can be decomposed in many subproblems, each subproblem corresponding to a cell of \mathcal{S} . We next show that when f is concave in the variable y , it suffices to enumerate the *vertices* of \mathcal{S} , i.e., the zero-dimensional cells, to solve the optimistic problem:

Corollary 4.20 (Reduction of optimistic bilevel programming to vertex enumeration). *Assume that for every $y \in \mathbb{R}^n$, the function $z \in C^T\mathcal{P} \mapsto f(z, y)$ is lower semicontinuous. Suppose also that for every $z \in C^T\mathcal{P}$, the function $y \mapsto f(z, y)$ is concave in y . Then, the optimistic version of the bilevel programming problem 4.1 is equivalent to the following problem:*

$$\min_{\mathcal{C} \in \mathcal{S}_0} \left[\min_{y \in \mathcal{C}, z \in \phi(\mathcal{C})} f(z, y) \right]$$

Proof. The optimistic version of Problem 4.1 is equivalent to:

$$\min_{\mathcal{C} \in \mathcal{S}} \left[\inf_{y \in \mathcal{C}} \min_{z \in \phi(\mathcal{C})} f(z, y) \right]$$

according to Theorem 4.17. Consider a cell \mathcal{C} of $\mathcal{S} \setminus \mathcal{S}_0$, that is \mathcal{C} is not reduced to a single point. Then, if f is concave in y for every z , we have:

$$\inf_{y \in \mathcal{C}} \min_{z \in \phi(\mathcal{C})} f(z, y) = \min_{y \in \mathcal{E}(\mathcal{C}), z \in \phi(\mathcal{C})} f(z, y) .$$

Each point of $\mathcal{E}(\mathcal{C})$ is a face of \mathcal{C} , then for each $y \in \mathcal{E}(\mathcal{C})$, $\{y\} \in \mathcal{S}_0$. Moreover, $\{y\} \subset \mathcal{C}$, then $\phi(\mathcal{C}) \subset \phi(\{y\})$. Hence,

$$\inf_{y \in \mathcal{C}} \min_{z \in \phi(\mathcal{C})} f(z, y) \geq \min_{y \in \mathcal{E}(\mathcal{C})} \min_{z \in \phi(\{y\})} f(z, y) \geq \min_{\mathcal{C} \in \mathcal{S}_0} \left[\min_{y \in \mathcal{C}, z \in \phi(\mathcal{C})} f(z, y) \right] .$$

□

We next show that when f is concave in z (resp. convex), it suffices to enumerate the n -dimensional cells of \mathcal{S} , i.e., the *vertices* of the dual subdivision \mathcal{S}' , to solve the optimistic (resp. pessimistic) problem:

Corollary 4.21 (Reduction of optimistic bilevel programming to vertex enumeration of the dual subdivision). *Assume that for every $y \in \mathbb{R}^n$, the function $z \in C^T\mathcal{P} \mapsto f(z, y)$ is lower semicontinuous and concave. Then, the optimistic version of the continuous bilevel programming problem 4.1 is equivalent to the following problem:*

$$\min_{\mathcal{C} \in \mathcal{S}_n} \left[\inf_{y \in \mathcal{C}} \min_{z \in \phi(\mathcal{C})} f(z, y) \right]$$

Proof. The optimistic version of Problem 4.1 is equivalent to:

$$\min_{\mathcal{C} \in \mathcal{S}} \left[\inf_{y \in \mathcal{C}} \min_{z \in \phi(\mathcal{C})} f(z, y) \right]$$

according to Theorem 4.17. Consider a cell \mathcal{C} of $\mathcal{S} \setminus \mathcal{S}_n$, that is $\phi(\mathcal{C})$ is not reduced to a single point. Since f is concave in z for every y , we have:

$$\inf_{y \in \mathcal{C}} \min_{z \in \phi(\mathcal{C})} f(z, y) = \inf_{y \in \mathcal{C}} \min_{z \in \mathcal{E}(\phi(\mathcal{C}))} f(z, y) .$$

Each point of $\mathcal{E}(\phi(\mathcal{C}))$ is a face of $\phi(\mathcal{C})$, then for every $z \in \mathcal{E}(\phi(\mathcal{C}))$, $\{z\} \in \mathcal{S}'_0$. Moreover $\{z\} \subset \phi(\mathcal{C})$, then $\mathcal{C} \subset \phi^{-1}(\{z\})$. We have $\phi^{-1}(\{z\}) \in \mathcal{S}_n$. Hence:

$$\begin{aligned} \inf_{y \in \mathcal{C}} \min_{z \in \phi(\mathcal{C})} f(z, y) &\geq \min_{z \in \mathcal{E}(\phi(\mathcal{C}))} \inf_{y \in \phi^{-1}(\{z\})} f(z, y) \geq \min_{\mathcal{C}' \in \mathcal{S}'_0} \left[\min_{z \in \mathcal{C}'} \inf_{y \in \phi(\mathcal{C}')} f(z, y) \right] \\ &= \min_{\mathcal{C} \in \mathcal{S}_n} \left[\inf_{y \in \mathcal{C}} \min_{z \in \phi(\mathcal{C})} f(z, y) \right]. \end{aligned}$$

□

Corollary 4.22 (Reduction of pessimistic bilevel programming to vertex enumeration of the dual subdivision). *Assume that for every $\mathcal{C} \in \mathcal{S}$, the function f is continuous over $\phi(\mathcal{C}) \times \mathcal{C}$. Suppose additionally that for every $y \in \mathbb{R}^n$, the function $z \mapsto f(z, y)$ is convex. Then, the pessimistic version of the continuous bilevel programming problem 4.1 is equivalent to the following problem:*

$$\min_{\mathcal{C} \in \mathcal{S}_n} \left[\inf_{y \in \mathcal{C}} \max_{z \in \phi(\mathcal{C})} f(z, y) \right]$$

Proof. The optimistic version of Problem 4.1 is equivalent to:

$$\min_{\mathcal{C} \in \mathcal{S}} \left[\inf_{y \in \mathcal{C}} \max_{z \in \phi(\mathcal{C})} f(z, y) \right]$$

according to Theorem 4.18 when f is continuous over $\phi(\mathcal{C}) \times \mathcal{C}$. Consider a cell \mathcal{C} of $\mathcal{S} \setminus \mathcal{S}_n$, that is $\phi(\mathcal{C})$ is not reduced to a single point. Since f is convex in z for every y , we have:

$$\inf_{y \in \mathcal{C}} \max_{z \in \phi(\mathcal{C})} f(z, y) = \inf_{y \in \mathcal{C}} \max_{z \in \mathcal{E}(\phi(\mathcal{C}))} f(z, y) .$$

Let $y \in \mathcal{C}$. Then, there exists $z^* \in \mathcal{E}(\phi(\mathcal{C}))$ such that $f(z^*, y) = \max_{z \in \phi(\mathcal{C})} f(z, y)$. Each point of $\mathcal{E}(\phi(\mathcal{C}))$ is a face of $\phi(\mathcal{C})$. Since $z^* \in \mathcal{E}(\phi(\mathcal{C}))$, $\{z^*\} \in \mathcal{S}'_0$. Moreover $\{z^*\} \subset \phi(\mathcal{C})$, then $\mathcal{C} \subset \phi^{-1}(\{z^*\})$. We have $\phi^{-1}(\{z^*\}) \in \mathcal{S}_n$. Hence:

$$\max_{z \in \phi(\mathcal{C})} f(z, y) = f(z^*, y) \geq \inf_{y \in \phi^{-1}(\{z^*\})} f(z^*, y) \geq \min_{\mathcal{C} \in \mathcal{S}_n} \left[\inf_{y \in \mathcal{C}} \max_{z \in \phi(\mathcal{C})} f(z, y) \right].$$

Then:

$$\min_{\mathcal{C} \in \mathcal{S}} \left[\inf_{y \in \mathcal{C}} \max_{z \in \phi(\mathcal{C})} f(z, y) \right] \geq \min_{\mathcal{C} \in \mathcal{S}_n} \left[\inf_{y \in \mathcal{C}} \max_{z \in \phi(\mathcal{C})} f(z, y) \right].$$

□

4.2.3 Tropical interpretation of Problem 4.2

In this section, we consider the Problem 4.2 (discrete bilevel problem) in which the low-level problem becomes $\max_{x \in \mathcal{I}(\mathcal{P})} \langle \rho + Cy, x \rangle$, i.e., we consider a linear low-level problem in integer variables. We recall that $\mathcal{I}(\mathcal{P}) = \mathcal{P} \cap \mathbb{Z}^k$. We can write, similarly as in Section 4.2.2:

$$\max_{x \in \mathcal{I}(\mathcal{P})} \langle \rho + Cy, x \rangle = \max_{z \in C^T \mathcal{I}(\mathcal{P})} [\langle y, z \rangle + \varphi_I(z)], \quad (4.18)$$

where φ_I is defined over $C^T \mathcal{I}(\mathcal{P})$ by:

$$\varphi_I(z) = \max_{x \in \mathcal{I}(\mathcal{P}), z = C^T x} \langle \rho, x \rangle.$$

Consequently, the value of the low-level problem is an evaluation of a tropical polynomial Q_I defined by:

$$Q_I(y) = \bigoplus_{z \in C^T \mathcal{I}(\mathcal{P})} [\varphi_I(z) \odot y^{\odot z}] = \max_{z \in C^T \mathcal{I}(\mathcal{P})} [\varphi_I(z) + \langle y, z \rangle].$$

Lemma 4.23. *The bilevel programming problem 4.2 (discrete bilevel problem) is equivalent to:*

$$\text{“min”}_{y \in \mathbb{R}^n} f(z^*, y),$$

with z^* solution of $\max_{z \in C^T \mathcal{I}(\mathcal{P})} [\langle y, z \rangle + \varphi(z)]$.

Proof. By using Equation (4.18), the proof is similar to the proof of Lemma 4.13. \square

We have to characterize the vectors $z^* \in C^T \mathcal{I}(\mathcal{P})$ which are optimal solutions of the low-level problem for at least one vector $y \in \mathbb{R}^n$. We have to add some hypotheses about the matrix C and the polytope \mathcal{P} .

Definition 4.24. A real matrix A is said *totally unimodular* if the determinants of all its square submatrices are equal to 0 or are in $\{\pm 1\}$.

Note that in particular, all the coefficients of the matrix are in $\{-1; 0; 1\}$. The following result about totally unimodular matrices is frequently used in combinatorial optimization.

Theorem 4.25 (Th. 19.1 and Coro. 19.1 of [Sch98]). *Let A be a totally unimodular matrix, b a vector with integer entries, and c a vector of \mathbb{R}^n . Then:*

$$\inf_{x \in \mathbb{R}^n, Ax \leq b} c^T x = \inf_{x \in \mathbb{Z}^n, Ax \leq b} c^T x$$

The same conclusion holds if $\{x \in \mathbb{R}^n, Ax \leq b\}$ is replaced by a polyhedron defined by equality and inequality constraints, i.e., by a polyhedron of the form $\{x \in \mathbb{R}^n, Ax \leq b, Dx = h\}$ where $\begin{pmatrix} A \\ D \end{pmatrix}$ is totally unimodular, and h is also a vector with integer entries. Indeed, an equality constraint can be represented by a conjunction of two inequality constraints, and so this generalized statement is an immediate consequence of the one of Theorem 4.25. The following result is also an immediate corollary of Theorem 4.25.

Corollary 4.26. *Let A be a totally unimodular matrix, b a vector with integer entries and c a vector of \mathbb{R}^n . Then:*

$$\arg \min_{x \in \mathbb{Z}^n, Ax \leq b} c^T x = \left(\arg \min_{x \in \mathbb{R}^n, Ax \leq b} c^T x \right) \cap \mathbb{Z}^n.$$

Moreover, the totally unimodular matrices define integer polyhedra.

Theorem 4.27 (Hoffman and Kruskal's theorem, Coro. 19.2a of [Sch98]). *Let A be an integral matrix. Then A is totally unimodular if and only if for every integral vector b , the polyhedron $\{x \in \mathbb{R}^n \mid Ax \leq b\}$ is integral.*

We now consider the polyhedron $\mathcal{P} = \{x \in \mathbb{R}^k \mid Ax \leq b\}$. Being interested in \mathcal{P} being an integer polytope, we suppose b is an integer vector. In the rest of this subsection, we also make the following assumption:

Assumption B. The polytope \mathcal{P} is an integer polytope. The entries of the matrix C are integer. Moreover $C^T \mathcal{I}(\mathcal{P}) = C^T \mathcal{P} \cap \mathbb{Z}^n$.

Lemma 4.28. *If $[C \ A^T]$ is totally unimodular, then Assumption B is satisfied.*

Proof. If $[C \ A^T]$ is totally unimodular, then both matrices C and A are totally unimodular. Then, the entries of C are integer and the polytope \mathcal{P} is an integer polytope as a consequence of Theorem 4.27. Since C has integer entries, $C^T \mathcal{I}(\mathcal{P}) \subset C^T \mathcal{P} \cap \mathbb{Z}^n$. Let $z^* \in C^T \mathcal{P} \cap \mathbb{Z}^n$. Then, the polytope $\{x \in \mathbb{R}^k \mid x \in \mathcal{P}, C^T x = z^*\}$ is non-empty. If $[C \ A^T]$ is totally unimodular, then this polyhedron is an integer polytope. In particular, it contains an integer point, meaning that $z^* \in C^T \mathcal{I}(\mathcal{P})$. \square

Proposition 4.29. *Assume that the matrix $[C \ A^T]$ is totally unimodular. Then, we have $\varphi_I = \varphi$.*

Proof. If $[C \ A^T]$ is totally unimodular (in particular, Assumption B is satisfied), then for every $z \in C^T \mathcal{I}(\mathcal{P})$, we have:

$$\varphi_I(z) = \max_{\substack{Ax \leq b, C^T x = z \\ x \in \mathbb{Z}^k}} \langle \rho, x \rangle = \max_{Ax \leq b, C^T x = z} \langle \rho, x \rangle = \varphi(z),$$

according to Theorem 4.25, or rather, from its extension to the case of polyhedra defined by equality and inequality constraints. \square

Lemma 4.30. *Under Assumption B, the tropical polynomial Q_I appearing in Problem 4.2 (discrete bilevel problem) is equal to the tropical polynomial Q appearing in the continuous bilevel problem 4.1, that is:*

$$\max_{z \in C^T \mathcal{E}(\mathcal{P})} [\langle y, z \rangle + \varphi(z)] = \max_{z \in C^T \mathcal{I}(\mathcal{P})} [\langle y, z \rangle + \varphi_I(z)]. \quad (4.19)$$

Proof. Let $y \in \mathbb{R}^n$. The polytope \mathcal{P} is integer. Consequently, we have $\mathcal{E}(\mathcal{P}) \subset \mathcal{I}(\mathcal{P}) \subset \mathcal{P}$ and so:

$$\max_{x \in \mathcal{E}(\mathcal{P})} \langle \rho + Cy, x \rangle = \max_{x \in \mathcal{I}(\mathcal{P})} \langle \rho + Cy, x \rangle = \max_{x \in \mathcal{P}} \langle \rho + Cy, x \rangle,$$

by using Equation 4.11. Then:

$$Q_I(y) = \max_{x \in \mathcal{I}(\mathcal{P})} \langle \rho + Cy, x \rangle = \max_{x \in \mathcal{E}(\mathcal{P})} \langle \rho + Cy, x \rangle = \max_{z \in C^T \mathcal{E}(\mathcal{P})} [\langle y, z \rangle + \varphi(z)] = Q(y), \quad (4.20)$$

where the first equality follows from (4.18), and the last equality follows from (4.13). \square

To be precise, Lemma 4.30 proves that both functions Q_I and Q are equal. By definition, the monomials of both polynomials are different, meaning that Q_I and Q are distinct when they are considered as formal polynomials.

It is now possible to characterize the low-level optimal responses in Problem 4.2 (discrete bilevel problem) in terms of integer points of cells of \mathcal{S}' .

Lemma 4.31. *Consider a vector $y \in \mathbb{R}^n$. Then, under Assumption B:*

$$z^* \in \arg \max_{z \in C^T \mathcal{I}(\mathcal{P})} [\langle y, z \rangle + \varphi(z)] \Leftrightarrow z^* \in \phi(\mathcal{C}_y) \cap \mathbb{Z}^n$$

Proof. According to Lemma 4.14, it suffices to show:

$$\arg \max_{z \in C^T \mathcal{I}(\mathcal{P})} [\langle y, z \rangle + \varphi(z)] = \arg \max_{z \in C^T \mathcal{P}} [\langle y, z \rangle + \varphi(z)] \cap \mathbb{Z}^n \quad (4.21)$$

Consider $z^* \in \arg \max_{z \in C^T \mathcal{I}(\mathcal{P})} [\langle y, z \rangle + \varphi(z)]$. We have $z^* \in \mathbb{Z}^n$. Moreover, \mathcal{P} is an integer polytope. Then, $C^T \mathcal{E}(\mathcal{P}) \subset C^T \mathcal{I}(\mathcal{P})$. So

$$\forall z \in C^T \mathcal{E}(\mathcal{P}), \langle y, z^* \rangle + \varphi(z^*) \geq \langle y, z \rangle + \varphi(z).$$

As a consequence of (4.12) and (4.13), $\max_{z \in C^T \mathcal{E}(\mathcal{P})} \langle y, z \rangle + \varphi(z) = \max_{z \in C^T \mathcal{P}} \langle y, z \rangle + \varphi(z)$, and so

$$z^* \in \arg \max_{z \in C^T \mathcal{P}} [\langle y, z \rangle + \varphi(z)] \cap \mathbb{Z}^n .$$

Consider now $z^* \in \arg \max_{z \in C^T \mathcal{P}} [\langle y, z \rangle + \varphi(z)] \cap \mathbb{Z}^n$. We just have to show that $z^* \in C^T \mathcal{I}(\mathcal{P})$. This comes directly from Assumption B. \square

Corollary 4.32. *Under Assumption B, the optimistic version of Problem 4.2 (discrete bilevel problem) is equivalent to:*

$$\inf_{y \in \mathbb{R}^n} \min_{z^* \in \phi(C_y) \cap \mathbb{Z}^n} f(z^*, y),$$

whereas the pessimistic one is equivalent to:

$$\inf_{y \in \mathbb{R}^n} \max_{z^* \in \phi(C_y) \cap \mathbb{Z}^n} f(z^*, y).$$

Proof. It comes directly from Lemma 4.31 together with the characterizations of the optimistic (3.1) and pessimistic (3.2) solutions of a bilevel programming problem. \square

Corollary 4.33. *Under Assumption B, the optimistic version of the bilevel programming problem 4.2 is equivalent to the following problem:*

$$\min_{z^* \in C^T \mathcal{P} \cap \mathbb{Z}^n} \inf_{y \in \phi^{-1}(C'_{z^*})} f(z^*, y)$$

Proof. According to Lemma 4.30, the low-level of Problem 4.2 is described by the same tropical polynomial Q as the low-level of Problem 4.1. Hence, according to Proposition 4.12, the set of possibles z^* when y describes \mathbb{R}^n is equal to $C^T \mathcal{P} \cap \mathbb{Z}^n$. Lemma 4.31 states that for each $y \in \mathbb{R}^n$, the feasible set of values of z^* is equal to $\phi(C_y) \cap \mathbb{Z}^n$. However, $z^* \in \phi(C_y) \Leftrightarrow y \in \phi^{-1}(C'_{z^*})$ according to Lemma 3.12. \square

We can now write the corresponding version for the discrete bilevel problem 4.2 of Theorem 4.17.

Theorem 4.34 (Reduction of discrete optimistic bilevel programming to cell enumeration). *Under Assumption B, the optimistic version of the discrete bilevel programming problem 4.2 is equivalent to the following problem:*

$$\min_{\mathcal{C} \in \mathcal{S}} \left[\inf_{y \in \mathcal{C}} \min_{z^* \in \phi(\mathcal{C}) \cap \mathbb{Z}^n} f(z^*, y) \right].$$

If f is inf-compact and lower semicontinuous in y , then an optimistic solution exists.

Proof. Under Assumption B, according to Corollary 4.32 and by noticing that $\mathbb{R}^n = \bigcup_{\mathcal{C} \in \mathcal{S}} \mathcal{C}$, the optimistic version of Problem 4.2 is equivalent to:

$$\min_{\mathcal{C} \in \mathcal{S}} \left[\inf_{y \in \mathcal{C}} \min_{z \in \phi(\mathcal{C}_y) \cap \mathbb{Z}^n} f(z, y) \right].$$

Hence, it suffices to prove that $\bigcup_{\mathcal{C} \in \mathcal{S}} \{(z, y) \mid y \in \mathcal{C}, z \in \phi(\mathcal{C}) \cap \mathbb{Z}^n\} = \{(z, y) \mid z \in \phi(\mathcal{C}_y)\}$. The proof is the same as for Theorem 4.17. If f is inf-compact and lower semicontinuous in y , then for every $\mathcal{C} \in \mathcal{S}$ the minimum is attained in $\inf_{y \in \mathcal{C}} \max_{z \in \phi(\mathcal{C}) \cap \mathbb{Z}^n} f(z, y)$. The minimum is always attained in $\inf_{z \in \phi(\mathcal{C}_y) \cap \mathbb{Z}^n} f(z, y)$ since $\phi(\mathcal{C}_y) \cap \mathbb{Z}^n$ is a discrete finite set. \square

As for Problem 4.1, a similar result exists for the pessimistic version of Problem 4.2.

Theorem 4.35 (Reduction of discrete pessimistic bilevel programming to cell enumeration). *Suppose that for each $z \in C^T \mathcal{P} \cap \mathbb{Z}^n$, the function $y \mapsto f(z, y)$ is continuous over \mathbb{R}^n . Then, the value of the pessimistic version of Problem 4.2 (discrete bilevel problem) is given by:*

$$\min_{\mathcal{C} \in \mathcal{S}} \left[\inf_{y \in \mathcal{C}} \max_{z^* \in \phi(\mathcal{C}) \cap \mathbb{Z}^n} f(z^*, y) \right]. \quad (4.22)$$

Moreover, if an optimal solution of 4.22, then for each $\varepsilon > 0$, there exists an ε -solution of the pessimistic version of Problem 4.2.

Proof. The proof is the same as for Theorem 4.18. Since $\phi(\mathcal{C}) \cap \mathbb{Z}^n$ is discrete and finite for every $\mathcal{C} \in \mathcal{S}$, the continuity of f in z is not required. \square

Using again the bijection between \mathcal{S} and \mathcal{S}' , we arrive at the following corollary:

Corollary 4.36 (Reduction of discrete bilevel programming to dual cell enumeration).

1. Under Assumption B, the optimistic version of the discrete bilevel programming problem 4.2 is equivalent to the following problem:

$$\min_{\mathcal{C}' \in \mathcal{S}'} \left[\inf_{y \in \phi^{-1}(\mathcal{C}')} \min_{z \in \mathcal{C}' \cap \mathbb{Z}^n} f(z, y) \right].$$

2. Assume that for every $\mathcal{C}' \in \mathcal{S}'$ and every $z \in \phi(\mathcal{C}') \cap \mathbb{Z}^n$, the function $y \mapsto f(z, y)$ is continuous over \mathcal{C}' . Then, the pessimistic value of Problem 4.2 is the optimal value of the following problem:

$$\min_{\mathcal{C}' \in \mathcal{S}'} \left[\inf_{y \in \phi^{-1}(\mathcal{C}')} \max_{z \in \mathcal{C}' \cap \mathbb{Z}^n} f(z, y) \right]$$

Proof. As in the proof of Corollary 4.19, this result comes straightforwardly from the bijection between the cells of \mathcal{S} and those of \mathcal{S}' , and from the results of Theorem 4.34 and 4.35. \square

4.2.4 Tropical interpretation of Problem 4.3

In this section, we consider Problem 4.3 (extreme points bilevel problem), in which the low-level problem becomes $\max_{x \in \mathcal{E}(\mathcal{P})} \langle \rho + Cy, x \rangle$. According to Equation 4.13, we can write:

$$\max_{x \in \mathcal{E}(\mathcal{P})} \langle \rho + Cy, x \rangle = \max_{z \in C^T \mathcal{E}(\mathcal{P})} [\langle y, z \rangle + \varphi(z)] = Q(y).$$

Lemma 4.37. *The bilevel programming problem 4.3 is equivalent to:*

$$\text{“min”}_{y \in \mathbb{R}^n} f(z^*, y),$$

with z^* solution of $\max_{z \in C^T \mathcal{E}(\mathcal{P})} [\langle y, z \rangle + \varphi(z)]$.

Proof. By using (4.13), the proof is similar to the proof of Lemma 4.13. \square

Then, as in Section 4.2.2, the value of the low-level problem of Problem 4.3 is an evaluation of the tropical polynomial Q . It means that we can have the same tropical interpretation as in the previous subsections for solving Problem 4.3 (extreme points bilevel problem). Since the low-level of Problem 4.3 is a maximization of a linear function over a finite set, it has a discrete structure. This means that we can apply the tropical approach for solving a discrete bilevel problem without any additionally assumption (in Section 4.2.3, we made Assumption B to apply this approach).

Although the low-level values of both bilevel problems 4.1 (continuous bilevel problem) and 4.3 (extreme points bilevel problem) are equal, both problems are not equivalent. The set of the low-level solutions of both problems are different, according to the following result.

Lemma 4.38. *Consider a vector $y \in \mathbb{R}^n$. Then:*

$$z^* \in \arg \max_{z \in C^T \mathcal{E}(\mathcal{P})} [\langle y, z \rangle + \varphi(z)] \Leftrightarrow z^* \in \phi(\mathcal{C}_y) \cap C^T \mathcal{E}(\mathcal{P}).$$

Proof. According to Proposition 4.12, it suffices to show:

$$\arg \max_{z \in C^T \mathcal{E}(\mathcal{P})} [\langle y, z \rangle + \varphi(z)] = \left(\arg \max_{z \in C^T \mathcal{P}} [\langle y, z \rangle + \varphi(z)] \right) \cap C^T \mathcal{E}(\mathcal{P}).$$

It comes directly from (4.13). \square

Corollary 4.39. *The optimistic version of Problem 4.3 is equivalent to:*

$$\inf_{y \in \mathbb{R}^n} \min_{z^* \in \phi(\mathcal{C}_y) \cap C^T \mathcal{E}(\mathcal{P})} f(z^*, y),$$

whereas the pessimistic one is equivalent to:

$$\inf_{y \in \mathbb{R}^n} \max_{z^* \in \phi(\mathcal{C}_y) \cap C^T \mathcal{E}(\mathcal{P})} f(z^*, y).$$

Proof. Same proof as Corollary 4.32 by replacing $\phi(\mathcal{C}_y) \cap \mathbb{Z}^n$ by $\phi(\mathcal{C}_y) \cap C^T \mathcal{E}(\mathcal{P})$. \square

Corollary 4.40. *The optimistic version of the bilevel programming problem 4.3 is equivalent to the following problem:*

$$\inf_{z^* \in C^T \mathcal{E}(\mathcal{P})} \inf_{y \in \phi^{-1}(C'_{z^*})} f(z^*, y).$$

Proof. Same proof as Corollary 4.33 by replacing $C^T \mathcal{P} \cap \mathbb{Z}^n$ by $C^T \mathcal{E}(\mathcal{P})$. \square

We can now state the corresponding version for Problem 4.3 of Theorem 4.17.

Theorem 4.41 (Reduction of optimistic bilevel programming with extreme points to cell enumeration). *The optimistic version of Problem 4.3 (extreme points bilevel problem) is equivalent to the following problem:*

$$\min_{\mathcal{C} \in \mathcal{S}} \left[\inf_{y \in \mathcal{C}} \min_{z^* \in \phi(\mathcal{C}) \cap C^T \mathcal{E}(\mathcal{P})} f(z^*, y) \right].$$

If f is inf-compact and lower semicontinuous in y , then an optimistic solution exists.

Proof. Same proof as Theorem 4.34 by replacing $\phi(\mathcal{C}) \cap \mathbb{Z}^n$ by $\phi(\mathcal{C}) \cap C^T \mathcal{E}(\mathcal{P})$. \square

We can also write an equivalent of Theorem 4.18 for the pessimistic version of Problem 4.3.

Theorem 4.42 (Reduction of pessimistic bilevel programming with extreme points to cell enumeration). *Suppose that for each $z \in C^T \mathcal{E}(\mathcal{P})$, the function $y \mapsto f(z, y)$ is continuous over \mathbb{R}^n . Then, the value of the pessimistic version of Problem 4.1 (extreme points bilevel problem) is given by:*

$$\min_{\mathcal{C} \in \mathcal{S}} \left[\inf_{y \in \mathcal{C}} \max_{z^* \in \phi(\mathcal{C}) \cap C^T \mathcal{E}(\mathcal{P})} f(z^*, y) \right]. \quad (4.23)$$

Moreover, if an optimal solution of 4.23, then for each $\varepsilon > 0$, a ε -solution of the pessimistic version of Problem 4.3 exists.

Proof. Same proof as Theorem 4.35 by replacing $\phi(\mathcal{C}) \cap \mathbb{Z}^n$ by $\phi(\mathcal{C}) \cap C^T \mathcal{E}(\mathcal{P})$. \square

Corollary 4.43 (Reduction of bilevel programming with extreme points to dual cell enumeration).

1. *The optimistic version of Problem 4.3 (extreme points bilevel problem) is equivalent to the following problem:*

$$\min_{\mathcal{C}' \in \mathcal{S}'} \left[\inf_{y \in \phi^{-1}(\mathcal{C}')} \min_{z \in \mathcal{C}' \cap C^T \mathcal{E}(\mathcal{P})} f(z, y) \right].$$

2. *Assume that for every $\mathcal{C}' \in \mathcal{S}'$ and every $z \in \phi(\mathcal{C}') \cap C^T \mathcal{E}(\mathcal{P})$, the function $y \mapsto f(z, y)$ is continuous over \mathcal{C}' . Then, the pessimistic value of Problem 4.3 is the optimal value of the following problem:*

$$\min_{\mathcal{C}' \in \mathcal{S}'} \left[\inf_{y \in \phi^{-1}(\mathcal{C}')} \max_{z \in \mathcal{C}' \cap C^T \mathcal{E}(\mathcal{P})} f(z, y) \right]$$

Proof. Same proof as Corollary 4.36 by replacing $\mathcal{C}' \cap \mathbb{Z}^n$ by $\mathcal{C}' \cap C^T \mathcal{E}(\mathcal{P})$. \square

4.2.5 An example

We consider again the example introduced in Section 4.1, that is $n = 2$, $k = 4$, \mathcal{P} defined by $\mathcal{P} = \{x \in \mathbb{R}^4 \mid \forall i, 0 \leq x_i \leq 1 \text{ and } x_1 + x_3 \leq 1\}$, and the vector ρ and the matrix C defined by:

$$\rho = \begin{pmatrix} -2 \\ -1 \\ 0 \\ 1 \end{pmatrix} \quad \text{et} \quad C = \begin{pmatrix} 1 & 0 \\ 0 & 1 \\ 1 & 0 \\ 0 & 1 \end{pmatrix}$$

The tropical polynomial Q defined by the low-level problem is $Q(y) = \max(0, y_1, y_2 + 1, y_1 + y_2 + 1, 2y_2, y_1 + 2y_2)$. Its associated tropical hypersurface is drawn on Figure 4.1. Hence, the subdivision \mathcal{S} contains 15 cells:

- 6 two-dimensional cells corresponding to the areas in which each monomial is maximal. The image by the application ϕ of each of this cell is the corresponding exponent of the monomial. For example, the cell $\mathcal{C} = \{(y_1, y_2) \in \mathbb{R}^2 \mid y_1 \leq 0, y_2 \leq -1\}$ verifies $\phi(\mathcal{C}) = \{(0, 0)\}$.
- 7 one-dimensional cells corresponding to the border between two two-dimensional cells. The image by ϕ of the border is the convex hull of the image by ϕ of the two two-dimensional cells. For example, the cell $\mathcal{C} = \{(y_1, y_2) \in \mathbb{R}^2 \mid y_1 \leq 0, y_2 = -1\}$ verifies $\phi(\mathcal{C}) = \text{Conv}((0, 0), (0, 1))$.
- 2 zero-dimensional cells corresponding to the apices of the tropical hypersurface. They are the intersection points of the different one-dimensional cells. For example, the cell $\mathcal{C} = \{(0, -1)\}$ verifies $\phi(\mathcal{C}) = [0, 1]^2$.

Here, we define the high-level function f by $f(z^*, y) = (z_1^*)^2 + \langle y, z^* \rangle$. We apply Theorem 4.17 to solve Problem 4.1. For each cell $\mathcal{C} \in \mathcal{S}$, we have to solve the optimistic version $\min_{y \in \mathcal{C}, z^* \in \phi(\mathcal{C})} f(z^*, y)$ and the pessimistic version $\min_{y \in \mathcal{C}} \max_{z^* \in \phi(\mathcal{C})} f(z^*, y)$ of the bilevel problem.

\mathcal{C}	$\phi(\mathcal{C})$	Optimistic case	Pessimistic case
$\{(y_1, y_2) \in \mathbb{R}^2 \mid y_1 \leq 0, y_2 \leq -1\}$	$\{(0, 0)\}$	0	0
$\{(y_1, y_2) \in \mathbb{R}^2 \mid y_1 \geq 0, y_2 \leq -1\}$	$\{(1, 0)\}$	1	1
$\{(y_1, y_2) \in \mathbb{R}^2 \mid y_1 \leq 0, -1 \leq y_2 \leq 1\}$	$\{(0, 1)\}$	-1	-1
$\{(y_1, y_2) \in \mathbb{R}^2 \mid y_1 \geq 0, -1 \leq y_2 \leq 1\}$	$\{(1, 1)\}$	0	0
$\{(y_1, y_2) \in \mathbb{R}^2 \mid y_1 \leq 0, y_2 \geq 1\}$	$\{(0, 2)\}$	2	2
$\{(y_1, y_2) \in \mathbb{R}^2 \mid y_1 \geq 0, y_2 \geq 1\}$	$\{(1, 2)\}$	3	3
$\{(y_1, y_2) \mid y_1 = 0, y_2 \leq -1\}$	$[0, 1] \times \{0\}$	0	0
$\{(y_1, y_2) \mid y_1 \leq 0, y_2 = -1\}$	$\{0\} \times [0, 1]$	-1	0
$\{(y_1, y_2) \mid y_1 \geq 0, y_2 = -1\}$	$\{1\} \times [0, 1]$	0	1
$\{(y_1, y_2) \mid y_1 = 0, -1 \leq y_2 \leq 1\}$	$[0, 1] \times \{1\}$	-1	0
$\{(y_1, y_2) \mid y_1 \leq 0, y_2 = 1\}$	$\{0\} \times [1, 2]$	1	2
$\{(y_1, y_2) \mid y_1 \geq 0, y_2 = 1\}$	$\{1\} \times [1, 2]$	2	3
$\{(y_1, y_2) \mid y_1 = 0, y_2 \geq 1\}$	$[0, 1] \times \{2\}$	2	3
$\{(0, -1)\}$	$[0, 1]^2$	-1	1
$\{(0, 1)\}$	$[0, 1] \times [1, 2]$	1	3

Table 4.2: List of cells of \mathcal{S} and of dual cells of \mathcal{S}' , with the solution of each subproblem in the optimistic and pessimistic case of the continuous bilevel problem 4.1.

We notice that the function f is not inf-compact over every $\phi(\mathcal{C}) \times \mathcal{C}$. For instance for the cell

$$\mathcal{C} = \{(y_1, y_2) \in \mathbb{R}^2 \mid y_1 \leq 0, y_2 \leq -1\},$$

we have $\phi(\mathcal{C}) = \{(0, 0)\}$ and $f(z, y) = 0$ for every $(z, y) \in \phi(\mathcal{C}) \times \mathcal{C}$. In fact, we have the following property. For each $\mathcal{C} \in \mathcal{S}$, there exists a compact set $K \subset \mathcal{S}$ such that:

$$\inf_{y \in \mathcal{C}} \min_{z \in \phi(\mathcal{C})} f(z, y) = \min_{y \in K, z \in \phi(\mathcal{C})} f(z, y),$$

which guarantees that the minimum is attained.

We conclude that both optimistic and pessimistic versions have the same solution -1 . An optimistic solution is for instance $z^* = (0, 1)$ and $y^* = (-1, -1)$. However, a pessimistic solution does not exist. In fact, the pessimistic value -1 is the optimal solution of the problem:

$$\min_{y_1 \leq 0, -1 \leq y_2 \leq 1} \max_{z=(0,1)} (z_1)^2 + y_1 z_1 + y_2 z_2 = \min_{y_1 \leq 0, -1 \leq y_2 \leq 1} y_2.$$

It is attained for every $y_1 \leq 0$ and $y_2 = -1$. However, take $y = (y_1, -1)$ with $y_1 < 0$. Then, the minimal cell $\mathcal{C}_y = \{(y'_1, y'_2) \in \mathbb{R}^2 \mid y'_1 \leq 0, y'_2 \leq -1\}$. Thus, $\phi(\mathcal{C}_y) = \{0\} \times [0, 1]$. Consequently, in the pessimistic case, the follower chooses the optimal solution z^* such that:

$$f(z^*, y) = \max_{z \in \phi(\mathcal{C}_y)} f(z, y) = \max_{0 \leq z_2 \leq 1} -z_2 = 0.$$

However, consider for each $\varepsilon > 0$ the point $y_\varepsilon = (-1, -1 + \varepsilon)$. In this case $\phi(\mathcal{C}_{y_\varepsilon}) = \{(0, 1)\}$. Then, $\max_{z \in \phi(\mathcal{C}_{y_\varepsilon})} f(z, y_\varepsilon) = (y_\varepsilon)_2$, and the pessimistic value is then equal to $-1 + \varepsilon$. An ε -solution is $z^* = (0, 1)$ and $y^* = (-1, -1 + \varepsilon)$.

Moreover, we have:

$$[C \ A^T] = \begin{pmatrix} 1 & 0 & 1 & 0 & 0 & 0 & -1 & 0 & 0 & 0 & 1 \\ 0 & 1 & 0 & 1 & 0 & 0 & 0 & -1 & 0 & 0 & 0 \\ 1 & 0 & 0 & 0 & 1 & 0 & 0 & 0 & -1 & 0 & 1 \\ 0 & 1 & 0 & 0 & 0 & 1 & 0 & 0 & 0 & 0 & -1 \end{pmatrix}$$

It is not difficult to see that this matrix is totally unimodular. This can be seen either by a routine verification, or by applying an elementary lemma of Poincaré showing that if a matrix has entries in $\{0, \pm 1\}$ with at most one elements of a given sign on every column, this matrix is totally unimodular. Poincaré's lemma can be applied to the matrix obtained by changing the sign of all the entries in the third and fourth row of the matrix above, noting that this change of sign does not alter total unimodularity. Consequently, Assumption B is true. Hence, we can solve Problem 4.2 by applying Theorem 4.34.

We only have to consider for each subproblem the integer points of $\phi(\mathcal{C})$. We easily check that both optimistic and pessimistic versions of Problem 4.2 have also the same solution -1 .

4.3 Generalization of the tropical approach

To conclude with this chapter, we study if it is possible to generalize the results of Section 4.2 to more general classes of bilevel programming problems.

4.3.1 Generalization of the low-level problem

We show in Lemma 4.23 that the low-level part of the discrete bilevel problem 4.2 corresponds to:

$$\max_{z \in C^T \mathcal{P} \cap \mathbb{Z}^n} \langle y, z \rangle + \varphi_I(z),$$

where the function φ is defined by:

$$\varphi_I(z) = \max_{x \in \mathcal{I}(\mathcal{P}), z = C^T x} \langle \rho, x \rangle.$$

φ_I is a piecewise-linear concave function defined over $C^T\mathcal{P}$. $C^T\mathcal{P} \cap \mathbb{Z}^n$ is a finite set because $C^T\mathcal{P}$ is bounded. Hence, the low level of the discrete problem 4.2 defines a tropical polynomial, as we already show. The reason why the low level defines a tropical polynomial is that it consists in a maximization of tropical monomials over a finite set. No additional assumption has to be done over the coefficients of the monomials.

This means that we can generalize the discrete bilevel problem 4.2 of problems of the following form:

Problem 4.44 (General discrete bilevel problem).

$$\text{“min”}_{y \in \mathbb{R}^n} f(z^*, y) \quad (4.24)$$

with z^* solution of:

$$\max_{z \in C^T\mathcal{P} \cap \mathbb{Z}^n} \langle y, z \rangle + \tilde{\varphi}(z), \quad (4.25)$$

where $\tilde{\varphi}$ is any concave function over $C^T\mathcal{P}$.

Let $\tilde{\varphi}_I$ be the restriction to $C^T\mathcal{I}(\mathcal{P})$ of $\tilde{\varphi}$. Then, the function:

$$y \mapsto \max_{z \in C^T\mathcal{I}(\mathcal{P})} [\langle y, z \rangle + \tilde{\varphi}_I(z)]$$

defines a tropical polynomial. Then, under Assumption B, we can apply the same approach as in Section 4.2.3 for the general discrete problem 4.44. The same results are valid if we assume B.

We also generalize bilevel problem 4.3 (extreme points bilevel problem) to problems of the following form:

Problem 4.45 (General version of the extreme points bilevel problem).

$$\text{“min”}_{y \in \mathbb{R}^n} f(z^*, y) \quad (4.26)$$

with z^* solution of:

$$\max_{z \in C^T\mathcal{E}(\mathcal{P})} \langle y, z \rangle + \tilde{\varphi}(z). \quad (4.27)$$

where $\tilde{\varphi}$ is any concave function over $C^T\mathcal{P}$.

Let $\tilde{\varphi}_E$ be the restriction to $C^T\mathcal{E}(\mathcal{P})$ of $\tilde{\varphi}$. Then, the function:

$$y \mapsto \max_{z \in C^T\mathcal{E}(\mathcal{P})} [\langle y, z \rangle + \tilde{\varphi}_E(z)]$$

defines also a tropical polynomial. Then, we can apply the same approach as in Section 4.2.4 for the general bilevel problem 4.45. The same results are valid.

Finally, this generalization cannot be applied to the continuous bilevel problem 4.1. Assume that the function φ defined by (4.12) is any concave function. The low-level problem of 4.1 consists in a maximization over a polytope. Then, the number of monomials is infinite, and it does not define generally a tropical polynomial. We need the piecewise-linearity of φ to introduce the tropical structure.

4.3.2 Generalization of the high-level problem

On the contrary of the low-level of Problem 4.1 (continuous bilevel problem), the high level is quite general because we consider general functions f . However, we assumed that f depends on $C^T x^*$ and y , where $x^* \in \arg \max_{x \in \mathcal{P}} \langle \rho + Cy, x \rangle$. In particular, the matrix C appears twice. A generalization of the continuous problem 4.1 is the following problem.

Problem 4.46.

$$\text{“min”}_{y \in \mathbb{R}^n} h(x^*, y) \quad (4.28)$$

with x^* solution of:

$$\max_{x \in \mathcal{P}} \langle \rho + Cy, x \rangle \quad (4.29)$$

In fact, we can reduce the general bilevel problem 4.46 to the continuous bilevel problem 4.1, according to the following theorem:

Theorem 4.47. 1. The optimistic version of Problem 4.46 is equivalent to Problem 4.1 with:

$$f(z^*, y) = \inf_{\substack{x \in \mathcal{P} \\ C^T x = z^* \\ \varphi(z^*) = \langle \rho, x \rangle}} h(x, y),$$

where $\varphi(z^*) = \max_{x \in \mathcal{P}, C^T x = z^*} \langle \rho, x \rangle$.

2. The pessimistic version of Problem 4.46 is equivalent to Problem 4.1 with:

$$f(z^*, y) = \sup_{\substack{x \in \mathcal{P} \\ C^T x = z^* \\ \varphi(z^*) = \langle \rho, x \rangle}} h(x, y).$$

Proof. Let $z^* \in C^T \mathcal{P}$. According to Proposition 4.12, there exists $y \in \mathbb{R}^n$ such that $z^* \in \arg \max_{z \in C^T \mathcal{P}} \langle y, z \rangle + \varphi(z)$. Let $x^* \in \mathcal{P}$. If $\varphi(C^T x^*) > \langle \rho, x^* \rangle$, then there exists $x \in \mathcal{P}$ such that $C^T x^* = C^T x$ and $\varphi(C^T x^*) = \langle \rho, x \rangle$. Then, for all $y \in \mathbb{R}^n$:

$$\langle \rho + Cy, x^* \rangle < \langle \rho, x \rangle + \langle y, C^T x^* \rangle = \langle \rho + Cy, x \rangle.$$

If $\varphi(C^T x^*) = \langle \rho, x^* \rangle$, then there exists $y \in \mathbb{R}^n$ such that for each $z \in C^T \mathcal{P}$, $\langle y, C^T x^* \rangle + \varphi(C^T x^*) \geq \langle y, z \rangle + \varphi(z)$, that is for all $x \in \mathcal{P}$, $\langle \rho + Cy, x^* \rangle \geq \langle \rho + Cy, x \rangle$. Consequently, a point $x^* \in \mathcal{P}$ is such that there exists $y \in \mathbb{R}^n$ with $x^* \in \arg \max_{x \in \mathcal{P}} \langle \rho + Cy, x \rangle$ if and only if $\varphi(C^T x^*) = \langle \rho, x^* \rangle$. Moreover, for a fixed $y \in \mathbb{R}^n$, the set of optimal solutions z^* of the low-level problem:

$$\max_{z \in C^T \mathcal{P}} [\langle y, z \rangle + \varphi(z)]$$

is $\phi(\mathcal{C}_y)$ according to Lemma 4.14.

Hence, the optimistic version of the general continuous problem 4.46 is equivalent to:

$$\inf_{y \in \mathbb{R}^n} \inf_{\substack{x^* \in \mathcal{P} \\ C^T x^* \in \phi(\mathcal{C}_y) \\ \varphi(C^T x^*) = \langle \rho, x^* \rangle}} h(x^*, y),$$

and the pessimistic version of Problem 4.46 is equivalent to:

$$\inf_{y \in \mathbb{R}^n} \sup_{\substack{x^* \in \mathcal{P} \\ C^T x^* \in \phi(\mathcal{C}_y) \\ \varphi(C^T x^*) = \langle \rho, x^* \rangle}} h(x^*, y),$$

according to Corollary 4.15. The statement of the theorem comes directly from these equivalences. \square

We notice that the value of the low-level problem of Problem 4.46 corresponds to the value of a tropical polynomial. We recall the tropical polynomial P defined by:

$$\forall u \in \mathbb{R}^k, P(u) = \max_{x \in \mathcal{E}(\mathcal{P})} [\langle u, x \rangle + \langle \rho, x \rangle].$$

Then, the low-level value of the general continuous problem 4.46 is:

$$\max_{x \in \mathcal{P}} \langle \rho + Cy, x \rangle = \max_{x \in \mathcal{E}(\mathcal{P})} \langle \rho + Cy, x \rangle = P(Cy),$$

as stated in Equation 4.11. The Newton polytope $\text{New}(P)$ of P is equal to \mathcal{P} . The coefficients of the different monomials are defined by a linear function. Then, the graph of the function $x \in \mathcal{P} \mapsto \langle \rho, x \rangle$ is a k -dimensional polyhedron in \mathbb{R}^{k+1} , meaning that the extended Newton polytope of P contains only one bounded n -dimensional face. Hence, the subdivision \mathcal{S}' of $\text{New}(P)$ is:

$$\mathcal{S}' = \{\mathcal{C}' \in \mathcal{S}' \mid \mathcal{C}' \text{ is a face of } \mathcal{P}\}.$$

Consider the bijection ϕ between the subdivision \mathcal{S} associated to the tropical hypersurface $\mathcal{T}(P)$ and the subdivision \mathcal{S}' of $\text{New}(P)$ (see Section 3.3). Then, for every $\mathcal{C}' \in \mathcal{S}'$, $\phi^{-1}(\mathcal{C}')$ is defined by:

$$\phi^{-1}(\mathcal{C}') = \{u \in \mathbb{R}^k \mid \forall x' \in \mathcal{E}(\mathcal{C}'), \langle \rho + u, x' \rangle = \max_{x \in \mathcal{E}(\mathcal{P})} \langle \rho + u, x \rangle\}.$$

It means that the cells of the subdivision \mathcal{S} associated to the tropical hypersurface $\mathcal{T}(P)$ correspond to the normal fan of \mathcal{P} in each of this face.

The tropical approach can be applied to the general problem 4.46 by using the tropical polynomial P . Problem 4.46 can be rewritten as follows:

$$\text{“min”}_{u \in \mathbb{R}^k} \left[\inf_{y \in \mathbb{R}^n, u=Cy} h(x^*, y) \right],$$

with $x^* \in \arg \max_{x \in \mathcal{P}} \langle \rho + Cy, x \rangle$. By defining $g(x^*, u) = \inf_{y \in \mathbb{R}^n, u=Cy} h(x^*, y)$, the high-level problem of 4.46 becomes:

$$\text{“min”}_{u \in \mathbb{R}^k} [g(x^*, u)].$$

Then, we can apply the results of Section 4.2.2 to Problem 4.46, by considering the tropical polynomial P and the subdivision \mathcal{S} and \mathcal{S}' associated to P . We have in particular the following result.

Proposition 4.48. *Assume that the function h is continuous over $\mathcal{P} \times \mathbb{R}^n$. Then, the optimistic version of the general bilevel programming problem 4.46 is equivalent to the following problem:*

$$\min_{\mathcal{C}' \in \mathcal{S}'} \left[\inf_{y \in \mathbb{R}^n, Cy \in \phi^{-1}(\mathcal{C}')} \min_{z \in \mathcal{C}'} f(z, y) \right].$$

Proof. Let $g(x, u) = \inf_{y \in \mathbb{R}^n, u=Cy} h(x, y)$. If h is continuous over $\mathcal{P} \times \mathbb{R}^n$, then g is continuous over $\mathcal{P} \times \mathbb{R}^k$. Then, by Corollary 4.19, the optimistic version of Problem 4.46 is equivalent to:

$$\min_{\mathcal{C}' \in \mathcal{S}'} \left[\inf_{x \in \mathcal{C}'} \inf_{u \in \phi^{-1}(\mathcal{C}')} g(x, u) \right].$$

We deduce the statement of the proposition. \square

CHAPTER 5

Cell enumeration applied to bilevel programming: general complexity results

In this chapter, we deal with the class of bilevel programming problems introduced in Chapter 4. Here, n denotes the dimension of the high-level problem, whereas k denotes the dimension of the low-level problem. For the different problems of this class (continuous, discrete, extreme points problems), we established that the low-level defines a tropical polynomial Q in n variables. This tropical polynomial defines a subdivision \mathcal{S} . There exists a bijection ϕ between the cells of \mathcal{S} and the cells of another subdivision \mathcal{C}' , which is a regular subdivision of $\text{New}(Q) = C^T \mathcal{P}$, where $C \in \mathcal{M}_{k,n}(\mathbb{R})$ and \mathcal{P} is a polytope of \mathbb{R}^k defined by:

$$\mathcal{P} = \{x \in \mathbb{R}^k \mid Ax \leq b\}, \quad (5.1)$$

where $b \in \mathbb{R}^p$ and $A \in \mathcal{M}_{p,k}(\mathbb{R})$.

The tropical approach leads to a reduction of the problems to a series of optimization subproblems. Each of these subproblems is associated to a cell \mathcal{C} of the subdivision \mathcal{S} .

The aim of this chapter is to use this reduction to propose an algorithm which returns an optimal solution of the different bilevel problems and to estimate its complexity. In the rest of this chapter, we denote by:

- (BP) : one of the bilevel problem among the optimistic and pessimistic version of the continuous problem 4.1, the discrete problem 4.2 and the extreme points problem 4.3.

- Th. (BP): the theorem of Section 4.2 establishing the reduction of (BP) into a series of optimization subproblems. According to the nature of (BP), Th. (BP) is one of the following theorems: 4.17, 4.18, 4.34, 4.35, 4.41 and 4.42.
- $(SP_{\mathcal{C}})$: the kind of subproblems to solve for solving (BP) according to Th. (BP). We recall them for each type of bilevel problem (BP) in Chapter 5.

	Optimistic version	Pessimistic version
Problem 4.1	$\min_{y \in \mathcal{C}, z^* \in \phi(\mathcal{C})} f(z^*, y)$	$\min_{y \in \mathcal{C}} \max_{z^* \in \phi(\mathcal{C})} f(z^*, y)$
Problem 4.2	$\min_{y \in \mathcal{C}, z^* \in \phi(\mathcal{C}) \cap \mathbb{Z}^n} f(z^*, y)$	$\min_{y \in \mathcal{C}} \max_{z^* \in \phi(\mathcal{C}) \cap \mathbb{Z}^n} f(z^*, y)$
Problem 4.3	$\min_{y \in \mathcal{C}, z^* \in \phi(\mathcal{C}) \cap C^T \mathcal{E}(\mathcal{P})} f(z^*, y)$	$\min_{y \in \mathcal{C}} \max_{z^* \in \phi(\mathcal{C}) \cap C^T \mathcal{E}(\mathcal{P})} f(z^*, y)$

Table 5.1: The different subproblems $(SP_{\mathcal{C}})$ to solve.

For the rest of this chapter, we consider that we study the bilevel problem (BP) together with the following assumption:

Assumption C. The high-level function of Problem (BP) is such that Th. (BP) guarantees the existence of an optimal solution to (BP) if (BP) is an optimistic bilevel problem, or of an ε -solution (for every $\varepsilon > 0$) to (BP) if (BP) is a pessimistic bilevel problem.

According to the different type of problem (BP), Assumption C is satisfied for instance if f is inf-compact, lower semicontinuous in $z \dots$ (see precisely the corresponding theorem Th. (BP) to have the precise assumptions).

To explain the idea, we consider for instance (BP) as the optimistic version of the continuous bilevel problem 4.1. Here, Th. (BP) is Theorem 4.17. We established in Theorem 4.17 that this problem is equivalent to:

$$\min_{\mathcal{C} \in \mathcal{S}} \left[\inf_{y \in \mathcal{C}} \inf_{z \in \phi(\mathcal{C})} f(z, y) \right].$$

Under Assumption C, an optimal solution exists. Assumption C is true if f is jointly lower semicontinuous and inf-compact. The subproblem $(SP_{\mathcal{C}})$ is the following one:

$$\inf_{y \in \mathcal{C}} \inf_{z \in \phi(\mathcal{C})} f(z, y),$$

where \mathcal{C} is a polyhedron defined by a set of inequalities, and $\phi(\mathcal{C})$ is a polytope defined as the convex hull of its vertices. For instance, if f is convex in y and z^* , then each subproblem of the optimistic version of Problem 4.1 can be solved thanks to classical convex optimization techniques (gradient algorithm, Newton or interior point methods, \dots).

Intuitively, the sketch of the algorithm is the following. In order to define each subproblem, we need first to compute the cells of the subdivision \mathcal{S} and the dual cells in \mathcal{S}' . We will refer to this task as *cell enumeration*, being understood that we are interested in listing effectively all the cells, not just counting them. By definition of \mathcal{S} , the cells are the projection of the faces of the epigraph $\text{epi}(Q)$ of Q . So, we have equivalently to enumerate the faces of $\text{epi}(Q)$. We use an algorithm proposed by Fukuda, Liebling and Margot [FLM97]. These faces are defined by a set of inequalities. Then, we determine the dual cell $\phi(\mathcal{C})$. By definition of the bijection ϕ given in Section 3.3, the dual cell $\phi(\mathcal{C})$ is given by the set of its vertices. We assume that it is "easy" to solve each subproblem when the different cells \mathcal{C} and their dual cells $\phi(\mathcal{C})$ are defined

respectively by a list of inequalities and by the convex hull of their vertices. We can consequently solve each subproblem. We obtain the optimal solution and the optimal value. Finally, we keep the minimal optimal value, and the corresponding optimal solution.

Algorithm 2 Sketch of the algorithm to solve the bilevel problem (BP)

1. Determine a definition of $\text{epi}(Q)$ by a list of inequalities.
 2. Enumerate the faces of $\text{epi}(Q)$. Deduce the cells \mathcal{C} of \mathcal{S} and the dual cells $\phi(\mathcal{C})$.
 3. Solve each subproblem.
 4. Deduce the optimal value of the bilevel problem.
-

As in Chapter 4, we are interested in the case in which the dimension of the high-level problem n is much smaller than the dimension of the low-level problem k . Consequently, we want to answer to the following question: is there an implementation of the approach of Algorithm 2 such that its complexity depends polynomially of the low-level dimension k , when all other parameters are fixed ?

Intuitively, if each subproblem is "easy" to solve, the complexity of such an algorithm depends on the total number of subproblems, that is the total number of cells of \mathcal{S} . It depends also on the number of operations needed to enumerate all the cells of \mathcal{S} . The enumeration of the cells of \mathcal{S} is developed in Section 5.1.2. The complexity of the algorithm of Fukuda et al. [FLM97] depends on the total number of cells in \mathcal{S} and on the number of inequalities needed to define the polyhedron $\text{epi}(Q)$. Finally, it depends on the number of operations needed to obtain these inequalities. We also show in Section 5.1.2 that these inequalities can be obtained in polynomial time in the low-level dimension when the high-level dimension is fixed under the following assumption, that we make for the rest of this chapter.

Assumption D. The polytope \mathcal{P} is an integer polytope of \mathbb{R}^k and the matrix C has integer entries. If (BP) is the optimistic or pessimistic version of the discrete bilevel problem 4.2, then we assume additionally that the matrix $[C \ A^T]$ is totally unimodular.

In a second time, we estimate the number of cells of \mathcal{S} . This is the topic of Section 5.2. In the general case, we provide an upper bound over the total number of faces in \mathcal{S} . This upper bound requires Assumption D. Moreover, we focus on a particular case in which the Newton polytope of Q , that is $C^T\mathcal{P}$, is a simplex. By duality, the number of cells of \mathcal{S} is equal to the number of cells of the dual subdivision \mathcal{S}' of $C^T\mathcal{P}$. We show that when the high-level dimension n is small ($n \leq 4$), it is possible to find a better upper bound of the total number of cells of \mathcal{S}' which is attained for a particular subdivision, called edgewise subdivision, of \mathcal{S}' .

In Section 5.3, we use these upper bounds to estimate the total complexity of Algorithm 2. We prove in particular the main result of this chapter.

Theorem 5.1 (Fixed parameter tractability of the bilevel problem (BP)). *Assume that an ε -solution of each subproblem ($SP_{\mathcal{C}}$) can be obtained in polynomial time when the high-level dimension is fixed. Then, Algorithm 2 returns an ε -solution of (BP) in polynomial time in the low-level dimension and in a metric estimate of $C^T\mathcal{P}$, when the high-level dimension is fixed.*

This theorem is proved for each possible bilevel problem (BP). The complexity bounds are in fact different for each problem, but they have the property stated in Theorem 5.1.

Finally, in Section 5.4, we discuss the results proven in this chapter.

5.1 Enumerating the cells

5.1.1 Determining the epigraph

In this section, we recall that we study the bilevel problem (BP), which satisfies Assumption C. We recall also that we make Assumption D. Hence, the low-level problem of (BP) defines a tropical polynomial Q , which is defined by:

$$\forall y \in \mathbb{R}^n, Q(y) = \max_{z \in C^T \mathcal{E}(\mathcal{P})} [\langle y, z \rangle + \varphi(z)],$$

where φ is defined by:

$$\forall z \in C^T \mathcal{P}, \varphi(z) = \max_{x \in \mathcal{P}, C^T x = z} \langle \rho, x \rangle. \quad (5.2)$$

We refer the reader to Section 4.2.1 for the introduction of the different notations.

The epigraph $\text{epi}(Q)$ of Q is then an unbounded polyhedron of \mathbb{R}^{n+1} defined by a list of inequalities:

$$\text{epi}(Q) = \{(y, y_{n+1}) \in \mathbb{R}^n \times \mathbb{R} \mid \forall z \in C^T \mathcal{E}(\mathcal{P}), y_{n+1} \geq \langle y, z \rangle + \varphi(z)\}.$$

The projection of the faces of $\text{epi}(Q)$ over the n first entries defines a regular subdivision \mathcal{S} .

Our first aim is to determine the inequalities defining $\text{epi}(Q)$. It suffices to know the points of $C^T \mathcal{E}(\mathcal{P})$. However, $\mathcal{P} \subset \mathbb{R}^k$, where k is the low-level dimension of (BP). Then, the number of vertices of \mathcal{P} can be exponential in k . Since we deal with bilevel problems with a large low-level dimension, we have to avoid to enumerate directly the vertices of \mathcal{P} .

Since Assumption D is satisfied, we have $\mathcal{E}(\mathcal{P}) \in \mathbb{Z}^k$ and $C^T \mathcal{E}(\mathcal{P}) \in \mathbb{Z}^n$. Then, the following inclusion chain holds:

$$C^T \mathcal{E}(\mathcal{P}) \subset C^T \mathcal{P} \cap \mathbb{Z}^n \subset C^T \mathcal{P}. \quad (5.3)$$

Moreover, by using Equations (4.11), (4.13), and (4.14), we have for every $y \in \mathbb{R}^n$:

$$\begin{aligned} Q(y) &= \max_{z \in C^T \mathcal{E}(\mathcal{P})} [\langle y, z \rangle + \varphi(z)] = \max_{x \in \mathcal{E}(\mathcal{P})} \langle \rho + Cy, x \rangle = \max_{x \in \mathcal{P}} \langle \rho + Cy, x \rangle \\ &= \max_{z \in C^T \mathcal{P}} [\langle y, z \rangle + \varphi(z)]. \end{aligned}$$

Then, it follows:

$$Q(y) = \max_{z \in C^T \mathcal{P} \cap \mathbb{Z}^n} [\langle y, z \rangle + \varphi(z)]. \quad (5.4)$$

Consequently, the polyhedron $\text{epi}(Q)$ is described by the following inequalities:

$$\text{epi}(Q) = \{(y, y_{n+1}) \in \mathbb{R}^n \times \mathbb{R} \mid \forall z \in C^T \mathcal{P} \cap \mathbb{Z}^n, y_{n+1} \geq \langle y, z \rangle + \varphi(z)\}.$$

We denote by $n_{\mathbb{Z}}$ the number of integer points in $C^T \mathcal{P}$, that is:

$$n_{\mathbb{Z}} = \#(C^T \mathcal{P} \cap \mathbb{Z}^n).$$

To estimate the number $n_{\mathbb{Z}}$ of integer points in $C^T \mathcal{P}$, we have the following result.

Proposition 5.2. *Let R be a strictly positive real defined by:*

$$R = k \|C\|_{\infty} \max_{j \in [k]} (|\min_{x \in \mathcal{P}} x_j|, |\max_{x \in \mathcal{P}} x_j|). \quad (5.5)$$

Then, $C^T \mathcal{P} \cap [-R, R]^n$.

Proof. Let $z \in C^T \mathcal{E}(\mathcal{P})$. Then, there exists $x \in \mathcal{E}(\mathcal{P})$ such that $z = C^T x$. For every $i \in [n]$, we have:

$$z_i = \sum_{j=1}^k c_{ji} x_j.$$

For every $j \in [k]$, we define $m_j = \min_{x \in \mathcal{P}} x_j$ and $M_j = \max_{x \in \mathcal{P}} x_j$. Then, for every $j \in [k]$, we have $m_j \leq x_j \leq M_j$. Then, for every $i \in [n]$:

$$|z_i| \leq \sum_{j=1}^k |c_{ji}| x_j \leq k \|C\|_\infty \max_{j \in [k]} (|m_j|, |M_j|).$$

□

Corollary 5.3. *The number $n_{\mathbb{Z}}$ of integer points in $C^T \mathcal{P} \cap \mathbb{Z}^n$ satisfies:*

$$n_{\mathbb{Z}} \leq (2R + 1)^n.$$

Proof. It comes directly from Proposition 5.2 since the number of integer points in $[-R, R]^n$ is equal to $(2R + 1)^n$. □

Finally, we have to calculate $\varphi(z)$ for every $z \in C^T \mathcal{P} \cap \mathbb{Z}^n$. Let $z \in [-R, R]^n \cap \mathbb{Z}^n$. By Equation 5.2, if $z \notin C^T \mathcal{P}$, then we have $\varphi(z) = -\infty$. To evaluate $\varphi(z)$ for every $z \in [-R, R]^n$, we solve a linear program in dimension k defined by p inequalities and n equalities. By replacing $C^T x = z$ by $C^T x \leq z$ and $C^T x \geq z$, we can formulate this linear program with $p + 2n$ inequality constraints. For the rest of this chapter, we denote by $\text{LP}(m, n, L)$ the time needed to solve a linear program in dimension n with m inequality constraints, when the input size of the linear program is coded by L bits. A large class of algorithms exist to solve such a problem, like the simplex algorithm, interior point methods In particular, the interior point methods (see [Kar84, Ren88]) provide a polynomial time algorithm for solving a linear program. Renegar [Ren88] proved $\text{LP}(m, n, L) = O((m + n)^{3.5} L)$.

Proposition 5.4. *The set of points:*

$$\{(z, \varphi(z)) \mid z \in C^T \mathcal{P} \cap \mathbb{Z}^n\},$$

can be obtained in $O((2R)^n \text{LP}(p + 2n, k, L))$ time, where L is the input size.

Proof. We need to solve $(2R + 1)^n$ linear programs in dimension k with $p + 2n$ inequality constraints to decide whether $z \in [-R, R]^n$ belongs to $C^T \mathcal{P} \cap \mathbb{Z}^n$ or not, and if it does, to calculate the value $\varphi(z)$. □

Consequently, it is possible to obtain a description of $\text{epi}(Q)$ by a list of inequalities in polynomial time in the dimension of the low-level problem.

5.1.2 Algorithm for enumerating the cells of \mathcal{S}

In this section, we show how to obtain all the cells of \mathcal{S} , or equivalently, all the faces of the polyhedron $\text{epi}(Q)$ defined by:

$$\text{epi}(Q) = \{(y, y_{n+1}) \in \mathbb{R}^n \times \mathbb{R} \mid \forall z \in C^T \mathcal{P} \cap \mathbb{Z}^n, y_{n+1} \geq \langle y, z \rangle + \varphi(z)\}.$$

It is a $(n + 1)$ -dimensional polyhedron defined by $n_{\mathbb{Z}}$ inequalities.

In [HJP13], Herrmann, Joswig and Pfetsch study the different existing algorithms to enumerate the faces of an unbounded polyhedron. Two types of algorithm exist. The first type consists in enumerating directly the faces of a polyhedron given by a set of inequalities. Such an algorithm was developed by Fukuda, Liebling and Margot in [FLM97]. Assume that the polyhedron is $\{x \in \mathbb{R}^n \mid Ax \leq b\}$, where $b \in \mathbb{Q}^m$ and A is a $m \times n$ matrix with rational entries. The different inequalities give a list of possible facets of the polytope. One defines possible faces as intersections of these facets, and a linear program is solved to know whether such a face exists or not. The algorithm returns all the faces of the polyhedron in $O(mLP(m, n, L)f)$ time, where L is the input size and f the total number of faces of the polyhedron. We can then apply directly this algorithm to enumerate all the faces of $\text{epi}(Q)$.

Theorem 5.5 (Corollary of Th. 3.1 of [FLM97]). *The faces of the polyhedron $\text{epi}(Q)$ can be enumerated in $O(n_{\mathbb{Z}}LP(n_{\mathbb{Z}}, n + 1, L)f)$ time, where L is the input size and f the total number of faces of $\text{epi}(Q)$.*

This approach needs to solve a large number of linear programs. The second type of algorithms is applied only on bounded polyhedron. In [FR94], Fukuda and Rosta propose an algorithm to enumerate all the faces of a polytope when its vertex-facet incidence matrix is given. The rows of such a matrix represent the vertices of the polytope, whereas the columns represent the facets. Then, $U_{vF} = 1$ if the vertex v belongs to F , and $U_{vF} = 0$ otherwise. That needs to know all the facets and all the vertices of the polytope, and the vertices belonging to each facet. If we consider a polytope of \mathbb{R}^n with f_n facets and f_0 vertices, and denoting by f the total number of faces of the polytope, the algorithm runs in $O(\min(f_n, f_0)nf^2)$. If the polytope is simple and if a good orientation of the graph induced by the polytope is provided, the algorithm can be accelerated to $O(nf)$. In [KP02], Kaibel and Pfetsch propose another algorithm which improves the complexity bound of Fukuda and Rosta. With a given vertex-facet incidence matrix, the algorithm generates the face lattice of the polytope in $O(\min(f_n, f_0)\alpha f)$, where α is the number of ones in the incidence matrix. The complexity can also be improved for simple polytopes in $O(n\alpha f)$ with no special orientation provided.

When a polyhedron is given by a list of inequalities, meaning that we know its facets, we need first to enumerate its vertices. In [AF92], Avis and Fukuda propose an algorithm based on reverse search (see [AF96]) to solve the following problem: given a $m \times n$ matrix A and a vector $b \in \mathbb{R}^m$, what are the vertices of the polyhedron $\{x \in \mathbb{R}^n \mid Ax \leq b\}$. The general time complexity of the proposed algorithm is $O(m^2n \binom{m}{n})$. However, if the polyhedron $\{x \in \mathbb{R}^n \mid Ax \leq b\}$ is non-degenerate, that is each vertex is defined by exactly n equalities, the algorithm is output sensitive and the complexity is $O(m^2nv)$, where v is the number of vertices of the polyhedron. This already leads to a considerable improvement since McMullen's upper bound theorem shows that v is of order $\binom{m}{n/2}$. Moreover, if the polyhedron is simple (that is each facet has exactly n vertices), the algorithm can be accelerated to $O(mnv)$ time.

When a polyhedron is unbounded, its vertices can be enumerated by the algorithm proposed by Avis and Fukuda. However, to use the algorithm proposed by Kaibel and Pfetsch to enumerate the faces, we need to bound the polyhedron, by introducing one or several additional facets. Such an approach is proposed in Appendix A.

The second type of algorithms need to bound the polyhedron $\text{epi}(Q)$. However, they do not need to solve a linear program. In particular if $\text{epi}(Q)$ is simple, the bound gives by Avis and Fukuda algorithm is much better than in the general case, and to apply this type of algorithms can be relevant. Moreover, it depends on the number of inequalities : for a polyhedron defined

by a very few number of inequalities, the time complexity of the algorithm proposed by Fukuda et al. [FLM97] is small.

5.2 Counting the number of cells

In Section 5.1.2, we present an algorithm to enumerate all the cells of the subdivision \mathcal{S} . Theorem 5.5 proves that the complexity of this algorithm depends on combinatorial characteristics of the polyhedra $\text{epi}(Q)$ like the number of $n_{\mathbb{Z}}$ of inequalities which define $\text{epi}(Q)$, or the total number of faces f of $\text{epi}(Q)$. Moreover, the complexity of Algorithm 2 depends also on the number of subproblems of type $(\text{SP}_{\mathcal{C}})$ to solve (BP) . The number of subproblems to solve corresponds to the total number of faces of the polyhedron $\text{epi}(Q)$.

In this section, we try to identify these different numbers, or to give a tighter upper bound of these numbers. These numbers can depend on the polytope \mathcal{P} , on the matrix C and on the dimensions of the problem n and k . The question is to know if this number can be a polynomial in certain of these parameters. The aim is to obtain a fixed-parameter tractability result, that is to prove that solving the bilevel programming problems (BP) can be done in polynomial time in certain parameters when the other ones are fixed.

We define $f(\mathcal{S}) \in \mathbb{N}^{n+1}$ as the f -vector of \mathcal{S} (as defined in Section 3.2), that is $f(\mathcal{S}) = (f_0(\mathcal{S}), \dots, f_n(\mathcal{S}))$ with for each $0 \leq d \leq n$, $f_d(\mathcal{S})$ is the number of d -dimensional cells in \mathcal{S} . Similarly, we denote by $f(\mathcal{S}')$ the f -vector of \mathcal{S}' . We recall that for each $0 \leq d \leq n$, we have $f_d(\mathcal{S}) = f_{n-d}(\mathcal{S}')$, as a direct consequence of Theorem 3.8. Finally, as in Section 5.1.2, we denote by $n_{\mathbb{Z}} = \#(C^T \mathcal{P} \cap \mathbb{Z}^n)$ the number of integer points in $C^T \mathcal{P}$.

The different monomials of the tropical polynomial Q correspond to exponents in $C^T \mathcal{E}(\mathcal{P})$. It means that the number of full-dimensional cells in \mathcal{S} (or equivalently of zero-dimensional cells in \mathcal{S}') is bounded by the number of points in $C^T \mathcal{E}(\mathcal{P})$. We recall that $C^T \mathcal{E}(\mathcal{P}) \subset \mathbb{Z}^n$ because C has only integer coefficients and \mathcal{P} is an integer polytope.

In the next paragraph, we study the general case and find some upper bounds about the different coordinates of the f -vectors of \mathcal{S} and $\mathcal{P}(Q)$ and about the number $n_{\mathbb{Z}}$. We next study the particular case $C^T \mathcal{P} \subset \Delta_d$, where Δ_d denotes the d -simplex ($\Delta_d = \{z \in \mathbb{R}_+^n \mid \sum_{i=1}^n z_i \leq d\}$). We give for small values of n ($n \leq 4$) the maximal number of cells of a subdivision of Δ_d . It leads to more precise upper bounds in this case.

5.2.1 General upper bounds

Without any additional assumption, we can find some upper bounds about the numbers $f_d(\mathcal{S})$ for each $0 \leq d \leq n$ and about $n_{\mathbb{Z}}$.

We recall first the next result.

Proposition 5.6. $f_n(\mathcal{S}) \leq n_{\mathbb{Z}}$.

Proof. We have $f_n(\mathcal{S}) = f_0(\mathcal{S}')$. Because \mathcal{P} is assumed to be an integer polytope and C has integer coefficients, we have $C^T \mathcal{E}(\mathcal{P}) \subset C^T \mathcal{P} \cap \mathbb{Z}^n$. Moreover, the 0-dimensional cells of \mathcal{S}' correspond to points which are in $C^T \mathcal{E}(\mathcal{P})$. \square

We observe that \mathcal{S}' defines a polyhedral complex with boundary equal to the Newton polytope of Q . The full-dimensional cells of \mathcal{S}' are polyhedra with vertices included in $C^T \mathcal{E}(\mathcal{P}) \subset \mathbb{Z}^n$. We have the following result concerning polyhedra with integer vertices.

Lemma 5.7. *Let Δ be a polyhedron of \mathbb{R}^n with vertices included in \mathbb{Z}^n . Then, the volume of Δ is such that $n! \text{Vol}(\Delta) \in \mathbb{N}$.*

Proof. Let Δ be a polyhedron of \mathbb{R}^n . If the number of vertices of Δ is less or equal than n , then Δ is included in an affine hyperplane of \mathbb{R}^n and $\text{Vol}(\Delta) = 0$.

If the number of vertices of Δ is exactly $n+1$, then it is a simplex. Denote by $v_0, \dots, v_n \in \mathbb{Z}^n$ its vertices. Then:

$$\text{Vol}(\Delta) = \frac{1}{n!} |\det(v_1 - v_0, \dots, v_n - v_0)|$$

The matrix $(v_1 - v_0, \dots, v_n - v_0)$ has only integer coefficients, so its determinant is an integer and $n! \text{Vol}(\Delta) \in \mathbb{N}$.

If the number of vertices of Δ is bigger or equal than $n+2$, then Δ can be triangulated in full-dimensional simplices T_1, \dots, T_r because all polytopes have triangulations ([DLRS10], prop. 2.2.4). We have $\forall i \in [r], n! \text{Vol}(T_i) \in \mathbb{N}$ and $n! \text{Vol}(\Delta) = n! \sum_{i=1}^r \text{Vol}(T_i) \in \mathbb{N}$. \square

Lemma 5.7 gives an upper bound about the number of 0-dimensional cells in \mathcal{S} .

Proposition 5.8. *The number $f_0(\mathcal{S})$ of 0-dimensional cells in \mathcal{S} is such that:*

$$f_0(\mathcal{S}) \leq n! \text{Vol}(C^T \mathcal{P})$$

Proof. We have $f_0(\mathcal{S}) = f_n(\mathcal{S}')$. The n -dimensional cells in \mathcal{S}' subdivide the polytope $C^T \mathcal{P}$. Then, $\text{Vol}(C^T \mathcal{P}) = \sum_{C'_n \in \mathcal{S}'_n} \text{Vol}(C'_n)$. Consider a cell $C'_n \in \mathcal{S}'_n$. It is a polyhedron with integer vertices. By Lemma 5.7, we have $n! \text{Vol}(C'_n) \in \mathbb{N}$. Because C'_n is full-dimensional, then $\text{Vol}(C'_n) > 0$. So $n! \text{Vol}(C'_n) \geq 1$. Moreover, $n! \text{Vol}(C^T \mathcal{P}) \in \mathbb{N}$ by Lemma 5.7. So, $n! \text{Vol}(C^T \mathcal{P}) \geq \sum_{C'_n \in \mathcal{S}'_n} 1 = f_n(\mathcal{S}') = f_0(\mathcal{S})$. \square

Moreover, it is also possible to deduce from Lemma 5.7 an upper bound about the number of integer points in $C^T \mathcal{P}$. We recall first a classical lower bound theorem about simplicial balls.

Theorem 5.9 ([DLRS10], Th. 2.6.1.). *Let K be a d -dimensional simplicial ball with N vertices. Then $f_d(K) \geq N - d$.*

Proposition 5.10. *The number $n_{\mathbb{Z}}$ of integer points in $C^T \mathcal{P}$ is such that:*

$$n_{\mathbb{Z}} \leq n + n! \text{Vol}(C^T \mathcal{P})$$

Proof. Suppose that there are $n_{\mathbb{Z}}$ integer points in $C^T \mathcal{P}$. Then, any triangulation of the point configuration defined by these $n_{\mathbb{Z}}$ integer points contains at least $n_{\mathbb{Z}} - n$ full-dimensional simplices by Theorem 5.9. All of these simplices have integer vertices. So, by Lemma 5.7, the volume of each of these simplices is bigger or equal than $\frac{1}{n!}$. So:

$$\text{Vol}(C^T \mathcal{P}) \geq \frac{n_{\mathbb{Z}} - n}{n!}$$

The result comes straightforwardly. \square

Corollary 5.11. $f_n(\mathcal{S}) \leq n + n! \text{Vol}(C^T \mathcal{P})$

Proof. This follows readily from Proposition 5.6 and Proposition 5.10. \square

It is also possible to obtain an upper bound about the total number of cells.

Theorem 5.12. *The total number $\sum_{d=0}^n f_d(\mathcal{S})$ of cells of \mathcal{S} is such that:*

$$\sum_{d=0}^n f_d(\mathcal{S}) \leq n!(2^{n+1} - 1) \text{Vol}(C^T \mathcal{P})$$

Proof. We have $\sum_{d=0}^n f_d(\mathcal{S}) = \sum_{d=0}^n f_d(\mathcal{S}')$. Hence, $\#\mathcal{S}$ is bounded by the total number of faces of a polytopal complex defining a subdivision of $C^T \mathcal{P}$. Consider a subdivision of $C^T \mathcal{P}$ such that the total number of faces of this subdivision is maximal. This subdivision is a triangulation. In fact, if one of the full-dimensional cells of this subdivision is not a simplex, it can be triangulated ([DLRS10], prop. 2.2.4). Then, this triangulation defines a new subdivision which more faces than the previous one. The maximal number of simplices in a triangulation of $C^T \mathcal{P}$ is $n! \text{Vol}(C^T \mathcal{P})$, according to Proposition 5.8.

Moreover, a simplex is defined by $n+1$ vertices, and the convex hull of $d+1$ of these vertices is a d -dimensional cell of the simplex. Hence, the number of d -dimensional cells of a simplex in \mathbb{R}^n is $\binom{n+1}{d+1}$. Hence, the total number of faces of a simplex is $\sum_{d=0}^n \binom{n+1}{d+1} = 2^{n+1} - 1$. Consequently:

$$\sum_{d=0}^n f_d(\mathcal{S}') \leq (2^{n+1} - 1) f_n(\mathcal{S}'),$$

which leads to the statement of the proof by Proposition 5.10. \square

5.2.2 Specific upper bounds for the simplex

In this section, we consider that $C^T \mathcal{P}$ is a simplex Δ_d , that is:

$$C^T \mathcal{P} = \Delta_d = \{z \in \mathbb{R}_+^n \mid \sum_{i=1}^n z_i \leq d\}.$$

Proposition 5.2 show that $C^T \mathcal{P}$ is included in a hypercube. Let $z \in C^T \mathcal{P}$. Instead of obtaining inequalities over each coordinate z_i , it is also possible to adapt the proof of Proposition 5.2 to obtain an inequality over $\sum_{i=1}^n z_i$.

The full-dimensional cells in \mathcal{S} correspond to integer points of $C^T \mathcal{P}$. The number of full-dimensional cells in \mathcal{S} is consequently less than the number of integer points in Δ_d , which is characterized by the following lemma:

Lemma 5.13. *The number of integer points in Δ_d is $\#(\Delta_d \cap \mathbb{Z}^n) = \binom{n+d}{n}$. Hence, the number of cells in \mathcal{S}_n is such that $\#\mathcal{S}_n \leq \binom{n+d}{n}$.*

Proof. Consider $z \in \Delta_d \cap \mathbb{Z}^n$, and define $\hat{z} \in \mathbb{Z}^{n+1}$ such that $\forall i \in [n]$, $\hat{z}_i = z_i$ and $\hat{z}_{n+1} = d - \sum_{i=1}^n z_i$. The application $z \mapsto \hat{z}$ defines clearly a bijection between $\Delta_d \cap \mathbb{Z}^n$ and the set of integer points of the simplex $\{\hat{z} \in \mathbb{Z}^{n+1} \mid z \geq 0, \sum_{i=1}^{n+1} \hat{z}_i = d\}$. The number of points in $\Delta_d \cap \mathbb{Z}^n$ is equal to the number of integer points of this simplex, which corresponds to the number of partitions of an integer d in $n+1$ parts. There exists a bijection between the set of partitions of an integer d in $n+1$ parts and the hypersimplex $\{x \in \{0; 1\}^{n+d} \mid \sum_{i=1}^{n+d} x_i = n\}$, defined in the following way. To each partition (q_1, \dots, q_{n+1}) of d , we associate the vector $x \in \{0, 1\}^{n+d}$ such that for all $j \in [n]$, $x_{q_1+\dots+q_j+j} = 1$, the other coordinates of x being equal to 0. It is clearly well-defined because $\sum_{i=1}^{n+1} q_i = d$, then for all $j \in [n]$, $1 \leq q_1 + \dots + q_j + j \leq d + n$. Moreover, $\sum_{i=1}^{n+d} x_i = n$. This application defines a bijection. Consider $x \in \{0, 1\}^{n+d}$ with

exactly n ones. Denote by j_1, \dots, j_n the indices of x such that $x_j = 1$. Then, the preimage of x by this application is (q_1, \dots, q_{n+1}) with:

$$q_1 = j_1 - 1, \quad \forall i \in \{2, \dots, n\}, q_i = j_i - j_{i-1} - 1, \quad q_{n+1} = d - \sum_{i=1}^n q_i$$

It is well-defined because $\sum_{i=1}^n q_i = j_n - n \leq d$. Consequently, the number of points in $\Delta_d \cap \mathbb{Z}^n$ is equal to the number of points in $\{0, 1\}^{n+d}$ with exactly n ones, that is $\binom{n+d}{n}$. Consequently:

$$\#\mathcal{S}_n = \#C^T\mathcal{E}(\mathcal{P}) \leq \#(\Delta_d \cap \mathbb{Z}^n) = \binom{n+d}{n}$$

□

We have now to try to find a more precise upper bound to the number of cells in \mathcal{S} (which is equal to the number of cells of \mathcal{S}') than the bound given in Theorem 5.12. The question is to find a subdivision of $C^T\mathcal{P}$, such that all cells of this subdivision has vertices in $C^T\mathcal{E}(\mathcal{P})$, and with the maximal possible number of cells. Because $C^T\mathcal{P} \subset \Delta_d$ and $C^T\mathcal{E}(\mathcal{P}) \subset \mathbb{Z}^n$, we try to find a subdivision of Δ_d , in which all cells have integer vertices, and with the maximal possible number of cells. Such a subdivision defines a polyhedral complex with boundary equal to Δ_d . For any subdivision $\mathcal{S}(\Delta_d)$ of Δ_d , we denote by $f(\mathcal{S}(\Delta_d)) = (f_0(\mathcal{S}(\Delta_d)), \dots, f_n(\mathcal{S}(\Delta_d)))$ its f -vector, that is $f_j(\mathcal{S}(\Delta_d))$ is the number of j -dimensional cells in $\mathcal{S}(\Delta_d)$. Then, we search a subdivision $\mathcal{S}^{\max}(\Delta_d)$ such that for all subdivision $\mathcal{S}(\Delta_d)$, we have:

$$\sum_{i=0}^n f_i(\mathcal{S}^{\max}(\Delta_d)) \geq \sum_{i=0}^n f_i(\mathcal{S}(\Delta_d))$$

We already observed in the proof of Theorem 5.12 that $\mathcal{S}^{\max}(\Delta_d)$ is a triangulation. Moreover, consider a subdivision $\mathcal{S}(\Delta_d)$ of Δ_d . It follows from Lemma 5.13, that $f_0(\mathcal{S}(\Delta_d)) \leq \binom{n+d}{n}$. It also follows from the proof of Proposition 5.8 that $f_n(\mathcal{S}(\Delta_d)) \leq n! \text{Vol}(\Delta_d) = d^n$.

We define a particular subdivision of Δ_d , which is called an *edgewise subdivision* and denoted by $\text{Eds}(\Delta_d)$.

This subdivision is introduced in [EG00]. An example is shown on Figure 5.1.

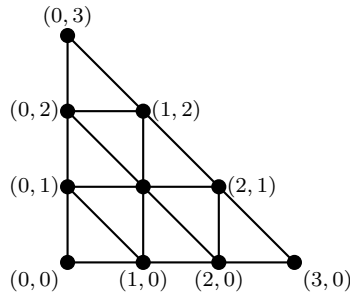

Figure 5.1: An edgewise subdivision of Δ_3 in dimension 2

The 0-dimensional cells of this subdivision are the integer points of Δ_d . Then, $f_0(\text{Eds}(\Delta_d)) = \binom{n+d}{n}$.

Moreover, the number of n -dimensional cells in $\text{Eds}(\Delta_d)$ is given by the following result.

Lemma 5.14 ([EG00], Volume Lemma). *Each n -dimensional cell in $\text{Eds}(\Delta_d)$ has a volume equal to $\frac{1}{n!}$, and $f_n(\text{Eds}(\Delta_d)) = d^n$.*

In [EG00], the precise value of the number of j -dimensional cells of $\text{Eds}(\Delta_d)$ is given:

Lemma 5.15 ([EG00]). *The number of j -dimensional cells in $\text{Eds}(\Delta_d)$ is*

$$f_j(\text{Eds}(\Delta_d)) = \sum_{i=0}^j (-1)^i \binom{j}{i} \binom{n + (j+1-i)d}{n}$$

Notice that for the case $j = 0$, we find again the result of Lemma 5.13.

We can now establish the main theorem of this paragraph:

Theorem 5.16. *Suppose $n \leq 4$. Then, $\text{Eds}(\Delta_d)$ maximizes the total number of faces of a subdivision of Δ_d , that is for all subdivisions $\mathcal{S}(\Delta_d)$ of Δ_d , we have:*

$$\sum_{i=0}^n f_i(\text{Eds}(\Delta_d)) \geq \sum_{i=0}^n f_i(\mathcal{S}(\Delta_d))$$

Proof. Take a subdivision $\mathcal{S}(\Delta_d)$ of Δ_d . Without loss of generality, we suppose that $\mathcal{S}(\Delta_d)$ is a triangulation (if it is not, it is always possible to triangulate it to obtain a triangulation with strictly more faces than $\mathcal{S}(\Delta_d)$, as we remarked above). We already know by Proposition 5.8 and Corollary 5.14 that $f_n(\mathcal{S}(\Delta_d)) \leq d^n = f_n(\text{Eds}(\Delta_d))$. Moreover, $f_0(\mathcal{S}(\Delta_d)) \leq \binom{n+d}{n} = f_0(\text{Eds}(\Delta_d))$ by Lemma 5.13. Denote by $\partial\mathcal{S}(\Delta_d)$ (resp. $\partial\text{Eds}(\Delta_d)$) the boundary of $\mathcal{S}(\Delta_d)$ (resp. $\text{Eds}(\Delta_d)$). Each $n-1$ -dimensional cell of $\mathcal{S}(\Delta_d)$ inside Δ_d is common to two different n -dimensional cells of $\mathcal{S}(\Delta_d)$, whereas each $n-1$ -dimensional cell of $\partial\mathcal{S}(\Delta_d)$ belongs only to one n -dimensional cell of $\mathcal{S}(\Delta_d)$. Intuitively, we may think of an $n-1$ -dimensional cell of Δ_d as a “wall” separating “rooms” constituted by n -dimensional cells: a wall separates precisely two rooms if the wall is inside Δ_d , whereas if the wall lies at the boundary of Δ_d , one of these two rooms is absent.

Because each n -dimensional cell of $\mathcal{S}(\Delta_d)$ is a simplex, it has exactly $n+1$ faces of dimension $n-1$. Then, exploiting the previous observation, and counting $n-1$ -dimensional cells in two different ways, we arrive at the following equality:

$$2(f_{n-1}(\mathcal{S}(\Delta_d)) - f_{n-1}(\partial\mathcal{S}(\Delta_d))) + f_{n-1}(\partial\mathcal{S}(\Delta_d)) = (n+1)f_n(\mathcal{S}(\Delta_d))$$

that is:

$$f_{n-1}(\mathcal{S}(\Delta_d)) = \frac{1}{2}((n+1)f_n(\mathcal{S}(\Delta_d)) + f_{n-1}(\partial\mathcal{S}(\Delta_d))) \quad (5.6)$$

The boundary of Δ_d consists of $n+1$ faces, which are $n+1$ simplices of dimension $n-1$. By applying Proposition 5.8 and Corollary 5.14 in dimension $n-1$, we deduce:

$$f_{n-1}(\partial\mathcal{S}(\Delta_d)) \leq (n+1)d^{n-1} = f_{n-1}(\partial\text{Eds}(\Delta_d))$$

Then, $f_{n-1}(\mathcal{S}(\Delta_d)) \leq f_{n-1}(\text{Eds}(\Delta_d)) = \frac{1}{2}(n+1)d^{n-1}(d+1)$.

Suppose now that $n = 2$. Then, according to Lemma 3.2, we have:

$$f_1(\mathcal{S}(\Delta_d)) = -1 + f_0(\mathcal{S}(\Delta_d)) + f_2(\mathcal{S}(\Delta_d)) \leq -1 + f_0(\text{Eds}(\Delta_d)) + f_2(\text{Eds}(\Delta_d)) = f_1(\text{Eds}(\Delta_d))$$

Suppose $n = 3$. Then, according to Lemma 3.2, we have:

$$\begin{aligned} f_1(\mathcal{S}(\Delta_d)) + f_3(\mathcal{S}(\Delta_d)) &= -1 + f_0(\mathcal{S}(\Delta_d)) + f_2(\mathcal{S}(\Delta_d)) \\ &\leq -1 + f_0(\text{Eds}(\Delta_d)) + f_2(\text{Eds}(\Delta_d)) = f_1(\text{Eds}(\Delta_d)) + f_3(\text{Eds}(\Delta_d)) \end{aligned}$$

Suppose now $n = 4$. According to Lemma 3.2, we have $\chi(\mathcal{S}(\Delta_d)) = 1$. According to Theorem 3.4, we have $h_1(\partial\mathcal{S}(\Delta_d)) - h_0(\partial\mathcal{S}(\Delta_d)) = h_1(\mathcal{S}(\Delta_d)) - h_4(\mathcal{S}(\Delta_d))$. Then, by definition of the h -vectors, and by using $f_{-1}(\mathcal{S}(\Delta_d)) = f_{-1}(\partial\mathcal{S}(\Delta_d)) = 1$, we can write:

$$-5 + f_0(\partial\mathcal{S}(\Delta_d)) = -10 - 3f_0(\mathcal{S}(\Delta_d)) + 3f_1(\mathcal{S}(\Delta_d)) - 2f_2(\mathcal{S}(\Delta_d)) + f_3(\mathcal{S}(\Delta_d)) \quad (5.7)$$

Combining equation 5.7 and the equality $3\chi(\mathcal{S}(\Delta_d)) = 3$, we obtain:

$$8 + f_0(\partial\mathcal{S}(\Delta_d)) = f_2(\mathcal{S}(\Delta_d)) - 2f_3(\mathcal{S}(\Delta_d)) + 3f_4(\mathcal{S}(\Delta_d)) \quad (5.8)$$

Equation 5.6 gives $2f_3(\mathcal{S}(\Delta_d)) = f_3(\partial\mathcal{S}(\Delta_d)) + 5f_4(\mathcal{S}(\Delta_d))$. Then:

$$f_2(\mathcal{S}(\Delta_d)) = 8 + f_0(\partial\mathcal{S}(\Delta_d)) + f_3(\partial\mathcal{S}(\Delta_d)) + 2f_4(\mathcal{S}(\Delta_d))$$

Because $f_0(\partial\mathcal{S}(\Delta_d))$, $f_3(\partial\mathcal{S}(\Delta_d))$ and $f_4(\mathcal{S}(\Delta_d))$ are maximal when $\mathcal{S}(\Delta_d) = \text{Eds}(\Delta_d)$, then $f_2(\mathcal{S}(\Delta_d)) \leq f_2(\text{Eds}(\Delta_d))$. By using $\chi(\mathcal{S}(\Delta_d)) = \chi(\text{Eds}(\Delta_d)) = 1$, we obtain $f_1(\mathcal{S}(\Delta_d)) + f_3(\mathcal{S}(\Delta_d)) \leq f_1(\text{Eds}(\Delta_d)) + f_3(\text{Eds}(\Delta_d))$, and then we conclude:

$$\sum_{i=0}^4 f_i(\mathcal{S}(\Delta_d)) \leq \sum_{i=0}^4 f_i(\text{Eds}(\Delta_d)).$$

□

Corollary 5.17. *If $n \leq 4$, then the number $\#\mathcal{S}$ of cells in \mathcal{S} verifies:*

$$\#\mathcal{S} \leq \sum_{j=0}^n \sum_{i=0}^j (-1)^i \binom{j}{i} \binom{n + (j+1-i)d}{n}$$

Proof. The number of cells of \mathcal{S} is equal to the number of cells in \mathcal{S}' , which is less than the number of cells in the elementary subdivision of Δ_d . We conclude by Lemma 5.15. □

Notice that each term $\binom{n+(j+1-i)d}{n}$ is a polynomial in d of degree n . More precisely, the bound of $\#\mathcal{S}$ given in Corollary 5.17 is a polynomial in d of degree n and with coefficients depending only on n .

5.3 Fixed-parameter tractability

These different results lead to the main theorem of this part. We recall that we study a bilevel programming problem (BP) among the optimistic and pessimistic versions of Problem 4.1, 4.2 and 4.3. According to the corresponding theorem Th. (BP), an optimal solution of the bilevel problem (BP) can be obtained by solving a series of optimization subproblems of the type (SP $_{\mathcal{C}}$) given in Table 5.

To solve (BP), we have to be able to solve the subproblems (SP $_{\mathcal{C}}$) for every $\mathcal{C} \in \mathcal{S}$. These subproblems consist in minimizing or maximizing a function over a cartesian product of polyhedra. The first one, corresponding to the cells $\mathcal{C} \in \mathcal{S}$, is defined by a list of inequalities. The

second one, corresponding to the dual cell $\phi(\mathcal{C}) \in \mathcal{S}'$, is defined as the convex hull of its vertices. In order to show that the different versions of the different bilevel problems can be solved in polynomial time in the low-level dimension k when the dimension n is fixed, we have to assume that we can obtain an approximate solution for each subproblem $(\text{SP}_{\mathcal{C}})$ in polynomial time for fixed n . We say that one of the studied bilevel problem satisfies Assumption E if:

Assumption E. Provided the polyhedron \mathcal{C} defined by a list of inequalities and the polytope $\phi(\mathcal{C})$ defined as the convex hull of its vertices, there exists an oracle finding an ε -solution of $(\text{SP}_{\mathcal{C}})$ for every $\varepsilon > 0$ in $T(n, k, p, L, \varepsilon)$ time, where L is the input size and T is a polynomial in $k, p, L, |\log(\varepsilon)|$ when n is fixed.

Assumption E concerns large classes of bilevel programming problems: Problem 4.1 together with f linear in both optimistic and pessimistic versions, f convex in the optimistic case and f convex in y , concave in z^* in the pessimistic one, Problem 4.2 with f convex in y for each $z^* \dots$

We can now write the main results of this Section, showing that the complexities of the different optimization problems is polynomial in the low-level dimension and in the input size, when n is fixed, and precise the complexities in each case.

Theorem 5.18 (Fixed parameter tractability for (BP)). *Algorithm 2 is correct. If the bilevel problem (BP) satisfies Assumption E, then an ε -solution of (BP) can be obtained for every $\varepsilon > 0$ in:*

$$O((2R)^n (LP(p + 2n, k, L_{low}) + R^n LP(R^n, n + 1, L_{low})2n!) T(n, k, p, L_{high}, \varepsilon)),$$

time, where L_{low} and L_{high} are respectively the input sizes of the low-level and high-level problem of (BP).

Proof. Let $\varepsilon > 0$. According to theorem Th. (BP), an ε -solution of (BP) can be obtained by solving:

$$\min_{\mathcal{C} \in \mathcal{S}} \text{val}(\text{SP}_{\mathcal{C}}),$$

where $\text{val}(\text{SP}_{\mathcal{C}})$ is the optimal value of the subproblem $(\text{SP}_{\mathcal{C}})$. Then, Algorithm 2 is correct and returns an ε -solution of (BP).

The polyhedron $\text{epi}(Q)$ can be obtained by a list of inequalities in $O((2R)^n LP(p + 2n, k, L))$ time according to Proposition 5.4. Then, the faces of $\text{epi}(Q)$ (and by projection the cells of \mathcal{S}) can be obtained by the algorithm proposed by Fukuda et al. [FLM97] in $O(R^n LP(R^n, n + 1, L)f)$ time according to Theorem 5.5, where f is the total number of faces of $\text{epi}(Q)$. By Theorem 5.12, we have:

$$f \leq (2^{n+1} - 1)n! \text{Vol}(C^T \mathcal{P}).$$

Moreover, by Proposition 5.2, we have:

$$\text{Vol}(C^T \mathcal{P}) \leq R^n.$$

The faces of $\text{epi}(Q)$ being obtained as intersection of the facets of $\text{epi}(Q)$, the cells of \mathcal{S} are defined by a list of inequalities, meaning that the vertices of the dual cells are obtained directly. Finally, an ε -solution of each subproblem can be obtained in $T(n, k, p, L, \varepsilon)$ time. \square

Theorem 5.18 shows consequently that if we can "easily" solve each subproblem, the bilevel problem (BP) can be solved in polynomial time in the low-level dimension and in a metric estimate of $C^T \mathcal{P}$, when the high-level dimension n is fixed.

If (BP) is the optimistic version of the discrete problem, the complexity bound can be improved, with a weaker assumption than Assumption E.

Assumption F. Provided a point $z \in C^T \mathcal{P} \cap \mathbb{Z}^n$ and the polytope $\phi^{-1}(C'_z)$ defined by a list of inequalities, there exists an oracle finding an ε -solution, for every $\varepsilon > 0$, of:

$$\min_{y \in \phi^{-1}(C'_z)} f(z, y)$$

in $U(n, k, p, L, \varepsilon)$ time, where L is the input size and T is a polynomial in $k, p, L, |\log(\varepsilon)|$ when n is fixed.

Theorem 5.19. *If the optimistic Problem 4.2 satisfies Assumptions B and F, then for every $\varepsilon \geq 0$, an ε -solution of the optimistic Problem 4.2 can be obtained in $O(R^n U(n, k, p, L_{high}, \varepsilon))$ time, where L_{high} is the input size of the high-level problem.*

Proof. According to Corollary 4.33, the optimistic version of Problem 4.2 is equivalent to:

$$\min_{z \in C^T \mathcal{P} \cap \mathbb{Z}^n, y \in \phi^{-1}(C'_z)} f(z, y).$$

By Proposition 5.4, all the points z of $C^T \mathcal{P} \cap \mathbb{Z}^n$ together with $\varphi(z)$ can be obtained in $O((2R)^n \text{LP}(p + 2n, k, L_{low}))$ time. A point y belongs to $\phi^{-1}(C'_z)$ if and only if z belongs to $\phi(C_y)$ by Lemma 3.12. This condition is equivalent to $Q(y) = \langle y, z \rangle + \varphi(z)$. Then, y belongs to $\phi^{-1}(C'_z)$ if and only if y belongs to the polyhedron defined by the following inequalities:

$$\forall z' \in C^T \mathcal{P} \cap \mathbb{Z}^n, \langle y, z \rangle + \varphi(z) \geq \langle y, z' \rangle + \varphi(z').$$

Then, we can define $\phi^{-1}(C'_z)$ by a list of inequalities. The number of inequalities is less or equal than R^n , then it is polynomial in R when n is fixed. By Assumption F, each problem:

$$\min_{y \in \phi^{-1}(C'_z)} f(z, y)$$

can be solved in $U(n, k, p, L_{high}, \varepsilon)$ time. □

The complexity bounds given by Theorem 5.18 and Theorem 5.19 depend polynomially on the dimension of the low-level problem (k being the number of variables, p being the number of constraints) and of a metric estimate R . In some particular cases, for instance if the entries of C are in $\{0; \pm 1\}$ and the discrete problem deals with binary variables (that is $\mathcal{P} \subset [0, 1]^n$), the value of R given by Proposition 5.4 is equal to k , meaning that our complexity bounds are polynomial in the low-level dimension when the high-level dimension is fixed.

5.4 Discussion of the results

We discuss some aspects of the results presented in this chapter. To better understand the complexity bounds obtained in Section 5.3, we consider an example. Assume that C is totally unimodular and that $\mathcal{P} \subset [0, 1]^n$. Then, by Proposition 5.2, we have $C^T \mathcal{P} = [-k, k]^n$. The complexity of Algorithm 2 is then:

$$O((2k)^n (\text{LP}(p + 2n, k, L_{low}) + 2n!k^n \text{LP}(k^n, n + 1, L_{low})) T(n, k, p, L_{high}, \varepsilon)),$$

by Theorem 5.18. By using interior point methods, we have $\text{LP}(m, n, L) = O((m + n)^{3.5} L)$ according to Renegar [Ren88]. To simplify, we assume that the number p of constraints of the

low-level problem is very small, that is $p \ll k$. Consider $n = 3$. Then, the time needed to enumerate all the cells of \mathcal{S} :

$$O(8k^3((k+6)^{3.5}L_{low} + 12k^3(k^3+4)^{3.5}L_{low})).$$

It is polynomial for fixed k . However, the complexity is in $O(k^{16.5})$. We mention nevertheless that this worst-case complexity is not attained in practice.

The complexity bounds have the following form. Let T_{epi} be the time needed to determine the facets of $\text{epi}(Q)$, T_F be the time needed to enumerate all the faces of $\text{epi}(Q)$ by the algorithm proposed by Fukuda et al. , and T_{sp} be the time needed to solve each subproblem. Theorem 5.18 shows that, for $\varepsilon \geq 0$, an ε -solution of Problem (BP) is obtained in $O((T_{epi} + T_F)T_{sp})$ time.

We have $T_{epi} = O(n_{\mathbb{Z}} \text{LP}(p + 2n, k, L_{low}))$. By Corollary 5.3, we have $n_{\mathbb{Z}} \leq (2R + 1)^n$. However, by Proposition 5.10, we have $n_{\mathbb{Z}} \leq n + n! \text{Vol}(C^T \mathcal{P})$. Then, we have another upper bound for the number of integer points, which can be better than $(2R + 1)^n$ in certain cases. However, we mention also that $C^T \mathcal{P}$ is a compact set, with strictly positive volume. This means that we can also find $r > 0$ such that $[-r, r]^n \subset C^T \mathcal{P}$, if $0 \in C^T \mathcal{P}$. Consequently, we have the lower bound $n_{\mathbb{Z}} \geq (2r)^n$. Intuitively, if the high-level dimension n is large, the number $n_{\mathbb{Z}}$ is exponential in n and the time T_{epi} can be very large.

Then, we have $T_F = O(n_{\mathbb{Z}} f \text{LP}(n_{\mathbb{Z}}, n + 1, L_{low}))$, where f is the number of faces of $\text{epi}(Q)$. We already mentioned that there exists other types of algorithms to enumerate the faces of $\text{epi}(Q)$. Such an algorithm needs to compactify first $\text{epi}(Q)$ by adding one or more facets. We obtain consequently a polytope $\mathcal{P}(Q)$. Then, we enumerate the vertices of $\mathcal{P}(Q)$ (by using for instance the Avis and Fukuda algorithm [AF92]) in order to build the vertex-facet incidence matrix of $\mathcal{P}(Q)$. In a third time, we enumerate all the faces of $\mathcal{P}(Q)$ (by using for instance the Kaibel and Pfetsch algorithm [KP02]) and finally we obtain the faces of $\text{epi}(Q)$. This other kind of algorithm, presented in Appendix A, can be more efficient when $\mathcal{P}(Q)$ is simple, or when $C^T \mathcal{P}$ is simple. Herrmann, Joswig and Pfetsch mention in [HJP13, Section 3.3] that for bounded polyhedra, an algorithm using the vertex-facet incidence matrix is better in practice. The complexities of both methods are different and do not depend on the same parameters (the number of vertices of $\mathcal{P}(Q)$ appears in the complexity of Kaibel and Pfetsch algorithm). Hence, to decide whether an algorithm is more efficient than the other one depends on the nature of $\mathcal{P}(Q)$ (large or small number of facets, of vertices ...).

Moreover, the time complexity T_F depends on the number f of faces of $\text{epi}(Q)$ and of the number $n_{\mathbb{Z}}$ of integer points of $C^T \mathcal{P}$. We give in Section 5.2 a general upper bound for $n_{\mathbb{Z}}$, f :

$$n_{\mathbb{Z}} \leq n + n! \text{Vol}(C^T \mathcal{P}), \quad f \leq (2^{n+1} - 1)n! \text{Vol}(C^T \mathcal{P})$$

Consider the example of Section 4.2.5. We have $n = 2$ and $C^T \mathcal{P} = [0, 1] \times [0, 2]$, that is $n! \text{Vol}(C^T \mathcal{P}) = 8$. We can write the values of the combinatorial parameters and the upper bound.

	Exact value	Upper bound
$n_{\mathbb{Z}}$	6	10
f	15	56

We see that even in very small dimensions, with very small polytopes, the upper bound can be far from the exact value. We compare also with the case $C^T \mathcal{P} = \Delta_d$ presented in Section 5.2.

We have the following upper bounds when $n \leq 4$:

$$n_{\mathbb{Z}} \leq \binom{n+d}{n}$$

$$f \leq \sum_{j=0}^n \sum_{i=0}^j (-1)^i \binom{j}{i} \binom{n+(j+1-i)d}{n}$$

In this case, $n! \text{Vol}(C^T \mathcal{P}) = d^n$. As an example, we compare the upper bounds on $n_{\mathbb{Z}}$ and f given in this case for $n = 3$ and $d = 10$ with the general upper bounds.

	Upper bound for the case $C^T \mathcal{P} = \Delta_d$	General upper bound
$n_{\mathbb{Z}}$	286	1003
f	4971	15000

We observe that we gain a factor 3 over the upper bounds. It means that in practice, the upper bounds given by the different results of Section 5.2 are often far from the real values, that is Algorithm 2 converges in practice much faster than the announced complexity.

Finally, we focus on T_{sp} . The number of time needed to find an ε -solution of a certain optimization problem depends on the structure of the problem. Consider Problem 4.1 with a linear function f . Then, each subproblem consists in minimizing a linear function over $\mathcal{C} \times \phi(\mathcal{C})$, where \mathcal{C} is an n -dimensional polyhedron defined by a list of inequalities, and $\phi(\mathcal{C})$ is an n -dimensional polyhedron defined as the convex hull of its vertices. Hence, if $\phi(\mathcal{C})$ has v vertices, we need v variables to describe the polyhedron. Using methods like interior point methods (see [Kar84], [Ren88]), it is possible to solve each subproblem in polynomial time in $n + v$.

CHAPTER 6

Structured classes of bilevel problems

In Chapter 4, we introduced a specific class of bilevel programming problems, modelling an economic problem. The value of the low-level component of these bilevel problems can be described by a polynomial in the tropical algebra. We introduced a specific method for solving this class of bilevel problems, based on the enumeration of the cells of the polyhedral complex defined by the tropical hypersurface associated to the low-level problem. In Chapter 5, we proposed an algorithm for enumerating the different cells, and so for solving the problem. We gave also some complexity results, showing that the bilevel programming problem under study can be solved in polynomial time in the dimension of the low level problem and in certain metric estimates, when the high-level dimension is fixed.

Here, we will focus on some specific classes of bilevel problems. First, we study Problems 4.4 and 4.5 introduced in Chapter 4, which model a situation with a large number of customers, and which correspond to a specific version of Problem 4.1 and 4.2. We show in this case that the low-level problem corresponds to the product of tropical polynomials, each polynomial being associated to one customer. Hence, we shall see that the tropical hypersurface representing the customer's response is in fact an arrangement of elementary tropical hypersurfaces describing individual responses. It is hence possible to improve some bounds given in Section 5.2 for this special class of problems.

Next, we study another bilevel problem corresponding to a balancing problem in pricing. The aim of the producer is only to avoid the peaks of consumptions, and the high-level function

to optimize does not depend on the price. Under this assumption, the enumeration method presented in Chapter 4 leads to a decomposition method in which only two optimization problems have to be solved. It leads to polynomial time algorithms, based on results of discrete convexity.

Finally, we study a balancing problem with a large number of customers. The bilevel problem belongs to the classes studied in this chapter. We establish a comparison with a competitive equilibrium problem for indivisible goods defined by Danilov et al. [DKM01]. We prove that the congestion problem can also be viewed as a limit of competitive equilibria. Because the congestion problem is easier to solve than the competitive equilibrium problem, this result enables to compute certain competitive equilibria.

6.1 Arrangement of tropical hypersurfaces

6.1.1 Bilevel problem with separable low-levels

In this section, we study the following economic situation, described in Section 4.1. A producer sells n goods to a set of q customers. He proposes a price $-y_i$ for good i . Each customer j (for $j \in [q]$) has a consumption vector $x^j \in \mathbb{R}^n$, where $x^j(i)$ denotes the quantity of good i that customer j buys. The consumption x^j is constrained to belong to a polytope \mathcal{P}^j , or to the integer points of \mathcal{P}^j if the goods are indivisible. Customer j has also a preference vector $\rho^j \in \mathbb{R}^n$ for buying the different goods. Hence, each customer j maximizes his utility $\langle \rho^j + y, x^j \rangle$ with the constraint $x^j \in \mathcal{P}^j$ (or $x^j \in \mathcal{P}^j \cap \mathbb{Z}^n$). Denoting by x^{j*} the optimal consumption of customer j , the producer wants to minimize his costs, modeled by a function f depending on his decision vector y and on the global solds $z = \sum_{j=1}^q x^{j*}$. This leads to Problems 4.4 and 4.5, that we recall below

Problem 6.1.

$$\text{“min”}_{y \in \mathbb{R}^n} f\left(\sum_{j=1}^q x^{j*}, y\right) \quad (6.1)$$

with for all $j \in [q]$, x^{j*} solution of:

$$\max_{x^j \in \mathcal{P}^j} \langle \rho^j + y, x^j \rangle \quad (6.2)$$

and:

Problem 6.2.

$$\text{“min”}_{y \in \mathbb{R}^n} f\left(\sum_{j=1}^q x^{j*}, y\right) \quad (6.3)$$

with for all $j \in [q]$, x^{j*} solution of:

$$\max_{x^j \in \mathcal{P}^j \cap \mathbb{Z}^n} \langle \rho^j + y, x^j \rangle \quad (6.4)$$

As mentioned in Section 4.1, Problems 6.1 and 6.2 are just a particular case of Problems 4.1 and 4.2 respectively. In fact, assume that $k = qn$, $\mathcal{P} = \mathcal{P}^1 \times \dots \times \mathcal{P}^q$ with for each $j \in [q]$, \mathcal{P}^j is a polytope of \mathbb{R}^n , and:

$$C = \begin{pmatrix} I_n \\ \dots \\ I_n \end{pmatrix} \quad \text{and} \quad \rho = \begin{pmatrix} \rho^1 \\ \dots \\ \rho^q \end{pmatrix}.$$

Then, by decomposing $x^T = [x_1^T \dots x_q^T]$, with for each $j \in [q]$, $x_j \in \mathcal{P}^j$, the low-level problem of Problem 4.1 becomes:

$$\max_{x \in \mathcal{P}} \langle \rho + Cy, x \rangle = \max_{\forall j, x_j \in \mathcal{P}^j} \sum_{j=1}^q \langle \rho_j + y, x_j \rangle = \sum_{j=1}^q \max_{x_j \in \mathcal{P}^j} \langle \rho_j + y, x_j \rangle$$

It corresponds exactly to the low-level of Problem 6.1. The result remains for the integral problems.

As in Section 4.1, we study the version in which the low-level variable belongs to the extreme points of a polytope, that is:

Problem 6.3.

$$\text{“min”}_{y \in \mathbb{R}^n} f\left(\sum_{j=1}^q x_j^*, y\right) \quad (6.5)$$

with for all $j \in [q]$, x_j^* solution of:

$$\max_{x^j \in \mathcal{E}(\mathcal{P}^j)} \langle \rho^j + y, x^j \rangle \quad (6.6)$$

Consequently, we have $C^T \mathcal{P} = \sum_{j=1}^q \mathcal{P}^j$, $C^T \mathcal{P} \cap \mathbb{Z}^n = \left(\sum_{j=1}^q \mathcal{P}^j\right) \cap \mathbb{Z}^n$ and $C^T \mathcal{E}(\mathcal{P}) = \sum_{j=1}^q \mathcal{E}(\mathcal{P}^j)$.

According to Lemma 4.13, Problem 6.1 is equivalent to:

$$\text{“min”}_{y \in \mathbb{R}^n} f(z^*, y)$$

subject to $z^* = \sum_{j=1}^q x_j^*$ and $\forall j \in [q]$, x_j^* solution of $\max_{x_j \in \mathcal{P}^j} \langle \rho_j + y, x_j \rangle$. The same result is obtained respectively for Problem 6.2 under Assumption B and for Problem 6.3, by replacing \mathcal{P}^j in the low-level problem respectively by $\mathcal{P}^j \cap \mathbb{Z}^n$ and $\mathcal{E}(\mathcal{P}^j)$.

The tropical hypersurface defined by the low-level problem corresponds to the arrangement of the tropical hypersurfaces associated to the tropical polynomial Q_j where $Q_j(y) = \max_{x_j \in \mathcal{E}(\mathcal{P}^j)} \langle \rho_j + y, x_j \rangle$. This corresponds to the situation described by Baldwin and Klemperer [BK12] and further by Yu and Tran [TY15]. We assume here for comparison that the set of possible consumptions of each customer is $\mathcal{E}(\mathcal{P}_j)$. For each vector y , the optimal response of customer j corresponds to a cell of the polyhedral complex \mathcal{S}_j defined by the tropical hypersurface $\mathcal{T}(Q_j)$. Each full-dimensional cell corresponds to one possible response in $\mathcal{E}(\mathcal{P}^j)$. To study jointly the responses of q different customers, we draw the arrangement of hypersurfaces $\mathcal{T}(Q_j)$ for $j \in [q]$.

Example 6.4. We consider an example in which $n = 2$ and $q = 2$. We assume that customer 1 is characterized by $\rho_1^T = [0 \ 0]$ and $\mathcal{E}(\mathcal{P}^1) = \{(1, 0); (0, 1); (0, 0)\}$, whereas customer 2 is characterized by $\rho_2^T = [1 \ 1]$ and $\mathcal{E}(\mathcal{P}^2) = \{(1, 1); (1, 0); (0, 1); (0, 0)\}$. Then, the tropical polynomials associated to each customers are:

$$\begin{aligned} Q_1(y) &= \max(y_1, y_2, 0), \\ Q_2(y) &= \max(y_1 + y_2 + 2, y_1 + 1, y_2 + 1, 0). \end{aligned}$$

We can then draw the arrangement of tropical hypersurfaces associated to both polynomials Q_1 and Q_2 , together with the optimal response of each customer in the full-dimensional cells of the polyhedral complex (see Figure 6.1).

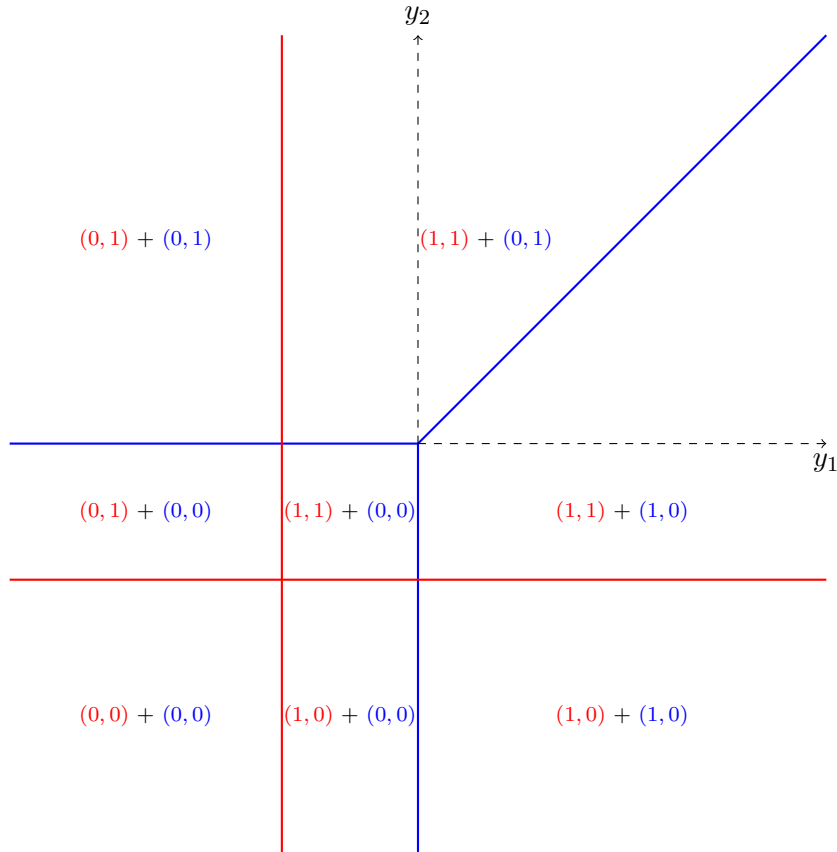

Figure 6.1: Arrangement of tropical hypersurfaces: the blue one is $\mathcal{T}(Q_1)$ and the red one is $\mathcal{T}(Q_2)$. The arrangement corresponds to the tropical hypersurface associated to $Q = Q_1 \odot Q_2$. In each cell, we can determine the global low-level response with its decomposition into each customer.

The arrangement of tropical hypersurfaces $\mathcal{T}(Q_1)$ and $\mathcal{T}(Q_2)$ corresponds to the hypersurface associated to $Q = Q_1 \odot Q_2$. We have:

$$\begin{aligned} Q(y) &= \max(y_1, y_2, 0) + \max(y_1 + y_2 + 2, y_1 + 1, y_2 + 1, 0) \\ &= \max(2y_1 + y_2 + 2, y_1 + 2y_2 + 2, 2y_1 + 1, 2y_2 + 1, y_1 + y_2 + 2, y_1 + 1, y_2 + 1, 0). \end{aligned}$$

Yu and Tran [TY15] exploit the duality between the polyhedral complex \mathcal{S} associated to $\mathcal{T}(Q)$ and a subdivision \mathcal{S}' of the Newton polytope $\text{New}(Q)$. As explained in Section 3.3, the subdivision \mathcal{S}' is a mixed subdivision of $\text{New}(Q)$. We recall that $\text{New}(Q) = \text{New}(Q_1) + \text{New}(Q_2)$. The subdivision \mathcal{S}' is obtained as a Minkowski sum of two subdivisions \mathcal{S}'_1 and \mathcal{S}'_2 of respectively $\text{New}(Q_1)$ and $\text{New}(Q_2)$, where \mathcal{S}'_1 and \mathcal{S}'_2 are the dual subdivisions of the polyhedral complexes \mathcal{S}_1 and \mathcal{S}_2 associated to Q_1 and Q_2 .

Yu and Tran study the existence of a competitive equilibrium, which is a different problem from ours. However, the question can be formulated as follows with our notations. For $z^* \in \sum_j (\mathcal{E}(\mathcal{P}^j))$, is it possible to find y such that $z^* = \sum_j x^{j*}$ and for every j , $x^{j*} \in \arg \max_{x^j \in \mathcal{E}(\mathcal{P}^j)} \langle \rho^j + y, x^j \rangle$? Lemma 3.1. of [TY15] proves that such a y exists if and only if $\{z^*\}$ is a zero-dimensional cell of \mathcal{S}' .

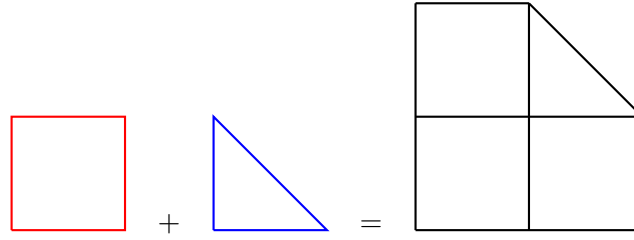

Figure 6.2: The subdivisions of the Newton polytope associated to Q_1 (blue one), Q_2 (red one) and Q (black one). The polytope $\text{New}(Q)$ is equal to $\text{New}(Q_1) + \text{New}(Q_2)$

6.1.2 Number of apices of a tropical hypersurface

We next show that the structure of arrangements of tropical hypersurfaces helps us to improve the bounds over the combinatorial parameters of \mathcal{S} obtained in Section 5.2. This leads to a better complexity of Algorithms 8 and 7. Let \mathcal{S} be the polyhedral complex associated to the tropical polynomial $Q = \odot_j Q_j = \sum_j Q_j$. Let $f(\mathcal{S})$ be the f -vector of \mathcal{S} . The number $f_0(\mathcal{S})$ corresponds to the number of 0-dimensional cells in \mathcal{S} , that is the number of apices of the arrangement of tropical hypersurfaces $\mathcal{T}(Q_j)$ for $j \in [q]$.

We first show the following result about the number of apices of the arrangement of k tropical hypersurfaces in dimension n .

Let P be a tropical polynomial of n variables. According to Proposition 3.5, a tropical hypersurface $\mathcal{T}(P)$ in \mathbb{R}^n , associated to a tropical polynomial P , defines a subdivision \mathcal{S} of \mathbb{R}^n . Suppose that:

$$P(x) = \max_{1 \leq i \leq p} c_i + \langle x, a_i \rangle.$$

Let \mathcal{C} be a cell of \mathcal{S} . There exists a non-empty subset of $[p]$, denoted by $\mathcal{A}(\mathcal{C})$ such that \mathcal{C} is the set of vectors $x \in \mathbb{R}^n$ satisfying the following inequalities:

$$\begin{aligned} \forall i, j \in \mathcal{A}(\mathcal{C}), c_i + \langle x, a_i \rangle &= c_j + \langle x, a_j \rangle \\ \forall i \in \mathcal{A}(\mathcal{C}), \forall j \notin \mathcal{A}(\mathcal{C}), c_i + \langle x, a_i \rangle &\geq c_j + \langle x, a_j \rangle, \end{aligned}$$

where the inequalities are strict for the points $x \in \text{ri}(\mathcal{C})$. Then, the points of \mathcal{C} are characterized by r equalities, meaning that $r + 1$ monomials are maximal in every point of \mathcal{S} , with $r + 1 = \#\mathcal{A}(\mathcal{C})$.

Consider now the arrangement of k tropical polynomials P_1, \dots, P_k . An apex of this arrangement is a 0-dimensional polyhedron. Hence, it is defined by at least n linearly independent equalities. This apex is an intersection of cells of each tropical hypersurface associated to each polynomial P_i . Let x be such an apex. Then:

$$\{x\} = \bigcap_{i=1}^k \mathcal{C}^i,$$

where each \mathcal{C}^i is a cell of the subdivision \mathcal{S}^i associated to the tropical hypersurface $\mathcal{T}(P_i)$. Each \mathcal{C}^i is defined by r_i equalities, where $r_i + 1 = \mathcal{A}(\mathcal{C}^i)$. This means that $\sum_{i=1}^k r_i \geq n$.

Consequently, for every apex x of $\mathcal{T}(P)$, there exists a partition (q_1, \dots, q_k) of n (that is $(q_1, \dots, q_k) \in \mathbb{N}^k$ with $\sum_{i=1}^k q_i = n$), such that for every P_i , $q_i + 1$ monomials are maximal for

P_i in x . Notice that in every $x \in \mathbb{R}^n$, at least one monomial is maximal for P in x . We have $q_i \leq p_i$ for every i , and the partition is unique if and only if $\sum_{i=1}^k r_i = n$.

Theorem 6.5. *Let P_1, \dots, P_k be k tropical polynomials in \mathbb{R}^n , with tropical hypersurfaces denoted by $\mathcal{T}(P_1), \dots, \mathcal{T}(P_k)$ and with Newton polytopes respectively denoted by $\Delta_1, \dots, \Delta_k$. Assume that the k tropical hypersurfaces are in general position. Consider k non-negative integers q_1, \dots, q_k such that $\sum_{i=1}^k q_i = n$. The number of apices x of the tropical hypersurface $\mathcal{T}(P_1 \odot \dots \odot P_k)$ such that, for every $i \in [k]$, at least $q_i + 1$ monomials are maximal for P_i in x is less or equal than:*

$$n! \mathbb{V}(\Delta_1, \dots, \Delta_k; q_1, \dots, q_k),$$

where $\mathbb{V}(\Delta_1, \dots, \Delta_k; q_1, \dots, q_k)$ is the mixed volume $\mathbb{V}(\Delta_1, \dots, \Delta_1, \dots, \Delta_k, \dots, \Delta_k)$ in which each Δ_i appears q_i times.

Proof. See Appendix B. □

We can now deduce the number of apices of an arrangement of tropical hypersurfaces:

Corollary 6.6. *Let P_1, \dots, P_k be k tropical polynomials in \mathbb{R}^n , with tropical hypersurfaces denoted by $\mathcal{T}(P_1), \dots, \mathcal{T}(P_k)$ and with Newton polytopes respectively denoted by $\Delta_1, \dots, \Delta_k$. Assume that the k tropical hypersurfaces are in general position. The number of intersection points of the arrangement of the tropical hypersurfaces $\mathcal{T}(P_i)$ for each $1 \leq i \leq k$ is less or equal than:*

$$n! \sum_{\substack{(q_1, \dots, q_k) \in \mathbb{N}^k \\ \sum_{i=1}^k q_i = n}} \mathbb{V}(\Delta_1, \dots, \Delta_k; q_1, \dots, q_k).$$

Proof. For each apex x of the arrangement of the tropical hypersurfaces $\mathcal{T}(P_i)$, there exists a partition (q_1, \dots, q_k) of n such that for every $i \in [k]$, at least $q_i + 1$ monomials are maximal for P_i in x . The result follows readily from Theorem 6.5. □

We mention that a similar result was established by Bihan and Bertrand [BB07, Th. 4.5] in the case of the tropical hypersurface $\mathcal{T}(P_i)$ intersects transversally in each apex of $\mathcal{T}(P_1 \odot \dots \odot P_k)$.

6.1.3 Upper bounds on the number of cells

We can deduce from the previous general results an upper bound of the number $f_0(\mathcal{S})$ of 0-dimensional cells in \mathcal{S} .

Theorem 6.7. *The number $f_0(\mathcal{S})$ of 0-dimension cells in \mathcal{S} verifies:*

$$f_0(\mathcal{S}) \leq n! \sum_{\substack{(j_1, \dots, j_q) \in \mathbb{N}^q \\ \sum_{i=1}^q j_i = n}} \mathbb{V}(\mathcal{P}^1, \dots, \mathcal{P}^q; j_1, \dots, j_q)$$

Proof. The number $f_0(\mathcal{S})$ of 0-dimension cells in \mathcal{S} is the number of apices of the arrangement of tropical hypersurfaces associated to each tropical polynomial Q_j . The result comes from Corollary 6.6. □

This bound is better than the bound given by Proposition 5.8 in this case. Consider for example $\mathcal{P}^1 = \dots = \mathcal{P}^q$. The upper bound given by Proposition 5.8 is $n! \text{Vol}(\sum_{j=1}^q \mathcal{P}^j) = n!q^n \text{Vol}(\mathcal{P}^1)$.

For all $(j_1, \dots, j_q) \in \mathbb{N}^q$ such that $\sum_{i=1}^q j_i = n$, we have $V(\mathcal{P}^1, \dots, \mathcal{P}^q; j_1, \dots, j_q) = \text{Vol}(\mathcal{P}^1)$. Then, the upper bound given by Theorem 6.7 is:

$$n! \text{Vol}(\mathcal{P}^1) \times \# \left(\{(j_1, \dots, j_q) \in \mathbb{N}^q \mid \sum_{i=1}^q j_i = n\} \right) = n! \binom{n+q-1}{n} \text{Vol}(\mathcal{P}^1)$$

according to Lemma 5.13. When the dimension n is fixed, we have asymptotically $\binom{n+q-1}{n} \sim \frac{q^n}{n!}$.

Theorem 6.7 provides a better upper bound of the number of 0-dimensional cells in \mathcal{S} . It is hence possible to improve the worst case complexity of Algorithm 8 and Algorithm 7 in the case of arrangements of tropical hypersurfaces.

Case of arrangement of hyperplanes We finally study a particular case in which each tropical hypersurface $\mathcal{T}(Q_j)$ is a tropical hyperplane. It means that Q_j is a tropical polynomial of degree 1 and $\text{New}(Q_j) = \Delta_1$ for all j .

Develin and Sturmfels [DS04] gave the following result concerning the f -vector of a polyhedral complex associated to an arrangement of tropical hyperplanes in general position.

Theorem 6.8 ([DS04], Corollary 25). *The number $f_d(\mathcal{S})$ of d -dimensional faces of the polyhedral complex \mathcal{S} associated to an arrangement of q tropical hyperplanes in dimension n and in general position is:*

$$f_d(\mathcal{S}) = \frac{(q+n-d-1)!}{(q-d-1)!(n-d)!d!}$$

As a particular case, we find $f_0(\mathcal{S}) = \binom{q+n-1}{n}$. Notice that if for every $j \in [n]$, $\text{New}(Q_j) = \Delta_1$, then Theorem 6.7 gives $f_0(\mathcal{S}) \leq n! \binom{q+n-1}{n} \frac{1}{n!} = \binom{q+n-1}{n}$. Theorem 6.8 shows that the upper bound given by Theorem 6.7 is attained.

6.2 A particular case: f does not depend on y

In this Section, we study the economic situation described by Problems 4.1, 4.2 (we still suppose Assumption B) and 4.3 when the producer is concerned by balancing its production between its different goods. It means that the high-level function, corresponding to the optimization of the producer, does not depend on the "leader" variable decision y .

This specific form simplifies the way to solve the optimistic solution of the different studied problems. Consider for instance Problem 4.1. According to Corollary 4.15, the optimistic solution of Problem 4.1 is given by:

$$\inf_{y \in \mathbb{R}^n} \inf_{z^* \in \phi(\mathcal{C}_y)} f(z^*),$$

that is $\inf_{z^* \in \bigcup_{y \in \mathbb{R}^n} \phi(\mathcal{C}_y)} f(z^*)$. We notice that this optimization problem does not depend on y . This means that solving the high-level problem consists in minimizing a function over the set of feasible z (which has to be determined) and then in finding the vectors $y \in \mathbb{R}^n$ such that z is an optimal solution of the low-level problem. This approach can be adapted for solving Problem 4.2 and 4.3 First, we have the following lemma:

Lemma 6.9. • If $z^* \in C^T\mathcal{P}$, then there exists $y \in \mathbb{R}^n$ such that $z^* \in \arg \max_{z \in C^T\mathcal{P}} \langle y, z \rangle + \varphi(z)$. Moreover $\bigcup_{y \in \mathbb{R}^n} \phi(\mathcal{C}_y) = C^T\mathcal{P}$.

• If $z^* \in C^T\mathcal{P} \cap \mathbb{Z}^n$, then there exists $y \in \mathbb{R}^n$ such that $z^* \in \arg \max_{z \in C^T\mathcal{P} \cap \mathbb{Z}^n} \langle y, z \rangle + \varphi(z)$. Moreover $\bigcup_{y \in \mathbb{R}^n} (\phi(\mathcal{C}_y) \cap \mathbb{Z}^n) = C^T\mathcal{P} \cap \mathbb{Z}^n$.

• If $z^* \in C^T\mathcal{E}(\mathcal{P})$, then there exists $y \in \mathbb{R}^n$ such that $z^* \in \arg \max_{z \in C^T\mathcal{E}(\mathcal{P})} \langle y, z \rangle + \varphi(z)$. Moreover $\bigcup_{y \in \mathbb{R}^n} (\phi(\mathcal{C}_y) \cap C^T\mathcal{E}(\mathcal{P})) = C^T\mathcal{E}(\mathcal{P})$.

Proof. The first item comes directly from Proposition 4.12. The two other items are a direct consequence of the first one. If $z^* \in C^T\mathcal{P} \cap \mathbb{Z}^n$, then it belongs to $C^T\mathcal{P}$ and there exists $y \in \mathbb{R}^n$ such that for each $z \in C^T\mathcal{P}$, $\langle y, z^* \rangle + \varphi(z^*) \geq \langle y, z \rangle + \varphi(z)$. In particular, $z^* \in \arg \max_{z \in C^T\mathcal{P} \cap \mathbb{Z}^n} \langle y, z \rangle + \varphi(z)$. The same reasoning is applied for the third item. \square

The different theorems of enumeration of cells for solving the different bilevel problems (Theorems 4.17, 4.34 and 4.41 respectively for Problems 4.1, 4.2 and 4.3) can be rewritten in this particular case. We have the following decomposition theorems:

Theorem 6.10 (Decomposition theorem for the continuous bilevel problem). *Assume that f is lower semicontinuous. Then, the optimistic version of Problem 4.1 is equivalent to:*

- Find $z^* \in \arg \min_{z \in C^T\mathcal{P}} f(z)$.
- Find $y^* \in \phi^{-1}(\mathcal{C}'_{z^*})$.

Proof. According to Corollary 4.15, the optimistic solution of Problem 4.1 is equal to:

$$\inf_{y \in \mathbb{R}^n} \inf_{z \in \phi(\mathcal{C}_y)} f(z) = \min_{z \in \bigcup \{\phi(\mathcal{C}_y) \mid y \in \mathbb{R}^n\}} f(z) = \min_{z \in C^T\mathcal{P}} f(z).$$

Also, from Corollary 4.16, it is equivalent to

$$\inf_{z \in C^T\mathcal{P}} \inf_{y \in \phi^{-1}(\mathcal{C}'_z)} f(z).$$

Hence, an optimal solution verifies $z^* \in \arg \min_{z \in C^T\mathcal{P}} f(z)$ and $y^* \in \phi^{-1}(\mathcal{C}'_{z^*})$. \square

Theorem 6.11 (Decomposition theorem for the discrete bilevel problem). *If Assumption B holds true, the optimistic version of Problem 4.2 is equivalent to:*

- Find $z^* \in \arg \min_{z \in C^T\mathcal{P} \cap \mathbb{Z}^n} f(z)$.
- Find $y^* \in \phi^{-1}(\mathcal{C}'_{z^*})$.

Proof. It is a direct consequence of Corollary 4.33. \square

Theorem 6.12 (Decomposition theorem for the extreme points bilevel problem). *The optimistic version of Problem 4.3 is equivalent to:*

- Find $z^* \in \arg \min_{z \in C^T\mathcal{E}(\mathcal{P})} f(z)$.
- Find $y^* \in \phi^{-1}(\mathcal{C}'_{z^*})$.

Proof. It is a direct consequence of Corollary 4.40. \square

According to Theorems 6.10, 6.11 and 6.12, we need to solve two different optimization problems in order to obtain an optimal solution of the bilevel problem.

The second one is the same for the three studied bilevel problems: given $z^* \in C^T \mathcal{P}$, how to find $y^* \in \phi^{-1}(C'_{z^*})$? We next show that this can be solved in polynomial time.

When dealing with such complexity issues, we work in the Turing (bit) model of computation. Recall that the input matrices or vectors C, A, b have been assumed to have integer entries. We assume in addition that $\rho \in \mathbb{Q}^k$.

Proposition 6.13. *Let $z^* \in C^T \mathcal{P}$. Then, it is possible to find $y^* \in \phi^{-1}(C'_{z^*})$ in polynomial time.*

Proof. The condition $y^* \in \phi^{-1}(C'_{z^*})$ is equivalent to

$$\langle y, z^* \rangle + \varphi(z^*) \geq \langle y, z \rangle + \varphi(z), \quad \forall z \in C^T \mathcal{P} . \quad (6.7)$$

In other words, we are looking for a vector y belonging to the subdifferential at point z^* of the convex map $z \mapsto -\varphi(z)$ taking finite values on $C^T \mathcal{P}$, and the $+\infty$ value elsewhere. We next show that such a vector y can be obtained as an optimal Lagrange multiplier, i.e., as an optimal solution of a dual linear program.

More precisely, the dual of the linear program

$$\varphi(z) = \max_{Ax \leq b, C^T x = z} \langle \rho, x \rangle \quad (6.8)$$

is given by

$$\inf_{y \in \mathbb{R}^n, \mu \in \mathbb{R}_+^m} \langle \mu, b \rangle - \langle y, z \rangle \quad \text{s.t.} \quad \rho - A^T \mu + Cy = 0 , \quad (6.9)$$

where m is the number of rows of the matrix A , $\mu \geq 0$ is the Lagrange multiplier associated to the constraint $Ax \leq b$, and y is the unsigned Lagrange multiplier associated to the constraint $C^T x = z$. The strong duality theorem in linear programming shows in particular that as soon as the value of the primal problem (6.8) is finite, this value $\varphi(z)$ coincides with the value of the dual problem (6.9), and the dual problem has an optimal solution μ^*, y^* . Then, for all z and z^* such that $\varphi(z)$ and $\varphi(z^*)$ are finite, taking for μ^* and y^* the values of y, μ achieving the infimum in (6.9) when z is specialized to z^* ,

$$\begin{aligned} \varphi(z^*) - \varphi(z) &= \inf_{y \in \mathbb{R}^n, \mu \in \mathbb{R}_+^m} (\langle \mu, b \rangle - \langle y, z^* \rangle) - \inf_{y \in \mathbb{R}^n, \mu \in \mathbb{R}_+^m} (\langle \mu, b \rangle - \langle y, z^* \rangle) \\ &= \langle \mu^*, b \rangle - \langle y^*, z^* \rangle - \inf_{y \in \mathbb{R}^n, \mu \in \mathbb{R}_+^m} (\langle \mu, b \rangle - \langle y, z^* \rangle) \\ &\geq \langle \mu^*, b \rangle - \langle y^*, z^* \rangle - \langle \mu^*, b \rangle + \langle y^*, z \rangle \\ &= \langle y^*, z - z^* \rangle , \end{aligned}$$

showing that y^* satisfies (6.7). Therefore, to determine y^* , it suffices to solve the dual linear program (6.9), which can be done in polynomial time, either by the ellipsoid [GLS81] or by interior point methods [Ren88]. □

We consider a convex function f accessible through an approximate polynomial-time evaluation oracle, i.e. a procedure returning a rational vector approximating $f(x)$ up to an error ε ,

given a rational input vector x , in a time polynomial in the bitsize of x and in $-\log \varepsilon$. We call ε -solution of the optimistic version of the bilevel problem 4.1 a vector y_ε such that there is an optimal response x^* of the follower such that $f(C^\top x^*)$ does not exceed the optimal value of this bilevel problem by more than ε .

Theorem 6.14. *Suppose f is convex. Then, for each $\varepsilon > 0$, an ε -solution of the optimistic continuous bilevel problem 4.1 can be obtained in polynomial time. Moreover, if f is linear, an exact optimistic solution can be obtained in polynomial time.*

Proof. It is a consequence of Theorem 6.10. If f is convex, then an ε -solution z_ε of the problem $\min_{z \in C^T \mathcal{P}} f(z)$ can be obtained in polynomial time, using the ellipsoid method [Kha79, GLS81]. If f is linear, the same method, or the interior points method, gives an exact solution in polynomial time. Then, finding $y^* \in \phi^{-1}(C'_{z_\varepsilon})$ can be done in polynomial time in n by Proposition 6.13. To be complete, we also have to find the optimal $x^* \in \mathcal{P}$ such that $\varphi(z_\varepsilon) = \langle \rho, x^* \rangle$. Because $\max_{z \in C^T \mathcal{P}} \langle y^*, z \rangle + \varphi(z) = \max_{x \in \mathcal{P}} \langle \rho + Cy^*, x \rangle$, each solution of the linear programming problem $\max_{x \in \mathcal{P}; C^T x = z_\varepsilon} \langle \rho, x \rangle$ is suitable. \square

For Problem 4.2 and Problem 4.3, Theorems 6.11 and Theorem 6.12 show that it is necessary to solve a discrete optimization problem.

Theorem 6.15. *Suppose f is a M^\natural -convex function and $C^T \mathcal{P}$ is a generalized polymatroid. Under Assumption B, the optimistic version of Problem 4.2 can be solved in polynomial time.*

Proof. According to Theorem 6.11, if Assumption B holds true, then an optimistic solution of Problem 4.2 can be obtained by finding $z^* \in \arg \max_{z \in C^T \mathcal{P} \cap \mathbb{Z}^n} f(z)$ and then $y^* \in \phi^{-1}(C'_{z^*})$. If $C^T \mathcal{P}$ is a generalized polymatroid, then the characteristic convex function $\chi_{C^T \mathcal{P} \cap \mathbb{Z}^n}$ is M^\natural -convex. Then, the first step consists in minimizing the sum of two M^\natural -convex functions, that can be done in polynomial time in n . Then, finding $y^* \in \phi^{-1}(C'_{z^*})$ can be done in polynomial time in n , according to Proposition 6.13. Finally, we need to find $x^* \in \mathcal{P} \cap \mathbb{Z}^k$ such that $\langle \rho + Cy^*, x^* \rangle = \max_{x \in \mathcal{P} \cap \mathbb{Z}^k} \langle \rho + Cy^*, x \rangle$. Using

$$\max_{x \in \mathcal{P} \cap \mathbb{Z}^k} \langle \rho + Cy^*, x \rangle = \max_{z \in C^T \mathcal{P} \cap \mathbb{Z}^n} \langle y^*, z \rangle + \varphi(z) = \langle y^*, z^* \rangle + \varphi(z^*),$$

it is sufficient to find $x^* \in \mathcal{P} \cap \mathbb{Z}^k$ such that $C^T x = z^*$ and $\varphi(z^*) = \langle \rho, x^* \rangle$. This is equivalent to $x^* \in \arg \max_{x \in \mathcal{P} \cap \mathbb{Z}^k; C^T x = z^*} \langle \rho, x \rangle$, and to:

$$x^* \in \arg \max_{x \in \mathcal{P}; C^T x = z^*} \langle \rho, x \rangle,$$

under Assumption B. Computing a solution of such a linear programming problem can also be done in polynomial time. \square

Theorem 6.16. *Suppose f is a M^\natural -convex function and $C^T \mathcal{E}(\mathcal{P})$ is a M^\natural -convex set. Then, the optimistic version of Problem 4.3 can be solved in polynomial time.*

Proof. According to Theorem 6.12, then an optimistic solution of Problem 4.3 can be obtained by finding $z^* \in \arg \max_{z \in C^T \mathcal{E}(\mathcal{P})} f(z)$ and then $y^* \in \phi^{-1}(C'_{z^*})$. If $C^T \mathcal{E}(\mathcal{P})$ is a generalized polymatroid, then the first step consists in minimizing a M^\natural -convex function over a M^\natural -convex set, that can be done in polynomial time in n . Then, finding $y^* \in \phi^{-1}(C'_{z^*})$ can be done in

polynomial time in n , according to Proposition 6.13. Finally, we need to find $x^* \in \mathcal{E}(\mathcal{P})$ such that $\langle \rho + Cy^*, x^* \rangle = \max_{x \in \mathcal{E}(\mathcal{P})} \langle \rho + Cy^*, x \rangle$. Using

$$\max_{x \in \mathcal{E}(\mathcal{P})} \langle \rho + Cy^*, x \rangle = \max_{z \in C^T \mathcal{E}(\mathcal{P})} \langle y^*, z \rangle + \varphi(z) = \langle y^*, z^* \rangle + \varphi(z^*),$$

it is sufficient to find $x^* \in \mathcal{E}(\mathcal{P})$ such that $C^T x = z^*$ and $\varphi(z^*) = \langle \rho, x^* \rangle$. This is equivalent to x^* solution of

$$\max_{x \in \mathcal{E}(\mathcal{P}); C^T x = z^*} \langle \rho, x \rangle = \max_{x \in \mathcal{P}; C^T x = z^*} \langle \rho, x \rangle.$$

Computing a solution of such a linear programming problem can also be done in polynomial time. \square

6.3 A balancing problem in economics

In this section, we consider another economic situation modelled by a bilevel programming problem. This problem is a particular case of the ones studied in Section 6.1 and 6.2.

6.3.1 A congestion problem

Let us consider the economic situation described in Section 6.1, that is a producer selling n goods at a price $-y_i \in \mathbb{R}$ to q different customers. We suppose now that the producer is only concerned by balancing his production between the different goods. Mathematically, it means that the high-level function depends only on the global consumption $\sum_j x_j^*$.

This situation can describe a congestion problem. Suppose that the producer is an operator managing a network with different roads. Each customer has a preference to use more or less the roads and determines his consumption in each road by maximizing his utility. The sum of consumptions of the customer determines the traffic. The operator is interested by minimizing the congestion in the network, that is by minimizing a measure of the global traffic. In order to do this, he proposes some discounts in the different roads to incite the customers to modify their optimal consumptions and so to reduce the congestion.

We assume here that the consumptions of the customers are discrete. It leads to a bilevel optimization problem, corresponding to Problem 6.2 where the high-level function does not depend on the discount vector y . We focus on the optimistic version:

Problem 6.17.

$$\min_{y \in \mathbb{R}^n} f(z^*) \tag{6.10}$$

with $z^* = \sum_{j=1}^q x^{j*}$ and for all $j \in [q]$, x^{j*} solution of:

$$\max_{x^j \in \mathcal{P}^j \cap \mathbb{Z}^n} \langle \rho^j + y, x^j \rangle. \tag{6.11}$$

Because the high-level function of Problem 6.17 does not depend on the vector y , the results of Section 6.2 can be applied. In particular, because we focus on the optimistic case, Problem 6.17 can be solved by the decomposition method:

Theorem 6.18. *Suppose that each polytope \mathcal{P}^j is of the form $\{x \in \mathbb{R}^n \mid A_j x \leq b_j\}$ where the matrix A_j is totally unimodular and the vector b_j has integer entries. Suppose moreover that $\sum_j (\mathcal{P}^j \cap \mathbb{Z}^n) = (\sum_j \mathcal{P}^j) \cap \mathbb{Z}^n$. Then, Problem 6.17 is equivalent to:*

- Find $z^* \in \arg \min_{z \in \sum_{j=1}^q (\mathcal{P}^j \cap \mathbb{Z}^n)} f(z)$
- Find $y^* \in \phi^{-1}(C'_{z^*})$

Proof. As mentioned in Section 6.1, Problem 6.17 corresponds to Problem 4.2 with $\mathcal{P} = \mathcal{P}^1 \times \dots \times \mathcal{P}^q$ and $C^T = [I_n \dots I_n]$. We assumed that $\mathcal{P}^j = \{x \in \mathbb{R}^n \mid A_j x \leq b_j\}$, with A_j is totally unimodular. Hence, $\mathcal{P} = \{x \in \mathbb{R}^n \mid Ax \leq b\}$ where A is block diagonal ($A = \text{Diag}(A_1, \dots, A_q)$). So, \mathcal{P} is an integer polytope. The entries of C are integer. Since we assume $\sum_j (\mathcal{P}^j \cap \mathbb{Z}^n) = (\sum_j \mathcal{P}^j) \cap \mathbb{Z}^n$, Assumption B holds true. We can then apply Theorem 6.11. \square

Theorem 6.18 can be understood by the Unimodularity theorem of Baldwin, Klemperer [BK12], Yu and Tran [TY15]. With our notations, the unimodularity theorems give necessary and sufficient conditions over the sets $\mathcal{P}^j \cap \mathbb{Z}^n$ to guarantee that for every $z^* \in \sum_j (\mathcal{P}^j \cap \mathbb{Z}^n)$, the set $\phi^{-1}(C'_{z^*}) \neq \emptyset$. These conditions are related with the unimodularity of the sets $\mathcal{P}^j \cap \mathbb{Z}^n$.

However, Theorem 6.18 shows that we have to minimize a convex function over a discrete set. We have nevertheless the following result:

Theorem 6.19. *Suppose that f is a M^{\natural} -convex function and that for each $j \in [q]$, the polytope \mathcal{P}^j is a g -polymatroid. Then, Assumption B holds true and Problem 6.17 can always be solved in polynomial time.*

Proof. Since each polytope \mathcal{P}^j is a generalized polymatroid, then it can be written as $\mathcal{P}^j = \{x^j \in \mathbb{R}^n \mid A_j x^j \leq b_j\}$, with each A_j totally unimodular. Moreover, $\sum_j (\mathcal{P}^j \cap \mathbb{Z}^n) = (\sum_j \mathcal{P}^j) \cap \mathbb{Z}^n$ as a consequence of [CLV08, Th. 2.10]. Then, Assumption B holds true and Theorem 6.18 is valid. Moreover, according to Proposition 3.26, the set $\sum_{j=1}^q (\mathcal{P}^j \cap \mathbb{Z}^n)$ is M^{\natural} -convex. We conclude by Theorem 6.15. \square

6.3.2 Generalization of the congestion problem

Here, we generalize the results of Section 6.3.1. We mentioned in Chapter 4, Section 4.3.1 that the integer problem can be generalized with concave functions instead of linear ones. We consider low-level problems of the type:

$$\max_{x^j \in \mathcal{P}^j \cap \mathbb{Z}^n} \langle y, x^j \rangle + \rho_j(x^j),$$

where functions ρ_j are M^{\natural} -concave. Hence, the global optimistic bilevel problem becomes:

Problem 6.20.

$$\min_{y \in \mathbb{R}^n} f(z^*) \tag{6.12}$$

with $z^* = \sum_{j=1}^q x^{j*}$ and for all $j \in [q]$, x^{j*} solution of:

$$\max_{x^j \in \mathcal{P}^j \cap \mathbb{Z}^n} \langle y, x^j \rangle + \rho_j(x^j). \tag{6.13}$$

This generalization can also be solved with the decomposition approach, using the function

$$\varphi(z) = \max_{\substack{\forall j, x^j \in \mathcal{P}^j \cap \mathbb{Z}^n \\ \sum_{j=1}^q x^j = z}} \sum_j \rho_j(x^j) = \max_{\substack{\forall j, x^j \in \mathbb{Z}^n \\ \sum_{j=1}^q x^j = z}} \sum_j [\rho_j(x^j) - \chi_{\mathcal{P}^j \cap \mathbb{Z}^n}(x^j)] \tag{6.14}$$

and its associated tropical polynomial

$$Q(y) = \max_{z \in \sum_j (\mathcal{P}^j \cap \mathbb{Z}^n)} [\langle y, z \rangle + \varphi(z)]. \quad (6.15)$$

We define ϕ as the bijection between the cells of the subdivision associated to the tropical hypersurface of Q and the cells of the dual subdivision of the Newton polytope (see Section 3.3).

Theorem 6.21. *Suppose that for each j the polyhedron \mathcal{P}^j is a g -polymatroid. Suppose furthermore that the function $\rho_j - \chi_{\mathcal{P}^j \cap \mathbb{Z}^n}$ is M^{\natural} -concave. Then, Problem 6.20 is equivalent to*

- Find $z^* \in \arg \min_{z \in \sum_{j=1}^q (\mathcal{P}^j \cap \mathbb{Z}^n)} f(z)$.
- Find $y^* \in \phi^{-1}(\mathcal{C}'_{z^*})$.

Proof. By summing the different low-level problems, Problem 6.20 can be rewritten:

$$\min_{y \in \mathbb{R}^n} f(z^*),$$

with z^* solution of $\max_{z \in \sum_j (\mathcal{P}^j \cap \mathbb{Z}^n)} [\langle y, z \rangle + \varphi(z)]$, with φ as in (6.14). Hence, if each function $\rho_j - \chi_{\mathcal{P}^j \cap \mathbb{Z}^n}$ is M^{\natural} -concave, then φ is M^{\natural} -concave as a consequence of Proposition 3.26. In particular, φ can be extended to \mathbb{R}^n in a polyhedral concave function. Let Q be its associated tropical polynomial (6.15), and \mathcal{S} the polyhedral complex associated to $\mathcal{T}(Q)$.

Since the polyhedra \mathcal{P}^j are g -polymatroid, we have $(\sum_{j=1}^q \mathcal{P}^j) \cap \mathbb{Z}^n = \sum_{j=1}^q (\mathcal{P}^j \cap \mathbb{Z}^n)$. Hence, with a similar approach as in Section 4.3.1, Corollary 4.33 can be applied. Problem 6.20 is then equivalent to:

$$\min_{z^* \in (\sum_{j=1}^q \mathcal{P}^j) \cap \mathbb{Z}^n} \inf_{y \in \phi^{-1}(\mathcal{C}'_{z^*})} f(z^*).$$

Because the high-level function does not depend on y , and $\sum_{j=1}^q \mathcal{P}^j = \bigcup_{y \in \mathbb{R}^n} \phi(\mathcal{C}_y)$, and $(\sum_{j=1}^q \mathcal{P}^j) \cap \mathbb{Z}^n = \sum_{j=1}^q (\mathcal{P}^j \cap \mathbb{Z}^n)$, this problem is equivalent to $\min_{z^* \in \sum_{j=1}^q (\mathcal{P}^j \cap \mathbb{Z}^n)} f(z^*)$. This result leads to a similar decomposition theorem as Theorem 6.11. \square

This decomposition of the bilevel problem leads to the following result:

Corollary 6.22. *Let us assume that $\forall j$, \mathcal{P}^j is a g -polymatroid, ρ_j is a M^{\natural} -concave function such that $\rho_j - \chi_{\mathcal{P}^j \cap \mathbb{Z}^n}$ is still M^{\natural} -concave. Assume moreover that f is M^{\natural} -concave. Then, Problem 6.20 can be solved in polynomial time.*

Proof. According to Theorem 6.21, Problem 6.20 is decomposed in two optimization problems. The first one is $\min_{z^* \in \sum_j (\mathcal{P}^j \cap \mathbb{Z}^n)} f(z)$. For each j , \mathcal{P}^j is a g -polymatroid. Hence, $\mathcal{P}^j \cap \mathbb{Z}^n$ is a M^{\natural} -convex set. Then, $\sum_j (\mathcal{P}^j \cap \mathbb{Z}^n)$ is also a M^{\natural} -convex set as Minkowski sum of M^{\natural} -convex sets. Consequently, we have to minimize a M^{\natural} -concave function, which can be done in polynomial time (see Section 3.4). To find a point $y^* \in \phi(\mathcal{C}'_{z^*})$ is equivalent to find a point verifying the following linear inequalities system:

$$\forall z \in \mathbb{Z}^n, \langle y^*, z^* \rangle + \varphi(z^*) \geq \langle y^*, z \rangle + \varphi(z). \quad (6.16)$$

The function φ is a M^{\natural} -concave function taking finite values only over $\sum_j (\mathcal{P}^j \cap \mathbb{Z}^n)$. Hence, we search y^* such that z^* is a global maximum of the discrete function $z \mapsto \varphi(z) + \langle y^*, z \rangle$, which is

also M^{\natural} -concave by addition of a M^{\natural} -concave function and a linear function. Consequently, the linear system (6.16) is equivalent to:

$$\begin{aligned} \forall i \in [n], \langle y^*, z^* \rangle + \varphi(z^*) &\geq \langle y^*, z^* - e_i \rangle + \varphi(z^* - e_i) \\ \forall i \in [n], \langle y^*, z^* \rangle + \varphi(z^*) &\geq \langle y^*, z^* + e_i \rangle + \varphi(z^* + e_i) \\ \forall i, j \in [n], \langle y^*, z^* \rangle + \varphi(z^*) &\geq \langle y^*, z^* - e_i + e_j \rangle + \varphi(z^* - e_i + e_j). \end{aligned}$$

This can be rewritten in:

$$\begin{aligned} \forall i \in [n], \varphi(z^*) - \varphi(z^* + e_i) &\geq y_i^* \geq \varphi(z^* - e_i) - \varphi(z^*) \\ \forall i, j \in [n], \varphi(z^*) - \varphi(z^* - e_i + e_j) &\geq y_j^* - y_i^*. \end{aligned}$$

It is a linear system in dimension n with n^2 inequalities. Hence, it can be solved in polynomial time in n and in the input size.

Once z^* and y^* have been computed, a solution x^* of the low level problem (6.13) is obtained by solving the maximization problem in (6.14). This consists in computing the sup-convolution φ of M^{\natural} -concave functions, which can be done in polynomial time by solving a M^{\natural} -convex submodular flow problem. (see Note 9.30 of [Mur03]). \square

Example 6.23. We apply the previous results on a simple example. We consider $n = 2$ and $q = 4$. We define the polytopes \mathcal{P}^j together with the functions ρ_j as :

$$\begin{aligned} \mathcal{P}^1 &= \{(x_1, x_2) \in \mathbb{R}_+^2 \mid x_1 + x_2 \leq 1\} \quad \text{and} \quad \rho_1(u_1) = -u_1(1) - 3u_1(2) \\ \mathcal{P}^2 &= \{(x_1, x_2) \in \mathbb{R}_+^2 \mid x_1 + x_2 \leq 1\} \quad \text{and} \quad \rho_2(u_2) = -2u_2(1) - u_2(2) \\ \mathcal{P}^3 &= \{(x_1, x_2) \in \mathbb{R}_+^2 \mid x_1 \leq 1, x_2 = 0\} \quad \text{and} \quad \rho_3(u_3) = u_3(1) \\ \mathcal{P}^4 &= \{(x_1, x_2) \in \mathbb{R}_+^2 \mid x_2 \leq 1, x_1 = 0\} \quad \text{and} \quad \rho_4(u_4) = -2u_4(2) \end{aligned}$$

Moreover, we define the function to minimize at the high-level stage as $f(z) = (z_1 - 2)^2 + (z_2 - 1)^2$.

Hence, for each $1 \leq j \leq 4$, the sets $\mathcal{P}^j \cap \mathbb{Z}^2$ are $\mathcal{P}^1 \cap \mathbb{Z}^2 = \{(0, 0); (0, 1); (1, 0)\}$, $\mathcal{P}^2 \cap \mathbb{Z}^2 = \{(0, 0); (0, 1); (1, 0)\}$, $\mathcal{P}^3 \cap \mathbb{Z}^2 = \{(0, 0); (1, 0)\}$ and $\mathcal{P}^4 \cap \mathbb{Z}^2 = \{(0, 0); (0, 1)\}$. It is straightforward to verify that for all $1 \leq j \leq 4$ the set $\mathcal{P}^j \cap \mathbb{Z}^2$ is M^{\natural} -convex and the function $\rho_j + \chi_{\mathcal{P}^j \cap \mathbb{Z}^2}$ is M^{\natural} -concave. Moreover, the function $f + \chi_{\sum_j (\mathcal{P}^j \cap \mathbb{Z}^2)}$ is M^{\natural} -convex, as sum of a M^{\natural} -convex function and a separable convex function.

The Minkowski sum $\sum_j (\mathcal{P}^j \cap \mathbb{Z}^2)$ is equal to $\{(z_1, z_2) \in \mathbb{Z}^2 \mid 0 \leq z_1 \leq 3, 0 \leq z_2 \leq 3, z_1 + z_2 \leq 4\}$. By solving the high-level problem, we obtain $z^* = (2, 1)$. The optimal x_j^* are those which attain the maximum in the sup-convolution φ of functions ρ_j , that is the optimal solutions of:

$$\begin{aligned} \max_{\substack{x^1 \in \mathcal{P}^1, \dots, x^4 \in \mathcal{P}^4 \\ x^1, \dots, x^4 \in \mathbb{Z}^2 \\ x^1 + x^2 + x^3 + x^4 = z^*}} & -x_1^1 - 3x_2^1 - 2x_1^2 - x_2^2 + x_1^3 - 2x_2^4 \end{aligned}$$

It leads to $x^{1*} = (1, 0)$, $x^{2*} = (0, 1)$, $x^{3*} = (1, 0)$ and $x^{4*} = (0, 0)$.

The low-level problems can be written for the different k as $\max(y_1 - 1, y_2 - 3, 0)$, $\max(y_1 - 2, y_2 - 1, 0)$, $\max(y_1 - 1, 0)$ and $\max(y_2 - 2, 0)$. To ensure the optimal solutions of these problems are the u_k^* defined previously, we have to take y^* in the polyhedron defined by the following equations: $y_1 - 1 \geq y_2 - 3$, $y_1 - 1 \geq 0$, $y_2 - 1 \geq y_1 - 2$, $y_2 - 1 \geq 0$, $y_1 - 1 \geq 0$ and $0 \geq y_2 - 2$. It means the optimal prices y^* are those which belong to the polyhedron $\{y \in \mathbb{R}^2 \mid 1 \leq y_1, 1 \leq y_2 \leq 2, y_1 - y_2 \leq 2\}$.

6.4 Comparison with a competitive equilibrium problem

6.4.1 The problem of competitive equilibrium

In this section, we establish a comparison between Problem 6.20 and a competitive equilibrium problem for indivisible goods developed by Danilov, Koshevoy and Murota ([DKM01]).

A competitive equilibrium problem in game theory can be formulated as follows. A set of K producers wants to sell n different goods to a set of J customers. We denote for each $k \in [K]$ by $z^k \in \mathbb{R}^n$ the supply of producer k (meaning that z_i^k is the quantity of good i sold by producer k), and for each $j \in [J]$ by $x^j \in \mathbb{R}^n$ the demand of customer j (meaning that x_i^j is the quantity of good i bought by customer i). Without any storage, the demand has to be equal to the supply at equilibrium, that is $\sum_{k=1}^K z^k = \sum_{j=1}^J x^j$. If the price of a good i is not constant among the different producers, then the customers want to buy it to the least expansive producer. The most expansive producers do not sell anything, then they decrease their prices. Consequently, if an equilibrium exists, then the price of each good i is p_i , not depending on the producers.

The profit of producer k is described by a function $f_k(z^k, p)$ depending on his production and on the price, whereas the utility of customer j is represented by a function $g_j(x^j, p)$ depending on his consumption and on the price. Each agent wants to maximize his own profit or utility. Hence, when the market price vector is p , the producer k is satisfied if his supply z^{k*} is such that $z^{k*} \in \arg \max_{z^k \in \mathbb{R}^n} f_k(z^k, p)$, whereas the customer j is satisfied if his demand x^{j*} is such that $x^{j*} \in \arg \max_{x^j \in \mathbb{R}^n} g_j(x^j, p)$. Hence, a *competitive equilibrium* exists if one can find a price vector p^* such that:

$$\begin{aligned} \forall k \in [K], z^{k*} &\in \arg \max_{z^k \in \mathbb{R}^n} f_k(z^k, p^*) \\ \forall j \in [J], x^{j*} &\in \arg \max_{x^j \in \mathbb{R}^n} g_j(x^j, p^*) \\ \sum_{k=1}^K z^{k*} &= \sum_{j=1}^J x^{j*} \end{aligned}$$

For divisible quantities, the existence of such an equilibrium under certain conditions was established by Arrow and Debreu [AD54]. Danilov, Koshevoy and Murota ([DKM01]) study the case of indivisible goods, meaning that the vectors z^k and x^j are constrained to belong to \mathbb{Z}^n . They study the usual case where the function f_k and g_j can be written $f_k(z^k, p) := f^k(z^k) + \langle p, z^k \rangle$, and $g_j(x^j, p) := g^j(x^j) - \langle p, x^j \rangle$, with functions f^k and g^j are defined over \mathbb{Z}^n .

Theorem 6.24 (Corollary of [DKM01], th.3). *Assume that f^k and g^j are M^\natural -concave function. Then, there always exist a competitive equilibrium.*

In fact, they mention the theorem for f^k and g^j belonging to a class of discrete concave functions, and prove in particular that M^\natural -concave functions are appropriate. We mention how an equilibrium can be found. The condition $\forall k \in [K], z^{k*} \in \arg \max_{z^k \in \mathbb{Z}^n} f^k(z^k) + \langle p, z^k \rangle$ is equivalent to $N^* \in \arg \max_{N \in \mathbb{Z}^n} F(N) + \langle p, N \rangle$ with $N = \sum_{k=1}^K z^k$ and F is the sup-convolution of functions f^k . Writing the same equivalence for the customers by introducing G as the sup-convolution of functions g^j , and using $\sum_k z^{k*} = \sum_j x^{j*}$, a competitive equilibrium exists if and only if there exist $p^* \in \mathbb{R}^n$ and $N^* \in \mathbb{Z}^n$ such that:

$$N^* \in \arg \max_{N \in \mathbb{Z}^n} F(N) + \langle p^*, N \rangle \quad \text{and} \quad N^* \in \arg \max_{N \in \mathbb{Z}^n} G(N) - \langle p^*, N \rangle$$

Because F and G are M^{\natural} -concave as sup-convolutions of M^{\natural} -concave functions, such a vector N^* exist if and only if $N^* \in \arg \max(F + G)$. The vector p^* is hence any vector p such that the functions $N \mapsto F(N) + \langle p, N \rangle$ and $N \mapsto G(N) - \langle p, N \rangle$ are maximal in N^* , that is p^* belongs to the polyhedron defined by the following inequalities:

$$\begin{aligned} \forall i \in [n], \max(F(N^* - e_i) - F(N^*), G(N^* + e_i) - G(N^*)) \\ \leq p_i^* \leq \min(F(N^*) - F(N^* + e_i), G(N^*) - G(N^* - e_i)) \\ \forall i, j \in [n], \max(F(N^* - e_i + e_j) - F(N^*), G(N^* + e_i - e_j) - G(N^*)) \\ \leq p_i^* - p_j^* \leq \min(F(N^*) - F(N^* + e_i - e_j), G(N^*) - G(N^* - e_i + e_j)) \end{aligned}$$

6.4.2 Comparison between the competitive equilibrium problem and the congestion problem

We introduce here a special case of the competitive equilibrium problem introduced in Section 6.4.1.

Let us consider the case $K = 1$ and $J = q$. We define $y \in \mathbb{R}^n$ as the opposite of the price, that is $y = -p$. It means that the supply of the producer satisfies $z^* \in \arg \max_{z \in \mathbb{Z}^n} F(z^*, y)$, whereas the demand of each customer $j \in [q]$ satisfies $x^{j*} \in \arg \max_{x^j \in \mathbb{Z}^n} g_j(x^j, y)$, with the condition $z^* = \sum_{j=1}^q x^{j*}$. We introduce a class of parametric competitive equilibrium problems as follows. We suppose that for each $j \in [q]$, $g_j(x^j, y) = \rho_j(x^j) - \chi_{\mathcal{P}^j \cap \mathbb{Z}^n}(x^j) + \langle y, x^j \rangle$. For $\lambda \geq 0$, we define $F(z^*, y) = -f(z^*) - \chi_{\sum_j(\mathcal{P}^j \cap \mathbb{Z}^n)}(z^*) \langle y, z^* \rangle$. We do the following assumption.

Assumption G. The function f is M^{\natural} -convex. For each $j \in [q]$, the function ρ_j is M^{\natural} -concave and the polytope \mathcal{P}^j is a g -polymatroid. Moreover, at least one of the following condition holds:

- For each $j \in [q]$, the function $\rho_j - \chi_{\mathcal{P}^j \cap \mathbb{Z}^n}$ is M^{\natural} -concave.
- The function $f + \chi_{\sum_j(\mathcal{P}^j \cap \mathbb{Z}^n)}$ is M^{\natural} -convex.

Hence, the competitive equilibrium problem (\mathcal{P}_λ) is written as follows. For $\lambda \geq 0$, under Assumption G, can we find $y_\lambda^* \in \mathbb{R}^n$, $z_\lambda^* \in \mathbb{Z}^n$ and for each $j \in [q]$, $x_\lambda^{j*} \in \mathbb{Z}^n$ such that:

$$(\mathcal{P}_\lambda) : \begin{cases} z_\lambda^* \in \arg \min_{z \in \sum_j(\mathcal{P}^j \cap \mathbb{Z}^n)} f(z) + \lambda \langle y_\lambda^*, z \rangle \\ \forall j \in [q], x_\lambda^{j*} \in \arg \max_{x^j \in \mathcal{P}^j \cap \mathbb{Z}^n} \rho_j(x^j) + \langle y_\lambda^*, x^j \rangle \\ z_\lambda^* = \sum_{j=1}^q x_\lambda^{j*} \end{cases}$$

We notice that if $\lambda = 0$, then the optimization of the producer does not depend on y . It leads to separate the study between two cases: $\lambda > 0$, and $\lambda = 0$.

Proposition 6.25. *Suppose that $\lambda > 0$. Then, a competitive equilibrium exists and can be obtained in polynomial time in n , q and the input size.*

Proof. If $\lambda > 0$, then the problem (\mathcal{P}_λ) can be rewritten. By using $p = -y$, the optimization of the producer is $\max_{z \in \mathbb{Z}^n} (-f - \chi_{\sum_j(\mathcal{P}^j \cap \mathbb{Z}^n)})(z) + \langle p, z \rangle$, and the optimization of each customer j is $\max_{x^j \in \mathbb{Z}^n} (\rho_j - \chi_{\mathcal{P}^j \cap \mathbb{Z}^n})(x^j) - \langle p, x^j \rangle$. Hence, under Assumption G, Theorem 6.24 can be applied, ensuring the existence of a competitive equilibrium. The optimal z_λ^* is such that $z_\lambda^* \in \arg \max -f(z) + \varphi(z) - \chi_{\sum_j(\mathcal{P}^j \cap \mathbb{Z}^n)}(z)$, where φ is the sup-convolution of the functions ρ_j . $\varphi - \chi_{\sum_j(\mathcal{P}^j \cap \mathbb{Z}^n)}$ being the sup-convolution of the M^{\natural} -concave functions $\rho_j - \chi_{\mathcal{P}^j \cap \mathbb{Z}^n}$, it is still

M^{\natural} -concave. Hence, z_{λ}^* is obtained by maximizing a M_2^{\natural} -concave function, what can be done in polynomial time in n and the input size (see Section 3.4). The price \mathcal{Y}_{λ}^* is obtained by finding a point satisfying linear inequalities as mentioned in Section 6.4.1. Finally, the vectors x_{λ}^{j*} are such that $\varphi(z_{\lambda}^*) = \sum_{j=1}^q \rho_j(x_{\lambda}^{j*})$. It can be obtained by solving a submodular flow problem (see Section 3.4), what can be done in polynomial time in n , q and the size input. \square

Example 6.26. We consider the same functions as in Example 6.23. We take $\lambda = 1$. The optimization problem of the producer becomes $\min_{z \in \sum_j (\mathcal{P}^j \cap \mathbb{Z}^n)} f(z) - \langle y, z \rangle$, whereas the optimization problem of each customer becomes $\max_{x^j \in \mathcal{P}^j \cap \mathbb{Z}^n} \rho_j(x^j) + \langle y, x^j \rangle$.

Consequently, the optimal z^* is computed as an optimal solution of:

$$\min_{z \in \sum_j (\mathcal{P}^j \cap \mathbb{Z}^n)} (z_1 - 2)^2 + (z_2 - 1)^2 + \min_{\substack{x^1 \in \mathcal{P}^1, \dots, x^4 \in \mathcal{P}^4 \\ x^1, x^2, x^3, x^4 \in \mathbb{Z}^2 \\ x^1 + x^2 + x^3 + x^4 = z}} [x_1^1 + 3x_2^1 + 2x_1^2 \\ + x_2^2 - x_1^3 + 2x_2^4]$$

The minimal value is equal to 1 and is attained for $z^* = (1, 0)$, $z^* = (1, 1)$ or $z^* = (2, 0)$. Take $z^* = (1, 0)$ for example. It leads to $x^{1*} = (0, 0)$, $x^{2*} = (0, 0)$, $x^{3*} = (1, 0)$ and $x^{4*} = (0, 0)$. The optimal y^* correspond to the value of y for which x^{j*} is the optimal solution of the customer problem for each j , and z^* the optimal solution of the producer problem. From customers' problem, we deduce $y_1^* - 1 \leq 0$, $y_2^* - 3 \leq 0$, $y_2^* - 1 \leq 0$, $y_1^* - 2 \leq 0$, $y_1^* - 1 \geq 0$, $y_2^* - 2 \leq 0$, that is $y_1^* = 1$ and $y_2^* \leq 1$. Moreover, the optimal y^* are also the values of y for which z^* is optimal for the producer. By the equivalence between local and global optimality for M^{\natural} -convex functions, we have $2 + y_1^* \leq 5$, $2 + y_1^* \leq 1 + 2y_1^*$, $2 + y_1^* \leq 1 + y_1^* + y_2^*$ and $2 + y_1^* \leq 4 + y_2^*$, that is $1 \leq y_1^* \leq 3$, $y_2^* \geq -1$ and $y_1^* - y_2^* \leq 2$. Consequently, the set of optimal y^* is the following polyhedron $\{y \in \mathbb{R}^2 \mid y_1 = 1, -1 \leq y_2 \leq 1\}$.

The optimization function of the producer in the case $\lambda = 0$ does not depend on the price, as in the bilevel problem 6.20. Moreover, we have the following result.

Theorem 6.27. *The competitive equilibrium problem (\mathcal{P}_0) is equivalent to Problem 6.20.*

Proof. Problem (\mathcal{P}_0) is equivalent to find $y_0^* \in \mathbb{R}^n$, $z_0^* \in \mathbb{Z}^n$ and for each $j \in [q]$, $x_0^{j*} \in \mathcal{P}^j \cap \mathbb{Z}^n$ such that $z_0^* \in \arg \min_{z \in \sum_j (\mathcal{P}^j \cap \mathbb{Z}^n)} f(z)$, for each $j \in [q]$, $x_0^{j*} \in \arg \max_{x^j \in \mathcal{P}^j \cap \mathbb{Z}^n} \rho_j(x^j) + \langle y_0^*, x^j \rangle$, and $z_0^* = \sum_{j=1}^q x_0^{j*}$. This is hence equivalent to find $y_0^* \in \mathbb{R}^n$ and $z_0^* \in \mathbb{Z}^n$ such that $z_0^* \in \arg \min_{z \in \sum_j (\mathcal{P}^j \cap \mathbb{Z}^n)} f(z)$ and $z_0^* \in \arg \max_{z \in \sum_j (\mathcal{P}^j \cap \mathbb{Z}^n)} \langle y_0^*, z \rangle + \varphi(z)$. By introducing the subdivision associated to the tropical polynomial $Q(y) = \max_{z \in \sum_j (\mathcal{P}^j \cap \mathbb{Z}^n)} \langle y, z \rangle + \varphi(z)$, this is equivalent to Problem 6.20 according to Theorem 6.21. \square

It means that the bilevel Problem 6.20 belong in fact to the class of competitive equilibrium problems. This correspondance comes from the specific structure of Problem 6.20 and Problem (\mathcal{P}_0) , that is the non-dependance on the price y in the optimization function of the producer.

6.4.3 Congestion problem as a limit of competitive equilibrium problems

We will now see that the congestion problem can be viewed as a limit case of competitive equilibrium problems when λ goes to 0.

For $\lambda \in \mathbb{R}_+$, we consider the sets of optimal supply \mathcal{Z}_λ defined by:

$$\mathcal{Z}_\lambda = \arg \min_{z \in \sum_j (\mathcal{P}^j \cap \mathbb{Z}^n)} [f(z) - \lambda \varphi(z)]$$

We define also the sets of equilibrium prices \mathcal{Y}_λ as the sets of vectors $y \in \mathbb{R}^n$ such that there exists $z^* \in \mathcal{Z}_\lambda$ with $\forall z \in \sum_j (\mathcal{P}^j \cap \mathbb{Z}^n)$:

$$\begin{aligned} \varphi(z^*) + \langle y, z^* \rangle &\geq \varphi(z) + \langle y, z \rangle \\ f(z^*) + \lambda \langle y, z^* \rangle &\leq f(z) + \lambda \langle y, z^* \rangle \end{aligned}$$

We mention that in the case $\lambda = 0$, the second inequality in the definition of \mathcal{Y}_0 is automatically induced by the condition $z^* \in \mathcal{Z}_0$.

We will now explain in which sense the congestion problem (\mathcal{P}_0) is a limit case of the competitive equilibrium problems (\mathcal{P}_λ) when λ goes to 0.

Theorem 6.28. *There exists a critical value λ_C such that $\forall 0 < \lambda < \lambda_C$, $\mathcal{Z}_\lambda = \arg \max_{z \in \mathcal{Z}_0} \varphi(z)$. In particular, we have $\mathcal{Z}_\lambda \subset \mathcal{Z}_0$.*

Proof. The set $\sum_j (\mathcal{P}^j \cap \mathbb{Z}^n)$ is finite. Hence, the sets of values $\{f(z) \mid z \in \sum_j (\mathcal{P}^j \cap \mathbb{Z}^n)\}$ and $\{\varphi(z) \mid z \in \sum_j (\mathcal{P}^j \cap \mathbb{Z}^n)\}$ are also finite and discrete.

If f is constant over $\sum_j (\mathcal{P}^j \cap \mathbb{Z}^n)$, then $\mathcal{Z}_0 = \sum_j (\mathcal{P}^j \cap \mathbb{Z}^n)$ and clearly $\forall \lambda \in \mathbb{R}_+$, $\mathcal{Z}_\lambda = \arg \max_{z \in \mathcal{Z}_0} \varphi(z)$. If φ is constant over $\sum_j (\mathcal{P}^j \cap \mathbb{Z}^n)$, then we have:

$$\arg \min_{z \in \sum_j (\mathcal{P}^j \cap \mathbb{Z}^n)} [f(z) - \lambda \varphi(z)] = \arg \min_{z \in \sum_j (\mathcal{P}^j \cap \mathbb{Z}^n)} f(z),$$

that is $\mathcal{Z}_\lambda = \mathcal{Z}_0$. In this case, we have also $\arg \max_{z \in \mathcal{Z}_0} \varphi(z) = \mathcal{Z}_0$.

Assume now that f and φ are not constant over $\sum_j (\mathcal{P}^j \cap \mathbb{Z}^n)$. We define two value f_0 and f_1 as :

$$\begin{aligned} f_0 &= \min_{z \in \sum_j (\mathcal{P}^j \cap \mathbb{Z}^n)} f(z) \\ f_1 &= \min_{z \in \sum_j (\mathcal{P}^j \cap \mathbb{Z}^n), f(z) > f_0} f(z). \end{aligned}$$

Because the set $\{f(z) \mid z \in \sum_j (\mathcal{P}^j \cap \mathbb{Z}^n)\}$ is finite and discrete, those definitions mean that f_0 and f_1 correspond to the two smallest values of function f .

Define λ_C as:

$$\lambda_C = \frac{f_1 - f_0}{\max_{N \in \sum_j (\mathcal{P}^j \cap \mathbb{Z}^n)} \varphi(z) - \min_{N \in \sum_j (\mathcal{P}^j \cap \mathbb{Z}^n)} \varphi(z)}$$

Because f and φ are not constant functions over $\sum_j (\mathcal{P}^j \cap \mathbb{Z}^n)$, λ_C is well defined and positive. Let $0 < \lambda < \lambda_C$ and $z^* \in \mathcal{Z}_\lambda$. For each $z \in \sum_j (\mathcal{P}^j \cap \mathbb{Z}^n)$, we have $f(z^*) - \lambda \varphi(z^*) \leq f(z) - \lambda \varphi(z)$, that is:

$$\begin{aligned} f(z^*) &\leq f(z) + \lambda (\varphi(z^*) - \varphi(z)) < f(z) + \lambda_C (\varphi(z^*) - \varphi(z)) \\ &< f(z) + (f_1 - f_0) < f_1. \end{aligned}$$

Hence, by definition of constants f_0 and f_1 , $f(z^*) = f_0$ and $z^* \in \mathcal{Z}_0$. Take $z \in \mathcal{Z}_0$. We have $f(z^*) - \lambda\varphi(z^*) \leq f(z) - \lambda\varphi(z)$ and $f(z^*) = f(z) = f_0$. So, $\varphi(z^*) \geq \varphi(z)$ and $z^* \in \arg \max_{z \in \mathcal{Z}_0} \varphi(z)$.

Conversely, consider $z^* \in \arg \max_{z \in \mathcal{Z}_0} \varphi(z)$. In particular, $z^* \in \mathcal{Z}_0$, meaning that $f(z^*) = f_0$. Consider $z \in \sum_j (\mathcal{P}^j \cap \mathbb{Z}^n)$. If $f(z) = f_0$, then $z \in \mathcal{Z}_0$. So, by definition of z^* , $\varphi(z^*) \geq \varphi(z)$ and $f(z^*) - \lambda\varphi(z^*) \leq f(z) - \lambda\varphi(z)$. Else, $f(z) \geq f_1$. So:

$$\begin{aligned} f(z) - f(z^*) &\geq f_1 - f_0 = \lambda_C \left[\max_{z \in \sum_j (\mathcal{P}^j \cap \mathbb{Z}^n)} \varphi(z) - \min_{z \in \sum_j (\mathcal{P}^j \cap \mathbb{Z}^n)} \varphi(z) \right] \\ &\geq \lambda(\varphi(z^*) - \varphi(z)) \end{aligned}$$

So, we also have $f(z^*) - \lambda\varphi(z^*) \leq f(z) - \lambda\varphi(z)$, that is $z^* \in \mathcal{Z}_\lambda$. \square

The existence of the critical value λ_C means that for small values of λ , the problem consisting to determine \mathcal{Z}_λ belongs to the class of lexicographic optimization problems. To belong to \mathcal{Z}_λ , it is necessary to solve $\min_{z \in \sum_j (\mathcal{P}^j \cap \mathbb{Z}^n)} f(z)$, and then to solve $\max \varphi(z)$ among the solutions of the first problem.

Corollary 6.29. For $0 \leq \lambda < \lambda_C$, $\mathcal{Y}_\lambda \subset \mathcal{Y}_0$.

Proof. By definition of \mathcal{Y}_λ , a price vector y belongs to \mathcal{Y}_λ if and only if there exists $z^* \in \mathcal{Z}_\lambda$ such that $\forall z \in \sum_j (\mathcal{P}^j \cap \mathbb{Z}^n)$:

$$\begin{aligned} \varphi(z^*) + \langle y, z^* \rangle &\geq \varphi(z) + \langle y, z \rangle \\ f(z^*) + \lambda \langle y, z^* \rangle &\leq f(z) + \lambda \langle y, z \rangle \end{aligned}$$

According to Theorem 6.28, $z^* \in \mathcal{Z}_0$. So, $\forall z \in \sum_j (\mathcal{P}^j \cap \mathbb{Z}^n)$, we have $f(z^*) \leq f(z)$. Thus, $y \in \mathcal{Y}_0$. \square

It means that for $0 < \lambda < \lambda_C$, the problem (\mathcal{P}_λ) can be solved lexicographically, first by minimizing f over $\sum_j (\mathcal{P}^j \cap \mathbb{Z}^n)$, and secondly by maximizing φ over the set of minimizers of f which is exactly \mathcal{Z}_0 .

Example 6.30. We illustrate Theorem 6.28. In Example 6.23, we study the case $\lambda = 0$. In Example 6.26, we study $\lambda = 1$. We consider the same functions for the producer and for the customers.

To illustrate the previous results, we need to determine the critical value λ_C .

- $f_0 = \min_{z \in \sum_j (\mathcal{P}^j \cap \mathbb{Z}^n)} f(z) = - \min_{z \in \sum_j (\mathcal{P}^j \cap \mathbb{Z}^n)} (z_1 - 2)^2 + (z_2 - 1)^2 = 0$.
- $f_1 = \min_{z \in \sum_j (\mathcal{P}^j \cap \mathbb{Z}^n), f(z) > 0} f(z) = 1$.

The function φ is defined as the sup-convolution of functions ρ_j over \mathcal{P}^j . Hence,

$$\varphi(z) = - \min_{\substack{x^1 \in \mathcal{P}^1, \dots, x^4 \in \mathcal{P}^4 \\ x^1, x^2, x^3, x^4 \in \mathbb{Z}^2 \\ x^1 + x^2 + x^3 + x^4 = z}} [x_1^1 + 3x_2^1 + 2x_1^2 + x_2^2 - x_1^3 + 2x_2^4]$$

So, $\max_{z \in \sum_j (\mathcal{P}^j \cap \mathbb{Z}^n)} \varphi(z) = - \min_{\substack{x^1 \in \mathcal{P}^1, \dots, x^4 \in \mathcal{P}^4 \\ x^1, x^2, x^3, x^4 \in \mathbb{Z}^2}} x_1^1 + 3x_2^1 + 2x_1^2 + x_2^2 - x_1^3 + 2x_2^4 = 1$, attained for $z^* = (1, 0)$ and $x^{1*} = (0, 0)$, $x^{2*} = (0, 0)$, $x^{3*} = (1, 0)$, $x^{4*} = (0, 0)$. We can also calculate

$\min_{z \in \sum_j (\mathcal{P}^j \cap \mathbb{Z}^2)} \varphi(z) = -6$ In fact, consider $z \in \sum_j (\mathcal{P}^j \cap \mathbb{Z}^2)$ such that $z_1 \geq 1$. Take $x^3 = (1, 0)$. Then, for each $j \in \{1, 2, 4\}$ and $x^j \in \mathcal{P}^j \cap \mathbb{Z}^2$, we have:

$$x_1^1 + 3x_2^1 + 2x_1^2 + x_2^2 - x_1^3 + 2x_2^4 \leq 3 + 2 - 1 + 2 = 6$$

Then $\phi(z) \geq -6$. Consider now $z \in \sum_j (\mathcal{P}^j \cap \mathbb{Z}^2)$ such that $z_1 = 0$. Then, for each $j \in [4]$ and each $x_j \in \mathcal{P}^j \cap \mathbb{Z}^2$, the condition $\sum_j x^j = z$ implies $x_1^j = 0$ and:

$$x_1^1 + 3x_2^1 + 2x_1^2 + x_2^2 - x_1^3 + 2x_2^4 \leq 3 + 2 + 1 = 6,$$

meaning that $\varphi(z) \geq -6$. Hence, for $z^* = (0, 3)$ and $x^{1*} = (0, 1)$, $x^{2*} = (0, 1)$, $x^{3*} = (0, 0)$ and $x^{4*} = (0, 1)$, we have $\varphi(z^*) = -6$. Consequently, $\lambda_C = \frac{1-0}{1-(-6)} = 1/7$.

Take for example $\lambda = 0.1$. We have to compute \mathcal{Z}_λ , that is to solve:

$$\min_{z \in \sum_j (\mathcal{P}^j \cap \mathbb{Z}^2)} 10(z_1 - 2)^2 + 10(z_2 - 1)^2 + \min_{\substack{x^1 \in \mathcal{P}^1, \dots, x^4 \in \mathcal{P}^4 \\ x^1, x^2, x^3, x^4 \in \mathbb{Z}^2 \\ x^1 + x^2 + x^3 + x^4 = z}} [x_1^1 + 3x_2^1 + 2x_1^2 + x_2^2 - x_1^3 + 2x_2^4]$$

We have clearly $\mathcal{Z}_\lambda = \{(2, 1)\}$, that is $\mathcal{Z}_\lambda = \mathcal{Z}_0$. We have $x^{1*} = (1, 0)$, $x^{2*} = (0, 1)$, $x^{3*} = (1, 0)$ and $x^{4*} = (0, 0)$. The optimal y^* correspond to the prices for which x^{j*} is the optimal consumption of each customer. It gives $y_1^* \geq 1$, $1 \leq y_2^* \leq 2$ and $y_1^* - y_2^* \leq 2$ according to the result of Section 6.4.2. The optimal y^* correspond also to the prices for which z^* is the optimal solution of the producer problem. By the equivalence between global and local optimality for M^1 -convex functions, we have:

$$\begin{aligned} 2y_1^* + y_2^* &\leq 10 + y_1^* + y_2^* & 2y_1^* + y_2^* &\leq 10 + 3y_1^* + y_2^* \\ 2y_1^* + y_2^* &\leq 10 + 2y_1^* + y_2^* & 2y_1^* + y_2^* &\leq 10 + 2y_1^* + 2y_2^* \\ 2y_1^* + y_2^* &\leq 20 + y_1^* + 2y_2^* & 2y_1^* + y_2^* &\leq 20 + 3y_1^*, \end{aligned}$$

that is $-10 \leq y_1^* \leq 10$, $-10 \leq y_2^* \leq 10$ and $-20 \leq y_1^* - y_2^* \leq 20$. Notice that $1 \leq y_2^* \leq 2$ and $2 \geq y_1^* - y_2^*$ imply $y_1^* \leq 4$. Moreover, $y_1^* \geq 1$ and $y_2^* \leq 2$ imply $y_1^* - y_2^* \geq -1$. Hence, the set of optimal prices \mathcal{Y}_λ is the polyhedron $\mathcal{Y}_\lambda = \{y \in \mathbb{R}^2 \mid y_1^* \geq 1, 1 \leq y_2^* \leq 2, y_1^* - y_2^* \leq 2\}$, that is $\mathcal{Y}_\lambda = \mathcal{Y}_0$.

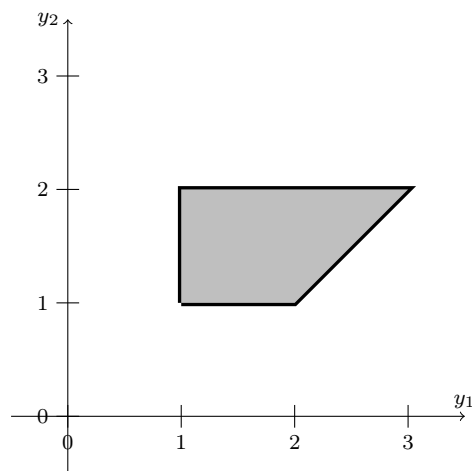

Figure 6.3: Set of optimal prices \mathcal{Y}_λ of Problem (\mathcal{P}_λ) for $\lambda = 0.1$

Part II

Application to a telecom problem

CHAPTER 7

A bilevel model for price incentives in telecommunications network

We propose a model of incentives for data pricing in large mobile networks, in which an operator wishes to balance the number of connexions (active users) of different classes of users in the different cells (or locations) and at different time instants, in order to ensure them a sufficient quality of service. We assume that each user has a given total demand per day for different types of applications, which he may assign to different time slots and locations, depending on his own mobility, on his preferences and on price discounts proposed by the operator. We show that this can be cast as a bilevel programming problem with a special structure allowing us to develop a polynomial time decomposition algorithm suitable for large networks. First, we determine the optimal number of connexions (which maximizes a measure of balance); next, we solve an inverse problem and determine the prices generating this traffic. Our results exploit a recently developed application of tropical geometry methods to mixed auction problems, as well as algorithms in discrete convexity (minimization of discrete convex functions in the sense of Murota). We finally present an application on real data provided by Orange and we show the efficiency of the model to reduce the peaks of congestion.

7.1 Introduction

With the development of new mobile data technologies (3G, 4G), the demand for using the Internet with mobile phones has increased rapidly. Mobile service providers (MSP) have to

confront congestion problems in order to guarantee a sufficient quality of service (QoS).

Several approaches have been developed to improve the quality of service, coming from different fields of the telecommunication engineering and economics. For instance, one can refer to Bonald and Feuillet [BF13] for some models of performance analysis to optimize the network in order to improve the QoS. One of the promising alternatives to solve such problems consists in using efficient pricing schemes in order to encourage customers to shift their mobile data consumption. In [MT06], Maillé and Tuffin describe a mechanism of auctions based on game-theoretic methods for pricing an Internet network, see also [MT14]. In [ABEA⁺06], Altman et al. study how to price different services by using a noncooperative game. These different approaches are based on congestion games. In the present work, we are interested in how a MSP can improve the QoS by balancing the traffic in the network. We wish to determine in which locations, and at which time instants, it is relevant to propose price incentives, and to evaluate the influence of these incentives on the quality of service.

This kind of problem belongs to smart data pricing. We refer the reader to the survey of Sen et al. [SJWHC13] and also to the collection of articles [SJWHC14]. Finding efficient pricing schemes is a revenue management issue. The first approach consists in usage-based pricing; the prices are fixed monthly by analysing the use of the former months. It is possible to improve this scheme by identifying peak hours and non-peak hours and proposing incentives in non-peak hours in order to decrease the demand at peak hours and to better use the network capacity at non-peak hours. This leads to time-dependent pricing. Such a scheme for mobile data is developed by Ha et al. in [HSJW⁺12]. The prices are determined at different time slots and based on the usage of the previous day in order to maximize the utility of the customers and the revenue of the MSP. This pricing scheme was concretely implemented by AT&T, showing the relevance of such a model. In another approach, Tadrous et al. propose a model in which the MSP anticipates peak hours and determines incentives for proactive downloads [TEEG13].

The latter models concern only the time aspects. One must also take into account the spatial aspect in order to optimize the demand between the different locations. In [MLH14], Ma, Liu and Huang present a model depending on time and location of the customers where the MSP proposes prices and optimizes his profit taking into account the utility of the customers.

Here, we assume (as in [MLH14]) that the MSP proposes incentives at different time and places. Then, customers optimize their data consumption by knowing these incentives and the MSP optimizes a measure of the QoS. In this way, we introduce a bilevel model in which the provider proposes incentives in order to balance the traffic in the network and to avoid as much as possible the congestion (high level problem), and customers optimize their own consumption for the given incentives (low level problem).

Bilevel programs have been widely studied, see the surveys of Colson, Marcotte and Savard [CMS07] and of Dempe [Dem03b]. They represent an important class of pricing problems in sense that they model a leader wanting to maximize his profit and proposing prices to some followers who maximize themselves their own utility. Most classes of bilevel programs are known to be NP-hard. Several methods have been introduced to solve such problems. For instance, if the low level program is convex, it can be replaced by its Karush-Kuhn-Tucker optimality conditions and the bilevel problem becomes a classical one-stage optimization problem, which is however generally non convex. If some variables are binary or discrete, and the objective function is linear, the global bilevel problem can be rewritten as a mixed integer program, as in Brotcorne et al. [BLMS00].

In the present work, we optimize the consumption of each customer in a large area (large urban agglomerations) during typically one day divided in time slots of one hour, taking into

account the different types of customers and of applications that they use. Therefore, we have to confront both with the difficulties inherent to bilevel programming and with the large number of variables (around 10^7). Hence, we need to find polynomial time algorithms, or fast approximate methods, for classes of problems of a very large scale, which, if treated directly, would lead to mixed integer linear or nonlinear programming formulations beyond the capacities of current off-the-shelve solvers.

This motivated us to introduce a different approach, based on tropical geometry. Tropical geometry methods have been recently applied by Baldwin and Klemperer in [BK12] to an auction problem. This has been further developed by Yu and Tran [TY15]. In these approaches, the response of an agent to a price is represented by a certain polyhedral complex (arrangement of tropical hypersurfaces). This approach is intuitive since it allows one to visualize geometrically the behavior of the agents: each cell of the complex corresponds to the set of incentives leading to a given response. Then, we visualize the collective response of a group of customers by “superposing” (refining) the polyhedral complexes attached to every customer in this group. We apply here this idea to represent the response of the low-level optimizers in a bilevel problem. This leads to the following decomposition method: first we compute, among all the admissible consumptions of the customers, the one which maximizes a measure of balance of the network; then, we determine the price incentive which achieves this consumption. In this way, a bilevel problem is reduced to the minimization of a convex function over a certain Minkowski sum of sets. We identify situations in which the latter problem can be solved in polynomial time, by exploiting the discrete convexity results developed by Murota [Mur03]. In this approach, a critical step is to check the membership of a vector to a certain Minkowski sum of sets of integer points of polytopes. In our present model, these polytopes, which represent the possible consumptions of one customer, have a remarkable combinatorial structure (they are hypersimplices). Exploiting this combinatorial structure, we show that this critical step can be performed quickly, by reduction to a shortest path problem in a graph. This leads to an exact solution method when there is only one type of contract and one type of application sensitive to price incentive, and to a fast approximate method in the general case.

We finally present the application of this model on real data from Orange and show how price incentives can improve the QoS by balancing the number of active customers in an urban agglomeration during one day. These results indicate that a price incentive mechanism can effectively improve the satisfaction of the users by displacing their consumption from the most loaded regions of the space-time domain to less loaded regions.

The paper is organized as follows. In Section 7.2, we present the bilevel model. In Section 7.3, we explain how a certain polyhedral complex can be used to represent the user’s responses, and we describe the decomposition method. In Section 7.5, we deal with the high level problem and identify special cases which are solvable in polynomial time. We also propose a general relaxation method. The application to the instance provided by Orange is presented in Section 7.6.

7.2 A bilevel model

We consider a time horizon of one day, divided in T time slots numbered $t \in [T] = \{1, \dots, T\}$, and a network divided in L different cells numbered $l \in [L]$. We assume that K customers, numbered $k \in [K]$, are in the network. The customers have different types of contracts $b \in [B]$ and they make requests for different types of applications $a \in [A]$ (web/mail, streaming, download, ...). We denote by \mathcal{K}^b the set of customers with the contract b . A given customer $k \in \mathcal{K}^b$ is

characterized by the following data. We denote by $L_t^k \in [L]$ the position of the customer k at each time $t \in [T]$, so that the sequence (L_1^k, \dots, L_T^k) represents the trajectory of this customer. We assume that this trajectory is deterministic, so we consider customers with a regular daily mobility (for example, the trip between home and work). We denote by $\rho_k^a(t)$ the inclination of a customer k to make a request for an application of type a at time $t \in [T]$. We suppose that customer k wishes to make a fixed number of requests $R_k^a \leq T$ using the application a during the day. We consider a set of time slots $\mathcal{I}_k^a \subset [T]$ in which the customer k decides not to consume the application a .

We denote by $u_k^a(t)$ the consumption of the customer k for the application a at time t , setting $u_k^a(t) = 1$ if k is active at time t and makes a request of type a and $u_k^a(t) = 0$ otherwise. Therefore, the number $N^{a,b}(t, l)$ of active customers with contract b for the application a at time t and location l is given by $N^{a,b}(t, l) = \sum_{k \in \mathcal{K}^b} u_k^a(t) \mathbb{1}(L_t^k = l)$, where $\mathbb{1}$ denotes the indicator function, and the total number of active customers $N(t, l)$ at time t and location l is given by $N(t, l) = \sum_a \sum_b N^{a,b}(t, l)$.

We consider the following two-stage model of price incentives. The first stage consists for the operator in announcing a discount $y^{a,b}(t, l)$ at time t and location l for the customers of contract b making requests of type a . We consider only nonnegative discounts, so $y^{a,b}(t, l) \geq 0$. The second stage models the behavior of customers who modify their consumption by taking the discounts into account. We will assume the preference of a customer k for consuming at time t becomes $\rho_k^a(t) + \alpha_k^a y^{a,b}(t, L_t^k)$, where α_k^a denotes the sensitivity of customer k to price incentives for the application a . It corresponds to classical linear utility functions, see e.g. [BK12]. We also assume that the customers cannot make more than one request at each time, that is $\forall t \in [T], \sum_a u_k^a(t) \leq 1$. Therefore, each customer k determines his consumptions $u_k^a = (u_k^a(t))_{t \in [T]} \in \{0, 1\}^T$ for the applications, as an optimal solution of the linear program:

Problem 7.1 (Low-level, customers).

$$\begin{aligned} & \max_{u_k^a \in \{0,1\}^T} \sum_{a \in [A]} \sum_{t=1}^T \left[\rho_k^a(t) + \alpha_k^a y^{a,b}(t, L_t^k) \right] u_k^a(t) & (7.1) \\ & s.t. \quad \forall a \in [A], \sum_{t=1}^T u_k^a(t) = R_k^a, \quad \forall t \in [T], \sum_{a \in [A]} u_k^a(t) \leq 1 \\ & \quad \forall t \in \mathcal{I}_k^a, \forall a \in [A], u_k^a(t) = 0 \end{aligned}$$

Consequently, each price $y^{a,b} = (y^{a,b}(t, l))_{t \in [T], l \in [L]}$ determines the possible individual consumptions u_k^a for the users with contract b , and so the possible cumulated traffic vectors $N^{a,b} = (N^{a,b}(t, l))_{t \in [T], l \in [L]}$ and $N = \sum_a \sum_b N^{a,b}$. The aim of the operator is, through price incentives, to balance the load in the network into the different locations and time slots to improve the quality of service perceived by each customer. We introduce a coefficient γ_b relative to the kind of contracts of the different customers in order to favor some classes of premium customers. In [LMS05], Lee et al. suppose that the satisfaction of a customer depends on his perceived throughput, which can be considered as inversely proportional to the number of customers in the cell. Here, we assume that the satisfaction of each customer k in the cell $l \in [L]$ is a decreasing function $s_l^{a,b}$ of the total number of active customers in the cell $N(t, l)$, depending on the characteristics of the cell, of the type of application the user wants to do (some applications like

streaming need a higher rate than other) and on the type of contract. We also assume the satisfaction of all the customers with contract b using a given application a in a given cell is maximal until the number of active customers reaches a certain threshold $N_l^{a,b}$, then $s_l^{a,b}(N(t, l)) = 1$ for $N(t, l) \leq N_l^{a,b}$. After this threshold, the satisfaction decreases until a critical value N_l^C . We add the constraint $\forall t \in [T], \forall l \in [L], N(t, l) \leq N_l^C$ to prevent the congestion. For non-real time services like web, mail, download, the satisfaction function can be viewed as a concave function of the throughput, like $1 - e^{-\delta/\delta_c}$ where δ denotes the throughput, see Moety et al. [MBENN16]. Hence, we will consider that for contents like web, mail and download, $N_l^{a,b} = N_l^1$, $s_l^{a,b}(n) = 1$ for $n \leq N_l^1$ and $s_l^{a,b}(n) = 1 - \lambda_b \exp\left(-\frac{2N_l^C}{n - N_l^1}\right)$ for $N_l^1 \leq n \leq N_l^C$ where λ_b is a positive parameter depending on the kind of contract of the customer. The more expensive the contract of the customer is, the larger is λ_b . We can prove that this function is concave for $0 \leq n \leq N_l^C$. For real time services like video streaming, the customers need a more important throughput to ensure a good QoS [LMS05]. We will here consider the same type of functions $s_l^{a,b}$ but with N_l^1 replaced by $N_l^{a,b} = 0$, that is $s_l^{a,b}(n) = 1 - \lambda_b \exp\left(-\frac{2N_l^C}{n}\right)$ for $0 < n \leq N_l^C$.

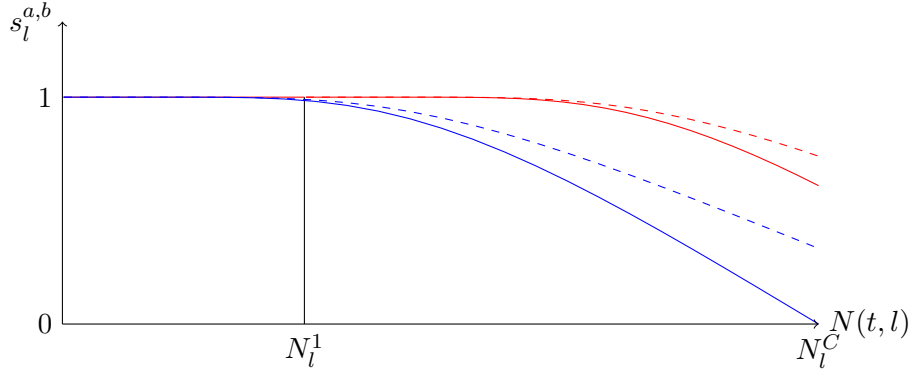

Figure 7.1: Different kind of satisfaction functions of the number of active customers in a cell. The blue ones are those for streaming contents whereas the red ones are those for web, mail and download contents. The dashed ones corresponds to the satisfaction of standard customers, the continuous ones to the satisfaction of premium customers.

So, the first stage consists in maximizing the global satisfaction function s which depends on the vectors $N^{a,b} \in \mathbb{N}^{T \times L}$ and is defined by:

$$\begin{aligned}
 s(N^{a,b}) &= \sum_{t=1}^T \sum_{a \in [A]} \sum_{b \in [B]} \sum_{k \in \mathcal{K}^b} \gamma_b s_{L_t^k}^{a,b}(N(t, L_t^k)) u_k^a(t) \\
 &= \sum_{t=1}^T \sum_{a \in [A]} \sum_{b \in [B]} \sum_{k \in \mathcal{K}^b} \sum_{l=1}^L \gamma_b s_l^{a,b}(N(t, l)) \mathbb{1}(L_t^k = l) u_k^a(t) \\
 &= \sum_{t=1}^T \sum_{l=1}^L \sum_{a \in [A]} \sum_{b \in [B]} \gamma_b N^{a,b}(t, l) s_l^{a,b}(N(t, l))
 \end{aligned}$$

with $\forall b \in [B], \gamma_b > 0$. Our final model consists in solving the following bilevel program:

Problem 7.2 (High-level, provider).

$$\max_{y^{a,b} \in \mathbb{R}_+^{T \times L}} \sum_{t=1}^T \sum_{l=1}^L \sum_{a \in [A]} \sum_{b \in [B]} \gamma_b N^{a,b}(t,l) s_l^{a,b}(N(t,l)) \quad (7.2)$$

where $\forall t \in [T], l \in [L], N(t,l) = \sum_{a=1}^A \sum_{b=1}^B N^{a,b}(t,l)$, and $N(t,l) \leq N_l^C, \forall t \in [T], l \in [L], a \in [A], b \in [B], N^{a,b}(t,l) = \sum_{k \in \mathcal{K}^b} u_k^a(t) \mathbf{1}(L_t^k = l)$, and $\forall k \in [K]$, the vectors u_k^a are solutions of Problem 7.1.

7.3 A polynomial time algorithm for solving the first model

We will present a decomposition method for solving the previous bilevel problem. In this section, and in the two next ones, we suppose that there is only one kind of application and one kind of contract. This special case is already relevant in applications: it covers the case when, for instance, only the download requests are influenced by price incentives, whereas other requests like streaming or web are fixed. Whereas the analytical results of the present section carry over to the general model, the results of the next two sections (polynomial time solvability) are only valid under these restrictive assumptions. We shall return to the general case in Section 7.5, developing a fast approximate algorithm for the general model based on the present principles.

In this special case, the bilevel model can be rewritten:

$$\max_{y \in \mathbb{R}_+^{T \times L}} \sum_{t=1}^T \sum_{l=1}^L N(t,l) s_l(N(t,l))$$

where $\forall t, l N(t,l) \leq N_l^C$ and $N(t,l) = \sum_{k \in [K]} u_k^*(t) \mathbf{1}(L_t^k = l)$, and for each $k \in [K]$ the vectors u_k^* are solutions of the problem:

$$\begin{aligned} & \max_{u_k \in \{0,1\}^T} \sum_{t=1}^T \left[\rho_k(t) + \alpha_k y(t, L_t^k) \right] u_k(t) \\ & \text{s.t. } \sum_{t=1}^T u_k(t) = R_k, \quad \forall t \in \mathcal{I}_k, u_k(t) = 0, \end{aligned}$$

In order to deal more abstractly with the bilevel model, we introduce the notation $u_k(t,l) = u_k(t) \mathbf{1}(L_t^k = l)$. Hence, we have $u_k(t,l) = 0$ if $L_t^k \neq l$. By defining the set $\mathcal{J}_k = \{(t,l) \mid t \in \mathcal{I}_k \text{ or } L_t^k \neq l\}$, we have that $(t,l) \in \mathcal{J}_k$ implies that $u_k(t,l) = 0$. We can then define $\rho_k(t,l) = \rho_k(t)/\alpha_k$ if $(t,l) \notin \mathcal{J}_k$ and $\rho_k(t,l) = -\infty$ otherwise. Then, we can rewrite each low-level problem as:

$$\max_{u_k \in F_k} \sum_{t,l} [\rho_k(t,l) + y(t,l)] u_k(t,l)$$

where $F_k = \{u \in \{0,1\}^{T \times L} \mid \sum_{t,l} u(t,l) = R_k \text{ and } \forall (t,l) \in \mathcal{J}_k, u(t,l) = 0\}$, and the global bilevel problem becomes:

$$\max_{y \in \mathbb{R}_+^{T \times L}} \sum_{t,l} f_l(N(t,l)) \quad \text{s.t. } \forall (t,l), N(t,l) \leq N_l^C, \quad N(t,l) = \sum_{k=1}^K u_k(t,l)$$

with

$$f_l : x \in \mathbb{R}_+ \mapsto xs_l(x) .$$

Notice that the set \mathcal{J}_k corresponds to the set of couples (t, l) such that $\rho_k(t, l) = -\infty$. It is possible to enumerate all the couples $(t, l) \in [T] \times [L]$. Let us define $n = T \times L$ and associate each couple (t, l) to an integer $i \in [n]$. The quantities $\rho_k(t, l)$, $u_k(t, l)$, $N(t, l)$ and $y(t, l)$ can be respectively denoted by $\rho_k(i)$, $u_k(i)$, N_i and y_i . The function f_l and the integer N_l^C can be respectively denoted by f_i and N_i^C . It means that for two indices i and j associated to two couples (t, l) and (t', l) with the same l , we have $f_i = f_j := f_l$ and $N_i^C = N_j^C := N_l^C$. The low-level problem can be rewritten:

Problem 7.3 (Abstract low-level problem).

$$\max_{u_k \in F_k} \sum_{i=1}^n [\rho_k(i) + y_i] u_k(i) \quad (7.3)$$

where $F_k = \{u \in \{0, 1\}^n \mid \sum_{i=1}^n u(i) = R_k \text{ and } \forall i \in \mathcal{J}_k, u(i) = 0\}$.

The global bilevel problem is:

Problem 7.4 (Bilevel problem).

$$\max_{y \in \mathbb{R}_+^n} \sum_{i=1}^n f_i(N_i) \quad s.t. \quad \forall i, N_i \leq N_i^C, \quad N_i = \sum_{k=1}^K u_k^*(i) \quad (7.4)$$

with for all $k \in [K]$, u_k^* solution of Problem 7.3.

Proposition 7.5. *Suppose that the functions s_i are decreasing and concave on $[0, N_i^C]$. Then, the functions f_i are also concave on $[0, N_i^C]$.*

Proof. The result comes easily if we suppose that the functions s_i are twice differentiable, because we have:

$$\forall x \in [0, N_i^C], f_i''(x) = xs_i''(x) + 2s_i'(x) \leq 0$$

. We could deduce that the same is true without the differentiability assumption by a density argument, writing a concave function as a pointwise limit of smooth concave functions. However, we prefer to provide the following elementary argument. Consider $0 \leq x \leq y \leq N_i^C$ and $t \in [0, 1]$. Because s_i is decreasing, we have $s_i(x) \geq s_i(y)$. We have:

$$\begin{aligned} tf_i(x) + (1-t)f_i(y) &= txs_i(x) + (1-t)ys_i(y) \\ &= (tx + (1-t)y) \left[\frac{tx}{tx + (1-t)y} s_i(x) + \frac{(1-t)y}{tx + (1-t)y} s_i(y) \right] \\ &\leq (tx + (1-t)y) s_i \left(\frac{tx^2 + (1-t)y^2}{tx + (1-t)y} \right) \end{aligned}$$

Because of the well-known inequality $2xy \leq x^2 + y^2$, we have:

$$\begin{aligned} (tx + (1-t)y)^2 &= t^2x^2 + (1-t)^2y^2 + 2t(1-t)xy \\ &\leq tx^2 + (1-t)y^2 \end{aligned}$$

Then, because s_i is decreasing, we have:

$$s_i \left(\frac{tx^2 + (1-t)y^2}{tx + (1-t)y} \right) \leq s_i(tx + (1-t)y)$$

so that:

$$tf_i(x) + (1-t)f_i(y) \leq (tx + (1-t)y)s_i(tx + (1-t)y) \leq f_i(tx + (1-t)y)$$

and f_i is concave. \square

An important remark is that Problem 7.4 is a particular case of Problem 6.17, studied in Chapter 6. We study first the tropical interpretation of the low-level problem in terms of arrangements of tropical hypersurfaces. Next, we adapt Theorem 6.18 to our problem. It states consequently that Problem 7.4 can be solved in polynomial time.

7.3.1 A tropical interpretation

The low-level component of Problem 7.4 can be studied thanks to tropical techniques. We first consider the relaxation in which the price vector y can take any real value, i.e. $y \in \mathbb{R}^n$. Each customer k defines his consumption u_k^* by solving the problem:

$$\max_{u_k \in F_k} \sum_i [\rho_k(i) + y_i] u_k(i) = \max_{u_k \in F_k} \langle \rho_k + y, u_k \rangle, \quad (7.5)$$

The map $P_k : y \mapsto \max_{u_k \in F_k} \langle \rho_k + y, u_k \rangle$ is convex, piecewise affine, and the gradients of its linear parts are integer valued. It can be thought of as a tropical polynomial function in the variable y . Indeed, with the tropical notation, we have

$$P_k(y) = \bigoplus_{u_k \in F_k} \left[\bigodot_{i \in [n]} (\rho_k(i) \odot y_i)^{\odot u_k(i)} \right]$$

where $z^{\odot p} := z \odot \dots \odot z = p \times z$ denotes the p th tropical power. In this way, we see that all the monomials of P_k have degree $\sum_i u_k(i) = R_k$, so that P_k is homogeneous of degree R_k , in the tropical sense. This remark leads to the following lemma:

Lemma 7.6. *Denote by $e = (1 \dots 1) \in \mathbb{R}^n$. Let y be a solution of the relaxation $y \in \mathbb{R}^n$ of Problem 7.4. Then, for all $\beta \in \mathbb{R}$, $y + \beta e$ is a solution of the relaxation $y \in \mathbb{R}^n$ of Problem 7.4.*

Proof. Consider a solution $y \in \mathbb{R}^n$ of the relaxed problem. Because P_k is homogeneous of degree R_k , we have for all $\beta \in \mathbb{R}$, $P_k(y + \beta e) = P_k(y) + \beta R_k$. In particular:

$$u_k^* \in \arg \max_{u_k \in F_k} \langle \rho_k + y, u_k \rangle \Leftrightarrow u_k^* \in \arg \max_{u_k \in F_k} \langle \rho_k + y + \beta e, u_k \rangle$$

Hence, $y + \beta e$ leads to the same repartition of the customers N^* and corresponds also to an optimal solution of the relaxed bilevel problem. \square

Corollary 7.7. *The bilevel problem 7.4 has the same value as its relaxation $y \in \mathbb{R}^n$.*

Proof. Consider a solution $y^* \in \mathbb{R}^n$ of the relaxed problem, and take $\beta \geq -\min_i y_i^*$. Then, we have $y^* + \beta e \in \mathbb{R}_+^n$ and solution of the relaxed problem according to Lemma 7.6. Consequently, $y^* + \beta e$ is a solution of Problem 7.4. \square

By definition, the *tropical hypersurface* associated to a tropical polynomial function is the nondifferentiability locus of this function. Since the monomial P_k is homogeneous, its associated tropical hypersurface is invariant by the translation by a constant vector. Therefore, it can be represented as a subset of the tropical projective space \mathbb{TP}^{n-1} . The latter is defined as the quotient of \mathbb{R}^n by the equivalence relation which identifies two vectors which differ by a constant vector, and it can be identified to \mathbb{R}^{n-1} by the map $y \in \mathbb{TP}^{n-1} \mapsto (y_i - y_n)_{i \in [n-1]} \in \mathbb{R}^{n-1}$.

Example 7.8. Consider a simple example with $T = 3$ time steps (for instance morning, afternoon and evening), $L = 1$ (that is $n = 3$), $K = 5$ and $\mathcal{J}_k = \emptyset$ for each k . The parameters of the customers are

$$\begin{aligned} \rho_1 &= [0, 0, 0], R_1 = 1, & \rho_2 &= [0, -1, 0], R_2 = 2, \\ \rho_3 &= [-1, 1, 0], R_3 = 1 & \rho_4 &= [1/2, 1/2, 0], R_4 = 2, \\ \rho_5 &= [1/2, 2, 0], R_5 = 1. \end{aligned}$$

The tropical polynomial of the first customer is $P_1(y) = \max(y_1, y_2, y_3)$, meaning that this customer has no preference and consumes when the incentive is the best. Its associated tropical hypersurface is a tropical line (since P_1 has degree 1), so it splits \mathbb{TP}^2 in three different regions corresponding to a choice of the vector u_1 among $(1, 0, 0)$, $(0, 1, 0)$ and $(0, 0, 1)$, see Figure 7.2. E.g., the cell labeled by $(1, 0, 0)$ represents a consumption concentrated the morning, induced by a price $y_1 > y_2$ and $y_1 > y_3$.

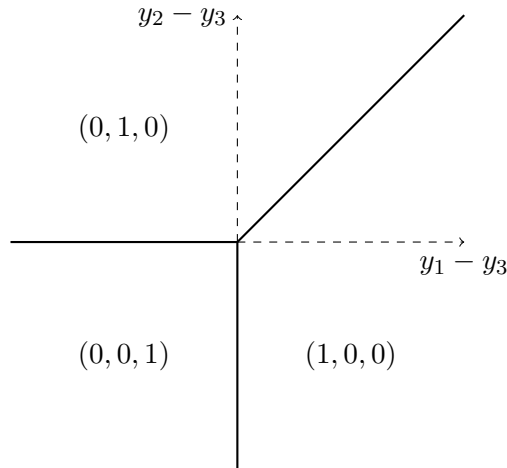

Figure 7.2: A customer response: a tropical line splits the projective space into three cells. Each cell corresponds to a possible customer response

To study jointly the responses of the five customers, we represent the arrangement of the tropical hypersurfaces associated to the P_k , $k \in [5]$ (see Figure 7.3), with

$$\begin{aligned} P_2(y) &= \max(y_1 + y_2 - 1, y_1 + y_3, y_2 + y_3 - 1), \\ P_3(y) &= \max(y_1 - 1, y_2 + 1, y_3), \\ P_4(y) &= \max(y_1 + y_2 + 1, y_1 + y_3 + 1/2, y_2 + y_3 + 1/2), \\ P_5(y) &= \max(y_1 + 1/2, y_2 + 2, y_3). \end{aligned}$$

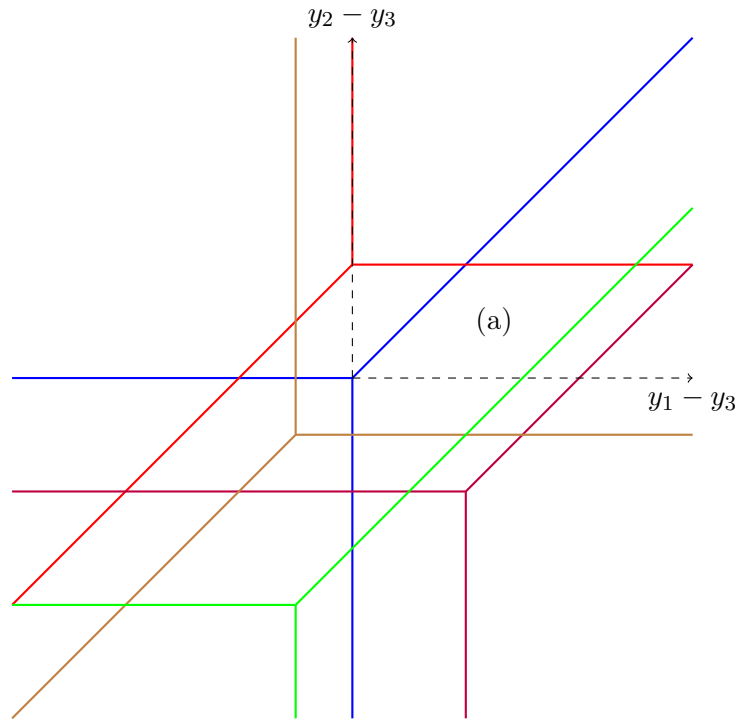

Figure 7.3: Arrangement of tropical hypersurfaces: each tropical hypersurface corresponds to a customer response. For example, the cell (a) corresponds to discounts y with responses (1,0,0) for customer 1, (1,0,1) for customer 2, (0,1,0) for customer 3, (1,1,0) for customer 4 and (0,1,0) for customer 5. Hence, the total number of customers in the network with these discounts is (3,3,1).

Lemma 7.9 (Corollary of [TY15, §4, Lemma 3]). *Each cell of the arrangement of tropical hypersurfaces corresponds to a collection of customers responses (u_1, \dots, u_K) and to an unique traffic vector N , defined by $N = \sum_k u_k$.*

7.3.2 Decomposition theorem

We next show that the present bilevel problem belongs to the subclass studied in Section 6.3.1. We prove that Theorem 6.18 can be applied, that is Problem 7.4 can be solved by decomposition.

We note that the function to optimize for the high-level problem of Problem 7.4, i.e. the optimization problem of the provider, depends only on N . The variables y_i allow one to generate the different possible vectors N .

Definition 7.10. A vector $N \in \mathbb{Z}^n$ is said to be *feasible* if there exists K vectors u_1^*, \dots, u_K^* such that $N = \sum_{k=1}^K u_k^*$ and there exists $y \in \mathbb{R}^n$ such that for each $k \in [K]$, $u_k^* \in \arg \max_{u_k \in F_k} \langle \rho_k + y, u_k \rangle$.

So, we will characterize the feasible vectors N in order to optimize directly the satisfaction function on the set of feasible N . This idea is motivated by the tropical approach thanks to Lemma 7.9. In Section 6.3.1, we developed a similar approach to solve a certain class of bilevel problems, of the following form:

$$\min_{y \in \mathbb{R}^n} f(z^*), \quad (7.6)$$

with $z^* = \sum_{j=1}^q x^{j*}$ and for all $j \in [q]$, x^{j*} solution of:

$$\max_{x^j \in \mathcal{P}^j \cap \mathbb{Z}^n} \langle \rho^j + y, x^j \rangle. \quad (7.7)$$

We define the relaxation of Problem 7.4 to the case $y \in \mathbb{R}^n$.

Problem 7.11 (Bilevel problem with real discounts).

$$\max_{y \in \mathbb{R}^n} \sum_{i=1}^n f_i(N_i) \quad s.t. \quad \forall i, N_i \leq N_i^C,$$

with $N = \sum_{k=1}^K u_k^*$ and for all $k \in [K]$, u_k^* solution of:

$$\max_{u_k \in F_k} \langle \rho_k + y, u_k \rangle.$$

According to Corollary 7.7, Problem 7.4 has the same value than the relaxation problem 7.11. Moreover, according to Lemma 7.6, if (y^*, N^*) is an optimal solution of Problem 7.11, then $(y^* + \beta e, N^*)$ is also an optimal solution of Problem 7.11 for every $\beta \in \mathbb{R}$. We recall that $e \in \mathbb{R}^n$ is a vector defined by $e^T = (1, \dots, 1)$. Then, if we find an optimal solution (y^*, N^*) of Problem 7.11, then $(y^* + \beta e, N^*)$ with $\beta = -\min_{i \in [n]} y_i^*$ is a solution of Problem 7.11 such that $y^* + \beta e \in \mathbb{R}_+^n$. Consequently, $(y^* + \beta e, N^*)$ is a solution of Problem 7.4. Hence, a solution of Problem 7.11 (with real discounts) provides a solution of Problem 7.4 (with nonnegative discounts). In the sequel, we will study the bilevel problem 7.11.

We next state that Problem 7.11 can be solved by the decomposition method introduced in Section 6.3.1. We recall that the convex characteristic function χ_A of a set $A \subset \mathbb{R}^n$ is defined by $\chi_A(x) = 0$ if $x \in A$, and $\chi_A(x) = +\infty$ otherwise. If A is a convex set, then χ_A is a convex function. Moreover, we define also for every k the polytope \mathcal{P}_k by:

$$\mathcal{P}_k = \{u \in [0, 1]^n \mid \sum_{i=1}^n u(i) = R_k \text{ and } \forall i \in \mathcal{J}_k, u(i) = 0\}.$$

We notice that for every $k \in [K]$, $\mathcal{P}_k \cap \mathbb{Z}^n = F_k$. We also define for every $k \in [K]$ the convex function φ_k defined by $\varphi_k(u) = -\langle \rho_k, u \rangle + \chi_{\Delta_k}(u)$.

Proposition 7.12. *Problem 7.11 is a particular case of Problem 6.17.*

Proof. For every $k \in [K]$, F_k is the set of integer points of the polytope \mathcal{P}_k . Hence, the low-level problem of Problem 7.11 is a special case of the low-level problem of Problem 6.17. Moreover, the high-level problem of Problem 7.11 consists in minimizing the function $-f + \sum_{i=1}^n \chi_{N_i \leq N_i^C}(N_i)$, where $\chi_{N_i \leq N_i^C}(x) = 0$ if $N_i \leq N_i^C$ and $+\infty$ otherwise. It is hence a special case of the high-level part of Problem 6.17. \square

In order to apply Theorem 6.18 to Problem 7.11, we have to show that for every $k \in [K]$, \mathcal{P}_k is defined by totally unimodular matrices, and that $\sum_k (\mathcal{P}_k \cap \mathbb{Z}^n) = (\sum_k \mathcal{P}_k) \cap \mathbb{Z}^n$.

Lemma 7.13. *For every $k \in [K]$, \mathcal{P}_k can be written as $\mathcal{P}_k = \{u \in [0, 1]^n \mid A_k u = b_k\}$, where A_k is a totally unimodular matrix. Moreover,*

$$\sum_k F_k = \left(\sum_k \mathcal{P}_k \right) \cap \mathbb{Z}^n.$$

Proof. Let $k \in [K]$. The polytope \mathcal{P}_k is of the form:

$$\mathcal{P}_k = \{u \in [0, 1]^n \mid e^T u = R_k, \forall i \in \mathcal{J}_k, u_i = 0\},$$

with $e^T = (1, \dots, 1)$ and $R_k \in \mathbb{Z}$. Because all the entries of e are equal to 1, \mathcal{P}_k is defined by a totally unimodular matrix.

Moreover, each set F_k is a M -convex set. In fact, take $u, u' \in F_k$ and an index i such that $u_i > u'_i$. Then, $u_i = 1$ and $u'_i = 0$. Since, the sum of the entries of u and u' is equal to R_k , there exists an index j such that $u_j = 0$ and $u'_j = 1$. We have directly that $u - e_i + e_j$ and $u' + e_i - e_j$ are in F_k . Then, the projection of the n first entries of F_k defines a M^{\natural} -convex set. The statement comes from [CLV08, Th.2.10]. \square

According to Lemma 7.13, Theorem 6.18 can be applied to solve Problem 7.11. Let \mathcal{S} be the polyhedral complex associated to the tropical hypersurface $\mathcal{T}(P)$ with $P = \odot_k P_k$. The tropical polynomial P is hence defined by:

$$\begin{aligned} P(y) &= \sum_{k=1}^K \max_{u_k \in F_k} \langle \rho_k + y, u_k \rangle = \max_{u_1 \in F_1, \dots, u_K \in F_K} \sum_{k=1}^K \langle \rho_k + y, u_k \rangle \\ &= \max_{N \in \sum_k F_k} [\langle y, N \rangle - \psi(N)], \end{aligned}$$

where:

$$\psi(N) = \min_{\substack{u_1 \in F_1, \dots, u_K \in F_K \\ \sum_k u_k = N}} \sum_k -\langle \rho_k, u_k \rangle. \quad (7.8)$$

We define \mathcal{S}' as the subdivision of the Newton polytope of P , which is dual to \mathcal{S} (see Section 3.3). Let ϕ be the bijection between the cells of \mathcal{S} and those of \mathcal{C}' . For $y \in \mathbb{R}^n$, we define $\mathcal{C}_y = \cap \{\mathcal{C} \in \mathcal{S} \mid y \in \mathcal{C}\}$. Similarly, for $N \in \sum_k \mathcal{P}_k$, we define $\mathcal{C}'_N = \cap \{\mathcal{C}' \in \mathcal{S}' \mid N \in \mathcal{C}'\}$.

Proposition 7.14. *Let $y^* \in \mathbb{R}^n$ and $N^* \in \sum_k F_k$. Then (y^*, N^*) is an optimal solution of Problem 7.11 if and only if:*

$$N^* \in \arg \max_{N \in \sum_k F_k} f(N) \quad \text{s.t } \forall i \in [n], N_i \leq N^{\mathcal{C}},$$

and $y^* \in \phi^{-1}(\mathcal{C}'_{N^*})$.

Proof. We apply Theorem 6.18 to Problem 7.11. The condition:

$$N^* \in \arg \min_{N \in \sum_k (\mathcal{P}_k \cap \mathbb{Z}^n)} -f(N) + \sum_{i=1}^n \chi_{N_i \leq N^{\mathcal{C}}}(N_i)$$

is equivalent to:

$$N^* \in \arg \max_{N \in \sum_k F_k} f(N) \quad \text{s.t } \forall i \in [n], N_i \leq N^{\mathcal{C}}.$$

\square

We next explain how to find a vector $y^* \in \phi^{-1}(\mathcal{C}'_{N^*})$ for a fixed $N^* \in \sum_k F_k$. We notice that $\phi^{-1}(\mathcal{C}'_{N^*})$ is a cell of the polyhedral complex \mathcal{S} . Hence, the condition $y^* \in \phi^{-1}(\mathcal{C}'_{N^*})$ means that y^* belongs to a polyhedron. We first characterize this polyhedron by inequalities.

Lemma 7.15. *Let $N^* \in \sum_k F_k$. Then, $y^* \in \phi^{-1}(\mathcal{C}'_{N^*})$ if and only if:*

$$N^* \in \arg \max_{N \in \sum_k F_k} \langle y, N \rangle - \psi(N).$$

Proof. Problem 7.11 belongs more generally to the subclass of integer bilevel problems studied in Section 4.2.3, as explained in Section 6.1.

Hence, the condition $y^* \in \phi^{-1}(\mathcal{C}'_{N^*})$ is equivalent to $N^* \in \phi(\mathcal{C}_{y^*}) \cap \mathbb{Z}^n$, which is equivalent to $N^* \in \arg \max_{N \in \sum_k F_k} \langle y, N \rangle - \psi(N)$ by applying Lemma 4.31 to Problem 7.11. \square

Lemma 7.16. *Let $N^* \in \sum_k F_k$ and $y \in \mathbb{R}^n$. The following assertions are equivalent.*

1. $N^* \in \arg \max_{N \in \sum_k F_k} \langle y, N \rangle - \psi(N)$.
2. *There exists for every $k \in [K]$ a vector $u_k^* \in F_k$ such that $N^* = \sum_k u_k^*$ and:*

$$(u_1^*, \dots, u_K^*) \in \arg \max_{\substack{u_1 \in F_1, \dots, u_K \in F_K \\ \sum_k u_k = N^*}} \sum_k \langle \rho_k, u_k \rangle$$

$$\forall k \in [K], u_k^* \in \arg \max_{u_k \in F_k} \langle \rho_k + y, u_k \rangle.$$

Proof. 1 \Rightarrow 2: Suppose that $N^* \in \arg \max_{N \in \sum_k F_k} \langle y, N \rangle - \psi(N)$. Consider for every $k \in [K]$ a vector $u_k^* \in F_k$ such that:

$$(u_1^*, \dots, u_K^*) \in \arg \max_{\substack{u_1 \in F_1, \dots, u_K \in F_K \\ \sum_k u_k = N^*}} \sum_k \langle \rho_k, u_k \rangle.$$

Let $(u_1, \dots, u_K) \in F_1 \times \dots \times F_K$, and $N = \sum_k u_k$. Then $-\psi(N) \leq \sum_k \langle \rho_k, u_k \rangle$. Then:

$$\begin{aligned} \sum_k \langle \rho_k + y, u_k^* \rangle &= \langle y, N^* \rangle + \sum_k \langle \rho_k, u_k^* \rangle = \langle y, N^* \rangle - \psi(N^*) \\ &\geq \langle y, N \rangle - \psi(N) = \sum_k \langle \rho_k + y, u_k \rangle. \end{aligned}$$

Consequently,

$$(u_1^*, \dots, u_K^*) \in \arg \max_{u_1 \in F_1, \dots, u_K \in F_K} \sum_k \langle \rho_k + y, u_k \rangle.$$

It follows that for every $k \in [K]$, $u_k^* \in \arg \max_{u_k \in F_k} \langle \rho_k + y, u_k \rangle$.

2 \Rightarrow 1: Let $N \in \sum_k F_k$ and $(u_k)_{k \in [K]}$ such that $\psi(N) = -\sum_k \langle \rho_k, u_k \rangle$. We have $\psi(N^*) = -\sum_k \langle \rho_k, u_k^* \rangle$, and:

$$\forall k \in [K], \langle \rho_k + y, u_k^* \rangle \geq \langle \rho_k + y, u_k \rangle.$$

By summing these inequalities K inequalities, we have $\langle y, N^* \rangle - \psi(N^*) \geq \langle y, N \rangle - \psi(N)$. \square

The previous lemmas allow us to rewrite Proposition 7.14 so that the optimal solutions of Problem 7.11 (bilevel problem with real discounts) are obtained by solving successively different optimization problems.

Theorem 7.17. (Decomposition) *The bilevel problem 7.11 can be solved as follows:*

1. Find an optimal solution N^* to the high level problem with unknown N :

$$\max_{N \in \sum_k F_k} \sum_{i=1}^n f_i(N_i) \quad s.t. \quad \forall i, N_i \leq N_i^C. \quad (7.9)$$

2. Find vectors (u_1^*, \dots, u_K^*) solutions of the following problem:

$$\max_{\substack{u_1 \in F_1, \dots, u_K \in F_K \\ \sum_k u_k = N^*}} \sum_k \langle \rho_k, u_k \rangle.$$

3. Find a vector y^* such that $\forall k, u_k^*$ is a solution of the low level problem.

Proof. It comes from Proposition 7.12 together with Lemma 7.15 and Lemma 7.16. \square

Complexity of the decomposition method We next study how to use the decomposition Theorem 7.17 to solve Problem 7.11. The bilevel problem is decomposed in three one-level optimization subproblems. We next show that we can solve these three subproblems in polynomial time, meaning that Theorem 7.17 leads to a polynomial time algorithm for the bilevel problem 7.11 with real discounts.

We first show that the second step of the Theorem 7.17 consists in solving a linear program.

Lemma 7.18. *Let $N^* \in \sum_k F_k$. Then :*

$$\arg \max_{\substack{u_1 \in F_1, \dots, u_K \in F_K \\ \sum_k u_k = N^*}} \sum_k \langle \rho_k, u_k \rangle = \left(\arg \max_{\substack{u_1 \in \mathcal{P}_1, \dots, u_K \in \mathcal{P}_K \\ \sum_k u_k = N^*}} \sum_k \langle \rho_k, u_k \rangle \right) \cap \mathbb{Z}^{K+n}.$$

Proof. We have:

$$\arg \max_{\substack{u_1 \in F_1, \dots, u_K \in F_K \\ \sum_k u_k = N^*}} \sum_k \langle \rho_k, u_k \rangle = \arg \max_{\substack{u_1 \in \mathcal{P}_1, \dots, u_K \in \mathcal{P}_K \\ \sum_k u_k = N^* \\ u_1, \dots, u_K \in \mathbb{Z}^n}} \sum_k \langle \rho_k, u_k \rangle.$$

This means that we have to solve an integer linear program. The continuous linear program can be rewritten:

$$\max_{\substack{u \in [0,1]^{K+n}, Au=b \\ \forall i \in \mathcal{J}, u(i)=0}} \rho^T u,$$

with $\mathcal{J} = \cup_k \mathcal{J}_k$, $\rho^T = [\rho_1^T \dots \rho_K^T]$, and $A \in \mathcal{M}_{K+n, K+n}(\mathbb{Z})$, $b \in \mathbb{Z}^{K+n}$ defined by :

$$A = \begin{pmatrix} 1 & 1 & \dots & 1 & 0 & 0 & \dots & 0 & \dots & 0 & 0 & \dots & 0 \\ 0 & 0 & \dots & 0 & 1 & 1 & \dots & 1 & \dots & 0 & 0 & \dots & 0 \\ & & & & & & \dots & & & & & & \\ 0 & 0 & \dots & 0 & 0 & 0 & \dots & 0 & \dots & 1 & 1 & \dots & 1 \\ -1 & 0 & \dots & 0 & -1 & 0 & \dots & 0 & \dots & -1 & 0 & \dots & 0 \\ 0 & -1 & \dots & 0 & 0 & -1 & \dots & 0 & \dots & 0 & -1 & \dots & 0 \\ & & & & & & \dots & & & & & & \\ 0 & 0 & \dots & -1 & 0 & 0 & \dots & -1 & \dots & 0 & 0 & \dots & -1 \end{pmatrix} \quad \text{and } b = \begin{pmatrix} R_1 \\ R_2 \\ \dots \\ R_K \\ -N_1 \\ -N_2 \\ \dots \\ -N_n \end{pmatrix}.$$

In each column, A has two non-zero entries, one being equal to 1 and the other one to -1 . By Poincaré lemma, A is totally unimodular. Then,

$$\arg \max_{\substack{u \in [0,1]^{K^n}, Au=b \\ \forall i \in \mathcal{J}, u(i)=0 \\ u \in \mathbb{Z}^{K^n}}} \rho^T u = \left(\arg \max_{\substack{u \in [0,1]^{K^n}, Au=b \\ \forall i \in \mathcal{J}, u(i)=0}} \rho^T u \right) \cap \mathbb{Z}^{K^n}.$$

The statement of the lemma follows. \square

We next show that the third step reduces to a linear feasibility problem.

Lemma 7.19. *Let $N^* \in \sum_k F_k$ and $u_k^* \in F_k$ ($k \in [K]$) be vectors such that $N^* = \sum_k u_k^*$ and $\psi(N^*) = -\sum_k \langle \rho_k, u_k^* \rangle$. Then, the set of vectors $y^* \in \mathbb{R}^n$ such that for every $k \in [K]$, $u_k^* \in \arg \max_{u_k \in F_k} \langle \rho_k + y^*, u_k \rangle$ is non-empty and is the polytope defined by the following inequalities:*

$$\forall k \in [K], \forall i, j \notin \mathcal{J}_k, \text{ such that } u_k^*(i) = 1, u_k^*(j) = 0, \rho_k(i) + y_i^* \geq \rho_k(j) + y_j^*$$

Proof. If $N^* \in \sum_k F_k$, then there exists $y^* \in \mathbb{R}^n$ such that $N^* \in \arg \max_{N \in \sum_k F_k} \langle y, N \rangle - \psi(N)$ by Lemma 7.15. According to Lemma 7.16, we have for every $k \in [K]$, $u_k^* \in \arg \max_{u_k \in F_k} \langle \rho_k + y^*, u_k \rangle$.

Consider indices $i, j \notin \mathcal{J}_k$ with $u_k^*(i) = 1, u_k^*(j) = 0$, and the vector u_k defined by $u_k(i) = 0, u_k(j) = 1$ and $\forall l \neq i, j, u_k(l) = u_k^*(l)$. We verify easily $u_k \in F_k$, so that the condition $\langle \rho_k + y^*, u_k^* \rangle \geq \langle \rho_k + y^*, u_k \rangle$, which can be rewritten $\rho_k(i) + y_i^* \geq \rho_k(j) + y_j^*$, is satisfied.

Moreover, this condition is sufficient. Consider y^* such that $\forall i, j \notin \mathcal{J}_k$ with $u_k^*(i) = 1, u_k^*(j) = 0$, we have $\rho_k(i) + y_i^* \geq \rho_k(j) + y_j^*$. Consider $u_k \in F_k$. By definition of F_k , the quantity $\langle \rho_k + y^*, u_k \rangle$ corresponds to the sum of R_k coordinates of $\rho_k + y^*$ for which the index is not in \mathcal{J}_k . Hence,

$$\begin{aligned} \langle \rho_k + y^*, u_k \rangle &= \sum_{i, u_k(i)=1, u_k^*(i)=1} (\rho_k(i) + y_i^*) + \sum_{j, u_k(j)=1, u_k^*(j)=0} (\rho_k(j) + y_j^*) \\ &\leq \sum_{i, u_k(i)=1, u_k^*(i)=1} (\rho_k(i) + y_i^*) + \sum_{j, u_k(j)=0, u_k^*(j)=1} (\rho_k(j) + y_j^*) = \langle \rho_k + y^*, u_k^* \rangle \end{aligned}$$

because of the lemma hypothesis and because $\#\{j | u_k(j) = 1, u_k^*(j) = 0\} = \#\{j | u_k(j) = 0, u_k^*(j) = 1\}$. \square

For every k , the latter inequalities define a polytope, and we have to find y^* in the intersection of all these polytopes.

We next explain how to solve the first step of Theorem 7.17. We will use some elements of discrete convexity developed by Murota [Mur03] (see Section 3.4). We show that the first step of Theorem 7.17 is a M -concave maximization problem, what can be done in polynomial time.

Lemma 7.20. *The feasible domain of the high-level program $B = \{N \in \sum_k F_k | \forall i N_i \leq N_i^C\}$ is a M -convex set of \mathbb{Z}^n .*

Proof. We can easily check that $\forall k$, the set F_k is M -convex. See in the proof of Lemma 7.13. It is known that a Minkowski sum of M -convex sets is M -convex [Mur03, Th. 4.23, p.115], and so the set $\sum_k F_k$ is M -convex.

Finally, consider two vectors N and N' of B . They belong to $\sum_k F_k$, so for each i with $N_i > N'_i$, we can find j with $N_j < N'_j$ such that $N - e_i + e_j$ and $N' + e_i - e_j$ are in $\sum_k F_k$. The i -th coordinate of $N - e_i + e_j$ is $N_i - 1 < N_i \leq N_i^C$ and the j -th coordinate of $N - e_i + e_j$ is $N_j + 1 \leq N'_j \leq N_j^C$. So $N - e_i + e_j \in B$ and similarly $N' + e_i - e_j \in B$, which proves the M -convexity of B . \square

If B is a M -convex set, then χ_B is a M -convex function (we recall that $\chi_B : \mathbb{Z}^n \mapsto \mathbb{R}$ is defined by $\chi_B(x) = 0$ if $x \in B$ and $\chi_B(x) = +\infty$ otherwise). An important property of M -convex functions is that local optimality guarantees global optimality [Mur03, Th. 6.26, p.148] in the following sense. Let g be a M -convex function and $x \in \mathbb{Z}^n$. Then $g(x) = \min_{y \in \mathbb{Z}^n} g(y)$ if and only if $\forall i, j \in [n]$, $g(x) \leq g(x - e_i + e_j)$.

According to Theorem 7.17, we have to solve $\max_{N \in \mathbb{Z}^n} f(N) - \chi_B(N)$, where $f : N \mapsto \sum_i f_i(N_i)$ is a separable concave function, and B is the M -convex set introduced in Lemma 7.20. The function $f - \chi_B$ is M -concave [Mur03, Th. 6.13.(4), p.143].

Murota [Mur03, Section 10.1] gives different algorithms to minimize a M -convex function in polynomial time, if an initial point is given and if the domain of the function is bounded. Whereas it is easy to find a vector of \mathbb{Z}^n such that $\forall_i, N_i \leq N_i^C$ or a vector N belonging to $\sum_k F_k$, it is not obvious to find one satisfying both conditions. In fact, such a point can be obtained by solving the minimization problem:

$$\min_{N \in \sum_k F_k} \sum_i \max(N_i - N_i^C, 0)$$

The condition $N \in B$ is equivalent to $N \in \arg \min_{N \in \sum_k F_k} \sum_i \max(N_i - N_i^C, 0)$ if B is non-empty. The function $N \mapsto \sum_i \max(N_i - N_i^C, 0)$ is separable convex. Then, the function $N \mapsto M \sum_i \max(N_i - N_i^C, 0) + \chi_{\sum_k F_k}$ is M -convex according to [Mur03, Th. 6.13.(4), p.148]. Because $\sum_k F_k$ is bounded and a point in $\sum_k F_k$ can be obtained in $O(Kn)$ operations by summing vectors taken in each set F_k , it is possible to find a point $N^0 \in \arg \min_{N \in \sum_k F_k} \sum_i \max(N_i - N_i^C, 0) = B$ in polynomial time by Proposition 3.22.

We can finally write the following result about the complexity of the decomposition method given by Theorem 7.17.

Theorem 7.21. *Let $R = \sum_k R_k$, for every $k \in [K]$, $n_k = n - \#\mathcal{J}_k$ and $\bar{R} = \sum_k R_k(n_k - R_k)$. An optimal solution of Problem 7.11 can be obtained in $O((Kn)^{3.5} Ln^3 \log^2(K/n) + (n + \bar{R})^{3.5} L)$ arithmetic operations, where L is the input size of the bilevel problem.*

Proof. The first step of Theorem 7.17 is a maximization of a M -concave function over a bounded domain B . Finding a point in B can be done by solving the M -convex minimization problem:

$$\min_{N \in \sum_k F_k} \sum_i \max(N_i - N_i^C, 0)$$

The domain of the function $N \mapsto \sum_i \max(N_i - N_i^C, 0) + \chi_{\sum_k F_k}$ is $\sum_k F_k$. We define K_∞^1 by:

$$K_\infty^1 = \max\{\|N - N'\|_\infty \mid N, N' \in \sum_k F_k\}$$

For every $N \in \sum_k F_k$, the entries of N are sum of K binary values. Then, $K_\infty^1 \leq K$. We have to estimate the number of operations F^1 needed to evaluate the function $N \mapsto \sum_i \max(N_i -$

$N_i^C, 0) + \chi_{\sum_k F_k}$. The function $N \mapsto \sum_i \max(N_i - N_i^C, 0)$ can be evaluated in $O(n)$ operations. As explained in Lemma 7.13, $\sum_k F_k = (\sum_k \mathcal{P}_k) \cap \mathbb{Z}^n$. Hence, for any vector N , the conditions $N \in \sum_k F_k$ is equivalent to $N \in (\sum_k \mathcal{P}_k) \cap \mathbb{Z}^n$. A vector N belongs to $\sum_k \mathcal{P}_k$ if there exists for every $k \in [K]$ a vector $u_k \in \mathcal{P}_k$ such that $\sum_k u_k = N$. Hence, to know whether N belongs to $\sum_k \mathcal{P}_k$ or not is a linear feasibility problem in dimension Kn , It can be solved in $O((Kn)^{3.5}L)$ arithmetic operations by an interior point method ([Ren88]). Here L is the input size of the linear program. Consequently, $F^1 = O((Kn)^{3.5}L)$, and a point in B can be obtained in $O((Kn)^{3.5}Ln^3 \log^2(K/n))$ by Proposition 3.22.

After obtaining a point in B , the first step of Theorem 7.17 consists in solving the M -concave maximization problem:

$$\max_{N \in B} \sum_i f_i(N_i).$$

The domain of the function $N \mapsto \sum_i f_i(N_i) - \chi_B(N)$ is bounded and equal to B . We define K_∞^2 by:

$$K_\infty^2 = \max\{\|N - N'\|_\infty \mid N, N' \in B\}$$

For every $N \in \sum_k N_k$, the entries of N are sum of K binary values. Then, for every $i \in [n]$, we have $N_i \leq \min(K, N_i^C)$. Then, $K_\infty^2 \leq \min(K, \bar{N}^C)$, with $\bar{N}^C = \max_{i \in [n]} N_i^C$. The number of operations F^2 needed to evaluate the function $N \mapsto \sum_i \max(N_i - N_i^C, 0) - \chi_B(N)$ is $O((Kn)^{3.5}L)$ like previously. Hence, a point $N^* \in \arg \max_{N \in B} \sum_i f_i(N_i)$ can be obtained in $O((Kn)^{3.5}Ln^3 \log^2(\min(K, \bar{N}^C)/n))$ by Proposition 3.22.

According to Lemma 7.18, the second step of Theorem 7.17 is a linear program in dimension Kn . Hence, it can be solved in $O((Kn)^{3.5}L)$ arithmetic operations.

The third step of Theorem 7.17 is a linear program in n variables. For some $u_k^* \in F_k$, the constraints of this program are:

$$\forall k \in [K], \forall i, j \notin \mathcal{J}_k, \text{ such that } u_k^*(i) = 1, u_k^*(j) = 0, \rho_k(i) + y_i^* \geq \rho_k(j) + y_j^*.$$

For every $k \in [K]$, the number of entries of u_k^* equal to 1 is R_k , and the number of entries of u_k^* equal to 0 and which do not belong to \mathcal{J}_k is n_k . Hence, the number of inequality constraints of this linear program is $\sum_k R_k(n_k - R_k) = \bar{R}$. Hence, a solution of this linear program can be found in $O((n + \bar{R})^{3.5}L)$ by interior-point methods. \square

7.4 An efficient algorithm for solving the bilevel problem

7.4.1 A polynomial time algorithm for the bilevel problem

Theorem 7.21 shows that the decomposition method provides a polynomial time algorithm for solving Problem 7.11. In the worst case, we have $n_k = n$ and $\bar{R} = \frac{Kn^2}{4}$. Hence, the complexity given by Theorem 7.21 depends on K in $K^{3.5}$.

We deal with problems with large values of K (the number of customers in the network). Hence, in this section, we look for more efficient algorithms, in which the exponent of K in the complexity can be as small as possible.

Algorithm 1 can be applied to solve problem (7.9) of Theorem 7.17, that is maximizing the M -concave function $f - \chi_B$, or equivalently minimizing the M -convex function $-f + \chi_B$.

Step 1 consists in finding an initial vector $N \in B$. Whereas it is trivial to find a vector of \mathbb{Z}^n such that $\forall_i, N_i \leq N_i^C$ or a vector in $N \in \sum_k F_k$, it is not obvious to find one satisfying both

conditions. In fact, it is possible to replace the function $f - \chi_B$ by $g : N \mapsto f(N) - \chi_{\sum_k F_k}(N) - M \sum_i \max(N_i - N_i^C, 0)$, where $M > 0$ is an integer. If $N \in B$, then $g(N) = f(N)$. If M is sufficiently large, then $M \sum_i \max(N_i - N_i^C, 0) \geq M$ if $N \notin B$, and the maximum of the function g is attained for $N \in B$. Moreover $N \mapsto M \sum_i \max(N_i - N_i^C, 0)$ is separable convex, then g is M -concave according to [Mur03, Th. 6.13.(4), p.148]. Then, we apply Algorithm 1 the to function g to solve the problem $\max_{N \in B} f(N)$.

A first part is to determine the number F of operations to evaluate g . Because the different functions f_i are known, we have to determine the number of operations to decide whether a vector N belongs to $\sum_k F_k$ or not. More precisely, the different evaluations of $f - \chi_B$ are done in Step 2. Hence, the question is the following: given a vector $N \in \sum_k F_k$, how many operations are needed to check whether $N - e_i + e_j$ (for $i, j \in [n]$) belongs to $\sum_k F_k$. However, this problem can be studied as a shortest path problem in a graph. Consider $N \in \sum_k F_k$ and let us define $u_k^* \in F_k$ for $k \in [K]$ such that $\psi(N) = \sum_k \langle \rho_k, u_k^* \rangle$, that is the optimal decomposition of N in Theorem 7.17. For each $k \in [K]$ and $\alpha, \beta \in [n]$, we define by $w_{\alpha\beta}^k$ the following quantity: $w_{\alpha\beta}^k = \rho_k(\alpha) - \rho_k(\beta)$ if $u_k^*(\alpha) = 1$ and $u_k^*(\beta) = 0$, and $w_{\alpha\beta}^k = +\infty$ otherwise. Then, we define for each $\alpha, \beta \in [n]$, $w_{\alpha\beta} = \min_{k \in [K]} w_{\alpha\beta}^k$. We consider the oriented valuated graph $G = (V, E)$ where the set of vertices $V = [n]$ and there is an oriented edge between each vertices $\alpha, \beta \in V$ of value $w_{\alpha\beta}$.

Theorem 7.22. *Let $i, j \in [n]$. Suppose that there exists a path in G with finite valuation between the vertices $i, j \in V$. Then $N - e_i + e_j \in \sum_k F_k$. Moreover, there are no negative cycles and there is a shortest path between i and j . Let $(\alpha_u)_{0 \leq u \leq p}$ be any sequence such that $\alpha_0 = i$, $\alpha_p = j$ and let $\alpha_0 \rightarrow \alpha_1 \dots \alpha_{p-1} \rightarrow \alpha_p$ be a shortest path between i and j . Let also $(k_u)_{0 \leq u \leq p-1}$ be any sequence such that $w_{\alpha_u \alpha_{u+1}}^{k_u} = w_{\alpha_u \alpha_{u+1}}$ for all $0 \leq u \leq p-1$. Let us finally define the vectors v_k^* , $k \in [K]$ such that $v_{k_u}^* = u_{k_u}^* - e_{\alpha_u} + e_{\alpha_{u+1}}$ for each $0 \leq u \leq p-1$ and $v_k^* = u_k^*$ for each $k \notin \{k_0, \dots, k_{p-1}\}$. Then, $\psi(N - e_i + e_j) = \sum_k \langle \rho_k, v_k^* \rangle$.*

Proof. If $N - e_i + e_j \in \sum_k F_k$, then $N - e_i + e_j = \sum_k v_k^*$ with each $v_k^* \in F_k$ and $\psi(N - e_i + e_j) = -\sum_k \langle \rho_k, v_k^* \rangle$. This is a consequence of Lemma 7.16 and Lemma 4.31. We consider $\psi(N) = -\sum_k \langle \rho_k, u_k^* \rangle$ with each $u_k^* \in F_k$. Hence, $\psi(N - e_i + e_j) - \psi(N)$ is equal to:

$$\min_{v_k \in F_k \text{ and } \sum_k v_k = N - e_i + e_j} \sum_k \langle \rho_k, u_k^* - v_k \rangle.$$

We have $\sum_k (u_k^* - v_k) = e_i - e_j$. When v_k describes F_k , the possible $u_k^* - v_k$ are the vectors x_k with the following properties:

$$\begin{aligned} \sum_{\alpha=1}^n x_k(\alpha) &= 0, \quad \forall \alpha \text{ s.t. } u_k^*(\alpha) = 1, x_k(\alpha) \in \{0; 1\}, \\ \forall \alpha \in \mathcal{J}_k, x_k(\alpha) &= 0, \quad \forall \alpha \text{ s.t. } u_k^*(\alpha) = 0, x_k(\alpha) \in \{-1; 0\} \end{aligned}$$

Hence, $\psi(N - e_i + e_j) - \psi(N) = \sum_k \langle \rho_k, x_k^* \rangle$, where x_k^* is such that $\#\{\alpha \mid x_k^*(\alpha) = 1\} = \#\{\alpha \mid x_k^*(\alpha) = -1\}$. Consequently, $\psi(N - e_i + e_j) - \psi(N)$ can be written as a sum of $w_{\alpha\beta}^k$ for certain α, β . Because of the condition $\sum_k u_k^* - v_k = e_i - e_j$, we have $\psi(N - e_i + e_j) - \psi(N) = w_{\alpha_0 \alpha_1}^{k_0} + w_{\alpha_1 \alpha_2}^{k_1} + \dots + w_{\alpha_{p-1} \alpha_p}^{k_{p-1}}$, with the notations introduced in Theorem 7.22.

Consider now the graph defined in Theorem 7.22. If there exists a path between i and j , then its value can be written $w_{\beta_0 \beta_1}^{l_0} + w_{\beta_1 \beta_2}^{l_1} + \dots + w_{\beta_{q-1} \beta_q}^{l_{q-1}}$ (with the convention $\beta_0 = i$ and $\beta_q = j$). By defining $v_k = u_k^*$ if $k \notin \{l_0, \dots, l_{q-1}\}$ and $v_{l_u} = u_{l_u}^* - e_{\beta_u} + e_{\beta_{u+1}}$ for $0 \leq u \leq q-1$, the value of the

path is equal to $\sum_k \langle \rho_k, u_k^* - v_k \rangle$. Because $w_{\beta_u \beta_{u+1}}^{l_u} < +\infty$, we have $u_{l_u}^*(\beta_u) = 1$ and $u_{l_u}^*(\beta_{u+1}) = 0$. Then, each $v_k \in F_k$. Consequently, the value $\min_{v_k \in F_k} \sum_k v_k = N - e_i + e_j$ and $\sum_k \langle \rho_k, u_k^* - v_k \rangle$ is finite and $N - e_i + e_j \in \sum_k F_k$. Moreover, the value $\psi(N - e_i + e_j) - \psi(N)$ corresponds to the minimal values of the path between i and j in G , that is the shortest path. Hence, if the value of the shortest path is $\sum_{u=0}^{p-1} w_{\alpha_u \alpha_{u+1}}^{l_u}$, we have $\psi(N - e_i + e_j) - \psi(N) = \sum_k \langle \rho_k, u_k^* - v_k^* \rangle$, with v_k^* defined as in the statement of Theorem 7.22. Moreover, we can prove that there exists no cycle with negative weight in this graph. Suppose that such a cycle exists. It can be written $w_{\gamma_0 \gamma_1}^{l_0} + w_{\gamma_1 \gamma_2}^{l_1} + \dots + w_{\gamma_r \gamma_0}^{l_r} < 0$. For all $i \in \{0 \dots r\}$, we have $u_{l_i}(\gamma_i) = 1$ and $u_{l_i}(\gamma_{i+1}) = 0$. We consider for $k \in [K]$ the vectors v_k defined by $v_{l_i} = u_{l_i}^* - e_{\gamma_i} + e_{\gamma_{i+1}}$, and $v_k = u_k^*$ for $k \notin \{l_0, \dots, l_r\}$. We have $\sum_k u_k^* - v_k = 0$ and so $\sum_k \langle \rho_k, u_k \rangle = \sum_k \langle \rho_k, v_k \rangle + w_{\alpha_1 \alpha_2}^{k_1} + w_{\alpha_2 \alpha_3}^{k_2} + \dots + w_{\alpha_p \alpha_1}^{k_p} < \sum_k \langle \rho_k, v_k \rangle$ which refutes the optimality of the vectors u_k^* in the definition of $\psi(N)$. \square

Example We consider the cell (a) of Figure 7.3. We build the graph associated to $N = (3, 3, 1)$ (see Figure 7.4).

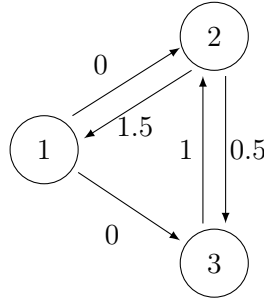

Figure 7.4: Graph G associated to the vector $N = (3, 3, 1)$

Consider $N' = N - e_1 + e_2 = (2, 4, 1)$. The shortest path in G is $1 \rightarrow 2$ with $w_{12} = 0 = w_{12}^1$. Then, according to Theorem 7.22, the optimal decomposition of $(2, 4, 1)$ is $v_1^* = (0, 1, 0)$, $v_2^* = (1, 0, 1)$, $v_3^* = (0, 1, 0)$, $v_4^* = (1, 1, 0)$ and $v_5^* = (0, 1, 0)$.

Thanks to Theorem 7.22, if we know that a vector N belongs to $\sum_k F_k$, it is possible to check whether a vector $N - e_i + e_j$ belongs to F_k by checking if there exists a path between i and j in the graph $G = (V, E)$. Generally, G has n vertices and n^2 edges. From each vertex $i \in V$, it is possible to find if there exists a path between i and j by using a depth-first or breadth first search algorithm in $O(n^2)$ operations. Consequently, the number of operations needed to evaluate g is $O(n^3)$.

According to Theorem 7.22, by checking if $N - e_i + e_j \in B$, we obtain the optimal decomposition of $N - e_i + e_j = \sum_k v_k^*$ such that $\psi(N - e_i + e_j) = -\sum_k \langle \rho_k, v_k^* \rangle$ by solving a shortest path problem between two vertices. This can be done in $O(n^3)$ operations thanks to Ford-Bellman algorithm ([Bel58], [FJ56]), because the graph G has n vertices and at most n^2 edges. Hence, according to Theorem 7.17, it suffices to solve the bilevel problem 7.4 to solve the linear feasibility problem of Lemma 7.19. Moreover, this problem can also be viewed as a shortest path problem in G , according to the following result.

Theorem 7.23. Consider K vectors $u_k^* \in F_k$ for each $k \in [K]$ such that, if we define $N = \sum_k u_k^*$, we have $\psi(N) = -\sum_k \langle \rho_k, u_k^* \rangle$. Consider the graph G associated to N . Consider an

index $s \in [n]$. Let $M > 0$ be any real scalar such that $M \geq n \max_{i,j \in [n]} w_{ij}$ and let us modify G such that for all $t \in [n]$ with $t \neq s$ and $w_{st} = +\infty$, we have $w_{st} = M$. Let us define a vector $y^* \in \mathbb{R}^n$ by $y_s^* = 0$ and for each $t \in [n]$ with $t \neq s$, y_t^* is the length of the shortest path between s and t in G . Then, for M sufficiently large and for each $k \in [K]$, $u_k^* \in \arg \max_{u_k \in F_k} \langle \rho_k + y^*, u_k \rangle$.

Proof. According to Lemma 7.19, a vector $y \in \mathbb{R}^n$ is such that for every $k \in [K]$,

$$u_k^* \in \arg \max_{u_k \in F_k} \langle \rho_k + y, u_k \rangle$$

if and only if the following inequalities are satisfied:

$$\forall k \in [K], \forall i, j \notin \mathcal{J}_k, \text{ such that } u_k^*(i) = 1, u_k^*(j) = 0, \rho_k(i) + y_i \geq \rho_k(j) + y_j.$$

Consider such a vector y . Consider also the graph G associated to N . The previous inequalities can be rewritten $\forall k \in [K], \forall i, j \in [n], y_j - y_i \leq w_{ij}^k$, or equivalently : $\forall i, j \in [n], y_j - y_i \leq w_{ij}$. For each $\delta \in \mathbb{R}$, $y + \delta e$ is also a solution. Consequently, it is possible to fix a coordinate to 0. Take a coordinate s such that $y_s = 0$. Consider $M > 0$ such that $M \geq n \max_{i,j} w_{ij}$ and modify the graph G as in the statement of the theorem. Consider an elementary cycle (that is a cycle containing no smaller cycle) of the modified graph. The cycle has no more than $n - 1$ edges. Suppose that exactly q edges have a modified weight, with $0 \leq q \leq n - 1$. If $q = 0$, then no edge has a modified weight, and this cycle is a cycle of G . So, its weight is nonnegative. If $q \geq 1$, then the total weight of the cycle is bigger than $qM + (n-1-q) \min_{i,j} w_{ij} \geq n(\max_{i,j} w_{ij} - \min_{i,j} w_{ij}) \geq 0$. Consequently, the modified graph has no negative cycles.

For each $t \in [n]$, with $t \neq s$, there exists a path between s and t . Let us define y^* such that $y_s^* = 0$ and for each $t \in [n]$ with $t \neq s$, y_t^* corresponds to the length of the shortest path between s and t . Consider $i, j \in [n]$. Then $y_i^* + w_{ij}$ is the length of a path between s and j defined as the concatenation of the shortest path between s and i and the edge $i \rightarrow j$. So $y_i^* + w_{ij} \geq y_j^*$. Hence, according to Lemma 7.19, we have for each $k \in [K]$, $u_k^* \in \arg \max_{u_k \in F_k} \langle \rho_k + y^*, u_k^* \rangle$. \square

These different results lead to Algorithm 3 to solve the bilevel problem 7.4. First, we have to find an initial point N in $\sum_k F_k$, with its optimal decomposition $\sum_k u_k^*$. We can calculate for each $k \in [K]$ and for each $i, j \notin \mathcal{J}_k$ the value w_{ij}^k , store them, and then define the graph G associated to N . Hence, with a graph search algorithm, we know for each $i, j \in [n]$ whether $N - e_i + e_j \in \sum_k F_k$ or not, and can calculate $g(N - e_k + e_l)$ for each $k, l \in [n]$ and find $i, j \in \arg \max_{k,l} g(N - e_k + e_l)$. By finding the shortest path between i and j in G , we obtain the optimal decomposition $N - e_i + e_j = \sum_k v_k^*$. Like in Algorithm 1, if $g(N - e_i + e_j) \leq g(N)$, then $N^* = N$ is the maximum value of g over $\sum_k F_k$. Else, we take $N := N - e_i + e_j$. For all the indices k such that $u_k^* \neq v_k^*$, we evaluate the new value of w_{ij}^k and we define the graph G associated to $N - e_i + e_j$ and restart the algorithm. Notice that the number of indices k such that $u_k^* \neq v_k^*$ is bounded by the length of the shortest path in G ; it means that this number is less than n . After finding the optimal N^* and having its optimal decomposition $N^* = \sum_k u_k^*$, we can redefine the graph associated to N^* and return an optimal y^* defines as in the statement of Theorem 7.23.

Algorithm 3 can be written as follows. We take in input a function GraphSearch, which associate to a graph G (defined by the weight vector w of its edges) a boolean vector b such that $b_{ij} = 1$ if there is an edge between i and j and 0 otherwise. We also take a function ShortestPath, which associate to a graph G (also defined by the weight vector w) and two vertices i and j , the

value v of the shortest path and a vector $path$ with the indices of this shortest path. Finally, we consider the function `ShortestPath2`, which associate to w and a vertex s a vector corresponding to the values of the shortest path between s and all other vertices in G . For much ease, we denote by f^* the function $f^* : N \mapsto f(N) + M \sum_{i=1}^n \max(N_i - N_i^C, 0)$.

Note that the pseudo-polynomial time bound for Murota's algorithm leads in this special case to a polynomial time bound.

Theorem 7.24. *Let us define $R = \sum_k R_k$, for each $k \in [K]$ $n_k = n - \#\mathcal{J}_k$ (that is the number of possible non-zero coordinates of the vectors of F_k) and $\bar{R} = \sum_k R_k(n_k - R_k)$. Algorithm 3 returns a global optimizer with a time complexity of $O(R(n^3 + \bar{R}))$ and a space complexity of $O(\bar{R})$.*

Proof. The vector returned by the algorithm is a global optimizer according to Algorithm 1 and Theorem 7.22. The initialization consists in taking vectors in each F_k and in adding them; it can be done in $O(K)$ operations. Then, to define the graph G , we have to calculate w_{ij}^k for each $i, j \notin \mathcal{J}_k$ and each $k \in [K]$, and to store the values. Let us define for each $k \in [K]$ $n_k = n - \#\mathcal{J}_k$. For each $k \in [K]$, we have $R_k \leq n_k$, and there are precisely R_k coordinates of u_k^* equal to 1 for each $u_k^* \in F_k$. Then, for each $k \in [K]$, there are exactly $R_k(n_k - R_k)$ finite values of w_{ij}^k to store. Then, by defining $\bar{R} = \sum_k R_k(n_k - R_k)$, we need $O(\bar{R})$ operations to define w_{ij} and k_{ij} . The function `GraphSearch` needs $O(n^3)$ operations by a depth-first or breadth-first algorithm to know if there is a path between i and j . The function `ShortestPath` needs also $O(n^3)$ operations to calculate the shortest path between i and j with Ford-Bellman algorithm. The length of the path is bounded by n . Consequently, there is less than n vectors u_k^* which have to be updated; and then less than $2nn_k$ values $w_{\alpha\beta}^k$ to update. \bar{R} operations are needed to calculate the new values of w_{ij} and k_{ij} . So, the number of operations in each step of the "while" loop is $O(n^3 + n\bar{R})$. The number of iterations of the loop is the same as in Algorithm 1, and is bounded by K_1 where $K_1 = \max(\|x - y\|_1, x, y \in \sum_k F_k)$. For each $x, y \in \sum_k F_k$, we have:

$$\|x - y\|_1 = \sum_{i=1}^n |x_i - y_i| \leq \sum_{i=1}^n (x_i + y_i) = 2R$$

by defining $R = \sum_{k=1}^K R_k$. Finally, to find the optimal y^* , n^2 operations are needed to find M , and $O(n^3)$ operations are needed to evaluate the function `ShortestPath2` by using again the Ford-Bellman algorithm. Step 7 consists in calculating the shortest path between a vertex s and the other ones in a graph with n vertices and n^2 edges. Then, Step 7 can be obtained in $O(n^3)$ thanks to Ford-Bellman algorithm. Hence, the global time complexity of Algorithm 3 is $O(R(n^3 + \bar{R}))$ and space complexity is $O(\bar{R})$. \square

Notice that for each $k \in [K]$, $n_k \leq n$ and $1 \leq R_k \leq n_k$. Then $K \leq R \leq nK$ and $0 \leq \bar{R} \leq Kn^2$. Therefore, the time complexity of Algorithm 3 is $O(Kn^3(K + n))$ in the worst case, whereas the space complexity is $O(Kn^2)$.

Example Consider again Example 7.8 together with the concave function f defined by

$$f : N \mapsto - \sum_{t,l} N(t, l)^2.$$

We suppose that $\forall k, \mathcal{J}_k = \emptyset$. Hence, we can prove that $\sum_k F_k = \{N \in \mathbb{N}^3 \mid \sum_{i=1}^3 N_i = 7 \text{ and } \max(N_i) \leq 5\}$. First, we want to solve $\max_{N \in \sum_k F_k} -(N_1^2 + N_2^2 + N_3^2)$. We start from

Algorithm 3 Solving the bi-level problem, for one application and one type of contract

Require: $u_k^* \in F_k, \forall k \in [K], \rho_k, \forall k \in [K], f^*, \text{GraphSearch}, \text{ShortestPath}, \text{ShortestPath2}, s \in [n]$

Ensure: N^* optimal number of customers, y^* optimal discount vector

```

 $N \leftarrow \sum_{k=1}^K u_k^*$ 
for all  $k \in [K]$  do
  for all  $i, j \notin \mathcal{J}_k$  do
    if  $u_k(i) = 1$  and  $u_k(j) = 0$  then
       $w_{ij}^k \leftarrow \rho_k(i) - \rho_k(j)$ 
    end if
  end for
end for
for all  $i, j \in [n]$  do
   $w_{ij} \leftarrow \min_{k \in [K]} w_{ij}^k; \quad k_{ij} \in \arg \min_{k \in [K]} w_{ij}^k$ 
end for
 $stop \leftarrow 0$ 
while  $stop = 0$  do
   $b \leftarrow \text{GraphSearch}(w)$ 
   $g_N \leftarrow f^*(N); \quad g^* \leftarrow \max_{u, v \in [n], b_{uv}=1} f^*(N - e_u + e_v); \quad i, j \in \arg \max_{u, v \in [n], b_{uv}=1} f^*(N - e_u + e_v)$ 

  if  $g^* \leq g_N$  then
     $stop \leftarrow 1$ 
  else
     $(v, path) \leftarrow \text{Shortestpath}(w, i, j); \quad N \leftarrow N - e_i + e_j$ 
    for  $q = 1$  to  $\text{Length}(path) - 1$  do
       $\alpha \leftarrow path(q); \quad \beta \leftarrow path(q + 1); \quad k \leftarrow k_{\alpha\beta}; \quad u_k^*(\alpha) = 0; \quad u_k^*(\beta) = 1$ 
      for all  $\gamma \notin \mathcal{J}_k$  do
         $w_{\alpha\gamma}^k \leftarrow +\infty; \quad w_{\gamma\beta}^k \leftarrow +\infty$ 
        if  $u_k^*(\gamma) = 1$  then
           $w_{\gamma\alpha}^k \leftarrow \rho_k(\gamma) - \rho_k(\alpha)$ 
        else
           $w_{\beta\gamma}^k \leftarrow \rho_k(\beta) - \rho_k(\gamma)$ 
        end if
      end for
    end for
    for all  $i, j \in [n]$  do
       $w_{ij} \leftarrow \min_{k \in [K]} w_{ij}^k; \quad k_{ij} \in \arg \min_{k \in [K]} w_{ij}^k$ 
    end for
  end if
end while
 $M \leftarrow 1 + n \max_{i, j \in [n]} w_{ij}$ 
for all  $t \in [n]$  do
  if  $t \neq s$  AND  $w_{st} = +\infty$  then
     $w_{st} = M$ 
  end if
   $y^* \leftarrow \text{Shortestpath2}(w, s)$ 
   $y_s^* \leftarrow 0$ 
end for

```

$N^{(0)} = (5, 2, 0)$, a feasible point. Following Algorithm 1, we compute $N^{(1)} = (4, 2, 1)$ and $N^{(2)} = (3, 2, 2)$ which is a minimizer. We take $N^* = (3, 2, 2)$. Now, we solve

$$\max_{\substack{u_1 \in F_1, \dots, u_5 \in F_5 \\ \sum_{k=1}^5 u_k = N^*}} \sum_{k=1}^5 \langle \rho_k, u_k \rangle.$$

We obtain $u_1^* = [1, 0, 0]$, $u_2^* = [1, 0, 1]$, $u_3^* = [0, 1, 0]$, $u_4^* = [1, 0, 1]$, $u_5^* = [0, 1, 0]$. Applying Lemma 7.19, we obtain the linear inequalities $y_1^* - y_2^* \leq 3/2$, $0 \leq y_1^* - y_3^*$ and $-1 \leq y_2^* - y_3^* \leq -1/2$. In particular, $y^* = (3/4, 0, 3/4)$ is an optimal solution.

7.4.2 A particular case : theory of majorization

Algorithm 3 can be accelerated in the particular case $\forall k \in [K]$, $\mathcal{J}_k = \emptyset$, that is $F_k = \{u_k \in \{0; 1\}^n \mid \sum_{i=1}^n u_k(i) = R_k\}$.

As previously, an important step of the maximization of the function g consists in being able to know whether a point belongs to $\sum_k F_k$ or not. In this particular case, we can use the *majorization order* [OM79]. For every $x \in \mathbb{R}^n$, denote by $x_{[1]} \geq \dots \geq x_{[n]}$ the coordinates of x arranged in nonincreasing order. A vector $x \in \mathbb{R}^n$ is said to be *majorized* by another vector $y \in \mathbb{R}^n$, denoted $x \prec y$, if $\sum_{i=1}^n x_i = \sum_{i=1}^n y_i$ and $\forall 1 \leq k \leq n-1$, $\sum_{i=1}^k x_{[i]} \leq \sum_{i=1}^k y_{[i]}$.

We have the following result.

Theorem 7.25 (Gale-Ryser, see [OM79, Th. 7.C.1]). *Let $a \in \mathbb{N}^k$ and $b \in \mathbb{N}^n$ be two integer vectors with nonnegative values. Let $a^* \in \mathbb{N}^n$ defined by $a_i^* = \#\{j \mid a_j \geq i\}$. Then, the following assertions are equivalent:*

1. $b \prec a^*$
2. *There exists a matrix $U \in \mathcal{M}_{k,n}(\mathbb{Z})$ such that for each i, j , $u_{ij} \in \{0; 1\}$, $\forall 1 \leq i \leq k$, $\sum_{j=1}^n u_{ij} = a_i$ and $\forall 1 \leq j \leq n$, $\sum_{i=1}^k u_{ij} = b_j$*

Corollary 7.26. *Denoting by $f_r = (1, \dots, 1, 0, \dots, 0)$ the vector with exactly r 1 and by $p_r = \#\{k \mid R_k = r\}$, for $1 \leq r \leq n$, we have $\sum_k F_k = \{N \in \mathbb{N}^n \mid N \prec \sum_{r=1}^n p_r f_r\}$.*

Proof. A vector N belongs to $\sum_k F_k$ if and only if for each $i \in [n]$, N_i corresponds to the sum of the coefficients of the i -th column of a matrix of size $K \times n$ with coefficients in $\{0; 1\}$ and such that the sum of the coefficients of the k -th line is R_k . We conclude by 7.25. \square

Example 7.27. Consider Example 7.8. We have $p_1 = 3$, $p_2 = 2$ and $p_3 = 0$. So N is feasible iff N verifies $N \prec (5, 2, 0)$.

Like for Algorithm 3, we need to know for a given $N \in \sum_k F_k$ whether $N - e_i + e_j \in \sum_k F_k$ for each $i, j \in [n]$. It is possible to answer to this question in polynomial time in n by sorting $N - e_i + e_j$ for each i, j and by checking the condition $N - e_i + e_j \prec N^{\max}$. The time complexity of such a procedure is $O(n^3 \log(n))$. However, it can be accelerated thanks to the following result.

Lemma 7.28. *Let $N \in \sum_k F_k$, and $i, j \in [n]$. Let S be the function defined on $\mathbb{R}^n \times [n]$ such that $\forall x \in \mathbb{R}^n, \forall k \in [n]$, $S(x, k)$ is the sum of the k largest values of the coordinates of x . Suppose finally that N_j is the k_j -th largest value of the coordinates of N (if $k_j > 1$, then we suppose that the $k_j - 1$ -th largest value of N is strictly bigger than N_j), and that N_i is the k_i -th largest value*

of the coordinates of N (if $k_i < n$, then we suppose that the $k_i + 1$ -th largest value of N is strictly smaller than N_j). Then $N - e_i + e_j \in \sum_k F_k$ if and only if $N_i > 0$ and, either $N_i > N_j$ or $\forall k_j \leq k \leq k_i, S(N, k) < S(N^{\max}, k)$.

Proof. Suppose $N - e_i + e_j \in \sum_k F_k$. Then $N_i - 1 \geq 0$ and $N_i > 0$. Moreover, suppose $N_i \leq N_j$. Then, $N_i - 1 < N_j + 1$ and $S(N, k) = S(N, k) + 1$. Then, $S(N, k) < S(N, k) + 1 = S(N^{\max}, k)$.

Conversely, if $N_i > 0$, then all the coordinates of $N - e_i + e_j$ are nonnegative integers. If $N_i > N_j$, then we easily see that $N - e_i + e_j \prec N$. So $N - e_i + e_j \prec N^{\max}$ and $N - e_i + e_j \in \sum_k F_k$. Suppose that $N_i \leq N_j$. Because we suppose that the $k - 1$ -th largest value of N is strictly bigger than N_j , then $k_i > k_j$. We also suppose that $\forall k_j \leq k \leq k_i, S(N, k) < S(N^{\max}, k)$. The $k - 1$ -th largest value of N is strictly bigger than N_j , so it is bigger than $N_j + 1$. Consequently, we have for all $1 \leq l \leq k - 1$, $S(N - e_i + e_j, l) = S(N, l) \leq S(N^{\max}, l)$ (because $N \prec N^{\max}$). Moreover, $\forall k_j \leq k \leq k_i - 1, S(N, k) < S(N^{\max}, k)$. Because the $k_i + 1$ -th larger coordiante of N is strictly smaller than N_i , then it is smaller than $N_i + 1$ and we have $S(N - e_i + e_j, k_i) = S(N, k_i) \leq S(N^{\max}, k_i)$ and $\forall l \geq k_i + 1, S(N - e_i + e_j, l) = S(N, l) \leq S(N^{\max}, l)$. Hence, $N - e_i + e_j \prec N^{\max}$ and $N - e_i + e_j \in \sum_k F_k$. \square

To solve the bilevel problem 7.4 in this specific case, we need to find $u_1^* \in F_1, \dots, u_K^* \in F_K$ such that $\psi(N^*) = -\sum_k \langle \rho_k, u_k^* \rangle$. In Algorithm 3, such vectors $(u_k)^*$ are found in the same time as N^* . Then, to accelerate Algorithm 3, we need to be able to solve this problem rapidly. In particular, to use a classical linear programming approach leads to a $O((Kn)^{3,5})$ time complexity, which is not acceptable. The problem to solve can be written:

Problem 7.29.

$$\max_{\substack{u_1, \dots, u_K \in \{0;1\}^n \\ \forall k, \sum_{i=1}^n u_k(i) = R_k \\ \forall i, \sum_{k=1}^K u_k(i) = N_i}} \sum_{k=1}^K \langle \rho_k, u_k \rangle$$

We already mentioned in the proof of Theorem 7.25 that the constraints of this linear program can be written $0 \leq u \leq 1$, $Au = b$, where A is a totally unimodular matrix. Therefore, the value of this problem is equal to the value of its continuous relaxation. Moreover, it can be interpreted as a minimum cost flow problem (see [Sch03, Ch. 12] for background). We define a bipartite graphs with vertices $i \in [n]$ and $k \in [K]$, and edges between each $i \in [n]$ and each $k \in [K]$. Each vertex $i \in [n]$ has an incoming flow equal to N_i , whereas each vertex $k \in [K]$ has an outgoing flow equal to R_k . Moreover, the capacity of each edge is 1, meaning that each flow $u_k(i)$ satisfies $0 \leq u_k(i) \leq 1$, and a cost $-\rho_k(i)$ is associated to each edge. Hence, the problem consists in finding the flow u minimizing the total cost in this graph. Plenty of algorithms exist to solve such a problem. In our case, we have $K \gg n$. According to Theorem 7.24, Algorithm 3 needs $O(Rn^2(K+n))$ operations to solve Problem 7.4. Notice that $K \leq R \leq nK$. Therefore, in order to accelerate Algorithm 3 in the studied case, we need an algorithm solving the flow problem with a complexity depending on K in K^α with $\alpha < 2$.

We can interprete the minimum cost flow problem as a minimum cost circulation problem, as presented in [Sch03, Ch. 12]. We introduce a sink t . We define an edge between each $k \in [K]$ and t of cost equal to 0, with a lower-bound for the flow equal to R_k and a capacity of R_k . We also define an edge between t and each $i \in [n]$ of cost equal to 0, with a lower-bound for the flow equal to N_i^* and a capacity of N_i^* . Such a graph is represented on Figure 7.5.

Such a graph has $|V| = K + n + 1$ vertices and $|E| = Kn + K + n$ edges. The sum of the capacities of the different edges is $2R + Kn$. In [GT89, Sec. 3.3], an algorithm is proposed to solve

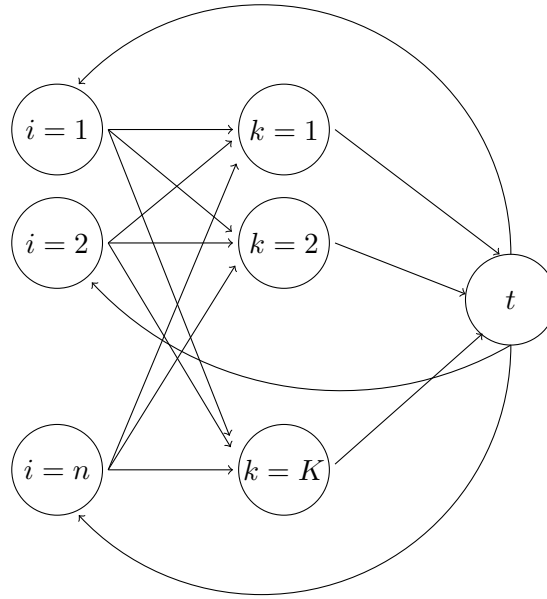

Figure 7.5: Minimum cost flow problem transformed in a minimum cost circulation problem. The flow in the edges between each i and k is in $[0, 1]$, the flow in the edges between each k and t is equal to R_k , and the flow in the edges between t and each i is N_i^* .

such a problem. Different complexity bounds of such an algorithm are given in [GT89, Th. 3.5]. In the case $K \gg n$, the optimal vectors u_1^*, \dots, u_K^* can be found in $O((Kn)^{3/2} \log((K+n)\|\rho\|_\infty))$, according to [GT89, Th. 3.5, (a)].

We can now write an algorithm for solving the bilevel problem in this specific case. We need first to calculate $N^{\max} = \sum_{r=0}^n p_r f_r$, where p_r is defined as in the statement of Theorem 7.25, and to find an initial point $N \in \sum_k F_k$. We apply the same method as in Algorithm 1. In order to calculate $g(N - e_i + e_j)$ for each $i, j \in [n]$, we sort the coordinate of N in the decreasing order, and we use Lemma 7.28 to decide whether $N - e_i + e_j \in F_k$ for all i, j . We use the same loop as in Algorithm 1 to compute an N^* such that $g(N^*)$ is the maximal value of g over $\sum_k F_k$. Then, we solve the minimum cost flow problem 7.29, as described previously, to find the optimal u_k^* and then we use Theorem 7.23 to determine an optimal y^* . It leads to Algorithm 4. The function *Sort* associates to a vector $x \in \mathbb{R}^n$ a couple (y, ind) , where y is a permutation of x such that $y_1 \geq \dots \geq y_n$ and ind is such that $x_i = y_{ind(i)}$ for each $i \in [n]$. The function S is defined by $S(x, k) = \sum_{i=1}^n x_i$. The function *MinCostFlow* associates to the different vectors $(\rho_k)_{k \in [K]}$ the vectors $(u_k^*)_{k \in [K]}$ solving the minimum cost flow problem 7.29. The functions f^* and *ShortestPath2* are defined as for Algorithm 3.

Theorem 7.30. *Let us define $\|\rho\|_\infty = \max_{k \in [K], i \in [n]} |\rho_k(i)|$, $R = \sum_k R_k$, for each $k \in [K]$ $n_k = n - \#\mathcal{J}_k$ and $\bar{R} = \sum_k R_k(n_k - R_k)$. Algorithm 4 is correct and returns a global optimizer in $O(Rn^2 + (Kn)^{3/2} \log((K+n)\|\rho\|_\infty) + \bar{R} + n^3)$ time and $O(Kn + n^2)$ space.*

Proof. According to Theorem 7.17, Theorem 7.25, Lemma 7.28 and Algorithm 1, this algorithm returns an optimal solution N^* of the high-level problem and an optimal discount vector y^* . Similarly as in the proof of Algorithm 3, the number of calls of the "while" loop is bounded by R . The function *Sort* needs $O(n \log(n))$ time and space operations. $O(n^2)$ operations are

Algorithm 4 Solving the bilevel problem, in the case of majorization**Require:** $N \in \sum_k F_k$, N^{\max} , $\rho_k, \forall k \in [K]$, f^* , S , $Sort$, $MinCostFlow$, $ShortestPath2$, $s \in [n]$ **Ensure:** N^* optimal number of customers, y^* optimal discount vector

```

 $s_1^{\max} \leftarrow 0$ 
for  $i = 1$  to  $n$  do
   $s_i^{\max} \leftarrow s_i^{\max} + N_i^{\max}$ 
end for
 $stop \leftarrow 0$ 
while  $stop = 0$  do
   $(N^{sort}, ind) \leftarrow Sort(N)$ ;  $s_1 = 0$ 
  for  $i = 1$  to  $n$  do
     $s_i \leftarrow s_i + N^{sort}(i)$ 
    for all  $j \in [n]$  do
      if  $N(i) = 0$  then
         $b(i, j) \leftarrow 0$ 
      else
         $b(i, j) \leftarrow 1$ 
      end if
    end for
    if  $s_i = s_i^{\max}$  then
      for  $j = 1$  to  $i$  do
         $b(ind(i), ind(j)) \leftarrow 0$ 
      end for
      for  $j = i$  to  $n$  do
         $b(ind(j), ind(i)) \leftarrow 0$ 
      end for
    end if
  end for
   $g_N \leftarrow f^*(N)$ ;  $g^* \leftarrow \max_{u, v \in [n]} b(u, v) f^*(N - e_u + e_v)$ ;  $i, j \in \arg \max_{u, v \in [n]} b(u, v) f^*(N - e_u + e_v)$ 
  if  $g^* \leq g_N$  then
     $stop \leftarrow 1$ 
  end if
end while
 $(u_1^*, \dots, u_K^*) \leftarrow MinCostFlow((\rho_k)_{k \in [K]})$ 
for all  $k \in [K]$  do
  for all  $i, j \notin \mathcal{J}_k$  do
    if  $u_k^*(i) = 1$  and  $u_k^*(j) = 0$  then
       $w_{ij}^k \leftarrow \rho_k(i) - \rho_k(j)$ 
    end if
  end for
end for
for all  $i, j \in [n]$  do
   $w_{ij} \leftarrow \min_{k \in [K]} w_{ij}^k$ ;  $k_{ij} \in \arg \min_{k \in [K]} w_{ij}^k$ 
end for
 $M \leftarrow 1 + n \max_{i, j \in [n]} w_{ij}$ 
for all  $t \in [n]$  do
  if  $t \neq s$  AND  $w_{st} = +\infty$  then
     $w_{st} = M$ 
  end if
end for
 $y^* \leftarrow Shortestpath2(w, s)$ 
 $y_s^* \leftarrow 0$ 
end for

```

needed to evaluate the vector b , then the global time complexity of the "while" loop is $O(Rn^2)$ whereas the space complexity is $O(n^2)$. Then, the optimal vectors u_1^*, \dots, u_K^* can be obtained in $O((Kn)^{3/2} \log((K+n)\|\rho\|_\infty))$ time and $O(Kn)$ space. By calculating only the finite values of w_{ij}^k (which are not necessary stored here), the number of operations needed to determine each w_{ij} and k_{ij} is $O(\bar{R})$, with $\bar{R} = \sum_k R_k(n_k - R_k)$ and for each $k \in [K]$, $n_k = n - \#\mathcal{J}_k$. We need only $O(n^2)$ space to store the values w_{ij} and k_{ij} . Finally, the vector y^* can be found by using the Ford-Bellman algorithm in a graph of n vertices and n^2 edges, that is in time complexity of $O(n^3)$. \square

In the worst case, we have $R = Kn$ and $\bar{R} = Kn^2$. Then, the time complexity of Algorithm 4 is $O(Kn^3 + (Kn)^{3/2} \log((K+n)\|\rho\|_\infty))$ If the number of bites needed to write $\|\rho\|_\infty$ is polynomial in n and if $K \gg n$, then Algorithm 4 is faster than Algorithm 3. We finally notice that a minimum cost flow problem is strongly polynomial time solvable, and it is then possible to adapt Algorithm 4 to return an optimal y^* in strongly polynomial time. The complexity of Algorithm 4 does not depend in this case on $\log(\|\rho\|_\infty)$. However, Algorithm 4 does not go faster than Algorithm 3 in this case.

Schur-convex functions at the high-level We focus on a particular case in which the high-level function is Schur-convex.

Definition 7.31 ([OM79], Ch.3, Def.A.1). Let $A \subset \mathbb{R}^n$. A function f is said *Schur-convex* on A if for every $x, y \in A$:

$$x \prec y \quad \Rightarrow \quad f(x) \leq f(y).$$

Proposition 7.32 ([OM79], Ch.3, Prop.C.1). Let I be an interval of \mathbb{R} and g be a convex function on I . Then, the function f defined over I^n by:

$$\forall x \in I^n, \quad f(x) = \sum_{i=1}^n g(x_i)$$

is *Schur-convex*.

The high-level function of Problem 6.17 is a separable convex function of the form $f(x) = \sum_{i=1}^n f_i(x_i)$. According to Proposition 7.32, f is Schur-convex if all functions f_i are equal.

Let us assume in the following that the high-level function f is Schur-convex. According to Corollary 7.26, the high-level problem can be written $\min_{N \in \mathbb{N}^n, N \prec \sum_{r=1}^n p_r f_r} f(N)$. Minimizing a Schur-convex function over a certain set defined by majorization inequalities is equivalent to find a minimal element in this set for the majorization order. We have the following result.

Proposition 7.33. Let f be a Schur-convex function. Let $R = \sum_{k=1}^K R_k$ and r be the remainder of the Euclidean division of R by n . Then, $N^* \in \arg \min_{N \in \mathbb{N}^n, N \prec \sum_{r=1}^n p_r f_r} f(N)$ if r entries of N^* are equal to $\frac{R-r}{n} + 1$ and $n - r$ entries of N^* are equal to $\frac{R-r}{n}$.

Proof. Let $N \in \mathbb{N}^n$ such that $N \prec \sum_{r=1}^n p_r f_r$. Suppose without loss of generality that $N_1 \geq \dots \geq N_n$. We have $\sum_{i=1}^n N_i = \sum_{k=1}^K R_k = R$. If $r = 0$, then $\frac{R}{n} \in \mathbb{N}$ and $(\frac{R}{n}, \dots, \frac{R}{n}) \prec N$. Then $f(\frac{R}{n}, \dots, \frac{R}{n}) \leq f(N)$. Suppose that $r \geq 1$. We next show by induction that for every $j \in [r]$, $\sum_{i=1}^j N_i \geq j \frac{R-r}{n} + j$. We have $N_1 \geq \frac{R-r}{n} + 1$. If not, it would mean that $N_i \leq \frac{R-r}{n}$ for every $i \in [n]$, that is $\sum_{i=1}^n N_i \leq \frac{R-r}{n} R$. Suppose that for a certain $j \in [r-1]$, $\sum_{i=1}^j N_i \geq j \frac{R-r}{n} + j$.

If $\sum_{i=1}^{j+1} N_i < (j+1)\frac{R-r}{n} + j + 1$, then $N_{j+1} < \frac{R-r}{n} + 1$, that is $N_{j+1} \leq \frac{R-r}{n}$. Consequently, for every $i \geq j+1$, $N_i \leq \frac{R-r}{n}$. Then:

$$\begin{aligned} \sum_{i=1}^n N_i &\leq \sum_{i=1}^{j+1} N_i + (n-1-j)\frac{R-r}{n} \\ &\leq (j+1)\frac{R-r}{n} + j + (n-1-j)\frac{R-r}{n} \leq R-r+j < R. \end{aligned}$$

We now prove by induction that for every $r \leq j \leq n$, $\sum_{i=1}^j N_i \geq j\frac{R-r}{n} + r$. It is shown for $j = r$. Suppose that for a certain $r \leq j \leq n$, $\sum_{i=1}^{j-1} N_i \geq (j-1)\frac{R-r}{n} + r$. If $\sum_{i=1}^j N_i < j\frac{R-r}{n} + r$, then $N_j < \frac{R-r}{n}$, that is for every $i \geq j$, $N_i \leq \frac{R-r}{n} - 1$. Then:

$$\begin{aligned} \sum_{i=1}^n N_i &\leq \sum_{i=1}^j N_i + (n-j)\frac{R-r}{n} - (n-j) \\ &\leq j\frac{R-r}{n} + r - 1 + (n-j)\frac{R-r}{n} - (n-j) \leq R-r + (r-1) - (n-j) < R. \end{aligned}$$

Let N^* be a vector with r first entries equal to $\frac{R-r}{n} + 1$ and $n-r$ remaining entries equal to $\frac{R-r}{n}$. Then, $N^* \in \mathbb{N}^n$ and the next inequalities state that for every $j \in [n-1]$, $\sum_{i=1}^j N_i \geq \sum_{i=1}^j N_i^*$, and $\sum_{i=1}^j N_i = \sum_{i=1}^j N_i^* = R$. Consequently, $N^* \prec N$ and $f(N^*) \leq f(N)$ by Schur-convexity of f . Any vector obtained by permuting the coordinates of N^* is suitable, since the majorization order is invariant by any permutation of entries. \square

As a consequence, the first part of Algorithm 4, consisting in finding an optimal N^* solution of $\min_{N \in \sum_k F_k} f(N)$ can be done in $O(K + \log(n))$ operations ($O(K)$ operations for calculating R and $O(\log(n))$ operations to do the Euclidean division of R by n). Then, the number of operations needed to find a solution of the bilevel problem is $O(K + (Kn)^{3/2} \log((K+n)\|\rho\|_\infty))$ in this case.

7.5 The general algorithm

In this section, we come back to the general bilevel problem 7.2 proposed in Section 7.2, and extend Algorithm 3 to it. In the low level problem of each customer, the consumptions for different contents verify the constraints $\forall a \in [A], \sum_{t=1}^T u_k^a(t) = R_k^a, \forall t \in \mathcal{I}_k^a, a \in [A], u_k^a(t) = 0$ and $\forall t \in [T], \sum_{a \in [A]} u_k^a(t) \leq 1$. We make the assumption that for each customer k , the sets of possible instants at which this customer makes a request for the different applications are disjoint, meaning that for any two applications $a \neq a'$, the complements of \mathcal{I}_k^a and $\mathcal{I}_k^{a'}$ in $[T]$ have an empty intersection. Then the constraint $\forall t \in [T], \sum_{a \in [A]} u_k^a(t) \leq 1$ is automatically verified and the low-level problem of each customer can be separated into different optimization problems corresponding to the consumption vector u_k^a of each customer k for each application a . Each of these problems takes the following form:

Problem 7.34.

$$\begin{aligned} &\max_{u_k^a \in \{0,1\}^T} \sum_{t=1}^T \left[\rho_k^a(t) + \alpha_k^a y^{a,b}(t, L_t^k) \right] u_k^a(t) & (7.10) \\ \text{s.t. } &\sum_{t=1}^T u_k^a(t) = R_k^a, \quad \forall t \in \mathcal{I}_k^a, a \in [A], u_k^a(t) = 0. \end{aligned}$$

We denote by F_k^a the feasible set of this problem. The above assumption (that the complements of \mathcal{I}_k^a and $\mathcal{I}_k^{a'}$ have an empty intersection) is relevant in particular if only one kind of application is sensitive to price incentives. For instance, requests for downloading data can be anticipated (see [TEEG13]) and it makes sense to assume that customers are only sensitive to incentives for this kind of contents. In this case, the assumption means that customers wanting to download data can shift their consumption only at instants when they do not request another kind of content.

Moreover, under this assumption, the decomposition theorem is still valid and Problem 7.2 can be solved with the following method:

Theorem 7.35 (Decomposition (general case)). *The bilevel problem 7.2 can be solved as follows:*

1. Find an optimal solution $(N^{a,b})^*$ to the high level problem with unknown $N^{a,b}$ for each $a \in [A]$, $b \in [B]$:

Problem 7.36.

$$\begin{aligned} \max_{N^{a,b} \in \sum_k F_k^a} \sum_{t,l} \left(\sum_{a \in [A]} \sum_{b \in [B]} \gamma_b N^{a,b}(t,l) s_l^{a,b}(N(t,l)) \right) \\ \text{s.t. } \forall t,l, N(t,l) = \sum_{a \in [A]} \sum_{b \in [B]} N^{a,b}(t,l) \quad \text{and} \quad \forall t,l, N(t,l) \leq N_l^C. \end{aligned}$$

2. For each $a \in [A]$ and $b \in [B]$, find vectors $((u_k^a)^*)_{k \in \mathcal{K}_b}$ solutions of the following problem:

$$\max_{\substack{(u_k^a \in F_k^a)_{k \in \mathcal{K}_b} \\ \sum_{k \in \mathcal{K}_b} u_k^a = (N^{a,b})^*}} \sum_{k \in \mathcal{K}_b} \langle \rho_k^a, u_k^a \rangle.$$

3. Find for each $a \in [A]$ and $b \in [B]$ a vector $y_{a,b}^*$ such that for every $k \in \mathcal{K}_b$,

$$(u_k^a)^* \in \arg \max_{u_k^a \in F_k^a} \langle \rho_k^a, u_k^a \rangle.$$

Proof. The different problems corresponding for each $a \in [A]$, for each $b \in [B]$ and for each $k \in \mathcal{K}_b$ to Problem 7.34 are independent. Thus, the global bilevel program consists in solving Problem 7.36. Moreover, the optimal decomposition of $(N^{a,b})^*$ and the optimal price vector $(y^{a,b})^*$ are totally independent for each $a \in [A]$ and $b \in [B]$. Then, the proof of the last two parts in the theorem is the same as in Theorem 7.17. \square

The last two parts of Theorem 7.35 are independent for each $a \in [A]$ and $b \in [B]$. Thus, they can be solved similarly as in the case of one kind of application and one kind of contracts, studied in Section 7.3. We need to solve Problem 7.36. The function to optimize is separable (it can be written as a sum of function depending only of one coordinate), but these functions are not concave in $(N^{1,1}, \dots, N^{A,B}) \in \mathbb{R}^{nAB}$. However, because each function $s_l^{a,b}$ is concave decreasing and each $N^{a,b}(t,l)$ is positive, we notice that $\forall a' \in [A], b' \in [B]$, the function which sends $N^{a',b'}(t,l)$ to $\sum_{a \in [A]} \sum_{b \in [B]} \gamma_b N^{a,b}(t,l) s_l^{a,b}(N(t,l))$ is still concave. Consequently, the function to optimize in Problem 7.36 is M -concave in each vector $N^{a,b} \in \mathbb{Z}^{T \times L}$ considered separately, the other one being fixed. This leads to a block descent method, in which we use the same scheme

as in Algorithm 1, successively, to maximize the objective function over every vector $N^{a,b}$. We denote by $f(N^{1,1}, \dots, N^{A,B})$ the objective function of the high-level problem. We consider for each a, b a vector $N^{a,b} \in \sum_{k \in \mathcal{K}_b} F_k^a$. For each couple (a, b) taken successively, we find $(i^{a,b}, j^{a,b})$ belonging to:

$$\arg \max_{(k,l) \text{ s.t. } N^{a,b} - e_k + e_l \in \sum_{k \in \mathcal{K}_b} F_k^a} f(N^{1,1}, \dots, N^{a,b} - e_k + e_l, \dots, N^{A,B})$$

If $f(N^{1,1} - e_{i^{a,b}} + e_{j^{a,b}}, \dots, N^{A,B} - e_{i^{a,b}} + e_{j^{a,b}}) \leq f(N^{1,1}, \dots, N^{A,B})$, then the algorithm stops and returns $(N^{1,1}, \dots, N^{A,B})$. Otherwise, we take for each a, b , $N^{a,b} := N^{a,b} - e_{i^{a,b}} + e_{j^{a,b}}$ and begin again. Consequently, Algorithm 3 can be modified to solve the bilevel problem 7.9 in the general case. It leads to Algorithm 5. The function *GraphSearch*, *ShortestPath* and *ShortestPath2* are the same as for Algorithm 3. The function f^* is here defined by:

$$f^* : (N^{1,1}, \dots, N^{A,B}) \mapsto \sum_t \sum_l \left[\sum_{a \in [A]} \sum_{b \in [B]} \gamma_b N^{a,b}(t, l) s_l^{a,b}(N(t, l)) - M \max(N(t, l) - N_l^C, 0) \right]$$

with $N(t, l) = \sum_{a \in [A]} \sum_{b \in [B]} N^{a,b}(t, l)$.

Because the objective function of Problem 7.36 is not M -convex in $(N^{1,1}, \dots, N^{A,B})$, we have no guarantee of convergence of Algorithm 5 to a global optimal of the function f^* . However, we can characterize the nature of the optimum returned by Algorithm 5. In order to estimate the complexity of Algorithm 5, we define the function Δf^* by:

$$\begin{aligned} \Delta f^*(N^{1,1}, \dots, N^{A,B}) &= -f^*(N^{1,1}, \dots, N^{A,B}) \\ &+ \max_{\substack{u^{a,b}, v^{a,b} \in [T] \times [L] \\ N^{a,b} - e_{u^{a,b}} + e_{v^{a,b}} \in \sum_{k \in \mathcal{K}_b} F_k^a}} f^*(N^{1,1} - e_{u^{a,b}} + e_{v^{a,b}}, \dots, N^{A,B} - e_{u^{a,b}} + e_{v^{a,b}}) \end{aligned}$$

If for each a, b we have $u^{a,b} = v^{a,b}$, then $\Delta f^*(N^{1,1}, \dots, N^{A,B}) = 0$. Thus, we have

$$\Delta f^*(N^{1,1}, \dots, N^{A,B}) \geq 0 .$$

Because the set $\prod_{a,b} (\sum_{k \in \mathcal{K}_b} F_k^a)$ is finite, we can define the value δg by:

$$\delta g = \min_{\substack{N^{a,b} \in \sum_{k \in \mathcal{K}_b} F_k^a \\ \Delta f^*(N^{1,1}, \dots, N^{A,B}) > 0}} \Delta f^*(N^{1,1}, \dots, N^{A,B})$$

because f^* has not a constant value.

Theorem 7.37. *Let us define $\gamma_{\max} = \max_{b \in [B]} \gamma_b$. Let us also define $R = \sum_{a \in [A]} \sum_{k \in [K]} R_k^a$, for each $a \in [A]$ and $k \in [K]$ $n_k^a = TL - \#\mathcal{J}_k^a$ (that is the number of possible non-zero coordinates of the vectors of F_k^a) and $\bar{R} = \sum_a \sum_k R_k^a (n_k^a - R_k^a)$. Algorithm 5 terminates in $O(\frac{\gamma_{\max} R}{\delta g} (AB(TL)^3 + \bar{R}))$ time and $O(\bar{R})$ space, and returns vectors $(y^{a,b})_{a \in [A], b \in [B]}^*$ and $(N^{a,b})_{a \in [A], b \in [B]}^*$ such that $\forall a \in [A], b \in [B], \forall N^{a,b} \in \sum_k \mathcal{K}_b F_k^a$:*

$$f^*((N^{1,1})^*, \dots, (N^{a,b})^*, \dots, (N^{A,B})^*) \geq f^*((N^{1,1})^*, \dots, N^{a,b}, \dots, (N^{A,B})^*)$$

Algorithm 5 Solving the bilevel problem for an arbitrary number of types of contracts.

Require: $(u_k^a)^* \in F_k^a, \forall a \in [A], \forall k \in [K], \rho_k^a, \forall a \in [A], \forall k \in [K], f^*, \text{GraphSearch}, \text{ShortestPath}, \text{ShortestPath2}, s \in [n]$

Ensure: N^* optimal number of customers, y^* optimal discount vector

```

for all  $a \in [A], b \in [B]$  do
   $N^{a,b} \leftarrow \sum_{k \in \mathcal{K}_b} (u_k^a)^*$ 
  for all  $k \in \mathcal{K}_b$  do
    for all  $t, t' \notin \mathcal{I}_k^a$  do
       $i = (t, L_k(t)) \quad j = (t', L_k(t'))$ ,
      if  $u_k^a(i) = 1$  and  $u_k^a(j) = 0$  then
         $w_{ij}^{k,a} \leftarrow \rho_k^a(i) - \rho_k^a(j)$ 
      end if
    end for
  end for
  for all  $t, t' \in [T], l, l' \in [L]$  do
     $i = (t, l) \quad j = (t', l')$ 
     $w_{ij}^{a,b} \leftarrow \min_{k \in \mathcal{K}_b} w_{ij}^{k,a}; \quad k_{ij}^{a,b} \in \arg \min_{k \in \mathcal{K}_b} w_{ij}^{k,a}$ 
  end for
end for
 $stop \leftarrow 0$ 
while  $stop = 0$  do
   $g_N \leftarrow f^*(N^{1,1}, \dots, N^{A,B});$ 
  for all  $a \in [A], b \in [B]$  do
     $c^{a,b} \leftarrow \text{GraphSearch}(w^{a,b})$ 
     $g^* \leftarrow \max_{u,v \in [T] \times [L]} c_{uv}^{a,b} f^*(N^{1,1}, \dots, N^{a,b} - e_u + e_v, \dots, N^{A,B}); \quad i^{a,b}, j^{a,b} \in$ 
     $\arg \max_{u,v \in [T] \times [L]} c_{uv}^{a,b} f^*(N^{1,1}, \dots, N^{a,b} - e_u + e_v, \dots, N^{A,B})$ 
  end for
  if  $g^* \leq g_N$  then
     $stop \leftarrow 1$ 
  else
    for all  $a \in [A], b \in [B]$  do
       $(v, path) \leftarrow \text{Shortestpath}(w^{a,b}, i, j); \quad N^{a,b} \leftarrow N^{a,b} - e_{i_a,b} + e_{j_a,b}$ 
      for  $q = 1$  to  $\text{Length}(path) - 1$  do
         $\alpha \leftarrow path(q); \quad \beta \leftarrow path(q+1); \quad k \leftarrow k_{\alpha\beta}^{a,b}; \quad (u_k^a)^*(\alpha) = 0; \quad (u_k^a)^*(\beta) = 1$ 
        for all  $\gamma \notin \mathcal{I}_k^a$  do
           $w_{\alpha\gamma}^{k,a} \leftarrow +\infty; \quad w_{\gamma\beta}^{k,a} \leftarrow +\infty$ 
          if  $(u_k^a)^*(\gamma) = 1$  then
             $w_{\gamma\alpha}^{k,a} \leftarrow \rho_k^a(\gamma) - \rho_k^a(\alpha)$ 
          else
             $w_{\beta\gamma}^{k,a} \leftarrow \rho_k^a(\beta) - \rho_k^a(\gamma)$ 
          end if
        end for
      end for
    end for
    for all  $t, t' \in [T], l, l' \in [L]$  do
       $i = (t, l) \quad j = (t', l')$ 
       $w_{ij}^{a,b} \leftarrow \min_{k \in \mathcal{K}_b} w_{ij}^{k,a}; \quad k_{ij}^{a,b} \in \arg \min_{k \in \mathcal{K}_b} w_{ij}^{k,a}$ 
    end for
  end for
end if
end while
 $M \leftarrow 1 + \text{ABTL} \max_{i,j \in [T] \times [L], a \in [A], b \in [B]} w_{ij}^{a,b}$ 
for all  $t \in [n]$  do
  if  $t \neq s$  AND  $w_{st} = +\infty$  then
     $w_{st} = M$ 
  end if
end for
 $y^* \leftarrow \text{Shortestpath2}(w, s)$ 
 $y_s^* \leftarrow 0$ 
end for

```

Proof. Algorithm 5 continues while the value g^* is strictly larger than g_N . Because the set $\prod_{a,b}(\sum_{k \in \mathcal{K}_b} F_k^a)$ is finite, the algorithm terminates. When it stops, the vector $(N^{a,b})_{a \in [A], b \in [B]}$ is such that $\forall a \in [A], b \in [B], \forall u, v \in [T] \times [L]$:

$$f(N^{1,1}, \dots, N^{a,b} - e_u + e_v, \dots, N^{A,B}) \leq f(N^{1,1}, \dots, N^{a,b}, \dots, N^{A,B})$$

For each a, b , the function $N^{a,b} \mapsto f(N^{1,1}, \dots, N^{a,b}, \dots, N^{A,B})$ is M -concave. The statement of the theorem comes straightforwardly from the equivalence between local and global optimality for M -concave functions.

Algorithm 5 differs from Algorithm 3 by the different applications and kind of contracts and by the number of iterations of the loop. The set $[K]$ of customers is splitted following the different kind of contracts $b \in [B]$. Thus, we have to define the parameters $w_{ij}^{k,a}$ for each $k \in [K]$ and $a \in [A]$ and the global space complexity becomes $\sum_a \sum_k R_k^a (n_k^a - R_k^a) = \bar{R}$. The number of iterations of the loop can be estimated with a pseudo-polynomial bound. The algorithm continues while $g^* > g_N$. Then, the new value of g^* is $f^*(N^{1,1} - e_{i1,1} + e_{j1,1}, \dots, N^{A,B} - e_{iA,B} + e_{jA,B})$. Consequently, at each iteration of the loop, the value of g^* increases of at least δg until the algorithm stops. The finite values of f^* are nonnegative, and an upper bound is $(\max_{b \in \mathcal{B}} \gamma_b)(\sum_a \sum_{k \in [K]} R_k^a) = \gamma_{\max} R$ because each function s_l takes values between 0 and 1. In each loop, the number of operations is $O(\bar{R} + AB(TL)^3)$ to calculate the new values of $w_{ij}^{a,b}$ and to solve a shortest path problem for each a and b in the graph $G^{a,b}$ with nodes corresponding to all couples in $[T] \times [L]$ and edges with values $w_{ij}^{a,b}$ between vertices $i, j \in [T] \times [L]$. \square

7.6 Experimental results

We consider an application based on real data provided by Orange. It involves the data consumptions in an area of $L = 43$ cells, during one day divided in time slots of one hour, that is $T = 24$ time slots. We will focus here our study on price incentives only for download contents. During this day, a number K of more than 2500 customers make some requests for downloading data in this area and we are interested in balancing the number of active customers in the network. Even though they are insensitive to price incentives, other kind of requests (web, mail, etc.) have to be satisfied and they are taken into account in the high level optimization problem. We consider two classes of users: standard and premium customers. The premium ones demand a better quality of service. Hence, they are less satisfied than the standard customers if they share their cell with a given number of active customers. We therefore define the satisfaction function as in Section 7.2. The provider wants to favor the premium customers. Hence, we take $\gamma_b = 2$ for the latter ones and $\gamma_b = 1$ for the standard customers, in the high-level optimization problem. We also assume that the premium customers are less sensitive to the incentives, and thus take $\alpha_k^a = 1/2$ for all standard customers and $\alpha_k^a = 1$ for all premium customers in the low-level problem 7.1. We estimate very simply the parameters ρ_k . We take $\rho_k(t) = 1$ when the customer k consumes download at time t without incentives, $\rho_k(t) = 0$ when he does not make any request without incentives but makes a request for download at times $t - 1$ or $t + 1$ (we assume he could shift his consumption of one hour) and $\rho_k(t) = -\infty$ otherwise.

We solve the bilevel problem using Algorithm 5, implemented in Scilab. The computation took 9526 seconds on a single core of an Intel i5-4690 processor @ 3.5 GHz.

On Figures 7.6– 7.9, we show the evolution of the satisfaction of different kind of customers for different kind of contents without and with incentives. These results show that price incentives

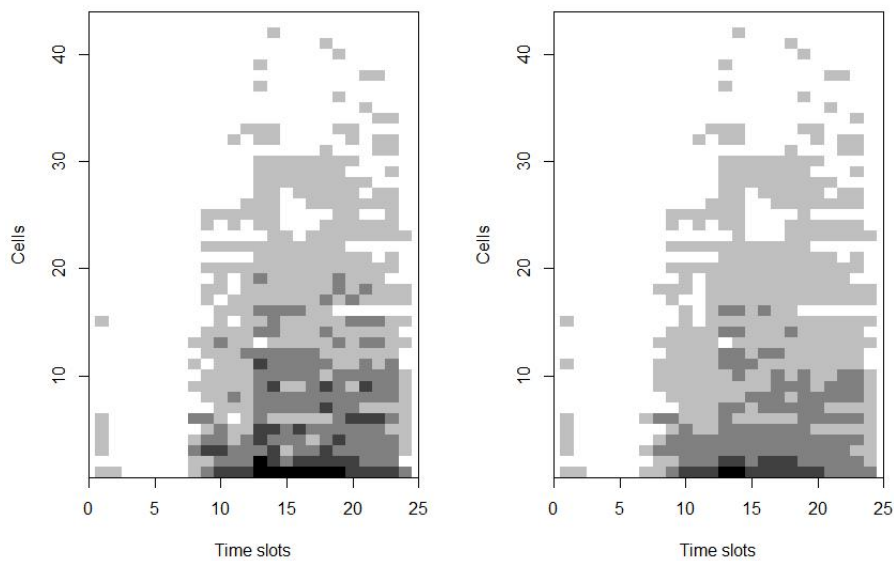

Figure 7.6: Satisfaction of premium customers for streaming without (left) and with (right) incentives. The grey level indicates the satisfaction: critical dissatisfaction, $s < 0.3$ (black), $0.3 < s < 0.7$ (dark grey), $0.7 < s < 0.9$ (grey), $0.9 < s < 0.99$ (light grey) and complete satisfaction $0.99 < s$ (white).

have an effective influence on the load, especially in the most loaded cells (the number of black regions in the space-time coordinates, in which the dissatisfaction of the users is critical, is considerably reduced). Moreover, Figure 7.10 reveals that the consumption of users is not only moved in time, but also in space: not only some consumption is moved from the peak hour to the night (off peak), but the surface of the dark grey region, representing the total download consumption in the cell over the whole day, is decreased, indicating that some part of the consumption has been shifted to other cells.

7.7 Conclusion

We presented here a bilevel model for price incentives in data mobile networks. We solved this problem by a decomposition method based on discrete convexity and tropical geometry. We finally applied our results to real data. In further work, we shall consider more general models: unfixed number of requests, nonlinear preferences of the customers, satisfaction functions of the provider taking into account the profit. Stochastic models shall also be considered in particular to take into account the partial information of the provider about the customers preferences and trajectories.

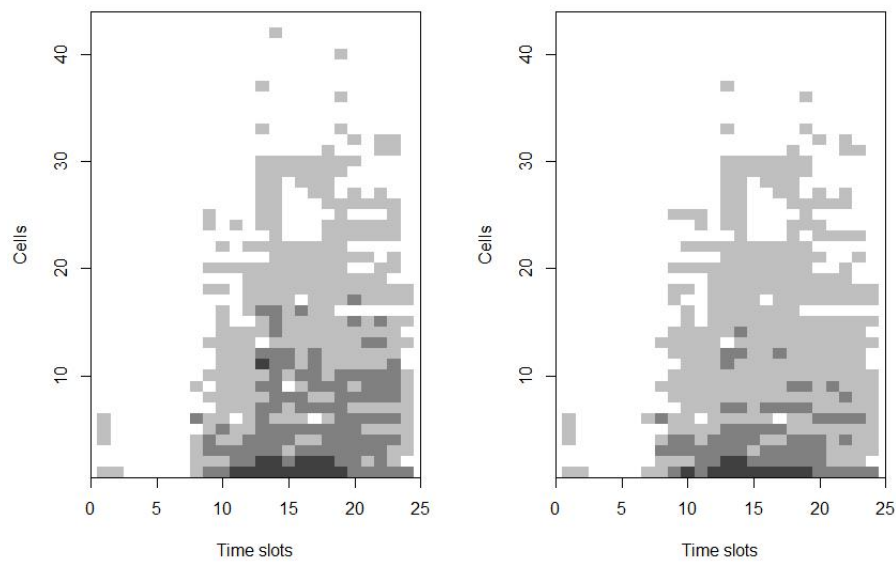

Figure 7.7: Satisfaction of standard customers for streaming without (left) and with (right) incentives

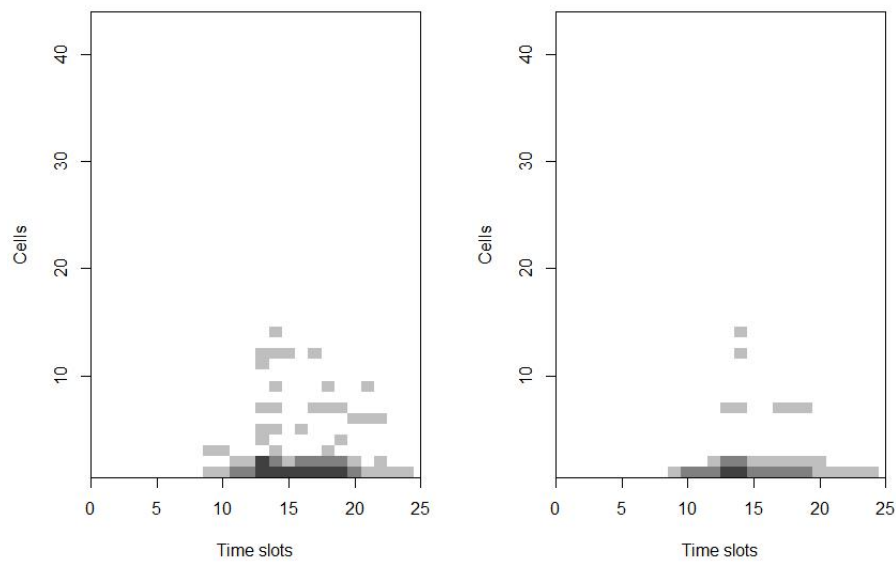

Figure 7.8: Satisfaction of premium customers for web, mail or download without (left) and with (right) incentives

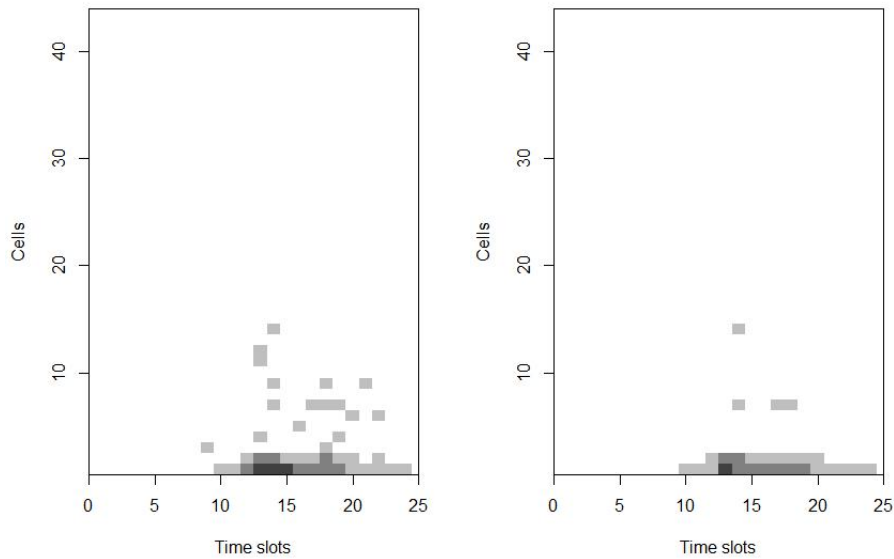

Figure 7.9: Satisfaction of standard customers for web, mail or download without (left) and with (right) incentives

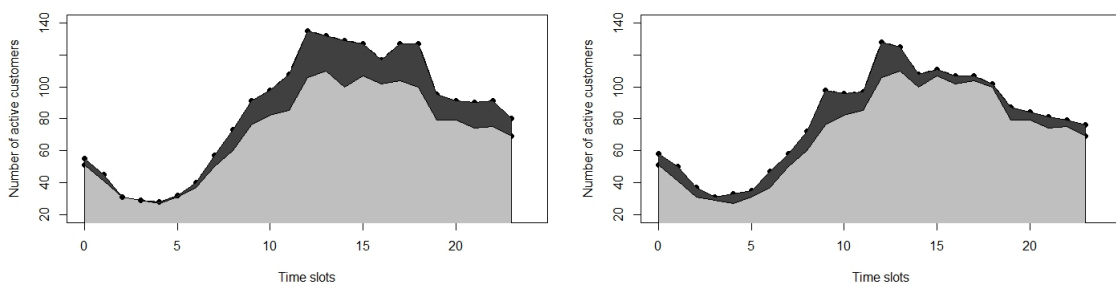

Figure 7.10: Traffic in the most loaded cell. The light grey part represents the web, mail and streaming customers who have no incentives and are fixed. The dark grey part corresponds to the download customers in the cell without (left) and with (right) incentives

CHAPTER 8

Perspectives

In this chapter, we deal with some perspectives and further developments of the work presented in this thesis.

8.1 A branch-and-bound algorithm for a class of bilevel problems

In this thesis we have solved a class of bilevel programming problems introducing a polyhedral approach. The proposed method requires solving a large number of optimization subproblems (each problem being associated to a cell of a regular polyhedral subdivision). In Section 5.3, the corresponding algorithm has been shown to be polynomial in the low-level dimension, when the high-level dimension is fixed. However, as proved in the same section, the complexity bounds of such an algorithm can be very large even for small values of the high-level dimension. We already mentioned in Section 5.4 that the real time needed to solve such an algorithm can be much smaller than the worst-case complexity bound.

This algorithm is based on the enumeration of the faces of a certain polyhedron. Applying an algorithm proposed by Fukuda et al. [FLM97], we enumerate all the faces of the polyhedron. This enumeration has a tree structure: the d -dimensional faces are constructed as intersections of $(d + 1)$ -dimensional faces.

It could be relevant to use these tree structure to develop a branch-and-bound algorithm. We saw in Section 3.1 that branch-and-bound algorithms are very much used in bilevel programming, for solving continuous or discrete problems. The idea is to cut certain cells of the polyhedral complex defined by the low-level problem. Since we reduced the bilevel problem to a large

number of subproblems associated to the cells of this polyhedral complex, one could investigate if it is possible to obtain some bounds over the optimal values of certain subproblems. These bounds would guarantee that the value of these subproblems is not the optimal value of the bilevel problem.

One could also study if it is possible to develop a pivoting algorithm. The idea would be to define a path in the polyhedral complex by solving subproblems associated to neighbour cells. It could provide a "local" optimum in the following sense. We are looking for a cell such that the optimal value of the subproblem associated to this cell is better than the optimal value of the subproblems associated to all the "neighbor" cells.

8.2 Best possible upper bounds for the number of cells

In Chapter 5, we count the number of cells of a certain subdivision of the Newton polytope. This means that we estimate the f -vector of a certain polyhedral complex. We are interested in finding an upper bound to the different entries of this vector, in order to obtain an upper bound of the total complexity of Algorithm 2. In Section 5.2.1, we provide general upper bounds. However, these upper bounds are possibly not attainable. For instance, the upper bound we give in Theorem 5.12 consists in summing the total number of faces of each n -dimensional cell. This implies that a large number of cells are counted twice.

An open problem is to find the best possible upper bounds to the total number of cells of a regular subdivision of a polytope, such that the zero-dimensional cells are integer points. This means that we want to propose a certain subdivision of a polytope which attains the upper bound. We study in Section 5.2.2 the case of a simplex Δ_d , and we propose a particular subdivision $\text{Eds}(\Delta_d)$, called edgewise subdivision. We show that this subdivision has the maximal total number of faces in dimension less than 4. It is possible to show that the subdivision $\text{Eds}(\Delta_d)$ has the maximal number of 0-dimensional and n -dimensional cells. We conclude by using the Dehn-Sommerville equations. Since the Dehn-Sommerville equations give only $n/2$ linear independent equations between the entries of the f -vector of a polyhedral complex, such a reasoning can be applied only in small dimensions. We would be interested in generalizing this result to all dimensions.

8.3 Bounded price incentives for the congestion problem

In the second part of the thesis, we have considered an optimistic bilevel approach to tackle a congestion problem in mobile data networks. More precisely, a mobile service provider announces some discounts at certain times and in certain cells. The users determine their optimal consumption by maximizing their utility function. The provider wants to minimize a congestion measure, depending only on the optimal consumptions of the users, using discounts that can take any non-negative value.

As the provider cannot pay an infinite amount of money to incite the users to shift their data consumptions, these discounts must be bounded. This leads to the analysis of a bilevel problem under the constraint of bounded discounts. Adding this constraint implies that the high-level function also depends on the discounts proposed by the provider. Since all the polynomial time algorithms developed in this thesis solve bilevel problems in which the high-level function depends only on the low-level response, we have developed new algorithms in Chapter 4 that deal with these bounded discounts. However, such algorithm can have an exponential complexity in

the high-level dimension making them inefficient for a real implementation. Some perspectives have been proposed in Appendix C, where we have shown that it is possible to characterize the feasible set of the high-level problem.

8.4 A stochastic model for the congestion problem

An other perspective to improve the methods introduced in this thesis would consist in analyzing the relevance of the multiple assumptions we have made. More precisely, we have assumed that the provider knows for each user its trajectory and its preference measure to consume at the different time slots of the day. The observations of a mobile data network [YQZ⁺15], [PSBD11] have shown that the demand is actually daily periodic: the data consumption of the customers is approximately the same each day. The trajectory of the different users (who are mobile in the network) can be relatively well predicted [SQBB10]. Mobile users have standard trajectories (similar from one day to another one), like leaving home at morning to go work, and coming back at the evening. The variations from such standard trajectories are rare events. These standard trajectories can be identified by the mobile service provider (MSP), analyzing the data consumptions of the different customers of the network. Such an analysis has been done in [YQZ⁺15] showing large disparities between the behaviors of customers. Top 1 % users consume more than 80 % of the data traffic whereas the 70 % users who consume at least are responsible for only 0,21 % of the data traffic. These disparities have been taken into accounts introducing clusters of users (as big, medium, or small consumers). We have made the choice in this work to model the consumptions of the users by binary variables. The data consumption per day in the network show that the number of active users per day in the network is globally constant (between 2.84 and 2.95 million) even if there are not all active every day: 4.51 million different users were connected during the studied week. These data also show that the traffic is globally constant (between 8.52 and 8.71 terabytes) with a peak at January 1st at 9.20 terabytes. Finally, the relation between the packet numbers and the flow numbers is quite constant (between 1735 and 1780) during the week. This leads to a large correlation between the number of users and the traffic. This legitimates the modeling the user consumption by a binary value equal to 1 if the user is active and 0 if not.

To improve the efficiency of the method, it can be relevant to consider the observed trajectory and consumptions of the users instead of the predicted ones. This would lead to an adaptive model, in which the provider proposes discounts at each time t knows the past (the observed data until time $t - 1$) and predicts the future. This corresponds to a stochastic model for the congestion problem in mobile data networks.

The probabilistic aspect of the model comes from different problems. First, the trajectory cannot be exactly defined, even for the customer, at the beginning of the day as there can exist some events which have a significant probability to occur (for example at the evening: staying at home, going to the cinema or the restaurant, swimming ...). Then, even if the path of a customer is well known, the time slots in which he follows this path could be not well-defined (a customer can go work at 8 a.m. or 8.30 a.m.), which introduces a difficulty to predict the position of a customer at certain time. A new probabilistic model that exploits as more as possible the information known about the habits of the customer would consequently be a tremendous perspective for further improvements. With this approach, the trajectory of a customer could be modeled as a path in a tree, where to each of his different actions is associated a probability to switch from an action to another one.

Then, the provider has to predict the data consumptions of the different users. Different

types of applications have to be distinguished [EABG17]. Some kind of contents like mail or search do not need a lot of resources from the antenna as they do not generate a lot of traffic. Moreover, they are difficult to anticipate and to shift. For instance, a user can check his e-mails at fixed time or use mobile data during his trip "home-work", and no incentive mechanism has any effect on his behavior. Other contents like streaming, music needs a better throughput to ensure a minimal quality of service. However, they are also not movable. Finally, upload or download contents can generate a lot of traffic but seem to be movable (an user wishing to read the newspaper or to use a new application can download it previously whenever he wants).

In this extent, a stochastic model would enable to develop a real-time price incentives scheme. At each time slot t , the provider observes the situation in the network, knowing the standard behavior of the users and their past trajectory. Being able to estimate the probability that each user will be in each cell for each time slot $t' \geq t$ and its probability to consume at each further time, the provider solves a stochastic optimization problem to decide at time t whether he proposes price incentives or not and in which cells. This model is real-time since he solves a problem at each time slot t by using the observations of the network at each time slot $t' < t$. As such a model would lead to a huge scale optimization problem, some complementary assumptions would be necessary to develop applicable methods. For instance, we could study some clusters of users who have the same behavior (same total consumptions, same habits ...). Such an assumption would reduce the dimension of the problem and would enable to use this model to solve huge scale problems.

APPENDIX \mathcal{A}

Compactification of a polyhedron to enumerate its faces

A.1 Enumerating the faces

In this chapter, we provide another approach to enumerate the cells of the epigraph $\text{epi}(Q)$ of a tropical polynomial. This problem was studied in Section 5.1.2.

We recall that $\text{epi}(Q)$ is a $(n + 1)$ -dimensional polyhedron given by $n_{\mathbb{Z}}$ inequalities:

$$\text{epi}(Q) = \{(y, y_{n+1}) \in \mathbb{R}^n \times \mathbb{R} \mid \forall z \in C^T \mathcal{P} \cap \mathbb{Z}^n, y_{n+1} \geq \langle y, z \rangle + \varphi(z)\}.$$

We assume we already determined the set $\{(z, \varphi(z)) \mid z \in C^T \mathcal{P} \cap \mathbb{Z}^n\}$.

We present here how to define a polytope $\mathcal{P}(Q)$ which is a compactification of $\text{epi}(Q)$. In fact, we add one facet, that is one inequality, and show that the polyhedron obtained $\mathcal{P}(Q)$ is bounded. Then, we apply an algorithm proposed by Avis and Fukuda [AF92] to enumerate all the vertices of $\mathcal{P}(Q)$. We then determine the vertex-facet incidence matrix of $\mathcal{P}(Q)$ in order to apply an algorithm proposed by Kaibel and Pfetsch [KP02] to enumerate all the faces of $\mathcal{P}(Q)$. Finally, we deduce the faces of $\text{epi}(Q)$ by removing the added facet.

We recall that $V(Q)$ is the set of points $z \in C^T \mathcal{E}(\mathcal{P})$ such that $y \mapsto \langle y, z \rangle + \varphi(z)$ is an essential monomial. Let $z \in C^T \mathcal{P} \cap \mathbb{Z}^n$. Then, there exists a facet of $\text{epi}(Q)$ included in the hyperplane $\{(y, y_{n+1}) \in \mathbb{R}^n \times \mathbb{R} \mid y_{n+1} = \langle y, z \rangle + \varphi(z)\}$ if and only if $z \in V(Q)$.

We now explain how to define a polytope $\mathcal{P}(Q)$ by adding a facet to $\text{epi}(Q)$. Let z_0 be in the interior of $C^T \mathcal{P}$. Let V be the set of vertices of $\text{epi}(Q)$. Then, we define a real number M

Algorithm 6 Sketch of the algorithm to enumerate the faces of $\text{epi}(Q)$

1. Add a face to $\text{epi}(Q)$ to obtain a polytope $\mathcal{P}(Q)$
 2. Apply the Avis and Fukuda algorithm to obtain the vertices of $\mathcal{P}(Q)$
 3. Determine the vertex-facet incidence matrix of $\mathcal{P}(Q)$
 4. Apply the Kaibel and Pfetsch algorithm to obtain the faces of $\mathcal{P}(Q)$.
 5. Obtain the faces of $\text{epi}(Q)$
-

by $M = 1 + \max_{y \in V} [Q(y) - \langle y, z_0 \rangle]$. $\mathcal{P}(Q)$ is then defined as:

$$\mathcal{P}(Q) = \text{epi}(Q) \cap \{(y, y_{n+1}) \in \mathbb{R}^{n+1} \mid y_{n+1} \leq \langle y, z \rangle + M\}$$

We first have to show that $\mathcal{P}(Q)$ is bounded.

Proposition A.1. $\mathcal{P}(Q)$ is a polytope of \mathbb{R}^{n+1} .

Proof. Let $y \in \mathbb{R}^n$. Then, (y, y_{n+1}) belongs to $\mathcal{P}(Q)$ if and only if:

$$Q(y) \leq y_{n+1} \leq \langle y, z_0 \rangle + M$$

Thus, for a fixed $y \in \mathbb{R}^n$, y_{n+1} belongs to a segment. We next have to show that the set of values of $y \in \mathbb{R}^n$ such that there exists y_{n+1} with $(y, y_{n+1}) \in \mathcal{P}(Q)$ is bounded. For a fixed $y \in \mathbb{R}^n$, there exists y_{n+1} such that $(y, y_{n+1}) \in \mathcal{P}(Q)$ if and only if for each $z \in C^T \mathcal{P}$, $\langle y, z_0 \rangle + M \geq \langle y, z \rangle + \varphi(z)$, that is:

$$\forall z \in C^T \mathcal{P}, \langle y, z - z_0 \rangle \leq M - \varphi(z)$$

Because z_0 is in the interior of $C^T \mathcal{P}$, 0 is in the interior of $C^T \mathcal{P} - z_0$. For a vector $x \in \mathbb{R}^n$, we denote by $\text{sgn}(x) \in \{-1; 0; 1\}^n$ the vector whose i -th coordinate is equal to 0 if $x_i = 0$ and is equal to $\frac{x_i}{|x_i|}$ otherwise. Then, for each possible sign vector $s \in \{-1; 0; 1\}^n$, there exists $\varepsilon_s > 0$ such that $\varepsilon_s s \in C^T \mathcal{P} - z_0$, that is $z_0 + \varepsilon_s s \in C^T \mathcal{P}$. Let M' be defined by:

$$M' = \frac{M + 1 - \min_{z \in C^T \mathcal{P}} \varphi(z)}{\min_{s \in \{-1; 0; 1\}^n} \varepsilon_s}$$

We next show that a point $(y, y_{n+1}) \in \mathcal{P}(Q)$ is such that $y \in [-M', M']^n$. In fact, suppose that there exists a coordinate y_i such that $|y_i| > M'$. Take $s = \text{sgn}(y)$. Then $z = z_0 + \varepsilon_s s \in C^T \mathcal{P}$. Consequently:

$$\langle y, z - z_0 \rangle = \varepsilon_s \sum_{j=1}^n |y_j| \geq \varepsilon_s M' \geq 1 + M - \varphi(z)$$

by definition of M' . Thus, there does not exist a point $y_{n+1} \in \mathbb{R}$ such that $(y, y_{n+1}) \in \mathcal{P}(Q)$ if $\|y\|_\infty > M'$. \square

For each $0 \leq d \leq n$, the d -dimensional faces of $\mathcal{P}(Q)$ are related to the d -dimensional faces of $\text{epi}(Q)$. We clarify this relation.

Proposition A.2. *Let F be a d -dimensional face of $\text{epi}(Q)$ (with $0 \leq d \leq n$). The intersection $F \cap \mathcal{P}(Q)$ is non-empty and is a d -dimensional face of $\mathcal{P}(Q)$.*

Proof. Let F be a d -dimensional face of $\text{epi}(Q)$. There exists a cell $\mathcal{C} \in \mathcal{S}$ such that $F = \{(y, Q(y)) \in \mathbb{R}^n \times \mathbb{R} \mid y \in \mathcal{C}\}$. Moreover, F is defined by the following set of inequalities:

$$\begin{aligned} \forall z \in \phi(\mathcal{C}), y_{n+1} &= \langle y, z \rangle + \varphi(z) \\ \forall z \in C^T \mathcal{P} \setminus \phi(\mathcal{C}), y_{n+1} &\geq \langle y, z \rangle + \varphi(z) \end{aligned}$$

F has at least one vertex. Let (y^V, y_{n+1}^V) be such a vertex. We have $y_{n+1}^V = Q(y^V)$. By definition of M , we have $M \geq 1 + Q(y^V) - \langle y^V, z_0 \rangle$. Then, $y_{n+1}^V < \langle y^V, z_0 \rangle + M$, which means $(y^V, y_{n+1}^V) \in \mathcal{P}(Q)$. Moreover, (y^V, y_{n+1}^V) is in the interior of the half-space $\{(y, y_{n+1}) \mid y_{n+1} \leq \langle y, z_0 \rangle + M\}$. Thus, there exists $\varepsilon > 0$ such that $F \cap \mathcal{B}_\infty((y^V, y_{n+1}^V), \varepsilon) \subset \mathcal{P}(Q)$, where $\mathcal{B}_\infty((y^V, y_{n+1}^V), \varepsilon)$ is the ball centered in (y^V, y_{n+1}^V) of radius ε for the infinite norm, that is:

$$\mathcal{B}_\infty((y^V, y_{n+1}^V), \varepsilon) = \{(y, y_{n+1}) \in \mathbb{R}^{n+1} \mid \forall i \in [n+1], |y_i - y_i^V| \leq \varepsilon\}$$

Then, $F \cap \mathcal{B}_\infty((y^V, y_{n+1}^V), \varepsilon)$ is a k -dimensional polyhedron and:

$$F \cap \mathcal{B}_\infty((y^V, y_{n+1}^V), \varepsilon) \subset F \cap \mathcal{P}(Q) \subset \mathcal{P}(Q)$$

Consequently, $F \cap \mathcal{P}(Q)$ is a k -dimensional polyhedron, which is straightforwardly a face of $\mathcal{P}(Q)$. \square

Proposition A.3. *Let F be a k -dimensional face of $\mathcal{P}(Q)$ for $0 \leq k \leq n$. Then, exactly one of the two following assertions is true.*

1. *There exists a k -dimensional face F' of $\text{epi}(Q)$ such that $F = F' \cap \mathcal{P}(Q)$.*
2. *There exists a $k+1$ -dimensional face F' of $\text{epi}(Q)$ such that $F = F' \cap \{(y, y_{n+1}) \mid y_{n+1} = \langle y, z_0 \rangle + M\}$ (with the convention that $\text{epi}(Q)$ is a $n+1$ -dimensional face of $\text{epi}(Q)$).*

Proof. First, we prove that $\{(y, y_{n+1}) \mid y_{n+1} = \langle y, z_0 \rangle + M\}$ is a n -dimensional face of $\text{epi}(Q)$. Let (y^V, y_{n+1}^V) be any vertex of $\text{epi}(Q)$. Consider the point $(y^V, \langle y^V, z_0 \rangle + M)$. It belongs clearly to $\{(y, y_{n+1}) \mid y_{n+1} = \langle y, z_0 \rangle + M\}$. Moreover $\langle y^V, z_0 \rangle + M \geq 1 + Q(y^V)$. Then $(y^V, \langle y^V, z_0 \rangle + M)$ belongs to $\mathcal{P}(Q)$ but does not belong to any other face of $\mathcal{P}(Q)$. It means that there exists $\varepsilon > 0$ such that $\{(y, y_{n+1}) \mid y_{n+1} = \langle y, z_0 \rangle + M\} \cap \mathcal{B}_\infty((y^V, \langle y^V, z_0 \rangle + M), \varepsilon)$ is a n -dimensional polyhedron included in $\mathcal{P}(Q)$. This concludes that $\{(y, y_{n+1}) \mid y_{n+1} = \langle y, z_0 \rangle + M\}$ is a n -dimensional face of $\mathcal{P}(Q)$. Then, the n -dimensional faces of $\mathcal{P}(Q)$ are exactly the intersection of the n -dimensional faces of $\text{epi}(Q)$ with the half-space $\{(y, y_{n+1}) \mid y_{n+1} \leq \langle y, z_0 \rangle + M\}$ or the face $\{(y, y_{n+1}) \mid y_{n+1} = \langle y, z_0 \rangle + M\}$. This establishes the statement of the proposition for the case $d = n$. Let $d < n$ and F be a d -dimensional face of $\mathcal{P}(Q)$. The polytope $\mathcal{P}(Q)$ is defined by the inequalities:

$$\begin{aligned} \forall z \in V(Q), y_{n+1} &\geq \langle y, z \rangle + \varphi(z) \\ y_{n+1} &\leq \langle y, z_0 \rangle + M \end{aligned}$$

Each of this inequality corresponds hence to a n -dimensional face of $\mathcal{P}(Q)$. Consequently, F is characterized by exactly $n+1-d$ equalities among these inequalities. If $y_{n+1} = \langle y, z_0 \rangle + M$ is one of those equalities, then $F = F' \cap \{(y, y_{n+1}) \mid y_{n+1} = \langle y, z_0 \rangle + M\}$ where F' is a face of $\text{epi}(Q)$ characterized by $n-d$ equalities, so a $d+1$ -dimensional face of $\text{epi}(Q)$. If not, then $F = F' \cap \mathcal{P}(Q)$ where F' is a face of $\text{epi}(Q)$ characterized by the same $n+1-d$ equalities than F . Hence, it is a d -dimensional face of $\text{epi}(Q)$. \square

The polytope $\mathcal{P}(Q)$ is defined by a list of inequalities. Thus, by applying the Avis-Fukuda algorithm [AF92], it is possible to enumerate all the vertices of $\mathcal{P}(Q)$. We can now build the vertex-facet incidence matrix of $\mathcal{P}(Q)$. However, we do not know precisely the set $V(Q)$ of points $z \in C^T\mathcal{P} \cap \mathbb{Z}^n$ such that a n -dimensional face of $\mathcal{P}(Q)$ is included in $y_{n+1} = \langle y, z \rangle + \varphi(z)$. Then, we build a matrix with $n_{\mathbb{Z}} + 1$ lines and a column per vertex of $\mathcal{P}(Q)$. For each $z \in C^T\mathcal{P} \cap \mathbb{Z}^n$, there is a line of the matrix corresponding to the following face of $\mathcal{P}(Q)$:

$$\begin{aligned} y_{n+1} &= \langle y, z \rangle + \varphi(z) \\ \forall z' \in C^T\mathcal{P} \cap \mathbb{Z}^n \text{ with } z' \neq z, y_{n+1} &\geq \langle y, z' \rangle + \varphi(z') \\ y_{n+1} &\leq \langle y, z_0 \rangle + M \end{aligned}$$

The last line corresponds to the following face of $\mathcal{P}(Q)$:

$$\begin{aligned} y_{n+1} &= \langle y, z_0 \rangle + M \\ \forall z' \in C^T\mathcal{P} \cap \mathbb{Z}^n, y_{n+1} &\geq \langle y, z' \rangle + \varphi(z') \end{aligned}$$

For each of these faces f and for each vertex v of $\mathcal{P}(Q)$, we take $a_{fv} = 1$ if $v \in f$ and $a_{fv} = 0$ otherwise. As explained previously, the last face is a n -dimensional face of $\mathcal{P}(Q)$. The previous faces are n -dimensional if and only if the corresponding $z \in V(Q)$. We can now identify the set $V(Q)$.

Proposition A.4. *Let $z \in C^T\mathcal{P} \cap \mathbb{Z}^n$. If the number of vertices of $\mathcal{P}(Q)$ contained in the hyperplane $y_{n+1} = \langle y, z \rangle + \varphi(z)$ is less or equal than n , then there exists no n -dimensional face F of $\mathcal{P}(Q)$ included in $y_{n+1} = \langle y, z \rangle + \varphi(z)$.*

Proof. If the hyperplane $y_{n+1} = \langle y, z \rangle + \varphi(z)$ contains a n -dimensional face F of $\mathcal{P}(Q)$, then it contains the vertices of F . Because F is a n -dimensional polytope, it contains at least $n + 1$ vertices. Conversely, suppose that $n + 1$ vertices of $\mathcal{P}(Q)$ belong to $y_{n+1} = \langle y, z \rangle + \varphi(z)$. \square

Proposition A.5. *Let $z \in C^T\mathcal{P} \cap \mathbb{Z}^n$. Then, there exists a n -dimensional face F of $\mathcal{P}(Q)$ included in $\{(y, y_{n+1} \mid y_{n+1} = \langle y, z \rangle + \varphi(z))\}$ if and only if for each $z' \in C^T\mathcal{P} \cap \mathbb{Z}^n$, the set of vertices of $\mathcal{P}(Q)$ contained in $\{(y, y_{n+1} \mid y_{n+1} = \langle y, z \rangle + \varphi(z))\}$ is not included in the set of vertices of $\mathcal{P}(Q)$ contained in $\{(y, y_{n+1} \mid y_{n+1} = \langle y, z' \rangle + \varphi(z'))\}$.*

Proof. Suppose that there exists a n -dimensional face F of $\mathcal{P}(Q)$ included in $\{(y, y_{n+1} \mid y_{n+1} = \langle y, z \rangle + \varphi(z))\}$. If the set of vertices of $\mathcal{P}(Q)$ contained in $\{(y, y_{n+1} \mid y_{n+1} = \langle y, z \rangle + \varphi(z))\}$ is included in the set of vertices of $\mathcal{P}(Q)$ contained in $\{(y, y_{n+1} \mid y_{n+1} = \langle y, z' \rangle + \varphi(z'))\}$ for some $z' \in C^T\mathcal{P} \cap \mathbb{Z}^n$, then F is also included in the hyperplane $\{(y, y_{n+1} \mid y_{n+1} = \langle y, z' \rangle + \varphi(z'))\}$. Then, F cannot be a n -dimensional polyhedron.

Conversely, suppose that for each $z' \in C^T\mathcal{P} \cap \mathbb{Z}^n$, the set of vertices of $\mathcal{P}(Q)$ contained in $\{(y, y_{n+1} \mid y_{n+1} = \langle y, z \rangle + \varphi(z))\}$ is not included in the set of vertices of $\mathcal{P}(Q)$ contained in $\{(y, y_{n+1} \mid y_{n+1} = \langle y, z' \rangle + \varphi(z'))\}$. Let F be the convex hull of the vertices of $\mathcal{P}(Q)$ contained in $\{(y, y_{n+1} \mid y_{n+1} = \langle y, z \rangle + \varphi(z))\}$. $F \neq \emptyset$ because \emptyset is included in the set of vertices of $\mathcal{P}(Q)$ contained in $\{(y, y_{n+1} \mid y_{n+1} = \langle y, z' \rangle + \varphi(z'))\}$ for each $z' \in C^T\mathcal{P} \cap \mathbb{Z}^n$. If F is not a n -dimensional polyhedron, then there exists a n -dimensional face F' of $\mathcal{P}(Q)$ such that $F \subsetneq F'$. There exists $z' \in C^T\mathcal{P} \cap \mathbb{Z}^n$ with $z' \neq z$ such that $F' \subset \{(y, y_{n+1} \mid y_{n+1} = \langle y, z' \rangle + \varphi(z'))\}$. It is impossible because $\{(y, y_{n+1} \mid y_{n+1} = \langle y, z \rangle + \varphi(z))\} \neq \{(y, y_{n+1} \mid y_{n+1} = \langle y, z' \rangle + \varphi(z'))\}$. \square

Proposition A.4 and Proposition A.5 enable us to eliminate the hyperplanes which does not correspond to a n -dimensional face of $\mathcal{P}(Q)$. In fact, we eliminate first the hyperplanes which contain less or equal than n vertices of $\mathcal{P}(Q)$ according to Proposition A.4, that is the lines of the vertex-facet incidence matrix A with less or equal than n components equal to 1. After that, for each couples of faces (f, f') , we compare the vertices belonging to f and to f' . If the vertices contained in f belong all to f' , that is if for each v , $a_{fv} \leq a_{f'v}$, then we remove the line associated to f according to Proposition A.5. The remaining lines correspond exactly to the n -dimensional faces of $\mathcal{P}(Q)$. Excepting the last face (which is included in $\{(y, y_{n+1}) \mid y_{n+1} = \langle y, z_0 \rangle + M\}$), the other lines of this matrix correspond exactly to the restriction to $\mathcal{P}(Q)$ of the n -dimensional faces of $\text{epi}(Q)$ according to Proposition A.3. Thus, as a consequence of the definition of $V(Q)$, the set $V(Q)$ correspond to the elements of \mathcal{S}_n .

We can now write an algorithm to determine all the cells of \mathcal{S}_n . It leads to Algorithm 7. We introduce the function *AvisFukuda* which associates to a list L_I of linear inequalities of the type $A_i x \leq b_i$ a list L_V of all the vertices of the polyhedron $\{x \mid Ax \leq b\}$.

Theorem A.6. *Algorithm 7 terminates and returns all the cells of \mathcal{S}_n in $O(n_{\mathbb{Z}}^2(v + n \binom{n_{\mathbb{Z}}}{n}))$ time complexity. where v is the number of vertices of $\mathcal{P}(Q)$ and $n_{\mathbb{Z}} = \#(C^T \mathcal{P} \cap \mathbb{Z}^n)$.*

Proof. Algorithm 7 constructs $\mathcal{P}(Q)$, determines all the vertices of $\mathcal{P}(Q)$ thanks the Avis-Fukuda algorithm, constructs the vertex-facet incidence matrix of $\mathcal{P}(Q)$ and keeps only the hyperplanes corresponding to a facet of $\mathcal{P}(Q)$ according to Proposition A.4 and Proposition A.5. Hence, by duality, it returns the set V' of points z such that (z, z_{n+1}) is a vertex of $\overline{\text{New}}(Q)$, that is $\{z\} \in \mathcal{S}'_0$. The corresponding cell in \mathcal{S}_n is defined by the inequalities:

$$\forall z' \in C^T \mathcal{P} \cap \mathbb{Z}^n, \langle y, z \rangle + \varphi(z) \geq \langle y, z' \rangle + \varphi(z')$$

We now evaluate the complexity of the algorithm. Let v be the number of vertices of $\mathcal{P}(Q)$. $O(bn)$ operations are necessary to write the inequalities defining $\text{epi}(Q)$. $\text{epi}(Q)$ is a n -dimensional polyhedron defined by $n_{\mathbb{Z}}$ inequalities. Thus, we need $O(n_{\mathbb{Z}}^2 n \binom{n_{\mathbb{Z}}}{n})$ to obtain the vertices of $\text{epi}(Q)$. For each vertex (y, y_{n+1}) , the value of $Q(y)$ is obtained directly, because $Q(y) = y_{n+1}$ (the vertices of $\text{epi}(Q)$ belong to $\text{gph}(Q)$). Thus, $O(n_{\mathbb{Z}})$ operations are needed to evaluate M . Again, we need $O(n_{\mathbb{Z}}^2 n \binom{n_{\mathbb{Z}}}{n})$ to obtain the vertices of $\mathcal{P}(Q)$. $O(n_{\mathbb{Z}}v)$ operations are necessary to define the vertex-facet incidence matrix of $\mathcal{P}(Q)$ and finally we eliminate the hyperplanes which do not correspond to any facet of $\mathcal{P}(Q)$ in $O(n_{\mathbb{Z}}^2 v)$ operations. \square

When the vertex-facet incidence matrix of $\mathcal{P}(Q)$ is known, we can apply the algorithm of Kaibel and Pfetsch [KP02] to obtain all the d -dimensional faces of $\mathcal{P}(Q)$. In fact, the algorithm proposed by Kaibel and Pfetsch constructs the face lattice of $\mathcal{P}(Q)$ by adding faces with higher dimensions than the faces already added in the lattice. It means than the faces are constructed as the convex hull of their vertices. To better correspond to our problem, we apply the algorithm of Kaibel and Pfetsch to the transpose of the vertex-facet incidence matrix. It corresponds to vertex-facet incidence matrix of a dual polytope, in the same sense as the duality between $\text{epi}(Q)$ and $\overline{\text{New}}(Q)$. Hence, enumerating all the faces of this dual polytope is equivalent to enumerate all the faces of $\mathcal{P}(Q)$ as the intersections of n -dimensional faces. Then, we eliminate the faces which belong to $\{(y, y_{n+1}) = \langle y, z_0 \rangle + M\}$ and keep the other ones. If a face is defined by a subset $\tilde{V} \subset V'$ such that $\forall z \in \tilde{V}, y_{n+1} = \langle y, z \rangle + \varphi(z)$ and $\forall z' \notin \tilde{V}, y_{n+1} \geq \langle y, z' \rangle + \varphi(z')$, then the corresponding cell $\mathcal{C} \in \mathcal{S}$ is obtained by:

$$\begin{aligned} \forall z, z' \in \tilde{V}, \langle y, z \rangle + \varphi(z) &= \langle y, z' \rangle + \varphi(z') \\ \forall z \in \tilde{V}, z' \notin \tilde{V} \langle y, z \rangle + \varphi(z) &\geq \langle y, z' \rangle + \varphi(z') \end{aligned}$$

Algorithm 7 Enumeration of the cells of \mathcal{S}_n

Require: Points $(z, \varphi(z)) \forall z \in C^T\mathcal{P} \cap \mathbb{Z}^n$, point z_0 in the interior of $C^T\mathcal{P}$.

Ensure: Vertex-facet incidence matrix U of $\mathcal{P}(Q)$; List L of n -dimensional cells of the subdivision \mathcal{S} of $\mathcal{T}(Q)$; List L' of the dual cells

$L_I = \emptyset$

for all $z \in C^T\mathcal{P} \cap \mathbb{Z}^n$ **do**

$L_I \leftarrow L_I \cup \{y_{n+1} \geq \langle y, z \rangle + \varphi(z)\}$

end for

$L_V \leftarrow \text{AvisFukuda}(L_I)$ {Enumerate the vertices of $\text{epi}(Q)$ }

$M = 1 + \max_{y \in L_V} [Q(y) - \langle y, z_0 \rangle]$

$L_I \leftarrow L_I \cup \{y_{n+1} \leq \langle y, z_0 \rangle + M\}$

$L_V \leftarrow \text{AvisFukuda}(L_I)$ {Enumerate the vertices of $\mathcal{P}(Q)$ }

$f = 1$

for all $z \in C^T\mathcal{P} \cap \mathbb{Z}^n$ **do**

$v = 1$

for all $\{(y, y_{n+1})\} \in L_V$ **do**

if $y_{n+1} = \langle y, z \rangle + \varphi(z)$ **then**

$U_{fv} = 1$

else

$U_{fv} = 0$

end if

$v \leftarrow v + 1$

end for

if $\sum_v U_{fv} \leq n$ **then**

Remove line f in U ; $L_I \leftarrow L_I \setminus \{y_{n+1} \geq \langle y, z \rangle + \varphi(z)\}$; $f \leftarrow f - 1$

end if

$f \leftarrow f + 1$

end for

for all $i, j \in [f]$ **do**

if For each $k \in [v]$, $U_{ik} \leq U_{jk}$ **then**

Remove line i in U ; for the corresponding z do $L_I \leftarrow L_I \setminus \{y_{n+1} \geq \langle y, z \rangle + \varphi(z)\}$

end if

end for

$L = \emptyset$ $L' = \emptyset$ {Create the list of cells of \mathcal{S}_n and \mathcal{S}'_0 }

for all $\{y_{n+1} \geq \langle y, z \rangle + \varphi(z)\} \in L_I$ **do**

$L = L \cup \{y_{n+1} = \langle y, z \rangle + \varphi(z), \forall z' \in C^T\mathcal{P} \cap \mathbb{Z}^n, y_{n+1} \geq \langle y, z' \rangle + \varphi(z')\}$

$L' = L' \cup \{z\}$

end for

and the dual cell is $\phi(\mathcal{C}) = \text{Conv}(\tilde{V})$.

It leads to Algorithm 8 to enumerate the different cells of $\mathcal{P}(Q)$. We introduce a function *KaibelPfetsch* which associates to a vertex-facet incidence matrix U a list L_F containing all the faces of the corresponding polytope

Algorithm 8 Enumeration of all the faces of \mathcal{S}

Require: Points $(z, \varphi(z)) \forall z \in \mathcal{B}$, Point z_0 in the interior of $C^T \mathcal{P}$

Ensure: List L of cells of the subdivision \mathcal{S} of $\mathcal{T}(Q)$; List L' of the dual cells

Apply Algorithm 7 to obtain the vertex-facet incidence matrix U of $\mathcal{P}(Q)$

$L_F \leftarrow \text{KaibelPfetsch}(U^T)$

$L = \emptyset \quad L' = \emptyset$

for all $F \in L_F$ **do**

if F is not included in $\{(y, y_{n+1}) \mid \langle y, z_0 \rangle + M\}$ **then**

 Define \tilde{V} as the set of vertices in V' such that $F = \{(y, y_{n+1}) \mid \forall z \in \tilde{V}, y_{n+1} = \langle y, z \rangle + \varphi(z), \forall z' \notin \tilde{V}, y_{n+1} \geq \langle y, z \rangle + \varphi(z), y_{n+1} \leq \langle y, z_0 \rangle + M\}$

$L = L \cup \{\forall z, z' \in \tilde{V}, \langle y, z \rangle + \varphi(z) = \langle y, z' \rangle + \varphi(z'), \forall z \in \tilde{V}, z' \notin \tilde{V}, \langle y, z \rangle + \varphi(z) \geq \langle y, z' \rangle + \varphi(z')\}$

$L' = L' \cup \{\text{Conv } \tilde{V}\}$

end if

end for

Theorem A.7. *Algorithm 8 terminates and returns all the cells of \mathcal{S} in $O(n_{\mathbb{Z}}^2(v + n \binom{n_{\mathbb{Z}}}{n})) + \min(f_n, v)\alpha f$ time complexity, where $n_{\mathbb{Z}} = \#(C^T \mathcal{P} \cap \mathbb{Z}^n)$, α is the number of ones in U , v the number of vertices of $\mathcal{P}(Q)$, f_n the number of n -dimensional faces in $\mathcal{P}(Q)$ and f the total number of faces of $\mathcal{P}(Q)$.*

Proof. The vertex-facet incidence matrix U can be obtained in $O(n_{\mathbb{Z}}^2(v + n \binom{n_{\mathbb{Z}}}{n}))$ time according to Theorem A.6. The complexity of Kaibel-Pfetsch algorithm is $O(\min(f_n, v)\alpha f)$, where α is the number of ones in U , f_n the number of n -dimensional faces in $\mathcal{P}(Q)$ and f the total number of faces of $\mathcal{P}(Q)$. The creation of the different lists can be done in $O(f)$ operations, each face of $\mathcal{P}(Q)$ being given by its corresponding set \tilde{V} of supporting hyperplanes if we apply the algorithm to the matrix U^T . \square

A.2 Estimating the number of faces

In this section, we try to estimate the different combinatorial parameters introduced in the complexities of the previous algorithms, that is the number of vertices, full-dimensional faces or total number of faces of $\mathcal{P}(Q)$. We use the results of Section 5.2.

We denote by $f(\mathcal{P}(Q))$ the f -vector of $\mathcal{P}(Q)$, that is for each $0 \leq d \leq n$, $f_d(\mathcal{P}(Q))$ is the number of d -dimensional faces of $\mathcal{P}(Q)$. We recall that $f(\mathcal{S})$ is the f -vector of the subdivision \mathcal{S} , defined similarly.

In order to refine the complexity estimates of Algorithm 8 and 7, provided respectively by Theorem A.7 and A.6, we can give an upper bound about the components of the f -vector of $\mathcal{P}(Q)$

Theorem A.8. 1. $f_n(\mathcal{P}(Q)) = 1 + f_n(\mathcal{S})$

2. $f_0(\mathcal{P}(Q)) \leq f_0(\mathcal{S}) + f_1(\mathcal{S})$
3. $\sum_{d=0}^n f_d(\mathcal{P}(Q)) \leq 2 \sum_{d=0}^n f_d(\mathcal{S})$

Proof. By Proposition A.3, the d -dimensional faces of $\mathcal{P}(Q)$ are either d -dimensional faces of $\text{epi}(Q)$, or the intersection of $d + 1$ -dimensional faces of $\text{epi}(Q)$ with the hyperplane $\{(y, y_{n+1}) \mid \langle y, z_0 \rangle + M\}$. The number of d -dimensional faces of $\text{epi}(Q)$ is equal to $f_d(\mathcal{S})$. It follows that from each $0 \leq d \leq n - 1$:

$$f_d(\mathcal{P}(Q)) \leq f_d(\mathcal{S}) + f_{d+1}(\mathcal{S})$$

$\mathcal{P}(Q)$ is constructed by adding one face to $\text{epi}(Q)$, so $f_n(\mathcal{P}(Q)) = f_n(\mathcal{S}) + 1$. By summing these different inequalities and by using $f_0(\mathcal{S}) \geq 1$, we obtain the third assertion. \square

Corollary A.9. 1. $f_n(\mathcal{P}(Q)) \leq 1 + n + n! \text{Vol}(C^T \mathcal{P})$

2. $f_0(\mathcal{P}(Q)) \leq (n + 2)n! \text{Vol}(C^T \mathcal{P})$
3. $\sum_{d=0}^n f_d(\mathcal{P}(Q)) \leq (2^{n+2} - 2)n! \text{Vol}(C^T \mathcal{P})$

Proof. The upper bound of $f_n(\mathcal{P}(Q))$ and $\sum_{d=0}^n f_d(\mathcal{P}(Q))$ comes directly from Theorem A.8 and from the results of respectively Corollary 5.11 and Theorem 5.12. To obtain an upper bound of $f_0(\mathcal{P}(Q))$, we have to obtain an upper bound of $f_1(\mathcal{S}) = f_{n-1}(\mathcal{S}')$. \mathcal{S}' is a subdivision of $C^T \mathcal{P}$. Suppose it maximizes the number of $n - 1$ -dimensional cells of a subdivision of $C^T \mathcal{P}$. Then it is a triangulation. It would be possible to triangulate the non-simplicial n -dimensional cells otherwise, which increases the number $n - 1$ -dimensional cells of the subdivision. The number of $(n - 1)$ -dimensional faces of a simplex is $n + 1$. Then, we have:

$$f_{n-1}(\mathcal{S}') \leq (n + 1)f_n(\mathcal{S}') \leq (n + 1)n! \text{Vol}(C^T \mathcal{P})$$

Then, $f_0(\mathcal{P}(Q)) \leq (n + 2)n! \text{Vol}(C^T \mathcal{P})$ by using Proposition 5.8. \square

Corollary A.10. *The number α of ones in the vertex-facet incidence matrix of $\mathcal{P}(Q)$ is such that:*

$$\alpha \leq (n + 2)n! \text{Vol}(C^T \mathcal{P})[1 + n + n! \text{Vol}(C^T \mathcal{P})]$$

Proof. By definition of the vertex-facet incidence matrix of $\mathcal{P}(Q)$, the number α satisfies $\alpha \leq f_0(\mathcal{P}(Q))f_n(\mathcal{P}(Q))$. We conclude by Corollary A.9. \square

APPENDIX \mathcal{B}

Proof of Theorem 6.5

B.1 Sketch of the proof

In this chapter, we provide a proof of Theorem 6.5, that we recall:

Theorem B.1. *Let P_1, \dots, P_k be k tropical polynomials in \mathbb{R}^n , with tropical hypersurfaces denoted by $\mathcal{T}(P_1), \dots, \mathcal{T}(P_k)$ and with Newton polytopes respectively denoted by $\Delta_1, \dots, \Delta_k$. Assume that the k tropical hypersurfaces are in general position. Consider k non-negative integers q_1, \dots, q_k such that $\sum_{i=1}^k q_i = n$. The number of apices x of the tropical hypersurface $\mathcal{T}(P_1 \odot \dots \odot P_k)$ such that, for every $i \in [k]$, at least $q_i + 1$ monomials are maximal for P_i in x is less or equal than:*

$$n!V(\Delta_1, \dots, \Delta_k; q_1, \dots, q_k),$$

where $V(\Delta_1, \dots, \Delta_k; q_1, \dots, q_k)$ is the mixed volume $V(\Delta_1, \dots, \Delta_1, \dots, \Delta_k, \dots, \Delta_k)$ in which each Δ_i appears q_i times.

The idea of the proof is the following. For every $1 \leq i \leq k$, we write:

$$P_i(x) = \max_{1 \leq j \leq p_i} [c_j^i + \langle x, a_j^i \rangle].$$

We consider $q = (q_1, \dots, q_k)$ a partition of n , that is $\sum_{i=1}^k q_i = n$, with every $q_i \in \mathbb{N}$. We denote by X_q the set of apices of the arrangement of tropical hypersurfaces $\mathcal{T}(P_1), \dots, \mathcal{T}(P_k)$ such that, for every $i \in [k]$, at least $q_i + 1$ monomials are maximal for P_i in x .

We idea is to introduce q_i small generic perturbations of each P_i . Then, for every $i \in [k]$, we define q_i polynomials $P_i^1, \dots, P_i^{q_i}$ such that $\forall l \in [q_i]$:

$$P_i^l(x) = \max_{1 \leq j \leq p_i} [c_j^i + \varepsilon_{j,l}^i + \langle x, a_j^i \rangle],$$

where $\varepsilon_{j,l}^i$ are "small" and randomly defined such that $\forall j, j' \in [p_i]$ and $\forall l, l' \in [q_i]$:

$$\varepsilon_{j,l}^i - \varepsilon_{j',l}^i \neq \varepsilon_{j,l'}^i - \varepsilon_{j',l'}^i.$$

For every $l \in [q_i]$, the tropical hypersurface $\mathcal{T}(P_i^l)$ is then "close" from the tropical hypersurface $\mathcal{T}(P_i)$. Moreover, the Newton polytope of each tropical polynomial P_i^l is Δ_i . Since the perturbations are generic, the number of intersection points of the n tropical hypersurfaces P_i^l for every $i \in [k]$ and every $l \in [q_i]$ is equal to:

$$n!V(\Delta_1, \dots, \Delta_k; q_1, \dots, q_k),$$

where $V(\Delta_1, \dots, \Delta_k; q_1, \dots, q_k)$ is the mixed volume $V(\Delta_1, \dots, \Delta_1, \dots, \Delta_k, \dots, \Delta_k)$ in which each Δ_i appears q_i times, according to Theorem 3.16.

We prove that in a certain "small ball" centered in every $x \in X_q$, we can find an intersection point of the n tropical hypersurfaces $\mathcal{T}(P_i^l)$, for every $i \in [k]$ and $l \in [q_i]$. An example is shown on Figure B.1. We consider the arrangement of two tropical hypersurfaces in dimension 2 corresponding to the tropical polynomials:

$$\begin{aligned} P_1(x) &= \max(x_1, x_2, 0), \\ P_2(x) &= \max(x_1 + x_2 + 2, x_1 + 1, x_2 + 1, 0). \end{aligned}$$

The arrangement of tropical hypersurfaces can be found in Figure 6.1, in Chapter 6. We have $\Delta_1 = \text{New}(P_1) = \text{Conv}((0, 0), (0, 1), (1, 0))$, $\Delta_2 = \text{New}(P_2) = \text{Conv}((0, 0), (0, 1), (1, 0), (1, 1))$. Hence:

$$2V(\Delta_1, \Delta_1) = 1, \quad 2V(\Delta_2, \Delta_2) = 2, \quad 2V(\Delta_1, \Delta_2) = 2.$$

The number of intersection points between $\mathcal{T}(P_1)$ and $\mathcal{T}(P_2)$ is directly given by Theorem 3.16 as equal to 2. On Figure B.1, we introduce a small perturbation of $\mathcal{T}(P_1)$, and we see that in a small ball (blue ball) around all the apices of $\mathcal{T}(P_1)$, we find an intersection between $\mathcal{T}(P_1)$ and the perturbed $\mathcal{T}(P_1)$. We deduce that the number of apices of $\mathcal{T}(P_1)$ is less or equal than 1. We do the same thing for $\mathcal{T}(P_2)$, and we deduce that the number of apices of $\mathcal{T}(P_2)$ is less or equal than 2. In fact, the number of apices of $\mathcal{T}(P_2)$ is only 1, meaning that we provide only an upper bound.

B.2 Proof

For all $1 \leq i \leq k$, we write $P_i(x) = \max_{1 \leq j \leq p_i} [c_j^i + \langle x, a_j^i \rangle]$. Let X_q be the set of apices of the arrangement of tropical hypersurfaces $\mathcal{T}(P_1), \dots, \mathcal{T}(P_k)$ such that, for every $i \in [k]$, at least $q_i + 1$ monomials are maximal for P_i in x . When the tropical hypersurfaces $\mathcal{T}(P_1), \dots, \mathcal{T}(P_k)$ are in general position, X_q contains a finite number of points if it is not empty. Consider $i \in [k]$.

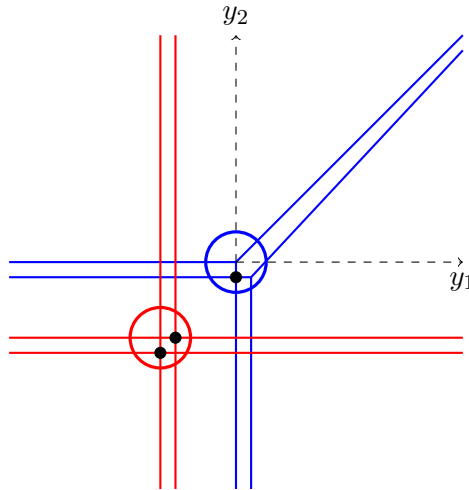

Figure B.1: Arrangement of perturbed tropical hypersurfaces: the blue ones are $\mathcal{T}(P_1)$ together with its perturbation, the red ones are $\mathcal{T}(P_2)$ together with its perturbation. The blue circle is centered in the apex of $\mathcal{T}(P_1)$, the red one is centered in the apex of $\mathcal{T}(P_2)$. We see that there exists at least one intersection point of the two "copies" of each tropical hypersurface in every circle.

For all $x \in X_q$, the value of exactly $q_i + 1$ monomials in P_i is equal to $P_i(x)$, the value of the other one being strictly less than $P_i(x)$. We define $R_1 > 0$ by:

$$R_1 = \min_{i \in [k]} \min_{x \in X_q} \left[P_i(x) - \max_{\substack{1 \leq i \leq p_i \\ c_j^i + \langle x, a_j^i \rangle < P_i(x)}} c_j^i + \langle x, a_j^i \rangle \right]$$

For all $x \in \mathbb{R}^n$, we define $\|x\|_\infty = \max_{1 \leq i \leq n} |x_i|$. For all $x \in \mathbb{R}^n$ and $r > 0$, we define the ball $\mathcal{B}^\infty(x, r) = \{y \in \mathbb{R}^n \mid \|y - x\|_\infty \leq r\}$. Then, we define $R_2 > 0$ such that $\forall x, x' \in X_q$, $\mathcal{B}^\infty(x, R_2) \cap \mathcal{B}^\infty(x', R_2) = \emptyset$.

Consider a point $x \in X_q$. It is defined by n equalities, q_i for each tropical polynomial P_i , that is for each $i \in [k]$, there exists $q_i + 1$ indices $j(i, 1), \dots, j(i, q_i + 1)$ such that

$$c_{j(i,1)}^i + \langle a_{j(i,1)}^i, x \rangle = \dots = c_{j(i,q_i+1)}^i + \langle a_{j(i,q_i+1)}^i, x \rangle$$

It means that x is defined by a system $Ax = c$, where $A \in \mathcal{M}_n(\mathbb{R})$ is a matrix with for all $i \in [k]$ exactly q_i lines equal to $a_{j(i,l)}^i - a_{j(i,l')}^i$ with $l, l' \in [q_i + 1]$. We define $M \in \mathbb{N}^*$ and $R_3 > 0$ by:

$$M = \max_{1 \leq i \leq k} \max_{1 \leq j, j' \leq p_i} \|a_j^i - a_{j'}^i\|_\infty, \quad R_3 = \min\left(\frac{R_1}{3nM}, R_2\right)$$

We consider the subset \mathcal{A} of $GL_n(\mathbb{R})$ of invertible matrices with, for each $i \in [k]$, exactly q_i lines equal to $a_{j(i,l)}^i - a_{j(i,l')}^i$ with $l, l' \in [q_i + 1]$. The set \mathcal{A} is finite. We define $R_4 > 0$ by:

$$R_4 = R_3 \times \min\left(1, \frac{1}{n \max_{A \in \mathcal{A}} \|A^{-1}\|_\infty}\right)$$

We define q_i polynomials $P_i^1, \dots, P_i^{q_i}$ such that $\forall l \in [q_i]$:

$$P_i^l(x) = \max_{1 \leq j \leq p_i} [c_j^i + \varepsilon_{j,l}^i + \langle x, a_j^i \rangle]$$

where $0 < \varepsilon_{j,l}^i < R_4$ are randomly defined such that $\forall j, j' \in [p_i]$ and $\forall l, l' \in [q_i]$:

$$\varepsilon_{j,l}^i - \varepsilon_{j',l}^i \neq \varepsilon_{j,l'}^i - \varepsilon_{j',l'}^i$$

The n polynomials $P_1^1, \dots, P_1^{q_1}, \dots, P_k^1, \dots, P_k^{q_k}$ are generically defined. Hence, according to Theorem 3.16, the number of intersection points of their tropical hypersurfaces is generically:

$$n!V(\text{New}(P_1^1), \dots, \text{New}(P_1^{q_1}), \dots, \text{New}(P_k^1), \dots, \text{New}(P_k^{q_k})) = n!V(\Delta_1, \dots, \Delta_k \mid q_1, \dots, q_k)$$

Consider $\hat{x} \in X_q$ and an index $i \in [k]$. There are $q_i + 1$ maximal monomials at point \hat{x} . We denote by $j_{\hat{x}}(i, \alpha)$ for $1 \leq \alpha \leq q_i + 1$ the indices of the maximal monomials in \hat{x} , that is :

$$\begin{aligned} \forall 1 \leq \alpha \leq q_i + 1, P_i(\hat{x}) &= c_{j_{\hat{x}}(i, \alpha)}^i + \langle \hat{x}, a_{j_{\hat{x}}(i, \alpha)}^i \rangle \\ \forall j \notin \{j_{\hat{x}}(i, \alpha) \mid 1 \leq \alpha \leq q_i + 1\}, P_i(\hat{x}) &> c_j^i + \langle \hat{x}, a_j^i \rangle \end{aligned}$$

Take $\alpha \in [q_i + 1]$, $j \notin \{j_{\hat{x}}(i, \alpha) \mid 1 \leq \alpha \leq q_i + 1\}$ and a point $y \in \mathcal{B}^\infty(\hat{x}, R_3)$. Then:

$$\begin{aligned} & [c_j^i + \varepsilon_{j,l}^i + \langle y, a_j^i \rangle] - [c_{j_{\hat{x}}(i, \alpha)}^i + \varepsilon_{j_{\hat{x}}(i, \alpha), l}^i + \langle y, a_{j_{\hat{x}}(i, \alpha)}^i \rangle] \\ &= [c_j^i + \langle \hat{x}, a_j^i \rangle] - [c_{j_{\hat{x}}(i, \alpha)}^i + \langle \hat{x}, a_{j_{\hat{x}}(i, \alpha)}^i \rangle] + \langle y - \hat{x}, a_j^i - a_{j_{\hat{x}}(i, \alpha)}^i \rangle + \varepsilon_{j,l}^i - \varepsilon_{j_{\hat{x}}(i, \alpha), l}^i \\ &\leq -R_1 + 2R_4 + nMR_3 < -R_1 + 3nMR_3 \leq 0 \end{aligned}$$

For each $i \in [k]$, we define q_i other polynomials $Q_{i, \hat{x}}^1, \dots, Q_{i, \hat{x}}^{q_i}$ such that $\forall l \in [q_i]$:

$$Q_{i, \hat{x}}^l(x) = \max_{j \in \{j_{\hat{x}}(i, \alpha) \mid 1 \leq \alpha \leq q_i + 1\}} [c_j^i + \varepsilon_{j,l}^i + \langle x, a_j^i \rangle]$$

The tropical hypersurface of the n polynomials $Q_{1, \hat{x}}^1, \dots, Q_{1, \hat{x}}^{q_1}, \dots, Q_{k, \hat{x}}^1, \dots, Q_{k, \hat{x}}^{q_k}$ are also in general position. According to Theorem 3.16, the number of intersection points of their tropical hypersurfaces is $n!V(S_1, \dots, S_k \mid q_1, \dots, q_k)$ with $S_i = \text{Conv}(\{a_j^i \mid j \in \{j_{\hat{x}}(i, \alpha) \mid 1 \leq \alpha \leq q_i + 1\}\})$. If S_i was not a full-dimensional simplex in \mathbb{R}^n , it would mean that, for some $\alpha \in [q_i + 1]$, the point $a_{j_{\hat{x}}(i, \alpha)}^i$ is in the convex hull of $\{a_j^i \mid j \in \{j_{\hat{x}}(i, \beta) \mid 1 \leq \beta \leq q_i + 1, \beta \neq \alpha\}\}$, which would imply the non-genericity of P_i because of the existence of \hat{x} . Hence, by the inequality given by Lemma 3.14, $n!V(S_1, \dots, S_k \mid q_1, \dots, q_k) \geq 1$, and the tropical hypersurfaces associated to $Q_{1, \hat{x}}^1, \dots, Q_{1, \hat{x}}^{q_1}, \dots, Q_{k, \hat{x}}^1, \dots, Q_{k, \hat{x}}^{q_k}$ have always at least one intersection point.

Consider such an intersection point x_ε . It is defined by n equalities. For each $i \in [k]$ and for each $l \in [q_i]$, two monomials in $Q_{i, \hat{x}}^l$ are maximal in x_ε , that is there exists $j_1(i, l), j_2(i, l) \in \{j_{\hat{x}}(i, \alpha) \mid 1 \leq \alpha \leq q_i + 1\}$ such that

$$P_i^l(x_\varepsilon) = c_{j_1(i, l)}^i + \varepsilon_{j_1(i, l), l}^i + \langle a_{j_1(i, l)}^i, x_\varepsilon \rangle = c_{j_2(i, l)}^i + \varepsilon_{j_2(i, l), l}^i + \langle a_{j_2(i, l)}^i, x_\varepsilon \rangle$$

Then, we have $Ax_\varepsilon = c + \varepsilon$, with $A \in \mathcal{M}_n(\mathbb{R})$, $c \in \mathbb{R}^n$ and $\varepsilon \in \mathbb{R}^n$ defined by:

$$A = \begin{pmatrix} a_{j_1(1,1)}^1 - a_{j_2(1,1)}^1 & & & & & \\ & \dots & & & & \\ a_{j_1(1,q_1)}^1 - a_{j_2(1,q_1)}^1 & & & & & \\ & \dots & & & & \\ a_{j_1(k,1)}^k - a_{j_2(k,1)}^k & & & & & \\ & \dots & & & & \\ a_{j_1(k,q_k)}^k - a_{j_2(k,q_k)}^k & & & & & \end{pmatrix} \quad c = \begin{pmatrix} c_{j_2(1,1)}^1 - c_{j_1(1,1)}^1 & & & & & \\ & \dots & & & & \\ c_{j_2(1,q_1)}^1 - c_{j_1(1,q_1)}^1 & & & & & \\ & \dots & & & & \\ c_{j_2(k,1)}^k - c_{j_1(k,1)}^k & & & & & \\ & \dots & & & & \\ c_{j_2(k,q_k)}^k - c_{j_1(k,q_k)}^k & & & & & \end{pmatrix} \quad \varepsilon = \begin{pmatrix} \varepsilon_{j_2(1,1),1}^1 - \varepsilon_{j_1(1,1),1}^1 & & & & & \\ & \dots & & & & \\ \varepsilon_{j_2(1,q_1),q_1}^1 - \varepsilon_{j_1(1,q_1),q_1}^1 & & & & & \\ & \dots & & & & \\ \varepsilon_{j_2(k,1),1}^k - \varepsilon_{j_1(k,1),1}^k & & & & & \\ & \dots & & & & \\ \varepsilon_{j_2(k,q_k),q_k}^k - \varepsilon_{j_1(k,q_k),q_k}^k & & & & & \end{pmatrix}$$

Then, it means A is invertible and $x_\varepsilon = A^{-1}(c + \varepsilon)$. In fact, if A was not invertible, there would exist either zero or an infinite number of solutions of $Ax_\varepsilon = c + \varepsilon$. Because x_ε is a solution, there is at least one solution, and because the number of intersection points of the n polynomials $Q_{1,\hat{x}}^1, \dots, Q_{1,\hat{x}}^{q_1}, \dots, Q_{k,\hat{x}}^1, \dots, Q_{k,\hat{x}}^{q_k}$ is finite, there is a finite number of solutions of $Ax_\varepsilon = c + \varepsilon$.

Moreover, by definition of \hat{x} , we also have $\hat{x} = A^{-1}c$. Then, we have $x_\varepsilon - \hat{x} = A^{-1}\varepsilon$. Because $A \in \mathcal{A}$, we have:

$$\|x_\varepsilon - \hat{x}\|_\infty \leq n\|A^{-1}\|_\infty\|\varepsilon\|_\infty \leq n\|A^{-1}\|_\infty R_4 \leq R_3$$

Consequently, $x_\varepsilon \in \mathcal{B}^\infty(\hat{x}, R_3)$. So, we have for all $j \notin \{j_{\hat{x}}(i, \alpha) \mid 1 \leq \alpha \leq q_i + 1\}$ and for $l \in [q_i]$ that:

$$c_j^i + \varepsilon_{j,l}^i + \langle x_\varepsilon, a_j^i \rangle \leq c_{j_1(i,l)}^i + \varepsilon_{j_1(i,l),l}^i + \langle x_\varepsilon, a_{j_1(i,l)}^i \rangle = Q_{i,\hat{x}}^l(x_\varepsilon)$$

Then, for all $i \in [k]$ and all $l \in [q_i]$, $Q_{i,\hat{x}}^l(x_\varepsilon) = P_i^l(x_\varepsilon)$. It means that x_ε is an intersection point of the tropical hypersurfaces associated to $P_1^1, \dots, P_1^{q_1}, \dots, P_k^1, \dots, P_k^{q_k}$. Because $x_\varepsilon \in \mathcal{B}^\infty(\hat{x}, R_3) \subset \mathcal{B}^\infty(\hat{x}, R_2)$, and because for all $x, x' \in X_q$, we have $\mathcal{B}^\infty(x, R_2) \cap \mathcal{B}^\infty(x', R_2) = \emptyset$, the number of intersection points of $\mathcal{T}(P_1^1), \dots, \mathcal{T}(P_1^{q_1}), \dots, \mathcal{T}(P_k^1), \dots, \mathcal{T}(P_k^{q_k})$ is bigger than the number of points in X_q , that is $\#X_q \leq n!V(\Delta_1, \dots, \Delta_k \mid q_1, \dots, q_k)$.

APPENDIX *C*

Congestion problem with bounded prices

In Chapter 7, we introduced a bilevel problem for solving a congestion problem in mobile data networks. We show that a particular case (Problem 7.11) can be solved in polynomial time. In this case, we assumed that the discounts proposed by the provider, that is the high-level decision variables, can take any real values. However, in the practice, such an assumption is not very realistic. It would mean that the provider can propose infinite discounts. Since he has to make some profit, he cannot accept to propose very large discounts.

In this section, we study Problem 7.11 with bounded price incentives. If we consider the discounts as a percentage of the total amount paid monthly by each user, it is relevant to assume that the discounts belong to $[0, 1]^n$. Because we deal with the optimistic case, the problem can be formulated as follows:

Problem C.1.

$$\begin{aligned} & \min_{y \in [0, 1]^n} \sum_{i=1}^n f_i(N_i) \\ & s.t. \begin{cases} \forall i, & N_i = \sum_{k=1}^K u_k(i) \\ \forall k \in [K], & \max_{u_k \in F_k} \langle \rho_k + y, u_k \rangle \end{cases} \end{aligned}$$

For simplicity, we include the constraint $\forall i, N_i \leq N_i^C$ in the definition of the functions f_i . In this thesis, the main assumption to develop polynomial time algorithms is that the

high-level function does not depend on the high-level decision variables. This assumption is not satisfied by Problem bilevel-telecom-bounded, since the high-level function of is $(y, N) \mapsto \sum_{i=1}^n f_i(N_i) + \chi_{y \in [0,1]^n}(y)$.

We study more specifically why the approach of Section 7.3.2 cannot be adapted to Problem bilevel-telecom-bounded. We say that a vector $N \in \sum_k F_k$ is *feasible* for Problem C.1 if there exists $y \in [0, 1]^n$ and for every k a vector $u_k^* \in F_k$ such that $N = \sum_k u_k^*$ and for every k , $u_k^* \in \arg \max_{u_k \in F_k} \langle \rho + y, u_k \rangle$.

We proved in Section 7.3.2 that all the points of $\sum_k F_k$ are feasible for Problem 7.11. In this problem, it is not guaranteed that all points of $\sum_k F_k$ are feasible. We first characterize the feasible vectors for Problem C.1. We consider for simplicity that for every $i \in \mathcal{J}_k$, $\rho_k(i) = -\infty$.

Lemma C.2. *The following assertions are equivalent:*

1. *There exists $y \in [0, 1]^n$ verifying $\langle \rho_k + y, u_k^* \rangle = \max_{u_k \in F_k} \langle \rho_k + y, u_k \rangle$.*
2. *For all indices i, j such that $\rho_k(i) > \rho_k(j) + 1$, then $u_k^*(i) \geq u_k^*(j)$.*

Proof. We have $u_k^*(i) = 1$ if and only if $\rho_k(i) + y_i$ is one of the R_k highest coordinates of $\rho_k + y$. Consequently, if $\rho_k(i) + y_i > \rho_k(j) + y_j$, we have:

$$u_k^*(i) = 0 \Rightarrow u_k^*(j) = 0 \quad \text{and} \quad u_k^*(j) = 1 \Rightarrow u_k^*(i) = 1$$

what corresponds to $u_k^*(i) \geq u_k^*(j)$.

Suppose there exists $y \in [0, 1]^n$ verifying $\langle \rho_k + y, u_k^* \rangle = \max_{u_k \in F_k} \langle \rho_k + y, u_k \rangle$. For all indices i, j such that $\rho_k(i) > \rho_k(j) + 1$, we have $\rho_k(i) + y_i > \rho_k(j) + y_j$ and so $u_k^*(i) \geq u_k^*(j)$. Conversely, consider u_k^* such that $u_k^*(i) \geq u_k^*(j)$ for all i, j with $\rho_k(i) > \rho_k(j) + 1$ and take $y = u_k^* \in [0, 1]^n$. Consider i, j with $u_k^*(i) = 1$ and $u_k^*(j) = 0$. Then, $u_k^*(j) < u_k^*(i)$ and so, $\rho_k(j) \leq \rho_k(i) + 1$. Because $y = u_k^*$, we have $y_i = 1$ and $y_j = 0$ such that $\rho_k(j) + y_j \leq \rho_k(i) + y_i$. It means consequently that the R_k indices i such that $u_k^*(i) = 1$ corresponds to the R_k highest coordinates of $\rho_k + y$ and so $\langle \rho_k + y, u_k^* \rangle = \max_{u_k \in F_k} \langle \rho_k + y, u_k \rangle$. \square

Lemma C.2 characterizes the sets of feasible u_k when $y \in [0, 1]^n$. Unfortunately, this set is not always M -convex. For example, consider $n = 4$, $R_k = 2$, $\rho_k = [0, 0.3, 0.6, 1.1]$ and $\mathcal{J}_k = \emptyset$. The consumptions u_k realizable by a discount vector $y \in [0, 1]^4$ are $(0, 0, 1, 1)$, $(0, 1, 0, 1)$, $(1, 0, 0, 1)$, $(0, 1, 1, 0)$. This set is not M -convex. Take $x = (1, 0, 0, 1)$, $y = (0, 1, 1, 0)$ and $i = 1$. To have a M -convex set, we should have whether $y + e_1 - e_2 = (1, 0, 1, 0)$ or $y + e_1 - e_3 = (1, 1, 0, 0)$ feasible. This is not the case.

We can nevertheless notice that the feasible u_k belong to a M -convex set which is included in F_k . Consider $\overline{\rho_k}$ the R_k highest coordinate of ρ_k and $\underline{\rho_k}$ the $R_k + 1$ highest coordinate of ρ_k . If a vector u_k^* is realizable for $y \in [0, 1]^n$, then for all indices i such that $\rho_k(i) > \underline{\rho_k} + 1$, $u_k^*(i) = 1$ and for all indices i such that $\rho_k(i) + 1 < \overline{\rho_k}$, $u_k^*(i) = 0$. We have in fact that if an index i verifies $\rho_k(i) > \underline{\rho_k} + 1$, and because there exist $(n - R_k)$ indices j such that $\rho_k(j) \leq \underline{\rho_k}$, then $\rho_k(j) + y_j \leq \underline{\rho_k} + y_j < \rho_k(i) \leq \rho_k(i) + y_i$. So $\rho_k(i) + y_i$ is one of the R_k highest coordinates of $\rho_k + y$ and so $u_k^*(i) = 1$. We prove similarly that if $\rho_k(i) + 1 < \overline{\rho_k}$ then $u_k^*(i) = 0$. Hence, the possible u_k when $y \in [0, 1]^n$ belong to a subset of F_k where certain coordinates are fixed to 1, and other fixed to 0. It defines also a M -convex set.

We could expect that the set of feasible N consists in the Minkowski sum of the sets of possible u_k . It is not true. Consider a simple example with $n = 3$ and $K = 2$. We assume that $F_1 = F_2 = \{(1, 0, 0); (0, 1, 0); (0, 0, 1)\}$, and $\rho_1 = [3/4, 0, -1]$, $\rho_2 = [-1, 0, 3/4]$. According

to Lemma C.2, the feasible values of u_1^* are $\{(1, 0, 0); (0, 1, 0)\}$ and the feasible values of u_2^* are $\{(0, 0, 1); (0, 1, 0)\}$. The point $(0, 2, 0)$ belongs to the Minkowski sum of these two sets. However, a vector y such that

However, the set of feasible N can be characterized. A vector $N \in \sum_k F_k$ is realizable if there exists $y \in [0, 1]^n$ such that $y \in \partial\psi(N)$ (where ψ is the sup-convolution of functions φ_k defined by $\varphi_k(u_k) = -\langle \rho_k, u_k \rangle - \chi_{F_k}(u_k)$). It means $\psi(N) + \langle y, N \rangle = \max_{N' \in \sum_k F_k} \psi(N') + \langle y, N' \rangle$, that is N is a global maximizer of the function $N \mapsto \psi(N) + \langle y, N \rangle$, which is M -concave. Global and local optimality for M -concave functions are equivalent. Hence, a vector $N \in \sum_k F_k$ is realizable if there exists $y \in [0, 1]^n$ such that $\forall i, j, \psi(N) + \langle y, N \rangle \geq \psi(N - e_i + e_j) + \langle y, N - e_i + e_j \rangle$, that is $\psi(N) - \psi(N - e_i + e_j) \geq y_j - y_i$. Moreover, we have the following characterization:

Theorem C.3. *The feasible N are those who verify $\forall i, j, \psi(N) - \psi(N - e_i + e_j) \geq -1$.*

Proof. If N is feasible, then there exists $y \in [0, 1]^n$ such that $\forall i, j, \psi(N) - \psi(N - e_i + e_j) \geq y_j - y_i$. So $\psi(N) - \psi(N - e_i + e_j) \geq -1$.

Conversely, consider $N \in \sum_k F_k$ and suppose that $\forall i, j, \psi(N) - \psi(N - e_i + e_j) \geq -1$. We define the matrix $A \in \mathcal{M}_n(\mathbb{R})$ by $a_{ij} = \psi(N) - \psi(N - e_i + e_j)$. The matrix A satisfies the following properties:

- $\forall i, a_{ii} = 0$. It comes straightforwardly from the definition of the coefficients of A .
- $\forall i, j, a_{ij} \geq -1$. It is the hypothesis.
- $\forall i, j, a_{ij} + a_{ji} \geq 0$. It comes from the M -concavity of ψ . Consider $x = N - e_i + e_j$ and $y = N - e_j + e_i$. Then $x - y = -2e_i + 2e_j$ and $x - y$ has only one positive coordinate (j) and one negative coordinate (i). So $\psi(x) + \psi(y) \leq \psi(x - e_j + e_i) + \psi(y + e_j - e_i)$, that is $\psi(N) - \psi(N - e_i + e_j) + \psi(N) - \psi(N - e_j + e_i) \geq 0$.
- $\forall i, j, k, a_{ij} + a_{jk} \geq a_{ik}$. It comes also from the M -concavity of ψ . Consider $x = N - e_i + e_j$ and $y = N - e_j + e_k$. Then $y - x = e_i + e_k - 2e_j$ and $y - x$ has two positive coordinates (i, k) and only one negative coordinate (j). So $\psi(x) + \psi(y) \leq \psi(x - e_j + e_k) + \psi(y + e_j - e_k)$, that is $\psi(N) + \psi(N - e_i + e_k) \geq \psi(N - e_i + e_j) + \psi(N - e_j + e_k)$, which can be rewritten $\psi(N) - \psi(N - e_i + e_j) + \psi(N) - \psi(N - e_j + e_k) \geq \psi(N) - \psi(N - e_i + e_k)$.

We want to show that there exists $y \in [0, 1]^n$ such that for every $i, j, a_{ij} \geq y_j - y_i$. Consider for every $i \in [n], y_i = -\min_j a_{ij}$. We have $a_{ij} \geq -1$ for every $i, j \in [n]$ Hence, for each $i, y_i \leq 1$. Moreover, $\min_j a_{ij} \leq a_{ii} = 0$. So $y_i \geq 0$ and $y \in [0, 1]^n$. Take $i, j \in [n]$. We have $y_j - y_i = a_{ik} - a_{jl}$ with $a_{ik} = \min_m a_{im}$ and $a_{jl} = \min_m a_{jm}$. Since $a_{ij} + a_{jk} \geq a_{ik}$, we have $y_j - y_i \leq a_{ij} + a_{jk} - a_{jl}$ and because $a_{jl} = \min_m a_{jm}$, we have $a_{jl} \leq a_{jk}$. So, $y_j - y_i \leq a_{ij}$. \square

The possible N do not consist in a M -convex set. We have to develop a heuristic for solving the bilevel problem in this case. We use the tropical interpretation exposed in Section 7.3.1. There exists a correspondence between the polyhedron $[0, 1]^n$ and the Hilbert ball $\mathcal{H} = \max(y) - \min(y) \leq 1$. A vector $y \in [0, 1]^n$ satisfies $\max(z) - \min(z) = y_j - y_k \leq 1$ for some j, k . Conversely, a point $y \in \mathcal{H}$ satisfies for all $\alpha \in \mathbb{R}, y + \alpha e \in \mathcal{H}$ with $e = (1, \dots, 1)$. By considering $\alpha = -\min(y)$, we have $\min(y + \alpha e) = 0$ and $\max(y + \alpha e) \leq 1$. Then $y + \alpha e \in [0, 1]^n$.

We consider the tropical projective space \mathbb{TP}^{n-1} . We associate to each point $y \in \mathbb{R}^n$ a point $z \in \mathbb{TP}^{n-1}$ with $\forall i \in [n-1], z_i = y_i - y_n$. For all $\alpha \in \mathbb{R}, y$ and $y + \alpha e$ correspond to the same $z \in \mathbb{TP}^{n-1}$. Hence, there is a one-to-one correspondence between the polyhedron $[0, 1]^n$ and the representation \mathcal{H}^P of the Hilbert ball \mathcal{H} in \mathbb{TP}^{n-1} . The polyhedron \mathcal{H}^P satisfies $\forall i \in [n-1], z_i \leq 1$ and $\forall i, j \in [n-1], z_i - z_j \leq 1$.

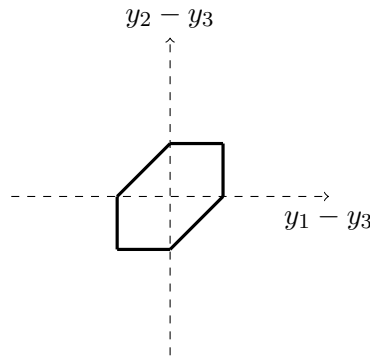
Figure C.1: Representation of \mathcal{H}^P in \mathbb{TP}^2

Lemma C.4. *The polyhedron \mathcal{H}^P corresponds to a cell of the subdivision in the tropical projective space defined by the tropical polynomial $\bigotimes_{k=1}^n Q_k(y)$ with $Q_k(y) = \max(y_1, \dots, y_k + 1, \dots, y_n)$.*

Proof. Consider for all i the tropical polynomial $Q_i(y) = \max(y_1, \dots, y_i + 1, \dots, y_n)$. There exist a domain where the maximum is attained in $y_i + 1$. We have $\forall j \neq i, y_j - y_i \leq 1$. The intersection of all these domains corresponds to the polyhedron defined by $\forall i, j$ such that $j \neq i, y_j - y_i \leq 1$, that is the Hilbert ball \mathcal{H} . In the tropical projective space, this cell corresponds to \mathcal{H}^P . \square

We can draw the arrangement of tropical hypersurfaces corresponding to these polynomials.

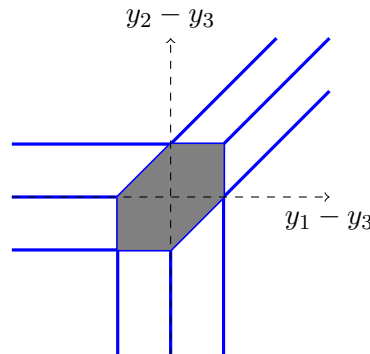
Figure C.2: Representation of the arrangement of the tropical polynomials defined by $\bigotimes Q_k$ in \mathbb{TP}^2 . The cell \mathcal{H}^P is filled in gray.

Each tropical polynomial can be written:

$$Q_k(y) = \max(y_1, \dots, 1 + y_k, \dots, y_n) = \max_{\tilde{u}_k \in \tilde{\Delta}_k} \langle \tilde{\rho}_k + y, \tilde{u}_k \rangle,$$

where the polytope $\tilde{\Delta}_k$ is the classical simplex ($\tilde{\Delta}_k = \{\tilde{u}_k \in [0, 1]^n \mid \sum_i \tilde{u}_k(i) = 1\}$) and the vector $\tilde{\rho}_k = e_k$ (the k -th vector of the canonical basis). We introduce n "fictive" customers. The "fictive" customer k wants to do $\tilde{R}_k = 1$ request, has the preference vector $\tilde{\rho}_k$ and we denote by \tilde{u}_k its optimal consumption.

We can calculate the number \tilde{N} of active "fictive" customers in the network. By the results of Section 7.4, all the vectors of $\sum_k \tilde{F}_k$ are feasible, with \tilde{F}_k the set of extreme points of $\tilde{\Delta}_k$, that is $\tilde{F}_k = \{\tilde{u}_k \in \{0; 1\}^n \mid \sum_i \tilde{u}_k(i) = 1\}$. The polyhedron \mathcal{H}^P corresponds to an optimal solution of each "fictive" customer $\tilde{u}_k^* = e_k$ and then $\tilde{N} = (1, \dots, 1)$ in this cell. It corresponds to a perfect balancing of the "fictive" customers.

We can introduce the "fictive" customers to develop a heuristic, if we make the following assumption:

Assumption H. The functions f_i are such that:

$$\max_{N \in \sum_{k=1}^n F_k} \sum_i f_i(N_i) = \max_{N \in \mathbb{Z}^n} \sum_i f_i(N_i)$$

This assumption seems to be reasonable if we consider a balancing problem. In fact, because of the M -concavity of the function $\sum_i f_i$, Assumption H is verified when the optimal solution of $\max_{N \in \sum_{k=1}^n F_k} \sum_i f_i(N_i)$ is in the interior of $\text{Conv}(\sum_{k=1}^n F_k)$.

We consider a perturbed bilevel problem which correspond to the previous one with both real and "fictive" customers in the network. We are able to solve it without any constraint over the discount vector y . The solution obtained can be ensured to be in \mathcal{H} , and so to be the same as the bounded problem (case $y \in \mathcal{H}$), which is also equivalent to the case $y \in [0, 1]^n$. The heuristic is based on a "big M "-penalty method. Let $M > 0$ be a sufficiently large integer. Consider Mn fictive customers, indexed by $K+1, \dots, K+Mn$. For each fictive customer k , let i be the remainder of the Euclidean division of k by n , and consider $\tilde{\rho}_k = e_i$. As previously, we can calculate the number \tilde{N} of active customers in the network

Proposition C.5. Let $M > \sum_{k=1}^n R_k$. Consider the optimistic bilevel problem defined by:

$$\begin{aligned} & \max_{y \in \mathbb{R}^n} \sum_{i=1}^n f_i(\hat{N}_i - M) \\ & \text{s.t.} \left\{ \begin{array}{ll} \forall i, & \hat{N}_i \leq N_i^C + M \\ \forall i, & \hat{N}_i = \sum_{k=1}^K \hat{u}_k^*(i) \\ \forall k, & \hat{u}_k^* = u_k^* + \tilde{u}_k^* \\ \forall k \in [K], & u_k^* \in \arg \max_{u_k \in F_k} \langle \rho_k + y, u_k \rangle \\ \forall k \geq K+1, & \tilde{u}_k^* \in \arg \max_{\tilde{u}_k \in \tilde{F}_k} \langle \rho_k + y, \tilde{u}_k \rangle \end{array} \right. \end{aligned}$$

Then, a solution (y^*, \hat{N}^*) of this bilevel problem is such that $y^* \in \mathcal{H}$.

Proof. The function $\hat{N} \mapsto \sum_{i=1}^n f_i(\hat{N}_i - M)$ is a separable concave function because each f_i is concave. According to the results of Section 7.4, this bilevel problem can be solved by decomposition. The optimal \hat{N}^* is a solution of the following optimisation problem:

$$\max_{\hat{N} \in \sum_{k=1}^n F_k + \sum_{k=K+1}^{K+Mn} \tilde{F}_k} \sum_{i=1}^n f_i(\hat{N}_i - M)$$

Take $y \in]0, 1[^n$. Then, for each "fictive" customer k , the optimal consumption $\tilde{u}_k = e_i$ where i is the remainder of the Euclidean division of k by n . According to this result, the

number of fictive customers in the network is $\tilde{N} = Me$ with $e = (1, \dots, 1)$. It means that $\sum_{k=1}^n F_k + Me \subset \sum_{k=1}^n F_k + \sum_{k=K+1}^{K+Mn} \tilde{F}_k$. Consequently,

$$\max_{\hat{N} \in \sum_{k=1}^n F_k + Me} \sum_i f_i(\hat{N}_i - M) \leq \max_{\hat{N} \in \sum_{k=1}^n F_k + \sum_{k=K+1}^{K+Mn} \tilde{F}_k} \sum_i f_i(\hat{N}_i - M) \leq \max_{\hat{N} \in \mathbb{Z}^n} \sum_i f_i(\hat{N}_i - M)$$

According to Assumption H, we have:

$$\max_{\hat{N} \in \sum_{k=1}^n F_k + Me} \sum_i f_i(\hat{N}_i - M) = \max_{\hat{N} \in \sum_{k=1}^n F_k + \sum_{k=K+1}^{K+Mn} \tilde{F}_k} \sum_i f_i(\hat{N}_i - M) = \max_{\hat{N} \in \mathbb{Z}^n} \sum_i f_i(\hat{N}_i - M)$$

It means that there always exists \hat{N}^* belonging to $\sum_{k=1}^n F_k + Me$. Take now $y \notin \mathcal{H}$. Then $\max_i y_i - \min_i y_i > 1$. Consider the index $j \in \arg \min_i y_i$. For $i \neq j$, the maximum in $Q_i(y)$ is not attained at y_j , because $y_i + 1 > y_j$. And $\max_i y_i > y_j + 1$, then the maximum in $Q_j(y)$ is not attained at $y_j + 1$. So, any fictive customers will have e_j for optimal consumptions. Consider N and \tilde{N} a possible number of respectively real and fictive customers, and $\hat{N} = N + \tilde{N}$. We have $\tilde{N}_j = 0$, and $N_j \leq \sum_{i=1}^n N_i = \sum_{k=1}^n R_k$. So $\hat{N}_j \leq \sum_{k=1}^n R_k < M$. It means $\hat{N} \notin \sum_{k=1}^n F_k + Me$ (because each F_k belongs to \mathbb{N}^n , each coordinate of each vector of $\sum_{k=1}^n F_k + Me$ is bigger than M), and \hat{N}^* is not realizable for y . Consequently, there exists $y^* \in \mathcal{H}$ such that (y^*, N^*) is a solution of the bilevel problem with real and fictive customers. \square

Since y^* is an optimal solution of a perturbation of a bilevel problem, a heuristic can be to considered this vector y^* as an optimal solution of Problem C.1 (or a translation of y^* to ensure that all its entries are in $[0, 1]$). This seems to be adapted to balancing problems, in which all functions f_i are equal. The high-level function is in this case Schur-convex and an optimal solution is attained for vectors N such that the difference between N_i and N_j for every $i, j \in [n]$ does not exceed 1. Intuitively, the fictive customers have the same response to discounts in \mathcal{H} . Then, the optimal price y^* provided by the bilevel problem with both real and fictive customers ensures a good "balancing" between the different consumptions of the real customers, which is the aim of Problem C.1.

Bibliography

- [ABEA⁺06] Eitan Altman, Dhiman Barman, Rachid El Azouzi, David Ros, and Bruno Tuffin. Pricing differentiated services: A game-theoretic approach. *Computer Networks*, 50(7):982–1002, 2006.
- [AD54] Kenneth J Arrow and Gerard Debreu. Existence of an equilibrium for a competitive economy. *Econometrica: Journal of the Econometric Society*, pages 265–290, 1954.
- [AF92] David Avis and Komei Fukuda. A pivoting algorithm for convex hulls and vertex enumeration of arrangements and polyhedra. *Discrete & Computational Geometry*, 8(3):295–313, 1992.
- [AF96] David Avis and Komei Fukuda. Reverse search for enumeration. *Discrete Applied Mathematics*, 65(1-3):21–46, 1996.
- [AGG12] Marianne Akian, Stephane Gaubert, and Alexander Guterman. Tropical polyhedra are equivalent to mean payoff games. *International Journal of Algebra and Computation*, 22(01):1250001, 2012.
- [BAB90] Omar Ben-Ayed and Charles E Blair. Computational difficulties of bilevel linear programming. *Operations Research*, 38(3):556–560, 1990.
- [Bar91] Jonathan F Bard. Some properties of the bilevel programming problem. *Journal of optimization theory and applications*, 68(2):371–378, 1991.
- [Bar13] Jonathan F Bard. *Practical bilevel optimization: algorithms and applications*, volume 30. Springer Science & Business Media, 2013.
- [BB07] Benoit Bertrand and Frederic Bihan. Euler characteristic of real nondegenerate tropical complete intersections. *arXiv preprint arXiv:0710.1222*, 2007.
- [BCOQ92] F. Baccelli, G. Cohen, G.J. Olsder, and J.P. Quadrat. *Synchronization and Linearity*. Wiley, 1992.

- [Bel58] Richard Bellman. On a routing problem. *Quarterly of applied mathematics*, 16(1):87–90, 1958.
- [Ber75] David N Bernshtein. The number of roots of a system of equations. *Functional Analysis and its applications*, 9(3):183–185, 1975.
- [BF13] Thomas Bonald and Mathieu Feuillet. *Network performance analysis*. John Wiley & Sons, 2013.
- [BH08] Walter Briec and Charles Horvath. Nash points, ky fan inequality and equilibria of abstract economies in max-plus and b-convexity. *Journal of Mathematical Analysis and Applications*, 341(1):188–199, 2008.
- [BHL13] Walter Briec, Charles Horvath, and QiBin Liang. Efficient nash equilibria on semilattices. *Journal of Global Optimization*, 56(4):1603–1615, 2013.
- [BK12] Elizabeth Baldwin and Paul Klemperer. Tropical geometry to analyse demand. Technical report, Working paper, Oxford University, 2012.
- [BK15] Elizabeth Baldwin and Paul Klemperer. Understanding Preferences: “Demand Types”, and the Existence of Equilibrium with Indivisibilities. Economics Papers 2015-W10, Economics Group, Nuffield College, University of Oxford, August 2015.
- [BLMS00] Luce Brotcorne, Martine Labbé, Patrice Marcotte, and Gilles Savard. A bilevel model and solution algorithm for a freight tariff-setting problem. *Transportation Science*, 34(3):289–302, 2000.
- [BLMS01] Luce Brotcorne, Martine Labbé, Patrice Marcotte, and Gilles Savard. A bilevel model for toll optimization on a multicommodity transportation network. *Transportation science*, 35(4):345–358, 2001.
- [BPS00] Jonathan F Bard, John Plummer, and Jean Claude Sourie. A bilevel programming approach to determining tax credits for biofuel production1. *European Journal of Operational Research*, 120(1):30–46, 2000.
- [But10] P. Butkovič. *Max-linear systems : theory and algorithms*. Springer monographs in mathematics. Springer, 2010.
- [BV04] Stephen Boyd and Lieven Vandenberghe. *Convex optimization*. Cambridge university press, 2004.
- [Cis17] Cisco. Cisco visual networking index: Global mobile data traffic forecast update, 2016–2021 white paper. <https://www.cisco.com/c/en/us/solutions/collateral/service-provider/visual-networking-index-vni/mobile-white-paper-c11-520862.html>, 2017.
- [CLV08] William J Cook, László Lovász, and Jens Vygen. *Research Trends in Combinatorial Optimization: Bonn 2008*. Springer Science & Business Media, 2008.
- [CMS07] Benoît Colson, Patrice Marcotte, and Gilles Savard. An overview of bilevel optimization. *Annals of operations research*, 153(1):235–256, 2007.

- [CT16] Robert Alexander Crowell and Ngoc Mai Tran. Tropical geometry and mechanism design. *arXiv preprint arXiv:1606.04880*, 2016.
- [Dem02] Stephan Dempe. *Foundations of bilevel programming*. Springer Science & Business Media, 2002.
- [Dem03a] Stephan Dempe. Annotated bibliography on bilevel programming and mathematical programs with equilibrium constraints. *Optimization*, 52(3):333–359, 2003.
- [Dem03b] Stephan Dempe. *Bilevel programming: A survey*. Dekan der Fak. für Mathematik und Informatik, 2003.
- [DF14] Stephan Dempe and Susanne Franke. Solution algorithm for an optimistic linear stackelberg problem. *Computers & Operations Research*, 41:277–281, 2014.
- [DK04] Vladimir I Danilov and Gleb A Koshevoy. Discrete convexity and unimodularity—i. *Advances in Mathematics*, 189(2):301–324, 2004.
- [DKM01] Vladimir Danilov, Gleb Koshevoy, and Kazuo Murota. Discrete convexity and equilibria in economies with indivisible goods and money. *Mathematical Social Sciences*, 41(3):251–273, 2001.
- [DLRS10] Jesús A De Loera, Jörg Rambau, and Francisco Santos. *Triangulations Structures for algorithms and applications*. Springer, 2010.
- [DS04] Mike Develin and Bernd Sturmfels. Tropical convexity. *Doc. Math*, 9(1-27):7–8, 2004.
- [DZ12] Stephan Dempe and Alain Bertrand Zemkoho. On the karush–kuhn–tucker reformulation of the bilevel optimization problem. *Nonlinear Analysis: Theory, Methods & Applications*, 75(3):1202–1218, 2012.
- [EABG17] Jean Bernard Eytard, Marianne Akian, Mustapha Bouhtou, and Stéphane Gaubert. A bilevel optimization model for load balancing in mobile networks through price incentives. In *Modeling and Optimization in Mobile, Ad Hoc, and Wireless Networks (WiOpt), 2017 15th International Symposium on*, pages 1–8. IEEE, 2017.
- [Edm70] Jack Edmonds. Submodular functions, matroids, and certain polyhedra. *Combinatorial structures and their applications*, pages 69–87, 1970.
- [EG00] Herbert Edelsbrunner and Daniel R Grayson. Edgewise subdivision of a simplex. *Discrete & Computational Geometry*, 24(4):707–719, 2000.
- [FJ56] Lester R Ford Jr. Network flow theory. Technical report, RAND CORP SANTA MONICA CA, 1956.
- [FLM97] Komei Fukuda, Thomas M Liebling, and François Margot. Analysis of backtrack algorithms for listing all vertices and all faces of a convex polyhedron. *Computational Geometry*, 8(1):1–12, 1997.
- [FR94] Komei Fukuda and Vera Rosta. Combinatorial face enumeration in convex polytopes. *Computational Geometry*, 4(4):191–198, 1994.

- [GLS81] Martin Grötschel, László Lovász, and Alexander Schrijver. The ellipsoid method and its consequences in combinatorial optimization. *Combinatorica*, 1(2):169–197, 1981.
- [GT89] Harold N Gabow and Robert E Tarjan. Faster scaling algorithms for network problems. *SIAM Journal on Computing*, 18(5):1013–1036, 1989.
- [HJP13] Sven Herrmann, Michael Joswig, and Marc E Pfetsch. Computing the bounded subcomplex of an unbounded polyhedron. *Computational Geometry*, 46(5):541–551, 2013.
- [HRS00] Birkett Huber, Jörg Rambau, and Francisco Santos. The cayley trick, lifting subdivisions and the bohne-dress theorem on zonotopal tilings. *Journal of the European Mathematical Society*, 2(2):179–198, 2000.
- [HSJW⁺12] Sangtae Ha, Soumya Sen, Carlee Joe-Wong, Youngbin Im, and Mung Chiang. Tube: time-dependent pricing for mobile data. *ACM SIGCOMM Computer Communication Review*, 42(4):247–258, 2012.
- [IMS09] Ilia Itenberg, Grigory Mikhalkin, and Eugenio I Shustin. *Tropical algebraic geometry*, volume 35. Springer Science & Business Media, 2009.
- [Jer85] Robert G Jeroslow. The polynomial hierarchy and a simple model for competitive analysis. *Mathematical programming*, 32(2):146–164, 1985.
- [Jos17] Michael Joswig. The cayley trick for tropical hypersurfaces with a view toward ricardian economics. In *Homological and Computational Methods in Commutative Algebra*, pages 107–128. Springer, 2017.
- [Kar84] Narendra Karmarkar. A new polynomial-time algorithm for linear programming. In *Proceedings of the sixteenth annual ACM symposium on Theory of computing*, pages 302–311. ACM, 1984.
- [Kha79] Leonid G Khachiyan. A polynomial algorithm in linear programming. In *Doklady Akademii Nauk SSSR*, volume 244, pages 1093–1096, 1979.
- [Kle10] Paul Klempner. The product-mix auction: A new auction design for differentiated goods. *Journal of the European Economic Association*, 8(2-3):526–536, 2010.
- [KP02] Volker Kaibel and Marc E Pfetsch. Computing the face lattice of a polytope from its vertex-facet incidences. *Computational Geometry*, 23(3):281–290, 2002.
- [LMS98] Martine Labbé, Patrice Marcotte, and Gilles Savard. A bilevel model of taxation and its application to optimal highway pricing. *Management science*, 44(12-part-1):1608–1622, 1998.
- [LMS05] J-W Lee, Ravi R Mazumdar, and Ness B Shroff. Non-convex optimization and rate control for multi-class services in the internet. *IEEE/ACM transactions on networking*, 13(4):827–840, 2005.
- [LP98] Torbjörn Larsson and Michael Patriksson. Side constrained traffic equilibrium models—traffic management through link tolls. In *Equilibrium and advanced transportation modelling*, pages 125–151. Springer, 1998.

- [MBENN16] F. Moety, M. Bouhtou, T. En-Najjary, and R. Nasri. Joint optimization of user association and user satisfaction in heterogeneous cellular network. In *28th International Teletraffic Congress*, 2016.
- [MLH14] Qian Ma, Ya-Feng Liu, and Jianwei Huang. Time and location aware mobile data pricing. In *Communications (ICC), 2014 IEEE International Conference on*, pages 3235–3240. IEEE, 2014.
- [MS05] Patrice Marcotte and Gilles Savard. Bilevel programming: A combinatorial perspective. *Graph theory and combinatorial optimization*, pages 191–217, 2005.
- [MS15] Diane Maclagan and Bernd Sturmfels. *Introduction to Tropical Geometry*, volume 161 of *Graduate Studies in Mathematics*. American Mathematical Society, Providence, RI, 2015.
- [MT06] Patrick Maillé and Bruno Tuffin. Pricing the internet with multibid auctions. *IEEE/ACM transactions on networking*, 14(5):992–1004, 2006.
- [MT14] Patrick Maillé and Bruno Tuffin. *Telecommunication network economics: from theory to applications*. Cambridge University Press, 2014.
- [Mur03] Kazuo Murota. *Discrete convex analysis*. SIAM, 2003.
- [OM79] Ingram Olkin and Albert W Marshall. *Inequalities: theory of majorization and its applications*, volume 143. Academic press, 1979.
- [PR00] Mikael Passare and Hans Rullgård. Amoebas, monge-ampere measures and triangulations of the newton polytope. Research reports in Mathematics 10, Dept. Math., SU, 2000.
- [PRr04] Mikael Passare and Hans Rullgård. Amoebas, Monge-Ampère measures, and triangulations of the Newton polytope. *Duke Math. J.*, 121(3):481–507, 2004.
- [PSBD11] Utpal Paul, Anand Prabhu Subramanian, Milind Madhav Buddhikot, and Samir R Das. Understanding traffic dynamics in cellular data networks. In *INFOCOM, 2011 Proceedings IEEE*, pages 882–890. IEEE, 2011.
- [Ren88] James Renegar. A polynomial-time algorithm, based on newton’s method, for linear programming. *Mathematical Programming*, 40(1-3):59–93, 1988.
- [Roc70] Ralph Tyrell Rockafellar. *Convex analysis*. Princeton university press, 1970.
- [Sch98] Alexander Schrijver. *Theory of linear and integer programming*. John Wiley & Sons, 1998.
- [Sch03] Alexander Schrijver. *Combinatorial optimization: polyhedra and efficiency*, volume 24. Springer Science & Business Media, 2003.
- [Shi15] Yoshinori Shiozawa. International trade theory and exotic algebras. *Evolutionary and Institutional Economics Review*, 12(1):177–212, 2015.
- [SJWHC13] Soumya Sen, Carlee Joe-Wong, Sangtae Ha, and Mung Chiang. A survey of smart data pricing: Past proposals, current plans, and future trends. *ACM Computing Surveys (CSUR)*, 46(2):15, 2013.

- [SJWHC14] Soumya Sen, Carlee Joe-Wong, Sangtae Ha, and Mung Chiang. *Smart Data Pricing*. John Wiley & Sons, 2014.
- [SMD17] Ankur Sinha, Pekka Malo, and Kalyanmoy Deb. A review on bilevel optimization: From classical to evolutionary approaches and applications. *IEEE Transactions on Evolutionary Computation*, 2017.
- [SQBB10] Chaoming Song, Zehui Qu, Nicholas Blumm, and Albert-László Barabási. Limits of predictability in human mobility. *Science*, 327(5968):1018–1021, 2010.
- [Sto76] Larry J Stockmeyer. The polynomial-time hierarchy. *Theoretical Computer Science*, 3(1):1–22, 1976.
- [Stu94] Bernd Sturmfels. On the newton polytope of the resultant. *Journal of Algebraic Combinatorics*, 3(2):207–236, 1994.
- [Stu02] Bernd Sturmfels. *Solving systems of polynomial equations*, volume 97 of *CBMS Regional Conference Series in Mathematics*. Published for the Conference Board of the Mathematical Sciences, Washington, DC; by the American Mathematical Society, Providence, RI, 2002.
- [TEEG13] John Tadrous, Atila Eryilmaz, and Hesham El Gamal. Pricing for demand shaping and proactive download in smart data networks. In *INFOCOM, 2013 Proceedings IEEE*, pages 3189–3194. IEEE, 2013.
- [TY15] Ngoc Mai Tran and Josephine Yu. Product-mix auctions and tropical geometry. *arXiv preprint arXiv:1505.05737*, 2015.
- [VS34] Heinrich Von Stackelberg. *Marktform und Gleichgewicht*. J. springer, 1934.
- [WTKR13] Wolfram Wiesemann, Angelos Tsoukalas, Polyxeni-Margarita Kleniati, and Berç Rustem. Pessimistic bilevel optimization. *SIAM Journal on Optimization*, 23(1):353–380, 2013.
- [YQZ⁺15] Jie Yang, Yuanyuan Qiao, Xinyu Zhang, Haiyang He, Fang Liu, and Gang Cheng. Characterizing user behavior in mobile internet. *IEEE transactions on emerging topics in computing*, 3(1):95–106, 2015.

Une approche par la géométrie tropicale et la convexité discrète de la programmation bi-niveau : application à la tarification des données dans les réseaux mobiles de télécommunications

Mots clés : géométrie tropicale, programmation bi-niveau, convexité discrète, tarification des données, réseaux mobiles de télécommunications

Résumé : La programmation bi-niveau désigne une classe de problèmes d'optimisation emboîtés impliquant deux joueurs. Un joueur meneur annonce une décision à un joueur suiveur qui détermine sa réponse parmi l'ensemble des solutions d'un problème d'optimisation dont les données dépendent de la décision du meneur (problème de niveau bas). La décision optimale du meneur est la solution d'un autre problème d'optimisation dont les données dépendent de la réponse du suiveur (problème de niveau haut). Lorsque la réponse du suiveur n'est pas unique, on distingue les problèmes bi-niveaux optimistes et pessimistes, suivant que la réponse du suiveur soit respectivement la meilleure ou la pire possible pour le meneur. Les problèmes bi-niveaux sont souvent utilisés pour modéliser des problèmes de tarification. Dans les applications étudiées ici, le meneur est un vendeur qui fixe un prix, et le suiveur modélise le comportement d'un grand nombre de clients qui déterminent leur consommation en fonction de ce prix. Le problème de niveau bas est donc de grande dimension. Cependant, la plupart des problèmes bi-niveaux sont NP-difficiles, et en pratique, il n'existe pas de méthodes générales pour résoudre efficacement les problèmes bi-niveaux de grande dimension. Nous introduisons ici une nouvelle approche pour aborder la programmation bi-niveau. Nous supposons que le problème de niveau bas est un programme linéaire, en variables continues ou discrètes, dont la fonction de coût est déterminée par la décision du meneur. Ainsi, la réponse du suiveur correspond aux cellules d'un complexe polyédral particulier, associé à une hypersurface tropicale. Cette interprétation est motivée par des applications récentes de la géométrie tropicale à la modélisation du comportement d'agents économiques. Nous utilisons la dualité entre ce complexe polyédral et une subdivision régulière d'un polytope de Newton associé pour introduire une méthode de décomposition qui résout une série de sous-problèmes associés aux différentes cellules du complexe. En utilisant des résultats portant sur la combinatoire des subdivisions, nous montrons que cette décomposition mène à un algorithme permettant de résoudre une grande classe de problèmes bi-niveaux en temps polynomial en la dimension du problème de niveau bas lorsque la dimension du problème de niveau haut est fixée. Nous identifions ensuite des structures spéciales de problèmes bi-niveaux pour lesquelles la borne de complexité peut être améliorée. C'est en particulier le cas lorsque la fonction coût du meneur ne dépend que de la réponse du suiveur. Ainsi, nous montrons que la version optimiste du problème bi-niveau peut être résolue en temps polynomial, notamment pour des instances dans lesquelles les données satisfont certaines propriétés de convexité discrète. Nous montrons également que les solutions de tels problèmes sont des limites d'équilibres compétitifs. Dans la seconde partie de la thèse, nous appliquons cette approche à un problème d'incitation tarifaire dans les réseaux mobiles de télécommunication. Les opérateurs de données souhaitent utiliser des schémas de tarification pour encourager les différents utilisateurs à décaler leur consommation de données mobiles dans le temps, et par conséquent dans l'espace (à cause de leur mobilité), afin de limiter les pics de congestion. Nous modélisons cela par un problème bi-niveau de grande taille. Nous montrons qu'un cas simplifié peut être résolu en temps polynomial en utilisant la décomposition précédente, ainsi que des résultats de convexité discrète et de théorie des graphes. Nous utilisons ces idées pour développer une heuristique s'appliquant au cas général. Nous implémentons et validons cette méthode sur des données réelles fournies par Orange.

A tropical geometry and discrete convexity approach to bilevel programming: application to smart data pricing in mobile telecommunication networks

Keywords: tropical geometry, bilevel programming, discrete convexity, smart data pricing, telecommunication mobile networks

Abstract: Bilevel programming deals with nested optimization problems involving two players. A leader announces a decision to a follower, who responds by selecting a solution of an optimization problem whose data depend on this decision (low level problem). The optimal decision of the leader is the solution of another optimization problem whose data depend on the follower's response (high level problem). When the follower's response is not unique, one distinguishes between optimistic and pessimistic bilevel problems, in which the leader takes into account the best or worst possible response of the follower. Bilevel problems are often used to model pricing problems. We are interested in applications in which the leader is a seller who announces a price, and the follower models the behavior of a large number of customers who determine their consumptions depending on this price. Hence, the dimension of the low-level is large. However, most bilevel problems are NP-hard, and in practice, there is no general method to solve efficiently large-scale bilevel problems.

In this thesis, we introduce a new approach to tackle bilevel programming. We assume that the low level problem is a linear program, in continuous or discrete variables, whose cost function is determined by the leader. Then, the follower responses correspond to the cells of a special polyhedral complex, associated to a tropical hypersurface. This is motivated by recent applications of tropical geometry to model the behavior of economic agents. We use the duality between this polyhedral complex and a regular subdivision of an associated Newton polytope to introduce a decomposition method, in which one solves a series of subproblems associated to the different cells of the complex. Using results about the combinatorics of subdivisions, we show that this leads to an algorithm to solve a wide class of bilevel problems in a time that is polynomial in the dimension of the low-level problem when the dimension of the high-level problem is fixed.

Then, we identify special structures of bilevel problems for which this complexity bound can be improved. This is the case when the leader's cost function depends only on the follower's response. Then, we show the optimistic bilevel problem can be solved in polynomial time. This applies in particular to high dimensional instances in which the data satisfy certain discrete convexity properties. We also show that the solutions of such bilevel problems are limits of competitive equilibria.

In the second part of this thesis, we apply this approach to a price incentive problem in mobile telecommunication networks. The aim for Internet service providers is to use pricing schemes to encourage the different users to shift their data consumption in time (and so, also in space owing to their mobility), in order to reduce the congestion peaks. This can be modeled by a large-scale bilevel problem. We show that a simplified case can be solved in polynomial time by applying the previous decomposition approach together with graph theory and discrete convexity results. We use these ideas to develop an heuristic method which applies to the general case. We implemented and validated this method on real data provided by Orange.

