



HAL
open science

Interactions microorganismes - mercure - composante du sol : des outils pour l'évaluation de la qualité de la restauration écologique des sites miniers aurifères en Guyane française

Ewan Couic

► To cite this version:

Ewan Couic. Interactions microorganismes - mercure - composante du sol : des outils pour l'évaluation de la qualité de la restauration écologique des sites miniers aurifères en Guyane française. Biodiversité et Ecologie. Université Paris-Est, 2018. Français. NNT : 2018PESC1150 . tel-02166930

HAL Id: tel-02166930

<https://pastel.hal.science/tel-02166930>

Submitted on 27 Jun 2019

HAL is a multi-disciplinary open access archive for the deposit and dissemination of scientific research documents, whether they are published or not. The documents may come from teaching and research institutions in France or abroad, or from public or private research centers.

L'archive ouverte pluridisciplinaire **HAL**, est destinée au dépôt et à la diffusion de documents scientifiques de niveau recherche, publiés ou non, émanant des établissements d'enseignement et de recherche français ou étrangers, des laboratoires publics ou privés.

THESE DE DOCTORAT DE L'UNIVERSITE PARIS EST

Ecole Doctoral Sciences, Ingénierie et Environnement

Spécialité

Sciences de l'Univers et de l'Environnement

Présentée par

Ewan COUIC

Pour obtenir le grade de

Docteur de l'Université Paris Est

Interactions microorganismes - mercure - composante du sol : des outils pour
l'évaluation de la qualité de la restauration écologique des sites miniers
aurifères en Guyane française

Soutenue le 17 décembre 2018 devant le jury composé de :

WAFI Achouak – CEA Cadarache

Président du jury

GUYONEAUD Rémy – Université de Pau et des Pays de l'Adour

Rapporteur

MOUGIN Christian – INRA Versailles Grignon

Rapporteur

GARNIER-ZARLI Evelyne – Université Paris Est Créteil

CoDirecteur de thèse

BOUSSERRHINE Nouredine – Université Paris Est Créteil

Directeur de thèse

Remerciements

Cette thèse, réalisée au sein du Laboratoire Eau Environnement et Systèmes Urbains n'aurait pu être menée à bien sans l'aide de plusieurs personnes que je tiens à remercier.

En premier lieu je voudrais remercier Evelyne Garnier-Zarli qui a défendu mon projet de thèse auprès de l'école doctorale et qui a accepté de devenir ma directrice de thèse pour le démarrage de ce projet. Au même titre, je remercie Nouredine Bousserhine pour m'avoir guidé et aiguillé dans mon travail de recherche, de la paillasse jusqu'à la rédaction d'articles et de ce mémoire. Je le remercie également pour sa bonne humeur et son soutien lors de nos campagnes de terrains ainsi que pour l'autonomie qu'il m'a donné lors du congrès international de l'ICMGP. Je les remercie pour la confiance qu'ils m'ont accordée, leur patience et leurs amitiés.

Je remercie chaleureusement Michel Grimaldi, directeur de recherche à l'IRD, qui m'a transmis sa passion pour l'étude du sol et des paysages. Son aide lors de la campagne de terrain d'avril 2016 a été inestimable et j'ai pu apprendre au quotidien à ces côtés. Je le remercie également pour son aide précieuse dans la compréhension de certains processus biogéochimiques ainsi que pour sa participation à la correction d'une partie de mon travail de recherche.

Je voudrais remercier les membres du Jury d'avoir accepté de juger ce travail. Merci à Christian Mougin et Rémy Guyoneaud d'avoir accepté la tâche importante d'être mes rapporteurs. Merci à Wafa Achouak d'avoir accepté le rôle d'examineur.

Merci à Marie-Claire Gazeau et Denis Duhamel, directeurs de l'école doctorale SIE, de m'avoir accordé une bourse de mobilité pour l'inscription et la participation au colloque international de l'ICMGP à Providence aux Etats-Unis.

Les campagnes de terrains n'auraient pas été possibles sans l'aide de Christian Pernaut, directeur de la compagnie Ermina en Guyane française. Ses connaissances du terrain, des sites miniers, de la forêt tropicale, de la faune et de la flore ont été des sources incroyables d'informations pour la compréhension générale du contexte de la restauration écologique. Je tiens également à remercier Max Sarrazin pour son accueil à l'IRD de Cayenne et pour avoir accepté de s'occuper d'une partie des échantillons et de leurs rapatriements.

Un grand merci aux personnes de mon équipe de recherche. A Clarisse Balland-Bolou-Bi pour son amitié et son soutien pendant ces trois années et qui m'a beaucoup apportée dans la compréhension des résultats expérimentaux et des mécanismes biogéochimiques. A Vanessa Alphonse pour son aide quotidienne sur la paillasse ou au bureau, son amitié et sa positive attitude !! Merci d'avoir été à mon écoute pendant ces longues années. A Alexandre Livet pour son amitié, son aide et sa bonne humeur. Merci pour ces discours enflammés et passionnés qui me manqueront. A Catherine Martin pour sa bonne humeur et son soutien depuis les années de Master IBE. A Samir Abbad et Rachid Barhdadi pour leur soutien et leur

motivation. Un énorme merci à vous tous pour votre accompagnement et votre soutien indéfectible sans lesquels je n'aurais jamais pu arriver au terme de ce travail.

Je remercie également tous mes amis et collègues, Stéphanie Giusti-Miller pour son aide et ses conseils en enzymologie, Lise Dupont pour son amitié et pour les mois communs de partage de bureau, à Thomas Lerch et Manuel Blouin pour nos discussions passionnées sur la science et l'écologie, à Nadia Zindy pour son soutien et sa réactivité. Un merci en or à Juliette Rochet, merci pour son amitié, ses conseils, et à nos réflexions philosophiques lors de nos innombrables sessions footing autour du lac de Créteil. Je remercie toutes les professeures et tous les professeurs qui m'ont transmis le goût des sciences de la vie et de la terre pendant mon parcours universitaire.

Merci à tous les stagiaires qui ont participé à l'obtention des résultats de cette thèse, merci à Chloé, Alicia, Emma, Alexandre, Asmaa, Narimène et Lycia.

Un énorme merci à mes amies thésardes, Corinne et Charlotte. Merci à ces litres de café, numéro 94 essentiellement, qui nous ont coûté une petite fortune pendant ces 3 années, mais qui nous ont également permis de tisser des liens incroyables et de refaire le monde à chaque discussion. Merci à Charlotte d'avoir partagé avec moi sa passion de l'escalade et de la nature. Merci à Corinne pour ses innombrables fous rires et conseils de vie !

Merci à mes amis, Camille, Alain, Antoine & Antoine, Thomas, Joffrey, Akil, Nils, Elliott.... qui m'ont rappelé qu'il n'y avait pas que la thèse dans la vie.

Et enfin, merci à ma famille, à mes parents et mon frère pour leur soutien sans limite !

Résumé

Depuis plus de 150 ans l'exploitation aurifère en Guyane française bouleverse le paysage et l'écosystème. Les conséquences sont multiples, aussi bien pour l'environnement que pour la santé humaine. Pendant des décennies l'utilisation du mercure dans le processus d'extraction a entraîné une contamination du réseau hydrique et de la chaîne trophique. Afin d'inscrire l'exploitation aurifère dans une optique de développement durable le code minier impose depuis 1998 une obligation de réhabilitation des sites exploités. Des méthodes de revégétalisation utilisant différentes essences végétales ont donc été adoptées afin d'accélérer les successions écologiques. Le contrôle de la qualité de restauration écologique est néanmoins difficile à mettre en œuvre et il est nécessaire d'avoir des outils de bio-géo-indications fiables et peu coûteux pour estimer le recouvrement des fonctionnalités des écosystèmes et apprécier le risque de mobilités des éléments traces toxiques.

Dans ce contexte, les objectifs de ce travail de thèse ont été d'évaluer la qualité de restauration écologique de sites miniers à travers une caractérisation des activités microbiennes, du fonctionnement des cycles biogéochimiques d'éléments majeurs (C, N, P) et de la dynamique du mercure. L'originalité de ce travail réside dans l'évaluation dans le temps et dans l'espace des interactions entre couvert végétal – propriétés physico-chimiques du sol – activités microbiennes – spéciation du mercure après revégétalisation et en faire un outil diagnostique de la réussite de cette restauration. Dans ce but, plusieurs campagnes d'échantillonnages ont été réalisées en Guyane sur un panel de sites miniers réhabilités, avec différents types de couverts végétaux. Des échantillons de sols ont été prélevés sur des sites revégétalisés avec des espèces de fabacées, et sur des sites non revégétalisés. Nous avons évalué les fonctionnalités des communautés microbiennes de ces sites avec plusieurs bio-marqueurs de la qualité du sol. Afin d'estimer le devenir du mercure, des mesures du mercure total ainsi que des spéciations opérationnelles et environnementales ont été réalisées.

Ce travail de thèse a permis de mettre en évidence un effet positif de la revégétalisation sur la densité et les activités des communautés microbiennes. Les sites restaurés ont montré une biomasse microbienne, des taux de minéralisation des macroéléments (C, N, P), une diversité catabolique plus élevées que des sites non restaurés. Nos résultats confirment que la restauration influence les activités des communautés microbiennes anaérobies. En effet, les travaux portant sur les communautés bactériennes ferri-réductrices (BFR) et sulfato-réductrices (BSR) montrent des activités variantes entre les modalités de revégétalisation. Ces différences sont à mettre en relation avec les propriétés physiques et chimiques du sol ainsi qu'avec la nature du couvert végétal. Les communautés BFR sont actives sur les sites réhabilités alors que les communautés BSR seraient davantage actives sur les sites faiblement restaurés. Ces différences ont des conséquences sur la mobilité du mercure. Nos travaux montrent que si dans les sites revégétalisés le mercure est associé à des phases stables du sol alors que dans les sites non restaurés il est sous des formes solubles mobilisable dans le réseau hydrique, bio disponibles pour les organismes de la chaîne trophique.

Pour conclure, l'approche interdisciplinaire proposée dans ce travail a permis d'identifier certains processus d'écologie microbienne fondamentaux impactant le recouvrement des fonctionnalités des écosystèmes miniers dégradés. Ce travail offre un outil d'évaluation de la qualité de la restauration écologique original, appliqué et prometteur, qui pourra intéresser les décideurs responsables de la réhabilitation des sites miniers en Guyane française.

Abstract

For more than 150 years, gold mining in French Guiana has disrupted the landscape by causing massive deforestation of mining concessions. The consequences are multiple, both for the environment and human health. Indeed, for decades the use of mercury in the extraction process has led to pollution of aquatic systems, contaminating the food chain. To ensure that gold mining is carried out in a sustainable development perspective, the Mining Code has imposed an obligation since 1998 to rehabilitate the sites operated. Several revegetation methods using different plant species have been adopted to accelerate ecological succession. However, quality control of ecological restoration is difficult to implement, and it is necessary to have reliable and inexpensive bio-geo-indication tools to estimate the recovery of the functionalities of anthropized ecosystems and assess the risk of mobility of toxic metallic elements.

In this context, the objectives of this thesis work were to evaluate the quality of ecological restoration of mining sites in French Guiana through a characterization of microbial activities, the functioning of biogeochemical cycles of major elements (C, N, P) and the dynamics of mercury. The originality of this work lies in the evaluation over time and space of the interactions between vegetation cover - physico-chemical properties of the soil - microbial activities - mercury speciation after revegetation and making it a diagnostic tool for the success of this restoration. To this end, several sampling campaigns were carried out in French Guiana on a panel of rehabilitated mining sites, with different types of vegetation cover. Soil samples were taken from replanted sites with fabaceous species (*A. mangium* and *C. racemosa*), and from non-restored sites. We then evaluated the main functionalities of the microbial communities of these sites using several soil qualities bio-markers. In order to estimate the fate of mercury, measurements of total mercury as well as operational and environmental specimens were carried out.

This thesis work revealed a positive effect of revegetation on the density and activities of soil microbial communities. Sites restored with fabaceous species have thus shown microbial biomass, macro-element mineralization rates (C, N, P), and catabolic diversity significantly higher than sites that have not been restored. The associations of fabaceous plants show more conclusive results than the use of monoculture in terms of microbial functionalities. While the activities of aerobic microorganisms have been impacted by the return of vegetation, our results confirm that restoration influences the activities of anaerobic microbial communities. Indeed, work on iron-reducing (IRB) and sulfate-reducing (SRB) bacterial communities shows varying activities between revegetation modalities. These differences are related to the physical and chemical properties of the soil and the nature and density of the vegetation cover. BFR communities are more active on rehabilitated sites while SRB communities are more active on poorly restored sites. These differences in activities have consequences on mercury mobility and methylation. Our work also shows that while mercury in re-vegetated sites is associated with stable phases of the soil, including iron oxides, in non-restored sites it is in soluble forms that can potentially be mobilized in the water network, bioavailable and assimilated by organisms in the food chain.

In conclusion, the interdisciplinary approach proposed in this work made it possible to identify certain fundamental microbial ecological processes that impact the recovery of the functionalities of degraded mining ecosystems. This work provides an original, applied and promising tool for assessing the quality of ecological restoration that may be of interest to decision-makers responsible for the rehabilitation of mining sites in French Guiana.

Sommaire

Introduction générale

1. Introduction à la thématique de recherche	9
2. Objectifs et axes de recherches.....	11
3. Plan.....	12
4. Intérêt de la thématique de recherche.....	14

CHAPITRE 1 : L'orpaillage en Guyane, problématique du mercure et enjeux de la restauration écologique – Etat des connaissances 15

1. Généralités sur la Guyane	16
2. L'orpaillage en Guyane.....	19
3. Techniques d'orpaillage en Guyane.....	21
4. La problématique du mercure en Guyane	24
5. Les enjeux de la restauration écologique des sites miniers en Guyane française	31
6. Evaluation de la restauration écologique	36

CHAPITRE 2 : Influence de la restauration écologique sur la qualité d'un ancien sol minier en Guyane française..... 43

Article 1 – Mercury Behaviour and C, N, and P biogeochemical cycles during ecological restoration processes of old mining sites in French Guiana	46
---	----

CHAPITRE 3 : Influence d'une diversité de protocoles de restauration écologique sur les activités microbiennes telluriques d'anciens sites aurifères en Guyane française 76

Article 2 – Influence of temperature and soil moisture on biogeochemical cycles in former mining sites in French Guiana	80
--	----

Article 3 – Impact of vegetation cover on soil structure, microbial activity and diversity of former Guyanese mining sites	112
---	-----

Article 4 – Influence of microbial anaerobic metabolism on the mobilization of trace metallic elements on former mining sites in French Guiana	131
---	-----

CHAPITRE 4 : Influence d'une hétérogénéité de protocoles de réhabilitations et de revégétalisation sur la mobilité du mercure 158

Article 5 – Influence of different types of rehabilitation on microbial activities and mercury mobility on formers Guyanese mining sites	162
CHAPITRE 5 : Conclusion générale et perspectives	187
1. Rappel des objectifs	188
2. Principaux résultats.....	189
3. Discussion	194
4. Perspectives.....	201
Table des illustrations	203
Références bibliographiques	209

Listes des tables et figures

Chapitre I : Etat des connaissances

- Figure 1 : Carte géographique de la Guyane
- Figure 2 : Carte géologique de la Guyane
- Figure 3 : Carte pédologique de la Guyane
- Figure 4 : Histogramme du climat guyanais
- Figure 5 : Illustration d'une sluice artisanale
- Figure 6 : Photographie d'un sluice industrielle
- Figure 7 : Cycle global du mercure
- Figure 8 : Cycle du mercure dans un contexte d'orpillage
- Figure 9 : Photographie d'un site minier réhabilité avec une texture grossière
- Figure 10 : Photographie d'un site minier réhabilité avec une texture fine
- Figure 11 : Principales étapes de revégétalisation et de successions écologiques dans un contexte minier
- Figure 12 : Schéma simplifié du cycle global du carbone
- Figure 13 : Schéma simplifié du cycle global de l'azote

Chapitre II : Influence de la restauration écologique sur la qualité d'un ancien sol minier en Guyane française

- Article 1: *Mercury behaviour and C, N, and P biogeochemical cycles during ecological restoration processes of old mining sites in French Guiana*

Table 1 : Etapes des extractions séquentielles pour l'analyse du fractionnement des métaux dans le sol

Table 2 : Principales propriétés physico-chimiques des sites étudiés

Table 3 : Concentrations des principaux éléments traces métalliques dans les sites étudiés

Table 4 : Données relatives aux activités microbiennes en relation avec le turnover de la matière organique

Table 5 : Principales propriétés physico-chimiques et microbiologiques du site control naturel

Figure 1 : Représentation de la spéciation des différents éléments traces métalliques dans les fractions du sol

Figure 2 : Evolution des concentrations en mercure total au cours de l'expérimentation

Figure 3 : Evolution des concentrations en mercure soluble au cours de l'expérimentation

Figure 4 : Evolution des concentrations en mercure échangeable au cours de l'expérimentation

Figure 5 : Evolution des activités enzymatiques au cours de l'expérimentation

Chapitre III : Influence d'une diversité de protocoles de restauration écologique sur les activités microbiennes telluriques d'anciens sites aurifères en Guyane française

- *Article 2: Influence of temperature and soil moisture on biogeochemical cycles in former mining sites in French Guiana*

Table 1 :	Principales propriétés physico-chimiques dans sites étudiés
Table 2 :	Récapitulatif des résultats des ANOVA à 2 facteurs pour tester l'effet de la végétation et des différents traitements expérimentaux
Figure 1 :	Respiration du sol pour les différents sites pendant les 34 jours d'expérimentation
Figure 2 :	Minéralisation des nitrates pour les différents sites pendant les 34 jours d'expérimentation
Figure 3 :	Minéralisation de l'ammonium pour les différents sites pendant les 34 jours d'expérimentation
Figure 4 :	Activités uréases pour les différents sites pendant les 34 jours d'expérimentation
Figure 5 :	Activités déshydrogénase pour les différents sites pendant les 34 jours d'expérimentation
Figure 6 :	Activités enzymatiques globales pour les différents sites pendant les 34 jours d'expérimentation
Figure 7 :	Evolution des concentrations en mercure soluble pour les différents sites pendant les 34 jours d'expérimentation
Figure 8 :	Analyse Inter-groupe de l'effet site sur les propriétés microbiologiques mesurées au cours de l'expérimentation
Figure 9 :	Analyse Inter-groupe de l'effet traitement sur les propriétés microbiologiques mesurées au cours de l'expérimentation
Figure 10 :	Analyse Inter-groupe de l'effet site X effet traitement sur les propriétés microbiologiques mesurées au cours de l'expérimentation

- *Article 3: Impact of vegetation cover of former Guyanese mining sites on soil structure, microbial activity and diversity*

Table 1 : Principales propriétés physico-chimiques dans sites étudiés

Table 2 : Données microbiologiques, biomasse microbienne totale et potentiels de minéralisation en C, N et P des différents sites étudiés

Table 3 : Paramètres liés à la diversité catabolique des différents sites étudiés

Table 4 : Récapitulatif des résultats des ANOVA à 1 facteur pour tester l'effet et l'effet restauration écologique sur les différentes variables expérimentales

Figure 1 : Représentation en histogramme des différents substrats consommés lors de l'incubation des plaques Ecolog ecoplate

Figure 2 : Analyse Inter-groupe de l'effet site sur la diversité catabolique des communautés microbiennes des sites différents sites miniers réhabilités

Figure 3 : Analyse Inter-groupe de l'effet de la réussite de la restauration écologique sur la diversité catabolique des communautés microbiennes des sites différents sites miniers réhabilités

- Article 4: *Influence of microbial anaerobic metabolism on the mobilization of trace metallic elements on former mining sites in French Guiana*

Table 1 :	Principales propriétés physico-chimiques dans sites étudiés
Table 2 :	Récapitulatif des résultats des ANOVA à 2 facteurs et des ANOVA à mesures répétées pour tester l'effet et l'effet site et l'effet de l'incubation sur les différentes variables expérimentales
Table 3 :	Récapitulation des corrélations de Pearson entre les variables expérimentales mesurées au cours de l'incubation en conditions d'anaérobies
Figure 1 :	Evolution du pH pendant les 35 jours d'incubation en conditions d'anaérobies pour les différents sites
Figure 2 :	Evolution des concentrations en dioxyde de carbone pendant les 35 jours d'incubation en conditions d'anaérobies pour les différents sites
Figure 3 :	Evolution des concentrations en carbone organique dissous dans le milieu de culture pendant les 35 jours d'incubation en conditions d'anaérobies pour les différents sites
Figure 4 :	Evolution des concentrations en sulfates dans le milieu de culture pendant les 35 jours d'incubation en conditions d'anaérobies pour les différents sites
Figure 5 :	Evolution des concentrations en sulfures dans le milieu de culture pendant les 35 jours d'incubation en conditions d'anaérobies pour les différents sites
Figure 6 :	Evolution des concentrations en fer total dans le milieu de culture pendant les 35 jours d'incubation en conditions d'anaérobies pour les différents sites
Figure 7 :	Evolution des concentrations en fer (II) dans le milieu de culture pendant les 35 jours d'incubation en conditions d'anaérobies pour les différents sites
Figure 8 :	Evolution des concentrations en manganèse dans le milieu de culture pendant les 35 jours d'incubation en conditions d'anaérobies pour les différents sites
Figure 9 :	Evolution des concentrations en aluminium dans le milieu de culture pendant les 35 jours d'incubation en conditions d'anaérobies pour les différents sites
Figure 10 :	Evolution des concentrations en mercure dans le milieu de culture pendant les 35 jours d'incubation en conditions d'anaérobies pour les différents sites
Figure 11 :	Analyse en composante principale (PCA) des variables expérimentales mesurées au cours de l'expérimentation

Chapitre IV : Influence de l'hétérogénéité des protocoles de réhabilitation et revégétalisation sur la mobilité du mercure

- Article 5: *Influence of different types of rehabilitation on microbial activities and mercury mobility on formers Guyanese mining sites*

Table 1 : Principales propriétés physico-chimiques dans sites étudiés

Table 2 : Biomasse microbienne totale et activités enzymatiques des sites étudiés

Table 3 : Spéciation environnementale du mercure en fonction des différentes extractions

Figure 1 : Représentation en histogramme des différentes extractions du mercure

Figure 2 : Analyse en Co-inertie des propriétés physico-chimiques du sol et des activités microbiologiques

Figure 3 : Analyse en Co-inertie des propriétés physico-chimiques du sol et de la spéciation environnementale du mercure

Chapitre V : Conclusions générales et perspectives

Figure 1 : Schéma bilan des principaux résultats expérimentaux

Introduction générale

1. Introduction à la thématique de recherche

La pression environnementale des activités anthropiques sur la stabilité des écosystèmes est actuellement une source d'enjeux majeurs pour assurer le développement durable des générations futures. Le bassin amazonien, et notamment la Guyane française qui sera notre sujet d'étude, est certainement l'un des plus grands exemples d'enjeux, aussi bien écologiques qu'économiques.

Depuis des décennies, les activités anthropiques en Guyane française telles que l'agriculture, la sylviculture et bien sûr les activités minières, menacent l'intégrité écologique de l'un des plus grands réservoirs de biodiversité faunistique et floristique de la planète (Laurance *et al.*, 2004). La filière or en Guyane représente parfaitement ce dilemme entre développement économique et intégrité écologique. En Guyane française, l'exploitation aurifère depuis près de 150 ans (Montabo, 2004) est l'une des causes majeures de dégradations des écosystèmes tropicaux amazoniens mais représente également le troisième secteur d'exportation guyanais derrière les secteurs spatiaux et pétrolifères. L'utilisation prolongée du mercure, jusqu'au décret préfectoral n°1232/SG de 2006, dans le système d'exploitation (Lacerda, 2003) combinée à la déforestation et la destruction des terrasses alluvionnaires (Loubry, 2002) a entraîné une pollution chimique, une modification des micro-habitats et une altération des fonctionnalités des écosystèmes tropicaux et des cycles biogéochimiques (Chazdon, 2008; Ghazoul *et al.*, 2015; Loubry, 2002) dont les empreintes sont encore omniprésentes aujourd'hui. Cette pollution chronique au mercure est également responsable d'enjeux sanitaires majeurs puisque plusieurs études épidémiologiques (Réseau National de Santé Publique, Institut national de la santé et de la recherche médicale, 1994) ont mis en évidence des signes de contamination mercurielle chez les populations locales. Contamination s'effectuant principalement en raison de la consommation de poisson, surtout carnivores, et de la bioaccumulation du mercure dans la chaîne trophique (Fréry *et al.*, 2001).

Néanmoins, une prise de conscience depuis la fin du XX^{ème} siècle pour le maintien de la biodiversité et une meilleure gestion des écosystèmes, notamment tropicaux (Keenan *et al.*, 2015a) a permis de développer de nombreux programmes de recherche et de développement durable, notamment en restauration écologique (Martínez-Garza and Howe, 2003). La restauration écologique qui sera le point central de ce travail de recherche est la

conséquence directe de cette prise de conscience. Grâce aux principes de pollueur-payeur (adopté en 1972 par l'Organisation de coopération et de Développement puis par l'Acte unique européen en 1986), et au rapport Brundtland¹, les premiers socles du développement durable seront posés. Grâce à ces bases, le code minier français s'inscrit dans le développement durable et publie en avril 1998 (Journal Officiel) un article imposant dorénavant aux orpailleurs une obligation de réhabilitation des placers miniers à la fin de l'exploitation. Par la suite, les différents sommets pour la Terre (Rio et Kyoto), et le développement du principe de préjudice économique ayant fait l'objet d'un projet de loi en mai 2012), accentueront les efforts environnementaux que devront mettre en place les compagnies minières en Guyane française.

De nombreux protocoles de restauration écologique des parcelles minières guyanaises ont été développés pour répondre à des besoins environnementaux très particuliers et les premiers programmes de restauration ont notamment été développés par l'IRD (Institut de Recherche pour le Développement) (Loubry, 2002) avec des financements régionaux (ACPER) et européens (FEDER). Ces différents protocoles de restauration font appel à des notions et procédures très variées telles que le génie écologique, maîtrise du risque environnemental ou encore la gestion de la pollution. Néanmoins ces procédures ne sont pas normées et sont réalisées au cas par cas, en fonction de l'écosystème ciblé, sur des critères variables et indépendants. De plus, bien que certaines zones restaurées aient fait l'objet d'études fonctionnelles (Schimann *et al.*, 2012) ou d'études d'impacts (Kanowski *et al.*, 2010), la communauté scientifique manque encore de données pour évaluer les fonctions écosystémiques dans leur globalité au sein de ces parcelles réhabilitées. Ce manque de données, notamment sur le déroulement des cycles biogéochimiques des éléments majeurs (carbone, azote, phosphore) et des éléments traces métalliques limite notre capacité à proposer des solutions durables et sécurisées pour circonscrire la perte des milieux naturels.

Ce projet de thèse s'inscrit donc dans une démarche d'évaluation de certaines modalités de réhabilitation et de restauration écologique en Guyane française en s'appuyant sur des indicateurs de qualités physico-chimiques et biologiques du sol.

¹ Rapport : https://www.diplomatie.gouv.fr/sites/odysee-developpement-durable/files/5/rapport_brundtland.pdf

2. Objectifs et axes de recherches

Ce travail de thèse est le résultat de deux campagnes d'échantillonnages sur plusieurs concessions minières en Guyane française. Une première mission de prospection en décembre 2014 et une seconde en avril 2016 avec l'aide de Nouredine Bousserhine, Michel Grimaldi et Christian Pernaut. Les compétences de Christian Pernaut, opérateur minier, et ses connaissances des terrains miniers Guyanais nous ont permis de visiter un large panel d'anciens sites miniers, certains juste réhabilités et d'autres complètement restaurés et revégétalisés. A travers cet échantillonnage nous avons voulu cibler des parcelles minières dont l'historique d'exploitation et des protocoles de restauration écologique étaient connus.

Parmi ces sites nous avons retenus 2 sites entièrement restaurés dans l'ancienne mine de Yaoni, exploitée par la Compagnie Minière de Boulanger, dont les parcelles sont maintenant revégétalisées avec différentes essences de fabacées. Les parcelles du premier site ont été revégétalisées en 1998 avec une monoculture d'*Acacia mangium* alors que les parcelles du second site ont été restaurées avec une association d'*Acacia mangium* et de *Clitoria racemosa*. Nous avons également échantillonné du sol sur un autre site entièrement restauré dans l'ancienne mine de Bélizon, exploitée par la compagnie Ermina, dont les parcelles sont restaurées avec une monoculture de *Clitoria racemosa*. Pour compléter cet échantillonnage nous avons pris le parti de collecter du sol sur diverses parcelles minières, réhabilités après exploitation, mais où la reprise de la végétation arborée a été soit un échec, ou bien n'a pas été initiée par les opérateurs miniers.

L'objectif de cette thèse sera de répondre aux questions suivantes :

1. Quels sont les facteurs influençant la reprise de la végétation après l'étape de réhabilitation ? Est-ce que l'absence de protocoles de revégétalisation sur certains sites miniers est un frein au recouvrement des écosystèmes forestiers ?
2. Quels sont les indicateurs de qualité du sol pertinents pour évaluer les protocoles de restauration écologique ? Les cycles biogéochimiques sont-ils des témoins clefs de la reconstitution d'un écosystème tropical ? La restauration écologique a-t-elle permis la résilience des activités microbiennes dans les sols ?

3. L'utilisation de protocoles de revégétalisation contrôlés est-t-il un facteur clef du recouvrement de la qualité chimique du sol ? Est-ce que le niveau de complexité de ces protocoles influence les activités biogéochimiques dans les sols réhabilités ?
4. L'hétérogénéité des protocoles de restauration écologique peut-elle influencer la nature des communautés microbiennes et leur diversité catabolique ?
5. Quelle est l'impact de la restauration écologique sur le comportement du mercure et des principaux éléments toxiques dans les sols ? Quelles sont les principales phases porteuses et les principales formes chimiques mercure dans les sites réhabilités ? L'instauration d'un couvert végétal permet-elle de limiter la mobilité du mercure ?
6. Quelle est l'influence des communautés microbiennes des sites réhabilités sur le cycle biogéochimique du mercure ? Quelles sont les parts des processus microbiens aérobies et anaérobies dans la mobilité du mercure ?

L'aspect original de cette thèse sera donc de lier les différentes modalités de restauration écologiques au fonctionnement des cycles biogéochimiques ; l'enjeu étant de comprendre comment ces modalités influencent le comportement des communautés microbiennes du sol.

3. Plan

Les travaux de cette thèse seront illustrés à travers trois chapitres qui répondront aux différents objectifs initiaux. Le chapitre I se focalisera sur la présentation de la thématique de l'orpaillage en Guyane, en reprenant la problématique du mercure et de l'analyse de la qualité des sols réhabilités. Un développement particulier sera également accordé aux notions de réhabilitation et de revégétalisation, qui permettent de comprendre les enjeux de la restauration écologique des sites miniers.

Le chapitre II sera consacré à l'analyse de la qualité des anciens sols miniers échantillonnés lors de la première campagne sur les sites expérimentaux de Yaoni. Cette étude permettra notamment d'illustrer le contraste au niveau du fonctionnement

biogéochimiques des sols entre des parcelles minières entièrement restaurées, avec *Acacia mangium* et *Clitoria racemosa*, et non restaurés avec un couvert herbacé pauvre en biodiversité. Ces résultats permettront de dresser un bilan concernant l'impact de la restauration écologique sur les propriétés bio-physico-chimiques du sol.

Le chapitre III, constitué de trois parties, présente des analyses de métabolisme microbien dans les sols miniers restaurés. La première partie présentera une expérimentation en aérobie dans laquelle nous avons induit des perturbations simulant des variations climatiques. Cette expérimentation est une tentative de compréhension des réponses microbiennes des sols miniers à différents types de perturbations, en utilisant la chaleur et l'humidité comme facteur physique de stress ; avec comme objectif de comparer les réponses microbiennes en fonction de la nature du couvert végétal induit par la restauration écologique. La seconde partie présentera une analyse de la diversité métabolique et catabolique microbienne en fonction du gradient de restauration écologique. Les mesures des potentiels de minéralisation du carbone, du phosphore et du soufre couplées avec une analyse de la diversité fonctionnelles permettront d'affiner l'impact du processus de restauration écologique sur le fonctionnement des cycles biogéochimiques. La dernière partie du chapitre III présentera une simulation expérimentale d'anaérobiose sur les sites réhabilités. En raison de la topographie ces sites sont sensibles aux épisodes de crues et nous avons jugés pertinents d'analyser les conséquences de potentielles inondations sur le métabolisme microbien en conditions anaérobies. Ce travail se focalisera notamment sur les activités des communautés ferri et sulfato-réductrices en lien avec la solubilisation du fer, du manganèse, de l'aluminium et du mercure ; en essayant d'estimer les conséquences des inondations sur le cycle de certains éléments.

Le dernier chapitre de recherche (chapitre IV) présentera une analyse de la spéciation environnementale du mercure, avec pour objectif de comprendre comment la nature de la réhabilitation et de la revégétalisation impact le cycle et la mobilité de cet élément dans les sols.

Enfin, le dernier chapitre de cette thèse (Chapitre V) sera consacré à un bilan dans lequel nous essayerons de revenir sur les principaux résultats, leurs cohérences à travers les différents chapitres, et nous essayerons de proposer des perspectives de recherche et des

axes à développer pour compléter ce travail et les nombreuses questions qui sont apparues pendant ces 3 années.

4. Intérêt de la thématique de recherche

Les travaux de cette thèse ne se sont pas inscrits dans un programme de recherche financé exclusivement pour cette étude. Néanmoins, grâce aux sociétés Ermina et Compagnie Minière de Boulanger, nous avons pu bénéficier d'une aide logistique importante sur le terrain. Ces deux sociétés se démarquant par leur souhait de minimiser leur impact environnemental en s'inscrivant dans une démarche de développement durable, tout en assurant la pérennité de la filière aurifère. Les sites échantillonnés lors de cette thèse appartiennent tous aux anciennes concessions minières de ces deux entreprises. Cette étude contribuera à évaluer l'impact environnemental de la restauration écologique sur les fonctionnalités de certains cycles biogéochimiques en s'appuyant sur des descriptions des métabolismes microbiens telluriques. Nous espérons donc que cette étude pourra contribuer à la valorisation des programmes de restauration déjà initiés ; mais également à mettre en lumière certains de leurs défauts et qualités, dans le but d'optimiser les futurs programmes de restauration écologique.

Chapitre 1

L'orpillage en Guyane, problématique du mercure et enjeux de la restauration écologique – Etat des connaissances

1. Généralités sur la Guyane

La Guyane, ou Guyane Française est le plus grand département d'outre-mer du territoire français avec une superficie de près de 84 000 km², partageant une frontière commune avec le Suriname et le Brésil (**Figure 1**). L'histoire de la Guyane française est relativement récente et les premières installations françaises ne datent que du début du XVI^{ème} siècle. Après plus de deux siècles marqués par l'esclavagisme (1643 – 1848), la Guyane acquiert le statut de département français en 1946 en abandonnant son passé colonial. La création du Centre spatial Guyanais en 1968 a permis l'essor du département (15% du PIB pour la filière spatiale) et placé la Guyane comme un des acteurs clefs du développement du territoire français.

Avec moins de 260 000 habitants (2015), vivant principalement sur la côte Atlantique, la Guyane est également le département le moins densément peuplé. Sa population est néanmoins très riche en culture puisqu'elle abrite plusieurs ethnies amérindiennes (Galibi, Wayana, Arawak, Palikur, Wayampi, Emerillon), une forte communauté Hmong ainsi que des populations mixtes (créoles, immigrées du Brésil et du Surinam, européennes). Sa localisation (entre 2° et 6° de latitude Nord et 52° et 54° de longitude ouest) dans la ceinture équatoriale a permis le développement d'une biodiversité remarquable, dont la végétation couvre plus de 90% du territoire, donnant à la Guyane son statut de département le plus boisé. La biodiversité de la forêt primaire guyanaise a donné au département un statut de *Hot-Spot* de biodiversité, parmi les plus riches au monde, représentant à elle seule plus de 90% de la faune vertébrée et des plantes vasculaires françaises. La création en janvier 2007 du Parc Amazonien de Guyane est le reflet de la prise de conscience collective sur la préservation de la biodiversité. Le massif forestier Guyanais, propriété de l'Etat Français, est entièrement contrôlé par l'Office National des Forêts, ce qui a permis de développer un cadre strict et légal sur l'exploitation du territoire forestier. Cette gouvernance permet en outre un développement durable du secteur bois en Guyane avec l'exploitation de 826 000 hectares de forêt, répartis sur les quatre grands massifs forestiers guyanais. Parmi les autres secteurs primaires, les filières agricultures, élevages et pêches n'assurent que 4% environ du PIB mais permettent une auto-suffisance alimentaire sur le territoire. Du côté des activités

du secteur secondaire, nous nous intéresserons dans la partie suivante à l'industrie aurifère, qui sera un des points principaux de cette étude.

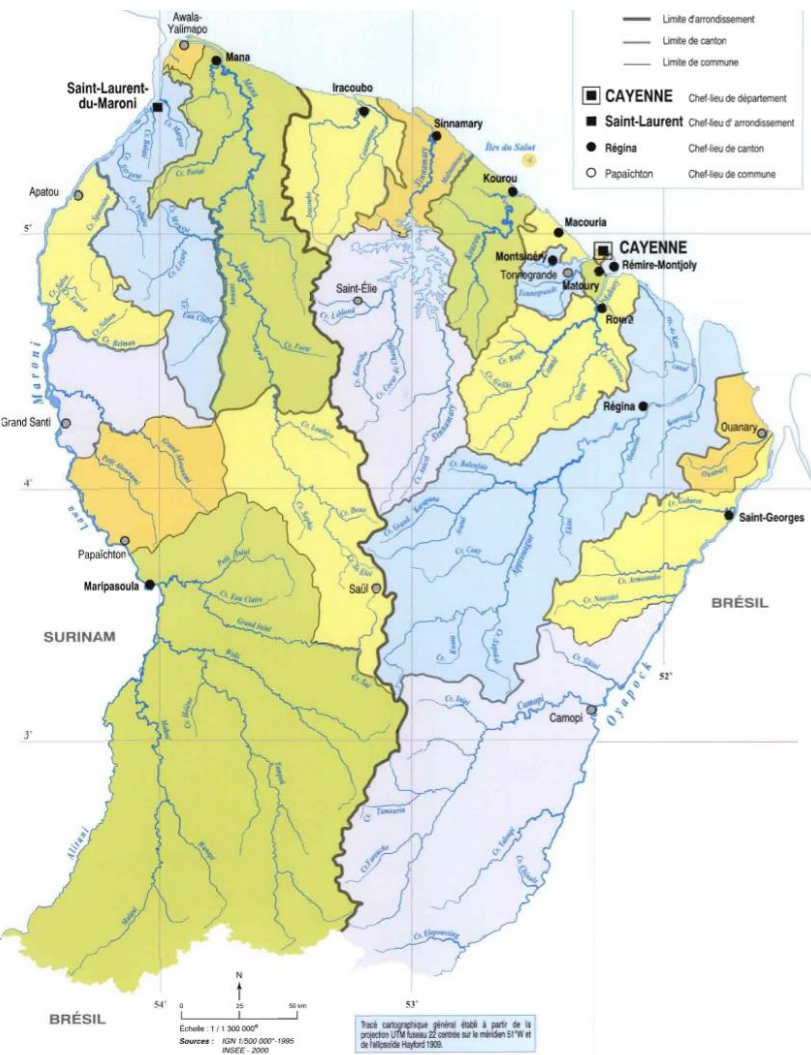

Figure 1 : Carte géographique de la Guyane. Source : Atlas illustré de Guyane, planche n°3, IRD Editions, 2001

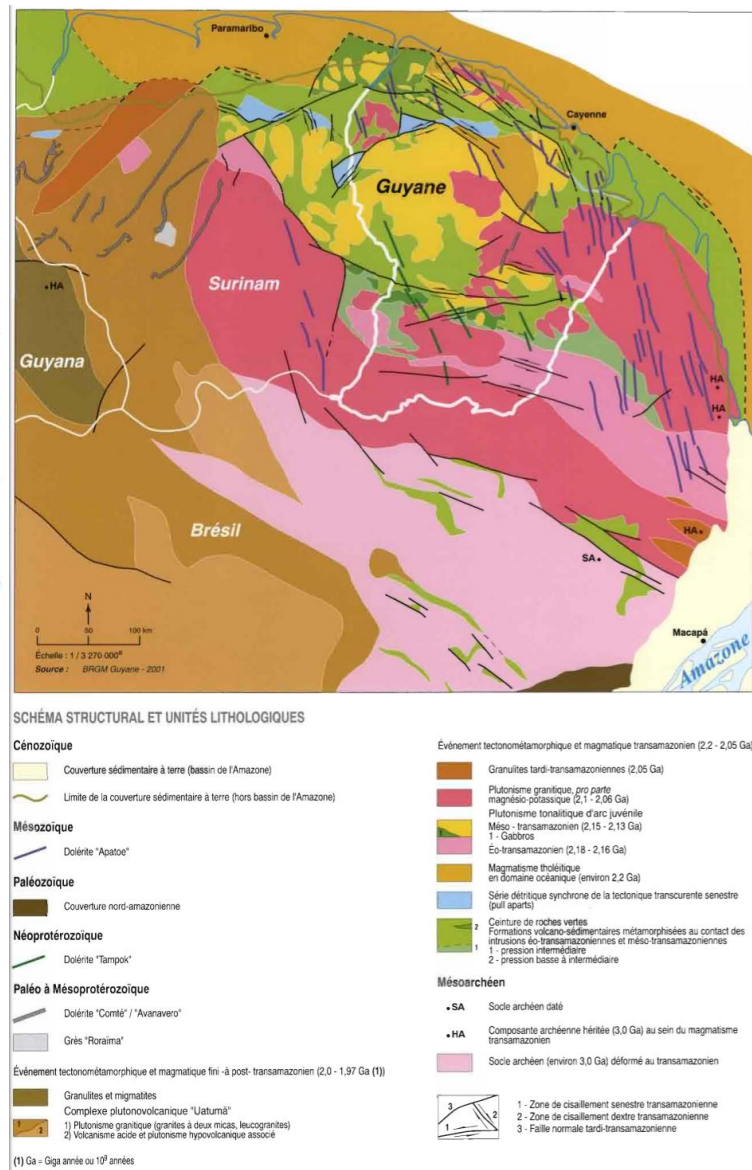

Figure 2 : Carte géologique de la Guyane. Source : Atlas illustré de Guyane, planche n°11, IRD Editions, 2001

Concernant sa géologie, toute la région guyanaise est sur un large Bouclier ou Craton guyanais (roche principalement granitique et métamorphique avec peu de sédiments de couverture) qui englobe également le Guyana, le Surinam, la partie nord du Brésil ainsi qu'une portion du Venezuela et de la Colombie. Les formations géologiques vieilles de 2 milliards d'années sont constituées de roches magmatiques, volcaniques et sédimentaires

qui sont localement métamorphisées en gneiss, amphibole et micaschistes (**Figure 2**). L'intégralité du socle est considérée comme ayant subi une forte altération physico-chimique en raison du climat tropical humide (température élevée, fortes précipitations et l'humidité permanente) et des formations latéritiques de plusieurs mètres, parfois dizaines, recouvrent les formations géologiques. En raison de ces processus d'altération, les sols ferrallitiques (**Figure 3**), acides, constituent la grande partie (65-70%) de la surface de la Guyane et sont caractérisés par de faibles teneurs en éléments nutritifs et de fortes teneurs en oxydes de fer (goethite, hématite) et d'Aluminium (gibbsite) qui donnent une couleur rouge très caractéristique.

Du fait de sa localisation dans la Zone Intertropicale de Convergence (ZIC), le climat guyanais est caractéristique des régions tropicales humides. Selon la classification de Köppen-Gelger, le climat se situe entre « Af : climat de forêt tropicale » et « Am : climat tropical de mousson », avec des température moyenne annuel d'environ 27°C répartie autour des saisons des pluies (petite saison des pluies de novembre à février, petit été de mars de mars à mai, saison des pluies de mai juillet, saison sèche d'aout à novembre. En fonction des saisons, les précipitations peuvent varier de 1700 millimètres à 4000 millimètres, avec une moyenne annuelle globale d'environ 2500-3000 millimètres en fonction de la région (**Figure 4**).

Concernant la topographie, l'altitude moyenne du Craton guyanais est d'environ 150 mètres mais certains massifs collinaires font figures de montagnes et culminent à plus de 500 mètres de hauteurs. Néanmoins, les « terres basses » du littoral ne représente que 5-6% de la superficie du territoire, et la plus grande partie du territoire intérieur, considérée comme des « terres hautes », est recouverte à près de 95% par la forêt tropicale humide guyanaise.

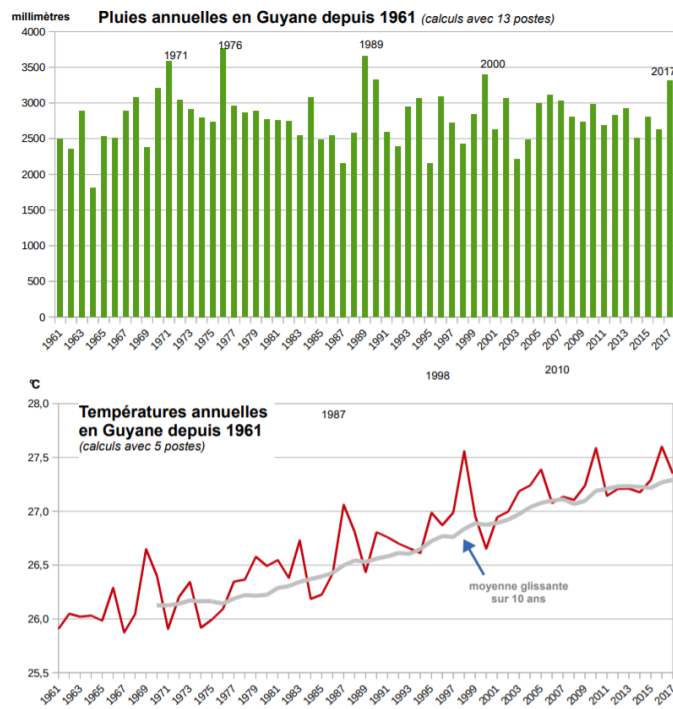
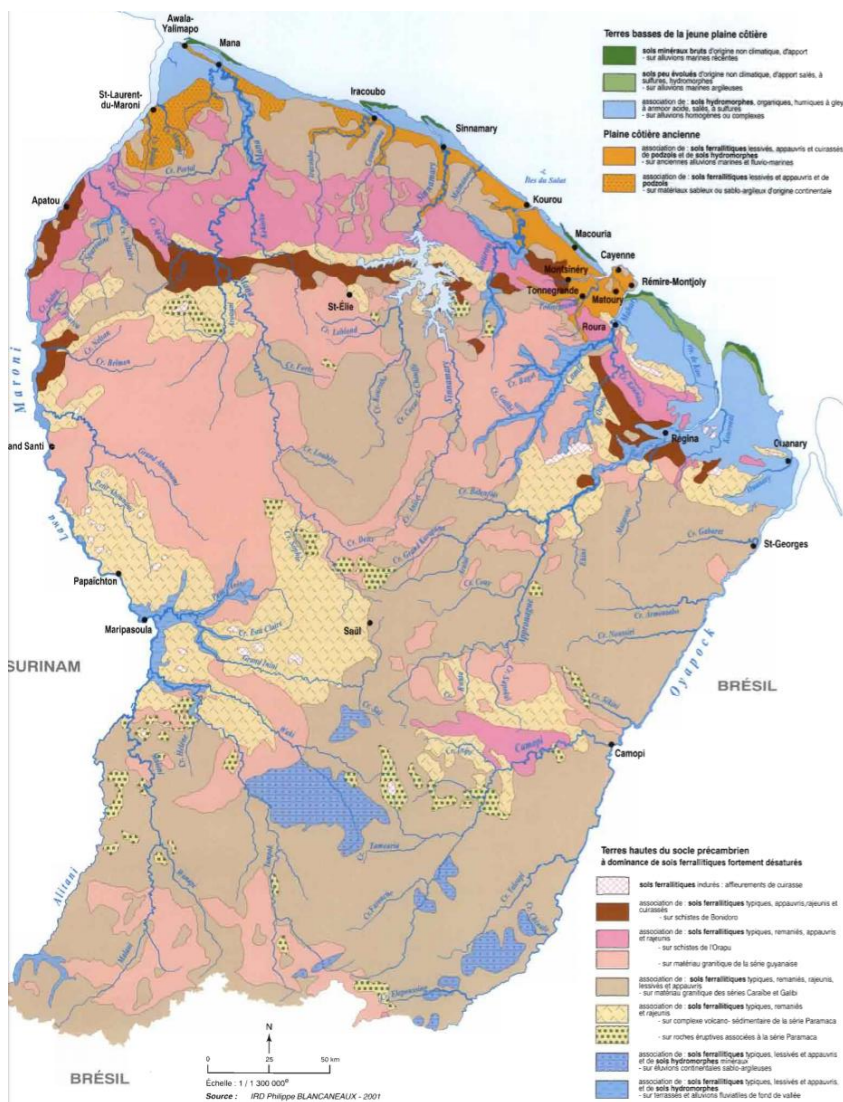

Figure 4 : Histogramme du climat, source météo France

2. L'orpaillage en Guyane

Le secteur minier Guyanais et plus particulièrement l'orpaillage est l'une des activités clefs du territoire guyanais (troisième poste d'exportation en 2013 derrière le secteur spatial et pétrolier) (Rapport IEDOM) et source d'enjeux aussi bien économiques (37,5 M€ de CA) qu'écologiques. Historiquement la découverte des premiers gisements d'or date de 1855-1857 et entraîna une ruée vers l'or de près de 12 000 personnes qui s'installèrent en Guyane pour faire fortune. A cette époque, les premiers sites d'exploitation étaient essentiellement des placers dans de petites rivières ou encore des exploitations de colluvions latéritiques. Cette exploitation a rapidement épuisé les placers et certains auteurs estiment qu'elle avait une ampleur supérieure aux exploitations actuelles avec une utilisation non contrôlée du mercure dans le processus d'extraction. Le secteur aurifère a décliné après la première guerre mondiale jusqu'en 1983, date clef à laquelle le BRGM (Bureau de Recherche

Géologiques et Minières) publie une série d'études géologiques et de prospections minières. Cette mise à jour de la cartographie des gisements, combinée à une amélioration des techniques d'extractions a permis de relancer le secteur, entraînant malheureusement un essor de l'orpaillage illégal.

Actuellement, moins d'une quarantaine d'exploitants (34 titres miniers en 2015) possède leur propre concession d'exploitation et la difficulté d'obtention de titres miniers a permis un meilleur contrôle des exploitations légales. L'orpaillage légal emploie environ 550 travailleurs déclarés (Iedom, 2017) et il est réparti sur deux types de gisements. Les compagnies de grandes envergures et internationales exploitent l'or primaire, nécessitant des moyens techniques et logistiques importants, alors que les PME se concentrent sur l'or alluvionnaire, provenant de l'érosion de l'or primaire. Les principales exploitations étant localisées vers Saint-Elie, dans le centre autour de Saül, près du fleuve Maroni et à Camp Caïman.

Si le nombre de travailleurs légaux a légèrement reculé pendant les dernières décennies, l'envol du cours de l'or entre 2002 et 2012 a considérablement augmenté les activités d'exploitations illégales. Bien qu'il soit difficile d'estimer l'activité des exploitations clandestines, la DRIRE estime que l'activité minière clandestine emploierait entre 4000 et 10 000 clandestins et pourrait produire des quantités d'or plus importantes que l'orpaillage légal (3 tonnes d'or brut contre 1,2 tonne en 2015). Néanmoins, la mise en place en 2008 du dispositif « Harpie » - qui succède aux opérations Anaconda et Toucan - menée par les forces de gendarmerie et les forces armées en Guyane (FAG) a permis d'améliorer la lutte contre les exploitations illégales. S'il est difficile d'estimer le recul des exploitations illégales, l'augmentation des saisies et de la destruction de camp illégaux aurait entraîné une baisse de 40% des sites clandestins.

L'exploitation aurifère a également un lourd passif de pollution environnementale. Avant le décret préfectoral n°1232/SG de 2006, l'utilisation du mercure dans le processus d'extraction était en effet la méthode la plus courante et l'une des méthodes les plus rentables. A raison de l'utilisation de 1,3 g de mercure pour 1 g d'or produit, le BRGM estime que la quantité de mercure d'origine anthropique utilisée serait supérieure à 300 tonnes, avec environ 5 à 10 tonnes de rejet mercuriel par an (Lacerda, 2002; Nriagu, 1994).

3. Techniques d'orpaillage en Guyane

3.1. Orpaillage artisanal

Les exploitations ayant vu le jour après la ruée vers l'or étaient artisanales et utilisaient des méthodes relativement rudimentaires d'exploitation de l'or alluvial, issu de l'altération de l'or primaire, se retrouve dans les alluvions sous forme de paillettes et de pépites et il est relativement libre et diffus. Sa densité importante (19,3) est à l'origine des premières techniques d'orpaillages à la batée.

Par la suite, des méthodes gravimétriques utilisant des rampes de lavage inclinées (Sluice ou Longtom (**Figure 5**), longues de plusieurs mètres, étaient très communément utilisées. Dans ces dispositifs, des séries de grilles de maillages divers créant des turbulences, sont installées sur toute la longueur des rampes de lavage qui permettaient de piéger les paillettes et pépites d'or en les dissociant des particules fines de sol ou de sédiment. Les premiers grillages étaient réalisés avec de la paille, ce qui donnera son nom à l'orpaillage. Les particules plus lourdes étaient ensuite triées à la batée puis amalgamées au mercure élémentaire. La récupération des particules d'or était effectuée après chauffage de l'amalgame à plus de 500°C pour permettre l'évaporation du mercure. Ce type d'exploitation ancestrale avait un rendement très faible comparé aux techniques récentes. De plus, l'absence de dispositif de recyclage du mercure lors du chauffage a conduit à d'importantes émissions de mercure élémentaire gazeux et dissous.

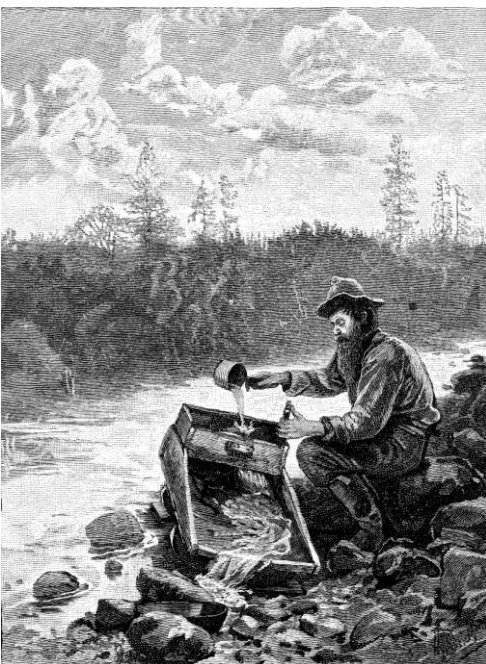

Figure 5 : Sluice artisanale The Century illustrated monthly magazine; 1883 Jan., p. 325



Figure 6 : Sluice industrielle, crédit RMS - Ross

3.2. Orpailage gravimétrique moderne

Les procédés récents font appel aux mêmes principes que l'orpailage artisanal (**Figure 6**) mais les nouveaux dispositifs sont plus performants et l'amélioration des rendements a permis aux exploitants de retourner sur des parcelles anciennement exploitées. Sur les sites d'orpailages industriels, l'utilisation de pelles hydrauliques permet maintenant d'élargir l'exploitation du sol et des sédiments aurifères alluvionnaires (le tout-venant) en excavant les lits majeurs des rivières. L'intégralité des matériaux d'intérêt est ensuite déstructurée et lavée grâce à des jets d'eau sous pression (lances monitors) et la boue ainsi formée (la pulpe) est dissociée sur des sluices de grandes tailles. Contrairement aux techniques artisanales qui relarguent les fractions fines directement dans les rivières, la fraction fine est ici stockée dans des bassins de décantation (les baranques), ce qui permet de réduire la turbidité. Les fractions les plus lourdes retenues dans les grilles (le concentré) sont ensuite récupérées et traitées pour en extraire l'or et le purifier au maximum. Cette séparation était généralement réalisée selon le procédé précédemment décrit ; en amalgamant les particules avec du Hg puis en brûlant l'amalgame. L'utilisation du mercure étant proscrite depuis 2006, la purification de l'or à partir du « concentré » est actuellement réalisée avec des méthodes gravimétriques.

L'utilisation d'un JIG permet la dissociation par succion des différentes fractions du « concentré » en fonction de leur masse. Les fractions légères (sables et minéraux primaires) sont éliminées et les fractions lourdes (Or, plomb, cuivre) sont ensuite triées sur des tables à secousse. Les purifications successives par chaleur permettent également d'évaporer le mercure naturel ou anthropique présent dans le sol sous formes de vapeurs, qui, une fois condensées pourront être récupérées. L'ajout de Borax dans des fours à induction par fusion et cristallisation fractionnée permet de purifier et d'éliminer les derniers minéraux non-désirés. Les dernières étapes de purification ne sont pas réalisées par les exploitants miniers et en fin de process l'or guyanais est pur à 95% environ. Le reste des impuretés étant généralement du plomb, de l'argent ou du cuivre.

3.3. Procédés de cyanuration

La technique de cyanuration est plus récente et ce n'est que depuis les années 1970 qu'elle est utilisée de manière intensive dans l'extraction de l'or, notamment en raison de l'envolée du cours de l'or qui a rendu ce procédé rentable. Historiquement, la cyanuration, ou

procédé MacArthur-Forrest, a été mise au point par John Stewart MacArthur et par les frères Forrest, à la fin du XIX^{ème} siècle après des recherches concernant les réactions de dissolution des éléments métalliques.

En Guyane française, cette méthode permet une exploitation de l'or primaire après une extraction des matériaux d'intérêts. Un fois extrait, le minerai doit être finement broyé (taille inférieure à un millimètre) puis transporté vers des réservoirs de lixiviation. Ces réservoirs contiennent des sels de cyanure (cyanure de potassium, de sodium ou de calcium) et vont permettre la formation d'un sel quadruple d'or lorsqu'il y aura contact entre le minerai et le cyanure en présence d'oxygène.

La réaction de dissolution des particules solides contenant les particules d'or est plus généralement décrite selon la réaction d'Elsner :

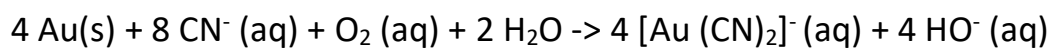

Le lixiviat de sel quadruple est ensuite traité avec une mise en contact avec des particules de zinc et d'aluminium afin de précipiter l'or dissous, selon le procédé Merrill-Crowe :

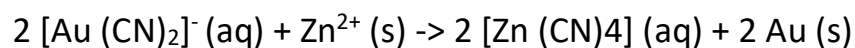

L'excès de zinc ou d'aluminium est ensuite éliminé par une digestion acide et un passage dans un four à plus de 600°C pour oxyder les résidus.

Bien que performant, ce procédé remis en question en Guyane en raison de la grande quantité de déchets toxiques produits pendant l'exploitation et stockés dans des bassins de rétention, protégés par des digues. Les précipitations importantes font craindre des ruptures des bassins de rétention, qui entrainerai une contamination aigüe des rivières guyanaises avoisinantes. Avant le XXI^{ème} siècle, la cyanuration n'avait été utilisé en Guyane uniquement lors du projet de la mine de Changement (1990) et avait démontré son haut rendement avec plus de 85% du minerai d'or extrait. Néanmoins, la cyanuration est depuis plusieurs années une nouvelle source de préoccupation car elle est utilisée par la multinationale Auplata-Nordgold sur différents sites tels que Yaou, Dorlin, Dieu-Merci et Remire-Montjoly. En cas de validation du projet « Montagne d'or », la cyanuration serait également au cœur des

préoccupations puisque plusieurs bassins de rétentions de millions de mètres cubes seraient créés afin de traiter plus de 12 000 tonnes de minerai par jour pendant 12 ans, en utilisant environ 10 grammes de cyanure par tonne de résidu.

4. La problématique du mercure en Guyane

4.1. Généralités sur le mercure

Le mercure est un métal de couleur argent brillant, caractéristique qui lui a valu d'être appelé « Vif argent » par de nombreux alchimistes. Son symbole (Hg) provient du latin *Hydrargyrum* qui signifiait argent liquide. Le mercure (Hg) est l'élément n°80 du tableau périodique des éléments, classé dans le groupe IIB au même titre que le zinc ou le cadmium. Sa densité > 6 le caractérise comme étant un élément trace métallique. D'une manière générale, dans l'environnement, le mercure existe majoritairement sous sa forme métallique Hg⁰ (phase gazeuse possible), sous forme de composés organiques et inorganiques ou sous forme de cinabre HgS qui est la forme minérale du mercure la plus fréquente.

Si les premières utilisations du mercure pour amalgamer l'or remontent à l'antiquité, cet élément a eu bien des vertus à travers l'histoire. Hippocrate de Cos (-460 av.J.-C. -377 av.J.-C.), un des « pères de la médecine », l'aurait utilisé pour ses propriétés médicinales. Toujours dans l'antiquité ainsi qu'à la renaissance, il était utilisé sous forme de sulfure de mercure en tant que cosmétique pour blanchir la peau (Anderson, 1979). Il sera également utilisé pour soigner la syphilis grâce à un traitement développé par le physicien Paracelsus Popula (1493-1541). Certaines utilisations plus récentes nous sont familières, telles que le thermomètre à mercure, mis au point en 1724 par Daniel Gabriel Fahrenheit (1686 – 1736). C'est cependant à l'époque préindustrielle que l'exploitation du mercure s'est accrue et que ses propriétés amalgamantes de l'or seront utilisées dans l'exploitation minière ainsi que dans certains antiseptiques ou encore dans les amalgames dentaires et dans les piles (Carpi, 2001).

4.2. Toxicité du mercure

Le mercure ne possède aucun rôle biologique et plusieurs études ont rapporté ses caractères biocide, mutagène et tératogène (Clarkson and Magos, 2006). D'une manière générale, la toxicité du mercure est associée à ses formes organiques méthylées hautement neurotoxiques, aussi appelées composés organomercuriels (méthylmercure et diméthylmercure principalement) (Veiga *et al.*, 1999). La forme métallique Hg⁰ peut également être inhalée et absorbée au niveau des membranes alvéolaires des poumons,

cependant, bien qu'ayant des effets similaires au méthylmercure, les concentrations nécessaires conduisant aux complications sanitaires sont plus élevées pour le Hg⁰, ce qui minimise légèrement ses conséquences néfastes.

La première prise de conscience pour limiter l'utilisation du mercure dans l'industrie intervint après l'incident de la baie de Minamata, au Sud-Ouest du Japon sur l'île de Kyushu. Tristement célèbre, l'usine « Chisso-corporation » relargua dans la baie de Minamata entre 1932 et 1965 près de 80 tonnes de mercure nécessaire à la fabrication de l'acétaldéhyde, qui s'est bioaccumulé dans les organismes aquatiques. Cette catastrophe sans précédent entraîna la mort d'un millier de personnes et une contamination de plusieurs millions de japonais, dont les conséquences sont encore préoccupantes (Veiga and Baker, 2004). Les habitants de la baie ayant consommé les poissons contaminés développèrent des pertes d'audition, des réductions du champ visuel, une diminution des sensations et de la coordination des membres. Ces symptômes ont été regroupés sous l'appellation de « maladie de Minamata » (Ekino *et al.*, 2007).

Le second incident a été engendré par une consommation de graines de semences d'orge et de blé traitées avec des organomercurels en 1971 en Irak. Ces graines qui ne devaient servir qu'à la culture ont été consommées au cours d'un épisode de famine important. Cette erreur a coûté la vie à 459 personnes et provoqué plus de 100 000 intoxications (Veiga and Baker, 2004).

Actuellement, près de 50% de la population Guyanaise vit le long des fleuves du département tels les amérindiens Wayanas regroupés sur les bords du fleuve Maroni. Le suivi de la contamination au mercure par la Direction Sanitaire et de Développement Social (DSDS) a mis en évidence une forte contamination mercurielle des écosystèmes aquatiques et des hommes via le réseau tropique, par la forme organométallique du mercure ; le méthylmercure. Les études des populations amérindiennes du Haut Maroni et du Haut Oyapock, réalisées à partir de 1994 ont mis en évidence des taux de mercure dans le sang et les cheveux supérieurs aux valeurs recommandées par l'Organisation Mondiale de la Santé ($11,4 \mu\text{g}\cdot\text{g}^{-1}$ contre $2 \mu\text{g}\cdot\text{g}^{-1}$) (Boudou *et al.*, 2006; Charlet and Boudou, 2002). La valeur seuil, déterminée par l'OMS au-delà de laquelle les risques neurologiques sont importants étant de $10 \mu\text{g}\cdot\text{g}^{-1}$ (Clarkson, 1992; Dolbec *et al.*, 2000; Grandjean *et al.*, 1999), le risque pour les populations guyanaises est bien présent et ces populations ayant pour alimentation

principale la consommation des poissons de rivières, la contamination est d'autant plus importante (Fréry *et al.*, 2001). Bien que les quantités de mercure ingérées ne soient pas aussi élevées qu'à Minamata ou en Irak, la contamination chronique de ces populations touche principalement les femmes au cours de la grossesse et constitue un risque majeur pour le développement neurologique des enfants à naître (Clarkson and Magos, 2006).

4.3. Le cycle biogéochimique du mercure

Le cycle du mercure est complexe (**Figure 7**) et grâce à sa volatilité il est présent dans tous les compartiments de la biosphère et ses temps de résidence y sont très variables en fonction des conditions physico-chimiques.

Les espèces chimiques les plus importantes de mercure participant au cycle géochimique de cet élément peuvent être classées comme telles (Alloway, 2012) :

- Composés volatiles : Hg^0 ; $(\text{CH}_3)_2\text{Hg}$
- Espèces réactives : Hg^{2+} , HgX_2 , HgX_3^- , et HgX_4^{2-} avec $\text{X} = \text{OH}^-$, Cl^- ou Br^- ; HgO sous forme d'aérosol, Hg^{2+} complexés avec des ligands organiques.
- Espèces non-réactives : Méthylmercure (CH_3Hg^+ , CH_3HgCl , CH_3HgOH) et autres composés organomercuriels ; $\text{Hg}(\text{CN})_2$; forme minérale cinabre (HgS); Hg^{2+} lié majoritairement aux composés soufrés dans la matière humique.

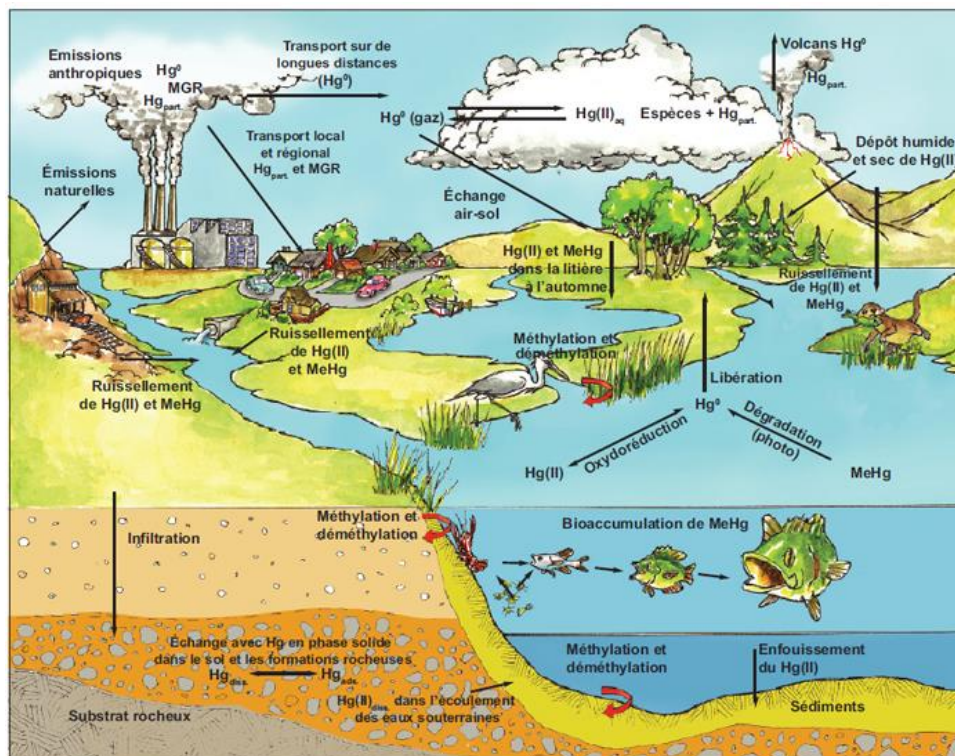

Source : Tetra Tech, Inc., 2010.

Figure 7 : Cycle global du mercure. Source : Tetra Tech, Inc, 2010. Hg^0 : mercure élémentaire ; $\text{Hg}(\text{II})$: mercure inorganique oxydé ; MeHg : monométhylmercure ; HgS : Sulfure de mercure

Dans l'air, les concentrations moyennes en mercure sont d'environ 3 nM m⁻³. Dans l'atmosphère amazonienne, l'oxydation du mercure élémentaire en Hg²⁺ peut être importante en raison de la forte concentration de composés organiques volatiles dus à la végétation et aux précipitations. A l'échelle de la terre, le temps de résidence du mercure dans l'atmosphère peut être important mais en raison d'une forte humidité en région tropicale, le temps de résidence du mercure ionique en Guyane peut être inférieur à deux semaines. En région tropicale, le couvert végétal joue également un rôle dans le cycle atmosphérique du mercure. Les émissions de mercure élémentaire provenant du couvert végétal peuvent également être importantes (Amouroux *et al.*, 1999; Tessier *et al.*, 2003) de même que la fixation du mercure au niveau des feuilles et des racines, qui sera ensuite redistribué au sol lors de la dégradation de la matière organique (Millhollen *et al.*, 2006).

Dans les sols guyanais, le mercure a des origines naturelles et anthropiques. Les sources originelles de mercure communes à tous les sols sont les minéraux, constituant les roches du fond géochimique. Ce fond géochimique peut être défini comme la quantité de mercure présent dans les sols avant les apports anthropiques. Dans les sols du bassin amazonien le fond géochimique du mercure est assez élevé est les concentrations peuvent être dix fois supérieures que dans les régions tempérées (Roulet and Lucotte, 1995, Grimaldi *et al.*, 2001). Les sols tropicaux amazoniens sont souvent considérés comme des puits à mercure (Mason *et al.*, 1994).

Cet apport est particulièrement élevé en Amazonie puisqu'il serait à l'origine d'environ 97% de mercure stocké dans les sols (Roulet *et al.*, 1999). Ce fond géochimique a deux origines : Lithogéniques et exogéniques.

Les apports lithogéniques proviennent de l'accumulation résiduelle du mercure originaire du matériel parental tout au long des processus d'altération et de la transformation du sol. En Guyane, l'érosion a mis à nu de grandes étendues granitiques et réduit les étendues d'origine volcanique et sédimentaire. Ces zones sont recouvertes par 20 à 40 mètres d'altérite et sont naturellement riches en mercure. L'ablation de ces couches superficielles par érosion permet de rapprocher de la surface les horizons plus profonds riches en mercure (Grimaldi *et al.*, 2001).

Les apports exogéniques proviennent de l'accumulation du mercure depuis des millions d'années via les retombées atmosphériques des émissions volcaniques, océaniques et de la végétation. Ces apports entraînent une augmentation importante des concentrations en mercure dans les horizons de surface. Des études récentes montrent que les apports exogéniques sont très nettement supérieurs aux apports lithogéniques (Guedron *et al.*, 2006).

En Guyane, les apports anthropiques ne représenteraient que 3% du mercure total dans le système sol-eau-sédiment. La majeure partie des apports anthropiques est la conséquence directe des activités d'orpillages depuis près de 150 ans. Avant l'interdiction d'utilisation du mercure, les orpailleurs professionnels admettaient ainsi utiliser jusqu'à 1,3g de Hg pour 1g d'or produit, ce qui a conduit à des rejets d'environ 5 à 10 tonnes de mercure par an en Guyane (Lacerda *et al.*, 2004). Si l'on considère l'ensemble des activités d'orpillages sur le bassin amazonien, les études estiment à près de 200 tonnes de mercure rejetés par an : des quantités historiques selon le BRGM (Lacerda, 2002).

Dans le sol, et notamment dans les sols tropicaux, le mercure peut interagir avec les différentes phases du sol. Bien que les teneurs en argiles dans les sols tropicaux ferrallitiques soient variables, le mercure peut être adsorbé sur des minéraux silicatés tels que la kaolinite ou la muscovite (Boulet 1978, Roulet *et al.*, 1998), mais la capacité d'adsorption cationique de ces minéraux pour le mercure reste faible (Guedron *et al.*, 2009; Sarkar *et al.*, 2000). Par conséquent, la fraction du sol qui sera majoritairement responsable du devenir du mercure dans le sol sera la nature de la matière organique ainsi que la présence d'oxydes et oxy(hydr)oxydes de fer, d'aluminium et de manganèse.

Le mercure a une forte affinité pour la matière organique dans les sols, liée à son affinité pour les groupements sulfures (Anderson, 1979; Neculita *et al.*; Schuster, 1991). Plus précisément, ce sont les groupements S réduits (thiols, sulfures, disulfures) qui fixent le mercure (Khwaja *et al.*, 2006). L'adsorption du mercure dans la matière organique sera donc grandement impactée par sa vitesse de minéralisation. Cependant, certaines études montrent que les acides humiques et certains complexes organiques peuvent adsorber davantage d'Hg (II) que les oxydes métalliques et minéraux argileux (Xu and Allard, 1991).

L'adsorption du mercure est également très importante sur les oxydes et oxyhydroxydes métalliques (Wasserman *et al.*, 2003). Les sols ferrallitiques, dominant en Guyane française, sont naturellement riches en fer et en aluminium (Ruellan and Dosso, 1993), en raison des processus pédogénétiques et climatiques ayant modelé le paysage guyanais pendant des milliers d'années. Il a largement été démontré que ces oxydes interviennent majoritairement dans l'adsorption et la rétention du mercure dans les sols tropicaux (Fadini and Jardim, 2001; Gonçalves *et al.*, 1998; Roulet *et al.*, 1998; Roulet and Lucotte, 1995). L'adsorption du mercure sur ces oxydes est possible principalement grâce à des mécanismes de co-précipitation (par inclusion, substitution isomorphique ou formation de solution solide) (Cornell and Schwertmann, 2003 ; Sposito, 1983). L'adsorption est majoritairement spécifique (interaction avec un groupement hydroxyle déprotoné de la surface minérale) ou non spécifique (grâce à la présence d'eau entre le cation adsorbé et les groupements fonctionnels de surface) (Bradl, 2004; Sarkar *et al.*, 1999).

4.4. Méthylation du mercure

Le méthylmercure est la forme organique la plus toxique du mercure qui a notamment été responsable de la contamination de la baie de Minamata en raison de sa bioaccumulation dans la chaîne trophique. La méthylation du mercure inorganique est un processus important mais qui a longtemps été peu étudié en raison des très faibles concentrations de méthylmercure accumulées naturellement dans l'environnement (Poulain *et al.*, 2007).

Les processus de méthylation peuvent être abiotiques et des auteurs ont mis en évidence des processus de transméthylation entre le mercure et les alkyls de plomb, d'étain et d'arsenic (Ebinghaus and Gister, 1994) et des processus faisant intervenir la méthylcobalamine (Weber, 1993), la matière organique (Weber, 1993) ou encore l'acide acétique (Gårdfeldt *et al.*, 2003). Néanmoins, dans un milieu naturel, même dans des sols inondés, c'est généralement la méthylation biotique qui prédomine.

Plus courante, la méthylation biotique peut être contrôlée directement ou indirectement par différentes espèces de microorganismes telles que les archées méthanogènes, les microorganismes anaérobies, certains organismes aérobies tels que *Pseudomonas spp*, *Bacillus megaterium*, *Escherichia coli* ou *Enterobacter aerogenes*, et certains champignons comme *Aspergillus niger* ou *Saccharomyces cerevisiae*. Les taux de

méthylation biotique seront dépendants d'un certain nombre de facteurs, dont les premiers sont les activités métaboliques et la structure des communautés microbiennes méthylantes. La spéciation du mercure sera également un facteur clé puisque c'est sa forme chimique et son niveau de complexation dans le milieu (Ullrich *et al.*, 2001) qui déterminera sa biodisponibilité pour les mécanismes de méthylation. Les autres paramètres déterminants les taux de méthylation seront les conditions physico-chimiques du milieu comme la température, le pH, le potentiel redox et la présence d'agents complexants tels que la matière organique ou les oxydes de fer. Il est crucial de préciser que la méthylation sera souvent la conséquence des interactions de ces paramètres et qu'il serait donc important de tous les considérer pour expliquer ces mécanismes dans l'environnement.

La méthylation biotique indirecte fait intervenir des produits du métabolisme pour réaliser la méthylation. Ces composés agissent comme des donneurs de groupements méthyl, à l'intérieur ou à l'extérieur des membranes cellulaires. Parmi ces composés on retrouve notamment la méthylcobalamine (CH_3B_{12} , une des formes actives de la vitamine B12), le iodiméthane (CH_3I) ou le méthyl-étain (CH_3Sn). Quand ces molécules sont produites, le transfert non-enzymatique du groupement méthyl sur une molécule de mercure ionique assure la formation du méthylmercure (Sand, 2003; Ullrich *et al.*, 2001).

La méthylation biotique directe requiert des enzymes de la voie de l'acétyl-coenzyme A (COA), une voie du métabolisme qui transforme l'acétate en CO_2 et inversement. En fin de métabolisme, l'acétate est dissocié en CO et en un groupement méthyl, qui pourra être fixé à du mercure ionique Hg (II) grâce à une enzyme, la méthyl transférase II. Parmi les microorganismes méthylateurs en conditions anaérobies, les bactéries sulfato-réductrices sont des organismes clés de la méthylation. Un mécanisme de méthylation connu ; celui de *Desulfovibrio desulfuricans* (Choi *et al.*, 1994; Compeau and Bartha, 1985; King *et al.*, 2002, 2000) permet un couplage de la méthylation avec la réduction du soufre et le métabolisme de l'acétate (Ekstrom *et al.*, 2003). Plus récemment, la mise en évidence de mécanismes de méthylation chez les bactéries ferri-réductrices du genre *Geobacter*, a montré un couplage entre la méthylation et la réduction du fer (III), des nitrates ou du fumarate (Fleming *et al.*, 2006). Néanmoins, la méthylation chez les bactéries ferri-réductrices n'est pas omniprésente et leurs activités sont souvent couplées avec le métabolisme des bactéries sulfato-réductrices.

Dans un contexte minier, notamment en milieu tropical, le mercure a son cycle modifié par rapport à des conditions naturelles, les apports anthropiques modifiant les flux de mercure dans l'environnement. La **figure 8** représente le cycle du mercure dans un environnement relatif à l'orpaillage en Guyane française.

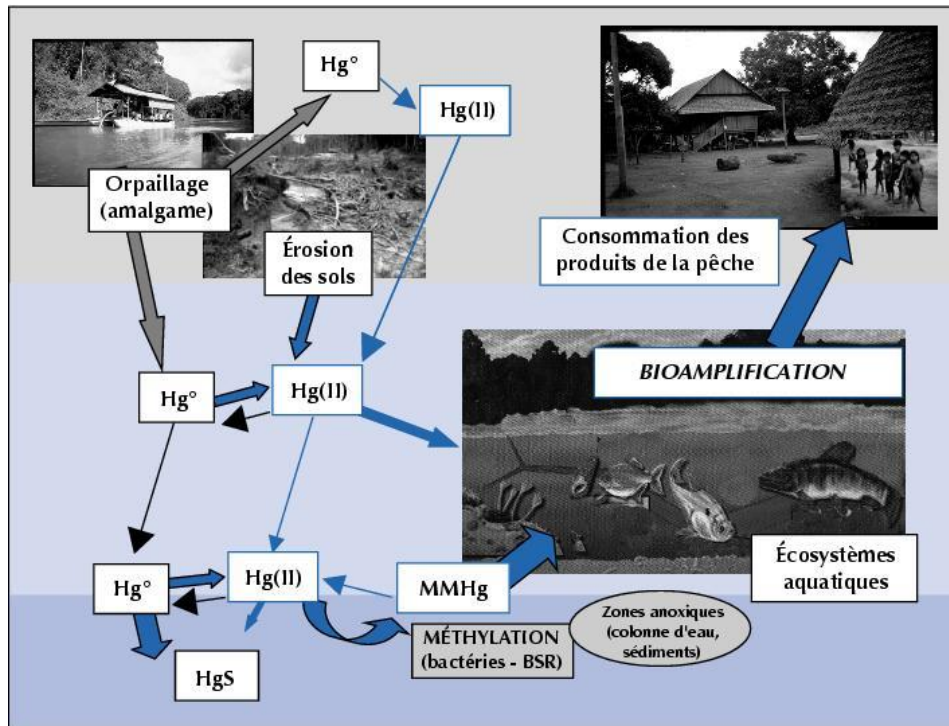

Figure 8 : Principales étapes du cycle biogéochimique du mercure (Hg) en relation avec les activités d'orpaillage en Guyane. Source : Environnement, Risques, & Santé. BSR : bactéries sulfato-réductrices ; Hg° : mercure élémentaire ; Hg(II) : mercure inorganique oxydé ; MMHg : monométhylmercure ; HgS : Sulfure de mercure

5. Les enjeux de la restauration écologique des sites miniers en Guyane française

Avant d'illustrer l'aspect de la restauration écologique des sites miniers il est absolument nécessaire de redéfinir certains termes utilisés couramment en écologie de la restauration afin d'appliquer une terminologie de base à l'ensemble de ce travail.

D'un point de vu général, la **restauration écologique** est un processus qui assiste l'autoréparation d'un écosystème qui a été dégradé, endommagé ou détruit. Les auteurs (Bradshaw, 1997; Edouard Le Floc'H and James Aronson, 1995; SER, 2004) considère que la restauration écologique est un processus intentionnelle mis en œuvre par les opérateurs et gestionnaires visant à revenir à la structure, à la diversité et à la dynamique de l'écosystème initial.

Les aspects législatifs de la restauration écologique des sites miniers sont dépendants des lieux d'exploitations et sont très variables entre les pays. Par exemple au Royaume-Uni la restauration écologique est très contrôlée et impose la restitution d'au moins 20 cm de sol de couverture, ou « fertile » dans le jargon minier. Sur le territoire français, le concept de restauration écologique des sites miniers est imposé sur les territoires d'Outre-Mer seulement depuis avril 1998 (*Journal Officiel du 22 avril 1998* du Code Minier).

Néanmoins, les objectifs de la restauration écologique sont relativement ambigus. Si les compagnies minières doivent avoir une obligation de moyens mis à disposition pour initier la restauration écologique, il n'y a pas une obligation de réussite de la restauration écologique mais une obligation de réhabilitation du site. Pour cette raison, nous distinguerons dans la suite de ce travail le concept de « réhabilitation » et celui de « revégétalisation ou restauration » qui constituent les deux socles de la restauration écologique au sens général.

5.1. La réhabilitation des sites miniers guyanais

Afin de comprendre les enjeux de la réhabilitation, il est nécessaire de rappeler l'impact direct de l'exploitation des surfaces alluvionnaires sur la structure verticale du substrat. Si une partie de l'or est sous forme de pépite, en surface des surfaces alluvionnaires, la majeure partie du minerai aurifère est sous forme particulaire dans les horizons profonds. En effet, le lieu d'altération du matériel parental, où les concentrations en or sont les plus importantes, sont juste au-dessus du niveau saprolithique, zone contemporaine de l'altération chimique des minéraux primaires. Pour atteindre cette zone, les compagnies minières déblayent généralement les 5 premiers mètres des surfaces alluvionnaires et parfois plus. Les horizons superficiels d'alluvions sont alors délités grâce au lance-monitor lors de l'étape du débouage. Les boues de délitage sont ensuite déversées sur les tables de lavage pour y être dissociées en fonction de leur granulométrie et continuer ainsi le processus d'extraction aurifère (partie 3. *Techniques d'orpaillage en Guyane*). Au fil de l'excavation, la topographie du site est entièrement remaniée. D'un côté, la baraque (fond de la surface excavée) qui contenait les minéraux d'intérêts est petit à petit remplie par les eaux de lavages des boues aurifères, créant des zones humides où la turbidité y est très élevée. De l'autre côté, les « stériles », ou minéraux de surface, sont séparés en fonction de leur granulométrie, générant des tas de sables, de limons et d'argiles tout autour de la baraque. Dans le cas où les « stériles » sont entassés, une succession de lits de minéraux se

forment en fonction du gradient granulométrique un lit minéral totalement déstructuré. Le remaniement du site entraîne une destruction complète de la structure du sol, de sa texture ainsi qu'une perte irréversible de la matière organique. En raison de cette perte en matière minérale, du pool de nutriments et des communautés biologiques du sol, la qualité chimique devient limitante et le substrat quasiment fertile.

L'étape de **réhabilitation** du site consiste donc à fermer les baranques avec l'étape du « régalage », à l'aide de bulldozers et de pelles mécaniques pour en évacuer l'eau stagnante. Les matériaux utilisés seront bien entendu les « stériles », extraits lors du délitage des horizons de sol. Si les « stériles » ne sont pas mélangés avant l'étape de régalage, cela donnera lieu à une hétérogénéité de surface majeure qui entrainera une modification des régimes hydriques et des conditions physico-chimiques peu propices à l'instauration d'un nouveau couvert végétal. Cette hétérogénéité peut induire des zones gravillonnaires très grossières (**Figure 9**) ou des zones limono-argileuses limitant l'infiltration de l'eau (**Figure 10**).

Le terme **réhabilitation** qui sera utilisé tout au long de ce travail concernera donc exclusivement des sites miniers dont la surface aura été reconstituée et régalée. Ce terme est avant tout utilisé dans le vocabulaire minier et ne doit pas être confondu avec la définition de la réhabilitation donnée en écologie de la restauration qui est une technique visant à la réparation des processus, de la productivité et des services de l'écosystèmes.



Figure 9 : Exemple de site minier réhabilité avec sable et graviers. Crédit : Ewan Couic



Figure 10 : Exemple de site minier réhabilité avec texture argilo-limoneuse. Crédit : Ewan Couic

5.2. La revégétalisation des sites miniers en Guyane française

Au sens strict, la **revégétalisation** ou **végétalisation** vise à reconstituer un couvert végétal d'un terrain dénudé par l'action de l'homme en utilisant des espèces adaptées aux conditions du site à revégétaliser. Dans les faits, ce concept ne précise par les objectifs à atteindre et les moyens à mettre en œuvre.

Afin de réaliser une revégétalisation optimale des sites d'orpaillages les compagnies minières ont opté pour l'utilisation intégrée d'espèces performantes à croissance rapide. Certaines techniques de revégétalisation préconisent l'apport d'un nouveau sol de couverture (Barnhisel and Hower, 1997) mais au vu du coût et des surfaces à restaurer, ces techniques ont été abandonnées au profit des plantes de couvertures. Depuis une vingtaine d'années, en Amérique du Sud, des expérimentations utilisant des espèces fixatrices d'azote ont montré des résultats très encourageants. Parmi ces espèces, les légumineuses nodulées arborescentes telles qu'*Acacia mangium*, *Clitoria racemosa*, *Clitoria fairchildiana*, *Inga edulis*, *Erythrina Jusca* et *Erythrina amazonica* ont été utilisées en Guyane française pour effectuer les premières phases de revégétalisation des sites miniers. Ces espèces mycorhizées en raison de leur croissance rapide et de leur capacité à fixer l'azote atmosphérique ont un taux de survie élevé, même sur des substrats très limitants. De plus, la productivité primaire de ces espèces frugales assure un renouvellement rapide du stock de matière organique, qui contribuera d'une part, à redonner la fertilité au substrat et d'autre part, à limiter les processus d'érosion (Franco *et al.*, 1994, Moiroud *et al.*, 1991, Lugo 1997). Le choix des espèces dépendra essentiellement de la nature du substrat. Ainsi, *Acacia*

mangium sera préféré sur les substrats sablo-gravillonnaires alors que *Clitoria racemosa* et *Erythrina amazonica* seront plus performants sur les surfaces argilo-sableuses. La reconstitution du stock de matière organique et de la couverture végétale par ces espèces constituera la phase pionnière de la revégétalisation qui dure généralement entre 2 et 4 ans, en fonction des espèces et du substrat à restaurer.

La seconde phase de revégétalisation sera exclusivement réservée à la réintroduction des espèces locales dans le but de reconstruire le plus fidèlement possible l'écosystème d'origine, en augmentant le niveau de biodiversité, tout en stratifiant la couverture arborée. Parmi ces espèces, le genre *Ficus* est très représenté en raison de ses fruits très attractifs pour la faune, les chiroptères notamment. L'utilisation d'espèces frugales variées permettra en outre de favoriser un retour pérenne de la biodiversité animale et des principaux pollinisateurs telles que les chauves-souris. Cette étape de pérennisation de la revégétalisation devra néanmoins être contrôlée et suivie pour en assurer la réussite. En effet, les espèces de fabacées utilisées dans la phase pionnière sont généralement très compétitives et limitent le développement de nouvelles espèces arborescentes. Les travaux de Jaffré sur la revégétalisation des anciens sites miniers en Nouvelle-Calédonie permettent de mettre en avant l'effet des différentes espèces végétales sur la reconstitution des écosystèmes et des paysages (**Figure 11**) et ces mécanismes ont largement été souligné par Loubry (2002) et Chazdon (2008) lors de la revégétalisation des sites miniers guyanais.

Cette phase de **revégétalisation** est normalement censée assurer la **restauration écologique** des sites miniers mais dans les faits, et en fonction du niveau de réussite de cette phase, la restauration n'est pas toujours effective. Dans le cas où la reprise de la végétation permet de stabiliser le terrain tout en apportant une amélioration esthétique il s'agirait d'une **récupération**. Dans le cas où la biodiversité initiale n'a pas été restaurée mais avec le développement d'un couvert arboré il s'agirait davantage d'un **remplacement** (ou substitution) du couvert végétal, qui l'on pourrait caractériser comme étant un **reboisement** (ou reforestation).

Dans ce travail de thèse nous distinguerons donc les étapes de **réhabilitation** et de **revégétalisation** qui constituent à notre sens les deux phases de la restauration écologique des sites miniers guyanais.

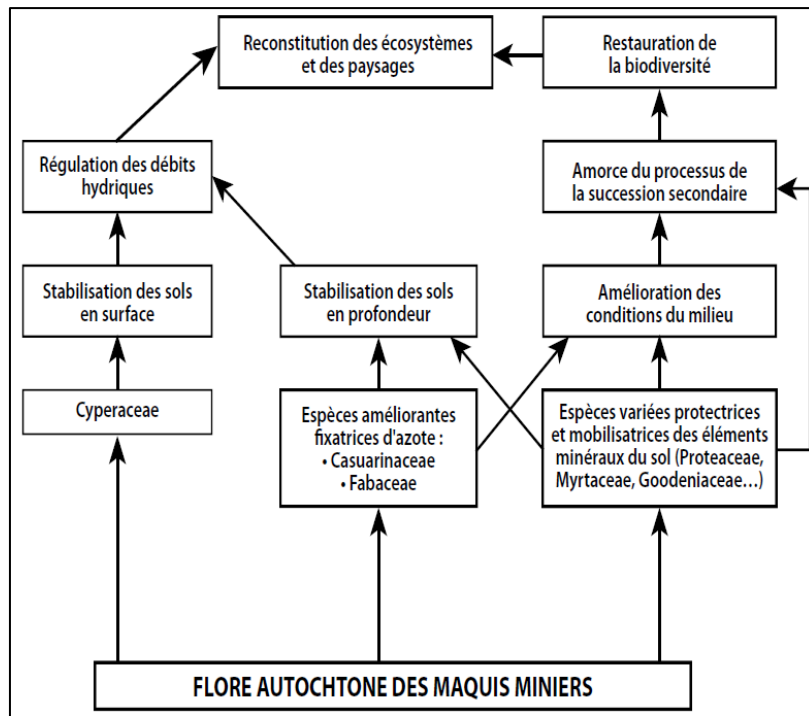

Figure 11 : Etapes de la revégétalisation des anciens sites miniers et incidence dans la reconstitution globale de l'écosystème (Jaffré *et al.*, 1997)

6. Evaluation de la restauration écologique

6.1. Concept de qualité des sols

Dans une perspective de développement durable de la filière aurifère en Guyane il est nécessaire de réaliser la reconstitution d'un écosystème pérenne qui assure l'ensemble des processus biogéochimiques liés à son fonctionnement. L'intégration de la composante du sol dans l'évaluation de la qualité de la restauration écologique est due au fait que la majeure partie des processus écologiques et des cycles biogéochimiques se déroulent dans le sol (Gobat *et al.*, 2003). Le sol est le témoin de l'anthropisation et des perturbations d'un écosystème, et son altération entraîne donc une perte de fonctionnalité globale de l'écosystème. De nombreux auteurs ont développé des définitions de la qualité du sol (Chaussod, 1996; Karlen *et al.*, 1997, Gros, 2002 Cécillon 2008) et il apparaît depuis évident que la qualité d'un sol dépendra d'une interaction entre plusieurs variables. Les variables intrinsèques aux sols tels que les facteurs chimiques, physiques et biologiques, ainsi que les variables extrinsèques telles que les variations climatiques, seront les paramètres les plus importants à prendre en compte dans le diagnostic environnemental. Afin d'évaluer cette qualité il est donc nécessaire de développer des indicateurs de qualité pertinents qui

intègrent au mieux la variabilité des différents facteurs intrinsèques et extrinsèques. Ces indicateurs doivent également être sensibles aux variations naturelles et aux pressions anthropiques et ils doivent traduire des processus biogéochimiques qui assurent le fonctionnement de l'écosystème. S'il semble impossible de trouver un indicateur unique permettant une évaluation complète de la qualité d'un sol, il est donc nécessaire d'aborder ce concept à travers une différenciation des indicateurs ; de la qualité chimique (pool de nutriments du sol, échange ioniques, biodisponibilité des ressources chimiques (Tessier *et al.*, 1996), physique (stabilité structurale du sol, porosité, perméabilité) et biologique (biodiversité, activités des ingénieurs du sol, diversité et activité microbienne).

Dale & Beyeler (Dale and Beyeler, 2001) ont défini une liste de critères pour que ces indicateurs écologiques soient pertinents, ils doivent :

- Être facilement mesurables
- Être sensibles aux pressions anthropiques
- Répondre aux stress de manière prédictive
- Permettre d'anticiper les trajectoires de restauration écologique
- Avoir une faible variabilité dans la réponse

Actuellement, l'étude des activités microbiennes dans les sols permet d'accéder de manière pertinente à différents paramètres de la qualité du sol. Leur prépondérance et leur rôle fondamental pour assurer les différents cycles biogéochimiques en font des indicateurs écologiques de référence. Les micro-organismes du sol remplissent généralement les critères définis par Dale et Bayeler (2001), car leurs activités intègrent les propriétés physiques, chimiques et biologiques des sols, et qu'ils sont sensibles aux variations abiotiques de leur milieu (Doran and Zeiss, 2000). Certains auteurs estiment que les processus biogéochimiques régissant la restauration écologique peuvent être appréciés avec l'utilisation des indicateurs de qualité microbienne et que ces indicateurs doivent être liés aux grands cycles biogéochimiques (Schloter *et al.*, 2003; White *et al.*, 1998). Grâce à leurs réponses très diverses aux pressions environnementales, il sera alors possible de caractériser les communautés microbiennes en fonction ; de leur densité, de leur diversité génétique et catabolique ainsi que de leurs fonctionnalités (Maron *et al.*, 2003).

6.2. Le recouvrement des principaux cycles biogéochimiques

6.2.1. Cycle du carbone

Le carbone est l'un des éléments biogènes primordiaux et son cycle intervient à tous les niveaux de la géosphère (**Figure 12**). En effet, le passage du CO₂ minéral en phase organique via la photosynthèse est la réaction clef de la vie sur terre. Le carbone est également présent dans tous les réservoirs et sous des formes très différentes. Le carbone peut en effet se retrouver sous des formes carbonatées (roches calcaires d'origine biogène), sous forme de dioxyde de carbone libre dans l'atmosphère ou dissous dans l'eau, sous forme organique dans la biomasse vivante ou en décomposition, dans les carburants fossiles etc. L'équilibre du cycle du carbone résulte d'une action simultanée de la photosynthèse (stockage) et de la respiration (relargage) de manière permanente et saisonnière. Ainsi, il a par exemple été démontré qu'en forêt amazonienne, la moitié de la production brute (30,4 t C.ha⁻¹.an⁻¹) correspond à la valeur de respiration (15,6 t C.ha⁻¹.an⁻¹), alors que l'autre moitié correspond à la quantité de carbone fixée dans les tissus, via la photosynthèse (Malhi and Grace, 2000). Le cycle du carbone présente également un enjeu environnemental majeur puisqu'on estime aujourd'hui que 60% du réchauffement climatique global constaté est dû à l'augmentation de concentration du dioxyde de carbone. La concentration moyenne dans l'air est passée de 280 μmol.mol⁻¹ avant la révolution industrielle à 360 μmol.mol⁻¹ actuellement (Grace, 2004). Cette hausse est principalement expliquée par l'utilisation de carburants fossiles, l'augmentation exponentielle des activités industrielles et la déforestation des forêts tropicales.

Les potentialités de minéralisation du carbone organique (via la respiration des microorganismes) d'un sol en condition aérobie constituent un témoin clef du fonctionnement et de la qualité biologique d'un sol (Chaussod, 1996). La mesure de ce processus microbien est un élément de bioindication parmi les plus pertinents pour évaluer les fonctionnalités d'un écosystème perturbé (Nannipieri et al., 2002) et s'inscrit parfaitement dans l'évaluation de procédés de restauration écologique de milieux anthropisés tels que des exploitations minières (Schimann et al., 2012).

Il a également été démontré que le cycle du carbone est fortement impacté par les pressions abiotiques. Par exemple, un sol anciennement contaminé par une source de mercure voit ses communautés microbiennes évoluer d'une stratégie de reproduction « k » à un type de

6.2.2. Cycle de l'azote

L'azote est un élément essentiel à tous les organismes et il est présent dans la constitution des protéines, des acides nucléiques et de nombreux polymères. Le cycle de l'azote est considéré comme l'un des plus complexes des cycles biogéochimiques (Svensson and Söderland, 1976). Il est en effet présent aussi bien dans l'atmosphère, la lithosphère que dans l'hydrosphère et il fait intervenir dans ses processus de régulation un nombre et une diversité très importante de microorganismes (**Figure 13**). Cette diversité est hiérarchisée et seules certaines catégories de microorganismes sont aptes à intervenir à chaque phase du cycle. Ces phases sont également régulées par des contraintes environnementales, déterminant la spéciation et la distribution des composés azotés. Parmi cette distribution il est possible de distinguer plusieurs formes minérales – azote moléculaire (N_2), ammoniac (NH_3), nitrite (NO_2^-), nitrate (NO_3^-), ammonium (NH_4^+), oxyde nitrique (N_2O) et oxyde nitreux (NO) – mais aussi des formes organiques très variées telles que les acides aminés, l'urée, les protéines ou les acides uriques ; chacune de ces formes ayant un rôle particulier dans l'écosystème. Certaines de ces formes intervenant dans la nutrition des végétaux (azote minéral et moléculaire), sont indispensables au fonctionnement des écosystèmes et sont très limitantes car peu disponibles (Chapin *et al.*, 1986). Svensson et Söderlund (1976) ont en effet estimé que l'azote minéral du sol représente environ 5% du pool d'azote total du sol.

La minéralisation de l'azote résulte de la conversion biologique de l'azote organique en azote inorganique, principalement sous forme ammonium (NH_4^+) et nitrates (NO_3^-). L'ammonification est la conversion de l'azote organique en NH_4^+ et la nitrification est la conversion des NH_4^+ en NO_3^- . La quantité d'azote produite par minéralisation est le facteur majeur qui contrôle la disponibilité en azote des plantes et donc la productivité des écosystèmes (Reich *et al.*, 2001, 1997).

Parmi les étapes du cycle de l'azote, ces processus de minéralisation sont utilisés comme des indicateurs de la qualité biologique des sols (Chaussod, 1996). De plus, il a été démontré que le cycle de l'azote compte parmi les cycles biogéochimiques les plus sensibles aux stress environnementaux et aux stress liés aux éléments traces métalliques (Broos *et al.*, 2005; Xian *et al.*, 2015; Xu *et al.*, 2009a). Un impact négatif des métaux lourds et de la qualité du sol sur les processus enzymatiques du cycle de l'azote a été largement rapporté. Par exemple, les composés mercuriels inorganiques sont connus pour avoir un effet fortement

inhibiteur sur *Azotobacter* (fixateur N_{atm}) et sur les bactéries nitrifiantes. Ce constat amène les bactéries du cycle de l'azote à être bons candidats pour une évaluation fine de l'impact du stress métallique et du recouvrement général de la qualité biochimique des sites restaurés.

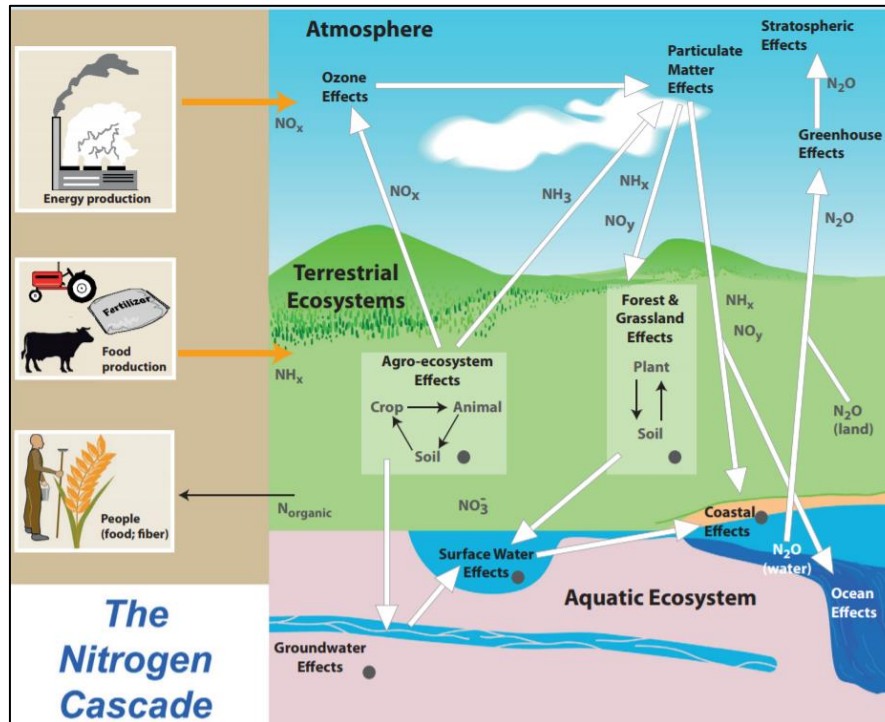

Figure 13 : Schéma simplifié du cycle global de l'azote. Source : IPCC adapté de Galloway et al., 2003

6.2.3. Cycle du phosphore

Le phosphore est l'un des macro-éléments essentiels entrant dans la constitution de toutes cellules vivantes. Il intervient aussi bien dans le métabolisme énergétique que dans l'édification de molécules organiques ou la synthèse du matériel génétique (acides nucléiques). D'une manière générale, le phosphore se trouve dans le sol sous deux formes principales : organique ou minérale. La forme organique du phosphore dans le sol provient exclusivement de la restitution au sol de la matière organique animale, des cellules microbiennes et des résidus végétaux. Parmi ces formes organiques il est possible de trouver des phospholipides, des acides nucléiques ou encore des sucres phosphorylés. Toutes ces formes organiques seront minéralisées par les communautés microbiennes du sol en forme minérale biodisponible pour les végétaux. A noter que les formes organiques du phosphore dans le sol représentent, en fonction du type de sol, entre 15 et 80% du phosphore total (Mortensen et Himes, 1964).

Le phosphore minéral provient exclusivement de roches lignées telles que les apatites ou de dépôts de phosphate sédimentaire comme les phosphorites (Manzoni *et al.*, 2010). Au cours de la pédogenèse, les ions phosphates sont progressivement libérés par dissolution et peuvent être (Mathieu et Pieltain, 2003) :

- Absorbés par les plantes sous des formes assimilables (P_2O_5)
- Adsorbés sur les surfaces colloïdales du sol (complexe argilo-humique)
- Transformés en phosphate d'aluminium, de fer ou de calcium relativement peu soluble et peu biodisponible pour les végétaux.

Le stock de phosphore du sol est exclusivement conditionné par la richesse en argile, en oxyhydroxydes et en matière organique (Fardeau et Conesa, 1994) et cet élément rare (environ 1% de la teneur en corps simple dans la lithosphère) est un facteur limitant primordial, voire le plus important, dans les écosystèmes dont il conditionne la productivité (Chapin *et al.*, 1986; Vitousek and Howarth, 1991) et plus particulièrement dans les forêts tropicales (Chacon *et al.*, 2006).

Il a été démontré par Chaussod (1996) que la quantification du phosphore et des activités enzymatiques associées (phosphatase) sont des indicateurs de la qualité biologique des sols. Elfstrand *et al.*, (2007) ainsi que Melero *et al.*, (2008) ont également démontré que l'activité phosphatase est en corrélation directe avec la disponibilité du phosphore et des nutriments d'une manière plus générale. D'autres études (Khan *et al.*, 2007; Kuperman and Carreiro, 1997) ont également montré que des concentrations élevées en éléments traces métalliques, conduisant à un stress pour les communautés microbiennes, avaient un effet inhibiteur direct sur les activités enzymatiques (dont la phosphatase). La quantification de cet élément et de ses différentes formes (solubles, disponibles, minérales) est depuis utilisée pour caractériser aussi bien la fertilité d'un sol (Jager *et al.*, 2015; Xie *et al.*, 2014) que l'efficacité de procédés de restauration d'écosystèmes dégradés (Gong *et al.*, 2013; Tejada *et al.*, 2011) ou encore l'impact d'une pollution métallique en sites miniers (Hu *et al.*, 2014).

Chapitre II

Influence de la restauration écologique sur la qualité d'un ancien sol minier en Guyane française

Avant-propos

Actuellement les activités d'orpaillages en Guyane française sont remises en question et les projets de grandes envergures comme la « Montagne d'or »² peine à se développer en raison des coûts environnementaux importants. Grâce au développement du Développement durable et de la prise de conscience écologique, la restauration écologique des sites miniers occupe maintenant une place majeure chez les exploitants miniers. Si de nombreuses études concernent les pollutions anthropiques sur les sites miniers, les données concernant l'impact de la restauration écologique sur la qualité des sols sont moins étudiées et très peu d'étude se sont intéressées au devenir des éléments traces métalliques lors du processus de réhabilitation.

Pour ce premier chapitre de recherche nous avons réalisé une campagne d'échantillonnage en décembre 2015 afin de choisir les différents sites miniers restaurés qui pourraient se prêter à cette étude. Lors de cette campagne, nous avons retenu le site de Yaoni pour effectuer les premiers prélèvements de sol. Le site de Yaoni présente l'avantage d'être l'un des premiers sites miniers restaurés en Guyane française. Sur les parcelles de la mine de Yaoni (Exploitée par la Compagnie Minière de Boulanger) depuis plus de 20 ans, différentes associations végétales ont été testées pour la revégétalisation. Ces premiers essais ont été réalisés dès 1997 grâce à une initiative de l'IRD et le projet a été piloté par M. Huttel et M. Loubry. Si certaines combinaisons d'espèces locales n'ont pas été concluantes, l'utilisation de fabacées a montré d'excellents résultats et l'empreinte de l'exploitation ancienne a presque totalement disparu sur les parcelles forestières.

Pour cette première partie nous avons choisi d'étudier l'effet d'un couvert forestier entièrement restaurés avec *Acacia mangium* et *Clitoria racemosa* sur un panel d'indicateurs de la qualité du sol, chimique et microbiologique. Nous avons également réalisé des mesures de spéciation d'éléments traces métalliques dans le but d'aborder la question de la qualité sanitaire des parcelles en s'appuyant sur la mobilité des éléments toxiques.

² Le projet « Montagne d'or » fait référence à un projet de mine à ciel ouvert d'envergure menée les entreprises Colombus Gold / Nordgold dans la région de Saint Laurent du Maroni en Guyane française. La concession minière, qui serait ouverte vers 2022, permettrait d'exploiter près de 150 tonnes d'or grâce à une fosse d'excavation de 2,5 km de long, 400 mètres de large et 120 mètres de profondeur. L'extraction de l'or primaire serait ensuite réalisée par cyanuration (voir chapitre 1 : 3.3 Procédés de cyanuration)

Article I: Mercury behaviour and C, N, and P biogeochemical cycles during ecological restoration processes of old mining sites in French Guiana

Résumé

Depuis des décennies, l'exploitation aurifère dans la forêt tropicale humide entraîne une pollution et une déforestation des milieux. Si la restauration écologique des sites miniers est primordiale pour recouvrir la biodiversité et limiter l'érosion, peu d'études se sont intéressées au comportement des éléments traces métalliques pendant le processus de réhabilitation. Cette étude se concentre sur l'utilisation potentielle des activités microbiennes et de la spéciation du mercure, de l'arsenic, du cuivre, du zinc et du chrome pour évaluer la qualité biochimique des sols restaurés. Nous avons échantillonné 2 sites miniers guyanais réhabilités il y a 17 ans. Le premier site est entièrement régénéré (R) avec l'utilisation des légumineuses *Acacia mangium* et *Clitoria racemosa*, le second site a été régénéré passivement avec de la végétation spontanée (Sv). Nous avons également échantillonné site non anthropisé (F) afin d'avoir un control positif. Nous avons réalisé une expérimentation en mesocosms avec une incubation du sol pendant 30 jours en conditions contrôlées où la spéciation de certains éléments traces et des activités enzymatiques (FDA, déshydrogénase, B-glucosidase, uréase, phosphatase acide et alcaline) ont été mesurées. En termes d'indicateur de la qualité, les mesures de la biomasse microbienne et des activités enzymatiques liées au cycle du carbone et du phosphore semblaient pertinentes pour témoigner de la qualité d'un sol réhabilités et régénérés. Ces résultats montraient que la restauration avec des fabacées a un effet positif sur la qualité biochimique du sol avec des activités microbiennes se rapprochant de celles du site control (F). La restauration écologique avait également un effet positif sur la spéciation avec une limitation de la mobilité. Sur le site Sv nous avons mesuré davantage de mercure soluble et échangeable alors que sur le site R le mercure était principalement adsorbé à la matière organique. Ces résultats suggèrent que les activités enzymatiques et le cycle du mercure sont sensibles à la dégradation du sol et à sa restauration, et que ces paramètres pourraient être considérés pour améliorer le diagnostic de la qualité des sols restaurés.

Mercury behaviour and C, N, and P biogeochemical cycles during ecological restoration processes of old mining sites in French Guiana

Ewan Couic^{*a,b}, Michel Grimaldi^{a,c}, Vanessa Alphonse^b, Clarisse Balland-Bolou-Bi^b, Alexandre Livet^b, Stéphanie Giusti-Miller^a, Max Sarrazin^d and Nouredine Bousserhine^b

^a Institut d'Ecologie et des Sciences de l'Environnement de Paris (IEES), Université-Paris-Est Créteil, 94010, Créteil cedex, France.

^b Laboratoire Eau Environnement et Systèmes Urbains (Leesu), Université-Paris-Est Créteil, 94010, Créteil cedex, France

^c Institut de Recherche pour le Développement (IRD), Centre IRD France Nord, 93143, Bondy cedex, France

^d Laboratoire des Moyens Analytiques de Cayenne (LAMA), Institut de Recherche pour le Développement (IRD), Centre IRD de Cayenne, 97323, Cayenne cedex, France

* Corresponding author :

Ewan Couic

E-mail :

Abstract

Several decades of gold mining extraction activities in the Amazonian rainforest have caused deforestation and pollution. While ecological rehabilitation is essential for restoring biodiversity and decreasing erosion on deforested lands, few studies note the behaviour or toxicity of trace elements during the rehabilitation process. Our original study focused on the potential use of microbial activity and Hg speciation and compared them with As, Cu, Zn and Cr speciation in assessing the chemical and biological quality of ecological restoration efforts. We sampled two sites in French Guyana 17 years after rehabilitation efforts began. The former site was actively regenerated (R) with the leguminous species *Clitoria racemosa* and *Acacia mangium*, and the second site was passively regenerated with spontaneous vegetation (Sv). We also sampled soil from a control site without a history of gold mining (F). We performed microcosm soil experiments for 30 days, where trace element speciation and enzyme activities (i.e., FDA, dehydrogenase, β -glucosidase, urease, alkaline and acid phosphatase) were estimated to characterise the behaviour of trace elements and the soil microbial activity. As bioindicators, the use of soil microbial carbon biomass and soil enzyme activities related to the carbon and phosphorus cycles seem to be relevant for assessing soil quality in rehabilitated and regenerated old mining sites. Our results showed that restoration with leguminous species had a positive effect on soil chemical quality and on soil microbial bioindicators, with activities that tended toward natural non-degraded soil (F). Active restoration processes had also a positive effect on Hg speciation by reducing its mobility. While in Sv we found more exchangeable and soluble mercury, in regenerated sites, Hg was mostly bound to organic matter. These results also suggested that enzyme activities and mercury cycles are sensitive to land restoration and must be considered when evaluating the efficiency of restoration processes.

1. Introduction

Tropical rainforests represent less than 8% of the global land surface; however, they contain more than 50% of all known species and provide a variety of key resources and ecosystem services (ES) to humans, including food, drinking water, timber and medicine (Foley *et al.*, 2007; Lewis *et al.*, 2009). In 2005, the Millennium Ecosystem Assessment showed the impacts of human activities on degradation and non-sustainable use of ecosystem services. Unfortunately, the Amazon rainforest is highly affected by this degradation (Keenan *et al.*, 2015b). Specifically in the Amazon rainforest, habitat loss and degradation by deforestation (e.g., agricultural expansion, logging, fire, mining activities) are currently the most common pressures on biodiversity (Vié *et al.*, 2008). All these pressures affect the structure of ecological communities, which can lead to reduced ecosystem functionality (Cardinale *et al.*, 2006; Tilman *et al.*, 2001), global extinction (Vié *et al.*, 2008) and a loss of ES (Grimaldi *et al.*, 2014). In the Amazon rainforest, the gold mining activities that have occurred for several decades are one of the major environmental threats that have cumulative effects, including deforestation, acid mine drainage, and soil and water pollution from arsenic, cyanide and mercury contamination (Veiga *et al.*, 2006). After these disturbances, the original soil of mine-degraded land is usually lost or damaged with only skeletal materials remaining (Loubry, 2002). In most cases, there is a lack of organic matter and major nutrients such as nitrogen (N) or phosphorus (P) in degraded soil (Wong, 2003). It has been shown that little vegetation is able to grow in those soils, with the exception of some grasses such as *Carex*, and as a result, natural forest succession is stalled (Bradshaw, 1997a; Martínez-Garza and Howe, 2003). In the context of man-made soils that are unsuited for biodiversity development, the establishment of a new vegetation cover is essential for stabilising the bare areas to reduce soil erosion, minimise trace element pollution and restart natural forest succession (Wong, 2003). To achieve ecological restoration, i.e., “the act of restoring to a former state or position...or to an unimpaired or perfect condition”, several remediation and phytoremediation techniques are used around the world (Bradshaw, 1997b). These techniques and the choice of vegetation type are usually based on the pollution intensity (i.e., concentration and depth of soil pollution), climate, and criteria of “soil quality”, which is defined as the capacity of a soil to function (Karlen *et al.*, 1997) and is usually evaluated by taking soil nutrient or soil respiration measurements (Chaussod, 1996). In degraded mining lands, especially in French Guiana, restoration programmes

generally involve planting leguminous species. Leguminous tree can grow quickly in the acidic soils of tropical regions and have nutritional advantages as a result of symbioses with nitrogen-fixing bacteria and arbuscular mycorrhizae (Butterfield, 1996; Norisada *et al.*, 2005). Among the legumes specie, *Acacia mangium* (Hulugalle, 1992) and *Leucaena* (Hutton, 1983) are commonly used and are well known to maintain a high growth rate, increase soil fertility and not inhibit the subsequent establishment of native species (Lamb and Lawrence, 1993). These two species are trees that can exceed 5-6 metres in height in just 3 years of growth. On the rehabilitated plots of land in French Guiana, some acacia trees can reach 15-20 metres in height and form an extremely dense vegetation canopy. One of the major problems in the evaluation (Grimaldi *et al.*, 2014) of ecological restoration concerns the definition of “soil quality”. Indeed, the definition varies by the type of use (e.g., agriculture, natural forest, grazing), and this lack of consensus (Doran *et al.*, 1997; Karlen *et al.*, 1997; Nortcliff, 2002) makes the development of relevant indicators difficult but necessary for evaluating the quality of ecological restoration (Chazdon, 2008). Moreover, to evaluate the “soil natural capital” (Dominati *et al.*, 2010), which refers to the physical, chemical and biological properties that contribute to soil function and ecosystem services (Doran *et al.*, 1994; Knoepp *et al.*, 2000), a useful indicator has to fulfil all these criteria to be relevant (Dale and Beyeler, 2001): (1) easily measurable, (2) sensitivity to variation in soil management and climate, (3) predictive response to stress, (4) low response variability, and (5) accessibility and utility to stakeholders and decision makers.

Currently, soil quality is assessed by physical indicators such as bulk density (Logsdon and Karlen, 2004) or aggregate stability (Angers *et al.*, 1992), chemical indicators such as soil pH (Smith *et al.*, 1996) or soil organic matter content (Karlen *et al.*, 2008) and biological indicators that typically include microbial biomass carbon (Jordan *et al.*, 1995) and microbial enzyme activities (Tabatabai, 1994). Soil microorganisms and enzymes are useful as bioindicators because they are among the first mediators of soil biological processes, such as organic matter degradation, mineralisation and nutrient recycling, and the overall biogeochemical cycle (Nannipieri *et al.*, 2003), and because they play a role in maintaining soil quality and functional diversity (Ölinger *et al.*, 1996; Tabatabai, 1994). Among the biogeochemical cycles, the carbon, nitrogen and phosphorus cycles are the most relevant to assess through the use of bioindicators (Bloem, J., Schouten, T., Sørensen, S., Breure and

A.M., 2003; Chacon *et al.*, 2006; Chaussod, 1996; Gong *et al.*, 2013; Nannipieri *et al.*, 2003; Schloter *et al.*, 2003), particularly during ecological restoration processes. Moreover, these cycles are negatively affected by trace elements such as mercury (Hg), arsenic (As), zinc (Zn), lead (Pb), cadmium (Cd), and copper (Cu) when concentrations exceed toxic thresholds and alter microbial community structure (Broos *et al.*, 2005; Campbell *et al.*, 2003; KHAN *et al.*, 2007; Kuperman and Carreiro, 1997; Xu and Chen, 2006). In fact, the presence of certain trace elements can inhibit the growth of bacteria or extracellular enzymes involved in the mineralisation of carbon and nitrogen (Da Silva *et al.*, 2016). The bacteria and enzymes involved in the nitrogen cycle are described as being very sensitive to the presence of ionic mercury in soil. Guyanese soils, particularly Oxisols (USDA classification), which are characterised by their red colour caused by high concentrations of iron oxides, generally have high levels of trace elements adsorbed to organic matter in deep horizons and iron oxides, which are considered as the major carrier phases of ETM in tropical soils (Bousserrhine *et al.*, 1999; Guedron *et al.*, 2009; Harris-Hellal *et al.*, 2009). When the soil is altered by mining, these toxic elements can be found in surface soils, in soil solutions, and in the water column; additionally, these toxic elements can lead to contamination (Gounou *et al.*, 2010). Processes that occur after the ecological restoration of mined soils are complex and could affect geochemical fractions and speciation of trace elements. By changing the pH, redox potential, availability of complexing compounds, and microorganism activities (Young, 2012), the transfer of trace elements into the food chain may also be impacted. Furthermore, the distribution, mobility, biological availability and toxicity of trace elements depend not only on their concentrations but also on their speciation (Ankley *et al.*, 1996; Rao *et al.*, 2008). Although restoration methods generally contribute to improving the visual aspect of degraded lands and to reducing soil erosion, there is a lack of information about the benefit of restoration methods on soil chemical properties, their impact on mercury and trace element distribution and speciation, and their impact on soil functionality. Studies that have aimed to improve the ability of restoration programmes to enhance biogeochemical cycling and ecosystem services are rare (Chazdon, 2008).

In this context, the main objective of this study was to evaluate the impacts of two different ecological revegetation processes on mined lands in French Guiana on biogeochemical cycles. Specifically, there are two sets of analyses, the biogeochemical cycles

of C, N, and P were assessed in one part, and the Hg, Cr, Zn, Cu, and As cycles were assessed in the other part. To achieve this objective, an experiment was conducted under laboratory controlled conditions; specifically, the experiment used soil samples collected from two old mining sites and one natural control site. The first mine (Sv) site was revegetated with only spontaneous vegetation while the second mine (R) site was revegetated with an association of two fabaceous species, *Acacia mangium* and *Clitoria racemosa*. Finally, a natural site (F) was sampled to compare microbiological data from revegetated sites with that of natural control soil. During the incubation period, soil quality was assessed based on microbial bioindicators related to C, N, and P turnover, which refers to the capacity of soils to decompose organic compounds into inorganic compounds (He *et al.*, 2003), and trace element (i.e., Hg, Cr, Zn, Cu, As) speciation. Special attention was given to mercury, which remains a major problem in Amazonian rainforests—and particularly in French Guiana (Bastos *et al.*, 2006)—by focusing on the estimation of soluble and exchangeable fractions. The interactions between biological activities and biogeochemical cycles of these elements have never been evaluated in terms of understanding the effects of revegetation on old mining sites in Guiana. By comparing the chemical and biological properties of spontaneous revegetation and revegetated mining lands, results from this study will help highlight issues related to the ecological restoration of mining sites. This information could notably show the added value of assisted restoration compared to spontaneous restoration, in a context of massive deforestation in the tropical forest. Additionally, the information can be used to highlight the effects of restoration that uses a biculture of fabaceous species on the physical and chemical properties of the soil, as well as on the main microbial components that ensure the functioning of biogeochemical cycles.

2. Materials and methods

2.1. Site description and soil sampling

The work was undertaken in French Guiana, South America. Annual rainfall ranges from 2 m to 4 m, and the annual average temperature varies slightly around approximately 26°C. The climate belongs to the seasonal equatorial type (Barret, 2004). The sampled soils for this study were rehabilitated after gold mining extraction occurred between 1990 and 1997. After closing the alluvial mine pit, restoration consisted of reconstituting the soil excavated during mine exploitation. All excavated soils were then homogenised and

flattened before restoration began (Loubry, 2002). These soils could be considered as anthroposol, and they have a different structure and texture than natural tropical forest soils.

The experimental site was in eastern French Guiana (N 04°30.930' / W 052°21.275'). The site was exploited by the Compagnie Minière de Boulanger (CMB)[®] and has remained unexploited for 17 years. Two sites were chosen as a function of the restoration methods adopted. The former method of restoration consisted of filling the pit and allowing spontaneous vegetation to recover the site (N 04°30.315' / W 052°26.903'). We named this site Sv to denote spontaneous vegetation. The spontaneous vegetation covers between 5 and 10% of the soil surface and is dominated by herbaceous species, ferns and pioneer tree species. The second method of restoration consisted of filling the pit and introducing *Acacia mangium* and *Clitoria racemosa* (N 04°29.839' / W 052°26.980'). We called this site R to denote the regenerated site.

To assess the recovery of biological activities during the ecological restoration process, we sampled a control site that corresponded to a natural forest Guyanese soil. This site has never been anthropised, and no mining activity has been identified. The site is called Combat Creek, and it is located near the village of Cacao (N 04°35' / W 52°23'). This soil is categorised as Oxisols based on the U.S. soil classification system. We called this site F to denote the forest control soil. At each site, soil samples were collected from depths between 0-10 cm with an auger. Soil samples consisted of a composite of 6 subsamples (each sampled 5 m from each other) for Sv and 9 subsamples for R and F (each sampled 5 m from each other). We chose to collect more subsamples for the R site because the terrain topography and the soil structure were more heterogeneous than at the Sv site. Soil samples were immediately sealed in sterile hermetic polyethylene bags for transportation to the Cayenne IRD laboratory. Samples were then dried at ambient temperature (25°C) until they were air dried (i.e., approximately 3 weeks). These 24 collected samples were then sieved at 2 mm, homogenised, and hermetically sealed at 4°C until use.

To carry out optimal speciation measurements of metallic trace elements in the soils, it is preferable to implement experiments on wet or frozen soils directly after sampling (Reis *et al.*, 2016). This prevents the redistribution of elements from the least mobile fractions to the more mobile/available fractions (Baeyens *et al.*, 2003; Claff *et al.*, 2010; Reis *et al.*, 2016).

This conservation method, although optimal, is difficult to implement in a field campaign. In most studies, to minimise the loss of trace elements, particularly elemental mercury, samples are usually dried at room temperature over a period of 1-2 weeks and then sieved (Arenas-Lago *et al.*, 2014a; Grimaldi *et al.*, 2008; Guedron *et al.*, 2006; Silveira *et al.*, 2006) or freeze dried (Guedron *et al.*, 2009). Drying in a dry environment at a temperature of 25°C, as in our study, is appropriate for the determination of total mercury. This method of conservation is widely reported in the literature (Da Silva *et al.*, 2016; Guédron *et al.*, 2006; Harris-Hellal *et al.*, 2009). In addition to being easy to carry out, this method allows for the homogenisation of the samples (Baeyens *et al.*, 2003; Reis *et al.*, 2015).

2.2. Initial soil sample characterisation

Before using soil samples in microcosms, effective cation exchange capacity (ECEC), pH, total major element (i.e., C, N, P, Fe, Al and Mn) and total trace element (i.e., Hg, As, Cr, Cu and Zn) content, total organic carbon content, granulometry, and microbial biomass carbon (using the substrate induced respiration (SIR) method) were determined to characterise the main physico-chemical and biological properties; this enabled us to assess the main differences between the soils. Analyses to determine enzymatic activities and speciation of trace elements are described in the section dedicated to the experimental set up.

2.2.1. Physical and chemical soil analysis

ECEC determination

ECEC was measured in soils with the same pH using BaCl₂ 0.1 M as an extractant (ISO 11260). After extract filtration (0.45 µm Teflon filters, Minisart SRP 25, Sartorius), the exchangeable cation (i.e., Ca, Mg, Na, K, Fe and Al) concentrations were determined using inductively coupled plasma optical emission spectroscopy (ICP-OES, Spectroblue).

Soil pH measurements

Soil pH-H₂O and pH-KCl were measured in soil suspensions by shaking 1 g of soil in a 1:2.5 soil-to-water and soil-to-KCl (0.1 M) ratio for 1 hour and then by using a pH metre (MetrOhm 744) (ISO 10390).

Soil total metal content

For all metal analysis, the samples were first ground to 63 µm. To obtain total metal (i.e., Fe, Mn, Al, Zn, Cr, Cu, As) concentrations, soil samples were dissolved in cleaned Teflon

digestion tubes (SCP Science) at 80°C in a mixture of concentrated HNO₃-HF (3:1 ml) using a hot block (Digiprep MS, SCP Science). Samples were warmed at 80°C. All samples were then dissolved in 2 ml of concentrated HCl overnight at 80°C and then warmed for 4 hours at 80°C. Then, samples were dissolved in 5% HNO₃ before the analysis by inductively coupled plasma optical emission spectroscopy (ICP-OES, Spectroblue). All chemicals used were of trace element grade purity.

The quantification of Hg in soil samples was performed using an advanced mercury analyser (Altec AMA-254, Simalab, France) without sample pre-treatment or pre-concentration. AMA 254 is an automatic mercury analyser with a detection limit of 0.01 ng. In brief, the sample is heated to 550°C, and all products of decomposition, including mercury, are carried by a stream of oxygen through a catalytic tube where HgT is transformed into elementary mercury (Hg⁰), which then readily adsorbs to a gold-trap. The fixed mercury is then released by heating the gold-trap at 450°C, and the mercury is quantified by atomic adsorption spectrometry at 253.7 nm.

Soil carbon, nitrogen, and phosphorous measurement

Soil total carbon (C_{tot}) and total nitrogen (N_{tot}) were determined by the Dumas method (NF ISO 13878). Briefly, the Dumas method consists of flash combustion of the soil sample (at 1000°C) using helium and oxygen. After purification of the combustion gases, determination of total carbon and nitrogen contents was performed by chromatography with a thermal conductivity detector (NA 1500 série 2 CARLO-ERBA).

Total phosphorus (P_{tot}) was determined after the acid digestion of soil samples, as previously described. The HPO₄ formed during acid digestion was measured after adding ammonium molybdate and acid ascorbic (Murphy and Riley, 1962). The colour produced by phosphomolybdenum (PMB) was measured by colorimetry at 885 nm (Genesys 10 µv Scanning, Thermo)

Water extractions were performed for total organic carbon (TOC), and concentrations were measured with a Shimadzu TOC-500 apparatus (Shimadzu, Kyoto, Japan). Briefly, 1 g of soil was shaken for 24 h in a polypropylene centrifuge tube with 10 ml of ultrapure water. The suspensions were centrifuged at 2000 rpm for 10 minutes, and supernatants were filtered at 0.2 µm (PTFE, VWR®) and directly analysed on the TOC analyser.

Soil granulometry determination

Granulometry was determined on the fraction less than 2 mm, and five classes of particles have been distinguished according to the NF X 31-107 standard: clay (< 2 µm), fine silts (2 to 20 µm), coarse silt (20 to 50 µm), fine sands (0.050 to 0.200 mm) and coarse sands (0.200 to 2 mm). Sampling and sieving were carried out after the destruction of organic matter by hydrogen peroxide (H₂O₂) on a test sample of approximately 10 g. The final dispersion was carried out by a short ultrasonic passage after the addition of dispersant [(NaPO₃)₆ + Na₂CO₃], and afterwards, the coarse sands (> 0.200 mm) were separated by sieving. To illustrate this, the results have been grouped into 3 parts: clay, total silt, and total sand.

2.2.2. Soil microbial biomass

The application of the substrate-induced respiration technique (SIR) was applied to determine the total microbial biomass (Anderson, 1982). This requires recording the hourly CO₂ production rates from the soil samples, which had been initially spiked with glucose. From the pre-incubated soils, samples with a weight of 2 g were taken and placed into flasks (15 ml), where a solution of glucose (0.1 ml/g soil; the final glucose concentration was 10 mg/g) was added and flasks were sealed with a butyl/PTFE shield cap (VWR®). The CO₂ concentrations were analysed using micro gas chromatography (micro-GC 490, Agilent). The CO₂ evolution rate (µLCO₂-C g⁻¹ soil h⁻¹) at each sampling time was then calculated after subtracting the background CO₂ concentration. Our experiment was conducted at 22°C, which was the temperature prescribed in the original SIR method (Anderson and Domsch, 1978). The basal respiration rate was calculated as the hourly mean of the respiration rates over a 4 h period prior to the addition of glucose. The SIR rate was defined as the minimum respiration rate measured during the 24 h after the addition of glucose, in accordance with Anderson and Domsch (1978) (Anderson and Domsch, 1978). Using the SIR method, soil microbial biomass C (SIR-biomass) was calculated using the following equation from Anderson and Domsch (1978) (Anderson and Domsch, 1978):

$$\text{SIR-biomass C } (\mu\text{gC g}^{-1} \text{ soil}) = \text{SIR } (\mu\text{L CO}_2 \text{ g}^{-1} \text{ soil h}^{-1}) \times 40.04 + 0.37 \quad (\text{Eq. 1})$$

2.3. Experimental set up to measure biological and chemical indicators of soil quality

Fifty-millilitre sterile hermetic glass plasma bottles were filled with 4 g of each soil sample. Soil samples were then brought to 70% of their holding capacity with sterile ultra-pure water, and soil humidity was kept constant with sterile ultra-pure water. The obtained microcosms were mixed with sterile spatulas, sealed with butyl/PTFE shield caps (VWR[®]) and incubated at 28°C for 30 days. Experiments were performed in 6 replicates. To avoid anaerobiosis conditions, the microcosms were regularly aerated under a laminar flow in sterile conditions (PSM Optima 12; ADS Laminaire). Three replicates were stopped after either 10 days or 30 days. Soil samples were harvested and analysed with the following parameters: 6 enzyme assays; C, N, and P contents; and trace element speciation.

2.3.1 Enzyme assays during incubation

The activity of acid (AcdP; EC 3.1.3.2) and alkaline (AlkP; EC 3.1.3.1) phosphatases (Ölinger *et al.*, 1996) and B-glucosidase (Glu; EC 3.2.1.21)(Eivazi and Tabatabai, 1990) were assayed based on the amount of p-nitrophenol (pNP) released after cleavage of enzyme-specific substrates at the average pH of natural soil. The specific substrates were p-nitrophenol phosphates for AcdP and AlkP and 4-nitrophenyl-B-D-glucopyranoside for Glu. These enzymes were measured as described by Badiane *et al.* (2001) (Badiane *et al.*, 2001) and Mora *et al.* (2005) (Mora *et al.*, 2005). One hundred µl of soil solution (1:5 w/v) was mixed with 50 µl of desired substrate (10 M) and 50 µl of *Mac ILVAIN* buffered solution (pH of 4 for AcdP, pH of 9 for AlkP and soil pH with citrate phosphate buffer for Glu). Matching soils were used as controls with 50 µl of buffer but no enzyme substrate. The soil was incubated for 2 h at 37°C on an orbital shaker and then centrifuged at 1500 rpm for 10 min. Then, 75 µl of supernatant was mixed with 175 µl of 0.2% Na₂CO₃ to stop the reaction. The colour intensity of the solution was immediately determined by colorimetry at 405 nm.

Dehydrogenase activity (DHA) was determined according to Klein *et al.* (1971)(Klein *et al.*, 1971) using 0.5 g of soil sample and 2,3,5-triphenyltetrazolium chloride (TTC) as substrate. The colour intensity of the solution after 96 h of incubation at 28°C was determined by colorimetry at 405 nm (Genesys 10 µv Scanning, Thermo).

Urease activity (Ur) was determined according to Kandeler and Gerber (1988)(Kandeler and Gerber, 1988) using 0.5 g of soil sample and urea as substrate in a borate buffer. After indophenol reaction, colour intensity of the solution after 4 h of

incubation at 37°C was determined colorimetrically at 660 nm (Genesys 10 μ v Scanning, Thermo).

Total microbial activity potential was measured through fluorescein diacetate (FDA) hydrolysis assay, which hydrolyse colourless FDA to release the coloured end product fluorescein (Taylor *et al.*, 2002). Soil samples were pre-incubated for 1 day at 25°C. Then, 100 μ l of soil solution (1:5 w/v) was mixed with 50 μ l of *Mac ILVAIN* buffered solution (pH of 7) and 50 μ l of 2 M FDA substrate solution; in contrast, controls received only the buffer. The soil was incubated for 2 h at 37°C on an orbital shaker and then centrifuged at 1500 rpm for 10 min. Then, 100 μ l of supernatant was mixed with 100 μ l of chilled (4°C) *Mac ILVAIN* buffered solution (pH of 7) to stop the reaction. The colour intensity of the solution was immediately determined colorimetrically at 490 nm.

2.3.2 C, N and P turnover and speciation in soil samples during incubation

Mineralised total carbon (C_{min}) was evaluated by measuring soil CO₂ respiration during the experimental set up. Every three days, the release of CO₂ was measured by micro gas chromatography (Agilent, Micro GC 490, PPQ column). The value of C_{min} was expressed as μ g-C CO₂. g⁻¹ of soil d⁻¹.

Mineralised nitrogen (N_{min}) was determined by measuring the production of mineral N (NH₄⁺ and NO₃⁻) during incubation. The NH₄⁺ and NO₃⁻ contents were measured at day 0 and day 30 by indophenol and dimethyl-2,6-phenol methods, respectively. For the measurement of NH₄⁺ and NO₃⁻, 1 g of soil sample (dry weight equivalent) was shaken with 7.5 ml of CaCl₂ (0.025 M) for 2 h. Filtration with a PES filter was performed after centrifugation for 10 min at 3000 rpm. The NH₄⁺ was measured with a spectrophotometer at 690 nm (Genesys 10 μ v Scanning, Thermo) after adding sodium hypochlorite and 4 drops of thymol/sodium nitroprussiate solution (ISO 7150-1). The NO₃⁻ was measured with a spectrophotometer at 493 nm (Genesys 10 μ v Scanning, Thermo) after adding sulfuric and phosphoric acid and 0.5 ml of dimethyl-2,6-phenol (DIN 38405-9). The net ammonification and nitrification rates were calculated as the difference in N-NH₄⁺ and N-NO₃⁻ contents before and after incubation (i.e., day 0 and day 30). The mineralisation rate of total organic N was estimated by summing the ammonification and nitrification rates. The N_{min} value was expressed as μ g-N. g⁻¹ of soil d⁻¹.

Mineralised phosphorus (P_{\min}) was determined by measuring the production of mineral phosphorus during incubation. Mineralised inorganic phosphorus in 1 g of soil was measured after the same CaCl_2 extraction as used for nitrogen mineralisation. Then, HPO_4 was measured after adding ammonium molybdate and ascorbic acid (Murphy and Riley, 1962). The colour produced by phosphomolybdenum (PMB) was measured with a spectrophotometer at 885 nm. The P_{\min} value was expressed as $\mu\text{g-P} \cdot \text{g}^{-1}$ of soil d^{-1} .

2.3.3 Speciation of trace elements during incubation

2.3.3.1 Soluble and exchangeable mercury analysis

Soluble mercury was estimated according to Rasmussen *et al* (2000) (Rasmussen *et al.*, 2000). Briefly, 1 g of each soil replicate was suspended in 10 ml of ultrapure water and agitated at 300 rpm for 30 min. The suspensions were then centrifuged at 4000 rpm, and the supernatants were filtered at 0.45 μm with Teflon filters (Minisart SRP 25, Sartorius). Then, 200 μl of extracted supernatants were analysed for mercury content with AMA 254. All liquid samples were previously filtered (0.45 μm Teflon filters, Minisart SRP 25, Sartorius) and acidified to a pH of 1 (HCl, 37% Suprapur). AMA 254 is an automatic mercury analyser (Courtage Analyses, France) with a detection limit of 0.01 ng. In brief, the sample is heated to 550°C, and all products of decomposition, including mercury, are carried by a stream of oxygen through a catalytic tube where HgT is transformed into elementary mercury (Hg^0), which then readily adsorbs to a gold-trap. The fixed mercury is then released by heating the gold-trap at 450°C, and the mercury is quantified by atomic adsorption spectrometry.

The exchangeable Hg fractions in soil samples were measured after a 1: 15 (w/v) soil/0.1 M CaCl_2 ratio suspension after 2 h of rotary agitation at room temperature according to Silveira *et al* (2006) (Silveira *et al.*, 2006). Then, solutions were centrifuged at 2000 rpm for 10 minutes to separate the supernatant and the residue. Then, 200 μl of extracted supernatants were analysed for mercury content with AMA 254. All liquid samples were previously filtered (0.45 μm Teflon filters, Minisart SRP 25, Sartorius) and acidified to a pH of 1 (HCl, 37% Suprapur). Exchangeable mercury concentrations in the soluble phase were determined directly using an automatic mercury analyser (AMA 254) previously described.

2.3.3.2 Soil sequential extraction and metal distribution

A seven-step sequential extraction procedure was used only at the beginning and at the end (i.e., day 30) of the experiments to define the partition of As, Ni, Cr, Zn, Cu, and Hg

in soil components. The procedure is summarised in Table 1 and is based on the work of Silveira *et al.* (2006)(Silveira *et al.*, 2006). The sequential extraction procedure was performed using 0.5 g of soil sample in a 30-ml polypropylene centrifuge tube. After the reaction with the appropriate reagent at each step, the mixture was centrifuged to separate the supernatant and the residue. The residue was washed with 5 ml of NaCl 0.1 M and added to the supernatant. Solutions were filtered at 0.2 μm (PTFE, VWR[®]), acidified with HNO₃ 5%, and used for analytical determinations; in contrast, the residue was dried at room temperature prior to the next extraction step. Then, for analyses of As, Ni, Cr, Zn and Cu, all solutions were analysed using inductively coupled plasma emission spectroscopy (ICP-OES, Spectroblue) with a detection limit of 0.005 ppm for each element. For the analyses of mercury concentrations in soluble phases, the solutions analysed using automatic mercury analyser (AMA 254) previously described.

Table 1:

Sequential extraction procedure for metals fractionation analyses (modified from Silveira *et al.*, 2006).

Soil fraction (abbreviation)	Extractor	Soil:solution (g:ml)	Extractions conditions
1- Soluble and exchangeable (Ex)	0.1M CaCl ₂	1:15	Stirring for 2h, room temperature
2- Carbonates (ADS)	1M NaOAc (pH 5)	1:30	Stirring for 5h, room temperature
3- Bound to Organic matter (OM)	NaOCl (pH 8.5)	1:10	Water-bath for 30 min, 90-95°C
4- Bound to Mn oxides (Mn-Oxides)	0.05M NH ₂ OH/HCl (pH 2)	1:30	Stirring for 30 min, room temperature
5- Bound to amorphous Fe oxides (A-Fe Ox)	0.2 M oxalate buffer (pH 3)	1:30	Stirring for 2h, in the dark
6- Bound to crystalline Fe oxides (C-Fe Ox)	6M HCl	1:40	Stirring for 24h, room temperature
7- Residual (RES)	-	-	Direct by ICP-OES and AMA 254

2.4 Statistical analysis

The normality of the data distributions and the equal variance between treatments were tested using the Shapiro test and Bartlett's test, respectively. Because of the non-normality of the data, the differences in all physico-chemical characterisation data between sites (i.e., Sv and R) were assessed by the Mann-Whitney non-parametric test ($p < 0.05$). For the analysis of different kinetics (i.e., enzymatic activities, evolution of soluble and exchangeable mercury content, evolution of trace elements in different soil fractions), the

differences between sites were assessed by the Kruskal-Wallis non-parametric test ($p < 0.05$). The R software was used for all statistical analyses (R version 3.3.2 (2016-10-31)).

2.5 Quality assurance and control (QA/QC)

To avoid contamination, all materials used in this work were acid-washed twice with HNO_3 (5%) and then rinsed several times with Milli-Q water before use.

Concerning mercury assays in samples, the relative error was routinely $\pm 5\%$ and was always under $\pm 10\%$. The detection limit (defined as three times the standard deviation (SD) of the blank) was $0.005 \mu\text{g g}^{-1}$. Concentrations obtained for repeated analyses of certified reference materials never exceeded the published range of concentrations (i.e., $0.128 \pm 0.017 \mu\text{g g}^{-1}$ and $0.091 \pm 0.009 \mu\text{g g}^{-1}$ for BCR-277R and MESS-3, respectively).

Total elements and trace elements were determined by inductively coupled plasma optical emission spectrometry (ICP-OES, Spectroblue). Calibration was conducted using standard solutions for spectroscopy (EnviroMAT Ground Water, High ES-H-2). The analytical errors were estimated by carrying out 3 measurements for each sample and were $< 10\%$.

3. Results

3.1 Soil initial physical and chemical properties of the 2 sites (Sv, R) and the control rain forest site (F)

The initial soil characteristics of the studied sites are summarised in Table 2 for the Sv and R sites, and in Table 5 for the F site. In terms of experimental variability, granulometry was the same for the Sv and R sites, with approximately 10% silt, 78% sand and 11% clay. This granulometry was different from the control, which usually had approximately 70% clay (Da Silva *et al.*, 2016; Harris-Hellal *et al.*, 2011). Soil pH- H_2O and pH-KCL measurements indicated that the R site was more acidic than the Sv site. These values were consistent with those for natural Oxisols or hydromorphic soil (Da Silva *et al.*, 2016; Harris-Hellal *et al.*, 2011).

The total carbon, nitrogen and phosphorus contents were always significantly the highest in the R site. The total carbon content was 24.72 g.kg^{-1} for the R site and 4.65 g.kg^{-1} for the Sv site. The total nitrogen content was 2.05 g.kg^{-1} for the R site and 0.4 g.kg^{-1} for the Sv site. The total phosphorus content was 0.43 g.kg^{-1} for the R site and 0.17 g.kg^{-1} for the Sv site. The natural control soil in our study has about twice as much carbon and total nitrogen (Table 5). The carbon value of the R site was consistent with the natural carbon content in

French Guiana natural soils (Guedron *et al.*, 2009; Guédron *et al.*, 2006; Harris-Hellal *et al.*, 2011); however, the carbon value was half as much as that in the F control site. The total Fe, Mn and Al contents showed no differences between the two sites. The values for Fe and Mn were consistent with natural content in Oxisols (Da Silva *et al.*, 2016; Harris-Hellal *et al.*, 2011, 2009), but the Al concentrations at the former mine sites (Sv) were high.

The values of soil effective cation exchange capacity were 5.83 $\text{cmol}_{(+)}. \text{kg}^{-1}$ for Sv and 6.71 $\text{cmol}_{(+)}. \text{kg}^{-1}$ for R. The two rehabilitated sites had relatively low values compared to that of the control soil (22.3 $\text{cmol}_{(+)}. \text{kg}^{-1}$). However, ECEC values in the literature are quite variable for tropical soils and are highly dependent on clay content (Harris-Hellal *et al.*, 2009). The total soil exchangeable cations were 0.46 $\text{cmol}_{(+)}. \text{kg}^{-1}$ for the Sv site and 0.95 $\text{cmol}_{(+)}. \text{kg}^{-1}$ for the R site. Despite the high content of Al and the low pH at both sites, the concentrations of exchangeable Al were very low (i.e., undetected in Sv and 0.73 $\text{cmol}_{(+)}. \text{kg}^{-1}$ in R site).

The total concentrations of mercury were 0.11 and 0.21 $\text{mg}. \text{kg}^{-1}$ for the Sv and R sites, respectively, with a significant difference between the two sites. The concentration of mercury in F soil (0.45 $\text{mg}. \text{kg}^{-1}$) was significantly higher than that of the rehabilitated soils; however, it remained within the normal range of mercury measurements in French Guiana (Guedron *et al.*, 2009). However, these concentrations were still low compared to the gold mined soil in French Guiana (Guedron *et al.*, 2009).

The total concentrations of As, Cu, Zn and Cr are displayed in Table 3. There was no significant difference in the total content of each trace element. After rehabilitation processes, trace element contents were in the same range of values commonly found in native soils in tropical rainforest (Alloway, 2012), with the exception of total arsenic content, which was above the natural average.

The soil microbial biomass carbon (MBC) in the R site was 2.56 times higher than the MBC in the Sv site; values were 951.5 and 371.9 mg kg^{-1} , respectively ($P < 0.001$) (Table 2). The soil MBC in the F site was significantly higher than at both sites, with a value of 2164.7 mg kg^{-1} .

Table 2:

Mean physical and chemical characteristics of non-revegetated (Sv) and revegetated areas (R) used for experiments (n=6 to 9, mean \pm SD). C_{tot}: Total carbon, ECEC : Effective cation exchange capacity. For each parameter, values followed by different letters differ significantly with P < 0.05 with Mann-Whitney-Wilcoxon test.

Areas	C _{tot} g kg ⁻¹	pH		Exchangeable cations					ECEC cmol _c kg ⁻¹	Total			Clay %	Silt %	Sand %
		pH-H ₂ O	pH-KCL	Na ⁺ cmol _c kg ⁻¹	K ⁺ cmol _c kg ⁻¹	Mg ²⁺ cmol _c kg ⁻¹	Ca ²⁺ cmol _c kg ⁻¹	Al ³⁺ cmol _c kg ⁻¹		Fe g kg ⁻¹	Mn g kg ⁻¹	Al g kg ⁻¹			
Areas of Spontaneous Vegetation (Sv)															
Sv _{tot}	4.65a \pm 0.08	5.1a \pm 0.33	4.5a \pm 0.11	0.15a \pm 0.03	0.14a \pm 0.02	0.06a \pm 0.02	0.11a \pm 0.04	nd	5.83a \pm 1.73	60.6a \pm 22.1	0.38a \pm 0.16	87.9a \pm 33.8	12.7ab \pm 0.8	6.6a \pm 0.2	79.6c \pm 3.2
Areas Revegetated with <i>A.mangium</i> and <i>C.racermosa</i> (R)															
R _{tot}	24.72b \pm 4.75	4.5a \pm 0.49	3.9b \pm 0.35	0.13 \pm a 0.02	0.28a \pm 0.13	0.16b \pm 0.08	0.38a \pm 0.25	0.73a \pm 0.26	6.71a \pm 1.64	61.9a \pm 27.5	0.30a \pm 0.25	70.5a \pm 22.1	9.8ab \pm 3.8	14.2b \pm 6.9	76.2c \pm 9.9

Table 3:

Mean of total concentrations of heavy metals in each treatment (n=6 to 9, mean \pm SD). In each column, values followed by different lower-case letters differ significantly (P < 0.05) with Mann-Whitney-Wilcoxon test. In each row, values followed by different capital letters differ significantly (P < 0.05) with Conover-Iman test of multiple comparisons after Kruskal-Wallis non-parametric test.

Areas / Metal	Hg	As	Cu	Zn	Cr
Areas of Spontaneous Vegetation (Sv)					
Sv	0.11aA \pm 0.05	67.4aB \pm 38.7	43.6aB \pm 1.4	32.4aB \pm 6.01	183.7aC \pm 53.1
Areas Revegetated with <i>A.mangium</i> and <i>C.racermosa</i> (R)					
R	0.21bA \pm 0.05	41.3aB \pm 19.8	25.9aB \pm 11.8	42.3aB \pm 13.1	279.3aC \pm 168.1

Table 4:

C_{tot}, N_{tot}, P_{tot} : Total Organic C, N and P ; C_{bio} : Microbial biomass carbon ; C_{min(SIR)} : organic C-glucose mineralization rate during SIR experiments ; C_{min}, NH₄⁺-N_{min}, NO₃⁻-N_{min}, P_{min} : organic C mineralization rate, mineralized NH₄⁺-N , mineralized NO₃⁻-N, total N mineralization rate, organic P mineralization rate (n=6 to 9, mean \pm SD). For each parameter, values followed by different letters differ significantly with P < 0.05 with Mann-Whitney-Wilcoxon test.

Areas	C			N				P		
	TOC g kg ⁻¹	C _{bio} mg kg ⁻¹	C _{min(SIR)} mg kg ⁻¹ h ⁻¹	C _{min} mg kg ⁻¹ d ⁻¹	N _{tot} g kg ⁻¹	NH ₄ ⁺ -N _{min} mg kg ⁻¹ d ⁻¹	NO ₃ ⁻ -N _{min} mg kg ⁻¹ d ⁻¹	Total-N _{min} mg kg ⁻¹ d ⁻¹	P _{tot} g kg ⁻¹	P _{min} μg kg ⁻¹ d ⁻¹
Areas of Spontaneous Vegetation (Sv)										
Sv	2.88a \pm 0.13	371.9a \pm 13.1	1.07a \pm 0.04	3.63a \pm 0.17	0.40a \pm 0.06	0.026a \pm 0.01	0.14a \pm 0.01	0.164a \pm 0.01	1.72a \pm 0.23	Nd
Areas Revegetated with <i>A.mangium</i> and <i>C.racermosa</i> (R)										
R	15.18b \pm 6.9	951.5b \pm 130	27.61b \pm 5.5	41.2b \pm 2.1	2.05b \pm 0.42	0.96b \pm 0.07	0.12a \pm 0.001	1.05b \pm 0.06	4.33b \pm 2.97	6.00a \pm 1.2

Table 5:

Main physical, chemical and biological properties of natural control soil properties of natural control soil

Main physical and chemical properties of natural control soil												
C tot	N tot	pH		ECEC	Total			Soluble Hg	Clay	Silt	Sand	
g.kg ⁻¹	g.kg ⁻¹	pH-H ₂ O	pH-KCL	cmol.kg ⁻¹	Fe	Al	Hg	% of total Hg	%	%	%	
					g.kg ⁻¹	mg.kg ⁻¹	μg.kg ⁻¹					
54	3,9	4	3,7	22,3	104,5	132	0,45	0,14	78,2	7,6	14,2	
±0,9	±0,5	±0,04	±0,08	±3,5	±5,5	±14	±0,02	±0,015	±0,9	±0,8	±1,3	

Main biological properties of natural control soil							
MBC	Carbon	Nitrogen			DH	Ur	FDA
	C _{min}	NH ₄ ⁺ -N _{min}	NO ₃ ⁻ -N _{min}	Total-N _{min}			
mg kg ⁻¹	mg kg ⁻¹ d ⁻¹	mg kg ⁻¹ d ⁻¹	mg kg ⁻¹ d ⁻¹	mg kg ⁻¹ d ⁻¹	μg TPF g ⁻¹ h ⁻¹	μg NH ₄ ⁺ -N g ⁻¹ h ⁻¹	μg FDA g ⁻¹ h ⁻¹
2164,7	117,6	1,26	0,3	1,56	1.38	12, 2	18,6
±215	±0,88	±0,12	±0,08	±0,35	±0,02	±1,09	±2,8

3.2 Changes in soil chemical and biological properties during microcosm experiments

3.2.1 Change in C, N and P contents and rates of mineralisation

The mineralisation rates of soil organic C, N and P markedly varied between the Sv and R sites (Table 4), with 3.63 and 41.2 mg CO₂-C kg⁻¹ d⁻¹ for C_{min}, respectively, 0.026 and 0.96 mg NH₄⁺-N kg⁻¹ d⁻¹, respectively, 0.14 and 0.12 mg NO₃⁻-N kg⁻¹ d⁻¹, respectively, and “nd” to 6 μg P kg⁻¹ d⁻¹, respectively. The average mineralisation rates of organic C, N, and P consumed for Sv and R were 0.08 and 0.17% of C_{tot}, respectively, 0.041 and 0.05% of N_{tot}, respectively, and “nd” and 0.0001% of P_{tot} per day, respectively. The mineralisation rates of soil organic C, N, and P were significantly higher in the R site than in the Sv site ($P < 0.001$), except for nitrification (i.e., the transformation of N_{tot} into NO₃⁻), where no difference between the two sites was observed. The rates of carbon and nitrogen mineralisation for the F site (Table 5) were 117.6 mg CO₂-C kg⁻¹ d⁻¹ for C_{min} and 1.56 mg N kg⁻¹ d⁻¹ for N_{min}, respectively. Although the mineralisation of carbon and nitrogen in natural soil was significantly higher than in the R site, the values were in the same order of magnitude.

3.2.2. Evolution of trace element (Hg, As, Cu, Cr, Ni) distribution

As previously indicated, a sequential chemical extraction was carried out to identify the distributions of trace elements in different soil fractions. Figure 1 displays the distributions of Hg, As, Cu, Zn and Cr in soil fractions at the beginning and at the end of the experiments.

The proportions of total Hg associated with organic matter (Figure 1) were 43.6% for Sv and 58% for R, with a significant difference between soils but no difference over time. The amount of mercury associated with the iron oxides was higher in Sv (23%) than in R (9%). The average total Hg during the experiment (Figure 2) was the highest in the R site, but the average soluble Hg content (Figure 3) was significantly the highest in the Sv site. The total Hg content and soluble Hg content did not change during the experiment. The exchangeable Hg content (Figure 4) in the Sv site represented 8.9% of the total Hg at day 0 and decreased significantly over time to reach 0.5% by day 30. The average exchangeable Hg (Figure 4) was significantly the highest in the Sv site during the experiment. The exchangeable Hg content for the R site was 1% at day 0 and decreased significantly over time to reach 0.05% by day 30.

Arsenic was mostly bound to the residual fraction, with a minimum of 71% of the total As. The second carrier phase for the two sites was the crystalline Fe oxides fraction. The exchangeable, OM and Mn oxides fractions bound in R were less than 0.88, 1.19 and 0.31% of the total content, respectively.

As with As, Cu was strongly bound to the residual fraction and then to the crystalline iron oxides fraction at the two sites. There was an important decrease in exchangeable Cu at the two sites during the experiment. The amounts associated with organic matter and Mn oxides represented less than 3.72 and 0.28%, respectively, at the two sites, with minor changes between soils and a significant decrease by the end of the experiment.

Zinc was mostly bound to the crystalline iron oxides fraction and then to the residual fractions at the beginning of the experiment at the two sites. By the end of the experiment, the results were reversed, and the most important carrier phase was the residual fraction and then the crystalline iron oxides fraction. The exchangeable, OM and Mn oxides fractions

represented less than 2.86%, 3.38% and 0.07%, respectively, with minor changes between the Sv and R sites.

Similar to As and Cu, most of the Cr was bound to the residual fraction of soils and then to the crystalline iron oxides fraction. The exchangeable fractions only increased in the Sv site—from 0.001% to 0.19% of the total Cr. There was no difference in Cr associated with the organic matter, the Mn oxides, or the amorphous iron oxides between the two sites or after the experiment.

To summarise, the residual fraction of the studied soil samples generally contained the highest proportion of trace elements, except for Hg, which was more bound to the organic fraction. The second carrier phase was the crystalline iron oxides fraction for Hg, As, Cu, Zn and Cr. The fraction linked to organic matter displayed a major difference between trace element concentrations.

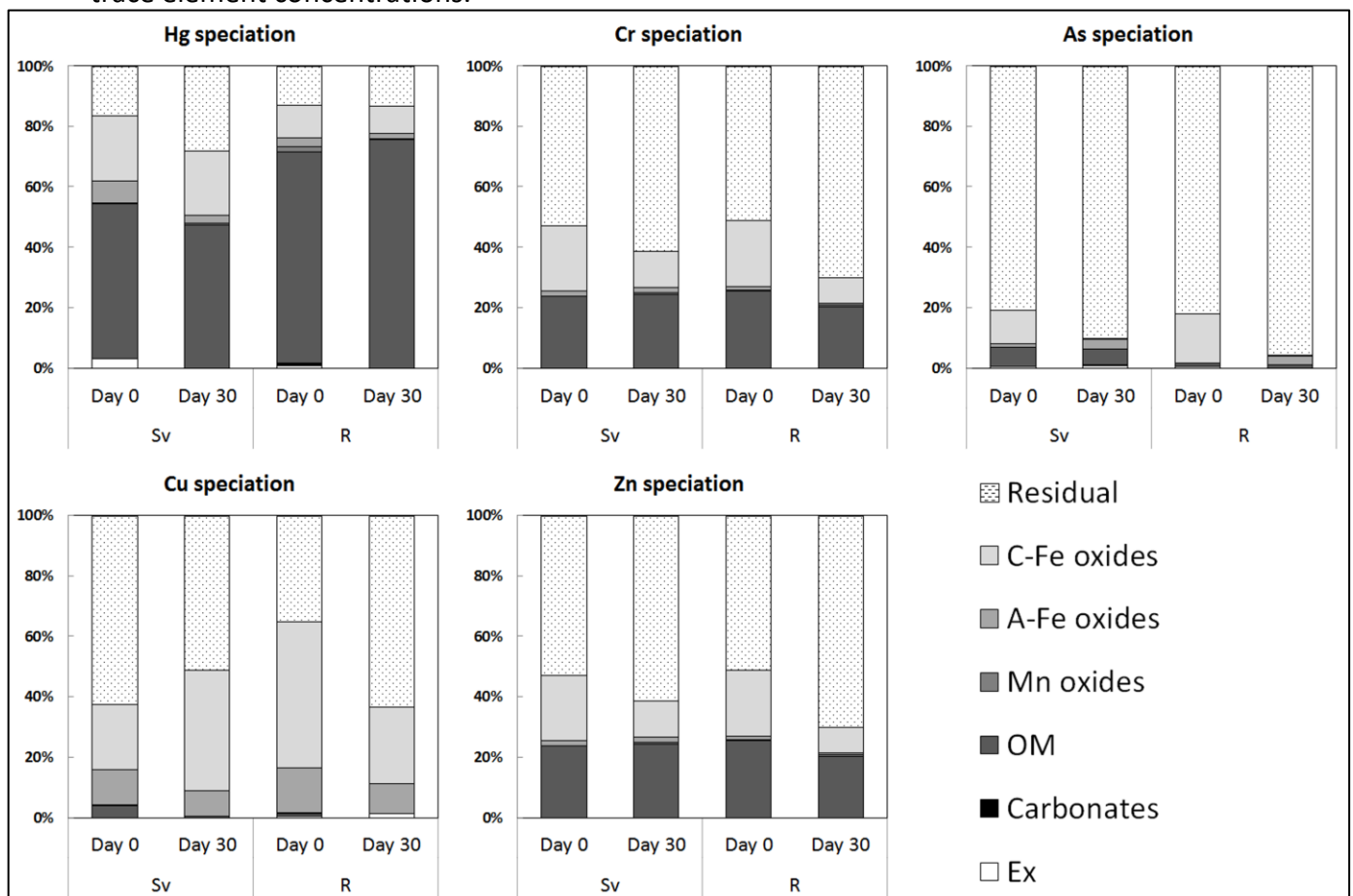

Figure 1:

Trace element speciation at the beginning and at the end of experiments for the two sites. Ex: exchangeable fraction, ADS: carbonate fraction, OM: organic matter fraction, Mn oxides: Mn oxide fraction, A-Fe oxides: poor and amorphous crystalline Fe oxide fraction, C-Fe oxides: crystalline Fe oxides, and residual fraction.

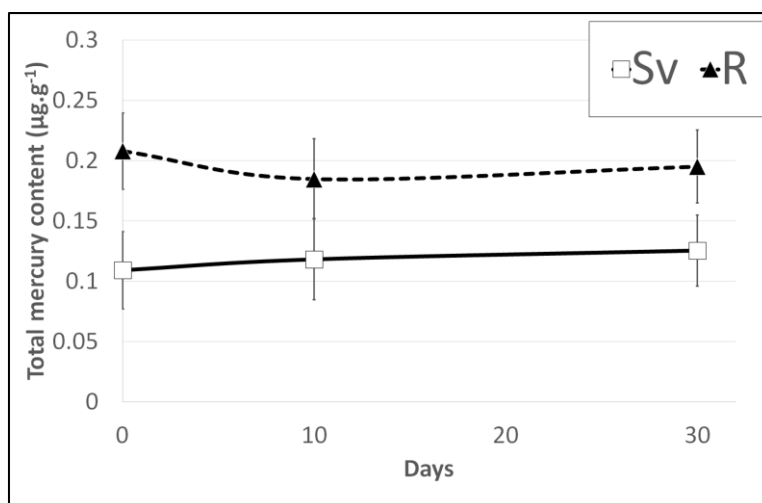

Figure 2:

Change in the total mercury content of Sv and R sites (n = 6 to 9, mean ± sd). Each point and bar represent the mean and standard deviation obtained on replicates.

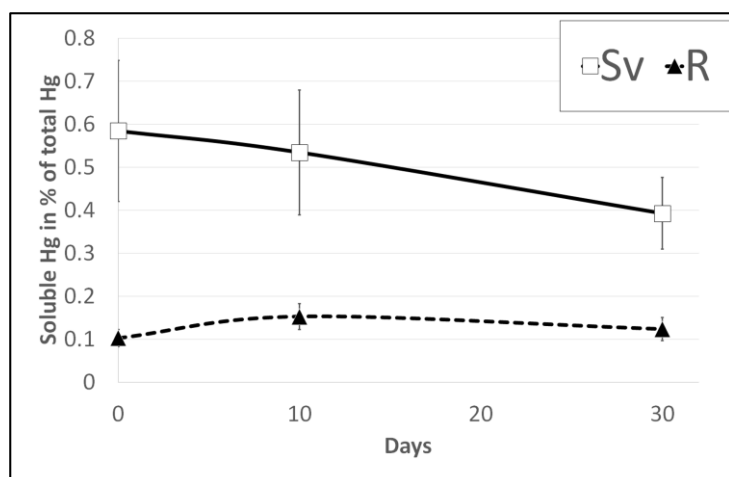

Figure 3:

Change in the soluble mercury content of Sv and R sites (n = 6 to 9, mean ± sd). Each point and bar represent the mean and standard deviation obtained on replicates.

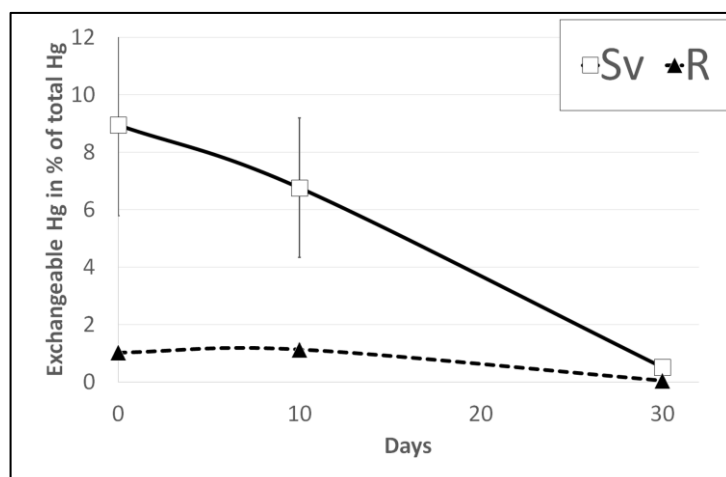

Figure 4:

Change in the exchangeable mercury content of Sv and R sites (n = 6 to 9, mean ± sd). Each point and bar represent the mean and standard deviation obtained on

3.2.3. Evolution of soil enzyme activities

Regardless of the soil enzyme assay and the restored site (i.e., Sv or R) (Figure 5), soil enzyme activities showed no significant differences between the beginning and the end of the laboratory experiment, except for dehydrogenase activity at the R site. Regardless of the

soil enzyme assay, soil enzyme activities were significantly the highest at the R site, except for urease activity.

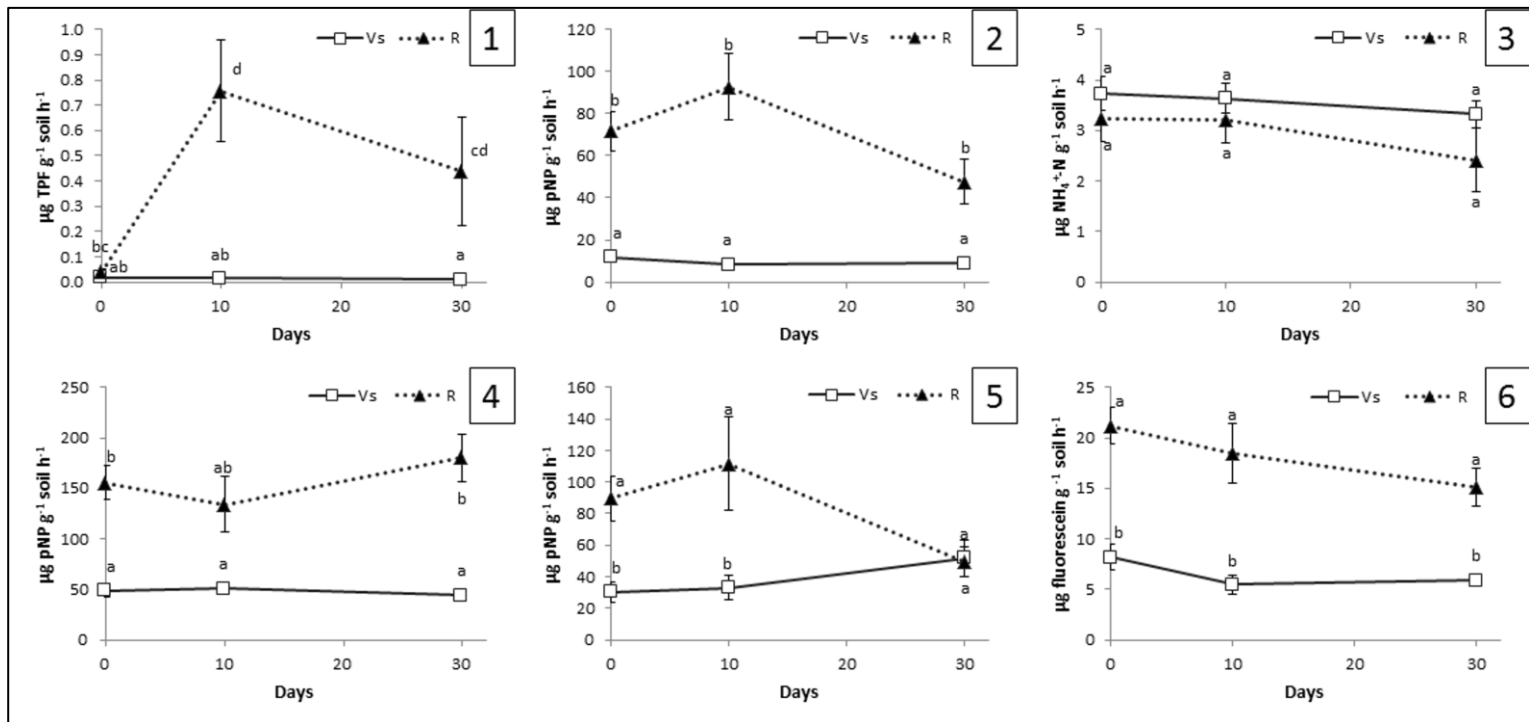

Figure 5:

Soil enzymes activities involved in soil C, N and P turnover during 30 days of incubation in non-revegetated (Sv) and revegetated areas (R) (n=6 to 9, mean ± SD). [1] = Dehydrogenase activity in µg TPF (red-colored formazan) g⁻¹ soil h⁻¹, [2] = β-glucosidase in µg pNP g⁻¹ soil h⁻¹, [3] = Urease activity in µg NH₄⁺-N g⁻¹ soil h⁻¹, [4 & 5] = Acid phosphatase and Alkaline phosphatase activities in µg pNP g⁻¹ soil h⁻¹ and [6] = FDA activity in µg fluorescein g⁻¹ soil h⁻¹. For each kinetic point during the incubation bars with different letters indicate significant differences between soils and times of incubation using Conover-Iman test of multiple comparisons after Kruskal-Wallis non-parametric test with P < 0.05.

By the end of experiment, the total enzymatic activities (FDA) at the Sv and R sites were 6.1 and 18.4 µg. g⁻¹.h⁻¹ of fluorescein, respectively. For dehydrogenase activity, the Sv and R sites reached values of 0.01 and 0.41 µg TPF g⁻¹ soil h⁻¹, respectively.

For β-glucosidase activity, the values at the Sv and R sites were 9.6 and 70.7 µg pNP g⁻¹ soil h⁻¹, respectively. The acid phosphatase values were 47.9 and 156.7 µg pNP g⁻¹ soil h⁻¹, respectively, and the alkaline phosphatase values were 38.2 and 83.5 µg pNP g⁻¹ soil h⁻¹ for the Sv and R sites, respectively. The urease activity at the Sv site and R site was 3.6 and 2.8 µg NH₄⁺-N g⁻¹ soil h⁻¹, respectively.

The three enzymatic activities measured for the control site are summarised in Table 5. The total enzymatic activity (FDA), with a value of $18.6 \mu\text{g} \cdot \text{g}^{-1} \cdot \text{h}^{-1}$ of fluorescein, was identical to that of the R site. However, the dehydrogenase and urease activities were significantly higher than those of the rehabilitated sites, with $1.38 \mu\text{g TPF g}^{-1} \text{ soil h}^{-1}$ and $12.2 \mu\text{g NH}_4^+\text{-N g}^{-1} \text{ soil h}^{-1}$, respectively.

4. Discussion

The aim of this study was to compare and characterise the effects of two restoration processes on soil physical, chemical and biological properties at two old mining sites. To accomplish this, one site with spontaneous vegetation (Sv) and a second site regenerated with *Acacia mangium* and *Clitoria racemosa* (R) vegetation were sampled, chemically and biologically characterised, and compared. The second objective, i.e., combining sequential chemical extraction, microbial enzymes activities and C, N and P turnover rates, was evaluated in microcosms under controlled laboratory conditions, and the effects of soil restoration processes on trace element speciation were identified; we compared the soil enzyme activities and the C, N and P microbial mineralisation rates. The interaction between the microbial activities and the mobility of trace elements was also a goal to be achieved to understand the interactions between chemical and biological quality indicators. The two old mining sites that were studied are in the same area and have the same history of gold exploitation.

4.1. Soil microbial biomass and enzyme activities as indicators of restoration quality

Microbial biomass carbon (MBC) is a major component of micro-organisms and is commonly considered as a sensitive indicator of changes in the abundance of soil microorganisms (Vig *et al.*, 2003). Microbial biomass also affects many critical ecosystem processes such as nutrient transformations and decomposition of organic compounds (He *et al.*, 2003), degradation of xenobiotic organic compounds, the immobilisation of trace elements, and the formation of soil structure (Nannipieri *et al.*, 2002). In the two studied sites, regardless of the soil enzyme assays, the MBC was positively and significantly correlated with enzyme activities, except for urease activity. This result may indicate that enzymatic activities related to carbon and phosphorus mineralisation are mediated and controlled by the abundance of microbial biomass, while activities related to the nitrogen

cycle are more affected by microbial community structure. This last interpretation is in agreement with the conclusions reported by some authors that showed the bacteria and enzymes involved in the nitrogen cycle are very sensitive to soil disturbance, and in particular, to metal pollution, including mercury pollution (Kandeler *et al.*, 1996; Watras and Huckabee, 1994; Yang *et al.*, 2005). It could also confirm that measurements of biomass and enzyme activity both appear to be relevant for bio-indication of ecological restoration quality (Badiane *et al.*, 2001). The higher soil microbial biomass and enzyme activities at the R site suggested that microorganisms had been stimulated by the introduction of leguminous species. Choosing fast-growing species and N₂-fixing species, such as legumes, can increase soil carbon and nitrogen stocks, which are key factors in ecological restoration that supports microbial activities and restores soil fertility (De Faria *et al.*, 2010; Franco and De Faria, 1997; Siddique *et al.*, 2008). The increase in soil organic matter content improves the soil water retention capacity as well as the bioavailability of soil nutrients (i.e., N, P, K, Ca, Mg)(Hobbs and Harris, 2001; Viana *et al.*, 2014) and soil enzymes (Asmar, 1997; Kang and Freeman, 2007). These conditions promote the development of microorganisms and their ability to mineralise soil macronutrients (Elfstrand *et al.*, 2007). These results are in agreement with other studies on rehabilitated land (Giai and Boerner, 2007; Hu *et al.*, 2016; Jia *et al.*, 2017; Ma *et al.*, 2017; Schimann *et al.*, 2012a), and this may show that there is a link between the restoration of a specific type of vegetation cover and the recovery of soil microbiological activities. A molecular characterisation of the microbial communities could have shown us whether the differences observed between the different sites were also associated with the community structures. Although some authors have shown a correlation between bacterial community structure and functionality, the work carried out by Hellal-Harris in our laboratory showed identical functionality despite the strongly altered genetic structures following metallic pollution (Harris-Hellal *et al.*, 2009).

In 17 years, in terms of rehabilitation objectives, fabaceous plantations have almost three times the microbial biomass and significantly increased enzymatic activities related to the carbon and phosphorus cycles. While these results are encouraging, it should be noted that microbial biomass values in F site are twice as high as in R site, and urease activity values for F control site are three to four times higher than in R site. Integrating that the overall enzymatic activity was similar between R and F, fabaceous plantations are able to

recover and stimulate microbial activity. However, the challenge concerning the recovery of enzymatic activities linked to the nitrogen cycle remains important, and has not yet been achieved after 17 years of ecological restoration. Further studies are needed to explain this finding. It is usually reported that heavy metals negatively impact the enzymatic processes of the nitrogen cycle. For example, inorganic mercurial compounds are known to have a strong inhibitory effect on *Azotobacter* (N₂ fixating) and on nitrifying bacteria. This observation makes nitrogen cycle bacteria good candidates for a finer assessment of the impacts of metallic stress (Kandeler *et al.*, 1996; Watras and Huckabee, 1994; Yang *et al.*, 2005).

4.2. Efficiency of ecological restoration on the dynamics of major elements (i.e., C, N, P)

The large differences in major element contents and mineralisation capacities between the two sites indicated an important effect of plant restoration. The R site regenerated with fabaceous species (*Acacia mangium* and *Clitoria racemosa*) developed a net primary productivity higher than that at the Sv site, which may be associated with an increase of microbial biomass (Fierer *et al.*, 2009). It is well known that plant residues (fresh litter and root exudates) provide an important input of soil organic matter, carbon, nitrogen, and other nutrients utilised by microbes (Cao *et al.*, 2008; Kaur *et al.*, 2002; Miao *et al.*, 2015). An increase in organic matter content improves the bioavailability of major elements, which leads to an increase in microbial activity (Melero *et al.*, 2007), as indicated by the significant correlation between the microbes and the major element parameters (Table 5). These correlations confirm that nutrient contents and transformations are closely related to soil enzyme activities, and thus, to soil fertility in rehabilitated land. Because of the return of microbial activities, ecological restoration promotes the recycling of soil nutrients. If plant restoration was a common method for limiting soil loss by erosion (Wong, 2003), our results would also show that the use of fabaceous species as a means of recovering the soil major nutrient element stocks showed good results in comparison to the spontaneous return of vegetation. Nevertheless, after 17 years of ecological restoration, the recovery of the carbon and nitrogen stocks, despite the use of fabaceous species, have not made it possible to determine the levels of C and N in the control soil.

However, the results concerning the nitrogen cycle (urease activity or N-transformation) were heterogeneous and were correlated with the C and P results, which may indicate a

condition of N limitation. These results did not include all nitrogen cycle mechanisms such as the potential denitrification rate. In addition, the topography of the Sv and R sites might suggest that these sites are likely to experience anaerobic conditions during heavy precipitation. These conditions could lead to denitrification, resulting in nitrogen loss. Assessing denitrification potentials, as proposed by Schimann (Schimann *et al.*, 2012a), could be a very good indicator of the impact of mine site remediation on the microbial community.

Nitrification is one of key soil functions and a regulating process of the nitrogen cycle, which directly impacts soil nitrogen availability and net primary production in an ecosystem (Parton *et al.*, 2007; Swift *et al.*, 1998). Nitrification could be a relevant bioindicator to assess soil ecosystem health and soil quality; however, it reacts very quickly to anthropisation and soil trace element pollution (Broos *et al.*, 2005; Xu *et al.*, 2009b; Xu and Chen, 2006). In this context of old mining site restoration with a high degree of disturbance, the nitrification measurements may not be appropriate. However, microbial activities related to the carbon and phosphorus cycles appear to be more relevant for assessing the soil chemical and biological quality.

4.3. The influence of ecological restoration on trace element speciation

The total mercury content (Figure 2) for the Sv and R sites did not significantly decrease during the mesocosm experiment ($p > 0.05$). It is possible that the experiment did not last long enough to observe significant results on fungal and bacterial enzymatic reduction activity, such as mercury (II) reductase that produces volatile Hg_0 (Robinson and Tuovinen, 1984; Summers, 1986). During the experiment, volatile mercury may have also condensed in the sealed bottles and been returned to the soil samples. Another hypothesis that can explain this low mercury volatility in the Sv and R samples is the strong association between mercury and its different carrier phases (MO, iron oxides) and its weak availability for microbial reduction (Hellal-Harris; 2009). While the results are consistent with the results found by the authors at natural sites (Alloway, 2012; Andersson, 1979; Guedron *et al.*, 2009; Roulet and Lucotte, 1995), they contrast with speciation results from contaminated mining sites. In the Wanshan mining area of China (Wang *et al.*, 2011), as well as in Asturias mines in Spain (Fernández-Martínez *et al.*, 2015), the main fraction of mercury in soil is the elemental form. Guedron *et al.* (2009) also obtained the same results from mining sites in French Guiana. Nevertheless, several authors have taken an interest in the speciation of mercury at

rehabilitated sites, and there is little information about this data, particularly in tropical forests. In our study, the Hg percentage associated with organic matter was higher than the results from Guedron (Guedron *et al.*, 2009), where mercury bound to organic matter never exceeded 50% under the same environmental conditions. This result could be explained by the organic matter composition and its relative affinity for mercury compared to natural soil (Qian *et al.*, 2002; Schuster, 1991). The characterisation of the organic matter at the study sites and their reactivity to mercury could help us confirm this hypothesis. The highest percentage of soluble and exchangeable Hg in the Sv site indicates a negative effect of this restoration process, increasing the availability of mercury. In addition, other studies have shown that the percentage of soluble Hg²⁺ could be high when Hg is mainly bound to dissolved organic matter, even more in acidic soils (Guedron *et al.*, 2009; Qian *et al.*, 2002; Skyllberg *et al.*, 2006a). In the R site, the higher quantity of Hg bound to stable OM and the lower concentration of exchangeable and soluble Hg indicated that the presence of vegetation canopy has reduced the mobility of mercury. While the mechanisms that allowed the plants used in the R site to reduce the availability of mercury remain to be identified, our results could show the influence of a specific vegetation cover type on mercury distribution.

Arsenic speciation must be considered because of the high concentration of As in both sites. Reference concentrations of arsenic in soils are generally in the order of 5-10 mg kg⁻¹, with an average of 7.2 mg kg⁻¹ (Smedley and Kinniburgh, 2002). However, the values found at the study plots were relatively low compared to the values found at contaminated sites, which may exceed 100 ppm (Smedley and Kinniburgh, 2002). In agreement with the authors, arsenic is mainly bound to iron oxides and to residual fractions such as ferric arsenate or arsenic sulphide, according to redox conditions (Bostick and Fendorf, 2003; Goldberg, 2002; Johnston *et al.*, 2012). In French Guyana, with high precipitation and possible anaerobic conditions, the residual fraction of arsenic could further be easily solubilised and released into the aqueous phase (Ahmann *et al.*, 1997; Islam *et al.*, 2004; O'Day *et al.*, 2004). The mechanisms of As dissolution, such as Hg availability, were highly dependent on iron and sulphate bacterial reduction (Xu *et al.*, 2016), but more measurements will need to be taken to confirm these hypotheses. Nevertheless, the influence of ecological restoration on As speciation seems to be low (Figure 1), and significant speciation differences were only observed on the fractions of organic matter ($p =$

0.01) and crystalline iron oxides ($p = 0.024$) using the Kruskal-Wallis test. Crystalline iron oxide, such as goethite, are, however, resistant to bacterial reduction and complexing compound action compared to less crystalline types, such as lepidocrocite, in environmental conditions with limited As mobilisation (Bousserrhine *et al.*, 1998).

Ecological restoration influences the speciation of copper (Figure 1). There was more exchangeable copper at the Sv site ($p = 0.001$) and more copper bound to OM at the R site ($p = 0.0001$). There was no significant effect on the other fractions. As reported by several authors (Arenas-Lago *et al.*, 2014b; Cerqueira *et al.*, 2011; Covelo *et al.*, 2008; Vega *et al.*, 2010), most of the copper was in residual fractions or bound to iron oxides. Moreover, for the two sites, there was more exchangeable Cu than Cu bound to organic matter, as has already been described by Arenas-Lago *et al.* (2014)(Arenas-Lago *et al.*, 2014b). However, despite more than 300 ppm of Mn in each soil, Cu was not bound to Mn oxide, contrary to the results of Covelo *et al.* (2007)(Covelo *et al.*, 2007) on polluted soils. In our study, the mobility of these two elements was not associated.

Ecological restoration could influence zinc speciation (Figure 1). Indeed, all fractions showed significant differences (p -value < 0.03) between the Sv and R sites. The observed changes affect the two soil samples. The exchangeable fraction of Zn appears low compared with native tropical soils and the results from Hseu (2006)(Hseu, 2006). For Silveira *et al.* (2006)(Silveira *et al.*, 2006), Zn appeared to be preferentially bound to iron oxides rather than primarily minerals (such those found in residual fractions) and especially with the crystalline forms of iron oxide. There were major changes in speciation by the end of the experiment, with different results from those reported by other authors (Fontes and Gomes, 2003; Gomes *et al.*, 2001). The type of ecological restoration could affect the Zn cycle.

The chromium speciation observed during the experiment for both the Sv and R sites was a normal speciation for tropical soils (Alloway, 2012), with more than 50% of the chromium below its residual fraction and the remainder bound to organic matter (22%) and iron oxides (approximately 20%). Chromium mobility seemed to be low despite redox conditions favourable to the formation of toxic hexavalent Cr (Gjerde *et al.*, 1993) by reductive dissolution of iron oxides (Gotoh and Patrick, 1972; Hsu *et al.*, 2007). Due to a lack of significant differences between the Sv and R soils ($p = 0.953$ after Kruskal-Wallis test), chromium speciation may not be significantly influenced by vegetation cover type.

The role of plant cover establishment is important here, and the effects on the trapping of trace elements, in particular mercury, by the two restoration methods can be discussed. Sv and R have the same mining history; both sites have experienced the same physical and chemical stresses associated with gold mining. The two sites also have the same physical properties and are not discriminated solely by the macro-element content (i.e., C, N, and P). Despite these similarities, the total mercury concentrations were half as high in Sv as in R, and as much as four times lower than in the F control site. Zinc and chromium concentrations were also higher in R. Unvegetated and deforested soils are very sensitive to erosion and leaching, particularly in tropical regions where precipitation is very high during the rainy seasons (Grimaldi *et al.*, 2014). It is possible that the absence of significant vegetation cover on the Sv plots could have led to a loss of metallic trace elements in the water network. As a result of creeping roots and high biomass production, the use of fabaceous species in the ecological restoration process allows for the rapid recovery of the organic matter pool in the soil and will limit the erosion processes (Loubry, 2002). Microbial biomass itself contributes a metal trap, which could help explain the differences in the observed levels between the sites (Gounou *et al.*, 2010). It should also not be excluded that further sampling of different non-vegetated sites could refine the mean mercury levels. The benefits of the controlled establishment of vegetation cover, therefore, go beyond ecosystem services related to carbon storage in soils, or the recovery of key biogeochemical cycles, and would limit the mobility of some toxic elements such as mercury. However, it is important to take a step back from these assumptions since no total trace element measurements were available at the initial phase before ecological restoration began. Among the trace elements studied and based on our results, mercury appears to be the most sensitive trace element in ecological restoration processes. Its speciation and distribution differed from other elements, and its physico-chemical properties, with a high potential for toxicity, make it a major element to be considered in the ecological restoration processes that occur at mining sites.

Conclusion

The responses of microbial activities and chemical processes have been poorly studied in terms of assessing the effects of restoration projects in old Amazonian mining sites. Comparing active ecological restoration that included planting *Acacia mangium* and

Clitoria racemosa (R) with passive restoration with spontaneous vegetation (Sv) resulted in significant improvements in surface vegetation, which were associated with greater soil microbial activities related to major element cycles. The results of this active restoration are positive and are close to the microbiological activities of the control forest soil (F). The use of soil microbial carbon biomass and soil enzyme activities related to the carbon and phosphorus cycles as bioindicators seems to be relevant to the assessment of soil quality at rehabilitated and regenerated old mining sites. Our results also indicated that changes in trace element speciation could be observed between restoration processes and may indicate the trapping of some trace elements in revegetated soils (R). Significant differences were observed for the mobility of mercury. In the R site, a global decrease in soluble and exchangeable mercury was observed; however, mercury mobility was high at the Sv site. Among the trace elements studied, mercury seemed to be the most sensitive to ecological restoration, which confirms that speciation of mercury could be another relevant indicator of soil quality and health during restoration processes.

Acknowledgements

We would like to thank Christian Pernaut, manager of the mining company Ermina, who was our guide in French Guiana during the sampling campaign. We thank Philippe Matheus, manager of the mining company C.M.B. for his logistical and material support. We also thank the Cayenne and Bondy Development Research Institute for their analytical contributions.

Chapitre III

Influence d'une diversité de protocoles de restauration
écologique sur les activités microbiennes telluriques
d'anciens sites aurifères en Guyane Française

Avant-propos

Les données acquises grâce à la première campagne d'échantillonnage ont permis de mettre en évidence des différences biogéochimiques fondamentales entre un site non revégétalisé et un site dont le couvert arboré était entièrement restauré. Au vu de ces résultats positifs nous avons réalisé une seconde campagne d'échantillonnage dans le but d'accroître le nombre de prélèvements pour avoir un jeu de données plus robuste. Avec l'aide d'un opérateur minier³, nous avons réalisé une semaine complète de prospection dans le but de cibler davantage de sites miniers réhabilités. Cette période de prospection nous a également fait envisager les enjeux de la restauration écologique sous un angle nouveau. Nous avons découvert des sites miniers peu ou mal réhabilités, de manière très hétérogène avec une végétation parfois totalement absente en raison d'une absence de suivi de la revégétalisation, ou parfois d'une non-revégétalisation. Grâce à l'aide d'un chercheur⁴ pour ces analyses paysagères, nous avons retenu une diversité plus importante de sites miniers réhabilités en dissociant cette fois des sites réhabilités uniquement et des sites réhabilités et restaurés avec un couvert végétal. Nous avons donc échantillonné un panel de sites uniquement réhabilités avec des textures hétérogènes et une faible couverture végétale ainsi que des sites réhabilités et entièrement restaurés grâce à l'utilisation de différentes légumineuses. Cet échantillonnage permettra d'aborder l'impact de la restauration écologique sous un nouvel angle en associant - diversité texturale du sol - diversité végétale – diversité des activités microbiennes.

³ Christian Pernaut, opérateur minier pour la compagnie Ermina

⁴ M. Michel Grimaldi (Directeur de recherche IRD)

Article II: Influence of temperature and soil moisture on biogeochemical cycles in former mining sites in French Guiana

Résumé

Les activités minières, particulièrement l'orpaillage en Guyane Française, ont conduit à une dégradation des sols et des habitats forestiers. Ces dégradations anthropiques peuvent altérer les réponses des communautés microbiennes aux stress ultérieurs, incluant les modifications climatiques. Cette étude s'intéresse à l'impact de la température et de l'humidité du sol sur la qualité biochimique de sols réhabilités et restaurés dans la région de Yaoni en Guyane française. Nous avons échantillonné 3 sites miniers réhabilités avec différents protocoles de revégétalisation : Un site recouvert par de la végétation spontanée (Sp), une monoculture d'*Acacia mangium* (Aca) et une association d'*Acacia mangium* et *Clitoria racemosa* (Mf). Nous avons également échantillonné un site control non anthropisé. Nous avons réalisé une expérimentation sur des échantillons de sol avec un dispositif en mésocosmes et des conditions d'incubation contrôlée. Quatre traitements expérimentaux ont été utilisés, avec un gradient de deux températures (28 et 38°C) et deux niveaux d'humidité de sol (70 et 100% de la capacité au champ). Tout au long de l'expérimentation la production de CO₂, de NH₄⁺, de NO₃, et les activités déshydrogénase, uréase et globales ainsi que la mobilité du mercure ont été suivies. L'analyse inter-groupes (BCA) ont mis en évidence un effet site expliquant 59,13% de la variable expérimentale. En termes de qualité biochimique, les deux sites restaurés Aca et Mf sont très proches et largement supérieur au site non restauré Sp. Toutefois, les activités biologiques restaient en deçà du site control naturel. Nous avons également mesuré une mobilisation plus importante du mercure sur les sites Aca et Mf. L'analyse inter-groupe a également mis en évidence un effet traitement, mais plus faible que l'effet site avec uniquement 14,36% de la variance expliquée. Il semblerait que la température ait un effet limité sur les activités microbiologiques alors que l'augmentation de l'humidité du sol à 100% de la capacité de rétention a diminué les activités enzymatiques. Le site restauré Mf et le site control naturel étaient les deux sites les plus sensibles aux traitements expérimentaux, notamment en changement d'humidité. D'après ces résultats, il semblerait que la biomasse microbienne total, en lien avec le niveau de couverture végétale, soit un facteur clef de l'adaptation à des perturbations climatiques.

Il semblerait également que l'utilisation de fabacées puisse avoir un effet sur la mobilisation du mercure et cela confirme l'importance de la prise en compte des processus biogéochimiques pour évaluer la performance des protocoles de restauration écologique.

Submitted in Pedobiologia

**Influence of temperature and soil moisture on biogeochemical cycles in
former mining sites in French Guiana**

Ewan Couic^{*a,b}, Vanessa Alphonse^b, and Noureddine Bousserhine^b

^a Institut d'Ecologie et des Sciences de l'Environnement de Paris (IEES), Université-Paris-Est Créteil, 94010, Créteil cedex, France.

^b Laboratoire Eau Environnement et Systèmes Urbains (Leesu), Université-Paris-Est Créteil, 94010, Créteil cedex, France

^d Laboratoire des Moyens Analytiques de Cayenne (LAMA), Institut de Recherche pour le Développement (IRD), Centre IRD de Cayenne, 97323, Cayenne cedex, France

* Corresponding author :

Ewan Couic

E-mail :

Abstract

Mining, particularly gold panning in French Guiana, leads to degradation of soil and natural forest habitats. This type of anthropogenic degradation can alter the response of microbial communities to subsequent stresses, including those induced by climate change. This study examined the impact of soil temperature and moisture on chemical and microbiological quality biomarkers of rehabilitated mining soils in the Yaoni region of French Guiana. We sampled 3 rehabilitated mining sites with different ecological restoration protocols: a site where vegetation cover restoration is spontaneous (Sp), a monoculture of *Acacia mangium* (Aca) and an association of *Acacia mangium* and *Clitoria racemosa* (Mf). We also sampled soil from a control site without a history of gold mining. We carried out an experiment in mesocosm by incubating soil samples for 34 days in 4 treatments with a gradient of 2 temperatures (28 and 38°C) and 2 levels of soil moisture (70% and 100% WHC). Throughout the experiment, the production of CO₂, NH₄⁺, NO₃⁻, enzymatic dehydrogenase, urease and global activities as well as mercury mobility were monitored.

The between groups analyses (BCA) revealed a significant site effect with 59.13% of the variable explained on the parameters monitored during the experiment. In terms of biochemical activities and quality, the two restored sites with tree cover (Aca and Mf) were very close and much superior to the spontaneous site Sp. Nevertheless, biological activities remained below those on the natural control site Fc. We also recorded a greater solubilization of mercury at the Aca and Mf sites than at the Sp and Fc sites. The between groups analyses on the effect of the treatments revealed only 14.36% of the variability. Overall, the temperature change had only a very limited effect on biological activities, while the increase in humidity to 100% of water retention capacity decreased enzymatic activities. The rehabilitated Mf site and the natural site Fc were the most sensitive to environmental changes and the change in humidity level is the factor that most affects microbiological activities at these sites. From these results, the increase in microbial biomass related to the level of ecological restoration is a key factor in soil adaptation to climate change. It would also appear that the use of fabaceae in mine reclamation may impact the mobilization of some trace elements such as mercury and this confirms the importance of understanding biogeochemical mechanisms to assess ecological reclamation.

1. Introduction

A rainforest is a biodiversity sink and provides a variety of key resources and ecosystem services to humans, such as food, drinking water, wood and medicines (Foley *et al.*, 2007; Lewis *et al.*, 2009). Preserving rainforests has been one of the most important issues in recent years, but an increase in anthropogenic pressures leads to a deterioration of the environment, natural resources and community structure (Sala *et al.*, 2000). The Amazonian forest is particularly affected by deforestation due to agriculture, mining and logging (Keenan *et al.*, 2015b). These pressures result in habitat loss and species extinctions and reduce ecosystem functions, resulting in a reduction in ecosystem services (Cardinale *et al.*, 2006; Grimaldi *et al.*, 2014; Tilman *et al.*, 2001). In the Amazon rainforest, gold mining activities for several decades have been a major environmental threat, having cumulative effects of deforestation, acid mine drainage and soil and water pollution from arsenic, cyanide and mercury contamination (Veiga *et al.*, 2006). Mining activity in the Amazon also leads to a very strong degradation of the soil, its structure and loss of organic matter and major nutrients (Wong, 2003). This type of stress has been shown to massively affect soil microorganism communities and can prevent the return of ecological succession (Bradshaw, 1997a; Martínez-Garza and Howe, 2003). Strong public policies are now needed to provide a framework for the sustainable management of forests and the gold industry (Stokstad, 2005). Current regulations require ecological rehabilitation with local plant species. Establishing new vegetation cover is essential for stabilizing bare areas to reduce erosion, minimize trace element mobilization, prevent water pollution and restart natural forest succession (Wong, 2003). The choice of species for the reclamation of mining sites in the Amazon is made according to the nature of the soils, the type of pollution and the water regime of the site (Karlen *et al.*, 1997). For nearly 20 years in French Guiana, legume species such as *Acacia mangium* (Hulugalle, 1992) have been selected for ecological rehabilitation, mainly for their ability to fix atmospheric nitrogen, their very high growth rate, and the fact that they do not inhibit the subsequent establishment of local species (Lamb and Lawrence, 1993). The assessment of the quality of ecological rehabilitation is usually carried out according to visual, physical (bulk density (Logsdon and Karlen, 2004), aggregate stability (Angers *et al.*, 1992)), chemical (pH (Smith *et al.*, 1996), soil organic matter content (Karlen *et al.*, 2008)) or biological criteria with the use of microorganism activities as bio-indicators. Microbiological activities associated with the functioning of biogeochemical cycles

(Nannipieri *et al.*, 2003) are bio-indicators of the overall functioning of an ecosystem. The evaluation of these activities is usually carried out by measuring microbial biomass (Jordan *et al.*, 1995), soil respiration or enzymatic activities (Jordan *et al.*, 1995). These measures are particularly relevant for assessing the quality of rehabilitation in a context where soils have been severely degraded (Nannipieri *et al.*, 2003). In natural soil, microbial activities are largely affected by the soil's thermal and humidity regimes (Subke and Bahn, 2010). In general, soil respiration and microbial activity are optimal with intermediate soil moisture levels, and episodes of drought and flooding are generally unfavourable to aerobic microbial communities (Silva *et al.*, 2008; Unger *et al.*, 2009). Concerning temperature, laboratory simulations show that optimal activities are found at intermediate temperatures of approximately 30 degrees and that high temperatures that exceed 40 °C generally affect heterotrophic communities more than low temperatures do (Luo *et al.*, 2001; Zhou *et al.*, 2009). However, the interactions of these two parameters are complex, and the response of microbial communities to physico-chemical changes will also be governed by organic carbon and nutrient levels (Bahn *et al.*, 2010; Davidson and Janssens, 2006; Fontaine *et al.*, 2004; Subke and Bahn, 2010).

Consequently, there is no real consensus on the effect of the thermal and humidity regimes on microbial activities since they also depend on the origin of the soil, its mineral component or the activities of fauna and flora (Chodak *et al.*, 2009; Chodak and Niklińska, 2010; Frouz *et al.*, 2011). While it has already been demonstrated that microbiological activities, in relation to the cycles of major elements, on reclaimed mining soils are below natural activities, and their relationships and sensitivity to thermal and humidity regimes are poorly understood. Moreover, alluvial Guianese mining soils are particularly affected by changes in water and thermal regimes over the seasons and by topographic changes induced by mining activity. Due to the strong degradation of the physico-chemical quality of these soils, their biological and chemical responses to certain climatic variations, such as an increase in temperature and humidity, could be modified and altered. In the context of global warming, understanding these mechanisms could enable better management of the rehabilitation of Guianese mining sites.

In this study, we examined the effect of different ecological rehabilitation protocols and different soil moisture and thermal regimes on microbial activities in relation to the

functioning of some important biogeochemical cycles through measurements of carbon and nitrogen mineralization and enzyme activities.

In this context, the objectives of this study were to (1) describe the influence of three ecological rehabilitation protocols on soil chemical quality, (2) describe the influence of these restoration processes on biogeochemical cycles, and (3) describe the influence of humidity and temperature variation on microbial activities and performance of different biogeochemical cycles in relation to environmental conditions. To simulate variations in humidity and temperature in the soils, 2 temperatures (28 and 38 °C) and 2 humidity levels (70 and 100% water holding capacity WHC) were retained. For the temperature, 28 °C represents a relatively normal temperature in French Guiana, while 38 °C degrees represent a high temperature encountered during heat waves. For humidity, 70% corresponds to an average humidity under forest cover, while 100% humidity represents nearly anaerobic conditions encountered during episodes of heavy rain and flooding, a recurring phenomenon on Guianese alluvial mining sites.

While it is difficult to predict the different recovery trajectories of biogeochemical cycles during rehabilitation, it is essential to evaluate the effectiveness of restoration efforts in a sustainable development context. The results obtained will be useful for developing new ecological evaluation criteria to improve forest management in tropical rainforests.

2. Materials and methods

2.1. Site description and soil sampling

This work was undertaken in French Guiana, South America. Annual rainfall ranges from 2 m to 4 m, and the annual average temperature varies slightly around approximately 26 °C. The climate is seasonal equatorial(Barret, 2004). The soils sampled for this study were rehabilitated after gold mining extraction occurred between 1990 and 1997. After closing the alluvial mine pit, restoration consisted of reconstituting the soil excavated during mine exploitation. All excavated soils were homogenized and flattened before restoration began(Loubry, 2002). These soils could be considered anthroposol, and they have structure and texture different from those of native natural tropical forest soils.

The experimental site was in eastern French Guiana (N 04°30.930' / W 052°21.275'). The site was exploited by the Compagnie Minière de Boulanger (CMB)[®] and has remained unexploited for 17 years.

Three situations were chosen based on the restoration method adopted. The first method of restoration consisted of allowing spontaneous vegetation to recover the site (N 04°30.311' / W 052°26.919') after the pit was filled. We named this site **Sp** to denote “*spontaneous vegetation*”. Spontaneous vegetation covered 5 to 10% of the soil surface and was dominated by herbaceous species, ferns and pioneer tree species. The second method of restoration consisted of introducing *Acacia mangium* in monoculture (N 04°29.860' / W 052°26.966') after filling the pit. We called this site **Aca** to denote “*Acacia*”. The third method of restoration consisted of introducing *Acacia mangium* and *Clitoria racemosa* (N 04°29.595' / W 052°26.984') after the pit was filled. We called this site **Mf** to denote “*Mixed fabaceous*”. A fourth site, serving as a positive control, was in a natural forest near the previously described sites. This site has never been anthropized, and no mining activity has been identified. It was in Combat Creek, near the village of Cacao (N 04°35' / W 52°23'). This soil is categorized as an Oxisol based on the US Soil Classification System. We called this site **Fc** to denote the “*forest control*” soil.

At each site, soil samples were collected from depths between 0 and 10 cm with an auger in April 2016. The soil samples for each of the four sites consisted of 5 pools of 3 samples each for a total of 15 samples collected per site (sampled at 5 m from each other). Soil samples were immediately sealed in sterile hermetic polyethylene bags for transportation to the laboratory. Samples were then air dried at ambient temperature (25 °C) until they were dry (i.e., approximately 3 weeks). These 60 collected samples were then sieved at 2 mm, homogenized, and hermetically sealed at 4 °C until use.

To perform optimal speciation measurements of metallic trace elements in soils, it is preferable to implement experiments on wet or frozen soils directly after sampling (Reis *et al.*, 2016). This approach prevents the modification of ETM redistribution (Baeyens *et al.*, 2003; Claff *et al.*, 2010; Reis *et al.*, 2016). This conservation method, although optimal, is difficult to implement in a field campaign. In most studies, to minimize the loss of trace elements, particularly elemental mercury, samples are usually dried at room temperature over a period of 1-2 weeks and then sieved (Arenas-Lago *et al.*, 2014a; Grimaldi *et al.*, 2008;

Guedron *et al.*, 2006; Silveira *et al.*, 2006) or freeze-dried(Guedron *et al.*, 2009). Drying in a dry environment at a temperature of 25 °C, as in our study, is appropriate for the determination of total mercury. This method of conservation is widely reported in the literature(Da Silva *et al.*, 2016; Guédron *et al.*, 2006; Harris-Hellal *et al.*, 2009).

2.2. Initial soil sample characterization

Before using soil samples in microcosm studies, the effective cation exchange capacity (ECEC), pH, total major element (i.e., C, N, P, Fe, Al) and total trace element (Hg) content, total organic carbon content, granulometry, and microbial biomass carbon (using the substrate-induced respiration (SIR) method) were determined to characterize the main physico-chemical and biological properties. Samples were analysed to determine the enzymatic activities and mineralization rates of C and N, and the protocol is described in the section dedicated to the experimental design (2.3).

Soil pH measurements:

Soil pH-H₂O and pH-KCl were measured in soil suspensions by shaking 1 g of soil in a 1:2.5 soil-to-water and soil-to-KCl (0.1 M) ratio for 1 hour and then by using a pH metre (MetrOhm 744) (ISO 10390).

Soil total metal content:

For all metal analyses, the samples were first ground to 63 µm. To obtain total metal (i.e., Fe, Al) concentrations, soil samples were mineralized in cleaned Teflon digestion tubes (SCP Science) at 80°C in a mixture of concentrated HNO₃-HF (3:1 ml) using a hot block (Digiprep MS, SCP Science). Samples were warmed at 80°C. All samples were then dissolved in 2 ml of concentrated HCl overnight at 80°C and then warmed for 4 hours at 80°C. Then, samples were dissolved in 5% HNO₃ before the analysis by inductively coupled plasma optical emission spectroscopy (ICP-OES, Spectroblue). All chemicals used were of trace element grade purity.

Soil total mercury content:

Total mercury concentrations (HgT) in soil samples were determined directly by thermal decomposition atomic absorption spectrometry after gold amalgamation using an automatic mercury analyser (AMA 254) with a detection limit of 0.01 ng. In brief, the sample is heated to 550°C, and all products of decomposition, including mercury, are carried by a stream of oxygen through a catalytic tube where HgT is transformed into elementary

mercury (Hg^0), which then readily adsorbs to a gold-trap. The fixed mercury is then released by heating the gold-trap at 450°C , and the mercury is quantified by atomic adsorption spectrometry.

Soil carbon, nitrogen, and phosphorous measurement:

Soil total carbon (C_{tot}) and total nitrogen (N_{tot}) were determined by the Dumas method (NF ISO 13878). Briefly, the Dumas method consists of flash combustion of the soil sample (at 1000°C) using helium and oxygen. After purification of the combustion gases, determination of total carbon and nitrogen contents was performed by chromatography with a thermal conductivity detector (NA 1500 série 2 CARLO-ERBA).

Total phosphorus (P_{tot}) was determined after the acid digestion of soil samples, as previously described. The HPO_4 formed during acid digestion was measured after adding ammonium molybdate and acid ascorbic (Murphy and Riley, 1962) by following the instructions of the reagent kit 1.14848.0002 Spectroquant®. The colour produced by phosphomolybdenum (PMB) was measured by colorimetry at 885 nm (Spectrophotometer Genesys 10 μv Scanning, Thermo)

Soil granulometry determination:

Granulometry was determined on the fraction less than 2 mm, and five classes of particles have been distinguished according to the NF X 31-107 standard: clay ($< 2 \mu\text{m}$), fine silts (2 to 20 μm), coarse silt (20 to 50 μm), fine sands (0.050 to 0.200 mm) and coarse sands (0.200 to 2 mm). Sampling and sieving were carried out after the destruction of organic matter by hydrogen peroxide (H_2O_2) on a test sample of approximately 10 g. The final dispersion was carried out by a short ultrasonic passage after the addition of dispersant $[(\text{NaPO}_3)_6 + \text{Na}_2\text{CO}_3]$, and afterwards, the coarse sands ($> 0.200 \text{ mm}$) were separated by sieving. To illustrate this, the results have been grouped into 3 parts: clay, total silt, and total sand.

Soil microbial biomass

The application of the substrate-induced respiration technique (SIR) was applied to determine the total microbial biomass (Anderson, 1982). This requires recording the hourly CO_2 production rates from the soil samples, which had been initially spiked with glucose. From the pre-incubated soils, samples with a weight of 2 g were taken and placed into flasks (15 ml), where a solution of glucose (0.1 ml/g soil; the final glucose concentration was 10

mg/g) was added and flasks were sealed with a butyl/PTFE shield cap (VWR[®]). The CO₂ concentrations were analysed using micro gas chromatography (micro-GC 490, Agilent). The CO₂ evolution rate ($\mu\text{LCO}_2\text{-C g}^{-1}\text{ soil h}^{-1}$) at each sampling time was then calculated after subtracting the background CO₂ concentration. Our experiment was conducted at 22°C, which was the temperature prescribed in the original SIR method (Anderson and Domsch, 1978). The basal respiration rate was calculated as the hourly mean of the respiration rates over a 4 h period prior to the addition of glucose. The SIR rate was defined as the minimum respiration rate measured during the 24 h after the addition of glucose, in accordance with Anderson and Domsch (1978) (Anderson and Domsch, 1978). Using the SIR method, soil microbial biomass C (SIR-biomass) was calculated using the following equation from Anderson and Domsch (1978) (Anderson and Domsch, 1978):

$$\text{SIR-biomass C } (\mu\text{gC g}^{-1}\text{ soil}) = \text{SIR } (\mu\text{l CO}_2\text{ g}^{-1}\text{ soil h}^{-1}) \times 40.04 + 0.37 \quad (\text{Eq. 1})$$

2.3. Experimental setup

Fifty ml sterile hermetic glass plasma bottles were filled with 18 g of each soil sample.

The soil samples were then incubated according to 4 different treatments: (A) **70%** holding capacity at **28 °C**; (B) **70%** holding capacity at **38 °C**; (A) **100%** holding capacity at **28 °C**; and (D) **100%** holding capacity at **38 °C**.

Holding capacities were maintained with sterile ultra-pure water, and soil humidity was kept constant with sterile ultra-pure water. The microcosms were mixed with sterile spatulas, incubated for 34 days and sealed with butyl/PTFE shield cap (VWR[®]). Experiments were performed in 5 replicates for each soil sample for a total of 80 microcosms (4 sites * 5 replicates * 4 treatments). At days 6, 10, 17, 27 and 34, 4 g of the soil samples were collected and analysed with the following parameters: 3 enzyme assays; C and N content; soluble mercury.

2.3.1. Enzyme assays during incubation

Dehydrogenase activity (DHA) was determined according to Klein *et al.* (1971) (Klein *et al.*, 1971) using 0.5 g of soil sample and 2,3,5-triphenyltetrazolium chloride (TTC) as substrate. The colour intensity of the solution after 96 h of incubation at 28°C was determined by colorimetry at 405 nm (Genesys 10 μv Scanning, Thermo).

Urease activity (Ur) was determined according to Kandeler and Gerber (1988)(Kandeler and Gerber, 1988) using 0.5 g of soil sample and urea as substrate in a borate buffer. After indophenol reaction, colour intensity of the solution after 4 h of incubation at 37°C was determined colorimetrically at 660 nm (Genesys 10 μ v Scanning, Thermo).

Total microbial activity potential was measured through fluorescein diacetate (FDA) hydrolysis assay, which hydrolyse colourless FDA to release the coloured end product fluorescein(Taylor *et al.*, 2002). Soil samples were pre-incubated for 1 day at 25°C. Then, 100 μ l of soil solution (1:5 w/v) was mixed with 50 μ l of *Mac ILVAIN* buffered solution (pH of 7) and 50 μ l of 2 M FDA substrate solution; in contrast, controls received only the buffer. The soil was incubated for 2 h at 37°C on an orbital shaker and then centrifuged at 1500 rpm for 10 min. Then, 100 μ l of supernatant was mixed with 100 μ l of chilled (4°C) *Mac ILVAIN* buffered solution (pH of 7) to stop the reaction. The colour intensity of the solution was immediately determined colorimetrically at 490 nm.

2.3.2. C and N turnover in soil samples during incubation

Mineralised total carbon (C_{min}) was evaluated by measuring soil CO₂ respiration during the experimental set up. Every three days, the release of CO₂ was measured by micro gas chromatography (Agilent, Micro GC 490, PPQ column). The value of C_{min} was expressed as μ g-C CO₂. g⁻¹ of soil d⁻¹.

Mineralised nitrogen (N_{min}) was determined by measuring the production of mineral N (NH₄⁺ and NO₃⁻) during incubation. The NH₄⁺ and NO₃⁻ contents were measured at day 0 and day 30 by indophenol and dimethyl-2,6-phenol methods, respectively. For the measurement of NH₄⁺ and NO₃⁻, 1 g of soil sample (dry weight equivalent) was shaken with 7.5 ml of CaCl₂ (0.025 M) for 2 h. Filtration with a PES filter was performed after centrifugation for 10 min at 3000 rpm. The NH₄⁺ was measured with a spectrophotometer at 690 nm (Genesys 10 μ v Scanning, Thermo) after adding sodium hypochlorite and 4 drops of thymol/sodium nitroprussiate solution (ISO 7150-1). The NO₃⁻ was measured with a spectrophotometer at 493 nm (Genesys 10 μ v Scanning, Thermo) after adding sulfuric and phosphoric acid and 0.5 ml of dimethyl-2,6-phenol (DIN 38405-9). The net ammonification and nitrification rates were calculated as the difference in N-NH₄⁺ and N-NO₃⁻ contents before and after incubation (i.e., day 0 and day 30). The mineralisation rate of total organic

N was estimated by summing the ammonification and nitrification rates. The N_{\min} value was expressed as $\mu\text{g-N} \cdot \text{g}^{-1}$ of soil d^{-1} .

2.3.3. Soluble mercury analysis

Soluble mercury was estimated according to Rasmussen *et al* (2000)(Rasmussen *et al.*, 2000). Briefly, 1 g of each soil replicate was suspended in 10 ml of ultrapure water and agitated at 300 rpm for 30 min. The suspensions were then centrifuged at 4000 rpm, and the supernatants were filtered at 0.45 μm with Teflon filters (Minisart SRP 25, Sartorius). Then, 200 μl of extracted supernatants were analysed for mercury content with AMA 254. All liquid samples were previously filtered (0.45 μm Teflon filters, Minisart SRP 25, Sartorius) and acidified to a pH of 1 (HCl, 37% Suprapur).

2.4. Statistical analysis

To determine both the effect of vegetation cover and the effect of the experimental treatments on biogeochemical cycles, parametric tests were performed. Normality of the data distributions and equal variance between treatments were tested using the Shapiro test and Bartlett's test, respectively. To study the interactions between the factors, we used a two-way ANOVA on day 10 and day 34, taking into account the "modalities" factor and the "treatment" factor rather than integrating incubation time as a third factor. The choice of day 10 was motivated by significant changes in the variables at day 10, and the choice of day 34 was motivated by the stabilization of experimental data at the end of incubation. Tukey's HSD multiple comparison procedure was used to test for differences throughout the experiment at specific measurement points.

To analyse the effect of the different rehabilitation processes and experimental treatments on biogeochemical data (C and N mineralization rate, enzyme activities and soluble mercury), a between-group multivariate analysis was performed for each factor (sites, treatments and interaction of sites/treatments), which provided the best linear combination of variables and maximized between-group variance(Baty *et al.*, 2006). Principal component analysis (PCA) was performed to identify the best linear combination of sub-variables describing the different sites (spontaneous vegetation, Acacia, biculture, control site) or different treatments (A, B, C and D), quantifying their respective effect on soil chemical and biological properties. The significance of each explanatory variable was determined using a

Monte-Carlo permutation test. A between-group analysis was also performed to assess the effects of rehabilitation processes or treatments using correspondence analysis (CA).

R software was used for all statistical analyses (R version 3.3.2 (2016-10-31)).

2.5. Quality assurance and control (QA/QC)

To avoid contamination, all materials used in this study were acid-washed twice with HNO₃ (5%) and then rinsed several times with Milli-Q water before use.

Concerning mercury assays in samples, the relative error was routinely $\pm 5\%$ and was always under $\pm 10\%$. The detection limit (defined as three times the standard deviation (SD) of the blank) was $0.005 \mu\text{g g}^{-1}$. Concentrations obtained for repeated analyses of certified reference materials never exceeded the published range of concentrations (i.e., $0.128 \pm 0.017 \mu\text{g g}^{-1}$ and $0.091 \pm 0.009 \mu\text{g g}^{-1}$ for BCR-277R and MESS-3, respectively).

3. Results

3.1. Soil physical and chemical properties of the 4 sites

The initial soil characteristics of the studied sites are summarized in **Table 1**.

Using a texture triangle, the results for the granulometry of the Sp site showed a silty-clay texture with approximately 32% clay and 40% silt. The Aca and Mf sites had the same texture, with a dominance of sand followed by silt. These results were different from the texture of the control site, Fc, which was approximately 78% clay.

Soil pH-H₂O and pH-KCL measurements indicated that sites with tree cover (Aca, Mf and Fc sites) had a more acidic pH than the non-restored Sp site. These values were consistent with those for natural Oxisols or hydromorphic soils (Da Silva *et al.*, 2016; Harris-Hellal *et al.*, 2011).

Total carbon, nitrogen and phosphorus contents were always significantly highest in the control site, Fc. These values were consistent with the natural content found in French Guiana natural soils (Guedron *et al.*, 2009; Guédron *et al.*, 2006; Harris-Hellal *et al.*, 2011). For the two revegetated sites, the Mf site had higher levels of macro-elements (C, N, and P) than the Aca site. Total carbon content was 27.4 g.kg^{-1} for the Mf site and 19.5 g.kg^{-1} for the Aca site. Total nitrogen content was 2.3 g.kg^{-1} for the P site and 1.5 g.kg^{-1} for the Aca site. Total phosphorus content was 0.76 g.kg^{-1} for the P site and 0.37 g.kg^{-1} for the Aca site. Total

carbon, nitrogen and phosphorus contents for the Sp site were low compared to natural soils.

The total Fe, Al and Hg contents showed no major differences between the three old mining sites. The values for Fe content were consistent with the natural content in Oxisols (Da Silva *et al.*, 2016; Harris-Hellal *et al.*, 2011, 2009), but the Al concentrations were higher. Mercury levels for Sp were significantly lower than for the restored Aca and Mf sites. These concentrations were still low compared to the gold-mined soil in French Guiana (Guedron *et al.*, 2009) but remained within the normal range of mercury measurements in natural soils (Guedron *et al.*, 2009).

The soil microbial biomass carbon (MBC) in the Fc site (2164,7 mg kg⁻¹) was approximately twice as high as the MBC in the Aca and Mf sites, with values of 909 and 1103 mg kg⁻¹, respectively. The soil MBC in the spontaneous vegetation site was significantly lower than all other sites, with a value of 224.5 mg kg⁻¹.

Table 1:

C_{tot}, N_{tot}, P_{tot} : Total C, N and P ; TOC : Total Organic Carbon ; MBC : Microbial biomass carbon; Total Fe, Al, Hg : Total Iron, Aluminum and Mercury content, (n=5, mean ± SD). For each parameter, values followed by different letters differ significantly with P < 0.05 with Tukey HSD test.

Sites						pH		Total					
	C _{tot} g.kg ⁻¹	TOC g.kg ⁻¹	MBC mg.kg ⁻¹	N _{tot} g.kg ⁻¹	P _{tot} g.kg ⁻¹	pH-H ₂ O	pH-KCL	Fe g.kg ⁻¹	Al g.kg ⁻¹	Hg μg.kg ⁻¹	Clay %	Silt %	Sand %
Sp	6.01 ±0.32	3.88 ±0.04	223 ±10.8	0.40 ±0.03	0.21 ±0.04	5.26 ±0.23	4.5 ±0.11	65.15 ±3.17	53.88 ±1.53	0.23 ±0.01	46.4 ±3.6	41.5 ±2.8	3.3 ±0.2
Aca	14.11 ±1.2	10.55 ±0.62	944 ±79	1.12 ±0.07	0.37 ±0.12	4.21 ±0.07	3.74 ±0.26	53.69 ±4.15	45.31 ±6.51	0.48 ±0.04	18.4 ±2.5	35.6 ±3.9	41.6 ±4.4
Mf	22.88 ±1.5	15.58 ±1.41	1103 ±41	1.81 ±0.10	0.76 ±0.15	4.66 ±0.11	3.88 ±0.45	71.02 ±1.37	43.76 ±1.21	0.41 ±0.05	19.8 ±3.8	32.4 ±4.9	36.4 ±5.9
Fc	54 ±2.23	38.8 ±1.49	2142 ±81	3.9 ±0.07	1.2 ±0.05	4.01 ±0.04	3.7 ±0.08	130.1 ±10.6	53.8 ±3.05	0.45 ±0.02	78.2 ±0.9	7.6 ±0.8	14.2 ±1.3

3.2. Biogeochemical processes during soil mesocosm studies

In this study, we simulated climatic variations using 2 incubation temperatures and 2 soil moisture levels for a total of 4 treatments. Samples from various rehabilitated mining sites in French Guiana were incubated under anaerobic conditions for 34 days, and different parameters related to microbial activity were monitored during the experiment. The results

were analysed using a two-way ANOVA to summarize the effect of the treatments on days 10 and 34 of the experiment.

The two-way ANOVA (**Table 2**) showed a significant effect of vegetation cover ($p < 0.05$) for all experimental variables for day 10 and day 34. The treatment effect was not homogeneous, and there was no significant effect ($p > 0.05$) of the different incubation modalities on nitrification on day 10 and on mercury solubilization on days 10 and 34. Site and treatment interactions were not significant ($p > 0.05$) on day 10 for pH, nitrate, or ammonium and were not significant for the nitrate data alone on day 34.

Table 2:

Effects of vegetation and incubation treatment (A, B, C, D) on soil pH, soil respiration, soil nitrification, soil ammonification, soil enzyme activities and mercury solubilization for three rehabilitated mining sites and one forest control site in a mesocosm experiment in a two-way ANOVA.

		DF	pH	Soil respiration (CO ₂)	Nitrification (NO ₃ ⁻)	Ammonification (NH ₄ ⁺)	Urease activity	DH activity	Global activity	Mercury solubilization
			P	P	P	P	P	P	P	P
Day 10	Sites	3	8.1e-06 ***	2e-16 ***	2e-16 ***	2e-16 ***	2e-16 ***	2e-16 ***	2e-16 ***	3.4e-0***
	Treatment	3	1.5e-05 ***	8.6e-13 ***	0.47	0.009 **	2e-16 ***	2.2e-09 ***	2e-16 ***	0.55
	Sites*Treatment	9	0.13	2.3e-06 ***	0.59	0.086	9.9e-14 ***	2e-16 ***	<2e-16 ***	0.01 *
	Residuals	64								
Day 34	Sites	3	0.0006 ***	2e-16 ***	2e-16 ***	2e-16 ***	2e-16 ***	2e-16 ***	2e-16 ***	2.7e-1 ***
	Treatment	3	1.5e-06 ***	1.2e-07 ***	9.8e-06 ***	4.9e-08 ***	2.3e-12 ***	0.024 *	2e-16 ***	0.44
	Sites*Treatment	9	0.0002 ***	8.5e-09 ***	0.001 **	6.7e-13 ***	2.0e-12 ***	0.001 ***	2e-16 ***	0.01 *
	Residuals	64								

3.2.1. Changes in C and N content and rates of mineralization

Soil respiration measurements (Figure 1) showed the same trends for the different treatments. The Fc control site always had the strongest respiration measurements, and the Sp site was significantly weaker than the other sites. The soil respiration measurement for the Mf site was higher than the Aca site in treatment A, but the differences were not significant in the other treatments. There was no treatment effect for Sp and Fc sites. Respiration for the Aca site was significantly lower in treatment A, whereas respiration was highest in treatment A for the Mf site.

Measurements of nitrate production (Figure 2) showed different trends. Nitrate levels for site Fc had two trends. The first trend (treatments A and B 28 °C) showed a strong increase in nitrate content in the first 10 days, whereas for treatments C and D, the levels changed less rapidly. For the Mf site, treatments A and C were similar, with an increase in nitrate content from day 10 onwards. Nitrate levels for the Aca site did not change significantly with treatment and remained below Mf values. For the Sp site, nitrate values were low and did not change during the experiment.

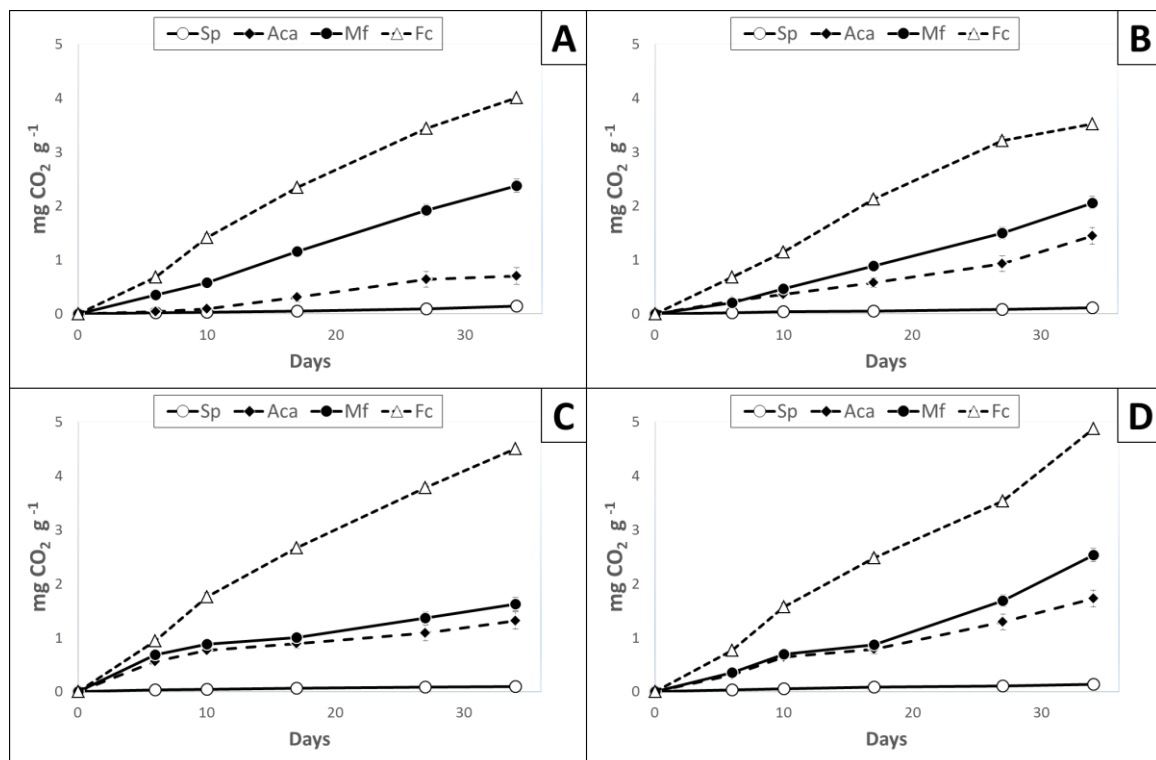

Figure 1:

Soil respiration during 34 days of incubation in the four sites, (A) Treatment 28°C and 70% WHC, (B) Treatment 28°C and 100% WHC, (C) Treatment 38°C and 70% WHC, (D) Treatment 38°C and 100% WHC.

Ammonium production measurements (Figure 3) were higher for the Fc site than for the Aca and Mf sites, and the A and C treatments significantly favoured the production of ammonium at the end of the experiment. Regarding the rehabilitated sites, no difference was observed for the Mf and Aca sites during treatments A and B, whereas treatment C favoured the production of ammonium for the Mf site, and treatment D influenced the quantity of ammonium produced at the end of the experiment for the Aca site. Although concentrations were low for the Sp site, the results showed an influence of the treatments

on ammonium production, especially during the A treatment, which favoured production during the first week of incubation.

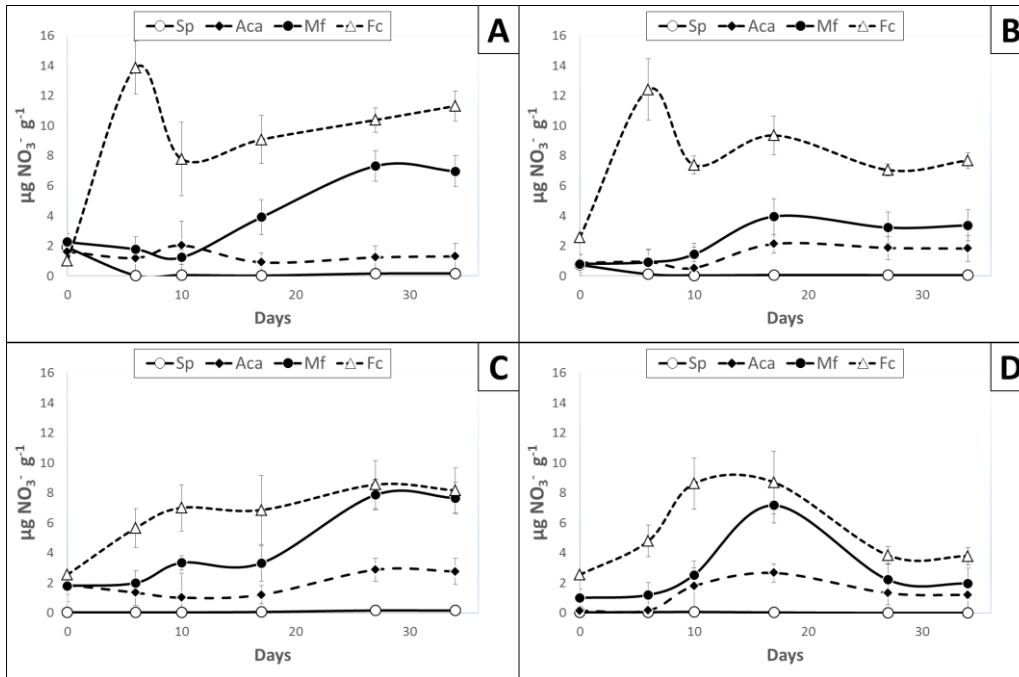

Figure 2:

Change in nitrate concentrations during 34 days of incubation in the four sites, (A) Treatment 28°C and 70% WHC, (B) Treatment 28°C and 100% WHC, (C) Treatment 38°C and 70% WHC, (D) Treatment 38°C and 100% WHC.

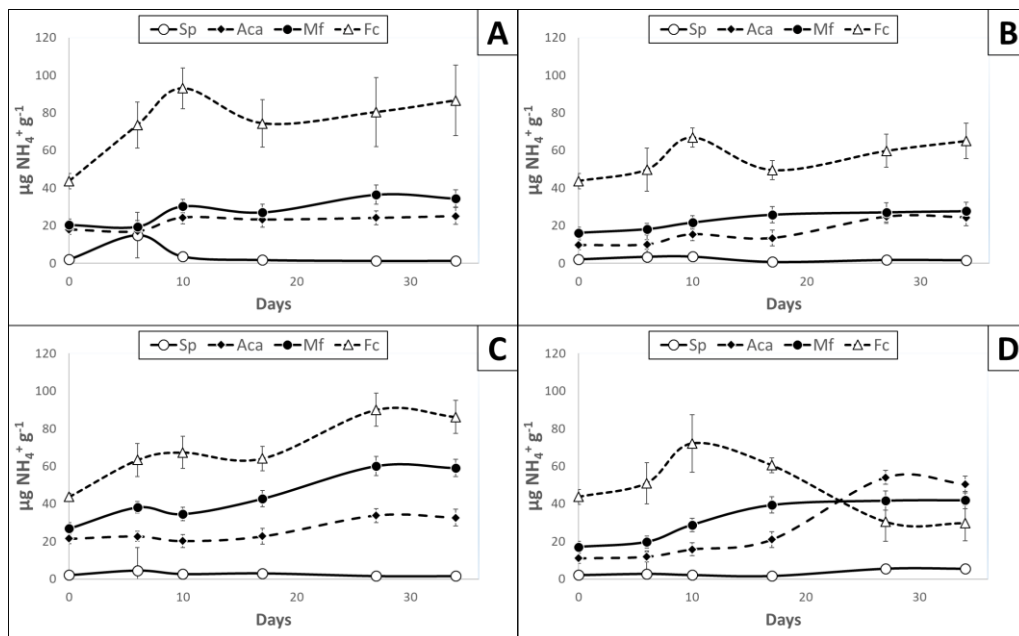

Figure 3:

Change in ammonium concentrations during 34 days of incubation in the four sites, (A) Treatment 28°C and 70% WHC, (B) Treatment 28°C and 100% WHC, (C) Treatment 38°C and 70% WHC, (D) Treatment 38°C and 100% WHC.

3.2.2. Evolution of soil enzyme activities

Urease activity (Figure 4) was strongly impacted by incubation conditions. In the 100% WHC, B and D treatments, there was a strong inhibition of urease activity at the Fc, Aca and Mf sites. In treatment A, urease activity of the rehabilitated sites, Aca and Mf, was homogeneous and remained lower than the Fc site. There was no significant difference between the results of the A and C treatments for the Aca and Fc sites, whereas the C treatment favoured urease activity for the Mf site. Again, the Sp site data were significantly lower than the revegetated sites, and there was no influence of different treatments on urease activity for the spontaneous vegetation site.

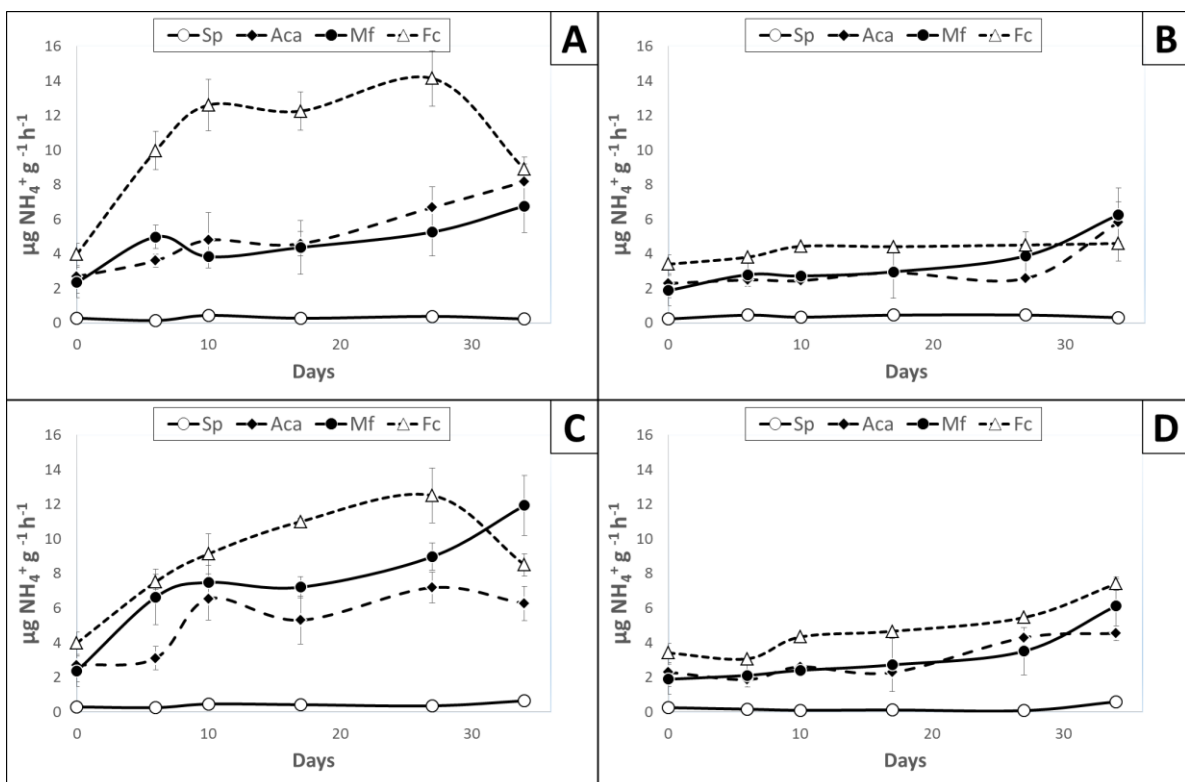

Figure 4:

Change in urease activities during 34 days of incubation in the four sites, (A) Treatment 28°C and 70% WHC, (B) Treatment 28°C and 100% WHC, (C) Treatment 38°C and 70% WHC, (D) Treatment 38°C and 100% WHC.

Dehydrogenase activity (Figure 5) showed a treatment effect only for the Fc site, with a decrease in peak activity on day 17 for the B and D treatments. The dehydrogenase activity of the forest site, Fc, was significantly higher than that of the three former mining sites, and for each treatment, an increase in enzymatic activity was observed on day 17. For site Mf, activity increased in the first few days of the experiment and then decreased to the level of Sp values. For the Aca site, dehydrogenase activity was low until day 10 and then increased

significantly until the end of the experiment. Dehydrogenase activity for the Sp site was constant between treatments but remained very low throughout the experiment.

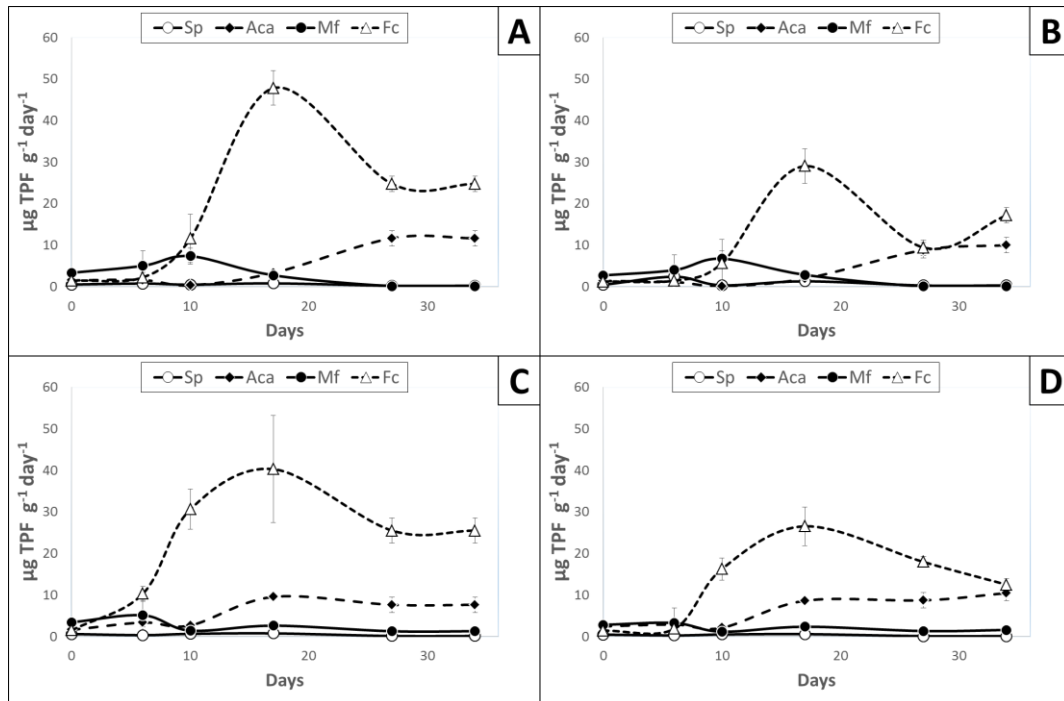

Figure 5:

Change in dehydrogenase activities during 34 days of incubation in the four sites, (A) Treatment 28°C and 70% WHC, (B) Treatment 28°C and 100% WHC, (C) Treatment 38°C and 70% WHC, (D) Treatment 38°C and 100% WHC

Overall microbial activity (Figure 6) showed mixed results between the different study sites. The control site, Fc, had significantly higher FDA activity than the other sites but was variable between treatments, particularly for A treatment, which showed the highest activity. Regardless of the experimental treatments, the Aca and Mf sites had the same overall microbial activities, with a decrease in activity in treatment D for both sites.

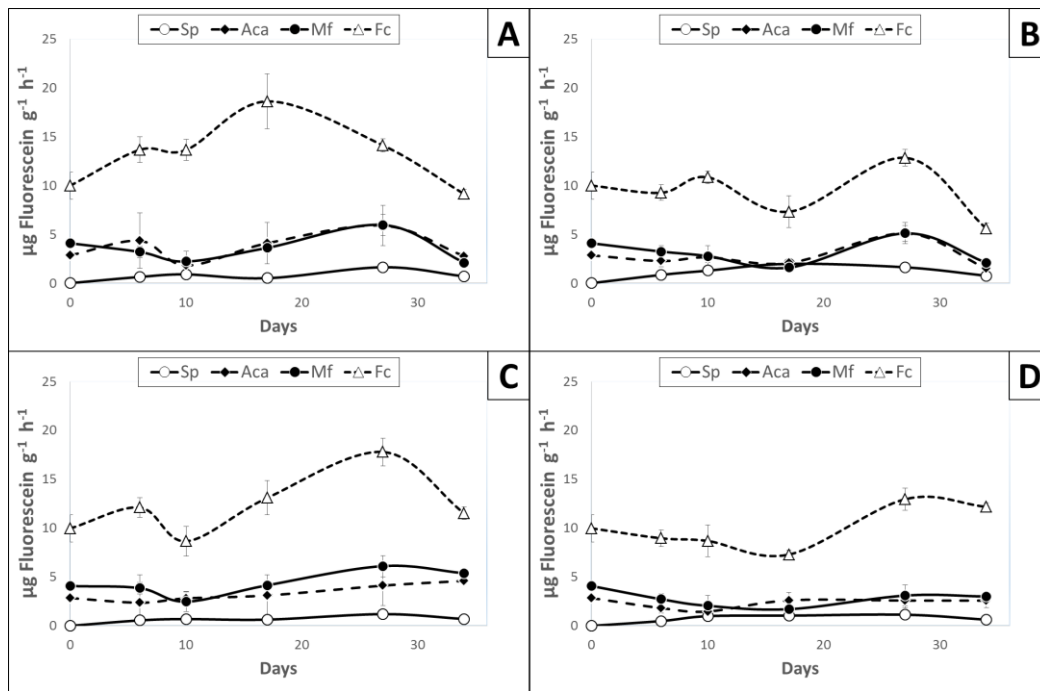

Figure 6:

Change in global enzymes activities during 34 days of incubation in the four sites, (A) Treatment 28°C and 70% WHC, (B) Treatment 28°C and 100% WHC, (C) Treatment 38°C and 70% WHC, (D) Treatment 38°C and 100% WHC.

3.3.3. Evolution of soluble mercury content

Soluble mercury levels (Figure 7) increased rapidly in the first two weeks before stabilizing at the end of the experiment, but mercury levels for the Aca and Mf sites stabilized after 20 days in the D treatment. For all treatments, the rehabilitated Aca and Mf sites had the highest mercury solubilization, particularly in treatment D while treatment C showed limited solubilization for the Mf site. In contrast, the Sp and Fc sites had relatively homogeneous and significantly lower levels of soluble mercury in treatments A, B and D, while treatment C appeared to promote an increase in mercury solubilization.

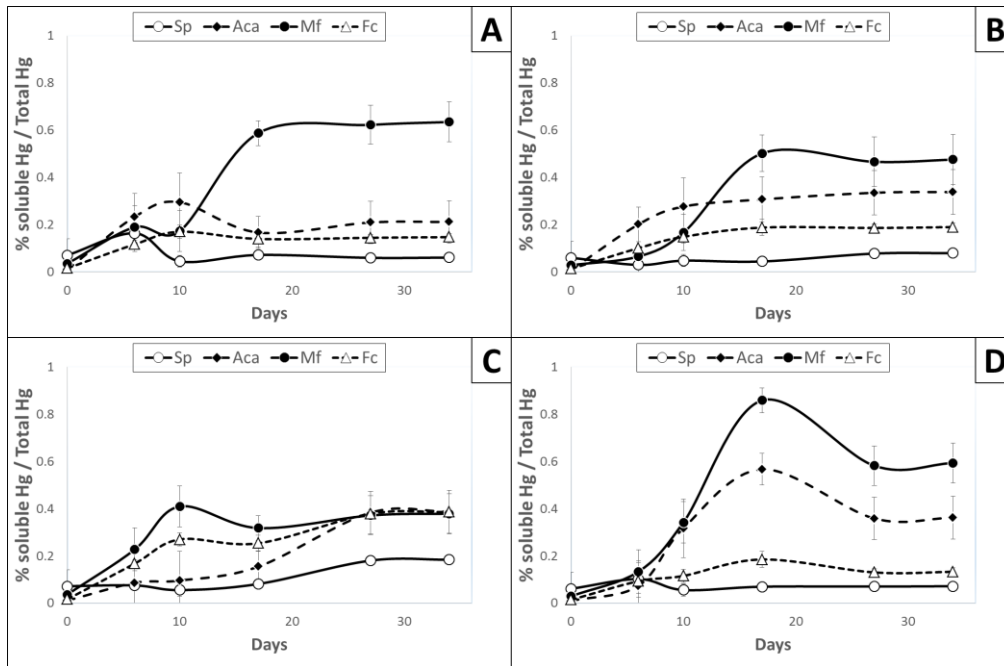

Figure 7:

Change in soluble mercury concentrations during 34 days of incubation in the four sites, (A) Treatment 28°C and 70% WHC, (B) Treatment 28°C and 100% WHC, (C) Treatment 38°C and 70% WHC, (D) Treatment 38°C and 100% WHC.

3.3. Between-group analyses of experimental variables

3.3.1. Effect of rehabilitation processes on biogeochemical cycles

Between-group analyses performed on biogeochemical cycles with the type of rehabilitation as the explanatory variable accounted for 59.13% of the total variance (**Figure 8**). Axes 1 and 2 accounted for 84.71% and 12.6% of the variance, respectively. Seven variables contributed to the axis 1, one on the negative side (pH measurements) and six on the positive side (C and N mineralization data, enzyme data). Carbon and nitrogen data (three variables) contributed more significantly to the formation of axis 1 than the enzyme data. Axis 1 discriminated soil along chemical quality. The Sp and Aca sites were on the negative side, and the Mf and Fc sites were on the positive side. Only one variable on the positive side (soluble mercury) contributed to the formation of axis 2 and discriminated soil along mercury availability. The spontaneous vegetation and control sites were on the negative side, and the two rehabilitated sites were on the positive side. A Monte-Carlo permutation test showed that the type of vegetation and rehabilitation protocol was significantly related to the variables measured during the experiment (**p = 0.001**).

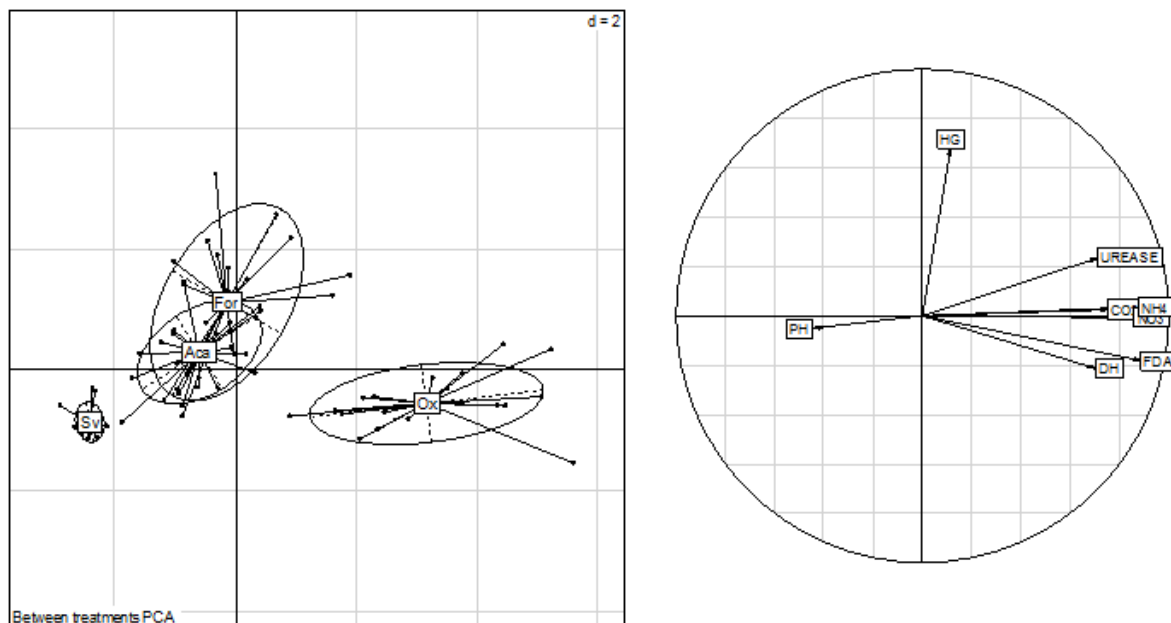

Figure 8:

Between-group analysis on the data monitored during the experiment with types of vegetation cover. left: projection of data set variability plotted on a factorial map of the first two discriminating axis according to respective factor. Labels on the gravity center correspond to sub-factor of respective factor. right: correlation circles plot with variable vectors (pH, CO₂, N₀₃, NH₄, UREASE, DH, FDA, HG) for each respective factor. Types of vegetation cover: Sp. Spontaneous vegetation, Aca. Monoculture of *A. mangium*, Mf: Mixed fabaceous culture, Fc. Forest control site. Eigen values 84.71%, 12.6% for axes 1 to 2 respectively. Randtest: simulated p-value: 0.001. Explained variance: 59.13%.

3.3.2. Effect of experimental treatments on biogeochemical cycles

Between-group analyses performed on biogeochemical changes during the experiment with the type of rehabilitation as the explanatory variable accounted for 14.36% of the total variance (**Figure 9**). Axes 1 and 2 accounted for 90.3% and 9.1% of the variance, respectively. Six variables contributed to the formation of axis 1, one on the negative side (pH measurements) and 5 on the positive side (N mineralization data, enzyme data). Urease activity contributed significantly more to the formation of axis 1 than other enzyme data. Axis 1 discriminated treatments along chemical quality. Treatments B and D were on the negative side, and treatments A and C were on the positive side. Two variables on the negative side (soluble mercury and CO₂ content) contributed to the formation of axis 2 and discriminated treatments along mercury availability and soil respiration. Treatments C and D were on the negative side, and treatments A and B were on the positive side. A Monte-Carlo permutation test showed that the type of vegetation and rehabilitation was significantly related to the variables measured during the experiment (**p = 0.042**).

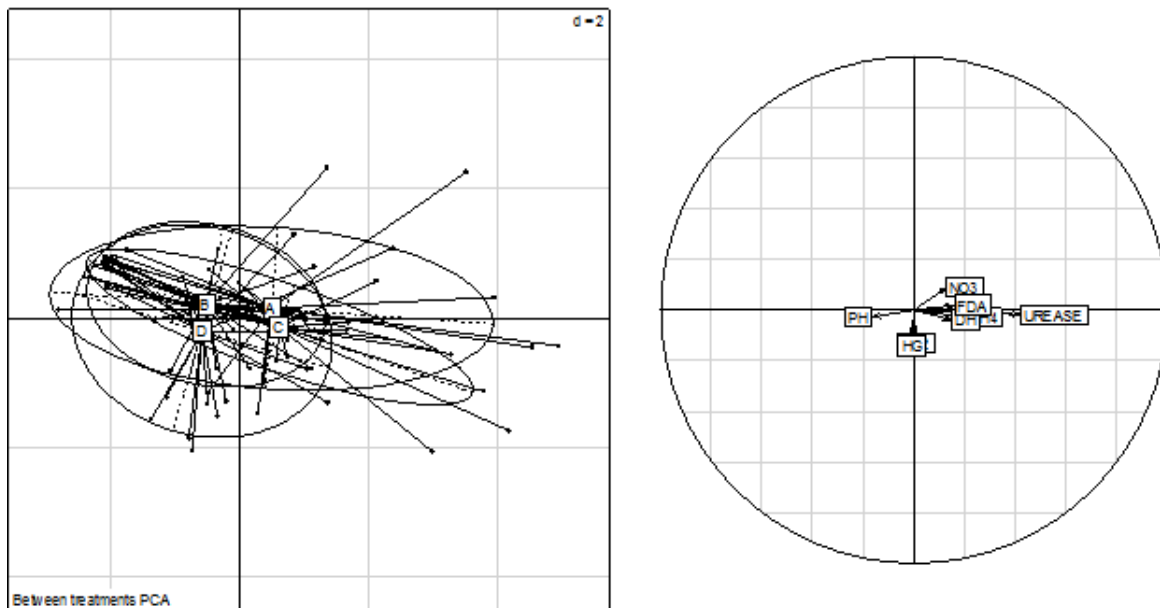

Figure 9:

Between-group analysis on the data monitored during the experiment with types of vegetation cover. left: projection of data set variability plotted on a factorial map of the first two discriminating axis according to respective factor. Labels on the gravity center correspond to sub-factor of respective factor. right: correlation circles plot with variable vectors (pH, CO₂, N₀₃, NH₄, UREASE, DH, FDA, HG) for each respective factor. Types of vegetation cover: Sp. Spontaneous vegetation, Aca. Monoculture of *A.mangium* , Mf: Mixed fabaceous culture, Fc. Forest control site. Eigen values 90.3%, 9.1% for axes 1 to 2 respectively. Randtest: simulated p-value: 0.042. Explained variance: 14.36%.

3.3.3. Interaction of rehabilitation processes and treatments on biogeochemical cycles

Between-group analyses performed on biogeochemical changes during the experiment with the type of rehabilitation/experimental treatment interaction as the explanatory variable accounted for 70.98% of the total variance (**Figure 10**). Axes 1 and 2 accounted for 78.3% and 11.6% of the variance, respectively. Seven variables contributed to the formation of axis 1, one on the negative side (pH measurements) and six on the positive side (C and N mineralization data, enzyme data). Carbon and nitrogen data (three variables) contributed more significantly to the formation of axis 1 than enzyme data. Axis 1 discriminated soil and treatments along chemical quality. For the control site, treatments A and C were on the positive side and were close, and treatments B and D were also close. On axis 1, the two rehabilitated soil (Aca and P) were very close, but only site P-Treatment C was on the positive side. There was little variability within the different treatments for the S site. Only one variable on the negative side (soluble mercury) contributed to the formation of axis 2 and mainly discriminated soils and treatments based on soluble mercury content, with spontaneous vegetation and control sites on the positive side and the two rehabilitated sites

on the negative side. For the P site, treatments A and D were mostly discriminated by soluble mercury levels. A Monte-Carlo permutation test showed that the type of vegetation and rehabilitation was significantly related to the variables measured during the experiment ($p = 0.001$).

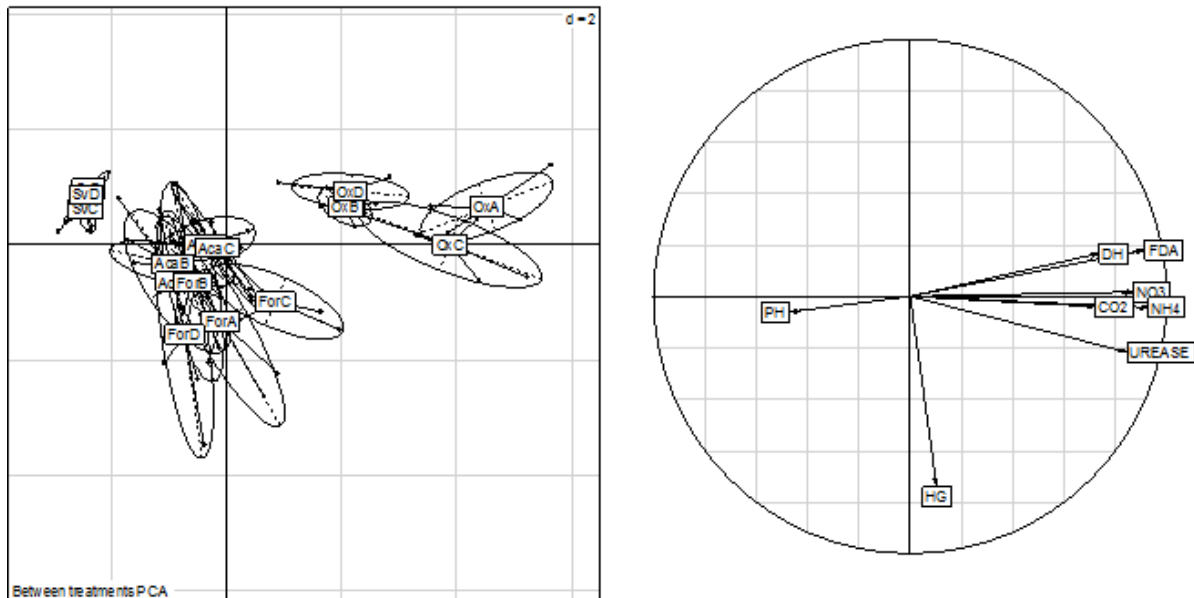

Figure 10:

Between-group analysis on the data monitored during the experiment with types of vegetation cover. left: projection of data set variability plotted on a factorial map of the first two discriminating axis according to respective factor. Labels on the gravity center correspond to sub-factor of respective factor. right: correlation circles plot with variable vectors (pH, CO₂, NO₃, NH₄, UREASE, DH, FDA, HG) for each respective factor. Types of vegetation cover: Sp. Spontaneous vegetation, Aca. Monoculture of *A.mangium* , Mf: Mixed fabaceous culture, Fc. Forest control site. Eigen values 78.3%, 11.6% for axes 1 to 2 respectively. Randtest: simulated p-value: 0.001. Explained variance : 70.98%.

4. Discussion

The purpose of this study was to evaluate the effect of humidity and temperature on the biological activities of different reclaimed mining sites using mesocosms by simulating the effect of observed seasons on the study sites. Parameters related to the carbon, nitrogen and mercury cycles were measured over a 34-day period with 4 experimental treatments (combination of 2 temperatures (28 °C, 38 °C) and 2 humidity levels (70% and 100% holding capacity)). The three former mining sites were at different stages of ecological restoration. The Sp site was covered with spontaneous herbaceous vegetation, the Aca site was a monoculture of *Acacia mangium* and the Mf site was a biculture of *Clitoria racemosa* and

Acacia mangium. A natural forest site served as a positive control and was used to estimate the ability to return to equilibrium and the quality of ecological rehabilitation.

4.1. Effect of different rehabilitation processes on soil properties

In French Guiana, the ecological rehabilitation of mining sites and their monitoring was relatively recent compared to the gold panning history. For the past 20 years, the protocols put in place had been chosen mainly based on their capacity to cover rehabilitated sites within a few years. Among the many plant species capable of growing on highly anthropized mining plots, fabaceous species have been widely used in French Guiana (Loubry, 2002). Their ability to fix atmospheric nitrogen through rhizospheric symbiosis made these species very competitive (Butterfield, 1996; Norisada *et al.*, 2005). *Acacia mangium* was among the most effective, and its ability to restore the soil's organic matter stock has been demonstrated in previous studies (Hulugalle, 1992; Lamb and Lawrence, 1993). The results in Table 1 show the contribution of a monoculture of Acacia (Aca) to the recovery of stocks in major macroelements (i.e., C, N, and P) compared to spontaneous vegetation cover (Sp). On the Sp plots, the return of vegetation was still blocked after more than 15 years of rehabilitation, and the microbial biomass was very low. Given the similar trace element and particle size contents in the Sp and Aca plots, it would appear that CNP content after mining was limiting and prevented the return of natural vegetation cover (Couic *et al.*, 2018). While *Acacia mangium* showed very encouraging results in the improvement of the chemical quality of the ground, this fabaceous species is not native to French Guiana, and rehabilitation programmes have favoured other species such as *Clitoria racemosa*. Several studies have shown that the fabaceous species used for ecological restoration provide the soil with a stock of organic matter of variable quality. Cattanio *et al.* (2014) showed that *Clitoria racemosa* litter was more rapidly mineralized than *Acacia mangium* litter. Other studies (Jaquetti *et al.*, 2016; Siddique *et al.*, 2008) have also shown that the productivity of fabaceous plants under ecological restoration conditions is not always indicative of the quality of organic matter and therefore of the stimulation of microorganisms responsible for the main biogeochemical cycles. Our results showed that the combination of *A. mangium* and *C. racemosa* allowed for a significant improvement in C, N, P, and TOC levels compared to an Acacia monoculture alone. Increasing biodiversity made it possible to encourage the development of new microbial communities involved in biogeochemical cycles of macroelements (Fierer *et al.*, 2009), thus encouraging the turnover

of organic matter. The soil texture of the Aca and Mf sites was similar; the differences in chemical quality observed could therefore be exclusively linked to the nature of the vegetation cover and its associated microorganisms. The establishment of fabaceous species, particularly in polyculture, seems to be suitable for the restoration of mining sites (Couic *et al.*, 2018; Loubry, 2002). Nevertheless, the chemical quality achieved after 18 years of restoration is not yet at the level of the natural forest site, Fc, which had approximately twice as much C_{tot} , TOC, N, P and MBC (Table 1). While some studies have shown that there is an effective return of soil quality after approximately ten years of ecological restoration, the quality generally remains below the quality of natural control soils (Hou *et al.*, 2018; Siddique *et al.*, 2008; Singh *et al.*, 2004; Valentim dos Santos *et al.*, 2016). In this study, it would seem that crops of fabaceous species alone were not efficient enough at replenishing the soil's natural organic matter stock. It could also be that 18 years of restoration was not enough to fully recover the chemical quality, biological quality and microbial functional diversity of natural soil.

4.2 Effect of rehabilitation processes on biogeochemical cycles

The large differences observed in monitoring the C, N, and Hg cycle data along with the results of the between-group analysis (Figure 9) indicated a significant effect of plant restoration. Similar results have also been demonstrated in other studies at rehabilitated sites, which may confirm the importance of revegetation for the recovery of soil microbiological activity (Couic *et al.*, 2018; Giai and Boerner, 2007; Hu *et al.*, 2016; Jia *et al.*, 2017; Ma *et al.*, 2017; Schimann *et al.*, 2012a).

The Aca and Mf sites showed high primary productivity compared to the Sp site, which contributed to an increase in the soil microbial biomass by a factor of almost 20 (Table 1) (Fierer *et al.*, 2009).

An increase in vegetation cover at the Aca and Mf sites, and in particular, the presence of plant residues (litter and root exudates), bring organic matter, organic carbon and nitrogen to the soil, which will be used in microbial processes (Cao *et al.*, 2008; Kaur *et al.*, 2002; Miao *et al.*, 2015). Organic matter supports soil water retention and the bioavailability of nutrients, which also contributes to improving microbiological activity and soil enzyme activities (Melero *et al.*, 2007).

The results showed a positive effect of ecological restoration on C and N cycles by fabaceous species compared to spontaneous vegetation, though the impact of polyculture (Mf)

compared to monoculture seemed to contrast more. The combination of *C. racemosa* and *A. mangium* seemed to favour soil respiration during incubation at 28 °C and nitrate and ammonium production at 38 °C compared to the Aca site. As Schimann *et al.*, (2012) pointed out, at Guiana mining sites, the differences in nitrogen cycle functionalities between the Aca and Mf sites could mean a change in the diversity of microorganisms in this cycle, linking it to the level of vegetation stratification. Despite a significantly lower microbial biomass for the Aca site ($p=0.005$), dehydrogenase activity was higher for the Aca site, and urease and overall (FDA) activities were similar between the two rehabilitated plots. Measurements of dehydrogenase activities, which were very low for the Mf site, would therefore not always be relevant for assessing the contribution of ecological restoration to the functionalities of the carbon cycle but highlight the degraded aspect of the rehabilitated sites (Kumar *et al.*, 2013). Enzyme activities were generally associated and mediated by the abundance and diversity of microbial biomass and were therefore relevant bio-indicators for the study of anthropized sites, but it would appear from our results that these activities were not solely related to soil microbial biomass (Badiane *et al.*, 2001).

A molecular characterization of the microorganisms could show us whether the higher biomass at the Mf site induced higher genetic and functional diversity than at the Aca site, which we would not have demonstrated with the three enzymatic activities measured.

Microbial activities related to the C and N cycles for the Sp site were very low and potentially worrying. Eighteen years after mine site rehabilitation, microbial resilience appeared limited and blocked. The microbial biomass was almost 40 times less than the natural Fc site, soil respiration was almost zero and nitrification processes, one of the key functions of nitrogen cycle regulation (Parton *et al.*, 2007; Swift *et al.*, 1998), were very weak. Although these processes are sensitive to soil pollution, particularly from trace metal elements (Broos *et al.*, 2005; Xu *et al.*, 2009b; Xu and Chen, 2006), their very low level at the Sp site would mainly be related to microbial biomass content rather than to concentrations of toxic elements such as mercury. Indeed, similar results were observed in a previous study at former Guiana mining sites, where speciation measurements of toxic elements showed low mobility and potential toxicity of mercury and arsenic (Couic *et al.*, 2018).

Without an ecological restoration protocol, the degradation of the physico-chemical quality of mining soils during exploitation was too great to give way to new, natural vegetation cover within a few years.

In the same way that ecological restoration with fabaceous species did not make it possible to recover the C and N stocks of a natural site, biogeochemical activities linked to soil quality were also not recovered. These results suggest the importance of making ecological restoration more complete with greater plant diversity.

4.3 Influence of temperature and soil moisture on biogeochemical cycles

Soil temperature and moisture were key factors responsible for microbial and biochemical soil properties (Giacometti *et al.*, 2013; Subke and Bahn, 2010). According to the literature, soil respiration, one of the most relevant microbial activities for bioindication (Jordan *et al.*, 1995), depended more strongly on moisture than on temperature (Hui and Luo, 2004; RAICH and SCHLESINGER, 1992; Silva *et al.*, 2008). While moisture is essential for maintaining the catalytic activity of soil enzymes (Jiang, 2002), excessive moisture has been shown to limit microbial biomass and enzyme activity by creating anaerobic conditions that limit the breathing activities of soil microbes and the synthesis and degradation of organic matter (Borowik and Wyszowska, 2016; Landesman and Dighton, 2010). An increase in soil temperature also impacts biogeochemical cycles by limiting and disrupting soil homeostasis (Kim *et al.*, 2008).

The results obtained by between-group analysis with the different treatments (Figure 9) explained only 14% of the variability of the experimental data. Although the analysis was significant, the effect of the different treatments on biogeochemical cycles appeared to be relatively small overall. Nevertheless, the between-group analysis carried out by dissociating the different sites and the different treatments (Figure 10) explained more than 70% of the variability and was very significant ($p < 0.001$), more than the between-group analysis of sites alone.

In our laboratory study, the effects of humidity and temperature were not evident for biological activities at the Sp site. However, the lack of an effect was probably related to low microbial biomass and therefore to almost non-existent biogeochemical activities.

The natural forest site, Fc, was the site most affected by the different treatments. While soil respiration for the Fc site was not significantly affected by moisture differences, incubation at 38 °C promotes respiratory activity, and nitrification is promoted at 28 °C. The differences in respiratory activities did not seem to play an important role in enzymatic activities since the three measured activities (DH, urease, and FDA) were not affected by temperature but

were inhibited by a soil moisture increase. The variations in enzymatic activity with different treatments also means that the differences observed were related to microbial intracellular enzymes. The Fc site was relatively well drained during the year, and nearly anaerobic conditions with an increase in humidity seem to strongly affect the three enzymatic activities. Excess water in the soil environment due to periodic flooding or heavy rain events, conditions that may be encountered at alluvial mining sites due to their topography, was particularly threatening for aerobic bacteria(Walker, 2003).

For the two rehabilitated sites, Aca and Mf, the influence of the treatments on biogeochemical cycles was not similar, which could confirm that vegetation cover modifies the properties of the microbial communities of the rehabilitated soils. The highest soil respiration in treatment A for the Mf site was consistent with other studies that showed maximum heterotrophic activity at intermediate humidity levels and average temperatures(Zhou *et al.*, 2014). However, for the Aca site, treatment A induced a significant decrease in soil respiration, whereas high humidity, and therefore oxygen limitation, caused an increase in soil respiration. These conditions could favour the activities of anaerobic communities, such as denitrifying communities. Variations in soil respiration were usually attributed to soil physico-chemical properties and changes in microbial communities(Cook and Orchard, 2008; Luo *et al.*, 2001). As the Aca and Mf sites generally had the same physico-chemical properties, it could be that the variations observed were induced by different fungus / bacteria ratios(Gray *et al.*, 2011) Indeed, fungi could survive heat stress better than bacteria because of their ability to grow at lower matric potentials(Nakas and Klein, 1979; Schnürer *et al.*, 1986). Future studies will be conducted with this in mind.

The differences in biogeochemical functionalities between the Aca and Mf sites was also observed in the nitrification process. Nitrification (figure 3), which was rather low for the Aca site, was not affected by the treatments, and this process was favoured in the Mf site with soil moisture at 70%. Ammonification varied similarly between the two sites and increased for C and D treatments at 38 °C, which is consistent with the literature(Bothe *et al.*, 2007). The differences in biogeochemical functionalities between the Aca and Mf sites was also observed in the nitrification process. Nitrification (figure 3), which was rather low for the Aca site, was not affected by the treatments, and this process was favoured in the Mf site with soil moisture at 70% and was limited by an increase in temperature. The results at the Mf

site suggest a response of the nitrification processes to climatic variations close to natural tropical soils (Bothe *et al.*, 2007; Myers, 1975). Ammonification varied similarly between the two sites and increases for C and D treatments at 38°C. Optimal temperatures for nitrification are less than those for ammonification, and these changes in the nitrogen cycle were consistent with other studies that showed a shift in the structure of nitrifying communities during an increase in soil temperature (Kim *et al.*, 2006; Sabey *et al.*, 1956; Sahrawat, 2008; Shammass Kh., 1986).

For the Aca and Mf sites, the decrease in urease and overall (FDA) activities when soil moisture increased agrees with the findings of other authors and reflects the level of soil oxygenation, which could alter the structure and diversity of microbial communities (Silva *et al.*, 2008; Unger *et al.*, 2009).

4.4 The case of mercury

Plant restoration is a common method to limit soil loss through erosion (Wong, 2003) and promote the return of biogeochemical cycles, but its effect on the bioavailability of mercury is less known and could be problematic (Couic *et al.*, 2018). In soils, the solubility of mercury is governed by many physico-chemical and biological factors, such as pH, redox potential, the nature of organic matter, grain size and the presence of iron oxides (Alloway, 2012).

Based on our results and considering the experimental variability, the treatments did not have a very significant effect except for the solubility of mercury for the Mf site, which was reduced with treatment C. Nevertheless, the solubility of mercury seemed to be favoured by the presence of fabaceous species (Aca and Mf sites), while the solubility of mercury on the Sp and an Fc sites was low.

If tropical soil, which is rich in kaolinite, has a strong affinity for mercury, pH values < 5 for the different sites would limit the adsorption of mercury on the carrier phase (Alloway, 2012) for the benefit of organic matter and iron oxides. The differences in solubility are thus more related to other physico-chemical and biological factors than to simple differences in clay content, as Guedron *et al.* (2009) (Guedron *et al.*, 2009) has already shown on former Guianese mining sites.

Several hypotheses are possible. In mining sites, the topography and atmospheric conditions made periods of flooding possible, thus creating anaerobic and suboxic conditions. Previous

work has demonstrated that disorganized hydromorphic zones, consequences of gold panning, lead to biogeochemical conditions favourable to mercury mobility (Lacerda *et al.*, 2004) and potentially to its methylation (Guedron, 2008). Some microbial communities, such as Ferri-reducing bacteria (FRB) and Sulphate reducing bacteria (SRB)(King *et al.*, 2002), promote the bioavailability of mercury under anaerobic conditions. If these communities were present in the rehabilitated sites and aerobic conditions were not maintained, mercury availability could be a factor. Moreover, in suboxic conditions, BSR and BFR activity levels may be conditioned by the quality of organic matter and the nature of functional groups, notably sulphide and sulphate groups (Skjellberg *et al.*, 2006b). The presence of dissolved carbon, resulting from microbial metabolism or root exudates, could be an important vehicle for the mobility of mercury, and the quality of the litter produced by fabaceous species combined with an acidic pH could promote the solubility of mercury.

Fabaceous species, especially certain species of the acacia species, are known to produce root exudates with a strong acidifying power (Abbas *et al.*, 2016) that can affect the solubility of metal trace elements. However, *Clitoria racemosa* is poorly described in the scientific literature, and it was therefore possible that this species may promote the solubility of certain trace elements, such as mercury. Further studies are needed to explain this finding, but these results showed the importance of considering the toxic trace element cycle in assessing the quality of ecological restoration. Indeed, studies have shown methylation mechanisms on Guianese sites that are relatively similar to those of this study (Da Silva *et al.*, 2016; Harris-Hellal *et al.*, 2011). Knowledge of mercury biogeochemistry is extensive but considering the sum of interactions between soil physics, soil biomass and plant biomass on mercury mobility will allow environmental and health assessments to be carried out at Guiana's mining sites.

Conclusion

Ecological rehabilitation of former mining sites in Guiana are essential for the sustainable development of the gold sector. The success of ecological restoration is linked to several criteria, notably the recovery of biogeochemical cycles and, from a health point of view, a potential limitation of trace element mobility. The study of three former rehabilitated sites revealed strong improvements in microbial activities involved in carbon and nitrogen cycles. The study also revealed a relatively limited effect of temperature range

used in the experiment, which could suggest a rapid response of rehabilitated soils to climatic variations. An increase in soil moisture had no significant effect on nitrification and ammonification processes, but it did reduce potential telluric enzyme activities. Regarding mercury mobility, the absence of ecological restoration protocols has resulted in significant total mercury losses, probably due to erosion. This erosion would lead the mercury associated with soil particles to be deposited in aquatic systems. The presence of vegetation cover via the restoration of mining sites with *Acacia mangium* and *Clitoria racemosa* would therefore limit mercury losses. Nevertheless, our mesocosm experiment also showed a higher solubility of mercury for sites restored with fabaceous species, which could be linked to a change in mercury chemistry at these former mining sites as well as a higher acidity on these plots. These results show the value of ecological restoration in the return of biogeochemical activities and highlight the potential impact of fabaceous species on mercury solubility. This climate change simulation highlighted different types of biogeochemical cycle responses depending on the nature of the rehabilitated or natural sites, which could therefore be linked to the level of ecological restoration. However, it would be useful to extend this study to a wider range of ecological restoration modalities to provide a more general overview of the evolution of biogeochemical processes after the rehabilitation of Guianese gold mining sites.

Article III: Impact of vegetation cover on soil structure, microbial activity and diversity of former Guyanese mining sites

Résumé

La compréhension des trajectoires écologiques après la réhabilitation des sites miniers est essentielle pour développer des protocoles de restauration écologique adaptés aux sites miniers aurifères. Cette étude décrit l'influence d'un panel de protocoles de réhabilitation et de revégétalisation sur les propriétés physico-chimiques du sol ainsi que sur les activités microbiennes relatives au fonctionnement des cycles biogéochimiques du carbone, de l'azote et du phosphore. Nous avons échantillonné du sol provenant de 6 sites réhabilités en Guyane française, avec des couverts végétaux différents (herbacées, cyperacées, monoculture de *Clitoria racemosa*, monoculture d'*Acacia mangium* et une association de *C. racemosa* et *A. mangium*). Nous avons mesuré les potentiels de minéralisation du carbone, de l'azote et du phosphore et nous avons complété ce diagnostic en évaluant la richesse fonctionnelle et la diversité catabolique des communautés microbiennes. Les résultats montrent une amélioration de la qualité chimique des sols revégétalisés avec des couverts arborés. Ce recouvrement du stock de matière organique a entraîné une augmentation de la biomasse microbienne totale d'un facteur 3 par rapport aux sites non revégétalisés. Sur les sites revégétalisés, il existe une corrélation importante entre l'augmentation du stock de biomasse microbienne et l'amélioration des potentiels de minéralisation de la matière organique. De plus, l'instauration d'un couvert arboré a significativement diversifiée la richesse catabolique des communautés microbiennes des sites miniers. Ces résultats confirment que l'établissement d'un couvert végétal en conditions contrôlées, dans une optique de restauration écologique améliore significativement la redondance fonctionnelle des communautés microbiennes telluriques des sites miniers.

Submitted in Soil, Forest and Environment

**Impact of vegetation cover on soil structure, microbial activity and diversity
of former Guyanese mining sites**

Ewan Couic^{*a,b}, Narimène Mati ^c, Vanessa Alphonse^b, Stéphanie Giusti-Miller^a and
Nouredine Bousserhine^b

^a Institut d'Ecologie et des Sciences de l'Environnement de Paris (IEES), Université-Paris-Est
Créteil, 94010, Créteil cedex, France.

^b Laboratoire Eau Environnement et Systèmes Urbains (Leesu), Université-Paris-Est Créteil,
94010, Créteil cedex, France

^c Université Paris Est Créteil 94010, Créteil cedex, France

* Corresponding author :

Ewan Couic

E-mail :

Abstract

Understanding ecological trajectories after mine site rehabilitation is essential to develop relevant protocols adapted to gold mining sites. This study describes the influence of a range of mine site rehabilitation and revegetation protocols on soil physicochemical parameters and microbial activities related to carbon, nitrogen and phosphorus cycles. We sampled soil from 6 rehabilitated mining sites in French Guiana with different plant cover (herbaceous, cyperaceous, *Clitoria racemosa* monoculture, *Acacia mangium* monoculture and association of *C. racemosa* and *A. mangium*). We measured the mineralization potential of organic matter by estimating the mineralization of carbon, nitrogen and phosphorus and supplemented these data with a microbial catabolic diversity balance. The results show an improvement in the quality of organic matter on revegetated sites with tree cover. At tree sites, the microbial biomass is 3 times higher than non-restored sites, improving the rates of mineralization of organic matter and restoring the catabolic diversity to the level of natural Guyanese soils. These results confirm that the establishment of tree cover under controlled conditions significantly improves the resilience of microbial communities in mining soils.

1. Introduction

Gold mining has been a key activity in Guyana's economy for nearly 150 years (Carmouze *et al.*, 2001). Before 2006, alluvial gold panning mainly used mercury because of its amalgamating properties, thus improving extraction efficiency. Decades of mining and mercury use have had serious consequences on Guyana's tropical forest, such as deforestation, pollution of water systems, and mercury contamination of local populations (Carmouze *et al.*, 2001). After mining, mine sites are characterized by heterogeneous soil texture, loss of organic soil horizons, and very low microbial activity. To limit the damage caused by mining, operators are now obliged to rehabilitate mining sites by terracing the soil to homogenize soil structure and texture. After rehabilitation, gold miners are encouraged, but not obliged, to carry out ecological restoration of mining sites by reintroducing plant species (Loubry, 2002).

Mine site restoration in stable and productive areas requires the establishment of a self-sufficient soil/plant system in which nutrient release rates are enough for plant growth. Fabaceous plants are known to be nitrogen-fixing species due to their root symbiosis, and the literature reports numerous studies on their use in soil remediation and restoration, particularly in Guyanese mining sites (Chaer *et al.*, 2011).

Ecological restoration of mining sites would also limit erosion and suboxic conditions favourable to the mobility of toxic elements, such as mercury. In contrast, non-remediated sites are more sensitive to erosion, particle transfer into the water system, and increased mobility of mercury at these sites, which can increase the potential for methylation and bioaccumulation in the food chain. Mastery of rehabilitation and ecological restoration techniques is therefore essential for sustainable development in Guyana.

The aim of this study is to highlight the influence of different types of plant cover on microbial activities developed after the rehabilitation of mining sites in the Belizon and Yaoni regions. The Belizon mine operated until 2013 and then rehabilitated and revegetated with macro cuttings of *Clitoria racemosa*. The Yaoni mine is older, operating during the 1990s, and is one of the pioneering sites for ecological restoration in French Guiana. To evaluate the functionality of the biogeochemical cycles on the restored plots, measurements of C, N and P mineralization and functional microbial diversity were carried out.

2. Materials and methods

2.1. Site description and soil sampling

The work was undertaken in French Guiana, South America. The sampled soil sites for this study were rehabilitated after gold mining extraction. After closing the alluvial mine pit, rehabilitation consisted of reconstituting the soil excavated during mine exploitation. All excavated soils were then homogenized and flattened before restoration began (Loubry, 2002). These soils can be considered anthroposol, and they have a different structure and texture than natural tropical forest soils.

Six sites were chosen as a function of the restoration method adopted. These six sites were grouped into two categories: 3 non-restored (NR) sites and 3 restored (R) sites by an ecological restoration protocol.

The first non-restored site (N 04°30.311' / W 052°26.919') had a vegetation cover of between 5 and 10% of the soil surface, and there was a domination of spontaneous herbaceous species. We called this site Sp1 to denote "spontaneous vegetation 1". The second non-restored site (N/W) also had a vegetation cover between 5 and 10%, with the majority of species belonging to Cyperaceae (*Cyperus spp.* and *Carex spp.*). We called this site Sp2 to denote "spontaneous vegetation 2". The third non-restored site (N 04°22.509' /

W 052°20.739') had a larger vegetation cover, with almost 30% of the surface dominated by *Lycopodiella spp.* and some Cyperaceae (*Cyperus spp.* and *Carex spp.*). We called this site Sp3 to denote "spontaneous vegetation 3". No trees had managed to establish themselves on these three non-restored sites.

Concerning the restored sites (R), the first site (N 04°29.860' / W 052°26.966') was restored with macrocuts of *Clitoria racemosa* in January 2013. Currently, the trees are over 5 metres tall across the site, and ecological restoration is a success. We called this site Cli to denote "*Clitoria racemosa*". The second site (N 04°29.860' / W 052°26.966') was restored with *Acacia mangium* macrocuts in 1998. Currently, the trees are over 10 metres tall across the site, and ecological restoration is a success. We have called this site Aca to denote "*Acacia mangium*". The third site (N 04°29.860' / W 052°26.966') was restored with macrocuts of *Acacia mangium* and *Clitoria racemosa* in 1998. Currently, the trees are over 10 metres tall across the site, and ecological restoration is a success. We called this site Mf to denote "mixed fabaceous species".

At each site, soil samples were collected from depths between 0-10 cm with an auger in April 2016. The sampling for the 6 sites consisted of sampling 5 plots (n=5) per site, with 3 sub-samples per plot that were pooled at the laboratory. The sampling of 5 plots per site was mainly determined by the topography of the terrain, the accessibility of the plots and the feasibility of sampling. Soil samples were immediately sealed in sterile hermetic polyethylene bags for transportation to the Cayenne IRD laboratory. Samples were then dried at ambient temperature (25°C) until they were air dried (i.e., approximately 3 weeks). These 90 collected samples (6 sites * 5 plots * 3 samples per plot) were then sieved at 2 mm, homogenized, and hermetically sealed at 4°C until use.

2.2. Initial soil sample characterization

Before using soil samples in microcosms, pH, total major element (i.e., C, N, P, Fe) and total trace element (Hg) content, total organic carbon content, granulometry measurements, and microbial biomass carbon (using the substrate-induced respiration (SIR) method) were determined to characterize the main physicochemical and biological properties; this enabled us to assess the main differences between soils.

Soil pH measurements:

Soil pH-H₂O and pH-KCl were measured in soil suspensions by shaking 1 g of soil in a 1:2.5 soil:water and soil:KCl (0.1 M) ratio for 1 h and then using a pH meter (MetrOhm 744) (ISO 10390).

Total Iron content:

For metal analyses, the samples were first ground to 63 μm . To obtain total iron concentrations, soil samples were dissolved in cleaned Teflon digestion tubes (SCP Science) at 80°C in a mixture of concentrated HNO₃-HF (3:1 ml) using a hot block (Digiprep MS, SCP Science). Samples were warmed at 80°C. All samples were then dissolved in 2 ml of concentrated HCl overnight at room temperature and then warmed for 4 h at 80°C. Then, samples were dissolved in 5% HNO₃ before the analysis by inductively coupled plasma optical emission spectroscopy (ICP-OES, Spectroblue). All chemicals used were of trace element grade purity.

Soil total mercury content:

Mercury concentrations (HgT) in soil samples (ground to 63 μm) were determined directly by thermal decomposition atomic absorption spectrometry after gold amalgamation using an automatic mercury analyser (AMA 254) with a detection limit of 0.01 ng.

Soil total carbon, nitrogen, and phosphorous measurement:

Soil total carbon (C_{tot}) and total nitrogen (N_{tot}) were determined by the Dumas method (NF ISO 13878). The Dumas method consists of flash combustion of the soil sample (at 1000°C) using helium and oxygen. After purification of the combustion gases, determination of total carbon and nitrogen content was performed by chromatography with a thermal conductivity detector (NA 1500 series 2 CARLO-ERBA).

Total phosphorus (P_{tot}) was determined after the acid digestion of soil samples, as previously described. The HPO₄ formed during acid digestion was measured after adding ammonium molybdate and acid ascorbic (Murphy and Riley, 1962). The colour produced by phosphomolybdenum (PMB) was measured by colorimetry at 885 nm (spectrophotometer Genesys 10 μv Scanning, Thermo).

Water extractions were performed for total organic carbon (TOC), and concentrations were measured with a Shimadzu TOC-500 apparatus (Shimadzu, Kyoto, Japan). One gram of soil was shaken for 24 h in a polypropylene centrifuge tube with 10 ml

of ultrapure water. The suspensions were centrifuged at 2000 rpm for 10 min, and supernatants were filtered at 0.2 μm (PTFE, VWR[®]) and directly analysed on the TOC analyser.

Soil granulometry determination:

Granulometry was determined on granules less than 2 mm, and five classes of particles were distinguished according to the NF X 31-107 standard: clay (< 2 μm), fine silts (2 to 20 μm), coarse silt (20 to 50 μm), fine sands (0.050 to 0.200 mm) and coarse sands (0.200 to 2 mm). Sampling and sieving were carried out after the destruction of organic matter by hydrogen peroxide (H_2O_2) on a test sample of approximately 10 g. The final dispersion was carried out by a short ultrasonic passage after the addition of dispersant $[(\text{NaPO}_3)_6 + \text{Na}_2\text{CO}_3]$, and afterwards, the coarse sands (> 0.200 mm) were separated by sieving. To illustrate this, the results have been grouped into 3 parts: clay, total silt, and total sand.

2.3. Soil microbial biomass

To estimate the catabolic diversity of microbial communities with the EcoPlate device (ECOLOG), it was first necessary to determine the biomass of microorganisms in the samples and then inoculate the EcoPlate at constant biomass.

The application of the substrate-induced respiration technique (SIR) was applied to determine the total microbial biomass (Anderson, 1982). Samples with a weight of 2 g were taken and placed into flasks (15 ml), to which a solution of glucose (0.1 ml/g soil; the final glucose concentration was 10 mg g) was added and flasks were sealed with a butyl/PTFE shield cap (VWR[®]). The CO_2 concentrations were analysed using micro gas chromatography (micro-GC 490, Agilent). The CO_2 evolution rate ($\mu\text{LCO}_2\text{-C g}^{-1}\text{ soil h}^{-1}$) at each sampling time was then calculated after subtracting the background CO_2 concentration. Our experiment was conducted at 22°C, which was the temperature prescribed in the original SIR method (Anderson and Domsch, 1978). The SIR rate was defined as the minimum respiration rate measured during the 24 h after the addition of glucose, in accordance with Anderson and Domsch (1978)(Anderson and Domsch, 1978). Using the SIR method, soil microbial biomass C (SIR-biomass) was calculated using the following equation from Anderson and Domsch (1978)(Anderson and Domsch, 1978):

$$\text{SIR-biomass C } (\mu\text{gC g}^{-1}\text{ soil}) = \text{SIR } (\mu\text{l CO}_2\text{ g}^{-1}\text{ soil h}^{-1}) \times 40.04 + 0.37 \quad (\text{Eq. 1})$$

2.4. Catabolic diversity using Biolog EcoPlates

The carbon source utilization patterns of microorganisms were investigated to discriminate the soil communities from the different non-restored and restored old mining sites. Community-level physiological profiles were assessed using the Biolog EcoPlate™ system (Biolog Inc., CA, USA). Each 96-well plate consisted of three replicates, each comprising 31 sole carbon sources and a water blank. Microbial cell suspensions for the inoculation of the Biolog EcoPlate™ were prepared by agitating 1 g of soil in 10 ml of NaCl (9 g.L⁻¹) for 30 min at 300 rpm and then centrifuging the suspensions (3000 rpm, 10 min) to eliminate soil particles. Dilutions were then applied to the solutions to ensure that the total microbial biomass inoculated into the Biolog EcoPlate wells was the same for each sample. Plates were inoculated with 150 µl of solution per well and incubated 120 h at 28°C. Absorbance at 595 nm was directly measured by a plate spectrometer (Dynex Oxy MR). Average well colour development (AWCD) was calculated, and the data were standardized by subtracting the blank control well measure from each substrate containing well and dividing by the AWCD (Garland, 1995). Potential functional richness (PFR) was estimated with the average number of positive wells (DO > 0.15). The catabolic diversity determining substrate utilization capacity was assessed by dividing the average number of positive substrates by the total number of substrates (31). The Shannon index (H) and the regularity index (E_H) were calculated using the following formulas:

$$H = - \sum_{i=1}^N P_i (\ln P_i)$$
$$E_H = \frac{H}{\ln S}$$

where **P_i** is the ratio of the activity of a particular substrate to the sum of the activities of all substrates and **S** is the richness of the substrate.

2.5. C, N and P turnover in soil samples

To quantify carbon, nitrogen and phosphorus mineralization activities in soil samples, fifty millilitres of sterile hermetic glass plasma bottles were filled with 4 g of each soil sample. Soil samples were then brought to 70% of their holding capacity with sterile ultra-pure water, and soil humidity was kept constant with sterile ultra-pure water. The obtained microcosms were mixed with sterile spatulas, sealed with butyl/PTFE shield caps (VWR®) and incubated

at 28°C for 10 days. To avoid anaerobiosis conditions, the microcosms were regularly aerated under a laminar flow in sterile conditions (PSM Optima 12; ADS Laminaire).

Mineralized total carbon (C_{\min}) was evaluated by measuring soil CO_2 produced during the experimental setup. Every three days, the release of CO_2 was measured by micro gas chromatography (Agilent, Micro GC 490, PPQ column). The value of C_{\min} was expressed as $\mu\text{g-C CO}_2 \cdot \text{g}^{-1}$ of soil d^{-1} .

Mineralized nitrogen (N_{\min}) was determined by measuring the production of mineral N (NH_4^+ and NO_3^-) during incubation. The NH_4^+ and NO_3^- contents were measured at day 0 and day 30 by indophenol and dimethyl-2,6-phenol methods, respectively. For the measurement of NH_4^+ and NO_3^- , 1 g of soil sample (dry weight equivalent) was shaken with 7.5 ml of CaCl_2 (0.025 M) for 2 h. Filtration with a PES filter was performed after centrifugation at 3000 rpm for 10 min. The NH_4^+ was measured with a spectrophotometer at 690 nm (Genesys 10 μv Scanning, Thermo Scientific) after adding sodium hypochlorite and 4 drops of thymol/sodium nitroprussiate solution (ISO 7150-1). NO_3^- was measured with a spectrophotometer at 493 nm (Genesys 10 μv Scanning, Thermo Scientific) after adding sulfuric and phosphoric acid and 0.5 ml of dimethyl-2,6-phenol (DIN 38405-9). The net ammonification and nitrification rates were calculated as the difference in N- NH_4^+ and N- NO_3^- contents before and after incubation (i.e., day 0 and day 30). The mineralization rate of total organic N was estimated by summing the ammonification and nitrification rates. The N_{\min} value was expressed as $\mu\text{g-N} \cdot \text{g}^{-1}$ of soil d^{-1} .

Mineralized phosphorus (P_{\min}) was determined by measuring the production of mineral phosphorus during incubation. Mineralized inorganic phosphorus in 1 g of soil was measured after the same CaCl_2 extraction as used for nitrogen mineralization. Then, HPO_4 was measured after adding ammonium molybdate and ascorbic acid (Murphy and Riley, 1962). The colour produced by phosphomolybdenum (PMB) was measured with a spectrophotometer at 885 nm. The P_{\min} value was expressed as $\mu\text{g-P} \cdot \text{g}^{-1}$ of soil d^{-1} .

3. Results and discussion

Mining activities seriously disturbed the soil ecology, and microbial diversity tended to decrease (Hou *et al.*, 2018). To prevent this, revegetation has been considered a management tool for the sustainable development of the mining industry and soil recovery

(Hou *et al.*, 2018). Our experiments revealed the impact of revegetation on microbial activity and diversity and physicochemical soil properties.

3.1. Soil properties

Revegetation with fabaceous plants is a widely used technique to restore soil fertility by covering the soil nutrient stock of mined soils (Singh *et al.*, 2004; Tripathi and Singh, 2008). Several studies have shown that the type of vegetation cover has an influence on improving the physicochemical quality of mined soils, as well as on the overall level of ecological restoration.

In our study, vegetation played a significant role in improving physicochemical properties, especially in the mixed fabaceous (Mf) site. Revegetation enhanced the physicochemical properties. Our experiments show the impact of rehabilitation on soil properties, particularly texture, which affects microbial activity and the success of ecological restoration (Schimann *et al.*, 2007).

Compared to NR sites (Sp1, Sp2 and Sp3), restoration significantly improved soil properties (Table 1). All parameters were influenced by the nature of the vegetation cover. The values of total C, N and P and total contents (Fe, Mn, Al and Hg) were the highest in R soils and the lowest in NR soils. These differences highlight that rehabilitation is an important step for effective restoration.

Restored soils had homogeneous texture, while the texture of NR soils was mainly varied. The differences in textures indicated that rehabilitation was performed differently, and this finding was supported by Ekamawanti, who showed high soil heterogeneity in rehabilitated sites (Ekamawanti, 2018). These different rehabilitation strategies might have an impact on microbial activities. Hou *et al.*, 2018 (Hou *et al.*, 2018) reported that there is an interaction between soil properties and the structure and function of soil microbial communities, particularly in the decomposition of organic matter. Any modification in this relationship may influence microbial structures, which, in turn, affect soil ecological processes and determine the success of ecological restoration. It would seem that the relatively homogeneous structure of the R sites (Table 1) ensures an adequate water balance for vegetation cover, and the very coarse texture of the Sp2 site and the very fine textures of the Sp1 and Sp2 sites limit the recovery of vegetation cover.

The contents of C, N, P and TOC were significantly higher in the R sites than in the NR sites. Many studies have shown that soil nutrient content is closely correlated with changes in the vegetation cover (Li *et al.*, 2015; Singh *et al.*, 2004; Yang *et al.*, 2010), and vegetation age affects the vertical distribution of microorganisms (Hou *et al.*, 2018). These results also confirm the effectiveness of a cover of fabaceous species in recovering soil organic matter stocks at rehabilitated sites in Guyana. The presence of fabaceous species and their ability to fix atmospheric nitrogen also improved the quality of organic matter, as shown by the values of C/N < 15 at the Aca and Mf sites compared to C/N > 20 for the Sp2 and Sp3 sites.

Table 1:

C_{tot}, N_{tot}, P_{tot} : Total C, N and P ; TOC : Total Organic Carbon ; MBC : Microbial biomass carbon; Total Fe, Al, Hg : Total Iron, Aluminum and Mercury content, (n=5, mean ± SD).

Sites	Restored	C _{tot} g.kg ⁻¹	TOC g.kg ⁻¹	N _{tot} g.kg ⁻¹	P _{tot} g.kg ⁻¹	C/N	pH		Total					
							pH-H ₂ O	pH-KCL	Fe g.kg ⁻¹	Al g.kg ⁻¹	Hg µg.kg ⁻¹	Clay %	Silt %	Sand %
Sp1	NR	6.01	3.88	0.40	0.21	15.02	5.26	4.5	65.15	53.88	0.23	46.4	41.5	3.3
		±0.32	±0.04	±0.03	±0.04	±0.30	±0.23	±0.11	±3.17	±1.53	±0.01	±3.6	±2.8	±0.2
Sp2	NR	3.52	2.47	0.14	0.13	25.14	5.3	4.7	66.2	16.4	0.27	7.5	21	71.1
		±0.37	±0.23	±0.02	±0.01	±1.08	±0.13	±0.15	±2.1	±0.6	±0.02	±2.7	±2	±1.6
Sp3	NR	9.55	5.84	0.45	0.27	21.2	4.66	4.21	44.56	41.33	0.23	22.2	65.8	11.8
		±0.73	±0.35	±0.01	±0.07	±1.27	±0.07	±0.09	±0.77	±1.77	±0.07	±5.1	±3.2	±1.2
Cli	R	7.01	5.0	0.40	0.17	17.52	5.0	4.45	113.3	25.5	0.28	21.3	24.8	53.9
		±0.83	±0.4	±0.04	±0.02	±1.35	±0.03	±0.13	±4.2	±2.15	±0.03	±1.6	±3.7	2.5
Aca	R	14.11	10.55	1.12	0.37	12.6	4.21	3.74	53.69	45.31	0.48	18.4	35.6	41.6
		±1.2	±0.62	±0.07	±0.12	±0.54	±0.07	±0.26	±4.15	±6.51	±0.04	±2.5	±3.9	±4.4
Mf	R	22.88	15.58	1.81	0.76	12.64	4.66	3.88	71.02	43.76	0.41	19.8	32.4	36.4
		±1.5	±1.41	±0.10	±0.15	±0.41	±0.11	±0.45	±1.37	±1.21	±0.05	±3.8	±4.9	±5.9

The pH-H₂O and pH-KCl measurements indicated that R sites were more acidic than NR sites, which means that the amount of H⁺ ions might be replaced by other potentially toxic elements. Several studies have demonstrated that leguminous plants have a great capacity for rhizosphere acidification due to the release of ample amounts of H⁺ ions.

The higher concentration of Hg for R sites, with 0.39 µg.kg⁻¹, than NR sites, with 0.24 µg.kg⁻¹, could suggest that Hg is trapped in the soil, mainly due to the presence of plantations. Several studies have reported that plantations are an essential means to stabilize a bare area and to minimize the pollution from mine sites (Finžgar *et al.*, 2006; Wong, 2003), in

particular, by limiting the processes of erosion and the transfer of mercury particles to the water system and by drying the soil, which limits anaerobic conditions favourable to mercury methylation. However, mercury measurements at the sites are very heterogeneous, and additional measurements would be needed to confirm this claim; it would be necessary to carry out environmental speciation measurements to ensure that the most mobile forms of mercury are reduced at the restored sites.

3.2. Microbiological parameters

Ecological restoration is also a common and relevant method for covering microbiological activities in mine soils, including the biogeochemical cycles of carbon and nitrogen. To assess the soil quality in rehabilitated and regenerated mining sites, microbial carbon biomass and mineralization of macronutrients are relevant tools (Couic *et al.*, 2018) (Schimann *et al.*, 2007). In this study, ANOVA tests (Table 2) showed that there were significant differences for all microbiological parameters, indicating a significant site effect with the type of restoration.

Table 2:

Effects of vegetation and level of restoration in a one-way ANOVA.

	Sites	Level of restoration
Df	5	1
Total carbon	4472***	25.42***
Total nitrogen	1529***	22.26***
Total phosphorus	224.3***	11.13**
Microbial Biomass Carbon	1330***	322***
Carbon mineralization	480***	20.2***
Nitrate mineralization (NO ³⁻ -N _{min})	67.6***	18.9***
Ammonium mineralization	49***	60.1***
Phosphorus mineralization	58.1***	94.6***
Average-well colored development (AWCD)	15.7***	47.7**
Potential functional richness	56.4***	60.6***
Catabolic diversity	56.4***	60.6***
Shannon Index	37**	44***
Regularity index	11.8**	17.8**

According to Ross *et al.* 1990, the microbial biomass is a satisfactory estimate of the restoration of the soil microbial population. In our study, the MBC was different for each site, indicating significant effects of the rehabilitation process, especially the type of vegetation cover.

An increase in MBC was observed across the level of restoration (NR and R) and plantation types (Cli, Aca and Mf) (Table 3). The highest MBC was registered for the Mf site (1103 mg kg⁻¹), followed by the Aca site (909 mg kg⁻¹) and the Cli site (845.2 mg kg⁻¹). For the non-restored soils, MBC was under 400 mg kg⁻¹. These microbial biomass values remain lower than those recorded in a previous study on natural soils in Guyana and show that the full recovery of microbial density is not yet complete for the restored sites (Couic *et al.*, 2018).

Table 3:

Microbial biomass carbon ; C_{min(SIR)} ; C_{min}, NH⁴⁺-N_{min}, NO³⁻-N_{min}, P_{min} : organic C mineralization rate, mineralized NH⁴⁺-N , mineralized NO³⁻-N, total N mineralization rate, organic P mineralization rate (n=5, mean ± SD).

Sites	Restored	MBC mg.kg ⁻¹	C _{min} μg.g ⁻¹ .j ⁻¹	NO ³⁻ -N _{min} μg.g ⁻¹ .j ⁻¹	NH ⁴⁺ -N _{min} μg.g ⁻¹ .j ⁻¹	N _{tot} _{min} μg.g ⁻¹ .j ⁻¹	P _{min} μg.g ⁻¹ .j ⁻¹
Sp1	NR	224.5 ±13.2	4.45 ±0.32	0.008 ±0.001	0.13 ±0.06	0.14 ±0.07	0.017 ±0.003
Sp2	NR	390.5 ±77.3	4.96 ±1.1	0.07 ±0.006	0.8 ±0.2	0.88 ±0.2	0.024 ±0.002
Sp3	NR	312.6 ±10.1	5.77 ±0.37	0.004 ±0.0003	0.45 ±0.05	0.46 ±0.05	0.03 ±0.002
Cli	R	845.2 ± 38.5	35.37 ±1.4	1.56 ± 0.35	1.15 ±0.15	2.7 ±0.44	0.047 ±0.007
Aca	R	909 ±69	39.14 ± 1.9	0.33 ±0.12	1.2 ± 0.32	1.55 ± 0.33	0.058 ±0.006
Mf	R	1103 ±88	46.58 ±1.5	0.35 ±0.11	1.7 ±0.14	2.03 ±0.07	0.065 ±0.008

The differences in MBC between restored soils (Cli, Aca and Mf) are related particularly to the age of the plantations and the species (Heděnc *et al.*, 2017; Singh *et al.*, 2004; Yang *et al.*, 2010), especially their litter inputs and roots exudates (Li *et al.*, 2015). Aca and Mf were planted in 1998, while Cli was planted in 2013. This demonstrates that a continuous increase in MBC with age indicates a continuous recovery of mining soils (Tripathi and Singh, 2008) and that estimated MBC recovery does not need a long period. MBC was higher in R than NR soils. This difference is due to plantations. Several studies reported the positive effect of plantations on microbial biomass (Heděnc *et al.*, 2017) through soil organic matter restoration, essential nutrient pools and soil structure. Organic matter stabilizes aggregate structure, increases soil retention capacity and improves nutrient bioavailability (Hobbs and Harris, 2001; Viana *et al.*, 2014), thus stimulating soil microbial flora (Asmar, 1997; Elfstrand

et al., 2007; Kang and Freeman, 2007). In addition, it highlights the role of vegetation in comparison with the non-restored sites with few pools of carbon, nitrogen and phosphorus (Bisseger *et al.*, 2014; Heděnc *et al.*, 2017; Yang *et al.*, 2010).

For these nutrients, the nutrient quality of the restored R soils was higher than that of the non-restored sites. These results appear to be directly related to the level of vegetation cover. Previous investigations on soil reclamation reported increased nutrient pools following the addition of compost, lime, and vegetation, in our case (Hou *et al.*, 2018).

Concerning microbial activities linked to the functioning of the main biogeochemical cycles, the differences between sites and between ecological restoration methods are very significant (Table 2) and confirm the role of restoration in the recovery of soil functionalities, as demonstrated in a previous study of rehabilitated former Guyanese mining sites (Couic *et al.*, 2018).

Large differences in the carbon mineralization rate showed the beneficial effect of ecological restoration. R soils were characterized by a higher rate of C, N, and P_{\min} (Table 2) in comparison with NR soils. These differences between the two restoration treatments were also highlighted in a previous study on similar sites in French Guiana (Couic *et al.*, 2018). This improvement in microbial functionality was largely attributed to differences in total microbial biomass between mine sites (Couic *et al.*, 2018). These results also confirm the positive effect of plant cover in stimulating microbial activities related to the turnover of organic matter (Couic *et al.*, 2018; Hou *et al.*, 2018).

Revegetation induced increases in the total N-mineralization rates by 2.03, 1.55 and 2.7, respectively, for Mf, Cli and Aca, in comparison with lower values in non-restored soils, as shown in Table 2. However, total N_{\min} was higher in Cli sites than Aca, which might be because of slow litter decomposition and lower N return through litterfall by *Acacia spp.* compared to *C. racemosa*, as reported by Singh *et al.* (2004), who found the same difference between *A. procera* and *A. lebeck*. These results could suggest that the different Fabaceae species and their associations are not all equally effective in restoring the functionalities of the nitrogen cycle in rehabilitated soils. It is possible that different covers of fabaceous species may induce variations in the diversity of microbial communities in the nitrogen cycle (Schimann *et al.*, 2012).

3.3. Catabolic diversity

Vegetation cover has an influence on the activity of microbial communities and their ability to provide compounds for biogeochemical cycles. However, several studies have demonstrated that the microbial communities on anthropized sites, such as old mine rehabilitated soils, can be altered.

The biological properties related to catabolic diversity are shown in Table 4. There were significant differences revealed by one-way ANOVA between restored and non-restored soils and biological parameters. The AWCD, catabolic diversity, PFR, Shannon and Eh measurements indicated that R sites were richer than NR sites in terms of diversity and biological activity, and these differences might be attributed primarily to vegetation (Bissegger *et al.*, 2014; Hou *et al.*, 2018; Schimann *et al.*, 2007) and secondarily to texture and soil properties (Schimann *et al.*, 2007).

Table 4:

AWCD, PFR, Catabolic diversity, Shannon index, Regularity index (n=5, mean \pm SD).

Sites	Restored	AWCD	PFR	Catabolic diversity	H	E _H
Sp1	NR	0.08 ± 0.01	3.6 ± 0.9	0.12 ± 0.02	1.2 ± 0.11	0.76 ± 0.05
Sp2	NR	0.18 ± 0.1	6.6 ± 2.1	0.21 ± 0.07	1.9 ± 0.47	0.53 ± 0.25
Sp3	NR	0.09 ± 0.02	3.8 ± 0.8	0.12 ± 0.03	1.3 ± 0.44	0.88 ± 0.036
Cli	R	0.34 ± 0.13	9.6 ± 1.9	0.31 ± 0.06	2.1 ± 0.12	0.92 ± 0.015
Aca	R	0.32 ± 0.1	15.2 ± 3.2	0.49 ± 0.11	2.6 ± 0.22	0.95 ± 0.027
Mf	R	0.49 ± 0.09	19.2 ± 1.1	0.62 ± 0.04	3.3 ± 0.11	0.98 ± 0.01

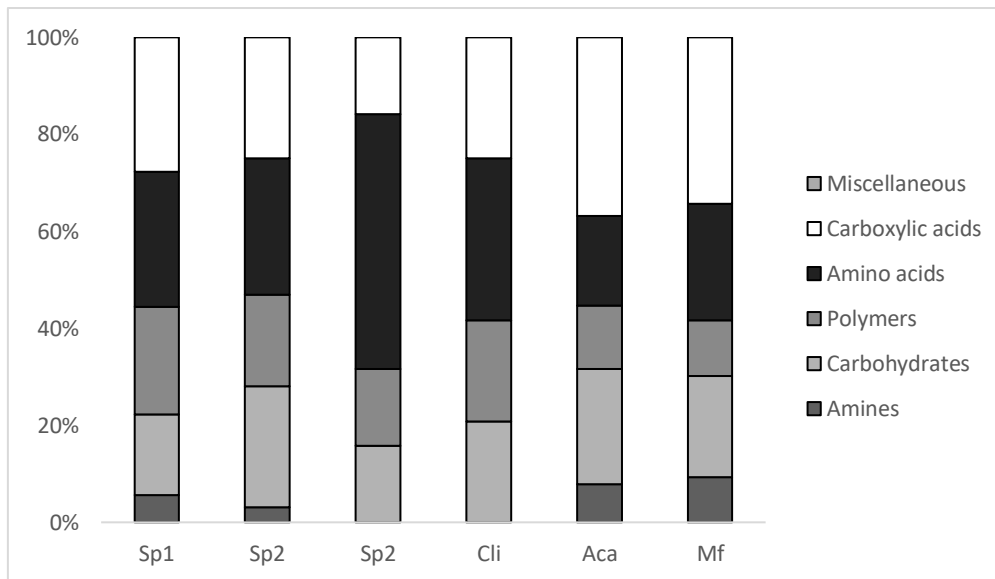

Figure 1:

Percentage degradation of substrates according to biochemical categories for the various rehabilitated soils

The AWCD value in an EcoPlate™ well is an important index of microbial functional diversity because it represents the capacity of soil microorganisms using different carbon sources (Zhu *et al.*, 2017). The increase in AWCD of R soils indicated a higher rate of carbon source use and higher functional diversity than NR soils. This might be attributed to plantations, which stimulate the microorganisms. A positive correlation between AWCD, MBC and total C, N, and P suggests that available C, N, and P are key factors influencing soil microbial functional diversity, which is improved by the nature of the vegetation cover (Zhu *et al.*, 2017). Li *et al.* (2015) showed the effect of vegetation as a significant factor for the development of microbial soil properties in many reclaimed treatment studies (Li *et al.*, 2015). In addition, it has already been shown that a rich vegetation cover, including fabaceous species, could stimulate microbial activities (Li *et al.*, 2015), which is in agreement with our results. Catabolic diversity and PFR parameters were significantly different between the levels of restoration. The main degraded substrates were carbonic sources (carbohydrates and carboxylic acid) (Figure 1), which might influence the composition of soil microorganisms. The same pattern was observed for Shannon and Eh, indicating that the greatest catabolic diversity existed under R soils and that the least diversity existed under NR soils. These results support the hypothesis that the establishment of a plant cover favours

microbial activities and functional diversities by improving the physicochemical properties of the soil (Asgharipour and Rafiei, 2015). It is important to note that the catabolic diversity measured at the Sp2 and Sp3 sites was very similar to that obtained by Harris (2009) from natural Guiana soils. These results could, therefore, illustrate a return to a balance in catabolic diversity and some biogeochemical functionality, but it would be interesting to determine genetic diversity to evaluate the molecular structure of microbial communities at rehabilitated sites (Harris-Hellal *et al.*, 2009).

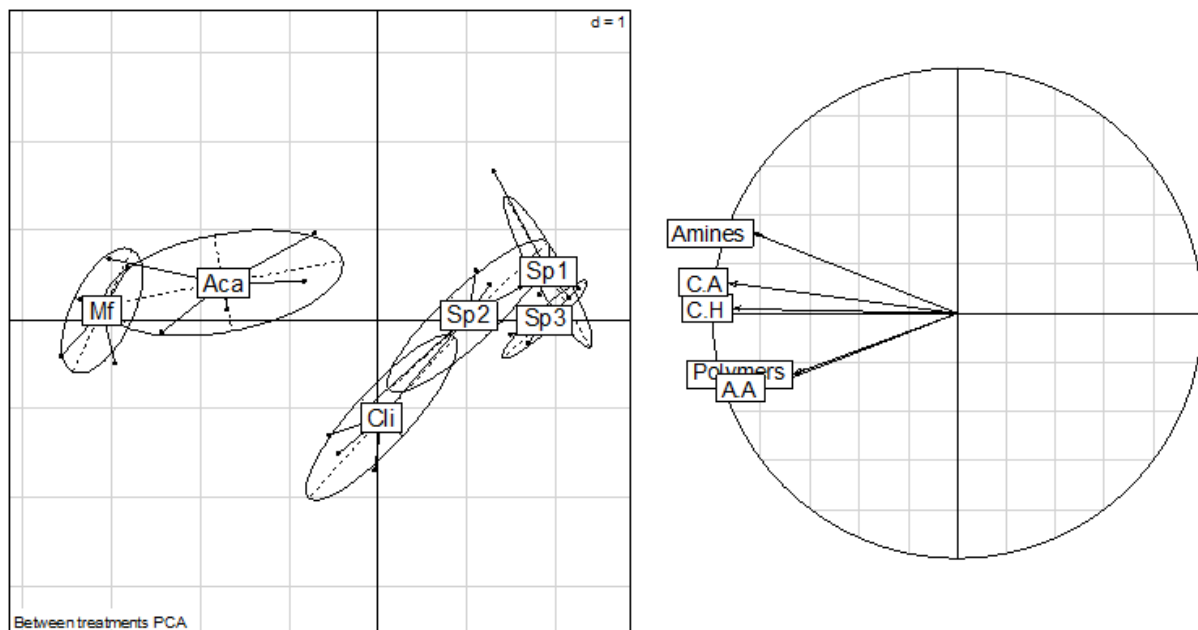

Figure 2:

Between-group analysis on the percentages of substrates consumed according to their biochemical classification. left: projection of data set variability plotted on a factorial map of the first two discriminating axis according to respective factor. Labels on the gravity center correspond to sub-factor of respective factor. right: correlation circles plot with variable vectors (Amines, Carboxylic Acids, Carbohydrates, Polymers and Amino Acids) for each respective factor. Types of vegetation cover: Sp1, 2 and 3. Spontaneous vegetation, Cli. Monoculture of *C.racemosa*, Aca. Monoculture of *A.mangium*, Mf. Mixed fabaceous culture. Eigen values 89.2%, 7.1% for axes 1 to 2 respectively. Randtest: simulated p-value: 0.001. Explained variance: 77.7%.

To evaluate the site effect and level of ecological restoration on catabolic diversity, the data obtained during the biological experiment were subjected to a BCA analysis. The first BCA (Figure 2) showed very significant differences ($p = 0.001$) and appeared to confirm the site effect on microbial catabolic diversity, with 77.7% of the total variance explained by the datasets. Eigenvalues for axes 1 and 2 were 89.2% and 7.1%, respectively. We observed a

significant influence of vegetation cover on microbial activity and diversity, especially for sites Mf and Aca, followed by Cli. These results are in accordance with those of Li et al (2015), who found that different carbon sources due to vegetation restoration patterns significantly influenced the metabolic activity and functional diversity of the microbial community in the soil (Li *et al.*, 2015) Further, (Bisseger *et al.*, 2014) showed that plant type and combination play a critical role in the development of the microbial communities present in treatment wetlands, in particular, by modifying the nature and quality of organic matter.

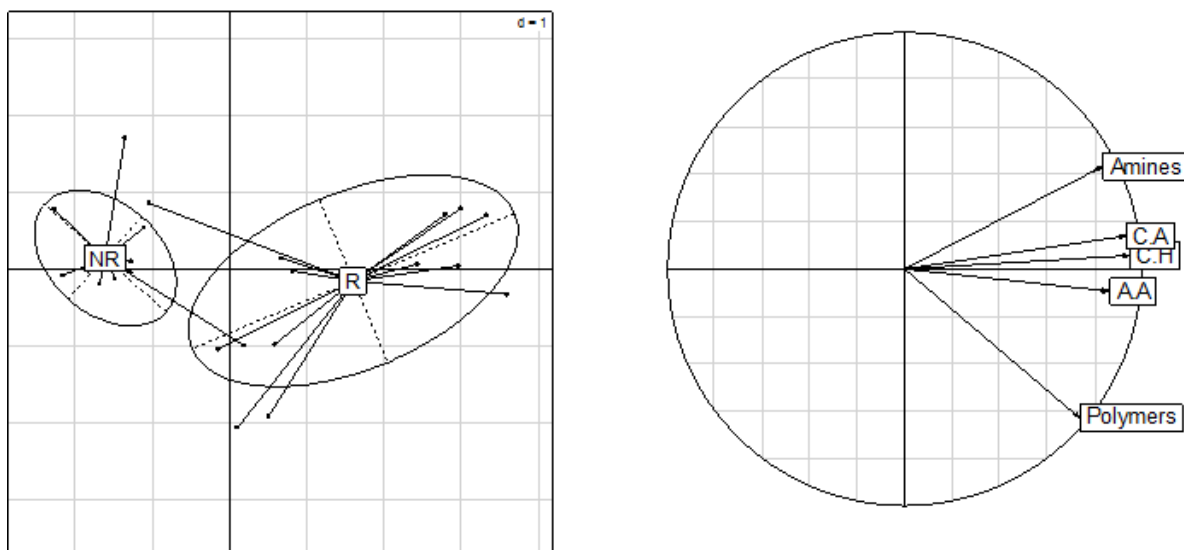

Figure 3:

Between-group analysis on the percentages of substrates consumed according to their biochemical classification. left: projection of data set variability plotted on a factorial map of the first two discriminating axis according to respective factor. Labels on the gravity center correspond to sub-factor of respective factor. right: correlation circles plot with variable vectors (Amines, Carboxylic Acids, Carbohydrates, Polymers and Amino Acids) for each respective factor. Level of restoration: NR. Non-Restored, R. Restored. Eigen values 75.4%, 12.2% for axes 1 to 2 respectively. Randtest: simulated p-value: 0.001. Explained variance: 52%.

To determine whether the level of ecological restoration had an impact on the structure of microbial communities, we also conducted a BCA (Figure 3) to estimate the variance of catabolic data explained by the level of restoration for R or NR. The between-group analysis was very significant ($p = 0.001$) and explained 52% of the total variance, while the eigenvalues for axes 1 and 2 explained 75.4% and 12.2%, respectively. The left projection

strongly differentiated NR and R sites according to the degradation of amino acids, carboxylic acids and carbohydrates, while amines and polymers had a smaller effect on site differentiation. These spatial representations of substrates degraded by the Biolog method to determine the site effect and ecological restoration level appeared to confirm changes in microbial community structure induced by tree canopy development.

Conclusion

This study, carried out on soil samples from rehabilitated Guyana mining sites, showed an improvement in the soil structure and functionalities of the biogeochemical cycles of C, N and P depending on the density and nature of the vegetation cover.

In agreement with various studies on rehabilitated sites (Ma *et al.*, 2017; Schimann *et al.*, 2012b; Valentim dos Santos *et al.*, 2016), the recovery of these functionalities seemed to be closely related to the increase in soil microbial biomass, which is conditioned by soil structure and the recovery of organic matter stock. Improving soil structure through revegetation could also affect the mobility of metallic trace elements in mining soils. This study also revealed a possible modification of the catabolic diversity of microbial communities at rehabilitated sites, which would confirm the hypothesis that ecological restoration directly influences soil microorganism activities. However, the results presented in this study do not make it possible to determine whether the modification of catabolic diversity is linked to an alteration in the genetic structure of communities. Moreover, these results cannot be generalized to all rehabilitated mining sites because of the very wide range of rehabilitation and restoration protocols adopted in French Guiana and the Amazon basin. Nevertheless, the microbial and biogeochemical approach seems to be a solid basis for assessing the quality of ecological rehabilitation protocols for Guyana's mining sites.

Article IV: Influence of reducing conditions on the mobilization of metal elements on former mining sites in French Guiana

Résumé

L'exploitation de l'or alluvial en Guyane française a engendré une pollution des milieux naturels, la déforestation des berges et l'érosion des sols miniers. Les sites miniers alluvionnaires, en raison de leur topographie sont sensibles aux épisodes d'inondations lors des fortes précipitations tropicales. Cette étude s'est intéressée à la caractérisation de la qualité physico-chimique de sols miniers réhabilités et à l'impact d'une simulation d'inondation sur le métabolisme microbien en lien avec la solubilisation de certains éléments métalliques. Nous avons échantillonné du sol sur 5 sites réhabilités en Guyane française, 2 sites avec un couvert végétal spontanée (NR et Lyc) et 3 sites réhabilités et restaurés avec un couvert de fabacées : une monoculture de *Clitoria racemosa* (Cli), une monoculture d'*Acacia mangium* (Aca) et une biculture de *Clitoria racemosa* et *Acacia mangium* (Mix). Nous avons réalisé une expérimentation en mésocosmes où des échantillons de sol ont été placés en conditions anaérobies pendant une période de 35 jours. Pour étudier l'effet de l'anaérobiose sur les communautés microbiennes nous avons suivi tout au long de l'expérimentation des paramètres relatifs au métabolisme microbien : production de CO₂, production de sulfates et des sulfures. Nous avons également suivi la solubilisation du fer, du manganèse, de l'aluminium et mercure dans le milieu de culture au cours de l'incubation. Dans un premier temps, les résultats illustraient l'importante contribution de la restauration écologique d'un couvert arboré sur le retour de la qualité du sol, particulièrement sur le site en biculture de fabacées. Dans un second temps, les résultats de l'expérimentation en mésocosmes ont révélé deux tendances. D'un côté, pour les échantillons des sites Aca et Mix nous avons mesurés des activités ferri-réductrices couplées à une importante solubilisation du manganèse, sans corrélation avec la mise en solution du mercure. De l'autre côté, sur les sites non restaurés (NR et Lyc), peu d'activités microbiennes ont été enregistrées, mais une production significative de sulfures dans le milieu de culture couplée à une solubilisation du mercure a été mesurée. Ces résultats permettent de mettre en évidence les conséquences potentielles d'inondation de sites miniers alluvionnaires sur le métabolisme microbien en conditions anaérobies et notamment sur la mobilité du mercure sur des sites miniers non restaurés.

Influence of microbial anaerobic metabolism on the mobilization of trace metallic elements on former mining sites in French Guiana

Couic Ewan^{*a,b}, Tribondeau Alicia^c, Alphonse Vanessa^b, Grimaldi Michel^{a,d}, Livet Alexandre^b, and Bousserhine Nouredine^b

^aInstitut d'Ecologie et des Sciences de l'Environnement de Paris (IEES), Université-Paris-Est Créteil, 94010, Créteil cedex, France. E-mail : ewan.couic@univ-paris-est.fr

^bLaboratoire Eau Environnement et Systèmes Urbains (Leesu), Université-Paris-Est Créteil, 94010, Créteil cedex, France

^cMuséum National d'Histoire Naturelle (MNHN), 75005 Paris

^dInstitut de Recherche pour le Développement (IRD), Centre IRD France Nord, 93143, Bondy cedex, France

* Corresponding author :

Ewan Couic

E-mail :

Abstract

Successive years of alluvial gold mining in French Guiana have resulted in soil degradation and deforestation leading to the pollution and erosion of mining plots. Due to erosion and topography, alluvial gold panning sites are submitted to hydromorphy during heavy rainfall and groundwater increases. This original study focused on characterizing the physicochemical quality of rehabilitated mining sites, the impact of hydromorphic anaerobic periods on iron- and sulfato-reducing bacteria, and the potential solubilization of some trace metallic elements. We sampled soil from 5 rehabilitated sites in French Guiana, including 2 sites with herbaceous vegetation (NR and Lyc) and 3 sites restored with fabaceous plants, including *Clitoria racemosa* (Cli) monoculture, *Acacia mangium* (Aca) monoculture, and *Clitoria racemosa* and *Acacia mangium* (Mix) bi-culture. We conducted mesocosm experiments where soil samples were incubated in anaerobic conditions for 35 days. To evaluate the effect of anaerobic conditions on the activity of bacterial communities, we measured the following parameters related to iron- and sulfato-reducing metabolism throughout the experiment: CO₂ release, carbon dissolution, sulphide production and sulphate mobilization. We also monitored the solubilization of iron oxyhydroxides, manganese oxides, aluminium oxides and mercury in the culture medium. The results revealed two trends in these rehabilitated sites. In the Aca and Mix sites, bacterial iron-reducing activity coupled with manganese solubilization was detected with no mercury solubilization correlation. In herbaceous sites (NR and Lyc), while the measured anaerobic activity was low, it seemed responsible for sulphide production coupled with twice as much mercury solubilization. These results confirm the presence and activity of ferri- and sulfato-reductive communities at rehabilitated mining sites and their interactions with the dynamics of metallic elements and mercury. These results also showed the positive impact of ecological restoration of mining sites in French Guiana by reducing the potential mobility of mercury.

1. Introduction

In the Amazon rainforest, several decades of gold mining activities and other anthropogenic activities have led to major environmental disruption due to the cumulative effects of deforestation, acid mine drainage and soil and water pollution from arsenic, cyanide and mercury contamination (Veiga *et al.*, 2006). Mining activity in the Amazon also leads to substantial degradation of the soil and its organic matter content (Wong, 2003), disruption of soil microorganism communities, and potential prevention of the expected ecological succession (Bradshaw, 1997a; Martínez-Garza and Howe, 2003).

Recent mining operations modify the topography of mining lands and expose the soils to sunlight and inclement weather conditions, and the absence of vegetation cover can facilitate erosion and the transport of particles containing trace elements into the water network (Lacerda *et al.*, 2004). In addition, this exploitation can create disorganized hydromorphic zones where anaerobic conditions can favour the activity of facultative and strict anaerobic bacterial communities (Guedron, 2008).

Soil microorganisms play an important role in the fate of metals in soils. Certain autotrophic bacteria of the genus *Acidithiobacillus* in aerobic environments can oxidize metal sulphides (Lombardi and Garcia, 2002; Ryu *et al.*, 1999), thus acidifying the environment due to sulfuric acid production, and they can also reduce iron and manganese (Bousserrhine *et al.*, 1999; Lovley, 1991), which promotes the release of some adsorbed metals (Schippers and Sand, 1999). Under anaerobic conditions, *Desulfovibrio* can reduce iron-hydroxysulphate minerals to sulphides (Ledin, 2000) and affect the mobilization of their associated trace elements. The sulphides released in this way can in turn adsorb trace elements, such as mercury, and form insoluble metal sulphides, such as cinnabar HgS. Sulphate-reducing bacteria (SRB) are also known as important methylators of inorganic Hg in anaerobic environments (Compeau and Bartha, 1985; Gilmour *et al.*, 1992). Under reducing conditions, ferri-reducing bacteria, such as *Clostridium sporogenes* and *Clostridium butyricum*, solubilize iron oxides by reducing Fe(III) to Fe(II), using it either as a major final electron acceptor in anaerobic respiration or as a minor electron acceptor during fermentation metabolism (Bousserrhine, 1995; Bousserrhine *et al.*, 1999; Lovley, 1991). The solubilization of iron oxides is concomitant with the solubilization of its associated trace metallic elements. Indeed, it is now recognized that the iron biogeochemical cycle is

associated with trace elements such as mercury (Roulet *et al.*, 1998; Roulet and Lucotte, 1995). In this context, ferri-reducing bacteria (FRB) were described as major agents that solubilize iron oxyhydroxide in anaerobic conditions and release the associated toxic metal (Cooper *et al.*, 2006; Gounou *et al.*, 2010; Harris-Hellal *et al.*, 2011; Lovley, 1993; Noubactep *et al.*, 2005). Several studies have demonstrated the presence and activity of certain soil-reducing microbial communities, such as iron-reducing bacteria (IRB) and sulfate-reducing bacteria (SRB), in natural sites and in gold washing sites in French Guiana (Guedron, 2008; Harris-Hellal, 2008; Harris-Hellal *et al.*, 2011).

In soils, mercury mobility modelling is complex, and its retention on clay minerals, on organic matter and on Fe-, Al- and Mn-(oxyhydr)oxides depends mainly on pH, redox conditions and the activity of anaerobic microbial communities (Alloway, 2012), which in turn depend on the topographic position, vegetation cover, hydromorphy and temperature (Cláudia M. Do Valle *et al.*, 2005; Fritsch *et al.*, 2007). Interactions between soil microbial communities and metal mobility have been described in the literature. However, only a few authors were interested in these mechanisms on Guyanese mining sites, and no study deals with microbial activity under anaerobic conditions on rehabilitated and restored former mining sites.

Due to the contributions of legislation in the management of gold mining sites, mining companies are now required to rehabilitate mining sites and, if possible, carry out an ecological restoration protocol (Le Roux, 2002). Legume species have been used in restoration efforts mainly because of their ability to grow on poor substrates while renewing the organic matter stock and limiting erosion (Loubry, 2002). However, this legislation is recent, and there is therefore a lack of data concerning the impact of ecological restoration in French Guiana on the fate of metallic elements, particularly under anaerobic conditions.

The objective of this research was to study the fate of soil metals (iron, aluminium, manganese and mercury) at various rehabilitated mining sites under hydromorphic conditions and the resulting anaerobic conditions that can promote IRB and SRB bacterial activities. Soil samples from rehabilitated and restored plots with different fabaceous species (*Clitoria racemosa* and *Acacia mangium*) were incubated under anaerobic conditions. The release of metals from soils into the culture medium and measurements of anaerobic microbial metabolism were monitored throughout the incubation period. This

approach improves our knowledge of microbial communities at rehabilitated sites in Guyana and our ability to assess the effect of this rehabilitation on soil quality.

2. Materials and methods

2.1. Site description and soil sampling

The work was undertaken in French Guiana, South America. Annual rainfall ranges from 2 m to 4 m, and the annual average temperature is approximately 26°C. The climate is classified as seasonal equatorial (Barret, 2004). The soils sampled for this study were rehabilitated after the more recent gold mining extraction, which occurred between 1990 and 1997. After closing the alluvial mine pit, rehabilitation consisted of returning the original soil that was excavated during mining. All excavated soils were then homogenized and flattened before ecological restoration began (Loubry, 2002). These soils could be considered anthroposols, and they have different structures and textures than natural tropical forest soils in the same topographic position.

Five sites were chosen to represent the restoration modality adopted. The first method of restoration consisted of filling the pit and allowing the natural return of vegetation to recover the site (N 04°30.311' / W 052°26.919'). The vegetation at this site covers from 5 to 10% of the soil surface and is only dominated by herbaceous species and ferns, and the site has therefore not been restored. We named this site NR to denote “*Non-Restored*”. This site, in the former mine of Yaoni, represents a negative control because of its complete lack of an ecological restoration programme.

The second selected site in the region of Belizon (N 04°22.509' / W 052°20.739') was rehabilitated, and an ecological restoration project was initiated but not monitored. More than 75% of the site is now mostly covered by *Lycopodiella sp.* and some Cyperaceae species (*Cyperus sp* and *Carex sp*), and no trees are present. We named this site Lyc to denote “*Lycopodiella*”.

The third method of restoration, in the region of Belizon, consisted of filling the pit and then introducing *Clitoria racemosa* in monoculture (N 04°29.860' / W 052°26.966'). The trees were planted with macro-cuttings in January 2013. Currently, the *Clitoria racemosa* plants are more than 4-5 metres high, and the restoration of the site is a success. We called this site Cli to denote “*Clitoria*”.

The fourth method of restoration, in the region of Yaoni, consisted of filling the pit and then introducing *Acacia mangium* in monoculture (N 04°29.860' / W 052°26.966'). The trees were planted with macro-cuttings in 1998. Currently, the *Acacia mangium* plants are more than 10 metres high, and the restoration of the site is a success. We called this site Aca to denote “*Acacia*”.

The fifth method of restoration, in the region of Yaoni, consisted of filling the pit and then introducing *Acacia mangium* and *Clitoria racemosa* (N 04°29.595' / W 052°26.984'). We called this site Mix to denote “*Mixed fabaceous*”. The trees were planted with macro-cuttings in 1998. Currently, the plants are more than 10 metres high, and the restoration of the site is a success. The Mix site, due to its complete restoration with a combination of Fabaceae, represents a positive example of successful ecological restoration at Guyanese mining sites.

At each site, soil samples were collected from depths between 0-10 cm with an auger in April 2016. The sampling at the 5 sites consisted of sampling 5 plots (n=5) per site, with 3 sub-samples per plot that were pooled at the laboratory. The 5 sampling plots per site were selected based on the topography of the terrain, the accessibility of the plots and the feasibility of sampling. All plots were in similar topographic environments at similar altitudes. Soil samples were immediately sealed in sterile hermetic polyethylene bags for transportation to the Cayenne IRD laboratory. Samples were then air-dried at ambient temperature (25°C) for approximately 3 weeks. These 75 collected samples (5 sites * 5 plots * 3 samples per plot) were then sieved at 2 mm, homogenized, and hermetically sealed at 4°C until use.

2.2. Initial soil sample characterization

Before the soil microcosm studies, effective cation exchange capacity (ECEC), pH, total major element (i.e., C, N, P, Fe, Al, Mn) content, total trace element (Hg) content, total organic carbon content, granulometry, and microbial biomass carbon (using the substrate-induced respiration (SIR) method) were determined to characterize the main physicochemical and biological properties; these measurements enabled us to assess the main differences between soils at initial conditions.

Soil total metal content:

For all metal analyses, the samples were first ground to 63 μm . To obtain total metal (i.e., Fe, Al, Mn) concentrations, soil samples were dissolved in cleaned Teflon digestion tubes (SCP Science) at 80°C in a mixture of concentrated HNO_3 -HF (3:1 ml) using a hot block (Digiprep MS, SCP Science). Samples were warmed at 80°C. Samples (300 mg) were then dissolved in 2 ml of concentrated HCl overnight at 80°C and then warmed for 4 hours at 80°C. Then, samples were diluted in 5% HNO_3 before analysis by inductively coupled plasma optical emission spectroscopy (ICP-OES, Spectroblue). All chemicals used were of trace element grade purity.

To carry out optimal speciation measurements of metallic trace elements in the soils, it is preferable to implement experiments on wet or frozen soils directly after sampling (Reis *et al.*, 2016). This prevents the redistribution of elements from the least mobile fractions to the more mobile/available fractions (Baeyens *et al.*, 2003; Claff *et al.*, 2010; Reis *et al.*, 2016). This conservation method, although optimal, is difficult to implement in a field campaign. In most studies, to minimize the loss of trace elements, particularly elemental mercury, samples are usually dried at room temperature over a period of 1-2 weeks and then sieved (Arenas-Lago *et al.*, 2014a; Grimaldi *et al.*, 2008; Guedron *et al.*, 2006; Silveira *et al.*, 2006) or freeze dried (Guedron *et al.*, 2009). Drying samples in a dry environment at a temperature of 25°C, as in our study, is appropriate for the determination of total mercury. This method of conservation is widely reported in the literature (Da Silva *et al.*, 2016; Guédron *et al.*, 2006; Harris-Hellal *et al.*, 2009). In addition to being easy to carry out, this method allows for the homogenization of the samples (Baeyens *et al.*, 2003; Reis *et al.*, 2015).

Soil total mercury content :

Mercury concentrations (HgT) in soil samples were determined directly by thermal decomposition atomic absorption spectrometry after gold amalgamation using an automatic mercury analyser (AMA 254, Simalab) with a detection limit of 0.01 ng. In brief, the samples were first ground to 63 μm , heated to 550°C, and all products of decomposition, including mercury, were carried by a stream of oxygen through a catalytic tube, where the HgT is transformed into elementary mercury (Hg^0), which then readily adsorbs to a gold trap. The fixed mercury is then released by heating the gold trap at 450°C, and the mercury is quantified by atomic adsorption spectrometry.

Soil carbon, nitrogen, and phosphorous measurement:

Soil total carbon (C_{tot}) and total nitrogen (N_{tot}) were determined by the Dumas method (NF ISO 13878). Briefly, the Dumas method consists of flash combustion of the soil sample (at 1000°C) using helium and oxygen. After purification of the combustion gases, determination of total carbon and nitrogen contents was performed by chromatography with a thermal conductivity detector (NA 1500 series 2 CARLO-ERBA).

Total phosphorus (P_{tot}) was determined after the acid digestion of soil samples, as previously described. The HPO_4 formed during acid digestion was measured after adding ammonium molybdate and ascorbic acid (Murphy and Riley, 1962) using the recommendations of the Spectroquant® phosphate test (ref: 114848). The colour produced by phosphomolybdenum (PMB) was measured by colourimetry at 885 nm (Genesys 10 μv Scanning, Thermo).

Water extractions were performed for total organic carbon (TOC), and concentrations were measured with a Shimadzu TOC-500 apparatus (Shimadzu, Kyoto, Japan). Briefly, 1 g of soil sieved at 2 mm was shaken for 24 hours in a polypropylene centrifuge tube with 10 ml of ultrapure water. The suspensions were centrifuged at 2000 rpm for 10 minutes, and supernatants were filtered at 0.2 μm (PTFE, VWR®) and directly analysed on the TOC analyser.

2.3. Experimental conditions

Microcosms were prepared to study microbial activity under anaerobic conditions. Thus, 125 ml sterile hermetic glass plasma bottles were filled with 15 g of soil and 100 ml sterile ultra-pure water. Microcosms were performed with 3 replicates for each plot at each site for a total of 75 microcosms (5 sites * 5 plots per site * 3 microcosms per plot).

The microcosms obtained were mixed with sterile spatulas and sealed with a butyl/PTFE shield cap (VWR®). Anoxic conditions were then initiated by flushing microcosms with N_2 for 10 minutes. The microcosms were incubated in the dark at 28°C for 35 days without shaking. The measurements were taken on days 7, 14, 21, 28 and 35. Then, 8 ml of medium culture was collected with a sterile syringe through the butyl/PTFE shield cap, which was then analysed for pH and the following concentrations in solution: sulfates, sulfides, ferrous iron, total iron, aluminium, manganese and mercury.

2.3.1. Bacterial metabolism

Immediately before the sampling of the culture medium, carbon mineralization was quantified in the microcosm atmosphere by measuring CO₂ evolution using micro gas chromatography (micro-GC 490, Agilent).

Dissolved organic carbon (DOC) concentrations in the culture medium were measured with a Shimadzu TOC-500 apparatus (Shimadzu, Kyoto, Japan) after being filtered at 0.2 µm (PTFE, VWR®).

Sulphur oxidation was followed by measuring sulfate (SO₄²⁻) formation in the culture medium. This was carried out using a kit (Spectroquant, Merck), similar to NF ISO 11048. This kit measures sulphate concentrations in the range of 5–250 mg SO₄²⁻ /l. Samples were filtered (0.45 µm, Minisart, Sartorius) prior to analysis.

Sulphate reduction was followed by measuring sulphide (S²⁻) formation in the culture medium. This was carried out using a kit (Spectroquant, Merck), similar to NF ISO 10530. This kit measures sulphide concentrations in the range of 0.02– 1.5 mg S²⁻/l. Samples were filtered (0.45 µm, Minisart, Sartorius) prior to analysis.

Soil pH-H₂O was measured in the culture medium by using a pH meter (MetrOhm 744).

2.3.2. Iron reduction in culture medium

To avoid any oxidation reactions, all samples used for the determination of iron (II) were immediately acidified to pH 1 with nitric acid (65%, Normatom) and stored at 4°C before analysis. Ferrous iron (Fe(II)) was measured in the medium using a colourimetric method with orthophenanthroline-chlorhydrate (Jackson and Barak, 2005). Briefly, 0.1-1 ml of filtered samples (0.45 µm acid rinsed filters, Minisart SRP 25, Sartorius) were put in a 25 ml graduated glass vial with 1 ml of orthophenanthroline (0.5%) and completed to 25 ml with MilliQ water. After 10 min, the absorbance was read at 490 nm (Genesys 10 µv Scanning, Thermo). Readings were compared to a standard curve established with dissolved anhydrous ferrous sulphate (Fe(NH₄)₂(SO₄)₂, 6H₂O).

2.3.3. Total iron, aluminium and manganese in culture medium

Total elements were analysed after filtration (0.45 µm acid-washed membrane filter, Minisart SRP 25, Sartorius) and acidification at pH 1 with HCl (37%) by inductively coupled

plasma optical emission spectroscopy (ICP-OES, Spectroblue). All chemicals used were of trace element grade purity.

2.3.4. Soluble mercury analysis

The mercury concentration in the culture medium was determined directly by thermal decomposition atomic absorption spectrometry after gold amalgamation using an automatic mercury analyser (AMA 254). All liquid samples were previously filtered (0.45 μm Teflon filters, Minisart SRP 25, Sartorius) and acidified to a pH of 1 (HCl, 37% Suprapur).

2.4. Statistical analysis

To determine the effect of vegetation cover on the microbial activities in anaerobic conditions, parametric tests were performed. The normality of data distributions and equal variance between treatments were tested using the Shapiro test and Bartlett's test, respectively. To study the effect of vegetation mode, the effect of incubation and the interactions between soils and time, we conducted a two-way ANOVA. Tukey's HSD multiple comparison method was used to test differences throughout the experiment at specific measurement points. To refine the analysis of the data, we also carried out repeated-measures ANOVA to determine the "sites" effect by taking into consideration the temporal evolution of the variables during the experiment.

To analyse the effect of the different restoration processes and experimental treatments on biogeochemical data (pH, CO₂, TOC, SO₄, S₂, Fe (II), Fe, Al, Mn and Hg), the results were also submitted to principal component analysis (PCA). The significance of each explanatory variable was tested using a Monte-Carlo permutation test. The R software was used for all statistical analyses (R version 3.3.2 (2016-10-31)).

2.5. Quality assurance and control (QA/QC)

To avoid contamination, all materials used in this work were acid-washed twice with HNO₃ (5%) and then rinsed several times with Milli-Q water before use.

Concerning mercury assays in samples, the relative error was routinely $\pm 5\%$ and was always under $\pm 10\%$. The detection limit (defined as three times the standard deviation (SD) of the blank) was 0.005 $\mu\text{g g}^{-1}$. Concentrations obtained for repeated analyses of certified reference materials never exceeded the published range of concentrations (i.e., $0.128 \pm 0.017 \mu\text{g g}^{-1}$ and $0.091 \pm 0.009 \mu\text{g g}^{-1}$ for BCR-277R and MESS-3, respectively). For total elements and trace elements, calibration was conducted using standard solutions for

spectroscopy (EnviroMAT Ground Water, High ES-H-2). The analytical errors were estimated by carrying out 3 measurements for each sample and were <10%.

3. Results

3.1. Soil physical and chemical properties of the 5 sites

The initial soil characteristics of the studied sites are summarized in **Table 1**.

The results for the granulometry demonstrated that the NR site is twice as clayey as other sites, with approximately 46.4% clay and 41.5% silt. In accordance with the soil triangle of texture, the Lyc site was silty with 65.8% silt on average. The Cli site was silt-clay-sand with 53.9% sand. The Aca and Mix sites had the same granulometry, with a dominance of sand over silt.

Soil pH-H₂O and pH-KCl measurements indicated that the site restored with *Acacia mangium* was more acidic than the other rehabilitated sites. These values were close to those for natural Oxisols or hydromorphic soil encountered in French Guyana (Da Silva *et al.*, 2016; Harris-Hellal *et al.*, 2011).

Among the three sites restored with Fabaceae, the total carbon, nitrogen and phosphorus contents were always significantly the highest in the mixed fabaceous site Mix. Macronutrient contents for the Mix site are similar to the natural soil data in French Guiana (Guedron *et al.*, 2009; Guédron *et al.*, 2006; Harris-Hellal *et al.*, 2011). Of the two restored sites with monoculture, the Aca site has higher levels of macro-elements than the Cli site. The total carbon content was 14.11 g kg⁻¹ at the Aca site and 7.01 g kg⁻¹ at the Cli site. The total nitrogen content was 1.12 g kg⁻¹ at the Aca site and 0.4 g kg⁻¹ at the Cli site. The total phosphorus content was 0.37 g kg⁻¹ at the Aca site and 0.17 g kg⁻¹ at the Cli site. The total carbon, nitrogen and phosphorus contents at the spontaneous vegetation site NR were low compared to natural soils.

The five sites are rich in iron with a minimum of 44.56 g kg⁻¹ at the Lyc site and a maximum of 113.3 g kg⁻¹ at the Cli site, which seems consistent with Guyanese soils (Da Silva *et al.*, 2016; Harris-Hellal *et al.*, 2011, 2009). The aluminium contents at the sites are similar and are higher than the natural content in French Guiana. Manganese levels are low at the Lyc and Cli sites (0.10 g kg⁻¹ and 0.11 g kg⁻¹, respectively), and the Mix site has the highest concentration of total Mn. Mercury levels for NR and Lyc are significantly lower than for

other sites. These concentrations were still low compared to other reported gold-mined soils in French Guiana (Guedron *et al.*, 2009) but remained within the normal range of mercury measurements in French Guiana (Guedron *et al.*, 2009).

The values of soil effective cation exchange capacity were similar between the former mine sites with a range of 5.28 cmol₍₊₎ kg⁻¹ for NR and 7.41 cmol₍₊₎ kg⁻¹ for Mix site.

The three sites restored with fabaceous species had significantly higher soil microbial biomass levels than the NR and Lyc sites. The maximum biomass was for the Mix site, while the minimum biomass was for the NR site, with values of 1103 mg kg⁻¹ and 223 mg kg⁻¹, respectively.

Table 1:

C_{tot}, N_{tot}, P_{tot} : Total C, N and P ; TOC : Total Organic Carbon ; MBC : Microbial biomass carbon; Total Fe, Al, Hg : Total Iron, Aluminum and Mercury content, (n=5, mean ± SD)

Sites						pH		Total						
	C _{tot} g.kg ⁻¹	TOC g.kg ⁻¹	MBC mg.kg ⁻¹	N _{tot} g.kg ⁻¹	P _{tot} g.kg ⁻¹	pH-H ₂ O	pH-KCL	Fe g.kg ⁻¹	Mn g.kg ⁻¹	Al g.kg ⁻¹	Hg µg.kg ⁻¹	Clay %	Silt %	Sand %
NR	6.01 ±0.32	3.88 ±0.04	223 ±10.8	0.40 ±0.03	0.21 ±0.04	5.26 ±0.23	4.5 ±0.11	65.15 ±3.17	0.52 ±0.05	53.88 ±1.53	0.23 ±0.01	46.4 ±3.6	41.5 ±2.8	3.3 ±0.2
Lyc	9.55 ±0.73	5.84 ±0.35	385.9 ±21.5	0.45 ±0.01	0.27 ±0.07	4.66 ±0.07	4.21 ±0.09	44.56 ±0.77	0.10 ±0.003	41.33 ±1.77	0.23 ±0.07	22.2 ±5.1	65.8 ±3.2	11.8 ±1.2
Cli	7.01 ±0.83	5.0 ±0.4	844.4 ±14.03	0.40 ±0.04	0.17 ±0.02	5.0 ±0.03	4.45 ±0.13	113.3 ±4.2	0.11 ±0.004	25.5 ±2.15	0.28 ±0.03	21.3 ±1.6	24.8 ±3.7	53.9 2.5
Aca	14.11 ±1.2	10.55 ±0.62	944 ±79	1.12 ±0.07	0.37 ±0.12	4.21 ±0.07	3.74 ±0.26	53.69 ±4.15	0.25 ±0.05	45.31 ±6.51	0.48 ±0.04	18.4 ±2.5	35.6 ±3.9	41.6 ±4.4
Mix	22.88 ±1.5	15.58 ±1.41	1103 ±41	1.81 ±0.10	0.76 ±0.15	4.66 ±0.11	3.88 ±0.45	71.02 ±1.37	0.54 ±0.03	43.76 ±1.21	0.41 ±0.05	19.8 ±3.8	32.4 ±4.9	36.4 ±5.9

3.2. pH in the culture medium during incubation

The ANOVA showed that medium pH (Figure 1) was affected by vegetation cover (p < 0.05), but repeated-measures ANOVA showed (Table 2) that the pH change during incubation was similar between different soils, with no incubation time effect. The two sites without tree cover (NR and Lyc) had significantly more acidic pH levels than the sites that had been effectively restored (Cli, Aca and Mix sites).

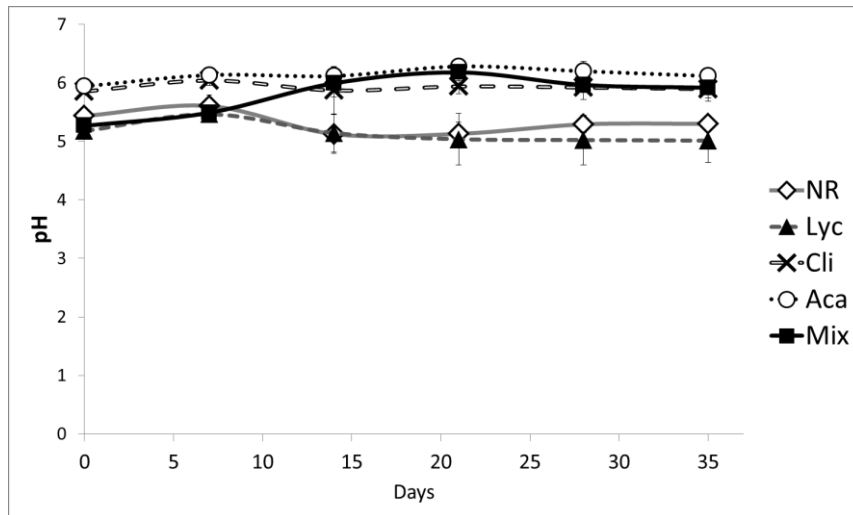

Figure 1:

Changes in pH during 35 days of anaerobic incubation in the five sites (n=5, mean \pm SD).

3.3. Heterotrophic metabolism and dissolved organic carbon

Heterotrophic respiration (Figure 2) and organic carbon dissolution (Figure 3) were both affected by vegetation cover and incubation period, and the interaction of these two factors had a clear effect. Heterotrophic respiration for Aca and Mix were quite close and significantly higher than other sites. The non-restored Lyc site had a greater heterotrophic respiration than the restored Cli site and NR site. The dissolved organic carbon content in the culture media was significantly higher in the two restored sites, Aca and Mix, than in the other three sites, with a clear increase until day 21. For the NR, Lyc and Cli sites, soluble carbon production was very low, with a slight peak in the first 15 days of incubation.

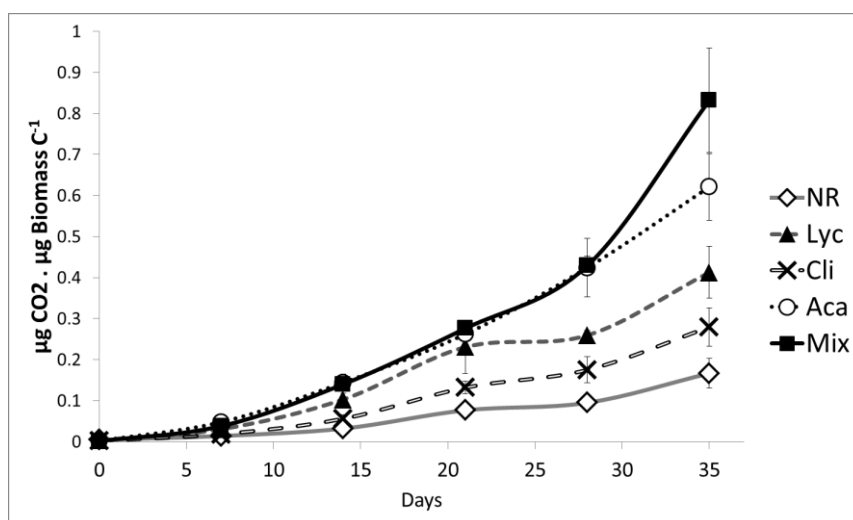

Figure 2:

Carbon mineralization during 35 days of anaerobic incubation in the five sites (n=5, mean \pm SD).

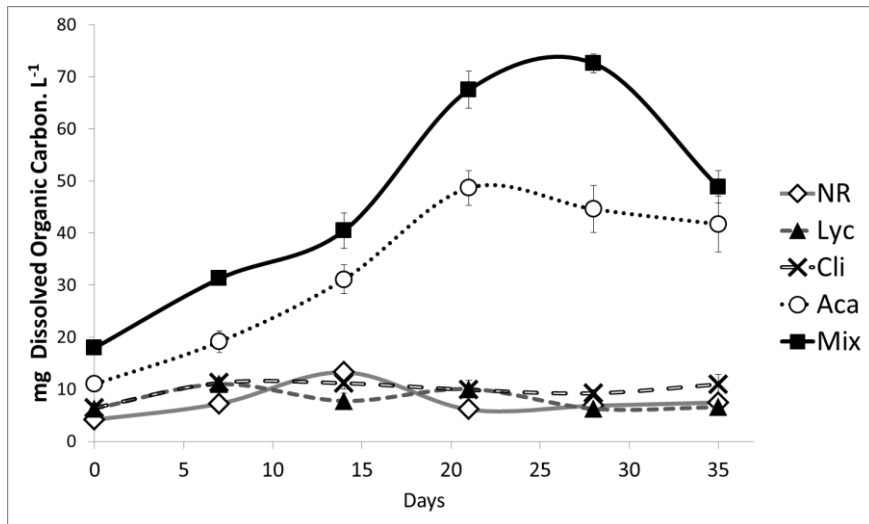

Figure 3:

Changes in total organic carbon concentration in solution during 35 days of anaerobic incubation in the five sites (n=5, mean ± SD).

3.4. Sulfate and Sulfide evolution in the culture medium

Sulfate (Figure 4) and sulfide content (Figure 5) in the culture medium were both affected by vegetation cover and incubation period, and the different sites evolved differently during incubation. For the 5 sites, the sulfate concentration in the solution increased during kinetics, with stagnation from day 21 for all sites except the Aca site. The highest sulfate concentrations were observed at the Lyc, Aca and Mix sites, while the restored Cli site showed the lowest increase in sulfate concentration during incubation. The evolution of sulfide concentrations showed very different trends. There was no sulfide production in the NR environment and very low production in the environments of the two restored sites Aca and Mf. For the Lyc and Cli sites, a strong increase in sulfide levels was observed between day 21 and day 28 of incubation.

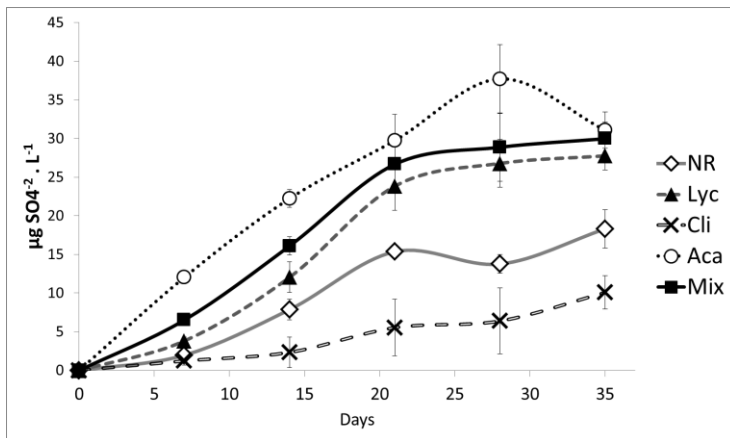

Figure 4:

Changes in Sulfates concentration in solution during 35 days of anaerobic incubation in the five sites (n=5, mean ± SD).

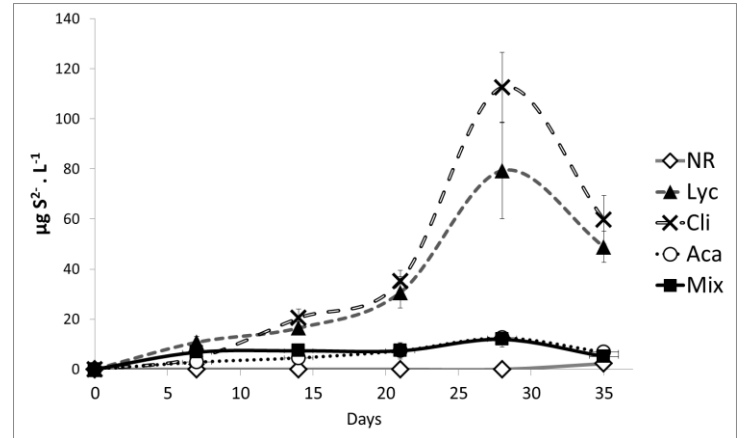

Figure 5:

Changes in Sulfides concentration in solution during 35 days of anaerobic incubation in the five sites (n=5, mean ± SD).

3.5. Metals solubilization

The ANOVA showed (Table 2) that all trace element concentrations in the culture medium were affected by both vegetation cover and incubation period, and the different sites evolved differently during incubation.

3.5.1. Iron in the culture medium

Concentrations of both total iron (Figure 6) and iron (II) (Figure 7) followed similar trends. No iron solubilization was detected in culture media at NR sites throughout incubation. Total iron solubilization was detected similarly in the Lyc and Cli microcosms, but the reduction of iron to iron (II) was slightly greater for the Lyc site during the first two weeks of incubation. The evolution of total iron solution levels for the Aca and Mix sites was similar during the first 3 weeks, but a shift was observed from this date with an increase in iron concentration for the Mix site and stagnation for the Aca site. Concerning iron reduction, the rate of change in iron (II) concentrations for the Aca and Mix sites was the same, but with approximately twice as much reduction observed for the Mix site.

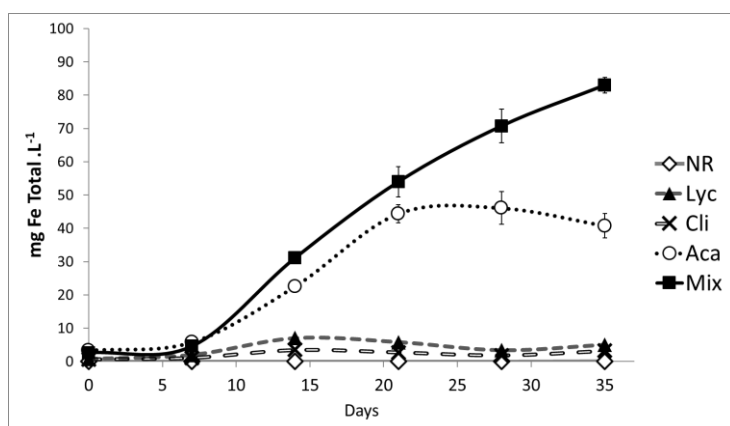

Figure 6:

Changes in Total Iron concentration in solution during 35 days of anaerobic incubation in the five sites (n=5, mean \pm SD).

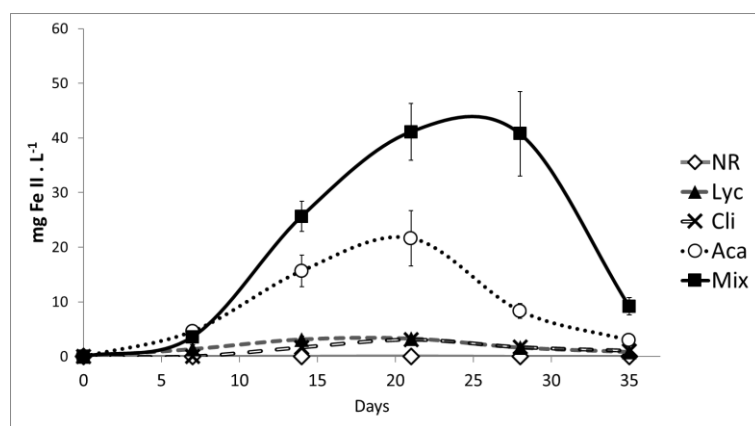

Figure 7:

Changes in Fe (II) concentration in solution during 35 days of anaerobic incubation in the five sites (n=5, mean \pm SD).

3.5.2. Manganese in the culture medium

Measurements of soluble manganese in solution in culture media (Figure 8) showed very similar trends to those of total soluble iron. Indeed, manganese detection was very low for the NR, Lyc and Cli sites, whereas the Aca and Mix sites had significantly higher manganese solubilization. Manganese levels in media stabilized from day 21 for Aca and 28 for Mix at

concentrations of approximately 8 and 10 mg Mn l⁻¹ for Aca and Mix site samples, respectively.

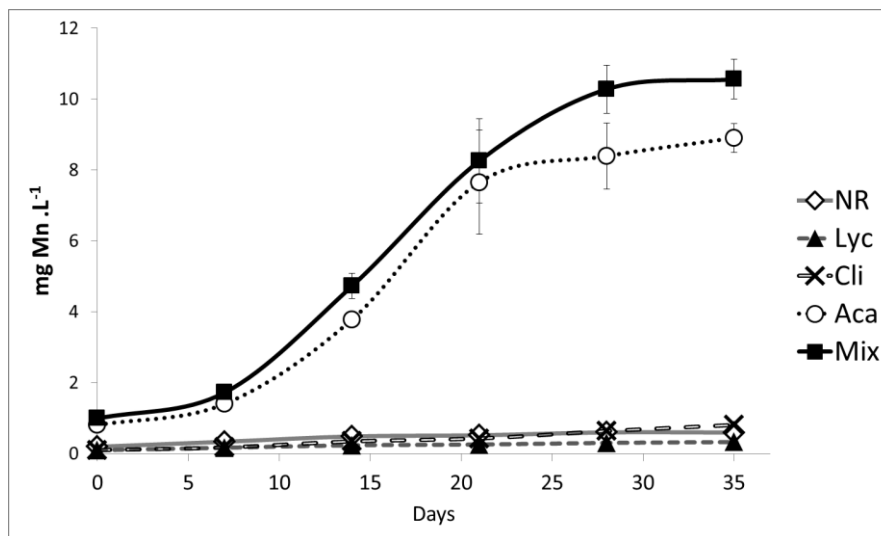

Figure 8:

Changes in Total Mn concentration in solution during 35 days of anaerobic incubation in the five sites (n=5, mean ± SD).

3.5.3. Aluminium in the culture medium

The evolution of soluble aluminium levels (Figure 9) in the media looked very different from the observed for iron and manganese solubilization measurements. No aluminium levels were detected for the NR and Lyc sites during incubation. A slight aluminium solubilization was detected for the Aca site but without a significant change during incubation. However, the Cli and Mix sites had peak concentrations on day 14 for Cli and on day 21 for Mix at approximately 0.8 mg and 1.4 mg Al l⁻¹ for the Cli and Mix sites, respectively.

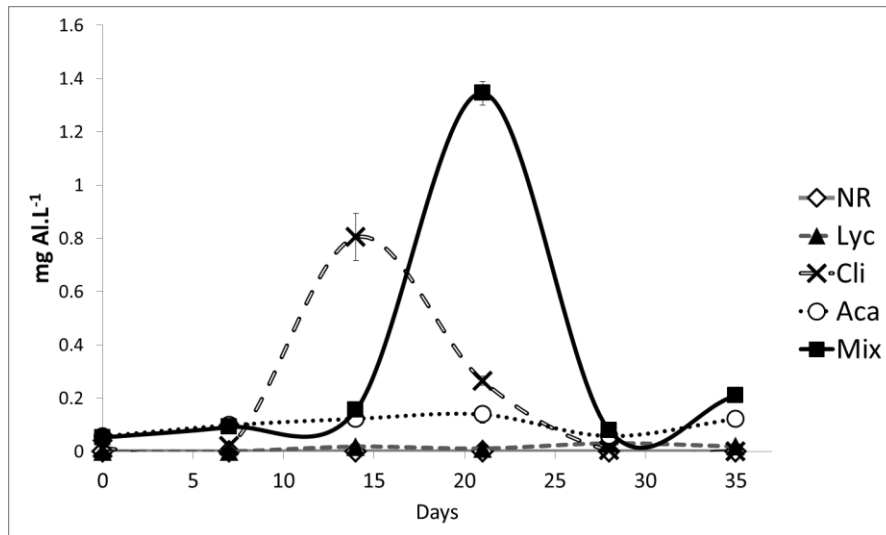

Figure 9:

Changes in Total Al concentration in solution during 35 days of anaerobic incubation in the five sites (n=5, mean \pm SD).

3.5.4. Mercury in the culture medium

Measurements of soluble mercury in media (Figure 10) showed two significantly distinct trends. On the one hand, the restored sites with significant vegetation cover (Cli, Aca and Mix) had very low levels of soluble mercury, without major changes in concentrations during incubation. On the other hand, the two sites that were not restored by tree cover (NR and Lyc) showed a significant increase in soluble mercury levels that stabilized at a concentration of approximately $0.35 \text{ ng Hg l}^{-1}$ on day 28 before decreasing at the end of incubation.

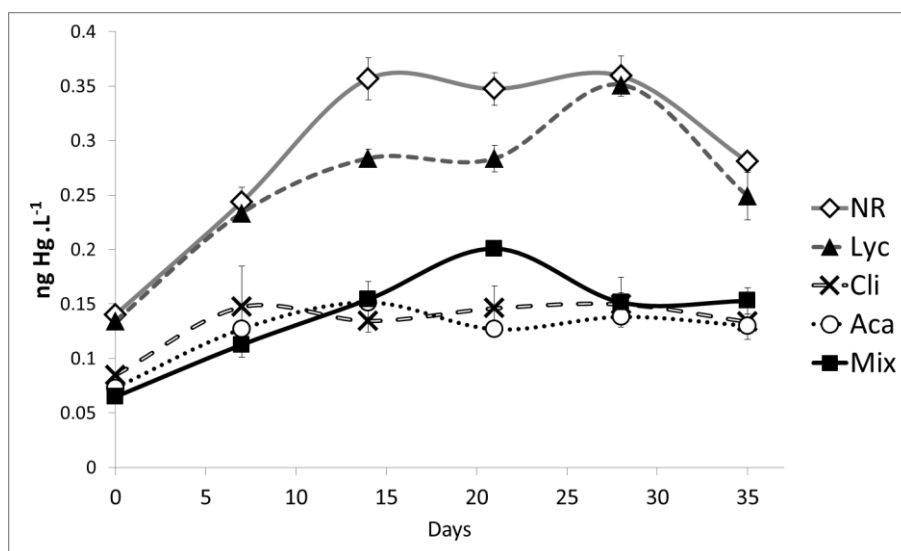

Figure 10:

Changes in Total Hg concentration in solution during 35 days of anaerobic incubation in the five sites (n=5, mean \pm SD).

Table 2:

Effects of vegetation and incubation in anaerobic conditions on soil pH, heterotrophic respiration, dissolved organic carbon, sulfates and sulfides content and iron, aluminum, manganese and mercury solubilization for five rehabilitated mining sites in mesocosm experiment in a two-way ANOVA and repeated-measures ANOVA.

	Sites	Time	Sites * Time	Repeated-measures ANOVA	
Df	4	5	20	5	
pH	F-value	114*	0.9	4.8*	0.61
Heterotrophic respiration ($\mu\text{g CO}_2 \cdot \mu\text{g Bio C}^{-1}$)		175*	513	35.6	14*
Dissolved Organic Carbon ($\text{mg DOC} \cdot \text{L}^{-1}$)		215*	108*	105*	1.6
Sulfates ($\mu\text{g SO}_4^{2-} \cdot \text{L}^{-1}$)		59.9*	96.3*	4.4*	21*
Sulfides ($\mu\text{g S}^{2-} \cdot \text{L}^{-1}$)		305*	214*	58.5*	3.7
Soluble Fe II ($\text{mg Fe II} \cdot \text{L}^{-1}$)		280*	174*	64.7*	2.8
Total soluble Fe ($\text{mg Fe} \cdot \text{L}^{-1}$)		534*	285*	120*	2.65
Total soluble Al ($\text{mg Al} \cdot \text{L}^{-1}$)		956*	864*	387*	3.6
Total soluble Mn ($\text{mg Mn} \cdot \text{L}^{-1}$)		446*	375*	116*	3.2
Total soluble Hg ($\text{mg Hg} \cdot \text{L}^{-1}$)		205*	66.5*	6.2*	11.3*

Table 3:

Pearson correlation coefficients for the data monitored during anaerobic experiment. * Significant at the $P < 0.05$

	pH	Sulfate	Sulfide	CO2	DOC	Fell	Fe	Mn	Al	Hg
pH	1	0.232	-0.135	0.288	0.603*	0.470*	0.551*	0.595*	0.479*	-0.621*
Sulfate		1	0.141	0.810	0.666*	0.527*	0.742*	0.765*	0.229	0.180
Sulfide			1	0.197	-0.209	-0.117	-0.148	-0.186	-0.070	0.102
CO2				1	0.609*	0.343	0.800*	0.786*	0.095	-0.049
DOC					1	0.876*	0.926*	0.940*	0.514*	-0.286
Fell						1	0.749*	0.719*	0.629*	-0.141
Fe							1	0.977*	0.409*	-0.218
Mn								1	0.384*	-0.252
Al									1	-0.212
Hg										1

3.6. Principal component analysis of microbial reducing activities and metal solubilization

In our study on the impact of the nature of the vegetation cover, the quality of ecological restoration was detected, as shown in Figure 11, which shows the results of PCS analysis on the data set obtained after incubation under a controlled anaerobic conditions approach. The Eigen values calculated by the PCA statistical analysis determined that two axes were significant, accounting for 54.4 and 17.5% of the total variance. Axis 1 was best represented by variables consisting predominantly of heterotrophic respiration and soluble content of dissolved carbon, sulfates, iron, and aluminium, while Axis 2 was mainly linked to sulfide concentration in solution. In addition, mercury concentration and pH were negatively correlated. T-test comparisons enabled us to distinguish significant differences between the five sites with clusters ($p = 0.001$). The data clusters for the NR and Lyc sites are not significantly different from one another but very different from the three clusters for the restored Cli, Aca and Mix sites. The cluster for the restored Cli site seems to be relatively separate from the other restored sites, whereas the Aca and Mix sites are very close.

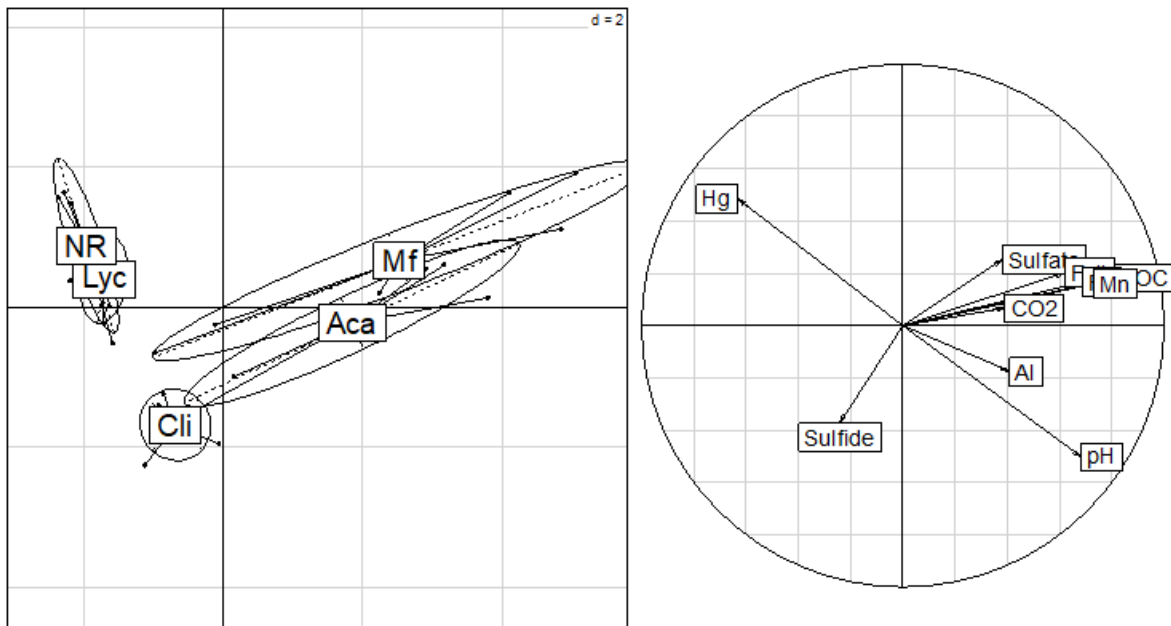

Figure 11:

Principal Component Analysis (PCA) on the data monitored during the anaerobic experiment with types of vegetation cover. left: projection of data set variability plotted on a factorial map of the first two discriminating axis according to respective factor. Labels on the gravity center correspond to sub-factor of respective factor. right: correlation circles plot with variable vectors (pH, CO₂, DOC, SO₄²⁻, S²⁻, Fe II, Fe, Al, Mn, Hg) for each respective factor. Types of vegetation cover: NR. Non-Restored with only spontaneous vegetation, Lyc. *Lycopodiella sp*, Cli. Monoculture of *C.racemosa*, Aca. Monoculture of *A.mangium*, Mix: Mixed fabaceous culture. Eigen values 54.4%, 17.5% for axes 1 to 2 respectively. Randtest: simulated p-value: 0.001. Explained variance : 47.1%.

4. Discussion

The main objective of this study was to determine the impact of the anaerobic microbial activity on metal solubilization in soils of old gold mines rehabilitated and restored by revegetation protocols. A kinetic approach under controlled reducing conditions was adopted in which factors related to carbon and sulphur metabolism were measured. The solubilization of iron, aluminium, manganese and mercury in culture media was also monitored to link the impact of different ecological restoration approaches on the mobilization of certain metallic elements.

In iron-rich soils such as Guyanese mining soils, it is generally accepted that iron molecules, and in particular iron oxides, are sinks for a wide range of metallic elements, including aluminium and manganese, and trace elements, such as mercury or cadmium, and that the biogeochemical cycles of these elements are closely linked (Bousserrhine *et al.*, 1999, 1998; Cooper *et al.*, 2006; M *et al.*, 2001; Noubactep *et al.*, 2005; Roulet *et al.*, 1998). Mercury has also been shown to have affinity for Al- and Mn-(oxyhydr)oxides (Alloway, 2012; Anderson, 1979; Roulet *et al.*, 1998), particularly in oxide-rich soils such as Guyanese soils. However, bacterial solubilization of these oxides can lead to re-mobilization of mercury and increase its mobility and toxicity (Cooper *et al.*, 2006; Gounou *et al.*, 2010; Harris-Hellal *et al.*, 2011; Lovley, 1993; Noubactep *et al.*, 2005). While these microbial mechanisms have been described in natural or anthropized soils, no studies have addressed these processes in rehabilitated soils. These results allow us to estimate the influence of different ecological restoration protocols on reducing microbial activities and on the potential mobility of mercury on rehabilitated sites, which are essential data needed to assess the quality of ecological restoration.

4.1. Properties of the rehabilitated soils and distribution of the various trace elements

The soils in this study were all completely destructured and redesigned due to gold mining. Therefore, they can be considered anthroposols, and the comparison of their soil properties with natural Guyanese soils such as oxisols, acrisols or Gleysols does not seem relevant. The differences in soil texture were primarily due to uneven site reworking after gold mining. These differences were observed not only at the Belizon sites, between the silty Lyc site and the sandy Cli site, but also at the Yaoni sites, between the silty clay NR site and the two

sandy-silty Aca and Mix sites. Such variation in texture for nearby sites that had the same mining process was noted in Schimann's (2007) work on rehabilitated sites in Guiana (Schimann *et al.*, 2007) and show difficulty in applying the recommendations of ecological restoration management (Loubry, 2002) and the instructions of the mining code (Le Roux, 2002). If the significant textural differences make it difficult to compare the pedogenesis of these soils, then this study highlights the consequences of this heterogeneity; regardless, the comparison of sites seems interesting. Due to the mobility of trace elements in tropical soils being linked to the physical properties of the soil, there could also be an impact on metal transfers in the water network. Variations in metal contents must be taken into consideration. Total iron concentrations in the sample soils were similar to concentrations found in gleysols and oxisols (Harris-Hellal *et al.*, 2011), with strong heterogeneity between sites but no significant correlation with soil texture parameters, carbon content ($p = 0.62$) or microbial biomass ($p = 0.07$) and no relationship to canopy density level. Nevertheless, the forms of iron in these soils could be different, which would impact solubilization kinetics. The distribution of manganese and aluminium also appeared to be random among the various rehabilitated sites. Nevertheless, mercury levels may reflect different geochemical behaviours. While mercury concentrations were not correlated with soil texture parameters (Table 2), they were positively correlated with organic matter concentration ($p = 0.0001$) and microbial biomass ($p = 0.0001$), which is consistent with the literature as described by Schuster *et al.* (1991) and Skyllberg *et al.* (2000) showing the high affinity of mercury for organic matter, particularly for sulphide groups (Schuster, 1991; Skyllberg *et al.*, 2000). In addition, the dense vegetation cover from the Aca and Mix sites may have contributed to fixing mercury in soils and limiting its mobility (Couic *et al.*, 2018). Vegetation allows atmospheric mercury to be fixed in leaves and in litter deposits. This result could confirm the positive contribution of ecological restoration in limiting mercury transfers into the water network by limiting erosion processes; however, we do not have soil samples taken directly after rehabilitation, and the heterogeneity of initial mercury concentrations cannot be excluded.

There were also significant differences in soil microbial biomass, which were directly related to the density and quality of the vegetation cover. These results, already highlighted by various works on rehabilitated sites, confirm the contribution of successful ecological

restoration in the recovery of soil microbial biomass (Couic *et al.*, 2018; Schimann *et al.*, 2012a, 2007; Valentim dos Santos *et al.*, 2016), especially on the rehabilitated sites of Yaoni.

4.2. Microbial activities during the anoxic soil experiment

The experimental variables measured during the anaerobic experiment indicated different microbial behaviours under reducing conditions depending on the ecological restoration modalities. The results were confirmed by the significant ($p < 0.001$) results of the principle component analysis (Figure 8), which showed a clear separation of the rehabilitated sites according to the nature of their vegetation cover. Thus, the two restored sites, Aca and Mf, were on the positive side of axis 1 and were mainly characterized by important biological and reducing activities (Fe and Mn), with the Cli site relatively close but nevertheless on the negative side of axis 1. These three sites, where ecological restoration has been accomplished with the efficient establishment of fabaceous macro-cutting, are significantly different from the two rehabilitated sites NR and Lyc, which were mainly characterized by a strong dissolution of mercury and are sites where ecological restoration has not been controlled and effective. Except for mercury, the experimental variables were strongly correlated with microbial biomass concentrations in the samples, and no dissolution of iron and aluminium could be detected in the media containing the NR soil samples.

During the experiment, CO₂ production, dissolved organic carbon and sulphate solubilization were significantly correlated with iron and manganese dissolution (Table 3), which could show that the Fe and Mn reduction is of biological origin (Bousserhine *et al.*, 1999; Lovley, 1987). Differences in dissolved organic carbon concentrations between restored and non-restored sites could be explained by differences in total microbial biomass and therefore total activity, as well as the quality and dynamics of organic matter. It would therefore be interesting to characterize labile and recalcitrant organic matter as suggested by Schimann (2007). We observed that the peak concentrations of these products were at slightly different measurement times. Measurements of soluble sulphates increased rapidly from the beginning of the kinetic analysis, followed by measurements of dissolved iron and manganese, which increased from day 7, while concentrations of CO₂, DOC and S²⁻ increased only slightly in the first 15 days.

From a thermodynamic point of view, iron reduction is generally more efficient under reducing conditions (Lovley, 1991) and occurs before sulphate reduction and CO₂ production

through methanogenesis by acetotrophic and methylotrophic Archaea (Liu *et al.*, 2009), which seems to agree with the results observed in this study.

These results appeared to confirm the presence and activity of iron-reducing bacteria at the restored Aca and Mix sites. For the Aca and Mix sites, the results show an interesting coupling between the dissolution of iron and manganese oxides, probably in the form of Mn^{2+} due to the maintenance of reducing conditions throughout the experiment. The strong correlation between manganese and dissolved iron ($R^2 = 0.977$), also observed by Gounou *et al.* (2010) and Bousserhine *et al.* (1999), could be explained both by the presence of manganese-reducing bacteria or by the release of adsorbed manganese to iron oxides when ferrous iron is reduced (Bousserhine *et al.*, 1999; Gounou *et al.*, 2010; Martin, 2005).

It is interesting to note the differences between the solubilization of iron and Mn and the solubilization of aluminium. The dissolution dynamics of aluminium oxides could indicate different speciation of metal elements between sites. The rapid dissolution of aluminium oxides for the Cli site could indicate the presence of amorphous oxides, which are easily soluble, while in the Aca site, the very low mobilization of aluminium would indicate the presence of crystallized oxides. For the Mix site, the later dissolution of aluminium relative to iron could indicate the presence of substituted iron oxides containing aluminium, which would therefore be solubilized more slowly. These differences highlight the importance of oxide species and character in metal mobilization mechanisms, and it has been shown that the nature of oxides is one of the most important factors involved in metal element mobilization processes (Bousserhine *et al.*, 1999; Harris-Hellal *et al.*, 2011).

Iron-reducing activities were also supported by the rapid increase in sulphate levels in culture media, which may be associated with desorption of sulphates bound or adsorbed to Fe(III)-(hydr)oxides (Rose and Ghazi, 1997). Although it was widely demonstrated that sulphate-reducing bacteria are also involved in the reduction of iron oxides (Lovley, 1991; Roden and Lovley, 1993), their presence in these rehabilitated sites did not seem to be obvious. Indeed, there is no correlation between sulphate and sulphide content experimental variables. There is also no positive correlation between sulphate concentrations and sulphide concentrations, which would indicate very different sulphate-reducing activities between the rehabilitated sites. The peak sulphide production for the Lyc

and Cli sites would confirm the presence and activity of SRB, but the results for the other sites would indicate heterogeneity of SRB communities in the rehabilitated soils.

The low sulphide contents during the experiment in NR, Aca and Mix samples suggest that sulfate-reducing communities are not very active, and several factors could explain these low activities. In the Aca and Mix sites, the low SRB activities could be explained by high competition with iron-reducing bacteria, generally described as more competitive in an acidic environment (Blodau, 2006; Colleran *et al.*, 1995; Stams *et al.*, 2005). For the NR site, the more acidic pH during the experiment could also explain the low sulfate-reducing activities because these bacteria are generally more active in a pH range of 6-8 (Hao *et al.*, 1996; Widdel, 1998). The very low overall heterotrophic metabolic activities recorded for the NR site could also be the cause of this lack of sulfate-reducing activities.

However, these chemical measurements may not reflect the observations of our culture media during the experiment. After 15 days of incubation, all of the culture bottles had turned blackish, and the culture medium samples had a very marked odour of H₂S, indicating a priori the presence of iron sulphide, certainly linked to the presence of SRB.

The very low sulphide contents measured could then be explained by both H₂S degassing or potential metal sulphide precipitation (Lewis, 2010). Indeed, the possible precipitation mechanisms of H₂S with iron under acidic conditions could explain the very low levels measured during the experiment (Holmer and Storkholm, 2001; Koschorreck, 2008).

Because Coleman demonstrated that sulfate-reducing bacteria could reduce iron enzymatically (Coleman *et al.*, 1993) the presence of sulfides in culture media could correlate with Lovley's work, where he associated iron reduction and iron sulfide production (Lovley, 1991). Thus, in this experiment, the activities observed correspond to the interactions between reducing communities. It would be interesting to test this hypothesis by discriminating between the two communities with the addition of specific substrates such as acetate or lactate to favour sulfate-reducing communities.

4.3. Mercury dissolution during the anoxic soil experiment

The dissolution of mercury in mesocosms under anaerobic conditions showed very contrasting results with other metallic elements, and the principal component analysis (Figure 8) clearly showed dissolution of mercury, which depends on the density of the

vegetation cover, associated with an increase in solubilization processes on the least restored NR and Lyc sites. No significant correlation was found (Table 3) with the other controlled variables during the experiment, except for a negative correlation with pH ($R^2 = -0.621$). These results confirmed that soil pH is a key factors affecting the adsorption-desorption behaviours and, hence, bioavailability of heavy metals in soil, especially mercury (Gabriel and Williamson, 2004).

In the literature, iron oxide reduction processes, mainly microbial (Stemmler and Berthelin, 2003), are at the origin of the release and mobilization of adsorbed trace elements (Bousserhine *et al.*, 1999; Cooper *et al.*, 2006; Lovley, 1991; Noubactep *et al.*, 2005), including mercury. However, anoxic soil conditions are not always synonymous with the mobilization of mercury (Wasserman *et al.*, 2003). In this study, the reduction and dissolution of iron, manganese, and aluminium, which are considered important carrier phases of mercury, have a relatively limited effect on mercury mobilization in the culture medium.

These results could be similar to Harris's (2011) work (Harris-Hellal *et al.*, 2011), which showed that bacterial reduction of iron oxides, unlike chemical reduction, was not always synonymous with mercury mobilization. However, it cannot be excluded that mercury speciation in soil phases may have changed during the experiment, a result also highlighted by Harris.

Although the dissolution of mercury and the other variables controlled during the experiment are not correlated, we measured significant negative correlations of mercury dissolution with the parameters related to the organic matter content in the soil. For microbial biomass, TOC, carbon, and total nitrogen, the correlations with mercury dissolution were $r = -0.87$, $r = -0.55$, $r = -0.5$ and $r = -0.51$, respectively. These results could mean that the higher the organic matter content in reclaimed soils, the greater the retention of mercury and the lower its mobility. However, the measurement of total microbial biomass does not only reflect the presence of IRBs, SRBs and methanogens, nor do quantitative measurements of organic matter reflect its nature and quality. Several authors have highlighted similar results. Anderson (Anderson, 1979) showed that the affinity for and retention of mercury in organic matter in acidic soils could exceed the affinity for metal oxides, as confirmed by recent studies on mercury speciation at former Guyanese mining

sites (Couic *et al.*, 2018; Guedron *et al.*, 2009). Roulet and Lucotte's (Roulet and Lucotte, 1995) work highlighted that mercury retention in Guyanese soils was not always correlated with the presence of metal oxides. However, recent studies show that the retention of mercury, if it is adsorbed on iron oxides, would depend more on the nature of the oxides than on their total concentration in the soil. Harris *et al.* (2009) and Guedron *et al.* (2009) have indeed shown on Guyanese sites that iron speciation and the amount of crystalline and amorphous oxides are important drivers of mercury dynamics. Differences in mercury speciation in soil phases could therefore be a key factor in its solubilization and mobilization (Navarro, 2008).

Speciation of mercury at the restored Cli, Aca and Mix sites, due to microbial dynamics and organic material turnover approaching a natural site, may have been altered to insoluble forms such as HgS. Indeed, due to its chalcophile character, mercury in natural conditions in well-oxygenated soils is mainly found in the form of cinnabar (HgS), a sulfide that is not easily weathered (Navarro, 2008). The increased presence of soluble and non-adsorbed forms of mercury at NR (Figure 7) and Lyc sites, including alkyl and inorganic mercury species, may also confirm that the solubility and reactivity of mercury at rehabilitated but non-restored sites is greater than at restored sites (Couic *et al.*, 2018). In this study, soluble mercury is also negatively correlated with total mercury ($r = -0.68$, which could show that mercury mobility is not related to its total concentration in soil).

The low concentrations of dissolved mercury at the Cli, Aca and Mix sites could also be explained by the high presence of sulphate-reducing bacteria. Under anoxic conditions, these bacteria will produce sulphides that can complex with mercury to form mercuric sulphide complexes (Benoit *et al.*, 2001), which is very insoluble compared to other forms of mercury (Navarro, 2008), and form the black precipitate in the mesocosms that were observed in our experiment and in the Gounou experiment (2012). Although dissolution of HgS is possible in acidic media (Balland-Bolou-Bi *et al.*, 2019; Navarro, 2008) with low molecular mass organic acids and root exudates, the experiment may not have lasted long enough to observe significant changes in dissolved mercury in the restored Cli, Aca and Mix sites. In addition, the estimation of other forms of mercury, such as methylmercury, during the experiment would allow us to estimate a toxicity potential based on environmental speciation.

Conclusion

The ecological restoration of alluvial mining sites in French Guiana is recent and essential for the sustainable development of the gold industry in tropical regions. In this study, the comparison of the soil quality of 5 vegetation restoration modalities, as well as a simulation of the hydromorphic period with an anaerobic mesocosms experiment, revealed very contrasting results on reducing microbial activities and on the dynamics of metallic elements. First, the results show a clear improvement in the physicochemical quality of the Aca (*Acacia mangium*) and Mix (*Acacia mangium* and *Clitoria racemosa*) sites, which shows the positive effect of successful ecological restoration. Second, the simulation of flooding periods with the mesocosms showed interactions between iron- and sulfato-reducing activities depending on the rehabilitated sites. The two old restored sites (Aca and Mix) had predominant iron-reducing activities with the carbon and sulphur cycles coupled and a high potential for solubilization of iron and manganese. The restored Cli site and non-restored Lyc site had predominant sulfato-reducing activities and very low ferri-reducing activities. Regarding the dynamics of mercury, its solubilization was twice as important at the two sites without tree cover restoration, which could lead to higher methylation potentials. Because these results provide information on the dynamics of microbial communities in association with the mobility of metallic elements, it seems necessary to further describe these results by characterizing the nature of metal oxides in the soils and estimating their environmental speciation according to the mode of ecological restoration.

Chapitre IV

Influence de l'hétérogénéité des protocoles de réhabilitations et de revégétalisation sur la mobilité du mercure

Avant-propos

Les trois articles présentés précédemment ont permis de mettre en évidence des modifications fondamentales des comportements microbiens en fonction de la nature de la réhabilitation et de la revégétalisation. D'après ces résultats la densité microbienne ainsi que leurs activités et leurs diversités ont largement été favorisées par l'instauration d'un couvert végétal dense en conditions contrôlées. En outre, les résultats obtenus sur un large panel de sites non restaurés montrent des tendances communes et des fonctionnalités biogéochimiques faibles voire limitantes ce qui confirme l'importance capitale de la revégétalisation pour accélérer les successions écologiques. Nous avons également mis en évidence à travers ces différents travaux que la spéciation opérationnelle du mercure pouvait varier entre les sites réhabilités. De plus, sa mobilité semble être liée aux différentes activités microbiennes, aussi bien aérobies qu'anaérobies. La solubilisation potentielle du mercure, plus importante sur les sites les moins restaurés pourrait être liée à des modifications de la spéciation environnementale du mercure. Dans ce dernier chapitre nous aborderons la question de la mobilité du mercure à travers une caractérisation, la plus complète possible, des différentes formes de mercure dans les sols miniers réhabilités et nous essayerons de faire le lien entre les formes chimiques du mercure et les activités microbiennes en relation avec les processus de réhabilitation. Ce chapitre permettra également de visualiser l'incidence de la réhabilitation sur la réussite de la restauration écologique ainsi que sur les fonctionnalités des cycles biogéochimiques.

Article V: Influence of different types of rehabilitation on microbial activities and mercury mobility on formers Guyanese mining sites

Résumé

L'émergence du concept de développement durable a permis d'améliorer le management écologique des sites miniers guyanais et les compagnies sont maintenant obligées de réhabiliter les sites d'orpaillage après l'exploitation. La réhabilitation des sites miniers nécessite des compétences multiples, en pédologie, en écologie, en botanique et plus généralement en ingénierie écologique. En raison d'une forte diversité de matrice minière, les protocoles d'extractions des minéraux d'intérêts sont très variables, dépendent du site et induisent donc des protocoles de réhabilitation au cas par cas. Néanmoins, une des premières instructions est de réaliser une réhabilitation homogène des sites en reconstruisant le sol au plus proche de sa condition initiale. Comme la réhabilitation des sites miniers en Guyane est récente il y a peu d'information sur l'effet des protocoles de réhabilitation sur les cycles biogéochimiques et sur la mobilité du mercure. Cette étude a été réalisée pour évaluer l'impact de différentes modalités de réhabilitation et de restauration écologique sur la texture du sol et sur sa qualité. L'impact de la réhabilitation a aussi été estimé grâce à des biomarqueurs et en estimant la toxicité potentielle du mercure. Nous avons échantillonné du sol sur 6 sites miniers réhabilités, 3 sites dans la région de Bélizon et 3 sites dans la région de Yaoni. Ces sites ont été choisis en fonction de leur gradient de restauration écologique. Nous avons réalisé une caractérisation physico-chimique, des analyses d'indicateurs de la qualité du sol avec des mesures de biomasse microbienne et d'activités enzymatiques et nous avons réalisé une mesure de la spéciation environnementale du mercure afin d'évaluer sa mobilité et sa toxicité potentielle. Les résultats obtenus dans cette étude montrent que la réhabilitation des sites miniers a été conduite de manière assez hétérogène avec de fortes variations de texture du sol, même pour des sites proches. L'analyse en co-inertie révèle 41,81% de co-variance entre les données relatives aux indicateurs de qualités microbiologiques et les paramètres physico-chimiques du sol, indiquant un effet important de la matière organique sur la qualité biologique du sol. De plus, les résultats mettent que les modifications de la spéciation du mercure sont corrélées à 82,06% avec les paramètres texturaux du sol, en confirmant un

effet direct de la réhabilitation sur la mobilité du mercure. Les sites les moins restaurés avaient potentiellement les formes de mercure les plus toxiques et les plus mobiles par rapport aux sites miniers restaurés avec un couvert végétal arboré. Cette étude confirme que le contrôle de la réhabilitation et de la restauration écologique a impact positif sur les activités microbiennes mais également sur les risques sanitaires en limitant la mobilité du mercure.

Will be submitted in Land Degradation and Development

Influence of different types of rehabilitation on microbial activities and mercury mobility on formers Guyanese mining sites

Ewan Couic^{*a,b}, Michel Grimaldi^{a,c}, Vanessa Alphonse^b, Clarisse Balland-Bolou-Bi^b, Alexandre Livet^b, Stéphanie Giusti-Miller^a and Noureddine Bousserhine^b

^a Institut d'Ecologie et des Sciences de l'Environnement de Paris (IEES), Université-Paris-Est Créteil, 94010, Créteil cedex, France.

^b Laboratoire Eau Environnement et Systèmes Urbains (Leesu), Université-Paris-Est Créteil, 94010, Créteil cedex, France

^c Institut de Recherche pour le Développement (IRD), Centre IRD France Nord, 93143, Bondy cedex, France

* Corresponding author :

Ewan Couic

E-mail :

Abstract

The emergence of the concept of sustainable development has made it possible to better manage mining plots in French Guiana and mining companies are obliged to rehabilitate gold panning sites after exploitation. The rehabilitation of mining sites requires skills in pedology, ecology, botany and more generally in ecological engineering. Due to the high diversity of mining matrixes, extraction protocols for minerals of interest are highly variable, dependent on the extraction sites and involve rehabilitation processes carried out on a case-by-case basis. Nevertheless, one of the first instructions for mining companies is to carry out a homogeneous rehabilitation and rebuild the soil as it was before mining. As rehabilitation in Guyana is recent, there is little information on the effect of different ecological rehabilitation protocols for Guyana's mining sites on biogeochemical cycles and mercury mobility.

This study was conducted to assess the impact of different rehabilitation and ecological restoration protocols on soil texture and quality. The impact of the rehabilitation was also estimated with the help of soil quality biomarkers and by estimating the mobility and potential toxicity of mercury. We sampled soil from 6 rehabilitated mining sites in French Guiana, 3 sites in the Belzon region and 3 sites in the Yaoni region. On these sites there was a gradient of success in ecological restoration. We carried out a physico-chemical quality characterization, an analysis of rehabilitation quality biomarkers with measurements of microbial biomass and enzymatic activities and we carried out an analysis of mercury environmental speciation to assess its potential toxicity according to a mobility gradient.

The results obtained in this study show that the rehabilitation of mining sites has been carried out in a heterogeneous manner and the texture of mining soils is very variable even for nearby sites. The co-inertia analysis revealed 41.81% co-variance between biological indicators and soil texture, indicating an effect of the rehabilitation method on biological indicators. Sites that have been homogeneously rehabilitated with fabaceous species have very positive soil quality indicators. In addition, the results highlight a change in mercury mobility that is 82.06% correlated with soil texture properties, which also confirms a direct effect of rehabilitation on mercury mobility. The non-restored sites had much higher potential for mobility and mercury toxicity than the site where ecological restoration was successful. These results highlight the positive effect of controlled rehabilitation and ecological restoration on microbiological activities and the potential toxicity of mercury.

1. Introduction

Mining activities have led to massive ecosystem degradation and disruption in most operations. In South America and in French Guiana in particular, the stakes of gold mining are essential for the development of the region but worrying for the preservation of the ecosystem. In Guyana, gold mining impacts land use and the functioning of the forest system, including the soil (Bradshaw, 1997a; Martínez-Garza and Howe, 2003; Veiga *et al.*, 2006; Wong, 2003). To exploit the gold in alluvial terraces, it is necessary to remove all the vegetation and then to use powerful water jets (sluice) to eliminate the superficial layers of soil until reaching reach the gold-bearing layer (Grimaldi and Guedron, 2015). In addition to the direct damage caused by deforestation, these practices lead to heavy soil losses through erosion, which will lead to increased turbidity in aquatic systems and the remobilization of toxic metallic trace elements such as mercury (Telmer *et al.*, 2006). Due to amalgamating chemical properties for gold mining, mercury was widely and legally used until 2006 and the problem of mercury in Guiana has already been described by many scientific studies (Roulet *et al.*, 1999 ; Wasserman *et al.*, 2003). Mercury used for decades has been added to that already accumulated in the soil by weathering mechanisms in source rocks and by atmospheric deposition, mainly from degassing of the earth's crust and oceans, and human activities (Grimaldi and Guedron, 2015). It was shown that mercury of anthropogenic origin in Guyana was the most reactive and that the highly disorganized and often suboxic physico-chemical conditions of the mining sites favoured its mobility and methylation (Guedron, 2008; Lacerda *et al.*, 2004).

In order to limit the adverse effects associated with mercury mobility, ecological rehabilitation methods have been proposed and are now being used with varying degrees of success in the Guyana basin. In the mining code, there is a fundamental difference between the principle of rehabilitation and restoration or revegetation (Le Roux, 2002). Rehabilitation in the mining sense consists solely of reconstituting the original soil from the materials that have been extracted and moved, terracing the mixture and if possible, covering it with so-called fertile horizons. Restoration will consist of applying a defined site revegetation protocol, if possible using local species in order to rebuild the original ecosystem (Jaffré *et al.*, 1997; Loubry, 2002). Although rehabilitation is mandatory, restoration is not explicitly requested in the mining code and too often remains at the discretion of mining companies.

Among the methods used to evaluate the quality of ecological restoration protocols, enzymatic activity measurements and quantification of soil microbial biomass are among the most effective and widely used methods, particularly at mining sites (Couic *et al.*, 2018; Jordan *et al.*, 1995; Nannipieri *et al.*, 2003).

Although data on mercury speciation in natural soils and mining sites are fairly well documented (Guedron *et al.*, 2009; Wasserman *et al.*, 2003), changes in carrier phases can alter mercury mobility and these mechanisms during ecological restoration processes are still not well known in Guyana and are essential to define a chemical quality status of the soil. The potential for toxicity, mobility and bioaccumulation of mercury depends on the forms of mercury and its carrier phases (Davis *et al.*, 1997). In a context where the physico-chemical conditions (iron oxides, low pH and suboxic conditions) of rehabilitated sites could promote mercury mobility (Guedron, 2008), environmental speciation measures could therefore be an interesting tool for assessing the health quality of these plots. While the effect of ecological restoration has already been shown to be positive for soil biological quality (Couic *et al.*, 2018; Schimann *et al.*, 2012b), it would also be relevant to assess the impact of different vegetation cover on mercury speciation. Moreover, in a context where site rehabilitation is not always homogeneous, mainly due to topography and site accessibility, and where soil physics impacts the fate of mercury, it seems relevant to link the physical properties of soil to mercury speciation. Environmental extraction procedures are complex, each extraction step is critical and few protocols have consensus (Leermakers *et al.*, 2005). However, the extraction principles are often the same and extractions allow access to compartments that are not very mobile under current conditions but which could be mobilised following acidification (carbonates) or phases of soil clogging (oxides)(Cornu and Clozel, 2000).

In this study, the main physico-chemical properties of the soil, telluric enzymatic activities indicative of the functioning of biogeochemical cycles, as well as the environmental speciation of mercury were determined in different soil samples from former mining sites rehabilitated in French Guiana, restored or not to see the effect of a vegetation gradient. The objectives of this study were: (1) Assess the biological quality of mine sites in relation to the quality of rehabilitation and the level of ecological restoration; (2) Describe the influence of heterogeneous soil rehabilitation and different ecological restoration modalities on the

fate and mobility of mercury in soils. It is difficult to anticipate the different recovery trajectories of biogeochemical cycles on a wide range of rehabilitated mining sites; however, these results could contribute to improving the assessment of the sanitary quality of rehabilitated sites in French Guiana.

2. Materials and methods

2.1 Site description and soil sampling

The work was undertaken in French Guiana, South America. The sampled soils for this study were rehabilitated after gold mining extraction. After closing the alluvial mine pit, rehabilitation consisted of reconstituting the soil excavated during mine exploitation. For a faster and more efficient rehabilitation it was recommended to homogenize the soil constituents extracted during gold mining. However, this homogenization is not always easily achievable depending on the topography of the site and water constraints. The soils selected for this study come from rehabilitated former mining sites and can be considered as anthroposols. The soils selected for this study come from rehabilitated former mining sites and can be considered as anthroposols. Due to different rehabilitation protocols, these soils all have different structures and textures.

The first three sites were in the Belizon forest (N 04°22.200' / W 052°19.328'). The mining operation lasted 5 years and ended in January 2013. All sites in the Belizon Forest have had the same mining history. In February 2013 an ecological restoration programme was initiated with macrocuts of *Clitoria racemosa*, a species of local fabacea. The recovery of *C.racemosa* macrocuts has not been effective on all sites in the Belizon forest.

On the Belizon 1 site (Bel 1) vegetation covered between 5 and 10% of the soil surface with a majority of cyperaceae species (*Cyperus sp* and *Carex sp*). On the Belizon 2 site, vegetation covered more than 70% of the site and almost the entire site is dominated by *Lycopodiella sp* with the presence of some cyperaceae species. On the Belizon 3 (Bel 3) site, macrocuts of *C.racemosa* were recovered and the trees are nearly 5 metres high.

The following three sites were taken from the former Yaoni mine site (N 04°30.930' / W 052°21.275'). Mining activity at the Yaoni sites lasted several years and ended in 1997. These three sites also have the advantage of having the same mining history. After mining, several ecological restoration protocols were put in place. The first two Yaoni sites (Yao 1 and Yao 2)

have not been restored by specific protocols and the low vegetation cover, mainly *Lycopodiella sp*, *Cyperus sp* and *Carex sp*, is the result of spontaneous vegetation development. The Yaoni 3 (Yao 3) site has been completely restored by associations of fabaceous species, notably *Acacia mangium* and *Clitoria racemosa*. The recovery of vegetation is a success and this site can be considered as a positive witness of ecological restoration in French Guiana.

At each site, soil samples were collected from depths between 0-10 cm with an auger in april 2016. The sampling for the 5 sites consisted of sampling 5 plots (n=5) per site, with 3 sub-samples per plot that were pooled at the laboratory. The sampling of 5 replicas per site was mainly conditioned by the topography of the terrain, the accessibility of the plots and the feasibility of sampling. Soil samples were immediately sealed in sterile hermetic polyethylene bags for transportation to the Cayenne IRD laboratory. Samples were then dried at ambient temperature (25°C) until they were air dried (i.e., approximately 3 weeks). These 90 collected samples (6 sites * 5 plots * 3 samples per plot) were then sieved at 2 mm, homogenised, and hermetically sealed at 4°C until use.

2.2. Initial soil samples characterization

pH, total major element (i.e., C, N, P, Fe, Al, Mn) and total trace element (Hg) content, total organic carbon content, granulometry, and microbial biomass carbon (using the substrate induced respiration (SIR) method) were determined to characterise the main physico-chemical and biological properties; this enabled us to assess the main differences between soils.

Soil pH measurements

Soil pH-H₂O and pH-KCl were measured in soil suspensions by shaking 1 g of soil in a 1:2.5 soil-to-water and soil-to-KCl (0.1 M) ratio for 1 hour and then by using a pH metre (MetrOhm 744) (ISO 10390).

Soil total carbon, nitrogen, and phosphorous measurement

Soil total carbon (C_{tot}) and total nitrogen (N_{tot}) were determined by the Dumas method (NF ISO 13878). Briefly, the Dumas method consists of flash combustion of the soil sample (at 1000°C) using helium and oxygen. After purification of the combustion gases, determination of total carbon and nitrogen contents was performed by chromatography with a thermal conductivity detector (NA 1500 série 2 CARLO-ERBA).

Total phosphorus (P_{tot}) was determined after the acid digestion of soil samples, as previously described. The HPO_4 formed during acid digestion was measured after adding ammonium molybdate and acid ascorbic (Murphy and Riley, 1962). The colour produced by phosphomolybdenum (PMB) was measured by colorimetry at 885 nm (Genesys 10 μv Scanning, Thermo)

Water extractions were performed for total organic carbon (TOC), and concentrations were measured with a Shimadzu TOC-500 apparatus (Shimadzu, Kyoto, Japan). Briefly, 1 g of soil was shaken for 24 h in a polypropylene centrifuge tube with 10 ml of ultrapure water. The suspensions were centrifuged at 2000 rpm for 10 minutes, and supernatants were filtered at 0.2 μm (PTFE, VWR®) and directly analysed on the TOC analyser.

Soil granulometry determination

Granulometry was determined on the fraction less than 2 mm, and five classes of particles have been distinguished according to the NF X 31-107 standard: clay (< 2 μm), fine silts (2 to 20 μm), coarse silt (20 to 50 μm), fine sands (0.050 to 0.200 mm) and coarse sands (0.200 to 2 mm). Sampling and sieving were carried out after the destruction of organic matter by hydrogen peroxide (H_2O_2) on a test sample of approximately 10 g. The final dispersion was carried out by a short ultrasonic passage after the addition of dispersant [$(\text{NaPO}_3)_6 + \text{Na}_2\text{CO}_3$], and afterwards, the coarse sands (> 0.200 mm) were separated by sieving. To illustrate this, the results have been grouped into 3 parts: clay, total silt, and total sand.

2.3. Soil microbial biomass

The application of the substrate-induced respiration technique (SIR) was applied to determine the total microbial biomass (Anderson, 1982). Our experiment was conducted at 22°C, which was the temperature prescribed in the original SIR method in accordance with Anderson and Domsch (1978) (Anderson and Domsch, 1978). Using the SIR method, soil microbial biomass C (SIR-biomass) was calculated using the following equation from Anderson and Domsch (1978) (Anderson and Domsch, 1978):

$$\text{SIR-biomass C } (\mu\text{gC g}^{-1} \text{ soil}) = \text{SIR } (\mu\text{l CO}_2 \text{ g}^{-1} \text{ soil h}^{-1}) \times 40.04 + 0.37 \quad (\text{Eq. 1})$$

2.4. Enzyme assays

The activity of acid (AcdP; EC 3.1.3.2) and alkaline (AlkP; EC 3.1.3.1) phosphatases, B-glucosidase (Glu; EC 3.2.1.21) and arylsulfatase (Aryl; EC 3.1.6.1) were assayed based on the amount of p-nitrophenol (pNP) released after cleavage of enzyme-specific substrates at the average pH of natural soil. The specific substrates were p-nitrophenol phosphates for AcdP and AlkP, 4-nitrophenyl-B-D-glucopyranoside for Glu and p-nitrophenol sulfates for Aryl. These enzymes were measured as described by Badiane *et al.* (2001)(Badiane *et al.*, 2001), Mora *et al.* (2005)(Mora *et al.*, 2005) and Tabatabai & Bremmer (1970). One hundred μl of soil solution (1:5 w/v) was mixed with 50 μl of desired substrate (10 M) and 50 μl of *Mac ILVA/IN* buffered solution (pH of 4 for AcdP, pH of 9 for AlkP and soil pH with citrate phosphate buffer for Glu and Aryl. Matching soils were used as controls with 50 μl of buffer but no enzyme substrate. The soil was incubated for 2 h at 37°C on an orbital shaker and then centrifuged at 1500 rpm for 10 min. Then, 75 μl of supernatant was mixed with 175 μl of 0.2% Na_2CO_3 to stop the reaction. The colour intensity of the solution was immediately determined by colorimetry at 405 nm.

Dehydrogenase activity (DHA) was determined according to Klein *et al.* (1971)(Klein *et al.*, 1971) using 0.5 g of soil sample and 2,3,5-triphenyltetrazolium chloride (TTC) as substrate. The colour intensity of the solution after 96 h of incubation at 28°C was determined by colorimetry at 405 nm (Genesys 10 μv Scanning, Thermo).

Urease activity (Ur) was determined according to Kandeler and Gerber (1988)(Kandeler and Gerber, 1988) using 0.5 g of soil sample and urea as substrate in a borate buffer. After indophenol reaction, colour intensity of the solution after 4 h of incubation at 37°C was determined colorimetrically at 660 nm (Genesys 10 μv Scanning, Thermo).

The total enzymatic activity of soil microorganisms was determined by a spectrophotometric method where hydrolysis cleavage of fluorescein diacetate (FDA) to fluorescein, by several soil enzymes, allows solutions to appear fluorescent yellow, following the method developed by Green *et al.* 2006. Briefly, 0.5 g soil is incorporated into sterile tubes has a solution containing 49.5 ml phosphate buffer and 500 μl FDA (0.24 mmol/L). The mixture is agitated for 2 hours in the dark. The tubes are then centrifuged, and the optical density of the supernatant is measured at 490nm (Genesys 10 μv Scanning, Thermo).

2.5. Environmental speciation and mobility of mercury

2.5.1. Total mercury content

Mercury concentrations (HgT) in soil samples were determined directly by thermal decomposition atomic absorption spectrometry after gold amalgamation using an automatic mercury analyser (AMA 254) with a detection limit of 0.01 ng. In brief, the sample is heated to 550°C, and all products of decomposition, including mercury, are carried by a stream of oxygen through a catalytic tube where HgT is transformed into elementary mercury (Hg⁰), which then readily adsorbs to a gold-trap. The fixed mercury is then released by heating the gold-trap at 450°C, and the mercury is quantified by atomic adsorption spectrometry.

2.5.2. Extraction of “Highly mobile” mercury species

This extraction included three fractions of the most mobile and bioavailable forms of mercury. The sum of the three fractions (F1+F2+F3) in the next three paragraphs will be called E1.

2.5.2.1. Water soluble mercury fraction

Soluble mercury was estimated according to Rasmussen *et al* (2000)(Rasmussen *et al.*, 2000). Briefly, 1 g of soil was suspended in 10 ml of ultrapure water and agitated at 300 rpm for 30 min. The suspensions were then centrifuged, and the supernatants were filtered at 0.45 mm with Teflon filters (Minisart SRP 25, Sartorius). Then, 200 µl of extracted supernatants were analysed for soluble mercury content with AMA-254. This fraction will be called F1.

2.5.2.2. Exchangeable mercury fraction

The exchangeable Hg fractions in soil samples were measured after a 1: 15 (w/v) soil/ 0.1M CaCl₂ ratio suspension after 2 h of rotary agitation at room temperature according to Silveira *et al* (2006)(Silveira *et al.*, 2006). Then, solutions were centrifuged, supernatants were filtered at 0.45 mm with Teflon filters (Minisart SRP 25, Sartorius) and then, 200 µl of extracted supernatants were analysed for exchangeable mercury content with AMA-254. This fraction will be called F2.

2.5.2.3. Bioavailable mercury fraction

The bioavailable mercury contents in soil samples were measured after a 1: 10 (w/v) soil/ 0.01M EDTA + 1M ammonium acetate ration suspension after 2 h or rotary agitation following the standard AFNOR NF X31-120. Then, solutions were centrifuged and filtered at

0.45 mm with Teflon filters (Minisart SRP 25, Sartorius). Extracted supernatants were analysed for bioavailable mercury content with AMA-254. This fraction will be called F3.

2.5.2. Extraction of “mobile and toxic” mercury species

The extraction involves the use of a solution of 2% HCl+10% ethanol to extract the mobile mercury species from soil. The target mercury species include toxic alkyl mercury species, such as MeHg^+ and EtHg^+ species, as well as inorganic mercury species that have great mobility, such as soluble Hg^{2+} . The extraction was carried out according to the procedure of Han *et al* (2003)(Han *et al.*, 2003). Soil sample was added to a centrifuge tube with 2.5 mL of the extract solution. The mixture was mixed well by vortex mixing. Then, the sample was sonicated at 60°C for 7 min. A centrifuge was applied, and supernatant was removed. The extraction was repeated three additional times. Ultrapure water was then added to the sample residue and the sample was vortex mixed, then centrifuged. This solution containing the “mobile and toxic” mercury species was analysed by the AMA-254 automatic mercury analyser. As this extraction targeted all forms of mobile mercury, including the three fractions detailed above, extraction E2 corresponded to the difference between the total mobile mercury extracted by this protocol and the sum of the fractions of extraction E1.

2.5.3. Extraction of “semi mobile” mercury species

The sample remaining after the ethanol extraction was first sonicated with 5 mL of ultrapure water at 60°C for 5 min. The sample was centrifuged, and the supernatant was discarded. Then, 5 mL 1:2 (v/v) HNO_3 : Ultrapure water extraction solution was added. The sample was mixed by vortex mixing. The mixture was heated to 95°C for 20 min in a water bath and then centrifuged. The supernatant was separated, and the extraction was repeated. Ultrapure water was then added to wash the sample residue. All supernatants were combined. These supernatants correspond to semi mobile mercury species and will be called E3. This solution containing the “semi-mobile” mercury species including mainly Hg and mercury-metal amalgam was analysed by the AMA-254 automatic mercury analyser.

2.5.4. Determination of the fraction of non-mobile mercury

The rest of the matrix material could be directly analysed by AMA-254 for “non-mobile” mercury species including mainly Hg^2Cl^2 and HgS mercury species. The remaining soil particles correspond to non-mobile mercury species and will be called E4.

2.6. Statistical analysis

The normality of the data distributions and the equal variance between treatments were tested using the Shapiro test and Bartlett's test, respectively. One-Way ANOVA and Tukey's HSD multiple comparison method was used to test differences for all data of the same experimental variable. To analyse the effect of the different rehabilitation processes on physical and biogeochemical data the results were also submitted to principal component analysis (PCA). three PCA were carried out to summarize the three data sets (physico-chemical soil data, enzymatic data, mercury data). Then, the various PCA were subjected to CO-inertia analyses (CIA) to test the PCA correlations between two datasets: (i) physico-chemical soil properties variable sets vs soil enzymatic variable sets, (ii) physico-chemical soil properties variable sets vs mercury speciation variable sets. The CIA is a multivariate method that identifies trends or co-relationships for multiple datasets, especially between a fauna or flora and its environmental factors (Culhane *et al.*, 2003; Velasquez *et al.*, 2005). The significance of each explanatory variable was tested using a Monte-Carlo permutation test. The R software was used for all statistical analyses (R version 3.3.2 (2016-10-31)).

2.7. Quality assurance and control (QA/QC)

To avoid contamination, all materials used in this work were acid-washed twice with HNO₃ (5%) and then rinsed several times with Milli-Q water before use.

Concerning mercury assays in samples, the relative error was routinely $\pm 5\%$ and was always under $\pm 10\%$. The detection limit (defined as three times the standard deviation (SD) of the blank) was $0.005 \mu\text{g g}^{-1}$. Concentrations obtained for repeated analyses of certified reference materials never exceeded the published range of concentrations (i.e., $0.128 \pm 0.017 \mu\text{g g}^{-1}$ and $0.091 \pm 0.009 \mu\text{g g}^{-1}$ for BCR-277R and MESS-3, respectively).

3. Results

3.1. Soil physical and chemical properties of the 6 sites

The initial soil characteristics of the studied sites are summarised in **Table 1**. The results of the granulometry measurements gave very heterogeneous textures between the different rehabilitated sites. The Bel 1, Bel 3, Yao 2 and Yao 3 sites were predominantly sandy with significantly different fine sand / coarse sand ratios between the sites. The Bel 2 site was mostly silty while the Yao 1 site was mainly clayey.

Table 1:

TOC: Total Organic Carbon, C_{tot}, N_{tot}, P_{tot} : Total C, N and P, Total Fe, Al : Total Iron, Aluminum content, (n=5, mean ± SD). For each parameter, values followed by different letters differ significantly with P < 0.05 with Tukey HSD test.

Sites characteristics	Bel 1	Bel 2	Bel 3	Yao 1	Yao 2	Yao 3
TOC (g.kg ⁻¹)	2.47 ± 0.22 a	5.84 ± 0.34 b	4.99 ± 0.37 b	3.88 ± 0.03 ab	3.51 ± 0.23 ab	15.58 ± 1.4 c
C total (g.kg ⁻¹)	3.52 ± 0.36 a	9.54 ± 0.73 b	7.01 ± 0.83 b	6.01 ± 0.32 b	4.29 ± 0.19 a	22.88 ± 1.51 c
N total (g.kg ⁻¹)	0.14 ± 0.02 a	0.45 ± 0.01 b	0.40 ± 0.04 b	0.40 ± 0.02 b	0.28 ± 0.03 ab	1.81 ± 0.04 c
P total (g.kg ⁻¹)	0.13 ± 0.01 a	0.27 ± 0.07 b	0.17 ± 0.02 ab	0.21 ± 0.01 ab	0.18 ± 0.01 ab	0.75 ± 0.03 c
pH H2O	5.3 ± 0.1 a	4.66 ± 0.08 b	5.00 ± 0.03 ab	5.26 ± 0.2 a	5.02 ± 0.03 ab	4.66 ± 0.2 b
Clay%	7.05 ± 2.7 a	22.24 ± 2.4 b	21.26 ± 1.5 b	46.44 ± 1.1 c	24.26 ± 0.5 b	19.78 ± 1.4 b
Fin silt%	18.62 ± 2.1 b	44.47 ± 2.6 d	17.68 ± 3.5 b	33.92 ± 1.2 c	10.10 ± 0.3 a	27.7 ± 0.8 c
Coarse silt%	2.39 ± 0.98 a	21.39 ± 0.92 d	7.10 ± 1.1 b	7.57 ± 0.45 b	10.40 ± 0.7 c	7.8 ± 0.5 b
Fin sand%	63.68 ± 1.4 e	2.67 ± 1.1 a	4.86 ± 0.6 a	8.59 ± 0.49 b	35.26 ± 0.7 d	14.17 ± 1.35 c
Coarse sand%	7.41 ± 0.33 b	9.14 ± 0.8 b	49 ± 5 d	3.30 ± 0.48 a	19.30 ± 0.5 c	22.22 ± 1.17 c
Fe (g.kg ⁻¹)	66.85 ± 6.2 b	44.4 ± 2.8 b	113.3 ± 15.2 a	65.4 ± 10.2 ab	75.7 ± 12.9 b	71.4 ± 4.9 b
Al (g.kg ⁻¹)	16.54 ± 2.12 a	41.4 ± 2.2 a	25.6 ± 2.15 b	53.6 ± 15.8 b	76.4 ± 4.8 b	43.3 ± 10.2 b

Soil pH-H₂O measurements indicated that rehabilitated sites were acidic, and pH varied between Yao 3 and Yao 1 sites with 4.66 and 5.25 respectively.

Among the six rehabilitated sites, the two sites restored with a good recovery of the fabaceous plants (Bel 3 and Yao 3 sites) had significantly higher levels of primary macro-elements (total CNP and TOC content) than the non-restored sites.

The total organic carbon content varied between 2.47 and 15.58 g.kg⁻¹ for Bel 1 and Yao 3 sites respectively. The total carbon content varied between 3.52 and 22.88 g.kg⁻¹ for Bel 1 and Yao 3 sites respectively. The total nitrogen content varied between 0.14 and 1.81 g.kg⁻¹ for Bel 1 and Yao 3 sites respectively. The total phosphorus content varied between 0.13 and 0.75 g.kg⁻¹ for Bel 1 and Yao 3 sites.

The six sites were rich in Iron with minor differences which seems consistent with Guyanese soils (Da Silva *et al.*, 2016; Harris-Hellal *et al.*, 2011, 2009). Total iron content in soil varied between 44.4 and 85.04 g.kg⁻¹ for Bel 3 and Yao 2 respectively. The aluminium contents

were homogeneous for Bel 3, Yao 1, Yao 2 and Yao 3 sites and higher than Bel 1 and Bel 2 sites. Aluminium levels appeared to be high enough for natural soils in French Guiana.

3.2. Soil microbial biomass and enzyme activities

Table 2:

Soil Microbial Biomass and soil enzymes activities involved in soil biogeochemical cycles in the six rehabilitated sites (n=5, mean \pm SD). MBC : Soil microbial biomass carbon in mg.kg^{-1} , DH : Dehydrogenase activity in $\mu\text{g TPF (red-colored formazan) g}^{-1} \text{ soil h}^{-1}$, B-Glu, AcdP, AlkP and Aryl : β -glucosidase, Acid phosphatase, Alkaline phosphatase and Arylsulfatase activities in $\mu\text{g pNP g}^{-1} \text{ soil h}^{-1}$, Urease : Urease activity in $\mu\text{g NH}_4^+\text{-N g}^{-1} \text{ soil h}^{-1}$, FDA : Global microbial enzymes activities in $\mu\text{g fluorescein g}^{-1} \text{ soil h}^{-1}$. For each parameter, values followed by different letters differ significantly with $P < 0.05$ with Tukey HSD test.

Microbial activities	Bel 1	Bel 2	Bel 3	Yao 1	Yao 2	Yao 3
MBC	312.6 \pm 10.0 c	385.9 \pm 21.5 c	844.4 \pm 14.1 b	223.1 \pm 10.8 d	248.1 \pm 13.6 d	1102 \pm 41 a
DH	0.43 \pm 0.08 d	0.34 \pm 0.02 d	2.10 \pm 0.19 b	0.46 \pm 0.07 d	1.03 \pm 0.12 c	5.80 \pm 0.44 a
B-Glu	1.60 \pm 0.25 a	1.46 \pm 0.78 a	5.54 \pm 0.38 a	1.38 \pm 0.10 a	3.48 \pm 0.97 a	18.6 \pm 3.4 b
Urease	0.46 \pm 0.04 c	0.70 \pm 0.02 bc	1.52 \pm 0.06 b	0.14 \pm 0.01 d	0.29 \pm 0.02 cd	4.74 \pm 0.28 a
AcdP	5.76 \pm 0.90 bc	3.41 \pm 0.80 c	11.78 \pm 1.70 b	2.87 \pm 0.98 c	10.98 \pm 0.94 b	18.09 \pm 0.7 a
AlkP	0.36 \pm 0.09 c	4.17 \pm 0.70 b	2.79 \pm 0.47 c	1.02 \pm 0.57 c	12.07 \pm 3.01 a	4.02 \pm 0.52 b
Aryl	1.57 \pm 0.27 bc	<i>nd</i>	8.42 \pm 1.22 b	1.04 \pm 0.36 c	1.12 \pm 0.50 bc	56.0 \pm 3.5 a
FDA	1.22 \pm 0.12 b	0.89 \pm 0.10 b	1.28 \pm 0.09 b	0.52 \pm 0.04 c	0.49 \pm 0.02 c	3.22 \pm 0.21 a

The two sites restored with fabaceous species Bel 3 and Yao 3 sites had significantly higher soil microbial biomass levels than the non-restored sites (Table 2). The maximum biomass was for the Yao 3 site while the minimum was for the Yao 1 site with value of 1102 mg kg^{-1} and 223.1 mg kg^{-1} respectively.

Regardless of the soil enzyme assay (Table 2) and the rehabilitated sites, soil enzyme activities showed strong significant differences between restored and non-restored sites. Regardless of the soil enzyme assay, soil enzyme activities were significantly the highest at the Yao 3 site, except for alkaline phosphatase.

The total enzymatic activities (FDA) varied between 0.49 and 3.22 $\mu\text{g. g}^{-1}.\text{h}^{-1}$ of fluorescein for Yao 2 and Yao 3 respectively. For dehydrogenase activity, the maximum

activity was for Yao 3 site while the minimum was for the Bel 2 site with value of 5.80 mg kg⁻¹ and 0.34 µg TPF g⁻¹ soil h⁻¹ respectively. For the β-glucosidase activity, the Yao 3 site had significantly the highest activity with 18.6 µg pNP g⁻¹ soil h⁻¹ while the other sites had a relatively homogeneous activity. For urease activity, the highest value was measured for Yao 3 then for Bel 3 with 4.74 and 1.52 µg NH₄⁺-N g⁻¹ soil h⁻¹, respectively. The other sites had significantly lower urease activities. Acid phosphatase activities were higher than for the other enzymes and significantly higher for the two restored sites and Yao 2 than for the others non-restored sites. For alkaline phosphatase activity, the highest value was measured for Yao 2 then for Bel 2 with 12.07 and 4.17 µg pNP g⁻¹ soil h⁻¹, respectively. For Arylsulfatase activity, the Yao 3 and Bel 3 sites reached values of 56.0 and 8.42 µg pNP g⁻¹ soil h⁻¹, respectively while the other sites had very little activity.

3.3. Mercury environmental speciation

Table 3:

Mercury environmental speciation for the six sites. E1: Extraction of highly mobile mercury species, F1: H₂O soluble mercury fraction, F2: CaCl₂ exchangeable mercury fraction, F3: EDTA bioavailable mercury fraction, E2: Extraction of mobile and toxic mercury species, E3: Extraction of semi mobile mercury species, E4: Non-mobile mercury species. All values are expressed in ng g⁻¹ soil. Extraction yield represents the quality of mercury extraction in the samples, the value is obtained with the following formula: (E1 + E2 + E3 + E4) / Total Hg * 100. For each parameter, values followed by different letters differ significantly with P < 0.05 with Tukey HSD test.

Extraction	Bel 1	Bel 2	Bel 3	Yao 1	Yao 2	Yao 3
E1	6.28±2.16 a	7.30±0.48 a	6.82±0.49 a	18.32±1.29 b	8.90±0.88 a	4.07±0.52 a
F1	4.87±0.09 b	4.97±0.12 b	4.21±0.08 b	10.39±0.82 a	5.55±0.45 b	1.71±0.21 b
F2	0.36±2.06 a	1.27±0.47 b	1.33±0.43 b	1.23±0.83 b	1.89±0.54 b	1.28±0.28 b
F3	1.04±0.09 a	1.04±0.19 a	1.27±0.29 a	6.69±0.19 b	1.46±0.27 a	1.08±0.53 a
E2	65.8±14.9 ab	14.4±1.6 bc	44.1±8.3 b	70.4±37.7 ab	103.1±5.3 a	25.9±4.0 b
E3	69.2±5.1 c	132.5±5.9 b	167.8±9.8 a	118.6±7.1 bc	92.8±3.6 bc	164.6±14.9 b
E4	147.1±12.2 a	69.2±4.0 ab	53.9±15.2 ab	10.1±3.7 b	23.1±1.6 b	210.0±4.8 a
Total Hg	292.8±16.5 ab	224.1±7.2 b	273.9±4.6 ab	228.5±11.5 b	232.7±3.9 b	410±11.6 a
Extraction yield (%)	98.5	99.7	99.5	103.1	97.9	101.1

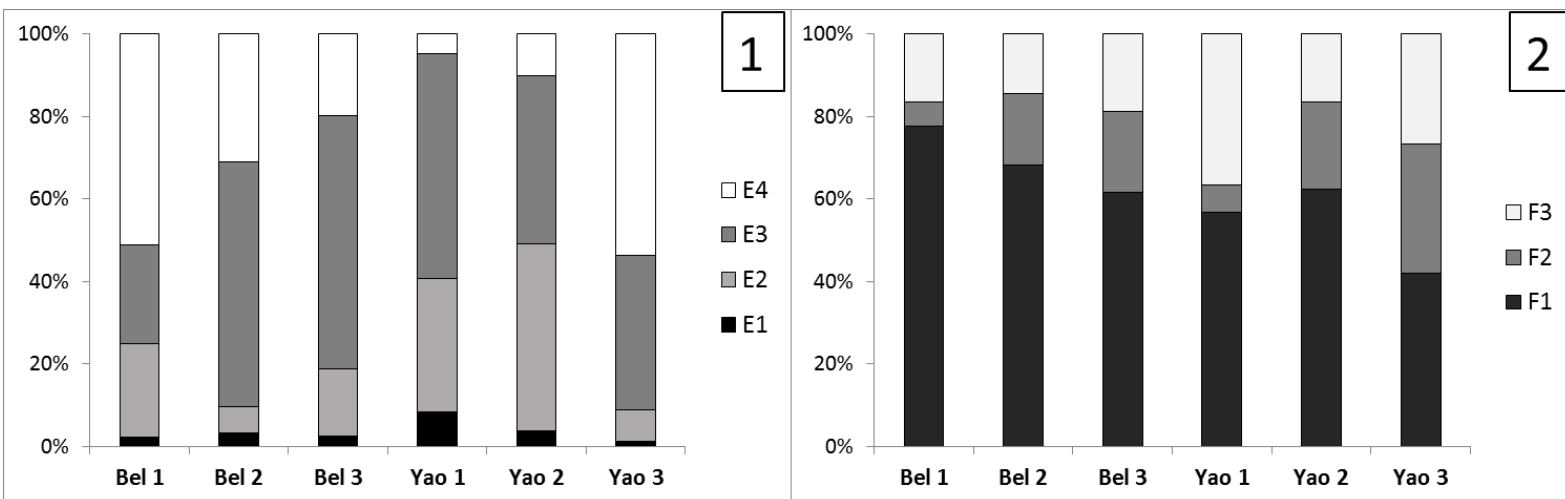

Figure 1:

Mercury environmental speciation for the six sites as a percentage of each fraction relative to total mercury. [1] Focus on the main extractions of mercury. E1: Extraction of highly mobile mercury, E2: Extraction of mobile and toxic mercury, E3: Extraction of semi mobile mercury, E4: Non-mobile mercury. [2] Focus on the most mobile fractions of mercury. F1: H₂O soluble mercury, F2: CaCl₂ exchangeable mercury, F3: EDTA bioavailable mercury.

3.3.1. Total mercury

Mercury levels (Table 3) were homogeneous between the various rehabilitated sites with an average of 265 ng Hg g⁻¹. The Yao 3 site had significantly higher mercury content with 338.8 ng Hg g⁻¹. These concentrations were still low compared to the gold mined soil in French Guiana (Guedron *et al.*, 2009) however it remained within the normal range of mercury measurements in French Guiana (Guedron *et al.*, 2009).

3.3.2. Total highly mobile and mobile mercury species

The quantities of highly mobile mercury E1 (Table 3), and their percentage in relation to total mercury (Figure 1.b) were significantly higher for site Yao 1 with a percentage of 8% for E1. Yao 1 was also the richest in water soluble mercury (F1) and bioavailable mercury (F3) with 4.56 and 2.93%, respectively. For the other rehabilitated sites, the percentages of fractions F1, F2 and F3 (Figure 1.a) did not show significant differences with average percentages of 1.67, 0.49 and 0.45 respectively.

Concerning mobile and toxic (E2) mercury concentrations in samples, ANOVA showed significant differences ($p < 0.0001$). The Bel 2 and Yao 3 sites had the lowest grades with percentages of 6.46 and 7.68% while Yaoni's two non-restored sites had average grades of 31.1 and 44.3% respectively.

3.3.3. Total semi-mobile mercury species

The highest percentages were detected for sites Yao 1, Bel 2 and Bel 3 with values of 51.9, 59.2 and 61.3% respectively. The grades for Yao 2 and Yao 3 were close at 39.9 and 37.9%. The Bel 1 site had the lowest quantity and percentage of semi-mobile mercury with 23.7%. The ANOVA showed significant differences ($p < 0.0001$) between sites rehabilitated for semi-mobile mercury levels.

3.3.4. Total non-mobile mercury species

The ANOVA analysis of non-mobile mercury (E4) concentrations also showed significant contrasts between the rehabilitated sites. The restored Yao 3 site displayed that mercury was most immobilized with 54% non-mobile mercury. The two non-restored Yaoni sites Yao 1 and Yao 2 had significantly lower levels of non-mobile mercury than the other sites with 4.4 and 9.9% respectively. Concerning the rehabilitated sites of Belizon, the two non-restored sites Bel 1 and Bel 2 had more still mercury, 50.3 and 30.9% respectively, than the restored site Bel 3 with 19.7%.

3.4. Co-inertia between soil parameters and microbial activities dataset

The co-inertia analysis (Figure 2a) showed that soil parameters (6 variables) had a highly significant correlation ($P < 0.001$) with the microbiological dataset (8 variables) with 41.86% of total variance explained. The eigen values for axis 1 and 2 were 92.07 and 5.21% respectively. The axis 1 mainly discriminated analysis according to enzymatic activities. Total organic carbon was strongly and positively correlated to enzyme activities with exception of acid and alkaline phosphatase. Soil pH, fin Sand and clay content were negatively related to microbiological dataset.

Discriminant analysis of co-inertia (Figure 2b) showed that soil samples were significantly distinguished ($P < 0.001$) according to their spatial distribution in terms of the quality of ecological restoration. In axis 1 direction, soil samples collected from restored sites (Bel 3 and Yao 3) were predominated on the positive axis, and were clearly distinguished from non-restored sites, all on the negative side. The correlations between soil parameters and microbiological dataset were different for restored soil sample (Bel 3 and Yao 3) but Bel 1, Bel 2 and Yao 1 were close enough according to discriminant analysis.

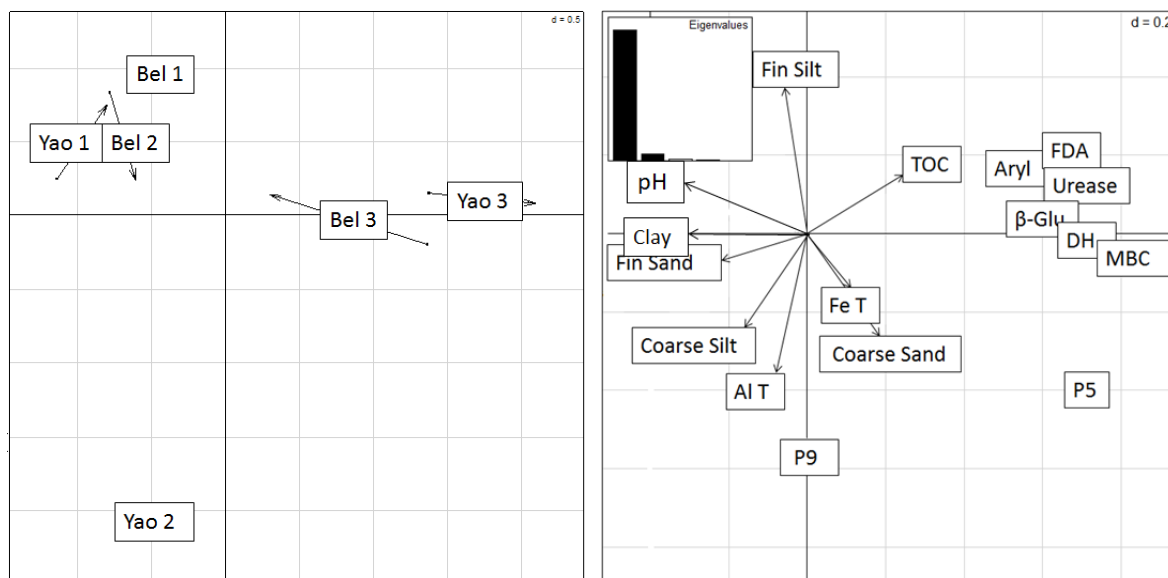

Figure 2:

(a) Co-inertia analysis between soil physico-chemical parameters and microbiological variables. (The variables linked by lines refer to the physico-chemical variables, the other variables refer to the different enzymes activities and microbial biomass in the soil sample); (b) discriminant analysis on co-inertia variable of soil samples. (Circles and boxes represent the projected co-ordinates of physico-chemical dataset and microbial dataset of each rehabilitated site, respectively. The length of the arrow is proportional to the divergence between the data sets.). Eigen values 86.74%, 9.08% for axis 1 to 2 respectively. Randtest: simulated p-value: 0.0019. Explained variance : 41.81 %.

3.5. Co-inertia between soil parameters and environmental mercury speciation dataset

The co-inertia analysis (Figure 3a) showed that soil parameters (8 variables) had a highly significant correlation ($P < 0.001$) with the environmental mercury speciation dataset (7 variables) with 82.06 % of total variance explained. The eigen values for axis 1 and 2 were 67.96 and 20.34 % respectively. Clay were strongly correlated to highly mobile mercury species (E1, F1, F3) and negatively correlated to total and non-mobile mercury, while silt was related exchangeable mercury and semi-mobile mercury species. Mobile mercury species were correlated to coarse sand but no with fin sand. Soil pH was significantly and positively correlated with mobile mercury species (E2) and negatively correlated with total Fe content. Discriminant analysis of co-inertia (Figure 3b) showed that soil samples were significantly distinguished ($P < 0.001$) according to their spatial distribution in terms of the quality of ecological restoration. In axis 1 direction, soil samples collected from restored sites (Bel 3 and Yao 3) were predominated on the positive axis and were clearly distinguished from non-restored sites. The highly mobile clay and mercury variable appeared to strongly distinguish

the Yaoni sites, while the percentages of silt, sand and semi-mobile mercury appeared to more differentiate the Belizon sites along the axis 2.

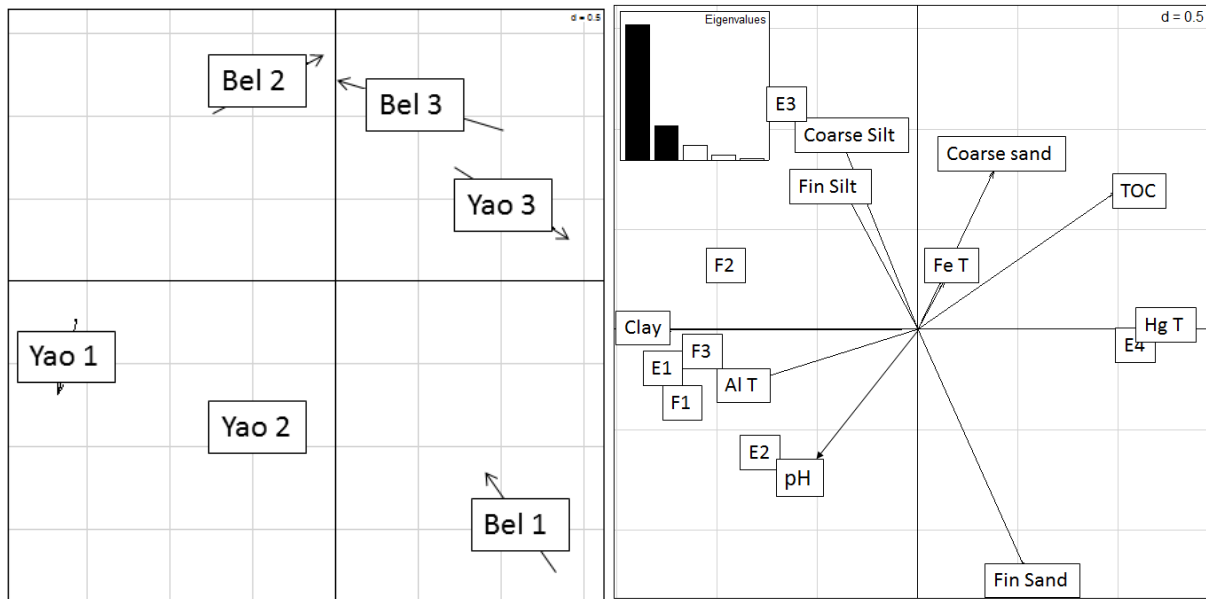

Figure 3:

(a) Co-inertia analysis between soil physico-chemical parameters and mercury extraction. (The variables linked by lines refer to the physico-chemical variables, the other variables refer to the different extractions and fractions of mercury in the samples); (b) discriminant analysis on co-inertia variable of soil samples. (Circles and boxes represent the projected co-ordinates of physico-chemical dataset and mercury dataset of each rehabilitated site, respectively. The length of the arrow is proportional to the divergence between the data sets.). Eigen values 67.96%, 20.34% for axis 1 to 2 respectively. Randtest: simulated p-value: 0.0001. Explained variance : 82.06%.

4. Discussion

The main objective of this study was to determine the influence of rehabilitation and ecological restoration methods for gold panning sites in French Guiana on certain soil microbiological functionalities as well as on the environmental speciation of mercury. For this purpose, two mining zones have been selected. The Belizon mine, rehabilitated in early 2013, then restored with a monoculture of *Clitoria racemosa*. On the Belizon mine, the conduct of the rehabilitation was heterogeneous and the success of the ecological restoration that followed was not homogeneous, only a third of the site was restored according to the initial objectives. The Yaoni mine, rehabilitated then restored in 1998 with different species of fabaceae is an example of a controlled ecological restoration. In addition to the restored Yaoni sites, there are areas that have been rehabilitated but not restored, which are evidence of spontaneous revegetation after mining. To assess the impact of the

conduct of rehabilitation and restoration on the functionality of biogeochemical cycles enzymatic activity measurements were performed. To estimate the health impact, we undertook an analysis of the environmental speciation of mercury to quantify the different forms of mercury in soil, in terms of potential mobility. The second objective of this study was to evaluate the impact of soil texture, and thus the conduct of rehabilitation, on these different experimental variables.

4.1. Positive effect of ecological restoration on microbial activities

Soil biochemical parameters such as microbial biomass or soil enzymatic activities are sensitive and relevant indicators of stressed and disturbed soils and are used to describe soil quality status (Jordan *et al.*, 1995; Nannipieri *et al.*, 2003). Soil microbial biomass measurement assesses the mass of all soil microorganisms (Kudeyarov and Jenkinson, 1976). This data also represents the active part of organic matter that will be responsible for its dynamics and soil quality (Chaussod, 1996; Nannipieri *et al.*, 2003). Generally, microbial biomass varies according to soil physico-chemical parameters, soil use, vegetation cover or potential contamination (Chaussod, 1996; Nannipieri *et al.*, 2003). In this study, microbial biomass appeared to be very sensitive to the different modalities of ecological restoration and to the nature of the vegetation cover. The presence of a restored tree cover on the Bel 3 and Yao 3 plots had increased the microbial biomass by a factor of 2-4 compared to the sites not restored. The presence of *Lycopodiella sp* canopy on the Bel 2 plot has also positively stimulated microbial biomass and shows that the increase in plant density, even herbaceous, has a significant impact on microbial biomass.

Soil enzymatic activities represent the overall degradation activity of organic soil components and are affected by many factors such as pH, organic matter content or contamination level (Nannipieri *et al.*, 2003, 2002; Niemeyer *et al.*, 2012). These activities are generally associated and mediated with microbial biomass. In our study, the restored Bel 3 and Yao 3 sites had the highest activities except for alkaline phosphatase activities. However, the classification of soils according to the amount of microbial biomass is not the same as for enzymatic activities. Indeed, the Yao 2 site, which has one of the lowest biomasses, has relatively important dehydrogenase, B-glucosidase, acid phosphatase and alkaline activities. This could show that these enzymatic activities are not only related to microbial biomass. These results indicated a significant and positive effect of controlled

ecological restoration on certain components of biochemical activities in rehabilitated soils (Balland-Bolou-Bi *et al.*, 2019; Giai and Boerner, 2007; Hu *et al.*, 2016; Jia *et al.*, 2017; Ma *et al.*, 2017; Schimann *et al.*, 2012a). The very low level of activity on non-restored soils also highlights the stressed and anthropized nature of these former mining lands, which require adapted ecological rehabilitation protocols.

4.2. Effect of soil texture on microbial activity

By looking at the interaction of the main physico-chemical soil parameters with microbiological activities (Figure 2), the co-intertie analysis revealed a significant covariance ($p = 0.0019$) between the physico-chemical data and the microbiological data with 41.86% variance explained by the data set. According to these data, the microbial biomass and all enzyme activities tested except for phosphatases would be correlated exclusively to the organic carbon concentration, and thus to the organic matter content. Soil texture parameters had a relatively limited effect since there was no correlation between previous data and fine and coarse silts, iron and total aluminum, and coarse sands. However, we observed a negative correlation of the microbiological data with the concentration of clays and fine sands. Texture and structure are among the most important factors influencing the activity of telluric enzymes (Shukla and Varma, 2011). Enzyme activity is generally greater in fine textured soils than in coarse textured soils (Acosta-Martínez *et al.*, 2007; Taylor *et al.*, 2002) and negative correlations between enzyme activity and clays appear to show opposite results. However, while the nature of clays also impacts enzymatic activities (Huang *et al.*, 2005; Safari Sinegani *et al.*, 2005), it has been shown that the structural stability of soil aggregates, linked to the organic matter content, could play a more important role than soil texture alone (Caravaca *et al.*, 2002; Taylor *et al.*, 2002; Udawatta *et al.*, 2008). Organic matter stabilizes aggregate structure, increases soil retention capacity and improves nutrient bioavailability (Hobbs and Harris, 2001; Viana *et al.*, 2014), thus stimulating soil microbial flora (Asmar, 1997; Elfstrand *et al.*, 2007; Kang and Freeman, 2007).

In this study the major factor of microbial activity was organic matter. In these rehabilitated soils, the contribution of organic matter is exclusively conditioned by the nature of the plant cover and therefore by the success of ecological restoration. The choice of the implantation of fabaceous species seems judicious. These fast-growing nitrogen-fixing species are known for their ability to bring a large amount of organic matter to the soil (Butterfield, 1996;

Norisada *et al.*, 2005), and thus stimulate microbial activities, which are key factors in the success of ecological restoration (de Faria *et al.*, 2010; Franco and De Faria, 1997; Siddique *et al.*, 2008).

4.3. Positive effect of ecological restoration on mercury mobility

The biogeochemistry of mercury is complex and depends on many physico-chemical parameters (i.e. temperature, redox potential, pH, metal oxides, organic matter, mercury oxidation level) (Alloway, 2012) but also biological parameters. Depending on these conditions, the forms of mercury in the soil will be affected and this will influence its mobility, bioavailability and toxicity to biological systems (Veiga and Baker, 2004). Free forms of mercury take different forms in soils such as alkyl mercury species such as methylmercury (MeHg⁺) or ethylmercury(II) (EtHg⁺) or inorganic soluble mercury species. These forms generally represent the most toxic component of mercury because they are the most mobile. Metal mercury complexes, or certain amalgams, are considered less toxic because they are more difficult to mobilize without specific reactions such as chemical or microbial reduction. The least toxic forms of mercury such as mercuric sulphide or cinnabar (HgS) (Han *et al.*, 2003; Navarro, 2008) are generally stable in soils but may however be weathered by simple dissolution in acidic environments (Navarro, 2008), by significant root exudates such as those from fabaceae (Basavaraja *et al.*, 2010) or by microbial production of low molecular weight organic acid (LMMOAs) (Balland-Bolou-Bi *et al.*, 2017). Determining mercury speciation at anthropized sites such as former mining sites is therefore very important for assessing the positive or negative health impact of ecological rehabilitation (Navarro, 2008; Walter Alves Durao Junior, Helena Eugenia Leonhardt Palmieri *et al.*, 2009).

In this study, the results showed very distinct mercury behaviors based on sites that were not solely related to vegetation density. Indeed, the three least covered sites (Bel 1, Yao 1 and Yao 2) presented very different speciation results with nearly 50% non-mobile mercury for Bel 1 and less than 10% non-mobile mercury for Yao 1 and Yao 2. In addition, the results showed a significant increase in mobile and toxic mercury for sites Yao 1 and Yao 2 with more than 40% compared to about 25% of mobile mercury for Bel 1. The presence of tree cover did not positively impact the mobility of mercury on the Bel 3 site compared to adjacent plots Bel 2 which showed a higher proportion of semi-extractable and non-mobile mercury and less mobile mercury. However, mercury speciation over the oldest restored

area of Yao 3 showed a very significant decrease in mobility and potential toxicity of mercury with 90% of mercury present in non-extractable forms.

While HCL/ethanol extraction represents more of a mobility potential linked to leaching under acidic conditions, water extraction, CaCl₂ and EDTA represent more direct mobility close to natural conditions in soils. The F1, F2 and F3 extractions show the lowest percentage of easily mobile mercury for the Yao 3 site and the highest for Yao 1 with 1 and 8% respectively. While the low mobility of mercury species for the Yao 3 site are close to those for the Asturias (Fernández-Martínez *et al.*, 2015), Almaden (García-Sánchez *et al.*, 2009) and Usagre (Moreno-Jiménez *et al.*, 2006) mines in Spain, the Cuyuni Basin (Santos-Francés *et al.*, 2011) in Venezuela, old mining mines in Mexico (Gavilán-García *et al.*, 2008), in the Yaoni region of French Guiana (Couic *et al.*, 2018), the mercury mobility and toxicity for Yao 1 were significantly higher and comparable to mobility at some Wanshan mining sites in China (Lin *et al.*, 2010). Depending on rainfall, these sites can go into suboxic or even anoxic conditions and these results show that the pool of mercury available for rapid methylation diverges very strongly between the rehabilitated sites.

The results indicate that the contribution of a dense cover of fabaceae on the Yao 3 site to modify mercury speciation compared to the unrestored Yao 1 and Yao 2 sites. At this site, despite a higher total mercury content than at the other rehabilitated sites, most of the mercury corresponds to very stable chemical species with low mobility and high stability, such as amalgamated elemental mercury, strongly bound mercury (mineralized and metal-oxyhydroxides) and species in the form of sulphides and hydroxide oxides. For the restored site Bel 3 the results are more contrasted but are possibly due to the more recent restoration and more limited contributions in organic matter in only 4 years of vegetation recovery.

4.4. Effect of soil texture on environmental speciation of mercury

In view of the above conclusions, the nature of the vegetation cover is not only indicative of mercury mobility. In the next paragraph, the main physical properties of soil that may explain the distribution of mercury in soil components will be discussed. The sequential extraction of mercury in the matrix of rehabilitated soils in French Guiana was established based on the potential mobility of different forms of mercury in soils. These results provide access to information on toxicity but do not provide a clear picture of the influence of

mercury-carrying phases in soils. In tropical soils, the mobility and retention of mercury largely from the nature of carrier phases. More specifically, clay minerals, iron, aluminium and manganese (oxyhydr)oxides, and the quantity and nature of organic matter represent the most important carrier phases and vary according to the biochemical conditions of the environment (Alloway, 2013; Claudia M. Do Valle *et al.*, 2005; Roulet and Lucotte, 1995; Skyllberg *et al.*, 2006a).

The co-inertia analysis (Figure 3) revealed 82.06% co-variance between the mercury extraction data sets and the main physico-chemical components of the rehabilitated soils. In this study, we found significant correlations between all extractions of the most mobile and potentially toxic forms of mercury. This could indicate relatively similar mercury retention and mobilization mechanisms between different rehabilitated sites.

Extractions E1, E2 as well as the highly soluble fractions F1, F2 and F3 are positively correlated with clay and total aluminium contents. In tropical soils, rich in kaolinite and aluminosilicates, the adsorption of mercury in clay minerals may be important (Alloway, 2012), especially when the pH is above 5 (Anderson, 1979). This distribution in soil of soluble fractions of mercury in clay minerals is consistent with the literature and shows that mercury adsorbed on these soil phases appears readily mobilizable.

The significant correlation between TOC, non-mobile mercury and total mercury is consistent with the literature (Schuster, 1991). This appears to confirm the importance of organic matter, particularly S groups, in immobilizing mercury as cinnabar in soils due to the chalcophile nature of mercury. This study also shows a significant association ($R^2 = 0.47$, $p = 0.016$) between total iron and total mercury. Although iron oxide concentrations in soils were not measured in this study, these results confirm the importance of iron in the biogeochemistry of mercury and its retention in soil phases. This hypothesis also seems to be confirmed by the important correlations observed between semi-mobile mercury extraction and silty soil fractions, rich in metal-oxyhydroxides such as goethite or hematite. Semi-mobile mercury extraction is mainly represented by Hg-metal amalgams such as Fe-oxyhydroxides and these results could confirm a strong retention of mercury in metal oxides, as has been demonstrated by Guedron (Grimaldi *et al.*, 2008) on natural and mining Guiana soils.

4.5. Footprint of rehabilitation on soil functioning and cover

The various stages of rebuilding an ecosystem after human degradation such as mining are complex, multidisciplinary and often involve ecological engineering. Each degraded site will have different physico-chemical properties and history of operation, making it difficult to generalize ecological restoration protocols. On mining sites in French Guiana, these protocols will have to be adapted according to the degree of site contamination, soil texture, water regime and of course the nature of the plant species used for restoration (Loubry, 2002). *Clitoria racemosa* is a fabacea native to South America and favors sandy-gravelly or even sandy-clay substrates. At the Belizon mine, difficult site rehabilitation and earthworks led to a high degree of textural heterogeneity, resulting in a mosaic of vegetation and partial success in ecological restoration. The recovery of the macrocuts was not effective on the overly draining and sandy substrate of the Bel 1 plots, now colonized by *cyperaceae sp.* On the Bel 2 plots, the significant presence of silt led to a rapid covering of the site by *Lycopodiella sp.*, preventing any recovery of *C.racemosa* plants. The rational use of other products such as *Acacia mangium*, adapted to gravel surfaces, and *Erythrina fusca*, adapted to silty substrates on the Bel 1 and Bel 2 plots respectively, could have allowed a more widespread success of ecological restoration. These results showed the importance of adapting ecological restoration protocols according to the nature of the substrate as already described by Loubry (Loubry, 2002), but which in fact is not always feasible.

On the former Yaoni mine, the very significant differences in terms of organic constituents of the soil provide interesting elements for the restoration of mining sites. The very low CNP stocks on plots Yao 1 and Yao 2 showed that mining activity depletes organic constituents and soil fertility. 17 years after the end of the rehabilitation, these sites had still not found shrub or tree cover and ecological succession seemed to be blocked. The controlled recovery of vegetation on the Yao 3 site has highlighted the positive effect of the establishment of a cover of fabaceae on the renewal of the stock of nutrients and organic matter.

In rehabilitated soils, as in natural soils, the retention, mobility and toxicity of mercury is governed by the nature and quantity of the different carrier phases. This study shows that the impact of non-homogeneous mine site remediation processes has altered mercury speciation by acting directly on soil texture. These results also show that the level of

vegetation cover, and the level of organic matter brought to the soil, has improved mercury retention and sanitary quality.

Conclusion

We evaluated the effect of the rehabilitation of Guyana's mining sites in order to link soil texture with the quality of ecological restoration, on the biochemical quality of the soil and the potential toxicity of mercury. The results indicate very variable and heterogeneous soil textures even on nearby sites. Some sites rehabilitated with too much silt or sand have not allowed the ecological restoration of a tree canopy. The results also highlight a direct impact of the success of ecological restoration on the return of microbial activities related to biogeochemical cycles. The provision of bedding using fabaceous species seems to be one of the key factors for the success of ecological restoration. The results also show an impact of soil texture on mercury mobility and toxicity. Environmental speciation measures show a link between mercury mobility and the nature of rehabilitation. The least restored sites have potentially higher concentrations of mobile and semi-mobile mercury, related to the quantities of clays and silts. The homogeneous texture of the restored Yaoni site, as well as the establishment of a dense tree canopy, has contributed to limiting mercury mobility by modifying its speciation towards more insoluble forms such as cinnabar.

Chapitre V

Conclusion générale et perspectives

1. Rappel des objectifs

L'objectif principal de ce travail de thèse était d'établir un bilan de la qualité du sol et du fonctionnement des cycles biogéochimiques dans les sols d'anciens sites miniers guyanais réhabilités après exploitation, puis restaurés avec un couvert végétal varié. L'objectif secondaire était de comprendre les interactions microbiennes intervenant dans la régulation des processus biogéochimiques, en incluant le cycle du mercure dans le diagnostic environnemental, afin d'apporter une vision de la qualité sanitaire des sites miniers et du devenir du mercure après les étapes de restauration écologique. Les travaux de cette thèse ont été présentés à travers trois chapitres ; un premier chapitre établissant un bilan sur le fonctionnement des cycles biogéochimiques sur deux sites miniers réhabilités de référence, l'un entièrement revégétalisé par des espèces de fabacées, l'autre uniquement réhabilité avec une absence totale de couvert arboré. Un second chapitre axé sur une description des activités microbiennes en réponse à des facteurs abiotiques (température, humidité, conditions d'aérobies), en lien avec la mobilité du mercure. Un troisième et dernier chapitre apportant une réflexion sur l'impact de l'hétérogénéité des protocoles de réhabilitation sur la spéciation environnementale du mercure et sur les principales activités enzymatiques indicatrices de la qualité des sols. Si les résultats obtenus lors de ce projet ont pour vocation d'être des outils potentiels d'indication de l'efficacité et de la qualité de la restauration écologique en Guyane française, nous espérons qu'ils intéresseront aussi bien le monde de la recherche que les professionnels en charge de la revégétalisation et la réhabilitation des sites d'orpaillages en particulier et miniers en général.

Les objectifs initiaux de ces travaux ont permis d'identifier une problématique plus large et d'élargir nos objectifs de recherches avec les interrogations suivantes :

- L'appréciation des fonctionnalités biogéochimiques est-elle pertinente pour évaluer la qualité de la restauration écologique ?
- Comment les différentes modalités de réhabilitation et de revégétalisation influencent-elles les communautés microbiennes dans les sols ?
- Comment l'instauration d'un couvert végétal varié peut impacter le cycle et la mobilité du mercure sur les anciens sites miniers ?
- Existe-t-il un lien entre la réussite de la revégétalisation et la qualité de la réhabilitation des sols miniers après exploitation ?

Afin de répondre à ces questions nous avons développé des expérimentations en mésocosmes permettant de suivre le métabolisme microbien sous différentes conditions contrôlées similaires à celles rencontrées sur le terrain. L'évolution de ce métabolisme a été mise en lien avec les propriétés physico-chimiques du sol et le comportement de certains éléments métalliques, notamment le mercure. Les différents articles présentés dans cette thèse regroupent les principales données recueillies au cours des expérimentations et permettront d'améliorer le diagnostic environnemental de certains modes de restauration écologique dans le bassin amazonien.

2. Principaux résultats

Les données expérimentales obtenues au cours de ces travaux de thèse proviennent des sites de Yaoni et de Bélizon en Guyane française et sont présentées à travers 5 articles résumés ci-après, et discutés la dernière partie de ce manuscrit. Les principaux résultats sont également illustrés dans un schéma bilan récapitulatif permettant de visualiser rapidement les principales conclusions de ces travaux.

Article 1 : Les propriétés physico-chimiques, la spéciation de certains éléments traces métalliques et les activités microbiennes en relation avec le fonctionnement des cycles du carbone, de l'azote et du phosphore ont été étudiés sur deux anciens sites miniers de références, réhabilités il y a 17 ans ; l'un, entièrement restauré par un couvert de fabacées (R), l'autre, non restauré (Sv) avec seulement quelques herbacées. Les résultats obtenus mettent en évidence des différences très significatives en termes de qualités biochimiques des sols. Le pool de nutriments très faible sur le site Sv, même après 17 ans de réhabilitation, serait un facteur de limitation des activités et de la densité des populations microbiennes, entraînant un blocage des successions écologiques. Le site R quant à lui, a montré des activités biogéochimiques performantes mais néanmoins en deçà du site témoin correspondant à une forêt naturelle non anthropisée. L'évaluation de la qualité des sols, en utilisant la spéciation de certains éléments traces métalliques dans le bilan environnemental, a montré des résultats contrastés. Bien que les quantités en arsenic, zinc, cuivre et chrome soient importantes, ces éléments sont majoritairement non mobiles ou difficilement mobiles dans les phases du sol. Concernant le mercure, sa mobilité semble accrue sur le site Sv et des modifications de sa spéciations ont été observées entre les parcelles Sv et R, avec notamment une forte concentration de mercure (60%) dans la phase organique du site R.

Article II : La résilience des communautés microbiennes des sols, en réponse à une modification de facteurs abiotiques simulant des changements climatiques. Ce travail a été réalisé en mésocosmes, avec 4 traitements expérimentaux, 2 températures (28 et 38°C) et deux humidités (70 et 100% CC), sur des échantillons de sols provenant de 3 sites réhabilités il y a 18 ans et d'un site contrôle naturel. Deux sites réhabilités et restaurés avec des fabacées ; l'un en monoculture d'*Acacia mangium*, l'autre avec une association d'*Acacia mangium* (Aca) et de *Clitoria racemosa* (Mf), et un site recouvert par de la végétation spontanée (Sp) ont été échantillonnés. Une étude en mésocosmes sur 34 jours avec un suivi des fonctionnements du cycle du carbone, de l'azote et du mercure dans les sols a permis de mettre en évidence des comportements différents entre les sites réhabilités. La modification des fonctionnalités microbiennes dues aux différents traitements expérimentaux a semblé montrer un gradient de réponses en fonction de la densité microbienne initiales, entre le site contrôle naturel et le site Mf ayant les plus fortes réponses. Parmi les facteurs étudiés, l'effet de la température a semblé relativement faible alors que l'augmentation de l'humidité a globalement conduit à une diminution des activités enzymatiques telluriques. Les résultats ont également montré que la mobilisation du mercure dans les sites restaurés était plus importante que sur le site naturel, ce qui pourrait indiquer un effet des fabacées sur la mobilisation de certains éléments traces.

Article III : La capacité des communautés microbiennes du sol à assurer la dégradation de la matière organique est un facteur clef du fonctionnement global des écosystèmes. Dans ce troisième article nous avons cherché à évaluer la minéralisation du carbone, de l'azote et du phosphore, en lien avec la diversité catabolique grâce au système Ecolog, dans 6 sites miniers réhabilités. Les 3 premiers sites non réhabilités (NR) étant simplement recouverts par de la végétation spontanée et les 3 autres sites réhabilités (R) caractérisés par une réussite des protocoles de restaurations écologiques avec différentes espèces de fabacées. Les résultats obtenus mettent en avant un effet direct de l'implantation d'un couvert arboré sur les sites restaurés, avec un doublement, de la biomasse microbienne tellurique et une augmentation de la minéralisation de l'azote et du phosphore. Les résultats mettent également en avant que la revégétalisation des sites R a induit une modification significative ($p = 0.001$) de la diversité catabolique, en améliorant les capacités de dégradation d'une variété de substrats sur le dispositif Biolog, tout en induisant une richesse spécifique

(nombre de substrats dégradés) plus régulière et significativement plus importante. Ces résultats confirment que la revégétalisation des sites miniers impacte positivement la diversité catabolique microbienne, ce qui améliore les fonctionnalités des cycles biogéochimiques des principaux macronutriments, permettant ainsi une restauration écologique plus performante et rapide.

Article IV : En raison de leur localisation et de leur topographie, les sites d'orpillages alluvionnaires sont sensibles aux épisodes d'hydromorphies. Ces inondations courtes ou prolongées peuvent donc entraîner des conditions anaérobies et favoriser le métabolisme de certaines communautés microbiennes réductrices. Dans cet article nous avons étudié l'impact de conditions réductrices au cours d'une expérimentation de 35 jours sur le métabolisme des communautés ferri et sulfato réductrices de 5 sols miniers réhabilités et sur le passage en solution du fer, du manganèse, de l'aluminium et du mercure dans le milieu de culture. Les résultats obtenus illustraient deux tendances distinctes entre les différents sites miniers réhabilités. Dans les échantillons des deux sites les mieux restaurés, nous avons mesuré des activités ferri-réductrices corrélées avec une solubilisation importante du manganèse et non corrélées avec la solubilisation du mercure. Sur les sites non restaurés, les activités ferri-réductrices étaient très faibles mais nous avons enregistré des activités sulfato-réductrices corrélées avec une solubilisation du mercure deux fois plus importantes que dans les sites restaurés. Ces résultats mettent en évidence que les épisodes d'inondation des anciens sites miniers peuvent impacter la mise en solution de certains éléments métalliques, en raison de la présence de communautés microbiennes réductrices, mais que la présence d'un couvert arboré semble limiter ces processus.

Article V : La réussite de la restauration écologique des sites d'orpillages est essentiellement conditionnée par une maîtrise des étapes de réhabilitation. Plus la réhabilitation sera homogène sur l'ensemble du site, plus la reprise de la végétation sera homogène et efficace. Dans ces travaux, nous avons cherché à évaluer l'impact de la texture et de l'hétérogénéité de 6 sites miniers dans les régions de Bélizon et Yaoni, sur le fonctionnement de 7 activités enzymatiques indicatrices de la qualité du sol et sur la spéciation environnementale du mercure. Sur les sites de Bélizon, la réussite de la restauration écologique semblait être conditionnée directement par la texture du sol. De trop fortes concentrations en limons et en sables avaient limité la reprise de *Clitoria*

racemosa. Les résultats ont montré que les activités enzymatiques telluriques ne semblaient pas être impactées directement par la texture du sol mais davantage par la quantité de matière organique apportée au sol, grâce à la reprise d'un couvert arboré. Concernant la spéciation environnementale du mercure, les résultats étaient plus contrastés et fortement corrélés avec les propriétés physico-chimiques des sols miniers réhabilités. La présence importante d'argile favoriserait la mobilité du mercure dans les sites faiblement restaurés alors que la présence de matière organique dans les sites restaurés limiterait la mobilité du mercure au profit d'une immobilisation sous des formes mercurielles comme le cinabre. Ces résultats mettent en lumière l'impact de la maîtrise des étapes de réhabilitation dans la réussite de la revégétalisation, ce qui semble être un facteur clef dans le recouvrement des activités biogéochimiques et dans l'immobilisation du mercure.



Schéma bilan illustrant les principaux résultats. La figure A représente les différents sols étudiés dans ces travaux : Les sites (1) et (2) correspondent aux sites non restaurés dans la région de Yaoni, les sites (3) et (4) correspondent aux sites non restaurés de la région de Bélizon, le site (A) est restauré avec *Clitoria racemosa*, le site (B) est restauré avec *Acacia mangium*, le site (C) est restauré avec une association de fabacées. Les figures B, C et D représentent les variables directement influencées par le mode de revégétalisation, en pourcentage par rapport à un site naturel control. La figure B résume le pool total de C, N, P, de matière organique et de biomasse microbienne, la figure C résume les potentiels de minéralisation du C, N, P ainsi que la diversité catabolique et l'indice de Shannon, la figure D résume les activités enzymatiques. La figure D illustre l'impact des différentes méthodes de réhabilitation sur la texture du sol à travers un triangle de texture (Aisne à 15 classes). La figure E illustre les principales tendances concernant la mobilité du mercure, avec les principaux facteurs de mobilité.

3. Discussion

Les enjeux de la distinction entre réhabilitation, revégétalisation et restauration écologique

Si un des objectifs majeurs de cette thèse était d'évaluer la qualité de la restauration écologique des sites miniers guyanais en utilisant comme outil les propriétés biogéochimiques des sols, il nous est apparu primordial de caractériser en premier lieu les processus de réhabilitation et de revégétalisation. Comme nous l'avons décrit dans le premier chapitre de cette thèse, la restauration écologique des sites d'orpaillages peut être segmentée en deux étapes. La première est la réhabilitation ou régalage des surfaces alluvionnaires qui consiste en la reconstitution d'un couvert plan et le plus homogène possible. La seconde étape est la revégétalisation qui consiste en une réintroduction progressive d'espèces végétales, avec une priorité pour les espèces locales. Sur les terrains miniers guyanais la revégétalisation est le plus souvent conduite avec des espèces de fabacées dans les premières années, dans le but de renouveler le stock de matière organique grâce à ces espèces peu exigeantes en nutriments et fixatrices d'azote. Si certains considèrent ces étapes comme indépendantes, nos expériences de terrains et de laboratoire montrent le contraire.

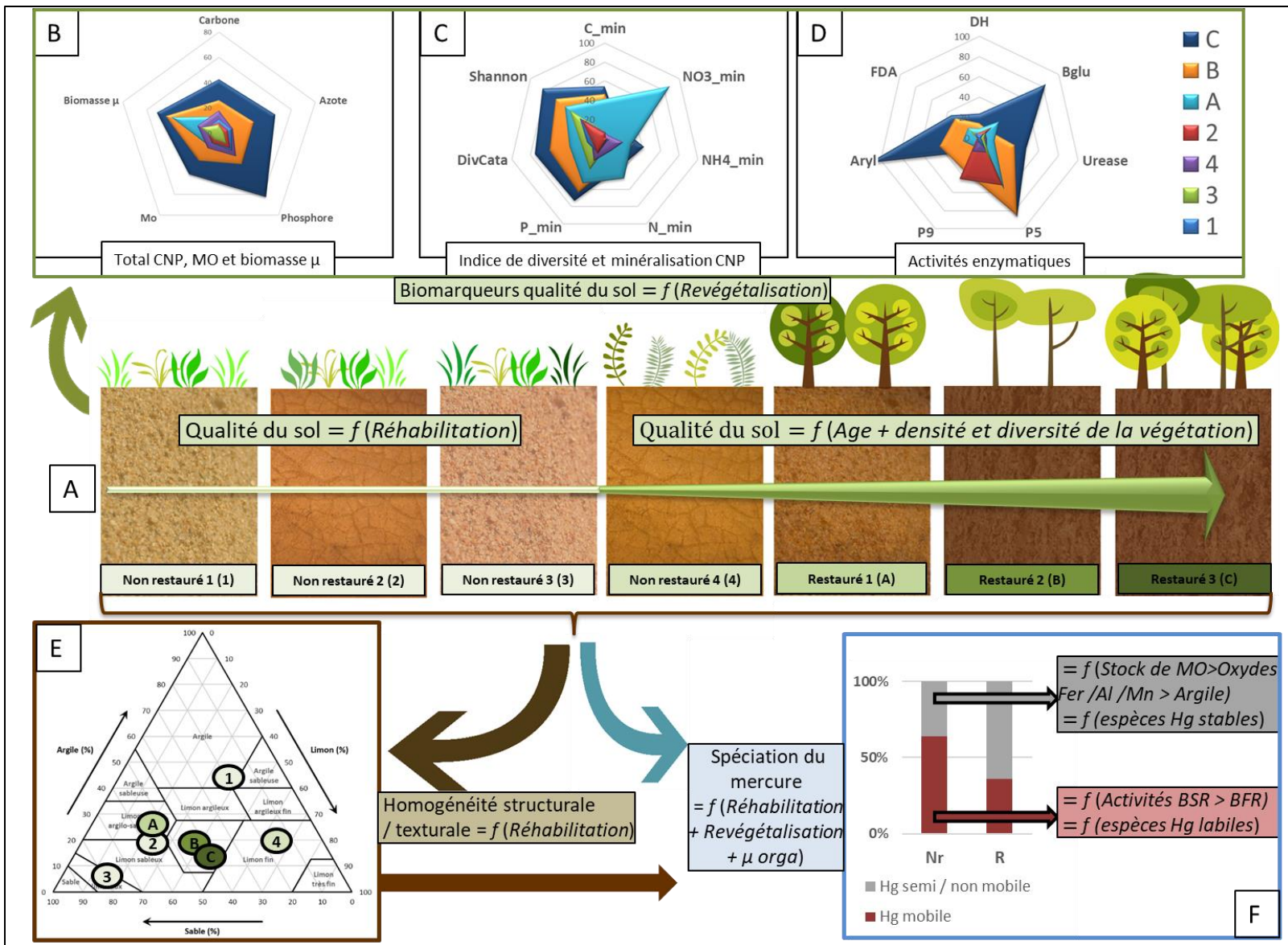
Les deux campagnes de terrains successives dans l'ancienne concession minière de Yaoni ont permis de mettre en évidence une hétérogénéité structurale des sols réhabilités extrêmement importante. Les sites non restaurés et restaurés échantillonnés en décembre 2014 avaient une texture très sableuse (77% de sable en moyenne) alors que les résultats de la seconde campagne de terrain, sur les mêmes parcelles du site de Yaoni, ont montré des textures totalement différentes, majoritairement limono-argileuses. Ces différences sont principalement dues à l'hétérogénéité générale de ces anthroposols et aux difficultés d'effectuer un échantillonnage optimal, plutôt qu'au processus pédogénétique ayant pu modifier le profil textural en moins d'un an entre les deux campagnes.

Néanmoins, la plantation de légumineuses sur ces parcelles selon un protocole identique (Loubry 2002) a eu comme effet de permettre un retour vers un fonctionnement du sol assez semblable à celui d'une forêt non anthropisée. Ces résultats sont similaires à ceux obtenus par Heidy Schimann en 2006. Dans le cas présent, il est intéressant de remarquer que l'hétérogénéité de la réhabilitation n'a pas eu d'impact sur la reprise de la végétation et

que le choix d'*Acacia mangium* a été particulièrement adapté. Bien que l'Office Nationale des Forêts ait prohibé l'utilisation d'*Acacia mangium* en raison de son origine non guyanaise, son utilisation contrôlée permet néanmoins un retour rapide vers un équilibre forestier.

Remarquons également que sur le site de Yaoni, les parcelles réhabilitées ayant été restaurées avec des associations de fabacées et non avec des monocultures d'*Acacia mangium* ont développé des biomarqueurs indicateurs de la qualité du sol (biomasse microbienne du sol, activités enzymatiques) significativement plus importants. Il semble également crucial de souligner que les différences de textures, mesurées lors des deux campagnes d'échantillonnage n'ont pas eu d'impacts significatifs sur les teneurs en biomasse microbienne au sein d'une même modalité de revégétalisation. Si les travaux de Stéphane Guedron (2008) ont mis en évidence des variations très importantes de teneur en mercure sur les sites miniers, parfois à de faibles distances, ces différences illustrent également le fait que la réhabilitation des sites miniers ne réhomogénéise pas intégralement les constituants minéraux du sol.

Le dernier point concernant la réhabilitation de l'ancienne mine de Yaoni est l'absence de végétation arborée sur les multiples parcelles non revégétalisées. Sans une induction de la revégétalisation, même après plus de quinze années après la fin de l'exploitation, aucun couvert arboré ne s'est installé sur ces parcelles. Les mesures de qualité chimique du sol ont fait état d'une limitation majeure en macroéléments (carbone, azote et phosphore) induisant une très faible biomasse microbienne, un blocage des activités microbiennes liées au fonctionnement des cycles biogéochimiques ainsi qu'une diversité catabolique significativement altérée par rapport à des sites restaurés. Cette résultante d'un état de dégradation avancée de la qualité du sol entraîne un blocage des successions écologiques et nous pouvons supposer qu'un laps de temps important sera nécessaire pour que la pédogénèse de ces sites développe à nouveaux des conditions favorables à l'établissement de la forêt tropicale. Soulignons également que les différences de mobilité du mercure mesurées sur ces sites entre les deux campagnes (Article I & II) pourraient davantage être liées à ces différences texturales plutôt qu'aux processus de solubilisation microbienne.

Si l'étude de la qualité de la restauration écologique sur les sites de références de Yaoni met en lumière des trajectoires de recouvrement écologique très distinctes, ces processus sur l'ancienne mine de Belizon sont moins évidents. Après une fin d'exploitation début 2013,

l'intégralité du site a été réhabilité et un protocole de revégétalisation avec des macro boutures de *Clitoria racemosa* a été utilisé uniformément sur l'ensemble du site. Lors de la campagne de terrain d'avril 2016 nous avons découvert que la réussite de la revégétalisation n'a pas été totale ; seulement un tiers des parcelles a été restaurée avec *Clitoria racemosa*. Le second tiers des parcelles a été recouvert uniquement par quelques herbacées, avec une couverture végétale très proches des parcelles non restaurées de Yaoni et le dernier tiers a été presque exclusivement recouvert par *Lycopodiella sp.* Il est alors apparu évident que la revégétalisation des sites miniers ne pouvait s'affranchir d'une étude pédologique préliminaire pour déterminer les principales contraintes physico-chimiques pouvant inhiber la reprise de la végétation.

En effet, la caractérisation granulométrique des sites de Bélizon a mis en évidence des textures extrêmement variables sur des parcelles très proches. D'après ces résultats, l'hétérogénéité texturale entraînant de fortes concentrations en limons et en sables sur certaines parcelles a limité la reprise des macro boutures de *Clitoria racemosa*. La campagne de terrain sur le site de Bélizon permet d'éclaircir plusieurs aspects de la restauration écologique.

Le premier concerne la qualité de la réhabilitation : Les différentes études sur les sols miniers de Guyane montrent que le respect de l'homogénéisation des « stériles » après l'exploitation est un point clef dans la réussite globale de la restauration. Cependant, cette étape n'est malheureusement pas toujours réalisée avec précision, souvent en raison d'une topographie du terrain peu propice aux manèges des engins lourds.

Le second aspect concerne la relation entre réhabilitation et revégétalisation. Si le cas d'étude de Yaoni montre que la revégétalisation est une réussite globale de reconstruction d'un écosystème forestier et cela sans relation avec le profil textural du sol, l'étude du site de Bélizon indique cependant que la revégétalisation ne serait pas l'étape primordiale du processus de restauration écologique. Dans le cas où la réhabilitation est très hétérogène, il serait donc judicieux d'adapter le choix de l'essence végétale pour effectuer la phase pionnière de revégétalisation.

Pertinence de l'approche biogéochimique pour évaluer la qualité de la restauration écologique

La restauration écologique en Guyane française est finalement assez récente et véritablement active depuis moins de 20 ans. Les études expérimentales menées par l'IRD et le CIRAD dans les années 90 ont permis de mettre au point des protocoles adaptés pour revégétaliser les parcelles minières anthropisées. Depuis, une grande diversité de protocoles s'est développée au cas par cas mais leur suivi ainsi que leur évaluation soulèvent des enjeux écologiques importants. Comment rendre compte de l'efficacité des protocoles de revégétalisation dans la reconstruction des écosystèmes forestiers ? Différentes méthodes ont été développées pour apporter des outils de contrôle de la qualité de la reforestation que la simple validation de la présence d'un couvert arboré, et ce projet de thèse s'inscrit dans la continuité de ces différentes méthodes. Kanowski *et al* (2010) ont développé un référentiel et plusieurs outils visant à estimer le degré de recouvrement écologique des procédés de revégétalisation. Dans ce référentiel, la combinaison d'une approche écologique (structure de la forêt, composition des espèces végétales, composition des espèces d'oiseaux) couplée à des estimations de la séquestration du carbone (évaluation de la biomasse aérienne et du stock de carbone du sol), permet de réaliser un bilan environnemental très poussé, mais également très lourd à mettre en place et à contrôler dans le temps. Certaines méthodes d'évaluations, basées sur des approches paysagères et de quantification des principaux services écosystémiques (indice de qualité chimique du sol, stock de carbone total, infiltration de l'eau et réserve d'eau biodisponible) se révèlent être également pertinentes pour réaliser des diagnostics environnementaux. Néanmoins, ces méthodes d'évaluations prennent mal en compte les cycles biogéochimiques se trouvant à la base de la régénération des écosystèmes. L'utilisation de la diversité des activités microbiennes (diversité fonctionnelle) a donc été développée (Anderson 2003, Nannipieri 2002, Schimann 2012) pour rendre compte des différences de fonctionnalités dans les sols perturbés en s'appuyant sur leurs données biogéochimiques, permettant un diagnostic complémentaire.

Dans ces travaux nous avons cherché à évaluer la qualité de la restauration écologique en nous appuyant sur la capacité des communautés microbiennes à assurer les grands cycles biogéochimiques (carbone, azote et phosphore) et en incluant également la dynamique du mercure et les interactions microbiennes associées.

L'utilisation des activités microbiennes pour décrire l'état de restauration écologique des sols réhabilités a été pertinente et permet de distinguer assez finement la densité et la qualité du couvert végétal s'étant développées après l'exploitation. Parmi les paramètres microbiens mesurés, il apparaît, d'après nos résultats, que la biomasse microbienne tellurique est en relation directe avec la densité du couvert végétal. Les sites réhabilités et non restaurés de Yaoni ou de Bélizon, ont montré des teneurs en biomasse microbienne très faible, indiquant un état de dégradation du sol important. Le site minier revégétalisé avec un couvert dense de *Lycopodiella sp* possède significativement une biomasse microbienne plus élevée que les sites non restaurés mais très inférieure aux sites restaurés avec un couvert arboré. Parmi ces sites, il est intéressant de souligner que l'augmentation de la biodiversité végétale sur le site en bi-culture de Yaoni a contribué à augmenter le stock de biomasse microbienne, impactant directement et de manière positive les fonctionnalités des cycles biogéochimiques. Néanmoins, même sur les sites les plus restaurés, la densité microbienne reste en deçà des valeurs observées sur des sites contrôles naturels, ce qui laisserait penser que les associations de fabacées seules (dans notre cas) ne permettent pas un retour total des activités microbiennes du sol. Cette hypothèse semble être étayée par les très faibles différences de densité microbienne observées entre les deux monocultures ; celle d'*Acacia mangium* sur le site de Yaoni et celle de *Clitoria racemosa* sur le site de Bélizon.

En effet, ces deux types de monocultures, réalisées avec 15 années d'écart, aboutissent à des densités microbiennes très proches. Ce résultat indiquerait que le retour de la densité microbienne du sol serait très rapide lors de l'implantation d'un couvert arboré (3 ans environ), mais que le recouvrement total de la densité microbienne vers celle d'un site naturel stagnera si la diversité du couvert n'est pas élevée.

Les différents résultats de cette thèse, relatifs au fonctionnement des cycles biogéochimiques se sont également avérés intéressants pour évaluer l'état de restauration des sites miniers. En premier lieu, les différents taux de minéralisation de la matière organique évalués à partir de la production de CO₂, de nitrates, d'ammonium et de phosphates, ainsi qu'avec les différentes activités enzymatiques ont donné des résultats positivement corrélés avec les teneurs en biomasse microbienne, tout en apportant des informations complémentaires sur les fonctionnalités des sols réhabilités. La minéralisation du phosphore indique par exemple des activités très limitées pour les sols les moins

revégétalisés de l'ancienne mine de Yaoni, ce qui pourrait être une des causes de l'absence de reprise des successions écologiques, même après plus de 15 années de « restauration » naturelle. Le phosphore étant l'un des éléments les plus limitants des écosystèmes, la prise en compte des activités microbiennes liées à sa minéralisation semble donc intéressante pour tenter d'estimer des trajectoires de restauration écologique.

Comme rapporté dans la littérature, les mesures de respiration du sol sont directement impactées par la biomasse microbienne aérobie totale, qui représente généralement plus de 90% de la biomasse microbienne tellurique. Néanmoins, les variations de conditions d'incubation induites dans l'article II indiquent des réponses relativement importantes de la communauté hétérotrophe, ce qui pourrait indiquer une certaine sensibilité de cette dernière (Rüter *et al.*, 2004). Les processus de nitrification et d'ammonification, généralement considérés comme sensibles au niveau d'altération des sols, sont moins corrélés à la biomasse totale et semblent donc indiquer que les différentes modalités de revégétalisation ont induit des modifications dans la diversité des bactéries du cycle de l'azote. D'après nos résultats, les parcelles en monoculture de *Clitoria racemosa* auraient favorisé le développement de communautés nitrifiantes alors que ces dernières seraient moins présentes sur les parcelles d'*Acacia mangium*. Les fortes variations observées au niveau du cycle de l'azote pourraient également être liées à la faible redondance fonctionnelle des communautés nitrifiantes (Griffiths *et al.*, 2000a, 2000b).

A contrario, l'évaluation de la diversité catabolique grâce à la méthode Ecolog, nous a permis de mettre en avant que la biomasse n'est pas entièrement corrélée avec la diversité catabolique dans les sites restaurés. En effet, bien que l'effet « revégétalisation » ait montré une amélioration significative de la diversité catabolique par rapport aux sites non restaurés, les indicateurs de diversité catabolique entre les sites de Bélizon (monoculture *Clitoria racemosa*) et de Yaoni (monoculture *Acacia mangium* et bi-culture) indiquent des différences de catabolisme significatives entre ces deux sites, qui seraient davantage liées à l'âge des parcelles réhabilitées plutôt qu'à la biomasse totale.

S'il apparaît délicat et peut-être trop ambitieux de réaliser des modèles complets de résilience des fonctionnalités biogéochimiques sur des sites dégradés, de nombreux auteurs (Bradshaw, 1997a, 1983; Cooke and Johnson, 2002; Jaffré *et al.*, 1997) estiment que plusieurs dizaines d'années sont nécessaires au recouvrement des fonctionnalités d'un

écosystème dégradé par l'activité minière. Bien que nos travaux aient été effectués en mésocosmes, dans des conditions qui ne reflètent pas entièrement le milieu naturel, ils mettent en avant un retour à l'équilibre des fonctionnalités des cycles biogéochimiques des sites réhabilités les plus anciens très encourageant. Bien que la biomasse microbienne totale n'ait pas été entièrement restaurée sur les sites réhabilités, les mesures d'activités enzymatiques et de diversité catabolique confirment un retour performant des fonctionnalités microbiennes, qui pourraient être liées à un retour de la diversité génétique.

Un des objectifs majeurs de cette thèse était d'inclure une évaluation de la mobilité des éléments traces toxiques dans le diagnostic environnementale des sites réhabilités. Dans le premier chapitre nous nous sommes intéressés à une diversité d'éléments métalliques à travers des mesures de spéciation opérationnelle (distribution sur les différentes phases du sol). Bien que les concentrations totales de certains métaux et métalloïdes soient importantes dans les sites réhabilités (Arsenic et Chrome par exemple), leur mobilité est relativement faible. Concernant le mercure, nous avons mesuré des concentrations assez faibles qui ne témoignent pas d'une utilisation récente du mercure dans le processus d'extraction minière. Néanmoins, les variations significatives de concentrations entre les sites non revégétalisés et revégétalisés, ainsi que les différences de mobilité, nous ont interpellé. Les résultats relatifs à la mobilité du mercure, obtenus dans cette thèse soulignent l'influence de la revégétalisation sur le cycle du mercure. Sur les anciens sites restaurés de Yaoni, il semblerait que la présence d'un couvert arboré dense, couplé à une forte stabilité structurale du sol liée à l'augmentation de la teneur en matière organique, soit des moteurs de la rétention du mercure dans les sols. Concernant les sites non revégétalisés, il semble difficile de généraliser un modèle de mobilité du mercure, en raison d'une hétérogénéité structurale importante. Néanmoins, les résultats mettent en avant une dynamique de mobilité du mercure accrue, en raison notamment d'une spéciation environnementale en faveur d'espèces chimiques libres, ainsi qu'une présence potentielle de communautés microbiennes favorisant la mobilité et la méthylation du mercure. Le rôle positif du couvert végétal dans la rétention des éléments métalliques dans les sols miniers serait donc appuyé par nos résultats.

4. Perspectives

Les études réalisées au cours de ces travaux ont permis de répondre à une partie des questions posées initialement mais certains points n'ont pas pu être développés. De nombreux restent à éclaircir et plusieurs questions viennent s'ajouter après l'interprétation des premiers résultats. Si les résultats mettent en avant une diversité des activités microbiennes en fonction des sites réhabilités nous n'avons pas eu la possibilité d'établir un profil génétique des communautés microbiennes. Les approches récentes de métabarcoding pourraient permettre d'affiner notre connaissance de la diversification des communautés microbiennes lors de la restauration écologique des sites miniers. Impossible également, sans une approche de génétique des communautés, de caractériser les microorganismes ferri et sulfato réducteurs, responsables de la solubilisation de certains éléments traces, dont le mercure. Si la caractérisation des bactéries impliquées dans la mobilité du mercure a déjà été réalisée dans notre laboratoire par Jennifer Harris, il serait nécessaire d'établir des liens entre les communautés des sites naturels, des sites miniers et des sites en cours de restauration écologique. Toujours à propos du mercure, si nous avons mis en lumière des mécanismes de mobilisation, nous n'avons pas été en mesure, faute de temps, de quantifier les flux potentiels de méthylmercure, notamment dans notre expérimentation en conditions réductrices. Si les travaux de Stéphane Guedron ont mis en avant des mécanismes de méthylation sur des sites d'orpillage, il serait primordial de quantifier également ces flux dans les sites réhabilités pour des raisons sanitaires. Une perspective intéressante serait également de caractériser le devenir des éléments traces métalliques mobiles sur ces sites, en caractérisant, les pertes dans le réseau hydrique ou bien la fixation dans la biomasse végétale. Une question importante demeure également, concernant la pertinence de l'échantillonnage réalisé dans ces travaux. Si nous avons essayé de réaliser le meilleur échantillonnage possible, l'hétérogénéité texturale et structurale des anciens sites miniers rend les étapes de prélèvements de sol très délicates et sujettes à discussions. Le choix des parcelles, guidé par la faisabilité des missions de terrains, est également un point central de cette étude et il serait intéressant de cibler un plus large spectre de sites réhabilités. Néanmoins, les sites réhabilités étant difficilement comparables en termes d'historique d'exploitation, de structure de sol et de diversification du couvert végétal, il serait intéressant d'estimer des trajectoires de recouvrement de certains indicateurs écologiques (densité microbienne, diversité catabolique et génétique) en fonction de l'âge des parcelles,

afin de développer des modèles de restauration des activités microbiennes des sols réhabilités.

Enfin, dans cette thèse nous nous sommes intéressés principalement aux activités microbiennes du sol mais nous n'avons pas ciblé la flore rhizosphérique, beaucoup plus difficile à échantillonner. Or, les espèces de fabacées utilisées pour la restauration écologique sont avant tout utilisées en raison de leur capacité à former des nodules racinaires grâce aux différentes symbioses microbiennes. Ce sont ces nodosités qui permettent la fixation de l'azote atmosphérique et qui conditionnent donc, en partie, la reprise de la végétation sur les sites réhabilités, très appauvris en azote minéral. La dernière perspective qui pourrait être ambitieuse serait d'estimer l'impact de la rhizosphère dans la mobilité des éléments traces métalliques, notamment du mercure et de caractériser notamment les acides organiques et exsudats racinaires qui seraient responsables de la dissolution de certaines phases porteuses du mercure, de la spéciation et du transport de ce dernier.

Références bibliographiques

A

- Abbas, G., Saqib, M., Akhtar, J., Murtaza, G., Shahid, M., Hussain, A., 2016. Relationship between rhizosphere acidification and phytoremediation in two acacia species. *Journal of Soils and Sediments* 16, 1392–1399. doi:10.1007/s11368-014-1051-9
- Acosta-Martínez, V., Cruz, L., Sotomayor-Ramírez, D., Pérez-Alegría, L., 2007. Enzyme activities as affected by soil properties and land use in a tropical watershed. *Applied Soil Ecology*. doi:10.1016/j.apsoil.2006.05.012
- Ahmann, D., Krumholz, L.R., Hemond, H.F., Lovley, D.R., Morel, F.M.M., 1997. Microbial mobilization of arsenic from sediments of the Aberjona watershed. *Environmental Science and Technology* 31, 2923–2930. doi:10.1021/es970124k
- Alloway, B., 2012. Heavy Metals in Soils: Trace Metals and Metalloids in Soils and Their Bioavailability, Environmental Pollution. doi:10.1007/978-94-007-4470-7
- Alloway, B.J. (Ed.), 2013. Heavy Metals in Soils, Environmental Pollution. Springer Netherlands, Dordrecht. doi:10.1007/978-94-007-4470-7
- Amouroux, D., Wasserman, J.C., Tessier, E., Donard, O.F.X., 1999. Elemental mercury in the atmosphere of a tropical Amazonian forest (French Guiana). *Environmental Science and Technology*. doi:10.1021/es990119b
- Anderson, A., 1979. The Biochemistry of Mercury in the Environment, in: *Mercury in Soils*. pp. 79–112. doi:10.1016/0016-7037(80)90239-2
- Anderson, J.P.E., 1982. Soil respiration, in: *American Society of Agronomy, S.S.S. of A. (Ed.), Methods of Soil Analysis. Part 2. Chemical and Microbiological Properties*. American Society of Agronomy, Soil Science Society of America, Madison, pp. 831–871.
- Anderson, J.P.E., Domsch, K.H., 1978. A physiological method for the quantitative measurement of microbial biomass in soils. *Soil Biology and Biochemistry* 10, 215–221. doi:10.1016/0038-0717(78)90099-8
- Andersson, A., 1979. The Biogeochemistry of mercury in the environment, in: Elsevier, A. (Ed.), *The Biogeochemistry of Mercury in the Environment*. Elsevier/North-Holland Biomedical Press, pp. 79–112. doi:10.1016/0016-7037(80)90239-2
- Angers, D.A., Pesant, A., Vigneux, J., 1992. Early Cropping-Induced Changes in Soil Aggregation, Organic Matter, and Microbial Biomass. *Soil Science Society of America Journal* 56, 115. doi:10.2136/sssaj1992.03615995005600010018x
- Ankley, G.T., Di Toro, D.M., Hansen, D.J., Berry, W.J., 1996. Assessing the ecological risk of metals in sediments. *Environmental Toxicology and Chemistry* 15, 2053–2055. doi:10.1002/etc.5620151201
- Arenas-Lago, D., Andrade, M.L., Lago-Vila, M., Rodríguez-Seijo, A., Vega, F.A., 2014a. Sequential extraction of heavy metals in soils from a copper mine: Distribution in geochemical fractions. *Geoderma* 230–231, 108–118. doi:10.1016/j.geoderma.2014.04.011
- Arenas-Lago, D., Andrade, M.L., Lago-Vila, M., Rodríguez-Seijo, A., Vega, F.A., 2014b. Sequential extraction of heavy metals in soils from a copper mine: Distribution in geochemical fractions. *Geoderma* 230–231, 108–118. doi:10.1016/j.geoderma.2014.04.011
- Asgharipour, M.R., Rafiei, M., 2015. The effects of land use on biomass and catabolic diversity of soil

microbial communities. doi:10.5897/AJAR11.1160

Asmar, F., 1997. Variation in activity of root extracellular phytase between genotypes of barley. *Plant and Soil* 195, 61–64. doi:10.1023/A:1004291512285

B

Badiane, N.N.Y., Chotte, J.L., Pate, E., Masse, D., Rouland, C., 2001. Use of soil enzyme activities to monitor soil quality in natural and improved fallows in semi-arid tropical regions. *Applied Soil Ecology* 18, 229–238. doi:10.1016/S0929-1393(01)00159-7

Baeyens, W., Monteny, F., Leermakers, M., Bouillon, S., 2003. Evaluation of sequential extractions on dry and wet sediments. *Analytical and Bioanalytical Chemistry* 376, 890–901. doi:10.1007/s00216-003-2005-z

Bahn, M., Janssens, I.A., Reichstein, M., Smith, P., Trumbore, S.E., 2010. Soil respiration across scales: towards an integration of patterns and processes. *New Phytologist* 186, 292–296. doi:10.1111/j.1469-8137.2010.03237.x

Balland-Bolou-Bi, C., Bolou-Bi, E.B., Alphonse, V., Giusti-Miller, S., Jusselme, M.D., Livet, A., Grimaldi, M., Bousserhine, N., 2019. Impact of microbial activity on the mobility of metallic elements (Fe, Al and Hg) in tropical soils. *Geoderma* 334, 146–154. doi:10.1016/j.geoderma.2018.07.044

Balland-Bolou-Bi, C., Turc, B., Alphonse, V., Bousserhine, N., 2017. Impact of microbial communities from tropical soils on the mobilization of trace metals during dissolution of cinnabar ore. *Journal of Environmental Sciences (China)* 56, 122–130. doi:10.1016/j.jes.2016.10.003

Barnhisel R. I., Hower J. M., 1997. Coal surface mine reclamation in the eastern United States : the revegetation of disturbed lands to hayland/pasture or cropland. *Advances in Agronomy*, 61 : 233-275.

Barret, J., 2004. *Illustrated Atlas of French Guyana*, French Guy. ed. Cayenne.

Basavaraja, P.K., Sharma, S.D., Dhananjaya, B.N., Badrinath, M.S., 2010. *Acacia nilotica* : A tree species for amelioration of sodic soils in Central dry zone of Karnataka , India. 19th World Congress of Soil Science, *Soil Solutions for a Changing World* 73–76.

Bastos, W.R., Gomes, J.P.O., Oliveira, R.C., Almeida, R., Nascimento, E.L., Bernardi, J.V.E., de Lacerda, L.D., da Silveira, E.G., Pfeiffer, W.C., 2006. Mercury in the environment and riverside population in the Madeira River Basin, Amazon, Brazil. *Science of the Total Environment* 368, 344–351. doi:10.1016/j.scitotenv.2005.09.048

Baty, F., Facompré, M., Wiegand, J., Schwager, J., Brutsche, M.H., 2006. Analysis with respect to instrumental variables for the exploration of microarray data structures. *BMC Bioinformatics* 7. doi:10.1186/1471-2105-7-422

Benoit, J.M., Gilmour, C.C., Mason, R.P., 2001. Aspects of bioavailability of mercury for methylation in pure cultures of *Desulfobulbus propionicus* (1pr3). *Applied and Environmental Microbiology*. doi:10.1128/AEM.67.1.51-58.2001

Bisseger, S., Rodriguez, M., Brisson, J., Weber, K.P., 2014. Catabolic profiles of microbial communities in relation to plant identity and diversity in free-floating plant treatment wetland mesocosms. *Ecological Engineering*. doi:10.1016/j.ecoleng.2014.03.063

Blodau, C., 2006. A review of acidity generation and consumption in acidic coal mine lakes and their watersheds. *Science of the Total Environment*. doi:10.1016/j.scitotenv.2006.05.004

- Bloem, J., Schouten, T., Sørensen, S., Breure, A.M., 2003. Application of microbial indicators in ecological approaches to monitor soil quality. *Ambio* In press.
- Borowik, A., Wyszowska, J., 2016. Soil moisture as a factor affecting the microbiological and biochemical activity of soil. *Plant, Soil and Environment* 62, 250–255. doi:10.17221/158/2016-PSE
- Bostick, B.C., Fendorf, S., 2003. Arsenite sorption on troilite (FeS) and pyrite (FeS₂). *Geochimica et Cosmochimica Acta* 67, 909–921. doi:10.1016/S0016-7037(02)01170-5
- Bothe, H. (Hermann), Ferguson, S.J. (Stuart J., Newton, W.E. (William E., 2007. *Biology of the nitrogen cycle*. Elsevier.
- Boudou, A., Dominique, Y., Cordier, S., Frery, N., 2006. Les chercheurs d'or et la pollution par le mercure en Guyane française: Conséquences environnementales et sanitaires. *Environnement, Risques et Sante*.
- Bousserrhine, N., 1995. Etude de paramètres de la réduction bactérienne du fer et application à la déferrification de minéraux industriels. Université Nancy 1.
- Bousserrhine, N., Gasser, U., Jeanroy, E., Berthelin, J., 1998. Effect of aluminium substitution on ferri-reducing bacterial activity and dissolution of goethites. *Comptes Rendus de l'Academie de Sciences - Serie IIa: Sciences de La Terre et Des Planetes* 326, 617–624. doi:10.1016/S1251-8050(98)80252-8
- Bousserrhine, N., Gasser, U.G., Jeanroy, E., Berthelin, J., 1999. Bacterial and chemical reductive dissolution of Mn-, Co-, Cr-, and Al-substituted goethites. *Geomicrobiology Journal* 16, 245–258. doi:10.1080/014904599270622
- Bradl, H.B., 2004. Adsorption of heavy metal ions on soils and soils constituents. *Journal of Colloid and Interface Science*. doi:10.1016/j.jcis.2004.04.005
- Bradshaw, A., 1997. Restoration of mined lands—using natural processes. *Ecological Engineering* 8, 255–269. doi:10.1016/S0925-8574(97)00022-0
- Bradshaw, A.D., 1983. the Reconstruction of Ecosystems. *Journal of Applied Ecology* 20, 1–17. doi:0021-8901/0400-0001
- Broos, K., Mertens, J., Smolders, E., 2005. Toxicity of heavy metals in soil assessed with various soil microbial and plant growth assays: a comparative study. *Environmental Toxicology and Chemistry* 24, 634–40.
- Butterfield, R.P., 1996. Early species selection for tropical reforestation: a consideration of stability. *Forest Ecology and Management* 81, 161–168. doi:10.1016/0378-1127(95)03649-0

C

- Campbell, C.D., Chapman, S.J., Cameron, C.M., Davidson, M.S., Potts, J.M., 2003. A Rapid Microtiter Plate Method To Measure Carbon Dioxide Evolved from Carbon Substrate Amendments so as To Determine the Physiological Profiles of Soil Microbial Communities by Using Whole Soil A Rapid Microtiter Plate Method To Measure Carbon Dioxide Ev. *Applied and Environmental Microbiology* 69, 3593–3599. doi:10.1128/AEM.69.6.3593
- Cao, C., Jiang, D., Teng, X., Jiang, Y., Liang, W., Cui, Z., 2008. Soil chemical and microbiological properties along a chronosequence of *Caragana microphylla* Lam. plantations in the Horqin sandy land of Northeast China. *Applied Soil Ecology* 40, 78–85. doi:10.1016/j.apsoil.2008.03.008

- Caravaca, F., Hernández, T., García, C., Roldán, A., 2002. Improvement of rhizosphere aggregate stability of afforested semiarid plant species subjected to mycorrhizal inoculation and compost addition. *Geoderma* 108, 133–144. doi:10.1016/S0016-7061(02)00130-1
- Cardinale, B.J., Srivastava, D.S., Emmett Duffy, J., Wright, J.P., Downing, A.L., Sankaran, M., Jouseau, C., 2006. Effects of biodiversity on the functioning of trophic groups and ecosystems. *Nature* 443, 989–992. doi:10.1038/nature05202
- Carmouze, J.-P., Lucotte, M., Boudou, A., 2001. Le mercure en Amazonie. IRD Éditions. doi:10.4000/books.irdeditions.2519
- Carpi, A. (2001). *The Toxicology of Mercure*. New York, John Jay College
- Cerqueira, B., Vega, F.A., Serra, C., Silva, L.F.O., Andrade, M.L., 2011. Time of flight secondary ion mass spectrometry and high-resolution transmission electron microscopy/energy dispersive spectroscopy: A preliminary study of the distribution of Cu 2+ and Cu 2+/Pb 2+ on a Bt horizon surfaces. *Journal of Hazardous Materials* 195, 422–431. doi:10.1016/j.jhazmat.2011.08.059
- Cécillon, L., 2008. Quels indicateurs pour évaluer la qualité de sols forestiers soumis à des contraintes environnementales fortes ? Thèse de l'Université Joseph Fourier de Grenoble. 215 p.
- Chacon, N., Silver, W.L., Dubinsky, E.A., Cusack, D.F., 2006. Iron Reduction and Soil Phosphorus Solubilization in Humid Tropical Forests Soils: The Roles of Labile Carbon Pools and an Electron Shuttle Compound. *Biogeochemistry* 78, 67–84. doi:10.1007/s10533-005-2343-3
- Chaer, G.M., Resende, A.S., Campello, E.F.C., De Faria, S.M., Boddey, R.M., Schmidt, S., 2011. Nitrogen-fixing legume tree species for the reclamation of severely degraded lands in Brazil. *Tree Physiology*. doi:10.1093/treephys/tpq116
- Chapin, F.S., Vitousek, P.M., Van Cleve, K., 1986. The Nature of Nutrient Limitation in Plant Communities. *The American Naturalist*. doi:10.1086/284466
- Chaussod, R., 1996. La qualité biologique des sols : Évaluation et implications. *Etude et Gestion Des Sols* 3, 261–278.
- Chazdon, R.L., 2008. Beyond deforestation: restoring forests and ecosystem services on degraded lands. *Science (New York, N.Y.)* 320, 1458–60. doi:10.1126/science.1155365
- Chodak, M., Niklińska, M., 2010. Effect of texture and tree species on microbial properties of mine soils. *Applied Soil Ecology* 46, 268–275. doi:10.1016/j.apsoil.2010.08.002
- Chodak, M., Pietrzykowski, M., Niklińska, M., 2009. Development of microbial properties in a chronosequence of sandy mine soils. *Applied Soil Ecology* 41, 259–268. doi:10.1016/j.apsoil.2008.11.009
- Choi, S.C., Chase, T., Bartha, R., 1994. Metabolic pathways leading to mercury methylation in *Desulfovibrio desulfuricans* LS. *Applied and Environmental Microbiology*.
- Claff, S.R., Burton, E.D., Sullivan, L.A., Bush, R.T., 2010. Effect of sample pretreatment on the fractionation of Fe, Cr, Ni, Cu, Mn, and Zn in acid sulfate soil materials. *Geoderma* 159, 156–164. doi:10.1016/j.geoderma.2010.07.007
- Clarkson, T.W., 1992. Mercury: Major Issues in Environmental Health. *Environmental Health Perspectives*. doi:10.1289/ehp.9310031
- Clarkson, T.W., Magos, L., 2006. The toxicology of mercury and its chemical compounds. *Critical Reviews in Toxicology*. doi:10.1080/10408440600845619

- Coleman, M.L., Hedrick, D.B., Lovley, D.R., White, D.C., Pye, K., 1993. Reduction of Fe(III) in sediments by sulphate-reducing bacteria. *Nature*. doi:10.1038/361436a0
- Colleran, E., Finnegan, S., Lens, P., 1995. Anaerobic treatment of sulfate-containing waste streams. *Antonie Van Leeuwenhoek International Journal of General and Molecular Microbiology*. doi:10.1007/BF00872194
- Compeau, G.C., Bartha, R., 1985. Sulfate-reducing bacteria: principal methylators of mercury in anoxic estuarine sediment. *Applied and Environmental Microbiology* 50, 498–502.
- Cook, F.J., Orchard, V.A., 2008. Relationships between soil respiration and soil moisture. *Soil Biology and Biochemistry* 40, 1013–1018. doi:10.1016/j.soilbio.2007.12.012
- Cooke, J., Johnson, M., 2002. Ecological restoration of land with particular reference to the mining of metals and industrial minerals: A review of theory and practice. *Environ. Rev* 10, 41–71. doi:10.1139/A01-014
- Cooper, D.C., Picardal, F.F., Coby, A.J., 2006. Interactions between microbial iron reduction and metal geochemistry: Effect of redox cycling on transition metal speciation in iron bearing sediments. *Environmental Science and Technology* 40, 1884–1891. doi:10.1021/es051778t
- Cornell, R.M., Schwertmann, U., 2003. *The iron oxides Vol.*, WILEY-VCH (664 pp.).
- Cornu, S., Clozel, B., 2000. Extractions séquentielles et spéciation des éléments trace métalliques dans les sols naturels : analyse critique. *Etudes et Gestion Des Sols* 7, 179–189.
- Couic, E., Grimaldi, M., Alphonse, V., Balland-Bolou-Bi, C., Livet, A., Giusti-Miller, S., Sarrazin, M., BOUSSERRHINE, N., 2018. Mercury behaviour and C, N, and P biogeochemical cycles during ecological restoration processes of old mining sites in French Guiana. *Environmental Science: Processes & Impacts*. doi:10.1039/C8EM00016F
- Covelo, E.F., Matías, J.M., Vega, F.A., Reigosa, M.J., Andrade, M.L., 2008. A tree regression analysis of factors determining the sorption and retention of heavy metals by soil. *Geoderma* 147, 75–85. doi:10.1016/j.geoderma.2008.08.001
- Covelo, E.F., Vega, F.A., Andrade, M.L., 2007. Competitive sorption and desorption of heavy metals by individual soil components. *Journal of Hazardous Materials* 140, 308–315. doi:10.1016/j.jhazmat.2006.09.018
- Culhane, A.C., Perrière, G., Higgins, D.G., 2003. Cross-platform comparison and visualisation of gene expression data using co-inertia analysis. *BMC Bioinformatics*. doi:10.1186/1471-2105-4-59

D

- Da Silva, E., Nahmani, J., Lapied, E., Alphonse, V., Garnier-Zarli, E., Bousserhine, N., 2016. Toxicity of mercury to the earthworm *Pontoscolex corethrurus* in a tropical soil of French Guiana. *Applied Soil Ecology* 104, 79–84. doi:10.1016/j.apsoil.2015.11.018
- Dale, V.H., Beyeler, S.C., 2001. Challenges in the development and use of ecological indicators. *Ecological Indicators* 1, 3–10. doi:10.1016/S1470-160X(01)00003-6
- Davidson, E.A., Janssens, I.A., 2006. Temperature sensitivity of soil carbon decomposition and feedbacks to climate change. *Nature* 440, 165–173. doi:10.1038/nature04514
- Davis, A., Bloom, N.S., Que Hee, S.S., 1997. The environmental geochemistry and bioaccessibility of mercury in soils and sediments: A review. *Risk Analysis*. doi:10.1111/j.1539-

6924.1997.tb00897.x

- de Faria, S.M., Diedhiou, A.G., de Lima, H.C., Ribeiro, R.D., Galiana, A., Castilho, A.F., Henriques, J.C., 2010. Evaluating the nodulation status of leguminous species from the Amazonian forest of Brazil. *Journal of Experimental Botany* 61, 3119–3127. doi:10.1093/jxb/erq142
- Dear, B.S., Virgona, J.M., Sandral, G.A., Swan, A.D., Morris, S., 2009. Changes in soil mineral nitrogen, nitrogen leached, and surface pH under annual and perennial pasture species. *Crop and Pasture Science* 60, 975–986. doi:10.1071/CP09026
- Do Valle, C.M., Santana, G.P., Augusti, R., Egreja Filho, F.B., Windmüller, C.C., 2005. Speciation and quantification of mercury in Oxisol, Ultisol, and Spodosol from Amazon (Manaus, Brazil). *Chemosphere* 58, 779–792. doi:10.1016/j.chemosphere.2004.09.005
- Do Valle, C.M., Santana, G.P., Augusti, R., Egreja Filho, F.B., Windmüller, C.C., 2005. Speciation and quantification of mercury in Oxisol, Ultisol, and Spodosol from Amazon (Manaus, Brazil). *Chemosphere* 58, 779–792. doi:10.1016/j.chemosphere.2004.09.005
- Dolbec, J., Mergler, D., Sousa Passos, C.J., Sousa De Morais, S., Lebel, J., 2000. Methylmercury exposure affects motor performance of a riverine population of the Tapajos river, Brazilian Amazon. *International Archives of Occupational and Environmental Health*. doi:10.1007/s004200050027
- Dominati, E., Patterson, M., Mackay, A., 2010. A framework for classifying and quantifying the natural capital and ecosystem services of soils. *Ecological Economics* 69, 1858–1868. doi:10.1016/j.ecolecon.2010.05.002
- Doran, J.W., Coleman, D.C., Bezdicsek, D.F., Stewart, B.A., Doran, J.W., Parkin, T.B., 1994. Defining and Assessing Soil Quality. doi:10.2136/sssaspecpub35.c1
- Doran, J.W., Safley, M., Pankhurst, C., Doube, B.M., Gupta, V., 1997. Defining and assessing soil health and sustainable productivity. *Biological Indicators of Soil Health*. 1–28.
- Doran, J.W., Zeiss, M.R., 2000. Soil health and sustainability: managing the biotic component of soil quality. *Applied Soil Ecology*. doi:10.1016/S0929-Get

E

- Edouard Le Floc'H, James Aronson, 1995. *Ecologie de la restauration. Définition de quelques concepts de base*. *Natures, Sciences, Sociétés Hors-série*, 29–35.
- Eivazi, F., Tabatabai, M.A., 1990. Factors affecting glucosidase and galactosidase activities in soils. *Soil Biology and Biochemistry* 22, 891–897. doi:10.1016/0038-0717(90)90126-K
- Ekamawanti, H.A.; W. E., 2018. Short Communication: The role of microbial rhizosphere in enhancing plant growth of *Jatropha curcas* in soil contaminated mercury. doi:10.13057/biodiv/d190243
- Ekino, S., Susa, M., Ninomiya, T., Imamura, K., Kitamura, T., 2007. Minamata disease revisited: An update on the acute and chronic manifestations of methyl mercury poisoning. *Journal of the Neurological Sciences*. doi:10.1016/j.jns.2007.06.036
- Ekstrom, E.B., Morel, F.M.M., Benoit, J.M., 2003. Mercury methylation independent of the acetyl-coenzyme a pathway in sulfate-reducing bacteria. *Applied and Environmental Microbiology*. doi:10.1128/AEM.69.9.5414-5422.2003

Elfstrand, S., Båth, B., Mårtensson, A., 2007. Influence of various forms of green manure amendment on soil microbial community composition, enzyme activity and nutrient levels in leek. *Applied Soil Ecology* 36, 70–82. doi:10.1016/j.apsoil.2006.11.001

F

Fadini, P., Jardim, W., 2001. Is the Negro River Basin (Amazon) impacted by naturally occurring mercury? *Science of The Total Environment* 275, 71–82. doi:10.1016/S0048-9697(00)00855-X

Fardeau J.C., Conesa, A.P. 1994. Le phosphore. Dans: Bonneau et Souchier, *Pedologie vol 2. Constituants et proprietes du sol*. Masson. 557 – 568

Fernández-Martínez, R., Larios, R., Gómez-Pinilla, I., Gómez-Mancebo, B., López-Andrés, S., Loredó, J., Ordóñez, A., Rucandio, I., 2015. Mercury accumulation and speciation in plants and soils from abandoned cinnabar mines. *Geoderma* 253–254, 30–38. doi:10.1016/j.geoderma.2015.04.005

Fierer, N., Strickland, M.S., Liptzin, D., Bradford, M.A., Cleveland, C.C., 2009. Global patterns in belowground communities. *Ecology Letters*. doi:10.1111/j.1461-0248.2009.01360.x

Finžgar, N., Kos, B., Leštan, D., 2006. Bioavailability and mobility of Pb after soil treatment with different remediation methods. *Plant, Soil and Environment*.

Fleming, E.J., Mack, E.E., Green, P.G., Nelson, D.C., Kerin, E.J., Gilmour, C.C., Roden, E.E., Suzuki, M.T., Coates, J.D., Mason, R.P., Steinlin, C., Warner, K.A., Roden, E.E., Bonzongo, J.C., 2006. Mercury methylation from unexpected sources: Molybdate-inhibited freshwater sediments and an iron-reducing bacterium. *Applied and Environmental Microbiology* 72, 2159–2165. doi:10.1128/AEM.01602-06

Foley, J.A., Gibbs, H., Olson, S.H., Asner, G.P., Costa, M.H., Coe, M.T., Defries, R., Gibbs, H.K., Howard, E.A., Olson, S., Patz, J., Ramankutty, N., Snyder, P., 2007. Amazonia revealed : forest degradation and loss of ecosystem goods and services in the Amazon Basin. *Frontiers in Ecology and the Environment* 5, 25–32. doi:jstor.org/stable/20440556

Fontaine, S., Bardoux, G., Abbadie, L., Mariotti, A., 2004. Carbon input to soil may decrease soil carbon content. *Ecology Letters* 7, 314–320. doi:10.1111/j.1461-0248.2004.00579.x

Fontes, M.P.F., Gomes, P.C., 2003. Simultaneous competitive adsorption of heavy metals by the mineral matrix of tropical soils. *Applied Geochemistry* 18, 795–804. doi:10.1016/S0883-2927(02)00188-9

Franco, A.A., De Faria, S.M., 1997. The contribution of N₂-fixing tree legumes to land reclamation and sustainability in the tropics. *Soil Biology and Biochemistry* 29, 897–903. doi:10.1016/S0038-0717(96)00229-5

Franco A. A., Campello E. F., Dias L. E., De Faria S. M., 1994. Revegetation of acidic residues from bauxite mining in Porto Trombetas-PA using nodulated and mycorrhizal legume trees. To be presented at 1st Latin American symposium on soil reclamation, Foz de Iguaçu, Brasil, 8 p

Fréry, N., Maury-Brachet, R., Maillot, E., Deheeger, M., De Mérona, B., Boudou, A., 2001. Gold-mining activities and mercury contamination of native Amerindian communities in French Guiana: Key role of fish in dietary uptake. *Environmental Health Perspectives*. doi:10.1289/ehp.01109449

Fritsch, E., Herbillon, A.J., Do Nascimento, N.R., Grimaldi, M., Melfi, A.J., 2007. From Plinthic Acrisols to Plinthosols and Gleysols: Iron and groundwater dynamics in the tertiary sediments of the

upper Amazon basin. *European Journal of Soil Science* 58, 989–1006. doi:10.1111/j.1365-2389.2006.00877.x

Frouz, J., Kalčík, J., Velichová, V., 2011. Factors causing spatial heterogeneity in soil properties, plant cover, and soil fauna in a non-reclaimed post-mining site. *Ecological Engineering* 37, 1910–1913. doi:10.1016/j.ecoleng.2011.06.039

G

Gabriel, M.C., Williamson, D.G., 2004. Principal biogeochemical factors affecting the speciation and transport of mercury through the terrestrial environment. *Environmental Geochemistry and Health*. doi:10.1007/s10653-004-1308-0

García-Sánchez, A., Murciego, A., Álvarez-Ayuso, E., Regina, I.S., Rodríguez-González, M.A., 2009. Mercury in soils and plants in an abandoned cinnabar mining area (SW Spain). *Journal of Hazardous Materials* 168, 1319–1324. doi:10.1016/j.jhazmat.2009.03.009

Gårdfeldt, K., Munthe, J., Strömberg, D., Lindqvist, O., 2003. A kinetic study on the abiotic methylation of divalent mercury in the aqueous phase, in: *Science of the Total Environment*. doi:10.1016/S0048-9697(02)00562-4

Gavilán-García, I., Santos-Santos, E., Tovar-Gálvez, L.R., Gavilán-García, A., Suárez, S., Olmos, J., La, B., Ticomán, L., Delegación, G.A., Madero, M.D.F., 2008. Mercury Speciation in Contaminated Soils from Old Mining Activities in Mexico Using a Chemical Selective Extraction Article, *Chem. Soc.*

Ghazoul, J., Burivalova, Z., Garcia-Ulloa, J., King, L.A., 2015. Conceptualizing Forest Degradation. *Trends in Ecology and Evolution* 30, 622–632. doi:10.1016/j.tree.2015.08.001

Giacometti, C., Demyan, M.S., Cavani, L., Marzadori, C., Ciavatta, C., Kandeler, E., 2013. Chemical and microbiological soil quality indicators and their potential to differentiate fertilization regimes in temperate agroecosystems. *Applied Soil Ecology* 64, 32–48. doi:10.1016/j.apsoil.2012.10.002

Giai, C., Boerner, R.E.J., 2007. Effects of ecological restoration on microbial activity, microbial functional diversity, and soil organic matter in mixed-oak forests of southern Ohio, USA. *Applied Soil Ecology* 35, 281–290. doi:10.1016/j.apsoil.2006.08.003

Gilmour, C.C., Henry, E.A., Mitchell, R., 1992. Sulfate stimulation of mercury methylation in freshwater sediments. *Environmental Science & Technology* 26, 2281–2287. doi:10.1021/es00035a029

Gjerde, D.T., Wiederin, D.R., Smith, F.G., Mattson, B.M., 1993. Metal speciation by means of microbore columns with direct-injection nebulization by inductively coupled plasma atomic emission spectroscopy. *Journal of Chromatography A* 640, 73–78. doi:10.1016/0021-9673(93)80170-D

Gobat, J.-M., Aragno, M., Matthey, W., 2003. *Le Sol Vivant*. PPUR, Suisse. 571 p.

Goldberg, S., 2002. Competitive Adsorption of Arsenate and Arsenite on Oxides and Clay Minerals. *Soil Science Society of America Journal* 66, 413. doi:10.2136/sssaj2002.4130

Gomes, P.C., Fontes, M.P.F., da Silva, A.G., de S. Mendonça, E., Netto, A.R., 2001. Selectivity Sequence and Competitive Adsorption of Heavy Metals by Brazilian Soils. *Soil Science Society of America Journal* 65, 1115. doi:10.2136/sssaj2001.6541115x

Gonçalves, C., Fávoro, D.I.T., De Oliveira, S.M.B., Boulet, R., Vasconcellos, M.B.A., Saiki, M., 1998. Preliminary study on mercury distribution in soil profiles from Serra do Navio, Amapá, using

- radiochemical neutron activation analysis. *Journal of Radioanalytical and Nuclear Chemistry*. doi:10.1007/BF02385973
- Gong, X., Liu, Y., Li, Q., Wei, X., Guo, X., Niu, D., Zhang, W., Zhang, J., Zhang, L., 2013. Sub-tropic degraded red soil restoration: Is soil organic carbon build-up limited by nutrients supply. *Forest Ecology and Management* 300, 77–87. doi:10.1016/j.foreco.2012.12.002
- Gotoh, S., Patrick, W., 1972. Transformation of Manganese in a Waterlogged Soil As Affected By Redox Potential and Ph. *Soil Science Society of America Proceedings* 36, 738-. doi:10.2136/sssaj1972.03615995003600050018x
- Gounou, C., Bousserhine, N., Varrault, G., Mouchel, J.M., 2010. Influence of the iron-reducing bacteria on the release of heavy metals in anaerobic river sediment. *Water, Air, and Soil Pollution* 212, 123–129. doi:10.1007/s11270-010-0327-y
- Grace, J., 2004. Understanding and managing the global carbon cycle. *Journal of Ecology*. doi:DOI 10.1111/j.0022-0477.2004.00874.x
- Grandjean, P., White, R.F., Nielsen, A., Cleary, D., De Oliveira Santos, E.C., 1999. Methylmercury neurotoxicity in Amazonian children downstream from gold mining. *Environmental Health Perspectives*. doi:10.1289/ehp.99107587
- Gray, S.B., Classen, A.T., Kardol, P., Yermakov, Z., Michael Mille, R., 2011. Multiple Climate Change Factors Interact to Alter Soil Microbial Community Structure in an Old-Field Ecosystem. *Soil Science Society of America Journal* 75, 2217. doi:10.2136/sssaj2011.0135
- Grimaldi, C., Grimaldi, M., Guedron, S., 2008. Mercury distribution in tropical soil profiles related to origin of mercury and soil processes. *Science of the Total Environment* 401, 121–129. doi:10.1016/j.scitotenv.2008.04.001
- Grimaldi, M., Grimaldi, C., 2001. Sources, stocks et transferts dans les sols et sédiments. Programme de recherche. Le Mercure en Guyane Française. Rapport final, partie I: la région de St Elie et le réservoir de Petit Saut.
- Grimaldi, M., Oszwald, J., Dolédec, S., Hurtado, M. del P., de Souza Miranda, I., Arnauld de Sartre, X., Assis, W.S. de, Castañeda, E., Desjardins, T., Dubs, F., Guevara, E., Gond, V., Lima, T.T.S., Marichal, R., Michelotti, F., Mitja, D., Noronha, N.C., Delgado Oliveira, M.N., Ramirez, B., Rodriguez, G., Sarrazin, M., Silva, M.L. da, Costa, L.G.S., Souza, S.L. de, Veiga, I., Velasquez, E., Lavelle, P., 2014. Ecosystem services of regulation and support in Amazonian pioneer fronts: searching for landscape drivers. *Landscape Ecology* 29, 311–328. doi:10.1007/s10980-013-9981-y
- Gros, R., 2002. Fonctionnement et qualité des sols soumis à des perturbations d'origines anthropiques : réponses du sol, de la flore et de la microflore bactérienne. Thèse ADEME Université de Savoie, 242p.
- Guedron, S., 2008. Impact de l'exploitation minière en Guyane française sur les flux de mercure vers les écosystèmes aquatiques. Grenoble, Université Joseph Fourier – Grenoble I.
- Guedron, S., Grangeon, S., Lanson, B., Grimaldi, M., 2009. Mercury speciation in a tropical soil association; Consequence of gold mining on Hg distribution in French Guiana. *Geoderma* 153, 331–346. doi:10.1016/j.geoderma.2009.08.017
- Guedron, S., Grimaldi, C., Chauvel, C., Spadini, L., Grimaldi, M., 2006. Weathering versus atmospheric contributions to mercury concentrations in French Guiana soils. *Applied Geochemistry* 21, 2010–2022. doi:10.1016/j.apgeochem.2006.08.011

Guédron, S., Grimaldi, C., Chauvel, C., Spadini, L., Grimaldi, M., 2006. Weathering versus atmospheric contributions to mercury concentrations in French Guiana soils. *Applied Geochemistry* 21, 2010–2022.

H

Han, Y., Kingston, H.M., Boylan, H.M., Rahman, G.M.M., Shah, S., Richter, R.C., Link, D.D., Bhandari, S., 2003. Speciation of mercury in soil and sediment by selective solvent and acid extraction. *Analytical and Bioanalytical Chemistry* 375, 428–436. doi:10.1007/s00216-002-1701-4

Hao, O.J., Chen, J.M., Huang, L., Buglass, R.L., 1996. Sulfate-reducing bacteria. *Critical Reviews in Environmental Science and Technology*. doi:10.1080/10643389609388489

Harris-Hellal, J., 2008. Etude des interactions entre sols – mercure – composante microbiologique en Guyane française. Université Paris Est.

Harris-Hellal, J., Grimaldi, M., Garnier-Zarli, E., Bousserhine, N., 2011. Mercury mobilization by chemical and microbial iron oxide reduction in soils of French Guyana. *Biogeochemistry* 103, 223–234. doi:10.1007/s10533-010-9457-y

Harris-Hellal, J., Vallaey, T., Garnier-Zarli, E., Bousserhine, N., 2009. Effects of mercury on soil microbial communities in tropical soils of French Guyana. *Applied Soil Ecology* 41, 59–68. doi:10.1016/j.apsoil.2008.08.009

He, Z.L., Yang, X.E., Baligar, V.C., Calvert, D. V., 2003. Microbiological and Biochemical Indexing Systems for Assessing Quality of Acid Soils. *Advances in Agronomy*. doi:10.1016/S0065-2113(02)78003-6

Heděnc, P., Vinduřková, O., Kukla, J., Šnajdr, J., Baldrian, P., Frouz, J., 2017. Enzyme activity of topsoil layer on reclaimed and unreclaimed post-mining sites. doi:10.21638/11701/spbu03.2017.103

Hobbs, R.J., Harris, J.A., 2001. Restoration ecology: Repairing the earth's ecosystems in the new millennium. *Restoration Ecology* 9, 239–246. doi:10.1046/j.1526-100X.2001.009002239.x

Holmer, M., Storkholm, P., 2001. Sulphate reduction and sulphur cycling in lake sediments: A review. *Freshwater Biology*. doi:10.1046/j.1365-2427.2001.00687.x

Hou, H., Wang, C., Ding, Z., Zhang, S., Yang, Y., Ma, J., Chen, F., Li, J., 2018. Variation in the soil microbial community of reclaimed land over different reclamation periods. *Sustainability (Switzerland)*. doi:10.3390/su10072286

Hseu, Z.Y., 2006. Extractability and bioavailability of zinc over time in three tropical soils incubated with biosolids. *Chemosphere* 63, 762–771. doi:10.1016/j.chemosphere.2005.08.014

Hsu, C.L., Wang, S.L., Tzou, Y.M., 2007. Photocatalytic reduction of Cr(VI) in the presence of NO₃⁻ and Cl⁻ electrolytes as influenced by Fe(III). *Environmental Science and Technology* 41, 7907–7914. doi:10.1021/es0718164

Hu, X.F., Jiang, Y., Shu, Y., Hu, X., Liu, L., Luo, F., 2014. Effects of mining wastewater discharges on heavy metal pollution and soil enzyme activity of the paddy fields. *Journal of Geochemical Exploration* 147, 139–150. doi:10.1016/j.gexplo.2014.08.001

Hu, Y.F., Peng, J.J., Yuan, S., Shu, X.Y., Jiang, S.L., Pu, Q., Ma, K.Y., Yuan, C.M., Chen, G.D., Xiao, H.H.,

2016. Influence of ecological restoration on vegetation and soil microbiological properties in Alpine-cold semi-humid desertified land. *Ecological Engineering* 94, 88–94. doi:10.1016/j.ecoleng.2016.05.061
- Huang, Q., Liang, W., Cai, P., 2005. Adsorption, desorption and activities of acid phosphatase on various colloidal particles from an Ultisol. *Colloids and Surfaces B: Biointerfaces*. doi:10.1016/j.colsurfb.2005.08.011
- Hui, D., Luo, Y., 2004. Evaluation of soil CO₂ production and transport in Duke Forest using a process-based modeling approach. *Global Biogeochemical Cycles* 18, 1–10. doi:10.1029/2004GB002297
- Hulugalle, N.R., 1992. Amelioration of a highly degraded tropical alfisol by planting I. Changes in soil physical and chemical properties 1989-91. *Land Degradation & Development* 3, 141–152. doi:10.1002/ldr.3400030302
- Hutton, E.M., 1983. Selection and breeding of *Leucaena* for very acid soils. *Leucaena Research in the Asian-Pacific Region*.

I

- Iedom, 2017. Guyane - Rapport annuel 2017.
- Islam, F.S., Gault, A.G., Boothman, C., Polya, D.A., Charnock, J.M., Chatterjee, D., Lloyd, J.R., 2004. Role of metal-reducing bacteria in arsenic release from Bengal delta sediments. *Nature* 430, 68–71. doi:10.1038/nature02638

J

- Jackson, M.L., Barak, P., 2005. *Soil chemical analysis : advanced course : a manual of methods useful for instruction and research in soil chemistry, physical chemistry of soils, soil fertility, and soil genesis*. Parallel Press, University of Wisconsin-Madison Libraries.
- Jaffré, T., McCoy, S., Rigault, F., Dagostini, G., 1997. Quelle méthode de végétalisation pour la réhabilitation des anciens sites miniers de Nouvelle-Calédonie. *Ecologie Des Milieux Sur Roches Ultramaïfiques et Sur Sols Métallifères : Actes de La Deuxième Conférence Internationale Sur l'écologie Des Milieux Serpentiniques*. 285–288.
- Jager, M.M., Richardson, S.J., Bellingham, P.J., Clearwater, M.J., Laughlin, D.C., 2015. Soil fertility induces coordinated responses of multiple independent functional traits. *Journal of Ecology* 103, 374–385. doi:10.1111/1365-2745.12366
- Jaquetti, R., Gonçalves, J., Ferraz, J., Ferreira, M., Santos Junior, U., 2016. Ecofunctional Traits and Biomass Production in Leguminous Tree Species under Fertilization Treatments during Forest Restoration in Amazonia. *Forests* 7, 76. doi:10.3390/f7040076
- Jia, X. hong, Li, Y. shou, Wu, B., Zhou, Y. yan, Li, X. rong, 2017. Effects of plant restoration on soil microbial biomass in an arid desert in northern China. *Journal of Arid Environments* 144, 192–200. doi:10.1016/j.jaridenv.2017.04.014
- Jiang, M., 2002. Water stress-induced abscisic acid accumulation triggers the increased generation of reactive oxygen species and up-regulates the activities of antioxidant enzymes in maize leaves. *Journal of Experimental Botany* 53, 2401–2410. doi:10.1093/jxb/erf090
- Johnston, S.G., Burton, E.D., Keene, A.F., Planer-Friedrich, B., Voegelin, A., Blackford, M.G., Lumpkin,

G.R., 2012. Arsenic mobilization and iron transformations during sulfidization of As(V)-bearing jarosite. *Chemical Geology* 334, 9–24. doi:10.1016/j.chemgeo.2012.09.045

Jordan, D., Kremer, R.J., Bergfield, W.A., Kim, K.Y., Cacio, V.N., 1995. Evaluation of microbial methods as potential indicators of soil quality in historical agricultural fields. *Biology and Fertility of Soils* 19, 297–302. doi:10.1007/BF00336098

K

Kandeler, E., Gerber, H., 1988. Short-term assay of soil urease activity using colorimetric determination of ammonium. *Biology and Fertility of Soils* 6, 68–72. doi:10.1007/BF00257924

Kandeler, F., Kampichler, C., Horak, O., 1996. Influence of heavy metals on the functional diversity of soil microbial communities. *Biology and Fertility of Soils* 23, 299–306. doi:10.1007/BF00335958

Kang, H., Freeman, C., 2007. Interactions of Marsh Orchid (*Dactylorhiza* spp.) and Soil Microorganisms in Relation to Extracellular Enzyme Activities in a Peat Soil. *Pedosphere* 17, 681–687. doi:10.1016/S1002-0160(07)60082-4

Kanowski, J., Cattarell, C.P., Freebody, K., Freeman, a. N.D., Harrison, D. a., 2010. Monitoring revegetation projects in rainforest landscapes. Toolkit version 3.

Karlen, D., Andrews, S., Wienhold, B.J., Zobeck, T., 2008. Soil Quality Assessment: Past, Present and Future. *Electronic Journal of Integrative Biosciences* 6, 3–14.

Karlen, D.L., Mausbach, M.J., Doran, J.W., Cline, R.G., Harris, R.F., Schuman, G.E., 1997. Soil Quality: A Concept, Definition, and Framework for Evaluation (A Guest Editorial). *Soil Science Society of America Journal* 61, 4. doi:10.2136/sssaj1997.03615995006100010001x

Kaur, B., Gupta, S.R., Singh, G., 2002. Carbon storage and nitrogen cycling in silvopastoral systems on a sodic soil in northwestern India. *Agroforestry Systems* 54, 21–29. doi:10.1023/A:1014269221934

Keenan, R.J., Reams, G.A., Achard, F., de Freitas, J. V., Grainger, A., Lindquist, E., 2015a. Dynamics of global forest area: Results from the FAO Global Forest Resources Assessment 2015. *Forest Ecology and Management*. doi:10.1016/j.foreco.2015.06.014

Keenan, R.J., Reams, G.A., Achard, F., de Freitas, J. V., Grainger, A., Lindquist, E., 2015b. Dynamics of global forest area: Results from the FAO Global Forest Resources Assessment 2015. *Forest Ecology and Management* 352, 9–20. doi:10.1016/j.foreco.2015.06.014

Kelly, J.J., Häggblom, M., Tate, R.L., 1999. Changes in soil microbial communities over time resulting from one time application of zinc: A laboratory microcosm study. *Soil Biology and Biochemistry*. doi:10.1016/S0038-0717(99)00059-0

Khan, S., Cao, Q., Hesham, A.E.L., Xia, Y., He, J. zheng, 2007. Soil enzymatic activities and microbial community structure with different application rates of Cd and Pb. *Journal of Environmental Sciences* 19, 834–840. doi:10.1016/S1001-0742(07)60139-9

Khwaja, A.R., Bloom, P.R., Brezonik, P.L., 2006. Binding constants of divalent mercury (Hg²⁺) in soil humic acids and soil organic matter. *Environmental Science & Technology* 40, 844–9.

Kim, D.J., Lee, D.I., Keller, J., 2006. Effect of temperature and free ammonia on nitrification and nitrite accumulation in landfill leachate and analysis of its nitrifying bacterial community by FISH. *Bioresource Technology* 97, 459–468. doi:10.1016/j.biortech.2005.03.032

- Kim, S.Y., Lee, S.H., Freeman, C., Fenner, N., Kang, H., 2008. Comparative analysis of soil microbial communities and their responses to the short-term drought in bog, fen, and riparian wetlands. *Soil Biology and Biochemistry* 40, 2874–2880. doi:10.1016/j.soilbio.2008.08.004
- King, J.K., Harmon, S.M., Fu, T.T., Gladden, J.B., 2002. Mercury removal, methylmercury formation, and sulfate-reducing bacteria profiles in wetland mesocosms. *Chemosphere* 46, 859–870. doi:10.1016/S0045-6535(01)00135-7
- King, J.K., Kostka, J.E., Frischer, M.E., Saunders, F.M., 2000. Sulfate-reducing bacteria methylate mercury at variable rates in pure culture and in marine sediments. *Applied and Environmental Microbiology*. doi:10.1128/AEM.66.6.2430-2437.2000
- Klein, D.A., Loh, T.C., Goulding, R.L., 1971. A rapid procedure to evaluate the dehydrogenase activity of soils low in organic matter. *Soil Biology and Biochemistry* 3, 385–387. doi:10.1016/0038-0717(71)90049-6
- Knoepp, J.D., Coleman, D.C., Crossley, D.A., Clark, J.S., 2000. Biological indices of soil quality: An ecosystem case study of their use. *Forest Ecology and Management* 138, 357–368. doi:10.1016/S0378-1127(00)00424-2
- Koschorreck, M., 2008. Microbial sulphate reduction at a low pH. *FEMS Microbiology Ecology*. doi:10.1111/j.1574-6941.2008.00482.x
- Kudeyarov, V.N., Jenkinson, D.S., 1976. The effects of biocidal treatments on metabolism in soil-VI. Fumigation with carbon disulphide. *Soil Biology and Biochemistry*. doi:10.1016/0038-0717(76)90036-5
- Kumar, S., Chaudhuri, S., Maiti, S.K., 2013. Soil Dehydrogenase Enzyme Activity in Natural and Mine Soil -A Review. *Middle-East Journal of Scientific Research* 13, 898–906. doi:10.5829/idosi.mejsr.2013.13.7.2801
- Kuperman, R.G., Carreiro, M.M., 1997. Soil heavy metal concentrations, microbial biomass and enzyme activities in a contaminated grassland ecosystem. *Soil Biology and Biochemistry* 29, 179–190. doi:10.1016/S0038-0717(96)00297-0

L

- Lacerda, L. de, 2002. Updating global Hg emissions from small-scale gold mining and assessing its environmental impacts. *Environmental Geology* 43, 308–314. doi:10.1007/s00254-002-0627-7
- Lacerda, L.D., De Souza, M., Ribeiro, M.G., 2004. The effects of land use change on mercury distribution in soils of Alta Floresta, Southern Amazon. *Environmental Pollution* 129, 247–255. doi:10.1016/j.envpol.2003.10.013
- Lamb, D., Lawrence, P., 1993. Mixed species plantations using high value rainforest trees in Australia. *Restoration of Tropical Forest Ecosystems* 30, 101–108. doi:10.1007/978-94-017-2896-6_9
- Landesman, W.J., Dighton, J., 2010. Response of soil microbial communities and the production of plant-available nitrogen to a two-year rainfall manipulation in the New Jersey Pinelands. *Soil Biology and Biochemistry* 42, 1751–1758. doi:10.1016/j.soilbio.2010.06.012
- Laurance, W.F., Albernaz, A.K.M., Fearnside, P.M., Vasconcelos, H.L., Ferreira, L. V., 2004. Deforestation in Amazonia. *Science (New York, N.Y.)* 304, 1109–11. doi:10.1126/science.304.5674.1109b
- Laurent Charlet, Alain Boudou, 2002. Cet OR qui file un mauvais mercure | larecherche.fr. La

- Recherche, Rubrique "Savoirs" 359, 52–59.
- Le Roux, C., 2002. La réhabilitation des mines et carrières à ciel ouvert : Restauration des sites miniers. *Bois et Forêts Des Tropiques* 272, 5–19.
- Ledin, M., 2000. Accumulation of metals by microorganisms - processes and importance for soil systems. *Earth Science Reviews* 51, 1–31. doi:10.1016/S0012-8252(00)00008-8
- Leermakers, M., Baeyens, W., Quevauviller, P., Horvat, M., 2005. Mercury in environmental samples: Speciation, artifacts and validation. *TrAC - Trends in Analytical Chemistry*. doi:10.1016/j.trac.2004.01.001
- Lewis, A.E., 2010. Review of metal sulphide precipitation. *Hydrometallurgy* 104, 222–234. doi:10.1016/J.HYDROMET.2010.06.010
- Lewis, S.L., Lloyd, J., Sitch, S., Mitchard, E.T.A., Laurance, W.F., 2009. Changing Ecology of Tropical Forests: Evidence and Drivers. *Annual Review of Ecology, Evolution, and Systematics* 40, 529–549. doi:10.1146/annurev.ecolsys.39.110707.173345
- Li, H., Zhang, F., Rengel, Z., Shen, J., 2013. Rhizosphere properties in monocropping and intercropping systems between faba bean (*Vicia faba* L.) and maize (*Zea mays* L.) grown in a calcareous soil. *Crop and Pasture Science* 64, 976–984. doi:10.1071/CP13268
- Li, J., Zhou, X., Yan, J., Li, H., He, J., 2015. Effects of regenerating vegetation on soil enzyme activity and microbial structure in reclaimed soils on a surface coal mine site. *Applied Soil Ecology*. doi:10.1016/j.apsoil.2014.11.010
- Lin, Y., Larssen, T., Vogt, R.D., Feng, X., 2010. Identification of fractions of mercury in water, soil and sediment from a typical Hg mining area in Wanshan, Guizhou province, China. *Applied Geochemistry*. doi:10.1016/j.apgeochem.2009.10.001
- Liu, T., Liu, H., Hu, Y., Zhou, L., Zheng, B., 2009. Growth characteristics of thermophile sulfate-reducing bacteria and its effect on carbon steel. *Materials and Corrosion* 60, 218–224. doi:10.1002/maco.200805063
- Logsdon, S.D., Karlen, D.L., 2004. Bulk density as a soil quality indicator during conversion to no-tillage. *Soil and Tillage Research* 78, 143–149. doi:10.1016/j.still.2004.02.003
- Lombardi, A.T., Garcia, O., 2002. Biological leaching of Mn, Al, Zn, Cu and Ti in an anaerobic sewage sludge effectuated by *Thiobacillus ferrooxidans* and its effect on metal partitioning. *Water Research* 36, 3193–3202. doi:10.1016/S0043-1354(02)00008-8
- Loubry, D., 2002. Livret technique pour la conduite de la revégétalisation sur les surfaces minières alluvionnaires de Guyane [WWW Document]. IRD. URL <http://www.documentation.ird.fr/hor/fdi:010029513> (accessed 9.22.17).
- Lovley, D.R., 1993. Dissimilatory Metal Reduction. *Annual Review of Microbiology* 47, 263–290. doi:10.1146/annurev.mi.47.100193.001403
- Lovley, D.R., 1991. Dissimilatory Fe(III) and Mn(IV) reduction. *Microbiological Reviews* 55, 259–87.
- Lovley, D.R., 1987. Organic matter mineralization with the reduction of ferric iron: A review. *Geomicrobiology Journal*. doi:10.1080/01490458709385975
- Lugo A. E., 1997. The apparent paradox if reestablishing species richness on degraded lands with tree monocultures. *Forestry Ecology and Management*, 99: 9-19.
- Luo, Y., Wan, S., Hui, D., Wallace, L.L., 2001. Acclimatization of soil respiration to warming in a tall

grass prairie. *Nature* 413, 622–625. doi:10.1038/35098065

M

- Ma, Z., Zhang, M., Xiao, R., Cui, Y., Yu, F., 2017. Changes in soil microbial biomass and community composition in coastal wetlands affected by restoration projects in a Chinese delta. *Geoderma* 289, 124–134. doi:10.1016/j.geoderma.2016.11.037
- Malhi, Y., Grace, J., 2000. Tropical forests and atmospheric carbon dioxide. *Trends in Ecology & Evolution*. doi:10.1016/S0169-5347(00)01906-6
- Manzoni, S., Trofymow, J.A., Jackson, R.B., Porporato, A., 2010. Stoichiometric controls on carbon, nitrogen, and phosphorus dynamics in decomposing litter. *Ecological Monographs*. doi:10.1890/09-0179.1
- Maron, P.A., Cœur, C., Pink, C., Clays-Josserand, A., Lensi, R., Richaume, A., Potier, P., 2003. Use of polyclonal antibodies to detect and quantify the NOR protein of nitrite oxidizers in complex environments. *Journal of Microbiological Methods*. doi:10.1016/S0167-7012(02)00231-2
- Martin, S., 2005. Precipitation and Dissolution of Iron and Manganese Oxides, in: *Environmental Catalysis*. CRC Press, pp. 61–82. doi:10.1201/9781420027679.ch3
- Martínez-Garza, C., Howe, H.F., 2003. Restoring tropical diversity: Beating the time tax on species loss. *Journal of Applied Ecology* 40, 423–429. doi:10.1046/j.1365-2664.2003.00819.x
- Mason, R., Fitzgerald, W., Morel, F., 1994. The biogeochemical cycling of elemental mercury: Anthropogenic influences. *Geochimica et Cosmochimica Acta*. doi:10.1016/0016-7037(94)90046-9
- Mathieu, C., Pielain, F., 2003. *Analyse chimique des sols : Methodes choisies*. Lavoisier Ed. Paris. 386
- Melero, S., Madejón, E., Ruiz, J.C., Herencia, J.F., 2007. Chemical and biochemical properties of a clay soil under dryland agriculture system as affected by organic fertilization. *European Journal of Agronomy* 26, 327–334. doi:10.1016/j.eja.2006.11.004
- Miao, R., Jiang, D., Musa, A., Zhou, Q., Guo, M., Wang, Y., 2015. Effectiveness of shrub planting and grazing exclusion on degraded sandy grassland restoration in Horqin sandy land in Inner Mongolia. *Ecological Engineering* 74, 164–173. doi:10.1016/j.ecoleng.2014.10.004
- Millhollen, A.G., Gustin, M.S., Obrist, D., 2006. Foliar mercury accumulation and exchange for three tree species. *Environmental Science and Technology*. doi:10.1021/es0609194
- Moiroud A., Capellano A., Danière C., 1991. Un procédé exemplaire de réaménagement et de reverdissement des carrières : l'emploi des espèces fixatrices d'azote atmosphérique. Rapport final. Taxe parafiscale sur les granulats : opération n° 60 EG 161/Laboratoire d'écologie microbienne de l'université Claude-Bernard, 34 p.
- Montabo, B., 2004. Le grand livre de l'histoire de la Guyane: Des origines à 1848.
- Mora, P., Miambi, E., Jiménez, J.J., Decaëns, T., Rouland, C., 2005. Functional complement of biogenic structures produced by earthworms, termites and ants in the neotropical savannas. *Soil Biology and Biochemistry* 37, 1043–1048. doi:10.1016/j.soilbio.2004.10.019
- Moreno-Jiménez, E., Gamarra, R., Carpena-Ruiz, R.O., Millán, R., Peñalosa, J.M., Esteban, E., 2006. Mercury bioaccumulation and phytotoxicity in two wild plant species of Almadén area. *Chemosphere*. doi:10.1016/j.chemosphere.2005.09.043

Mortensen, J.L. and Himes, F.I. 1964. In : F.E. Bear (Editor), *Chemistry of the Soil*. Reynolds, New York, N.Y., 2nd ed., pp. 206-241.

Murphy, J., Riley, J.P., 1962. A modified single solution method for the determination of phosphate in natural waters. *Analytica Chimica Acta* 27, 31–36. doi:10.1016/S0003-2670(00)88444-5

Myers, R.J.K., 1975. Temperature effects on ammonification and nitrification in a tropical soil. *Soil Biology and Biochemistry* 7, 83–86. doi:10.1016/0038-0717(75)90003-6

N

Nakas, J.P., Klein, D. a, 1979. Decomposition of microbial cell components in a semi-arid grassland soil. *Applied and Environmental Microbiology* 38, 454–460.

Nannipieri, P., Ascher, J., Ceccherini, M.T., Landi, L., Pietramellara, G., Renella, G., 2003. Microbial diversity and soil functions. *European Journal of Soil Science*. doi:10.1046/j.1351-0754.2003.0556.x

Nannipieri, P., Kandeler, E., Ruggiero, P., 2002. Enzyme Activities and Microbiological and Biochemical Processes in Soil, in: *Enzymes in the Environment: Activity, Ecology, and Applications*. doi:10.1201/9780203904039.ch1

Navarro, A., 2008. Review of characteristics of mercury speciation and mobility from areas of mercury mining in semi-arid environments. *Reviews in Environmental Science and Biotechnology* 7, 287–306. doi:10.1007/s11157-008-9139-6

Neculita, C.-M., Zagury, G.J., Deschênes, L.,. Mercury speciation in highly contaminated soils from chlor-alkali plants using chemical extractions. *Journal of Environmental Quality* 34, 255–62.

Niemeyer, J.C., Lolata, G.B., Carvalho, G.M. de, Da Silva, E.M., Sousa, J.P., Nogueira, M.A., 2012. Microbial indicators of soil health as tools for ecological risk assessment of a metal contaminated site in Brazil. *Applied Soil Ecology*. doi:10.1016/j.apsoil.2012.03.019

Norisada, M., Hitsuma, G., Kuroda, K., Yamanoshita, T., Masumori, M., Tange, T., Yagi, H., Nuyim, T., Sasaki, S., Kojima, K., 2005. *Acacia mangium*, a nurse tree candidate for reforestation on degraded sandy soils in the Malay Peninsula. *Forest Science* 51, 498–510.

Nortcliff, S., 2002. Standardisation of soil quality attributes, in: *Agriculture, Ecosystems and Environment*. Elsevier, pp. 161–168. doi:10.1016/S0167-8809(01)00253-5

Noubactep, C., Schöner, A., Dienemann, H., Sauter, M., 2005. Release of coprecipitated uranium from iron oxides. *Journal of Radioanalytical and Nuclear Chemistry* 267, 21–27. doi:10.1007/s10967-006-0004-1

Nriagu, J.O., 1994. Mercury pollution from the past mining of gold and silver in the Americas. *Science of the Total Environment* 149, 167–181. doi:10.1016/0048-9697(94)90177-5

O

O'Day, P.A., Vlassopoulos, D., Root, R., Rivera, N., 2004. The influence of sulfur and iron on dissolved arsenic concentrations in the shallow subsurface under changing redox conditions. *Proceedings of the National Academy of Sciences* 101, 13703–13708. doi:10.1073/pnas.0402775101

Ölinger, R., Margesin, R., Kandeler, E., 1996. Enzymes Involved in Phosphorus Metabolism, in:

Schinner, F., Öhlinger, R., Kandeler, E., Margesin, R. (Eds.), *Methods in Soil Biology*. Springer Berlin Heidelberg, Berlin, Heidelberg, pp. 208–227. doi:10.1007/978-3-642-60966-4_13

P

Parton, W., Silver, W.L., Burke, I.C., Grassens, L., Harmon, M.E., Currie, W.S., King, J.Y., Adair, E.C., Brandt, L.A., Hart, S.C., Fasth, B., 2007. Global-Scale Similarities in Nitrogen Release Patterns During Long-Term Decomposition. *Science* 315, 361–364. doi:10.1126/science.1134853

Poulain, A.J., Ní Chadhain, S.M., Ariya, P.A., Amyot, M., Garcia, E., Campbell, P.G.C., Zylstra, G.J., Barkay, T., 2007. Potential for mercury reduction by microbes in the high Arctic. *Applied and Environmental Microbiology*. doi:10.1128/AEM.02701-06

G

Qian, J., Skjellberg, U., Frech, W., Bleam, W.F., Bloom, P.R., Petit, P.E., 2002. Bonding of methyl mercury to reduced sulfur groups in soil and stream organic matter as determined by X-ray absorption spectroscopy and binding affinity studies. *Geochimica et Cosmochimica Acta* 66, 3873–3885. doi:10.1016/S0016-7037(02)00974-2

R

Raich, J.W., Schlesinger, W.H., 1992. The global carbon dioxide flux in soil respiration and its relationship to vegetation and climate. *Tellus B* 44, 81–99. doi:10.1034/j.1600-0889.1992.t01-1-00001.x

Rao, C.R.M., Sahuquillo, A., Lopez Sanchez, J.F., 2008. A Review of the Different Methods Applied in Environmental Geochemistry For Single and Sequential Extraction of Trace Elements in Soils and Related Materials. *Water, Air, and Soil Pollution* 189, 291–333. doi:10.1007/s11270-007-9564-0

Rasmussen, L.D., Sørensen, S.J., 2001. Effects of mercury contamination on the culturable heterotrophic, functional and genetic diversity of the bacterial community in soil. *FEMS Microbiology Ecology* 36, 1–9.

Rasmussen, L.D., Sørensen, S.J., Turner, R.R., Barkay, T., 2000. Application of a mer-lux biosensor for estimating bioavailable mercury in soil. *Soil Biology and Biochemistry* 32, 639–646. doi:10.1016/S0038-0717(99)00190-X

Reich, P.B., Grigal, D.F., Aber, J.D., Gower, S.T., 1997. Nitrogen mineralization and productivity in 50 hardwood and conifer stands on diverse soils. *Ecology*. doi:10.1890/0012-9658(1997)078[0335:NMAPIH]2.0.CO;2

Reich, P.B., Peterson, D.W., Wedin, D.A., Wrage, K., 2001. Fire and vegetation effects on productivity and nitrogen cycling across a forest-grassland continuum. *Ecology*. doi:10.1890/0012-9658(2001)082[1703:FAVEOP]2.0.CO;2

Reis, A.T., Coelho, J.P., Rucandio, I., Davidson, C.M., Duarte, A.C., Pereira, E., 2015. Thermo-desorption: A valid tool for mercury speciation in soils and sediments? *Geoderma* 237, 98–104. doi:10.1016/j.geoderma.2014.08.019

Reis, A.T., Davidson, C.M., Vale, C., Pereira, E., 2016. Overview and challenges of mercury

fractionation and speciation in soils. TrAC - Trends in Analytical Chemistry. doi:10.1016/j.trac.2016.05.008

Robinson, J.B., Tuovinen, O.H., 1984. Mechanisms of microbial resistance and detoxification of mercury and organomercury compounds: physiological, biochemical, and genetic analyses. Microbiological Reviews 48, 95–124. doi:0146-0749/84/020095

Roden, E.E., Lovley, D.R., 1993. Dissimilatory Fe(III) reduction by the marine microorganism *Desulfuromonas acetoxidans*. Applied and Environmental Microbiology.

Rose, S., Ghazi, A.M., 1997. Release of sorbed sulfate from iron oxyhydroxides precipitated from acid mine drainage associated with coal mining. Environmental Science and Technology. doi:10.1021/es960970f

Roulet, M., Lucotte, M., 1995. Geochemistry of mercury in pristine and flooded ferralitic soils of a tropical rain forest in French Guiana, South America. Water, Air, & Soil Pollution 80, 1079–1088. doi:10.1007/BF01189768

Roulet, M., Lucotte, M., Farella, N., Serique, G., Coelho, H., Passos, C.J.S., Silva, E. de J. da, Andrade, P.S. de, Mergler, D., Guimarães, J.-R.D., Amorim, M., 1999. Effects of Recent Human Colonization on the Presence of Mercury in Amazonian Ecosystems. Water, Air, and Soil Pollution 112, 297–313. doi:10.1023/A:1005073432015

Roulet, M., Lucotte, M., Saint-Aubin, A., Tran, S., Rhéault, I., Farella, N., De Jesus Da Silva, E., Dezencourt, J., Sousa Passos, C.J., Santos Soares, G., Guimarães, J.R.D., Mergler, D., Amorim, M., 1998. The geochemistry of mercury in central Amazonian soils developed on the Alter-do-Chao formation of the lower Tapajos River Valley, Para state, Brazil. Science of the Total Environment 223, 1–24. doi:10.1016/S0048-9697(98)00265-4

Ruellan, A. and Dosso, M. (1993). Regards sur le sol. Paris, Les Editions Foucher.

Ryu, H.W., Moon, H.S., Lee, E.Y., Cho, K.S., Choi, H., 1999. Leaching characteristics of heavy metals from sewage sludge by *Acidithiobacillus thiooxidans* MET. Journal of Environmental Quality 32, 751–759.

S

Sabey, B.R., Bartholomew, W. V., Shaw, R., Pesek, J., 1956. Influence of Temperature on Nitrification in Soils¹. Soil Science Society of America Journal 20, 357. doi:10.2136/sssaj1956.03615995002000030016x

Safari Sinangani, A.A., Emtiazi, G., Shariatmadari, H., 2005. Sorption and immobilization of cellulase on silicate clay minerals. Journal of Colloid and Interface Science. doi:10.1016/j.jcis.2005.04.030

Sahrawat, K.L., 2008. Factors affecting nitrification in soils. Communications in Soil Science and Plant Analysis 39, 1436–1446. doi:10.1080/00103620802004235

Sala, O.E., Chapin, F.S., Armesto, J.J., Berlow, E., Bloomfield, J., Dirzo, R., H., Sanwald, E., Huenneke, L.F., Jackson, R.B., Kinzig, A., Leemans, R., Lodge, D.M., Mooney, H.A., Oesterheld, M., Leroy Hoff, N., Sykes, M.T., Walker, B.H., W., M., Wall, D., 2000. Global Biodiversity Scenarios for the Year 2100. Science 287, 1770–1774. doi:10.1126/science.287.5459.1770

Sand, W., 2003. Corrosion Books: Geomicrobiology. By: Henry Lutz Ehrlich - Materials and Corrosion 5/2003. Materials and Corrosion 54, 349–349. doi:10.1002/maco.200390078

Santos-Francés, F., García-Sánchez, A., Alonso-Rojo, P., Contreras, F., Adams, M., 2011. Distribution

- and mobility of mercury in soils of a gold mining region, Cuyuni river basin, Venezuela. *Journal of Environmental Management*. doi:10.1016/j.jenvman.2010.12.003
- Sarkar, D., Essington, M.E., Misra, K.C., 2000. Adsorption of Mercury(II) by Kaolinite. *Soil Science Society of America Journal* 64, 1968. doi:10.2136/sssaj2000.6461968x
- Sarkar, D., Essington, M.E., Misra, K.C., 1999. Adsorption of mercury(II) by variable charge surfaces of quartz and gibbsite. *Soil Science Society of America Journal*. doi:10.2136/sssaj1999.6361626x
- Schimann, H., Joffre, R., Roggy, J.C., Lensi, R., Domenach, A.M., 2007. Evaluation of the recovery of microbial functions during soil restoration using near-infrared spectroscopy. *Applied Soil Ecology* 37, 223–232. doi:10.1016/j.apsoil.2007.07.001
- Schimann, H., Petit-Jean, C., Guitet, S., Reis, T., Domenach, A.M., Roggy, J.C., 2012a. Microbial bioindicators of soil functioning after disturbance: The case of gold mining in tropical rainforests of French Guiana. *Ecological Indicators* 20, 34–41. doi:10.1016/j.ecolind.2012.01.021
- Schimann, H., Petit-Jean, C., Guitet, S., Reis, T., Domenach, A.M., Roggy, J.C., 2012b. Microbial bioindicators of soil functioning after disturbance: The case of gold mining in tropical rainforests of French Guiana. *Ecological Indicators* 20, 34–41. doi:10.1016/j.ecolind.2012.01.021
- Schippers, A., Sand, W., 1999. Bacterial leaching of metal sulfides proceeds by two indirect mechanisms via thiosulfate or via polysulfides and sulfur. *Applied and Environmental Microbiology* 65, 319–321.
- Schlöter, M., Dilly, O., Munch, J.C., 2003. Indicators for evaluating soil quality. *Agriculture, Ecosystems and Environment*. doi:10.1016/S0167-8809(03)00085-9
- Schnürer, J., Clarholm, M., Boström, S., Rosswall, T., 1986. Effects of moisture on soil microorganisms and nematodes: A field experiment. *Microbial Ecology* 12, 217–30. doi:10.1007/BF02011206
- Schubert, E., Mengel, K., Schubert, S., 1990. Soil pH and Calcium Effect on Nitrogen Fixation and Growth of Broad Bean. *Agronomy Journal* 82, 969. doi:10.2134/agronj1990.00021962008200050026x
- Schubert, S., Schubert, E., Mengel, K., 1990. Effect of low pH of the root medium on proton release, growth, and nutrient uptake of field beans (*Vicia faba*). *Plant and Soil* 124, 239–244. doi:10.1007/BF00009266
- Schuster, E., 1991. The behavior of mercury in the soil with special emphasis on complexation and adsorption processes - A review of the literature. *Water, Air, & Soil Pollution* 56, 667–680. doi:10.1007/BF00342308
- Shuman, L.M., 1985. Fraction method for soil microelements. *Soil Science* 140, 11–22. doi:10.1097/00010694-198507000-00003
- SER, 2004. Society for Ecological Restoration [WWW Document]. SER International Primer on Ecological Restoration.
- Shammas Kh., N., 1986. Interactions biomass on the nitrification of pH , process and. *Water Pollution Control Federation Journal* 58, 52–59.
- Shukla, G., Varma, A. (Ajit), 2011. *Soil enzymology*. Springer.
- Siddique, I., Engel, V.L., Parrotta, J.A., Lamb, D., Nardoto, G.B., Ometto, J.P.H.B., Martinelli, L.A., Schmidt, S., 2008. Dominance of legume trees alters nutrient relations in mixed species forest restoration plantings within seven years. *Biogeochemistry* 88, 89–101. doi:10.1007/s10533-008-9196-5

- Silva, C.C., Guido, M.L., Ceballos, J.M., Marsch, R., Dendooven, L., 2008. Production of carbon dioxide and nitrous oxide in alkaline saline soil of Texcoco at different water contents amended with urea: A laboratory study. *Soil Biology and Biochemistry* 40, 1813–1822. doi:10.1016/j.soilbio.2008.03.004
- Silveira, M.L., Alleoni, L.R.F., O'Connor, G.A., Chang, A.C., 2006. Heavy metal sequential extraction methods-A modification for tropical soils. *Chemosphere* 64, 1929–1938. doi:10.1016/j.chemosphere.2006.01.018
- Singh, A.N., Raghubanshi, A.S., Singh, J.S., 2004. Impact of native tree plantations on mine spoil in a dry tropical environment. *Forest Ecology and Management* 187, 49–60. doi:10.1016/S0378-1127(03)00309-8
- Skyllberg, U., Bloom, P.R., Qian, J., Lin, C.M., Bleam, W.F., 2006a. Complexation of mercury(II) in soil organic matter: EXAFS evidence for linear two-coordination with reduced sulfur groups. *Environmental Science and Technology* 40, 4174–4180. doi:10.1021/es0600577
- Skyllberg, U., Bloom, P.R., Qian, J., Lin, C.M., Bleam, W.F., 2006b. Complexation of mercury(II) in soil organic matter: EXAFS evidence for linear two-coordination with reduced sulfur groups. *Environmental Science and Technology* 40, 4174–4180. doi:10.1021/es0600577
- Skyllberg, U., Xia, K., Bloom, P.R., Nater, E. a., Bleam, W.F., 2000. Binding of Mercury(II) to Reduced Sulfur in Soil Organic Matter along Upland-Peat Soil Transects. *Journal of Environment Quality* 29, 855. doi:10.2134/jeq2000.00472425002900030022x
- Smedley, P.L., Kinniburgh, D.G., 2002. A review of the source, behaviour and distribution of arsenic in natural waters. *Applied Geochemistry*. doi:10.1016/S0883-2927(02)00018-5
- Smith, J.L., Doran, J.W., Jones, A.J., 1996. Measurement and Use of pH and Electrical Conductivity for Soil Quality Analysis. *Methods for Assessing Soil Quality sssaspeca*, 169–185. doi:10.2136/sssaspecpub49.c10
- Stams, A.J.M., Plugge, C.M., de Bok, F.A.M., van Houten, B.H.G.W., Lens, P., Dijkman, H., Weijma, J., 2005. Metabolic interactions in methanogenic and sulfate-reducing bioreactors. *Water Science and Technology*. doi:10.2166/wst.2005.0493
- Stemmler, S.J., Berthelin, J., 2003. Microbial activity as a major factor in the mobilization of iron in the humid tropics. *European Journal of Soil Science*. doi:10.1046/j.1351-0754.2003.0571.x
- Stokstad, E., 2005. Ecology - Taking the pulse of earth's life-support systems. *Science* 308, 41–43. doi:10.1126/science.308.5718.41
- Subke, J.A., Bahn, M., 2010. On the “temperature sensitivity” of soil respiration: Can we use the immeasurable to predict the unknown? *Soil Biology and Biochemistry* 42, 1653–1656. doi:10.1016/j.soilbio.2010.05.026
- Summers, A.O., 1986. Organization, Expression, and Evolution of Genes for Mercury Resistance. *Annual Review of Microbiology* 40, 607–634. doi:10.1146/annurev.mi.40.100186.003135
- Svensson, B.H., Söderland, R., 1976. Nitrogen, phosphorus and sulphur : global cycles. International Council for Science (ICSU), Scientific Committee on Problems of the Environment (SCOPE), Stockholm.
- Swift, M.J., Andrén, O., Brussaard, L., Briones, M., Couteaux, M.M., Ekschmitt, K., Kjoller, A., Loiseau, P., Smith, P., 1998. Global change, soil biodiversity, and nitrogen cycling in terrestrial ecosystems: three case studies. *Global Change Biology* 4, 729–743. doi:10.1046/j.1365-2486.1998.00207.x

T

- Tabatabai, M.A., 1994. Soil Enzymes, in: *Methods of Soil Analysis. Part 2. Microbiological and Biochemical Properties*. pp. 775–833. doi:10.2136/sssabookser5.2.c37
- Tang, C., Weligama, C., Sale, P., 2013. Subsurface Soil Acidification in Farming Systems: Its Possible Causes and Management Options, in: *Molecular Environmental Soil Science*. Springer Netherlands, Dordrecht, pp. 389–412. doi:10.1007/978-94-007-4177-5_13
- Taylor, J.P., Wilson, B., Mills, M.S., Burns, R.G., 2002. Comparison of microbial numbers and enzymatic activities in surface soils and subsoils using various techniques. *Soil Biology and Biochemistry* 34, 387–401. doi:10.1016/S0038-0717(01)00199-7
- Tejada, M., Benítez, C., Gómez, I., Parrado, J., 2011. Use of biostimulants on soil restoration: Effects on soil biochemical properties and microbial community. *Applied Soil Ecology* 49, 11–17. doi:10.1016/j.apsoil.2011.07.009
- Telmer, K., Costa, M., Angélica, R.S., Araujo, E.S., Maurice, Y., 2006. The source and fate of sediment and mercury in the Tapajós River, Pará, Brazilian Amazon: Ground- and space-based evidence. *Journal of Environmental Management* 81, 101–113. doi:10.1016/j.jenvman.2005.09.027
- Tessier, D., Bruand, A., Bissonais, Y. Le, 1996. Qualité chimique et physique des sols : Variabilité spatiale et évolution. Numéro Spécial Étude et Gestion Des Sols.
- Tessier, E., Amouroux, D., Grimaldi, M., Stoichev, T., Grimaldi, C., Dutin, G., Donard, O.F.X., 2003. Mercury mobilization in soil from a rainfall event in a Tropical forest (French Guyana). *Journal de Physique IV (Proceedings)* 107, 1301–1304. doi:10.1051/jp4:20030539
- Tilman, D., Fargione, J., Wolff, B., D'Antonio, C., Dobson, A., Howarth, R., Schindler, D., Schlesinger, W., Simberloff, D., Swackhamer, D., 2001. Forecasting Agriculturally Driven Global Environmental Change. *Science* 292, 281–284. doi:10.1126/science.1057544
- Tripathi, N., Singh, R.S., 2008. Ecological restoration of mined-out areas of dry tropical environment, India. *Environmental Monitoring and Assessment*. doi:10.1007/s10661-007-0083-7

U

- Udawatta, R.P., Kremer, R.J., Adamson, B.W., Anderson, S.H., 2008. Variations in soil aggregate stability and enzyme activities in a temperate agroforestry practice. *Applied Soil Ecology*. doi:10.1016/j.apsoil.2007.12.002
- Ullrich, S.M., Tanton, T.W., Abdrashitova, S.A., 2001. Mercury in the aquatic environment: A review of factors affecting methylation. *Critical Reviews in Environmental Science and Technology*. doi:10.1080/20016491089226
- Unger, I.M., Kennedy, A.C., Muzika, R.-M., 2009. Flooding effects on soil microbial communities. *Applied Soil Ecology* 42, 1–8. doi:10.1016/j.apsoil.2009.01.007

V

- Valentim dos Santos, J., Varón-López, M., Fonsêca Sousa Soares, C.R., Lopes Leal, P., Siqueira, J.O., de Souza Moreira, F.M., 2016. Biological attributes of rehabilitated soils contaminated with heavy

- metals. *Environmental Science and Pollution Research* 23, 6735–6748. doi:10.1007/s11356-015-5904-6
- Vega, F.A., Andrade, M.L., Covelo, E.F., 2010. Influence of soil properties on the sorption and retention of cadmium, copper and lead, separately and together, by 20 soil horizons: Comparison of linear regression and tree regression analyses. *Journal of Hazardous Materials* 174, 522–533. doi:10.1016/j.jhazmat.2009.09.083
- Veiga, M., Hinton, J., Lilly, C., 1999. Mercury in the Amazon: a comprehensive review with special emphasis on bioaccumulation and bioindicators, in: NIMD (National Institute for Minamata Disease) Forum'99.
- Veiga, M.M., Baker, R.F., 2004. Protocols for Environmental and Health Assessment of Mercury Released by Artisanal and Small-scale Gold Miners.
- Veiga, M.M., Maxson, P.A., Hylander, L.D., 2006. Origin and consumption of mercury in small-scale gold mining. *Journal of Cleaner Production* 14, 436–447. doi:10.1016/j.jclepro.2004.08.010
- Velasquez, E., Lavelle, P., Barrios, E., Joffre, R., Reversat, F., 2005. Evaluating soil quality in tropical agroecosystems of Colombia using NIRS. *Soil Biology and Biochemistry*. doi:10.1016/j.soilbio.2004.09.009
- Viana, R.M., Ferraz, J.B.S., Neves, A.F., Vieira, G., Pereira, B.F.F., 2014. Soil quality indicators for different restoration stages on Amazon rainforest. *Soil and Tillage Research* 140, 1–7. doi:10.1016/j.still.2014.01.005
- Vié, J.-C., Hilton-Taylor, C., Stuart, S.N., 2008. Wildlife in a changing world - An analysis of the 2008 IUCN Red List of Threatened Species, IUCN Gland Switzerland. IUCN. doi:10.2305/IUCN.CH.2009.17.en
- Vig, K., Megharaj, M., Sethunathan, N., Naidu, R., 2003. Bioavailability and toxicity of cadmium to microorganisms and their activities in soil: A review. *Advances in Environmental Research*. doi:10.1016/S1093-0191(02)00135-1
- Vitousek, P.M., Howarth, R.W., 1991. Nitrogen limitation on land and in the sea: How can it occur? *Biogeochemistry*. doi:10.1007/BF00002772

W

- Walker, T.S., 2003. Root Exudation and Rhizosphere Biology. *PLANT PHYSIOLOGY* 132, 44–51. doi:10.1104/pp.102.019661
- Walter Alves Durao Junior, Helena Eugenia Leonhardt Palmieri, M.C.T., Otavio Eurico de Aquino Branco, Carlos Alberto Carvalho Filho, P.M.F., Windmoller, J.B.B. da S. and C.C., 2009. Speciation, distribution, and transport of mercury in contaminated soils from Descoberto, Minas Gerais, Brazil. *Journal of Environmental Monitoring* 11, 1056–1063. doi:10.1039/b813997k
- Wang, J., Feng, X., Anderson, C.W.N., Zhu, W., Yin, R., Wang, H., 2011. Mercury distribution in the soil-plant-air system at the Wanshan mercury mining district in Guizhou, Southwest China. *Environmental Toxicology and Chemistry* 30, 2725–2731. doi:10.1002/etc.681
- Wang, Y., Shi, J., Wang, H., Lin, Q., Chen, X., Chen, Y., 2007. The influence of soil heavy metals pollution on soil microbial biomass, enzyme activity, and community composition near a copper smelter. *Ecotoxicology and Environmental Safety* 67, 75–81. doi:10.1016/j.ecoenv.2006.03.007

- Wasserman, J.C., Fundação, S.S.H., Cruz, O., Wasserman, M., 2003. Biogeochemistry of Mercury in the Amazonian Environment Mercury Exposure in Yanomami Indigenous Communities in the state of Roraima View project Fate of nanoparticles in the environment View project 32. doi:10.1639/0044-7447(2003)032[0336:BOMITA]2.0.CO;2
- Watras, C.J., Huckabee, J.W., 1994. Mercury Pollution Integration and Synthesis.
- Weber, J.H., 1993. Review of possible paths for abiotic methylation of mercury(II) in the aquatic environment. *Chemosphere*. doi:10.1016/0045-6535(93)90032-Z
- White, D.C., Flemming, C.A., Leung, K.T., MacNaughton, S.J., 1998. In situ microbial ecology for quantitative appraisal, monitoring, and risk assessment of pollution remediation in soils, the subsurface, the rhizosphere and in biofilms. *Journal of Microbiological Methods*. doi:10.1016/S0167-7012(98)00017-7
- Widdel, F., 1998. Microbiology and ecology of sulfate-and sulfur-reducing bacteria. IN Zender AJB (Ed) *Biology of Anaerobic Microorganisms*. Wiley, New York. doi:10.1007/978-1-4757-2191-1
- Wong, M., 2003. Ecological restoration of mine degraded soils, with emphasis on metal contaminated soils. *Chemosphere* 50, 775–780. doi:10.1016/S0045-6535(02)00232-1

X

- Xian, Y., Wang, M., Chen, W., 2015. Quantitative assessment on soil enzyme activities of heavy metal contaminated soils with various soil properties. *Chemosphere* 139, 604–608. doi:10.1016/j.chemosphere.2014.12.060
- Xie, L.W., Zhong, J., Cao, F.X., Li, J.J., Wu, L.C., 2014. Evaluation of soil fertility in the succession of karst rocky desertification using principal component analysis. *Solid Earth Discussions* 6, 3333–3359. doi:10.5194/sed-6-3333-2014
- Xu, H., Allard, B., 1991. Effects of a fulvic acid on the speciation and mobility of mercury in aqueous solutions. *Water, Air, & Soil Pollution*. doi:10.1007/BF00342311
- Xu, L., Wu, X., Wang, S., Yuan, Z., Xiao, F., Yang, M., Jia, Y., 2016. Speciation change and redistribution of arsenic in soil under anaerobic microbial activities. *Journal of Hazardous Materials* 301, 538–546. doi:10.1016/j.jhazmat.2015.09.030
- Xu, Z., Chen, C., 2006. Fingerprinting Global Climate Change and Forest Management Within Rhizosphere Carbon and Nutrient Cycling Processes. *Area* 13, 293–298.
- Xu, Z., Chen, C., He, J., Liu, J., 2009a. Trends and challenges in soil research 2009: Linking global climate change to local long-term forest productivity. *Journal of Soils and Sediments* 9, 83–88. doi:10.1007/s11368-009-0060-6
- Xu, Z., Chen, C., He, J., Liu, J., 2009b. Trends and challenges in soil research 2009: Linking global climate change to local long-term forest productivity. *Journal of Soils and Sediments* 9, 83–88. doi:10.1007/s11368-009-0060-6

Y

- Yang, D., Zeng, D., Mao, R., Li, L., 2010. Restoration effect of young plantations on magnesite mine spoil in Northeast China, in: 2010 4th International Conference on Bioinformatics and Biomedical Engineering, ICBBE 2010. doi:10.1109/ICBBE.2010.5516608

Yang, Y., Chen, Y.-X., Tian, G.-M., Zhang, Z.-J., 2005. Microbial activity related to N cycling in the rhizosphere of maize stressed by heavy metals. *Journal of Environmental Sciences (China)*.

Young, S.D., 2012. Chemistry of Heavy Metals and Metalloids in Soils, in: *Heavy Metals in Soils: Trace Metals and Metalloids in Soils and Their Bioavailability*. Springer, Dordrecht, pp. 51–95. doi:10.1007/978-94-007-4470-7_3

Z

Zhou, T., Shi, P., Hui, D., Luo, Y., 2009. Global pattern of temperature sensitivity of soil heterotrophic respiration (Q₁₀) and its implications for carbon-climate feedback. *Journal of Geophysical Research: Biogeosciences*. doi:10.1029/2008JG000850

Zhou, W., Hui, D., Shen, W., 2014. Effects of soil moisture on the temperature sensitivity of soil heterotrophic respiration: A laboratory incubation study. *PLoS ONE*. doi:10.1371/journal.pone.0092531

Zhu, L. xia, Xiao, Q., Shen, Y. fang, Li, S. qing, 2017. Microbial functional diversity responses to 2 years since biochar application in silt-loam soils on the Loess Plateau. *Ecotoxicology and Environmental Safety*. doi:10.1016/j.ecoenv.2017.06.075

« Interactions microorganismes - mercure - composante du sol : des outils pour l'évaluation de la qualité de la restauration écologique des sites miniers aurifères en Guyane française »

Résumé :

Depuis plus de 150 ans l'exploitation aurifère en Guyane française bouleverse le paysage et l'écosystème. Les conséquences sont multiples, aussi bien pour l'environnement que pour la santé humaine. Pendant des décennies l'utilisation du mercure dans le processus d'extraction a entraîné une contamination du réseau hydrique et de la chaîne trophique. Afin d'inscrire l'exploitation aurifère dans une optique de développement durable le code minier impose depuis 1998 une obligation de réhabilitation des sites exploités. Des méthodes de revégétalisation utilisant différentes essences végétales ont donc été adoptées afin d'accélérer les successions écologiques. Le contrôle de la qualité de restauration écologique est néanmoins difficile à mettre en œuvre et il est nécessaire d'avoir des outils de bio-géo-indications fiables et peu coûteux pour estimer le recouvrement des fonctionnalités des écosystèmes et apprécier le risque de mobilités des éléments traces toxiques.

Dans ce contexte, les objectifs de ce travail de thèse ont été d'évaluer la qualité de restauration écologique de sites miniers à travers une caractérisation des activités microbiennes, du fonctionnement des cycles biogéochimiques d'éléments majeurs (C, N, P) et de la dynamique du mercure. L'originalité de ce travail réside dans l'évaluation dans le temps et dans l'espace des interactions entre couvert végétal – propriétés physico-chimiques du sol – activités microbiennes – spéciation du mercure après revégétalisation et en faire un outil diagnostique de la réussite de cette restauration. Dans ce but, plusieurs campagnes d'échantillonnages ont été réalisées en Guyane sur un panel de sites miniers réhabilités, avec différents types de couverts végétaux. Des échantillons de sols ont été prélevés sur des sites revégétalisés avec des espèces de fabacées, et sur des sites non revégétalisés. Nous avons évalué les fonctionnalités des communautés microbiennes de ces sites avec plusieurs bio-marqueurs de la qualité du sol. Afin d'estimer le devenir du mercure, des mesures du mercure total ainsi que des spéciations opérationnelles et environnementales ont été réalisées.

Ce travail de thèse a permis de mettre en évidence un effet positif de la revégétalisation sur la densité et les activités des communautés microbiennes. Les sites restaurés ont montré une biomasse microbienne, des taux de minéralisation des macroéléments (C, N, P), une diversité catabolique plus élevées que des sites non restaurés. Nos résultats confirment que la restauration influence les activités des communautés microbiennes anaérobies. En effet, les travaux portant sur les communautés bactériennes ferri-réductrices (BFR) et sulfato-réductrices (BSR) montrent des activités variantes entre les modalités de revégétalisation. Ces différences sont à mettre en relation avec les propriétés physiques et chimiques du sol ainsi qu'avec la nature du couvert végétal. Les communautés BFR sont actives sur les sites réhabilités alors que les communautés BSR seraient davantage actives sur les sites faiblement restaurés. Ces différences ont des conséquences sur la mobilité du mercure. Nos travaux montrent que si dans les sites revégétalisés le mercure est associé à des phases stables du sol alors que dans les sites non restaurés il est sous des formes solubles mobilisable dans le réseau hydrique, bio disponibles pour les organismes de la chaîne trophique.

Pour conclure, l'approche interdisciplinaire proposée dans ce travail a permis d'identifier certains processus d'écologie microbienne fondamentaux impactant le recouvrement des fonctionnalités des écosystèmes miniers dégradés. Ce travail offre un outil d'évaluation de la qualité de la restauration écologique original, appliqué et prometteur, qui pourra intéresser les décideurs responsables de la réhabilitation des sites miniers en Guyane française.

MOTS CLES : Restauration écologique, microorganismes, cycles biogéochimiques, mercure