



HAL
open science

Démarche méthodologique pour la conception préliminaire et interactive

David Ríos Zapata

► **To cite this version:**

David Ríos Zapata. Démarche méthodologique pour la conception préliminaire et interactive. Génie mécanique [physics.class-ph]. Ecole nationale supérieure d'arts et métiers - ENSAM; Universidad EAFIT, 2018. Français. NNT : 2018ENAM0066 . tel-02169557

HAL Id: tel-02169557

<https://pastel.hal.science/tel-02169557v1>

Submitted on 1 Jul 2019

HAL is a multi-disciplinary open access archive for the deposit and dissemination of scientific research documents, whether they are published or not. The documents may come from teaching and research institutions in France or abroad, or from public or private research centers.

L'archive ouverte pluridisciplinaire **HAL**, est destinée au dépôt et à la diffusion de documents scientifiques de niveau recherche, publiés ou non, émanant des établissements d'enseignement et de recherche français ou étrangers, des laboratoires publics ou privés.

École doctorale n° 432 : Science des Métiers de l'ingénieur

Doctorat ParisTech

THÈSE

pour obtenir le grade de docteur délivré par

l'École Nationale Supérieure d'Arts et Métiers

Spécialité doctorale « Génie Mécanique et Conception »

présentée et soutenue publiquement par

David RÍOS-ZAPATA

le 14 décembre 2018

Démarche méthodologie pour la conception préliminaire et interactive

Directeurs de thèse : **Jérôme PAILHÈS**
: **Ricardo MEJÍA-GUTIÉRREZ**

Jury

M. Pascal LAFON, Professeur des Universités, Université de Technologie de Troyes
M. Denis CAVALLUCCI, Professeur des Universités, INSA Strasbourg/ICUBE
Mme. Émilie POIRSON, Professeur des Universités, École Centrale de Nantes
M. Jérôme PAILHÈS, Professeur des Universités, Arts et Métiers ParisTech
M. Ricardo MEJÍA-GUTIÉRREZ, Professeur des Universités, Universidad EAFIT

Président
Rapporteur
Rapporteur
Examineur
Examineur

**T
H
È
S
E**

UNIVERSIDAD EAFIT

Engineering School
Design Engineering Research Group (GRID)



**Methodological approach for interactive
preliminary-design**

GRADUATION MANUSCRIPT PRESENTED AS PARTIAL REQUIREMENT TO OBTAIN THE
PhD in Mechanical Engineering and Design

AUTHOR:

David RÍOS-ZAPATA

ADVISORY TEAM:

Ricardo Mejía-Gutiérrez, (Universidad EAFIT)

Jérôme Pailhès, (Arts et Métiers ParisTech)

December 14, 2018



Résumé

Les processus de prise de décision à la conception préliminaire sont liées à l'hierarchisation des spécifications de conception et des variables afin de développer des solutions plus proches des exigences du produit. Néanmoins, la taille de l'information est souvent volumineuse et difficile à comprendre : garder la trace de la liste des variables dépendantes, des variables indépendantes et des objectifs de conception est une tâche difficile, avec potentiellement un retraitement et une perte de temps, en particulier quand il est nécessaire d'identifier comment une modification sur une variable peut affecter les performances du produit.

L'objectif de cette thèse est de générer une méthode interactive permettant d'obtenir un compromis entre la désirabilité des objectifs de conception. Ce processus de compromis repose sur deux aspects : i) l'élaboration d'un modèle de traçabilité, gérant les informations à partir des exigences d'entrée (dans le champ linguistique) jusqu'à la définition des variables (dans le champ des nombres réels). ii) un cadre d'amélioration de la conception, fondé sur la définition des fonctions de désirabilité des objectifs de conception ; la propagation de ces fonctions jusqu'à ce que les variables de conception permettent de calculer les combinaisons de valeurs qui maximisent l'index global de désirabilité de la solution. L'objectif de ce processus de compromis est de fonctionner dans un environnement de conception multidisciplinaire, confronté à des problèmes convexes et non convexes.

La proposition de cette thèse peut être comprise comme une approche hybride, comprenant une partie exploratoire interactive et une partie interactive inductive. Sur la partie exploratoire, les concepteurs peuvent modifier les variables à l'aide d'outils visuels afin de comprendre en temps réel l'impact de ces modifications sur les objectifs de conception. Sur la partie inductive, les concepteurs utilisent une méthode de pré-dimensionnement proposée qui calcule les valeurs des

variables qui maximisent l'opportunité des objectifs de conception.

Mots clés : *Conception interactive préliminaire, optimisation multi-critère, cadre de traçabilité, méthodologie de conception, maximisation de la désirabilité.*

Abstract

Preliminary design decision-making processes are related to the prioritisation of design specifications and variables in order to develop solutions that are closer to product's requirements. Nevertheless, the size of the information is often large and hard to understand: keeping in track the list of dependent variables, independent variables and design objectives is a challenging task, with potentially reprocessing and loss of time, especially when it is necessary to identify how a modification on a variable might impact the performance of the product.

The objective of this thesis is to generate an interactive method that can obtain a trade-off among the design objectives desirability. This trade-off process is supported on two aspects: i) the development of a traceability model, managing information from the input requirements (in the linguistic field) up to the variables definition (in the real numbers field). ii) A design amelioration framework, based on the definition of the design objectives desirability functions; the propagation of these functions until design variables allow calculating the combinations of values that maximise the global desirability of the solution. The goal of this trade-off process is to perform on a multidisciplinary design environment, facing convex and non-convex problems as well.

The proposal of the thesis can be understood as a hybrid approach, including an interactive exploratory part and an inductive interactive part. On the exploratory part, designers can modify the variables using visual tools in order to understand in real time how these modifications have an impact on the design objectives. On the inductive part, designers make use a proposed pre-sizing method that calculates the values of the variables that maximise the desirability of the design objectives.

Keywords: *Preliminary interactive design, multicriteria optimisation, traceability framework, design methodology, desirability maximisation.*

Los procesos de toma de decisiones en el diseño preliminar están relacionados con la priorización de las especificaciones y variables de diseño para desarrollar soluciones que estén más cerca de los requisitos del producto. Sin embargo, el tamaño de la información suele ser grande y difícil de entender. Mantener un seguimiento de la lista de variables dependientes, variables independientes y objetivos de diseño es una tarea difícil, con un posible reprocesamiento y pérdida de tiempo, especialmente cuando es necesario identificar como una modificación en una variable podría afectar el rendimiento del producto.

El objetivo de esta tesis es generar un método interactivo que pueda obtener un *trade-off* entre la deseabilidad de los objetivos. Este proceso de *trade-off* se apoya en dos aspectos: i) el desarrollo de un modelo de trazabilidad, que gestiona la información desde los requerimientos de entrada (en el campo lingüístico) hasta la definición de las variables (en el campo de los números reales). ii) un marco de mejora del diseño, basado en la definición de las funciones de deseabilidad de los objetivos de diseño: la propagación de estas funciones hasta que las variables de diseño permiten calcular las combinaciones de valores que maximizan la deseabilidad global de la solución. El resultado de ésta tesis pretende desarrollarse en entornos de diseño multidisciplinario, enfrentándose a problemas convexos y no convexos.

La propuesta de la tesis puede entenderse como un enfoque híbrido, que incluye una parte exploratoria interactiva y una parte interactiva inductiva. En la parte exploratoria, los diseñadores pueden modificar las variables utilizando herramientas visuales para comprender en tiempo real cómo estas modificaciones tienen un impacto en los objetivos de diseño. En la parte inductiva, los diseñadores hacen uso de un método de pre-dimensionamiento propuesto, que calcula los valores de las variables que maximizan la deseabilidad de los objetivos de diseño.

Palabras claves: *Diseño interactivo preliminar, optimización multicriterio, marco de trazabilidad, metodología de diseño, maximización de la deseabilidad.*

Remerciements

À mes directeurs de thèse pour m'avoir guidé et conseillé pendant ces années. Merci pour vos conseils et votre patience. La partie la plus difficile de ce type de projets est la communication, spécialement la communication par Skype. Jérôme, Ricardo, merci pour tout. Aussi, je voudrai remercier à Jean-Pierre Nadeau, pour avoir confiance en moi et me permettre d'arriver en France pour ma thèse.

Je remercie également les rapporteurs de cette thèse, la professeure Émilie POIRSON de l'École Centrale de Nantes et Denis CAVALLUCCI de l'INSA de Strasbourg pour avoir accepté d'examiner ce travail. Mes remerciements s'adressent aussi au professeur Pascal LAFON, de l'Université de Technologie de Troyes, pour avoir accepté de présider mon jury de thèse.

Je remercie aussi à Nicolas PERRY pour m'accueillir dans le laboratoire à Bordeaux et aussi à tous les chercheurs avec lesquels j'ai eu l'occasion de partager au cours de ces années. Également aux mes collègues au Laboratoire et tout le personnel administratif qu'ils ont été toujours gentils et m'ont aidé de différentes manières. Merci à Michel MESNARD, Marco MONTEMURRO, Giulio COSTA, Yohann AUDOUX, Azita AHMADI, Béatrice DESOUDIN.

Je voudrais aussi remercier aux sponsors de ma thèse, les organisations qu'ils m'ont donné des bourses : L'ambassade de France la France à la Colombie, le Ministère de l'éducation de la Colombie, l'ASCUN (ASsociation Colombienne des UNiversités) et Colfuturo, pour le financement à l'Europe. Aussi à la bourse de recherche de l'Universidad EAFIT et surtout mes parents pour tout le soutien à la Colombie.

Y en español : primero que todo a todas las personas en la Universidad EAFIT apoyaron ésta tesis a doble diploma. A Ricardo Mejía y Gilberto Osorio por haberme permitido ser parte del Grupo de Investigación en Ingeniería de Diseño por nueve años.

También a todas las personas en el GRID, tanto como colegas y amigos, han estado ahí durante tantos años : a Melisa, Stefy, Ana ; a Santiago, Jorge, Jesús, Andrés, Juan Carlos, Mauricio, Sebastián, Alejandro, Esteban. A Sebastián Ospina, Julián Sánchez, Esteban Echavarría por el soporte informático con la plataforma interactiva.

Obvio, a los amigos que dejó el doctorado, amigos de muchos rincones del mundo. A Santiago y Lina ; a Aitor y Jose ; a Ulises y Jorge, a Rachel ; a Xingyu Yan. Gracias por haber formado unos lazos de amistad tan chéveres y de haber podido disfrutar del tiempo que coincidimos en Bordeaux. Sin ustedes, tantos años de trabajo duro no hubieran sido tan amenos.

Algumas pequenas linhas em português, porque gostaria de agradecer a meus amigos Ana y Ricardo. Eu estou muito obrigado com vocês, com seu companhia, com os domingos na França. Obrigadíssimo. Agora, vocês cinco são convidados para a minha casa, na Colombia.

También le quería agradecer a Verónica. Lo mejor que me ha dejado el doctorado fue haber coincidido con ella en Francia. Fue gracias al doctorado que pudimos conocernos en Paris, y desde *la ville lumière*, empezar a escribir una nueva y mejor historia de vida. Gracias lindis por estar ahí e iluminarme todos estos años. Gracias por tu ayuda, que sin ti, no sabemos en dónde habría terminado éste viaje.

Por último y no menos importante. A mi familia. El apoyo de ellos en este proyecto ha sido infinito. En todos los aspectos, a ellos cuatro por haberse aguantado los malgenios y las horas y horas de desatención durante media década, a mi abuela, mamá, papá y hermana.

Y a los que de una y otra manera han ayudado, ¡gracias !

I	Résumé substantiel en français	1
1.	Résumé substantiel en français	5
1.1.	Introduction général	5
1.1.1.	Contexte de la recherche	6
1.1.2.	Justification de la recherche	13
1.1.3.	Définition du problème et questions de recherche	17
1.2.	État de l'art	20
1.2.1.	Interaction entre les objectifs de conception	20
1.2.2.	Pré-dimensionnement dans des problèmes multidisciplinaires non-convexes	21
1.2.3.	Conception interactive et amélioration de la prise de décision	23
1.3.	Interaction entre les objectifs de conception	23
1.3.1.	Compréhension des relations dans les processus de conception de produits	27
1.3.2.	Mesure de l'interaction entre les Propriétés et leurs Caractéristiques . . .	28
1.3.3.	Évaluation de l'interaction entre les Propriétés	37
1.4.	Amélioration de la désirabilité globale des objectifs de conception	40
1.4.1.	Méthode de pré-dimensionnement pour maximiser la désirabilité globale de la solution	41
1.4.2.	Évaluation des problèmes convexes	49
1.4.3.	Évaluation des problèmes non convexes	54
1.4.4.	Analyse de la méthodologie de conception proposé	60
1.5.	Validation de la méthodologie de conception préliminaire et interactive	60

1.5.1.	Description du cas	61
1.5.2.	Conception interactive exploratoire : d'étude de cas du SAPV	62
1.5.3.	Maximisation de la désirabilité des Propriétés en utilisant la méthode SSNV 69	69
1.5.4.	Analyse des résultats de la méthode SSNV sur la conception du SAPV	75
1.5.5.	Discussion de la mise en œuvre de la méthodologie interactive	76
1.6.	Conclusions et perspectives	79
II	Thesis manuscript in English	85
2.	General Introduction	91
2.1.	Context of the research	92
2.1.1.	Basic principles of design context	92
2.1.2.	Tools and methods in design processes	94
2.2.	Justification	103
2.2.1.	Background of the research	103
2.2.2.	Problem definition and research questions	108
2.3.	Work description	110
2.3.1.	Research objectives	110
2.3.2.	Scope	111
2.3.3.	Document structure	111
3.	State of the Art	113
3.1.	Interaction among design objectives	113
3.1.1.	Prioritisation among design objectives and/or design variables	113
3.1.2.	Optimisation techniques for understanding interaction	115
3.1.3.	Visualisation techniques in order to understand the interaction of information 117	117
3.1.4.	Analysis of the interaction among design objectives	119
3.2.	Pre-sizing in non-convex multidisciplinary problems	120
3.2.1.	Convexification of non-convex problems	121
3.2.2.	Multidisciplinary optimisation of non-convex problems	122
3.2.3.	Membership function optimisation	127
3.2.4.	Analysis and insights of pre-sizing techniques	129
3.3.	Interactive design and decision-making empowerment	129
3.3.1.	State of the Art of interactive design	129

3.3.2. Analysis and insights of interactive design	133
4. Interaction among design objectives	135
4.1. Understanding relationships in product design processes	144
4.2. Measuring interaction between Properties and its Characteristics	153
4.2.1. Evaluation of independent variables variation	154
4.2.2. Interpretation of sensibility analysis	157
4.2.3. Development of a traceability framework	162
4.3. Evaluation of interaction among Properties	168
4.3.1. Prioritisation of the Characteristics	169
4.3.2. Impact of modifying Characteristics	171
4.3.3. Evaluation of collateral connections among Characteristics	174
5. Amelioration of the global desirability of design objectives	181
5.1. Pre-sizing method for maximising global desirability of the solution	187
5.1.1. Propagation of desirability to Characteristics layer	191
5.1.2. Definition of desirability function of Characteristics	194
5.1.3. Definition of an evaluation mechanism	197
5.2. Convex problems evaluation	200
5.2.1. Preparation of the method	201
5.2.2. Implementation of the iterative method	201
5.2.3. Implementation of the pre-sizing method in convex problems	202
5.2.4. Implementation of pre-sizing method in constrained convex problems	207
5.3. Non-Convex problems evaluation	209
5.3.1. Method for convexification of non-convex Properties	210
5.3.2. SSNV application of problems with one non-convex Property	213
6. Interactive-preliminary design methodology validation	227
6.1. Description of the case	228
6.1.1. Solar energy systems	228
6.1.2. Development of energetic systems for developing countries	229
6.2. Exploratory interactive design: SAPVS case study system	231
6.2.1. Task clarification stage for SAPVS design	231
6.2.2. Conceptual design: implementation of CPM/PDD for SAPVS design	235
6.2.3. Embodiment design: Definition of preliminary layout	238

6.3. Maximisation of Properties desirability using SSNV method	244
6.3.1. Implementation of the pre-sizing method	248
6.3.2. Analysis of the results of the SSNV method on the SAPVS design	254
6.4. Discussion of the SSNV method implementation	256
7. Conclusions and further research	263
References	269
A. Preliminary design example: portable cooler	287
A.1. Planning and task clarification	287
A.2. Conceptual design	292
A.2.1. Conceptual development for Pr_1	293
A.2.2. Conceptual development for Pr_2	298
A.2.3. Conceptual development for Pr_3-Pr_5	299
A.2.4. Conceptual development for Pr_6	299
A.2.5. Conceptual development for Pr_7	299
A.2.6. Matrices for traceability tree	300
A.3. Embodiment design	307
B. Interactive framework and Website proposal	309
B.1. Interactive framework application	310
B.2. Website Proposal	313
C. SAPV system: Modelling of its components	319
C.1. Modelling of the PV module	319
C.2. Modelling of the storing system	321
D. SAPV system: External Functional Analysis	323
D.1. Guarantee an economic viability	323
D.2. Guarantee a service provided to the consumer	324
D.3. Guarantee a small impact on the environment	325
E. SAPV system: Internal functional analysis	329
E.1. Pr_1 - Initial investment cost	329

E.2. Pr ₂ - Component replacement cost (<i>CoR</i>)	329
E.3. Pr ₃ - Maintenance and repair costs (<i>CoMR</i>)	330
E.4. Pr ₄ - Cost related to the unavailability of the system (<i>NPC_{loss}</i>)	331
E.5. Pr ₅ - Internal Rate of Return (<i>TRI</i>)	331
E.6. Pr ₆ - Energy outage rate (<i>LPSP</i>)	332
E.7. Pr ₇ - Temporal outage rate (<i>LLP</i>)	334
E.8. Pr ₈ - Environmental impact indicator (<i>C_{dom}</i>)	334
E.9. Pr ₉ - Energy Pay Back Time (<i>TRE</i>)	335
E.10. Pr ₁₀ - Emission of CO ² (<i>GES</i>)	336
E.11. Adjacent Properties: Sensitivity to climate uncertainties	337
F. Analysis of SAPVS sub-systems' Characteristics	339
F.1. Analysis of the Characteristics of the batteries	339
F.2. Analysis of the Characteristics of the inverter and cables	340
F.3. Analysis of the Characteristics of cables	340
F.4. Definition of complementing Characteristics and External Conditions	340
G. SAPV system: Values of the Properties within iterative evaluation	343
H. Exploring the robustness of the SSNV with the SAPVS design	347
H.1. Scenario 1	347
H.2. Scenario 2 and 3	348
H.3. Scenario 4	349

List of Figures

1.1. Méthodologie de conception systématique. Adapté (Pahl et al., 2007)	7
1.2. Positionnement de la thèse	8
1.3. Évolution de la conception dans l'analyse du besoin	10
1.4. Évolution de la conception dans la recherche de concepts	11
1.5. Évolution de la conception dans la conception architecturale	13
1.6. Types d'optimisation	17
1.7. Évolution de l'information à travers les processus de conception	25
1.8. Interprétation de la fonction d'adhésion en couleurs	26
1.9. Proposition de méthode interactive	27
1.10. Méthodologie de conception proposée	28
1.11. Arbre de traçabilité complet basé sur CPM/PDD	29
1.12. Indice de corrélation pour la température interne après 5h	32
1.13. Analyse de sensibilité locale de la surface équivalente (A_{eq})	32
1.14. Chemins de Pr_1 à th_A et H_C	34
1.15. Égaliseur for th_A	39
1.16. SSNV diagramme de processus	42
1.17. Fonction de désirabilité pour Pr_1 et Pr_2	43
1.18. Désirabilité évaluée des Propriétés par la variation de leurs Caractéristiques	44
1.19. Extrait d'un graphe reliant une Caractéristique à ses Propriétés	45
1.20. Fonction de désirabilité propagé pour Ch_1	47
1.21. Approche d'analyse pour résoudre des problèmes convexes	50

1.22. Évolution des désirabilités à travers le processus itératif	53
1.23. Évolution des indexes de désirabilité à travers le processus itératif	54
1.24. Non-convex aggregation figures	55
1.25. Approche synthèse-analyse pour la résolution de problèmes non convexes	56
1.26. Méthode d'analyse utilisée dans l'opération de convexification	57
1.27. Méthodologie de conception interactive	60
1.28. Égaliseurs de la quantité des batteries (N_{bat}) après DCS_0	67
1.29. Égaliseur pour la quantité des modules PV (N_{PV}) après la modification du DCS_0	68
1.30. Preuve de non convexités dans le problème	70
1.31. Désirabilité de T_{bat} pour la boucle 1	72
1.32. Désirabilité de N_{bat} pour la boucle 1	73
1.33. Désirabilité de T_{PV} pour la boucle 1	73
1.34. Désirabilité de N_{PV} pour la boucle 1	74
1.35. Évolution des désirabilités des Propriétés du SAPVS à travers des itérations	77
1.36. Évolution de la désirabilité agrégé des Propriétés à travers des itérations	78
1.37. Égaliseur de la quantité de la quantité des batteries	78
1.38. Interactive framework equaliser in multi-touch surface	82
2.1. Systematic Design Methodology. Adapted (Pahl et al., 2007)	93
2.2. Axiomatic Design Methodology(Suh, 1990)	93
2.3. Positioning of the thesis	95
2.4. Uncertainty in design. Adapted (Giachetti et al., 1997)	96
2.5. Design evolution at planning and task clarification stage	98
2.6. Design evolution at conceptual design	100
2.7. Design evolution at embodiment design	102
2.8. Epistemic uncertainty management in CPM. Adapted (Malmiry, 2016)	105
2.9. Types of design problems optimisation	106
2.10. Mono-criteria and multi-criteria optimisation	107
3.1. Surfaces selection framework. Taken from (Bénabès et al., 2013).	130
3.2. Surfaces selection framework. Taken from (Eisenmann et al., 2014).	132
3.3. Interactive environment for rivets positioning. Taken from (Gao et al., 2013).	132
3.4. Framework for assessing necessary preference data in aesthetics selection. Taken from (Koyama, 2016).	133

3.5. Comparison between graphs visualisation techniques . Taken from (Qu et al., 2017)	133
4.1. Design process strategies. Adapted from (Weber, 2005)	137
4.2. Information evolution through design processes	138
4.3. Membership Functions	141
4.4. Membership function interpretation into colours	141
4.5. Interactive method proposal	142
4.6. Design methodology proposal	142
4.7. Process diagram	144
4.8. External Functional Analysis example	146
4.9. Connection between Customer Requirements and Properties	147
4.10. Conceptual modelling technique: CTOC, FBS and CPM/PDD. Adapted from (Malmiry, 2016).	148
4.11. Connection between Properties and Relations	149
4.12. Relation representation	149
4.13. Relation representation	150
4.14. Connection between Relations, Characteristics and External Conditions	150
4.15. Full traceability tree based on CPM/PDD	151
4.16. Process for calculate interaction Properties and its Characteristics	155
4.17. Possible variables' distributions	156
4.18. Generation of Properties distribution from Monte Carlo sampling	157
4.19. Correlation Index for Internal Temperature after 5h	159
4.20. Local sensibility analysis of equivalent area (A_{eq})	160
4.21. Local sensibility for Pr_1	162
4.22. From Monte Carlo sampling to Sensibility Analysis	163
4.23. Traceability tree for Pr_1 (Characteristics only)	164
4.24. Paths from Pr_1 to th_A and H_C	165
4.25. Connection between Pr_7 to th_A	167
4.26. Collateral relationships between Properties	169
4.27. Equaliser for th_A	173
4.28. Interactive interface: Equaliser of th_B and its supporting information	175
4.29. Equaliser of H_C for Pr_1 according the modifications of th_A	175
4.30. Equaliser of H_C with interval restriction by the variation of th_A	177
4.31. Interactive design methodology	179

5.1. Design methodology proposal	182
5.2. Aggregation techniques comparison. Adapted from (Collignan, 2012)	186
5.3. SSNV process diagram	188
5.4. Properties and Characteristics	192
5.5. Desirability function for Pr_1 and Pr_2	192
5.6. Evaluated desirabilities of Properties by the variation of their Characteristics . . .	194
5.7. Extract of a graph connecting a Characteristic with Properties	195
5.8. Propagated desirability function for Ch_1	196
5.9. Iteration loop	199
5.10. Analysis approach for solving convex MCDM	200
5.11. Schema of the iterative pre-sizing routine	202
5.12. Evolution of desirabilities through the iterative process	205
5.13. Evolution of the desirability indexes through the iterative process	206
5.14. Evolution of desirabilities thought the iterative process in a constrained situation	208
5.15. Non-convex aggregation figures	210
5.16. Synthesis-Analysis approach for solving non-convex MCDM	211
5.17. Analysis approach used in the convexification operation	212
5.18. Evolution of desirabilities of Characteristics through the iterative process	214
5.19. Evolution of the desirability of the Property	215
5.20. Distribution of possible solutions of the problem after the convexification process	216
5.21. Evolution of desirabilities of Characteristics on analysis part of non-convex evaluations	217
5.22. Evolution of the desirability indexes through the iterative process on non-convex problem	218
5.23. Distribution of possible solutions of the problem after the convexification process for 4 Properties	220
5.24. Evolution of the desirability indexes through the iterative process on non-convex problem of two Properties	221
5.25. Evolution of the desirability of Properties in non-convex situations with a bad definition of iteration loop	222
5.26. Evolution of the desirability indexes through non-convex problems using modified design loop	223
5.27. Interactive design methodology	224
6.1. Design methodology proposal	227

6.2. Representation of a standalone photo-voltaic system	229
6.3. Types of rural houses on Benin. Taken from (Semassou, 2011)	230
6.4. EFA for economic viability	232
6.5. Desirability of certain Properties	234
6.6. Traceability framework: CR to Pr	235
6.7. FBS + CPM for Pr_1 - cost of investment (CoI)	237
6.8. Traceability tree of a SAPVS design	239
6.9. Connections between Properties with N_{PV} and N_{bat}	241
6.10. Equaliser of the quantity of batteries (N_{bat}) after DCS_0	243
6.11. Equaliser of the quantity of PV modules (N_{PV}) after DCS_0 modified	243
6.12. Evidence of non-convexities in the problem	247
6.13. Desirability of T_{bat} in Loop 1	249
6.14. Desirability of N_{bat} in Loop 1	249
6.15. Desirability of T_{PV} in Loop 1	250
6.16. Desirability of N_{PV} in Loop 1	250
6.17. Desirability of N_{bat} and N_{PV} on Loop 2	252
6.18. Desirability of N_{bat} and N_{PV} on Loop 3	253
6.19. Evolution of the desirabilities of the SAPVS system through iterations	255
6.20. Aggregated properties desirability evolution through iterations	256
6.21. Equaliser of the quantity of batteries	257
6.22. GDI Evolution of modified SAPV problem	259
7.1. Interactive framework equaliser in multi-touch surface	267
A.1. LS4: Stand by in use	288
A.2. Property desirability for the system	291
A.3. Function Block Diagram for cooler and Pr_1 extraction	292
A.4. Wall disposition	293
A.5. Error evolution of the iterative process	296
A.6. CPM representation for Pr_1	298
A.7. Extract of CTOC + FBS diagram for Pr_1	301
A.8. CPM representation for Pr_2	302
A.9. Geometric representation	302
A.10. Lateral section of the cooler	302

A.11. Traceability tree of the cooler	306
A.12. Traceability graph	306
A.13. Rel_6 tree	307
A.14. Rel_1 tree	308
B.1. Multi-touch table at Universidad EAFIT	309
B.2. Interactive framework credits	310
B.3. Interactive framework homepage	311
B.4. Interactive framework traceability tree	311
B.5. Interactive framework traceability tree detail	312
B.6. Interactive framework equaliser	312
B.7. Website home	314
B.8. Properties menu	315
B.9. Characteristics menu	316
B.10. Characteristics menu with modification framework	317
D.1. EFA for energy provided	325
D.2. EFA for environmental viability	326
H.1. Properties' desirability evolution in scenario 1	348
H.2. GDI evolution in scenario 1	349
H.3. Properties' desirability evolution in scenario 2	350
H.4. GDI evolution in scenario 2	350
H.5. Properties' desirability evolution in scenario 4	351
H.6. GDI evolution in scenario 4	352

List of Tables

1.1. Poids des chemins entre Pr_1 and H_C	34
1.2. Ψ' tableau de décision	35
1.3. Analyse de sensibilité globale de la glacière portable	36
1.4. Niveau de complexité des Propriétés χ de la glacière	37
1.5. Intervalles de désirabilité des Propriétés	38
1.6. Niveau de désirabilité de la solution avec le layout préliminaire et le layout modifiée.	39
1.7. Exemple de propagation : Valeurs des Caractéristiques	43
1.8. Comparaison de valeurs entre solutions	48
1.9. Valeurs des Propriétés pendant le processus itératif	54
1.10. Valeurs des Caractéristiques dans le problème convexifié	59
1.11. Cahier de charges fonctionnelles pour le SAPV	63
1.12. Variables liées au module PV	65
1.13. Valeurs du layout préliminaire : DCS_0	66
1.14. Désirabilité des Propriétés au layout préliminaire	66
1.15. Valeurs des Caractéristiques du partie exploratoire	68
1.16. Évolution de la désirabilité des Propriétés pour l'approche exploratoire	68
1.17. Résultats de l'analyse de sensibilité global du SAPV	69
1.18. Niveau de complexité χ des Propriétés du SAPV	70
1.19. Valeurs des Caractéristiques pour la boucle 1	74
1.20. Valeurs des Caractéristiques pour la boucle 2	75
1.21. Valeurs des Caractéristiques pour la boucle 3	75

1.22. Valeurs de la Caractéristique qui maximisent l'a désirabilité du SAPV	76
1.23. Désirabilité des Propriétés après 21 itérations	76
3.1. Approaches boarded at interaction among design objectives	119
3.2. Approaches boarded multidisciplinary design	126
4.1. Properties and Functions [Pr2Fn]	146
4.2. QFD extract: Customer Requirements and Properties [CR2Pr]	146
4.3. Functions and Relations [Rn2Rel]	147
4.4. Properties and Relations [Pr2Rel]	148
4.5. Relations to Characteristics and External Conditions [Rel2Var]	152
4.6. Weight of paths between Pr_1 and H_C	165
4.7. Ψ' decision chart	168
4.8. Global sensitivity analysis of portable cooler	170
4.9. Complexity level of Properties χ of cooler design case	171
4.10. Intervals of desirability of Properties	172
4.11. Desirability level of the solution with Preliminary layout	173
4.12. Desirability level of the solution after th_A modification	174
5.1. Propagation example: Values of Characteristics	192
5.2. Comparison of values between solutions	197
5.3. ζ_i index of portable cooler Characteristics	198
5.4. Properties values on preliminary layout	204
5.5. Properties values after the iterative process	206
5.6. Values of the Characteristic on constrained problems	209
5.7. Properties values after the iterative process after constraining th_B	209
5.8. Properties' values after convexification	215
5.9. Values of the Characteristics in the convexified problem	215
5.10. Percentage of solutions within desirability range	217
5.11. Properties values after the application of the SSNV method	218
5.12. Values of the Characteristic that maximise desirability	218
5.13. Percentage of solutions within desirability range for non-convex problem of two Properties	220
5.14. Properties values after the SSNV application for non-convex problems using mod- ified design loop	223

5.15. Values of the Characteristic that maximise desirability for non-convex problems using modified design loop	223
6.1. Product Design Specifications of SAPV system	233
6.2. Customer Requirements to Properties for the SAPVS design case	234
6.3. Variables related to Pr_1 : Initial investment cost	237
6.4. Variables related to the PV module	240
6.5. Values of the preliminary layout: DCS_0	242
6.6. Properties desirability on Preliminary layout	242
6.7. Properties desirability evolution on exploratory approach	244
6.8. Values of the Characteristic on exploratory mode	244
6.9. Global sensitivity analysis of SAPV system	245
6.10. Complexity level of Properties χ of SAPVS design case	246
6.11. Values of the Characteristic on loop 1	251
6.12. Values of the Characteristic on loop 2	252
6.13. Values of the Characteristic on loop 3	253
6.14. Values of the Characteristic that maximise desirability of the SAPV system	254
6.15. Properties desirability results after 21 iterations	254
6.16. Modified acceptance levels of some Properties	258
6.17. Values of the Characteristic of modified SAPV problem	258
6.18. Properties desirability of modified SAPV problem	259
6.19. Comparison of the obtained solutions by the modification of the input of the method	260
A.1. Customer Requirements list	288
A.2. Life situations of portable cooler	288
A.3. Service and constraint functions on usage stage of portable cooler	289
A.4. Properties and CdCF	289
A.5. Matrix 1: QFD extract of the cooler	290
A.6. Properties to functions of cooler	290
A.7. Intervals of desirability of Properties	291
A.8. Values of temperatures	296
A.9. Functions to Relations of cooler	300
A.10. Properties to Relations of cooler	300

A.11. Relations to sub-relations of cooler	303
A.12. Relations to Characteristics of cooler	304
A.13. Relations to External Conditions of cooler	305
A.14. Characteristics and External Conditions intervals	308
C.1. Constants for lead–acid battery	322
E.1. Variables related to Pr_2 : Component replacement cost	330
E.2. Variables related to Pr_3 : Maintenance and repair costs	331
E.3. Variables related to Pr_4 : cost related to the unavailability of the system	331
E.4. Variables related to Pr_5 : Internal Rate of Return	332
E.5. Variables related to Pr_6 : Energy outage rate	334
E.6. Variables related to Pr_7 : Temporal outage rate	334
E.7. Variables related to Pr_8 : Environmental impact indicator	335
E.8. Variables related to Pr_9 : Energy Return Time	336
E.9. Variables related to Pr_{10} : Emission of CO ²	337
E.10. Adjacent Properties: Sensitivity to climatic uncertainties	338
F.1. Variables related to the batteries	339
F.2. Variables related to the inverter	340
F.3. Variables related to the cables	341
F.4. Variables related to the External conditions	341
G.1. Properties values	344
G.2. Properties desirability	345
H.1. Values of the Characteristic on scenario 1	348
H.2. Values of the Characteristic on scenario 4	349

Première partie

Résumé substantiel en français

Liste des notations

Liste des sous-index :

l :	Quantité de <i>Customer Requirements</i>
j :	Quantité de Propriétés
i :	Quantité de Caractéristiques
k :	Quantité de Relations et sous-relations
m :	Quantité de Conditions Externes
h :	Quantité de Design Characteristic Spaces

Lettres grecques utilisées :

μ	Fonctions d'adhésion pour noter la désirabilité
ρ	Influence de la caractéristique sur la propriété de GSA
ζ	Somme de la valeur absolue de ρ de la caractéristique
ψ	Somme normalisée des poids de chemin entre deux éléments
ξ	Complexité de la résolution d'une Propriété

Liste des abréviations utilisées :

<i>AFE</i>	Analyse Fonctionnelle Externe
<i>AFI</i>	Analyse Fonctionnelle Interne
<i>ASG</i>	Analyse de Sensibilité Globale
<i>ASL</i>	Analyse de Sensibilité Locale

<i>AV</i>	Analyse de Valeur
<i>CdCF</i>	Cahier des Charges Fonctionnelle
<i>CPM</i>	Modélisation de Caractéristiques-Propriétés
<i>DCS</i>	Espace de Caractéristiques de Conception
<i>DDF</i>	Fonctions de Désirabilité Dynamique
<i>FBD</i>	Function Block Diagram
<i>FBS</i>	Fonction-Comportement-Structure
<i>GDI</i>	Index de Désirabilité Global
<i>OIA</i>	Observation-Interprétation-Agrégation
<i>PDD</i>	Développement Piloté des Propriétés
<i>PRCC</i>	Indices de Corrélacion de Rangs Partiels
<i>PV</i>	Photo-Voltaïques
<i>QFD</i>	Quality Function Development
<i>SAPV</i>	Système Photo-Voltaïque Autonome
<i>SSNV</i>	Valeur nominale étagée structurée

1.1. Introduction général

Les processus de prise de décision de la conception fréquemment défient aux concepteurs de gérer les priorités entre spécifications et variables de conception afin de développer des solutions plus proches des exigences du produit. Néanmoins, de nombreux des systèmes de prise de décision sont concentrés dans les dernières étapes de la conception, tels que la conception détaillée et la conception de fabrication, même si la possibilité d'influencer un nouveau produit est plus élevée au début de la conception (Wang et al., 2002).

Les problèmes liés aux situations de prise de décision sont souvent liés à la nature multidisciplinaire de la conception. La modification de variables géométriques ayant une incidence sur les performances d'une solution. Par conséquent, le fait de suivre l'évolution de ces modifications pourrait générer un retraitement et une perte de temps. Le processus manuel de suivi des modifications afin de vérifier l'impact sur la conception conduit à un retraitement, en particulier lorsque les relations entre les variables sont complexes et difficiles à identifier en analysant les équations. Cela conduit à une analyse manuelle des besoins. Le problème est même complexe lorsque plusieurs solutions optimales peuvent être déterminées pour la solution de la conception.

L'un des objectifs préliminaires de cette recherche est un modèle de traçabilité. Le modèle comprend une structure permettant de gérer les exigences de conception d'entrée (dans le champ linguistique) jusqu'à la définition des variables (dans le champ des nombres réels). Cela permet aux

concepteurs de comprendre le lien entre les objectifs de conception et les variables de conception, à tout moment.

Basé sur la disponibilité des informations sur la relation entre les objectifs et les variables, il est prévu à générer un outil d'aide à la prise de décision destinée aux ingénieurs-concepteurs, lorsqu'il est nécessaire d'améliorer une spécification de conception donnée ou de modifier une variable sans affecter les performances du produit. L'objectif principal de cette thèse est de générer une méthode permettant d'obtenir un compromis entre l'agrégation des objectifs de conception, en modifiant les valeurs des variables de conception dans une conception multidisciplinaire.

1.1.1. Contexte de la recherche

1.1.1.1. Principes de base du contexte de conception de produits

Les deux théories de conception les plus utilisées sont la conception systématique et la conception axiomatique. L'approche de conception systématique est basée sur l'analyse des besoins du client et sur la décomposition séquentielle de ses besoins, où le problème est résolu en suivant cette décomposition par étapes et en résolvant chaque étape à la fois (Pahl et al., 2007). Le processus peut être suivi en utilisant différents outils pour chaque étape et en préparant les livrables pour chaque étape (Voir la Figure 1.1).

En ce qui concerne la conception axiomatique, elle est centrée sur l'analyse de la transformation des besoins des clients en variables de processus, en soutenant l'analyse et le processus de décision en utilisant deux axiomes : L'axiome de l'indépendance et l'axiome du contenu de l'information (Suh, 1990).

Certains auteurs (Drăghici and Banciu, 2007; Tate, 1999; Scaravetti, 2004) ont fait des comparaisons entre les deux approches. Les différences les plus importantes entre les deux théories sont :

- Dans la conception systématique, une fonction principale est déclarée et les sous-fonctions sont définies pour satisfaire la fonction principale. Dans la conception axiomatique, l'ensemble des exigences fonctionnelles sont considérées pour être satisfait par son paramètre de conception.
- La conception systématique est mise en avant dans les flux opérationnels et l'identification des changements, tandis que dans la conception axiomatique, l'objectif est de développer des solutions créatives : le premier est orienté vers le ré-aménagement des exigences fonctionnelles tandis que dans le second, il y a d'une synthèse des solutions permettant de

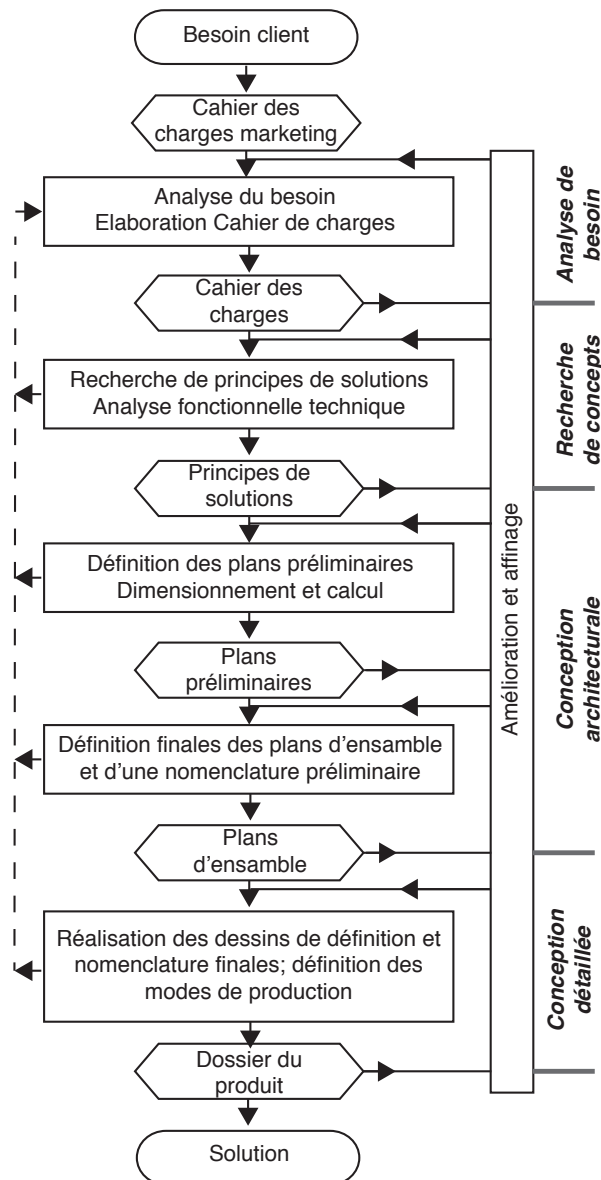

Figure 1.1 : Méthodologie de conception systématique. Adapté (Pahl et al., 2007)

développer différentes variantes de conception.

- La comparaison entre les deux détermine que la conception systématique permet d'étudier les relations entre les fonctions et les composants d'un produit. Cela permet d'optimiser le concept de produit en minimisant les fonctions techniques sans valeur ajoutée.
- La conception axiomatique est basée sur la décomposition hiérarchique : elle résout une fonction produit générale pour continuer vers les plus basses. Ceci établit des relations entre les fonctions et les solutions.

- Alors que la conception relie les domaines fonctionnel et physique à chaque niveau de la hiérarchie, la conception systématique permet une décomposition vers le bas de la fonction principale avant de s'approcher de la solution finale.

Les deux approches sont utilisées pour aborder un nouveau projet de conception. Cette thèse s'appuiera sur la conception systématique, notamment par la nomenclature des phases de conception, le traitement des flux et les interactions entre les fonctions

En ce qui concerne le positionnement de la thèse, la Figure 1.2 montre les limites de la méthode proposée et la relation avec les étapes de la conception dans la conception systématique. À cet égard, l'entrée principale est la liste des exigences, qui est un produit livrable fourni par les départements marketing. Le résultat à enrichir est lié à des valeurs pré-dimensionné calculés pour la solution qui répondent aux objectifs de conception.

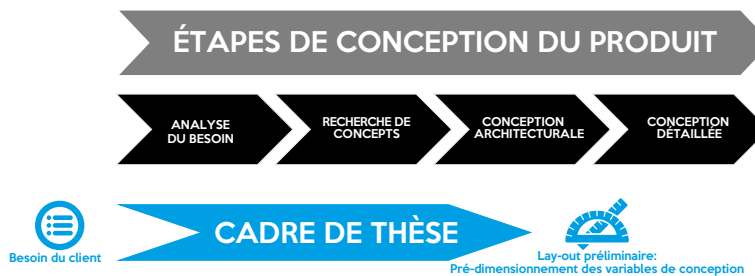

Figure 1.2 : Positionnement de la thèse

1.1.1.2. Outils et méthodes dans les processus de conception

Le travail de conception est centré sur l'utilisation d'outils et de méthodes qui aident les concepteurs dans le processus de prise de décisions. Le besoin qui déclenche le développement d'un nouveau produit est analysé à travers une liste d'exigences, résultant de la recherche marketing. Cette analyse permet d'écrire des fonctions et des spécifications en termes de relation entre le produit et l'environnement (Scaravetti et al., 2005).

En tant que exemple de processus de conception d'un conteneur pour garder les boissons frais dans un endroit chaud, la première étape consiste à rechercher les besoins de l'utilisateur. Le résultat de cette tâche est une liste d'exigences, avec des exigences telles que le conteneur doit être grand ou léger. L'équipe de conception commence à analyser ces informations et à prendre des décisions, qu'elles soient basées sur leur expérience ou sur d'autres sources d'informations (telles que l'analyse comparative). Finalement, les concepteurs définissent les spécifications qui répondent à ces exigences, c'est-à-dire rédigent des spécifications en termes de volume et de poids

du produit. Cette étape est liée à *l'analyse de besoin* et le résultat est la déclaration du Cahier des Charges Fonctionnelle (CdCF).

Ensuite, les concepteurs définissent plusieurs aspects techniques du produit, en termes de comportement qui détermine ceux qui peuvent être caractérisés en variables de conception (équations qui déterminent le volume et le poids du produit). Ceci conduit à l'apparition de variables de conception (longueur, hauteur et épaisseur). En fonction des valeurs attribuées à ces variables, le produit pourra répondre aux spécifications de conception. Enfin, en explorant différentes possibilités, les concepteurs doivent déterminer la valeur finale et les associer à différentes Caractéristiques géométriques. Ces étapes sont liées aux phases de *recherche de concepts* et *conception architecturale*. Au cours du processus de conception, les informations évoluent de données linguistiques à des données numériques. Pendant que ce processus se produit, l'imprécision de la conception diminue. Ce processus permet aux concepteurs d'arriver à des solutions consistantes (Giachetti and Young, 1997).

Néanmoins, les concepteurs doivent en quelque sorte anticiper les conséquences de leurs premières décisions sur les performances du produit. Même si des méthodologies de conception sont développées pour réduire ce manque de prise de conscience dans la prise de décision (Giachetti et al., 1997), cette incertitude est liée à la prise de décision en conception, en tant qu'une des Caractéristiques principales de la profession elle-même prédire (Clarkson et al., 2004).

Si l'on considère les premiers cours de conception, il faut se rappeler que près de 80% des décisions sont prises à cette étape, même si la disponibilité des outils informatiques n'est pas élevée (Giachetti et al., 1997). En ce qui concerne la gestion des connaissances, de nombreuses approches de conception n'avaient pas pleinement pris en charge la conception initiale. La raison en est le manque de connexion entre les exigences externes et les variables de conception, ce qui a également un impact sur l'incertitude qui se propage à travers la conception.

En ce qui concerne l'utilisation de certains outils pour les processus de prise de décision en conception, certaines utilisations peuvent être résumées comme suit :

1.1.1.3. Analyse du besoin

Dans la première partie des premières étapes de la conception, le concepteur accomplit plusieurs tâches afin de traduire les informations linguistiques en exigences techniques. Des outils tels que QFD (Quality Function Development) sont utilisés pour effectuer cette action, en reliant les exigences (variables linguistiques) aux spécifications (variables objectives) (Prasad, 1998). Néanmoins, QFD peut présenter plusieurs problèmes de subjectivité. Même dans certaines méthodes, il

est utilisé comme moyen de prendre en charge la hiérarchisation des Caractéristiques de conception technique, une analyse plus approfondie est nécessaire pour achever la traduction des variables linguistiques.

Ensuite, pour générer les spécifications des produits, l'Analyse Fonctionnelle Externe (AFE) est utilisée pour étudier les relations entre le produit et l'environnement (Scaravetti et al., 2005). Cette AFE se concentre sur la rédaction de spécifications de produits en termes de fonctions et leurs résultats sont consignés dans le CdCf. Dans ce document, les exigences du produit sont liées aux fonctions. Chaque fonction doit inclure ses critères et son niveau d'acceptation sur la base des résultats d'une Analyse de Valeur (AV). Le CdCF permet d'évaluer les objectifs du projet et de rechercher des concepts et des solutions (Martin et al., 2004).

Sur la Figure 1.3, on peut observer l'évolution de l'information entre variables linguistiques en variables d'intervalle dans cette phase de conception. Il est important de noter que l'entrée de la conception est le Cahier de charges marketing et la sortie de cette étape est le CdCF.

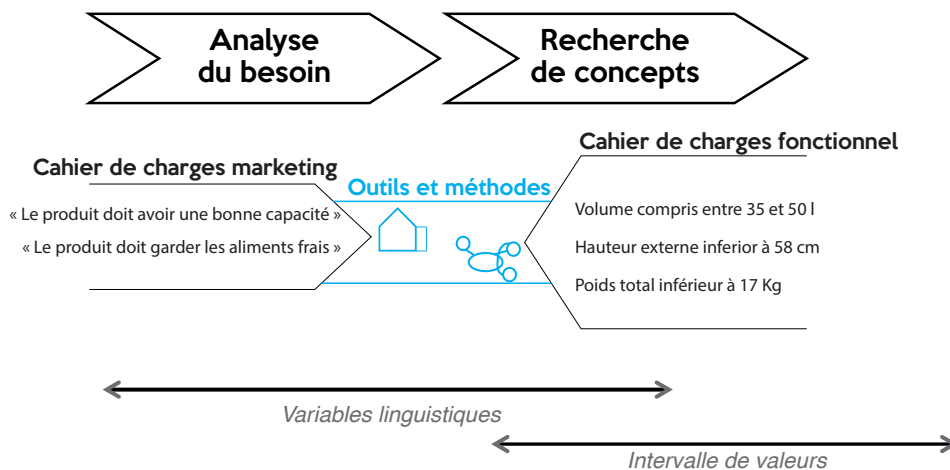

Figure 1.3 : Évolution de la conception dans l'analyse du besoin

1.1.1.4. Recherche de concepts

Cette deuxième étape est centrée sur la définition de concepts qui remplissent le CdCF. Dans cette situation, il est nécessaire d'analyser différentes fonctions afin de permettre aux concepteurs de traduire les besoins en produits en structures physiques. Plusieurs approches peuvent être répertoriées comme des fonctions affaiblissantes. Par exemple, Gero (1990) propose l'une des approches les plus utilisées appelée Fonction-Comportement-Structure (FBS).

Le cadre FBS permet de comprendre la transformation des fonctions en équations. Avec cette

méthode, la fonction est définie en comprenant les besoins et le comportement d'un système. Le comportement est centré sur la description des attributs attendus dérivés de la structure et la structure est liée aux composants de la solution (Gero, 1990).

Cette modélisation de fonction peut être accompli par des méthodes de décomposition fonctionnelle. Une approche qui prend en charge cette modélisation de fonction est le CTOC (Converter-Transmitter-Operator-Control)(Pailhès et al., 2011). Cette approche comprend chaque flux comme un ensemble CTOC, déterminant les surfaces fonctionnelles dans le produit et les mécanismes de retour de l'information de chaque flux entrant dans le système. L'utilisation permet de simplifier les fonctions en comprenant comment se transforme l'énergie et quelles sont les surfaces qui agissent dans le processus.

L'objectif de la phase de conception conceptuelle est de générer un schéma fonctionnel(FBD¹). Il contient toute l'information sur les flux d'énergie, de matière et d'information, ainsi que ses relations avec les fonctions. Sur la Figure 1.4, on peut voir comment l'évolution de l'information se produit du domaine linguistique au domaine physique (formes).

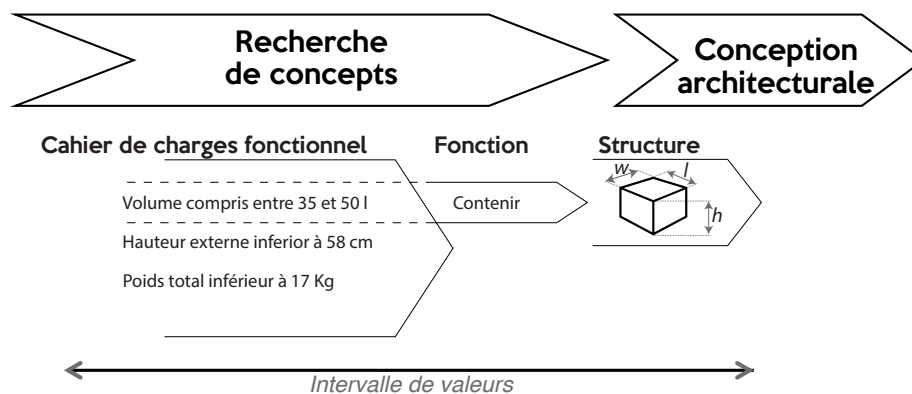

Figure 1.4 : Évolution de la conception dans la recherche de concepts

1.1.1.5. Conception architecturale

La conception architecturale est développée sur la base des concepts sélectionnés, sur la résolution du problème de conception. Pour cette étape, deux approches différentes peuvent être définies : « *analyse et synthèse* ». L'analyse a lieu lorsque les variables de conception sont définies et que leur comportement est compris. Ensuite, les objectifs de conception peuvent être déterminés. La synthèse se passe de l'autre côté. Les objectifs de conception sont connus et les variables

¹Function Block Diagram en anglais

de conception sont établies à partir de prédictions liées au comportement de l'objectif (Tomiyama et al., 2009). Comprendre quand utiliser ces approches détermine une forte capacité d'adaptation pour aborder un processus de conception.

En ce qui concerne les approches d'analyse, les équations qui caractérisent le problème de conception sont résolues. Les concepteurs définissent différentes valeurs et évaluent à l'aide de modèles comportementaux si cette combinaison de variables de conception produit un résultat approprié pour l'objectif de conception. En analyse, différentes approches peuvent être utilisées pour saper des solutions, telles que la simulation numérique, le calcul et les maquettes virtuelles, entre autres. De nombreuses techniques de résolution de projet peuvent être considérées comme des techniques d'analyse.

La disponibilité des techniques de synthèse n'est pas aussi élevée que celle de l'analyse, où les techniques les plus pertinentes sont les processus de synthèse automatisés.

Par exemple, des approches combinatoires sans restriction peuvent être utilisées pour déterminer une solution. Néanmoins, ces approches telles que le Problème de Satisfaction des Contraintes, prennent énormément de temps. Cette méthode permet de rechercher de manière exhaustive toutes les solutions possibles dans une intervalle (Scaravetti, 2004). Le défi est centré sur la définition des contraintes qui régissent la solution de conception et la nature des variables qui affecteront la conception finale (Yvars, 2009).

Une autre méthode, est le CPM/PDD proposée par Weber (2005). Cette méthode est composée de la Modélisation de Caractéristiques-Propriétés (CPM) et du Développement Piloté des Propriétés (PDD). C'est une méthode qui permet de connecter l'ensemble des informations générées lors de la conception préliminaire, en fournissant des explications sur les connexions entre les éléments d'information générés lors d'un processus de conception de produit (Weber, 2005, 2007).

Néanmoins, des auteurs tels que Malmiry et al. (2016) ont mis au point des méthodologies de conception centrées sur l'utilisation du CPM/PDD, appuyées par CTOC et FBS, montrant comment l'assemblage de ces outils peut être réalisé dans une nouvelle méthodologie de développement de produits (Malmiry et al., 2016). De plus, l'utilisation de graphiques et l'intégration au CPM/PDD permettent de proposer l'intégration d'une approche de synthèse / analyse. La synthèse est utilisée pour la modélisation du produit et l'analyse pour évaluer l'impact des objectifs de conception, sur la base de la modélisation fonctionnelle de l'approche FBS (Ríos-Zapata et al., 2017a).

Finalement, l'objectif de la conception architecturale est de déterminer les valeurs initiales

des variables de conception. Ce processus de définition des valeurs de conception s'appelle le pré-dimensionnement. Il constitue la dernière tâche de la conception préliminaire et détermine le début de la conception détaillée. La Figure 1.5 montre comment les informations évoluent en fonction d'attributs géométriques.

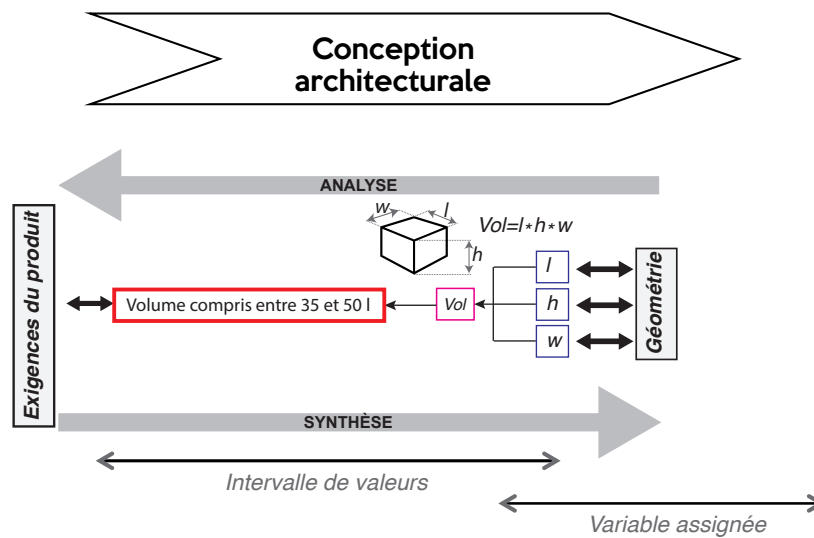

Figure 1.5 : Évolution de la conception dans la conception architecturale

1.1.2. Justification de la recherche

1.1.2.1. Contexte de la recherche

L'un des aspects les plus naturels de la prise de décision en conception est le rappel de toute interaction inattendue, ce qui signifie que la modification d'une « *variable de conception* » n'affectera pas négativement les « *objectifs de conception* ». La gestion de cette incertitude type aux premiers stades de la conception est l'une des principales facettes à étudier dans le contexte du XXI^e siècle. De nos jours, les approches sont axées sur la stimulation du développement de nouvelles technologies pour la conception préliminaire, où l'arrivée de nouveaux outils a été constante au cours des dernières décennies. De même, son utilisation est fortement motivée par l'automatisation de différentes tâches au cours de ces étapes de conception (Robertson and Radcliffe, 2009a) et par une économie de temps et d'argent ainsi (Valle and Vázquez-Bustelo, 2009).

En ce qui concerne cette thèse, ce projet a été développé conjointement par l'Institut de Mécanique et d'Ingénierie I2M-IMC, Arts et Métiers ParisTech à Bordeaux (France) et le Groupe

de Recherche en Ingénierie de Conception (GRID) de l'Universidad. EAFIT à Medellín (Colombie). Dans l'I2M, certains projets avaient contribué à soutenir le développement de processus multidisciplinaires. Cette thèse est liée aux travaux de Collignan (2012) et Malmiry (2016).

Collignan (2012) présente une méthode de prise de décision pour sélectionner une solution de conception. Cette méthode s'appelle Observation-Interprétation-Agrégation (OIA) : O pour l'observation et est liée au comportement du produit, I pour l'interprétation et est liée aux préférences subjectives des concepteurs et A pour l'agrégation et est liée aux approches de pondération. Cette méthode permet d'utiliser des fonctions de désirabilité pour comprendre la flexibilité des objectifs de conception et leur relation avec les échelles de qualification linguistiques (Collignan, 2012).

En ce qui concerne Malmiry (2016), il présente une approche de modélisation robuste axée sur la gestion de l'incertitude et de la complexité et axée sur l'optimisation du produit. Ce travail est centré sur le CPM/PDD et étudie comment les connexions de l'information, du processus d'évolution des exigences linguistiques jusqu'aux valeurs réelles liées aux attributs géométriques, peuvent être utilisées pour améliorer une conception. Le processus d'optimisation est centré sur une fonction spécifique d'un produit dans le but d'augmenter la valeur d'un produit (Malmiry, 2016).

Cette thèse est centrée sur le développement d'une méthode de conception capable de prendre en charge des processus de conception multidisciplinaires et d'améliorer un produit en calculant la meilleure combinaison de variables de conception permettant de maximiser la désirabilité de l'objectif de conception. Cependant, la définition des meilleures valeurs de variables de conception est une tâche très incertaine, notamment parce qu'on ne sait pas si la modification d'une variable aura une incidence sur les objectifs de conception. La gestion de cette incertitude joue également un rôle important de comment procéder avec les processus de prise de décision.

Les concepts d'incertitude et de traçabilité dans la conception

L'évolution de l'information résulte de plusieurs processus de prise de décision. Cela permet de noter l'évolution des variables ayant des attributs linguistiques jusqu'à des quantités capables de représenter des formes géométriques de conditions physiques. Afin de gérer ces informations, il est important de comprendre les processus de génération d'informations afin qu'ils puissent être organisés, stockés et exploités.

Pour définir le type d'informations générées et gérées, il est nécessaire de comprendre qui les génère, quelles informations sont générées, pourquoi et quelles sont les informations nécessaires aux autres membres de l'équipe de développement. Ce processus conduit à une complexité de

la gestion de la conception. Chaque fois que cette information n'est pas disponible, le niveau d'incertitude est augmenté en raison des hypothèses qu'il faut prendre en compte (Danilovic and Sandkull, 2005).

Dans les activités de conception, deux types d'incertitude peuvent être décrits : aléatoire et épistémique. Aléatoire est lié au caractère naturel des Caractéristiques et des Propriétés physiques du produit. L'épistémique est liée à l'imprécision due au manque de connaissances (Malak et al., 2009). La compréhension de l'incertitude épistémique joue un rôle important dans la gestion de l'incertitude. Avoir la possibilité d'anticiper différents types de situation détermine un avantage dans le processus de prise de décision. À cet égard, CPM/PDD est utilisé pour interpréter les fonctions et leurs définitions en équations, permettant ainsi de comprendre l'incertitude en tant que gère : Caractéristiques, Propriétés, relations, conditions externes, conditions de modélisation et Propriétés requises (Malmiry et al., 2016).

Tout ce processus d'évolution de l'information dans la conception préliminaire pose plusieurs questions, telles que : « *comment toutes les informations sont-elles stockées ?* », « *existe-t-il des liens de connexion entre ces types d'informations ?* » et « *comment les designers ont pris leurs décisions ?* »

On peut en déduire qu'il doit exister une relation entre les objectifs de conception et les variables, relations permettant de reconnaître l'évolution du produit entre la tâche et la solution finale. Selon l'IEEE (1990) le degré des relations qui peuvent être établies entre deux ou plusieurs éléments, en particulier lorsqu'un élément est prédécesseur d'autres éléments, peut être appelé « *traçabilité* » (IEEE, 1990).

L'importance d'avoir des informations très détaillées déterminent le niveau d'intégration du modèle de traçabilité, ce qui permettra une granularité des relations entre les différents types d'informations (Königs et al., 2012). Cela permet de comprendre pourquoi un modèle de traçabilité doit identifier les éléments potentiellement affectés par une modification de leurs connexions. Il est important de définir comment la dépendance est déterminée dans la conception, ce qui se mesure sous trois aspects (Ouertani et al., 2011) : i) variabilité : comment sont définies les exigences ? ii) sensibilité : quel est le risque dans la conception en cas de changement ? iii) intégrité : des connaissances sont nécessaires pour accomplir la tâche ?

Problèmes de conception convexes et non convexes

Dans les problèmes d'optimisation de la conception, deux types de problèmes peuvent survenir : les problèmes convexes et non convexes. D'une part, les problèmes convexes, il n'existe qu'un seul

maximum. En d'autres termes, si un minimum local est calculé, le minimum global est obtenu (Bertsekas et al., 2003) (Voir la figure 1.6a pour une représentation d'un problème convexe).

D'autre part, dans les problèmes non convexes, plusieurs minimums locaux peuvent être obtenus. Cela empêche la possibilité de calculer un maximum global. Même, il y a toujours une incertitude liée à l'existence du maximum global (Panagiotopoulos, 2012) (Voir la figure 1.6b pour une représentation d'un problème non convexe avec plusieurs maximums).

Ces problèmes non convexes peuvent être traités comme des problèmes convexes si une convexification du problème est effectuée. Par conséquent, l'une des tendances de la conception consiste à mettre au point des méthodes permettant de traiter ce type de problèmes. Soit des problèmes convexes, où un optima local est un optima global, ainsi que des problèmes non convexes (Tomiya et al., 2009). Concernant les problèmes non convexes, ils peuvent être convexifiés en maintenant son minimum global, c'est-à-dire en définissant l'enveloppe convexe du problème (Bertsekas et al., 2003).

Le traitement des problèmes d'optimisation peut être traité de deux manières : optimisation mono-critère et optimisation multi-critère. D'une part, pour l'optimisation mono-critère, un algorithme calcule la réponse optimale pour la fonction objectif (Voir la figure 1.6c).

D'autre part, dans l'optimisation multi-critères, les algorithmes calculent les solutions mais c'est l'utilisateur qui sélectionne la solution finale, permettant de hiérarchiser l'objectif de conception le plus critique (Miettinen et al., 2008). L'un des outils les plus utilisés pour ce type d'optimisation est le front de Pareto, que l'on peut observer à la Figure 1.6d.

Influence de la conception interactive dans la prise de décision

De nos jours, la conception est très influencée par la prise en charge de différents types d'outils informatiques, ce qui permet aux équipes de conception de mieux gérer les informations générées et de consacrer plus de temps aux activités à valeur ajoutée qu'au détail (Robertson and Radcliffe, 2009b). Cette influence entre les outils informatiques et les activités de conception est étudiée sous le concept de « *conception interactive* ».

Ce concept est lié à l'utilisation de techniques permettant une meilleure vue d'ensemble des solutions possibles en aidant le concepteur à obtenir des informations précieuses pendant les phases d'idéation et, par conséquent, une solution adéquate permettant une meilleure compréhension de chaque solution possible et favorisant également la décision adéquate (Fischer and Nadeau, 2011; Fischer and Coutellier, 2006).

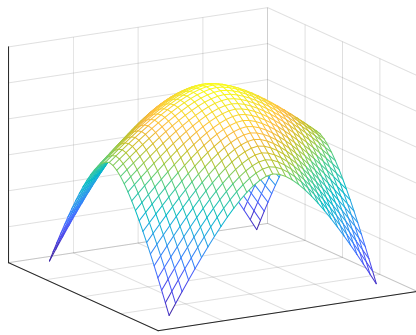

(a) Exemple de problème convexe

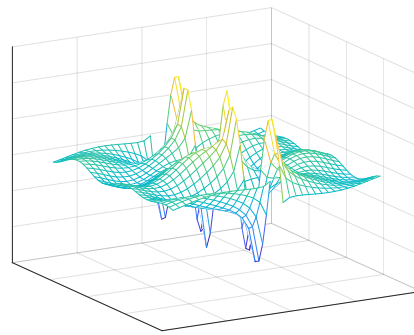

(b) Exemple de problème non-convexe

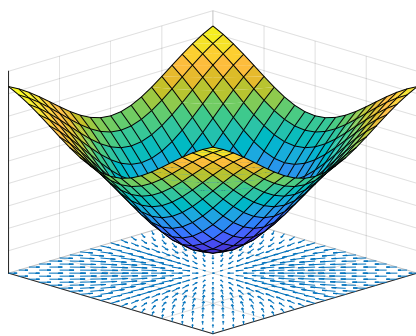

(c) Optimisation du gradient

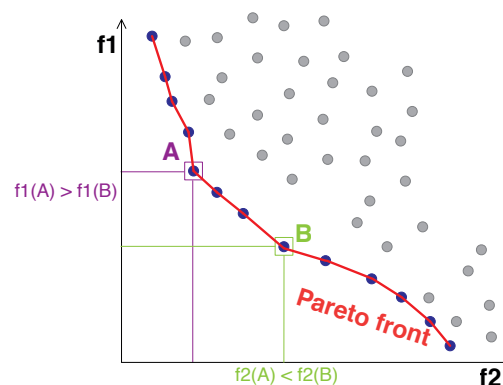

(d) Optimisation du front de Pareto

Figure 1.6 : Types d'optimisation

1.1.3. Définition du problème et questions de recherche

Le processus de conception d'un produit fait face à plusieurs étapes de corroboration, appelées processus de vérification et de validation. Il s'agit d'activités visant à garantir que les résultats de la conception répondent aux exigences en matière d'installation (exigences fonctionnelles et spécifications) font partie de la vérification de la conception, tandis que les activités menées pour garantir que le produit obtenu répond aux exigences de l'application spécifiée ou de l'utilisation prévue (besoins du client) font partie de la validation de la conception (Ferreboeuf, 2014). Alors que la vérification est liée à la manière comment chaque objectif est réalisé, la validation est liée à la manière dont l'ensemble des objectifs est remplies.

Le processus de validation dépend souvent de la modification des variables de conception afin d'obtenir une solution finale qui réponde aux besoins du client. Le problème est que ce processus de modification peut prendre beaucoup de temps, surtout lorsque les relations entre les éléments sont inconnues. En conséquence, la nécessité de générer une méthode qui sache quoi modifier et dans

quelle mesure, qu'il s'agisse d'un objectif de conception ou d'une variable de conception, devient importante dans la conception moderne. Prédire comment les décisions affecteront la conception est un des défis les plus importants de la conception multidisciplinaire (Sandberg et al., 2017).

Cela suscite une inquiétude quant à la compréhension du problème de l'ignorance de l'interaction entre les objectifs de conception et les variables de conception. Pour cette raison, il est nécessaire d'adopter un cadre capable de mesurer les relations entre les acteurs de la conception. Ce cadre doit prendre en compte les influences entre un objectif et ses variables et l'influence d'un objectif sur les autres objectifs. Cela a conduit à l'importance de la création de cadres informatiques permettant la traçabilité dans les décisions de conception (Wang, 2016).

Comme ce problème coexiste dans la conception préliminaire, où les modèles informatiques CAO ne sont souvent pas disponibles, il existe un problème de visualisation et de manipulation de l'information. Aussi, il n'existe aucun mécanisme efficace pour démarrer les connaissances et savoir comment utiliser les informations générées pour appuyer les activités de décision (Zha et al., 2008). Cela a conduit au premier problème :

Il est nécessaire d'adopter une méthode qui permette de mesurer la relation entre les objectifs de conception et les variables de conception dans des situations multidisciplinaires, afin d'évaluer l'influence d'un objectif de conception sur les autres.

Comprendre la relation entre les objectifs de conception n'est que la partie visible de l'iceberg dans les processus décisionnels multidisciplinaires. De plus, comprendre qu'il n'existe pas de solution unique à un problème multi-critères d'objectifs contradictoires (Guirguis et al., 2017), qui posent des problèmes différents. Par exemple, l'un des objectifs de la conception préliminaire est la définition des valeurs pour le pré-dimensionnement des variables.

Ce pré-dimensionnement est le résultat de la conception architecturale et le jalon final avant d'entrer dans les étapes de conception détaillée. Différentes approches peuvent être utilisées pour cette étape de vérification de la conception. Néanmoins, plus la liste d'objectifs est grande, plus il est difficile de définir les valeurs idéales pour les variables.

Dans cet environnement multi-objectif / multidisciplinaire, les techniques de pré-dimensionnement sont centrées sur la recherche de valeurs de variables optimales qui cherchent des solutions répondant aux objectifs de conception.

Néanmoins, à mesure que la complexité du problème augmente, le processus de recherche de solution est plus difficile et prend plus de temps à l'ordinateur, ce qui détermine de grands défis. Ce niveau de complexité est critique lorsque des problèmes non convexes sont résolus, en

raison de l'apparition de plusieurs solutions optimales pour la conception. Finalement, sur la base des théories de logique floue pour la représentation de l'incertitude (Nagy, 2012), le deuxième problème peut être posé comme suit :

Afin de maximiser la désirabilité des objectifs de conception, aux problèmes multidisciplinaires non convexes, il est nécessaire de développer une méthode de pré-dimensionnement afin d'offrir des solutions plus rapidement que les algorithmes de résolution conventionnels.

Cette définition automatisée des variables est capable de générer des solutions qui maximisent l'ensemble des objectifs de conception. Néanmoins, il arrive parfois qu'une équipe de conception souhaite hiérarchiser un objectif spécifique par rapport à un autre, en souhaitant que tout objectif spécifique ait une valeur plus grande de son désirabilité, quelle que soit la dégradation d'autres objectifs.

Un autre résultat de ce processus est que, pas toujours, les valeurs des variables sont liées à des valeurs qui sont devenues des contraintes dans les étapes de conception ultérieures. Par exemple, considérons qu'il existe un diamètre de trou d'une valeur de $50,108mm$. À partir de cette sortie plusieurs questions peuvent être posées : Est-ce que l'entreprise a une perceuse avec ce diamètre spécifique ? Que pourrait-il arriver au système si nous modifions ce diamètre de $50,108mm$ à $50mm$? Si nous changeons le diamètre, que devons-nous changer d'autre pour préserver une grande désirabilité de l'ensemble d'objectifs ?

En ce qui concerne ces situations, une réponse potentielle doit être liée en permettant aux concepteurs de modifier les valeurs des variables de conception.

Générer un cadre interactif lorsque les équipes de conception peuvent modifier des valeurs spécifiques sans dégradation excessive de la désirabilité du système : améliorer le processus de prise de décision en indiquant quelles modifications sont les plus appropriées.

1.1.3.1. Objectifs de recherche

Sur la base du problème, cette thèse est centrée sur le développement d'une approche interactive pouvant être utilisée dans la conception préliminaire afin de définir les valeurs des variables de conception afin de maximiser la désirabilité de l'objectif de conception. L'objectif principal est défini comme :

Développer une méthode interactive d'aide à la décision pour le compromis d'objectifs mul-

tiples dans les processus de validation de conception multidisciplinaire par la maximisation de la désirabilité global.

Objectifs de spécifiques

1. Développer une méthode interactive permettant de déterminer les informations permettant de mieux comprendre les relations entre les objectifs et les variables de conception.
2. Développer une méthode qui mesure la relation entre les objectifs de conception, les variables de conception et évalue l'influence d'un objectif de conception sur les autres.
3. Développer une méthode permettant d'assurer l'assurance de la méthode objective de conception pour le pré-dimensionnement dans des situations non-convexes/convexes.
4. Développer un cadre interactif qui indique quelle variable modifie et dans quelle mesure afin de répondre à la désirabilité de l'ensemble des objectifs de conception.

1.2. État de l'art

La recherche de l'état de l'art est divisée en trois parties :

1. Interaction entre les objectifs de conception, où les catégories suivantes ont été identifiées : hiérarchisation des objectifs de conception et des variables de conception, techniques d'optimisation pour la compréhension de l'interaction, techniques de visualisation afin de comprendre l'interaction des informations.
2. Pré-dimensionnement dans des problèmes multidisciplinaires non-convexes, où les catégories suivantes ont été identifiées : convexification de problèmes non-convexes, optimisation multidisciplinaire de problèmes non-convexes, optimisation de la fonction d'adhésion.
3. Conception interactive et amélioration de la prise de décision

1.2.1. Interaction entre les objectifs de conception

Il était trouvé que les techniques d'analyse de sensibilité étaient utilisées dans les 14,3% de la revue de littérature. Ces techniques permettent de mesurer quantitativement la performance de la solution et son évolution en fonction de la modification des valeurs des variables. Parmi les méthodes étudiées, il est important de rappeler celles qui conviennent, en fonction de la nature des données. C'est-à-dire si le comportement des données est linéaire ou non. Par exemple, les

indices de corrélation de rangs partiels sont une technique qui a fait ses preuves avec des données non linéaires (Gagnon et al., 2018), alors que de nombreuses techniques différentes sont décrites dans la littérature pour les données linéaires. Enfin, l'attribut le plus utile de ces techniques est la capacité à identifier les variables les plus importantes en termes d'influence sur les objectifs de conception.

19% des articles examinés utilisaient Pareto Front, une approche plus centrée sur l'optimisation des solutions, mais certaines de leurs résultats permettent de hiérarchiser certaines priorités. Néanmoins, l'un des plus gros problèmes avec ces techniques est liée au temps machine, en particulier pour les algorithmes de front de Pareto et les algorithmes génétiques. Ainsi que la difficulté à modifier les solutions (Lin and Gerber, 2014). De plus, Turrin et al. (2016) fournit quelques informations sur ce problème en proposant un outil informatique permettant une évaluation rapide des différentes solutions.

Près du quart des articles examinés étaient liés à l'utilisation de modèles de logique floue. Tout d'abord, il est nécessaire de soutenir que l'utilisation de modèles flous permet aux ingénieurs de comprendre l'intégration des connaissances des différentes disciplines, ce qui est essentiel pour la conception multidisciplinaire (Zha et al., 2008; Yano, 2016). En outre, un élément positif dans les modèles flous est la capacité de propager des modèles d'indépendance non redondants, non chevauchant et préférentiels (Thokala et al., 2016) Ainsi, dans les modèles flous, il est nécessaire d'être conscient de la perte d'informations qui se produit entre la conversion d'une quantité floue en un nombre réel (Ekel et al., 2016).

Finalement, des autres techniques ont été trouvées pour mesurer les interactions entre les objectifs de conception, mais ces outils ont été moins utilisés. Ces outils peuvent être énumérés comme suit : méthode des différences finies (Wang, 2014, 2016), analyse de sensibilité linéaire (Piedras et al., 2006; Gagnon et al., 2018), analyse de sensibilité non-linéaire (Gagnon et al., 2018), méthode Bellman-Zadeh (Ekel et al., 2016), analyse des éléments finis (Sandberg et al., 2017), optimisation fractale (Yano, 2016), algorithme génétique (Lin and Gerber, 2014), indices Sobol (Gagnon et al., 2018).

1.2.2. Pré-dimensionnement dans des problèmes multidisciplinaires non-convexes

Différentes techniques de convexification de problèmes non-convexes peuvent être trouvées dans la littérature (Ni et al., 2018; Bouchitté and Phan, 2017; Mao et al., 2016; Shishkin, 2017; Zhang et al., 2017a,b), ce qui détermine l'indication de la nécessité de résoudre ce type de problèmes par ces techniques. Cependant, les méthodes de convexification ne conviennent pas à

tous les types de problèmes. Chaque méthode étant adaptée à un type de problème spécifique, le défi consiste à mettre en œuvre la technique de convexification adéquate. Cela conduit à centrer l'analyse sur la littérature afin de déterminer comment l'optimisation multidisciplinaire de la conception est réalisée.

En ce qui concerne l'optimisation multidisciplinaire de problèmes non-convexes les approches les plus populaires sont le front de Pareto et les algorithmes génétiques, représentant les 43,4% des articles examinés

En ce qui concerne les algorithmes génétiques, la capacité la plus importante est de trouver le maximum global, qui peut être complété par le front de Pareto et sa capacité à identifier des solutions dans des situations à objectifs multiples. Le problème avec ces approches est qu'elles prennent trop de temps. (Yao et al., 2011).

À propos d'autres approches examinées, certaines idées peuvent être énumérées :

- L'optimisation est centrée sur les variables de pré-dimensionnement pour les dernières étapes de la conception, en particulier dans la conception détaillée (Badufle et al., 2010; Ng and Leng, 2002). Cela nous a permis de nous centrer sur les premières étapes de la conception.
- De nombreuses techniques d'optimisation visent à atteindre un maximum global, même si le temps de résolution est long (Ng and Leng, 2002).
- Les méthodes basées sur le gradient permettent au concepteur de contrôler le processus d'analyse et de centrer la recherche dans des domaines bien définis. (Mastroddi and Gemma, 2013).
- Un cadre de conception permet aux concepteurs moins expérimentés de mieux performer et plus rapidement dans différents processus de prise de décision en conception (Yang et al., 2018).
- Il serait nécessaire d'inclure un mécanisme permettant de comprendre la dégradation entre les objectifs de conception, tels que les fonctions de partage (Goldberg et al., 1987).

Finalement, à propos de l'utilisation de la logique floue pour les processus d'optimisation, elle a été utilisée pendant plusieurs décennies. Zimmermann (1975) décrit une méthode centrée sur la manière dont la logique floue peut être utilisée pour gérer l'incertitude. Le processus suivi par l'auteur caractérise les objectifs et les contraintes de conception avec une fonction d'appartenance permettant une analyse plus propre (Zimmermann, 1975).

Cette technique a évolué avec les années, introduisant différentes applications, par exemple : utilisation d'algorithmes génétiques (Goldberg et al., 1987; Kharrati et al., 2012; Song et al., 2017), introduction des Propriétés sémantiques (de Oliveira, 1999), optimisation par essais particuliers (Esmine and Lambert-Torres, 2007; Safaee and Mashhadi, 2016), logique floue dans modèles probabilistes (Yin et al., 2018).

1.2.3. Conception interactive et amélioration de la prise de décision

Des travaux ont été trouvés qui permettent aux concepteurs de comparer et d'interagir avec la solution via un environnement interactif (Bénabès et al., 2013). Cette thèse sera centrée sur l'utilisation de cette fonctionnalité, mais aussi sur l'information des utilisateurs sur la variable qui convient le mieux à la modification. Pour cette raison, il est nécessaire de rechercher différentes techniques de visualisation à cet égard. Par exemple, celles présentées par Koyama (2016) peuvent aider les concepteurs à savoir où modifier.

De plus, les travaux de Alam et al. (2015) et Gao et al. (2013) permettent de comprendre le pouvoir de l'interactivité dans la conception, en termes de réduction spectaculaire du temps. On peut analyser que l'interactivité peut réduire le temps de près de 93% (Gao et al., 2013) dans situations de conception spécifiques. Néanmoins, plus le design est complexe, plus il est difficile pour les concepteurs d'arriver à une solution « *quasi-optimale* » par essais et erreurs. De même, dans les environnements multidisciplinaires, où les problèmes ne sont pas convexes, l'attribution manuelle de variables de conception a moins de chances d'arriver à une solution sans aucun calcul mathématique.

Également, cette thèse sera centrée sur la proposition d'une approche basée sur un modèle permettant de définir des valeurs pour les variables de conception, dans des environnements multidisciplinaires avec des problèmes non convexes. L'objectif est de générer une grande désirabilité pour les objectifs de conception, mais aussi d'offrir aux concepteurs la possibilité de modifier les valeurs calculées, en suggérant de manière interactive comment produire l'impact minimal de la désirabilité de l'objectif de conception.

1.3. Interaction entre les objectifs de conception

L'objectif est de comprendre la relation entre différents objectifs de conception dans un processus de conception de produit. Cette compréhension permet d'anticiper les conséquences d'une modification de la valeur d'une variable sur les performances de la solution globale. Pour ce faire,

il est essentiel de comprendre comment l'information évolue. À cet égard, il est nécessaire d'établir une nomenclature en fonction des paramètres trouvés dans la littérature. Weber and Werner (2001) Il propose une nomenclature pour le développement de produits centrée sur la compréhension de la relation entre les variables et les objectifs pour décrire les produits et leur comportement. Ce processus s'appelle CPM/PDD. Cette méthodologie est conçue pour comprendre les liens entre les objectifs de conception et les variables. Cet aspect joue un rôle essentiel dans la conception multidisciplinaire complexe, lorsque des dizaines d'objectifs et des centaines de variables peuvent y participer.

Ainsi, la nomenclature du processus CPM/PDD sera adoptée dans cette thèse. La partie CPM, *Caractéristiques-Propriétés-Modélisation*, est une approche de modélisation et sa nomenclature est décrite comme suit : (Weber et al., 2003; Weber, 2005, 2007) :

1. *Propriétés* : ceux-ci se réfèrent aux **objectifs de conception**. Ces Propriétés sont liées au comportement du produit et aux paramètres que celui-ci doit accomplir, mais ne peuvent pas être modifiées directement par l'utilisateur (Pr_j).
2. *Propriétés Requises* : les critères de conception que le produit doit atteindre (RP_j).
3. *Caractéristiques* : les **variables de conception** indépendantes. Ce sont les variables que les concepteurs peuvent modifier pour obtenir des solutions qui répondent aux objectifs de conception. Ces Caractéristiques consistent en la structure, la forme, les dimensions, les matériaux et les surfaces d'un produit (Ch_i).
4. *Relation* : les relations entre les Propriétés et les Caractéristiques. Ceux-ci peuvent être notés comme des variables dépendantes (Rel_k).
5. *Conditions externes* : les paramètres que les concepteurs ne peuvent ni modifier ni contrôler et sont définis par un environnement externe (EC_m).

Cette nomenclature CPM est liée à la stratégie PDD (Développement Piloté des Propriétés)(Weber et al., 2004; Weber, 2014). Ce PDD permet d'aborder différentes stratégies de réalisation du nouveau processus de développement. Cette nomenclature permet de comprendre les processus d'analyse et de synthèse et la connexion entre les exigences du client et la géométrie.

Dans cette thèse, l'une des premières contributions est la proposition d'un cadre de gestion de l'information permettant de stocker et de visualiser les informations relatives à un problème de conception de produit. Pour organiser les informations, il est proposé une représentation visuelle capable de gérer l'évolution des informations depuis les exigences du client, sous forme de variables

linguistiques, jusqu'à Caractéristiques. Figure 1.7 montre comment cette évolution est suivie et comment l'information peut être adaptée visuellement à l'aide d'une structure CPM/PDD. (Ríos-Zapata et al., 2017b).

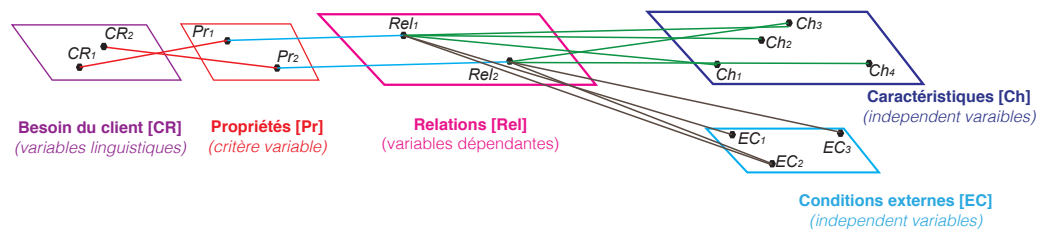

Figure 1.7 : Évolution de l'information à travers les processus de conception

Une fois que le déploiement des informations (Propriétés et Caractéristiques) est clair, il est prévu de développer une méthode permettant à l'équipe de conception de modifier les valeurs de Caractéristiques, tout en expliquant comment cette modification interagit avec les valeurs des Propriétés. Les Caractéristiques peuvent être modifiées afin de développer des solutions pouvant répondre aux objectifs de conception. Néanmoins, pour garantir une solution pouvant répondre à l'ensemble d'objectifs, la solution doit répondre aux critères de conception de l'ensemble des Propriétés.

La gestion de cette contrainte représente plusieurs défis, notamment en ce qui concerne la conception multidisciplinaire où le nombre de contradictions entre les Propriétés augmente. En outre, il est nécessaire de savoir, lors de la modification, comment elles peuvent avoir un impact sur les différents objectifs de conception. Pour faire face à ces situations, une stratégie consiste à introduire une certaine flexibilité dans les critères des objectifs de conception. Par exemple, dans la conception d'un refroidisseur portable, l'un des critères peut être défini comme "garantir une température de 10°C ".

Selon cela, définition précise d'une valeur, une solution comme $10,01^{\circ}\text{C}$ est inacceptable. Aussi une solution avec $9,99^{\circ}\text{C}$ peut être considérée comme bonne, probablement, comme une solution de 5°C . Sur la base de la compréhension des critères est défini comme température interne $< 10,0^{\circ}\text{C}$, ces trois affirmations sont vraies.

Par conséquent, l'introduction de concepts de flexibilité dans l'analyse et l'évaluation des objectifs de conception semble être nécessaire. Pour cette raison, dans le cadre de cette thèse, cette flexibilité sera abordée par l'utilisation du concept de « *désirabilité* ».

Cette opportunité peut être comprise dans la génération de fonctions pouvant être associées à

une fonction d'appartenance, qui est une valeur sans dimension comprise entre 0 et 1. Ces fonctions de désirabilité, notées avec la lettre grecque μ , sont faciles à configurer et largement utilisées dans les problèmes où la flexibilité pour l'évaluation des Propriétés est nécessaire (Pasandideh and Niaki, 2006).

Dans ces fonctions, la façon dont le résultat est interprété est basée sur la compréhension qu'une valeur de $\mu = 0$ est totalement inacceptable, alors qu'une valeur de $\mu = 1$ est tout à fait satisfaisante. Ce concept permet de résoudre le problème de flexibilité des objectifs de conception.

L'introduction de ces concepts de désirabilité, en tant qu'amplificateur de la prise de décision dans des situations multi-critères, peut être comprise dans la Figure 1.9. La proposition de cette thèse comprend une *méthode interactive exploratoire*. Dans cette méthode, l'équipe de conception peut modifier n'importe quelle Caractéristique spécifique et être immédiatement avertie de l'impact de cette modification sur les Propriétés. L'introduction de la flexibilité, accompagnée d'un code de couleur, permet au concepteur de comprendre l'impact de la modification des Caractéristiques sur la conception. Ce code de couleur peut être vu dans la Figure 1.8 et permet de comprendre que les valeurs vertes sont liées aux valeurs de désirabilité élevées, aux valeurs de désirabilité de rouge à mauvais et aux valeurs de désirabilité de noir à nul.

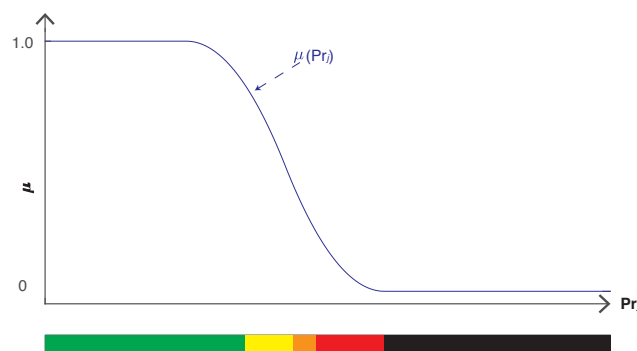

Figure 1.8 : Interprétation de la fonction d'adhésion en couleurs

La Figure 1.9 présente un diagramme en forme d'égaliseur utilisant des intervalles visuels pour faciliter la prise de décision des concepteurs. Dans ces diagrammes, une équipe de conception peut modifier manuellement une Caractéristique et comprendre l'impact de cette modification sur la conception.

De la Figure 4.5, la définition de Ch_i dans une valeur proche de 2,2 permet d'avoir une opportunité "verte" sur la désirabilité de toutes les Propriétés. De plus, une valeur de Ch_i proche de 1 déterminera une opportunité nulle pour P_{r_3} . Ce diagramme en forme d'égaliseur indique rapidement à l'équipe de conception que ces valeurs doivent être évitées.

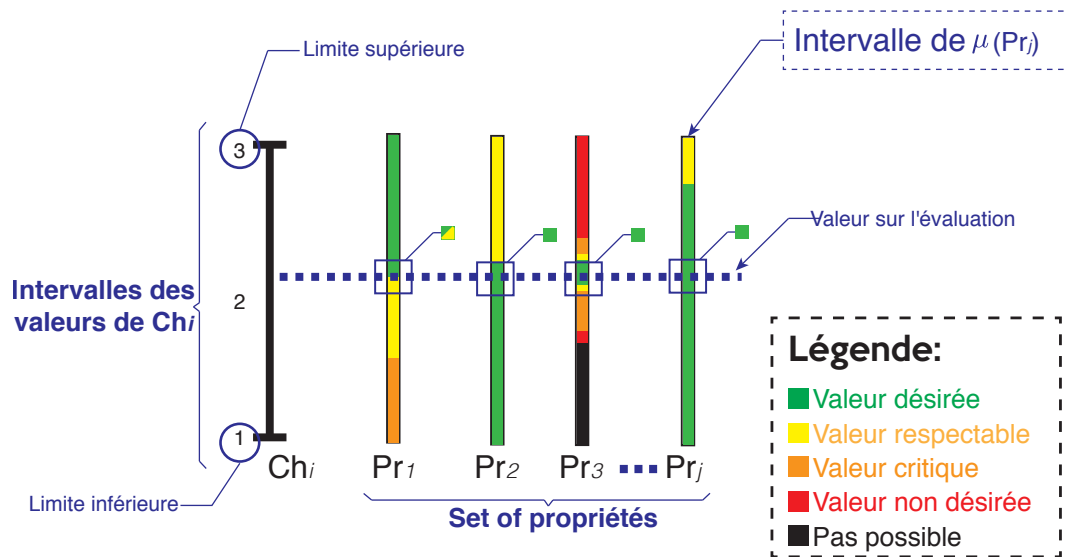

Figure 1.9 : Proposition de méthode interactive

Il est important de rappeler que la méthode proposée requiert certaines informations d'entrée pour produire des résultats : la construction du cadre de gestion de l'information et son exploitation, en tant que méthode exploratoire. Pour cette raison, il est nécessaire d'utiliser certains outils spécifiques qui permettront à la méthode de disposer des informations nécessaires pour pouvoir fonctionner correctement. En conséquence, il est proposé un processus de conception pouvant être observé sur la Figure 1.10.

La Figure 1.10 inclut non seulement les étapes de conception dans le processus de développement d'un nouveau produit, mais également les activités de conception, les outils et les livrables. Dans la figure, les produits livrables sont liés à des icônes, les activités de conception sont liées à des rectangles et les outils sont liés à des rectangles arrondis. De même, différentes couleurs sont utilisées pour identifier les outils : le bleu foncé est associé aux outils bien connus dans la littérature, tandis que les outils pourpres sont les activités proposées utilisées dans cette méthode.

1.3.1. Compréhension des relations dans les processus de conception de produits

La Figure 1.11 est une représentation d'un arbre de traçabilité, résultat de la conception d'une glacière portable (Voir Appendice A pour le détail du processus de conception). La construction de ce cadre d'information permet d'établir des relations entre les informations de conception. Ce cadre, défini comme un arbre de traçabilité, permet de comprendre et de discerner différentes couches d'informations.

Il est important de définir que cet arbre de traçabilité permet de comprendre comment l'incerti-

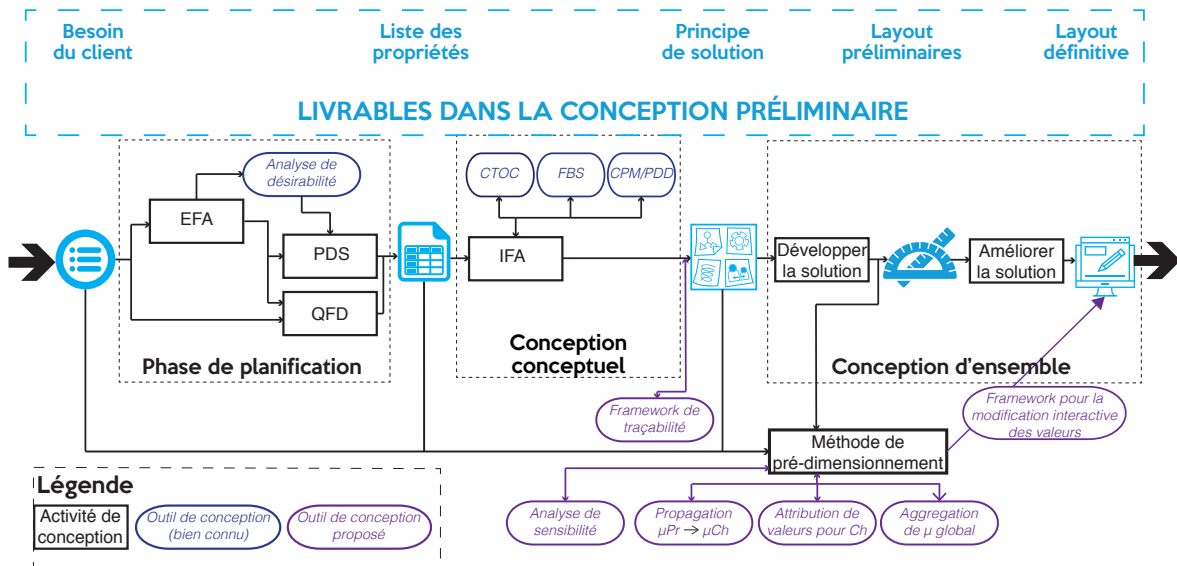

Figure 1.10 : Méthodologie de conception proposée

tude évolue au cours d'un processus de conception. Aussi, en précisant comment les méthodologies de conception réduisent le manque de conscience dans la prise de décision (Giachetti et al., 1997).

Comme l'arborescence est basée sur la structure du CPM/PDD, l'équipe de conception est capable de gérer et de comprendre comment l'incertitude interagit avec la conception. Les outils de conception utilisés pour établir les liens entre les couches sont les suivants :

- Besoin du client - Propriétés : QFD
- Propriétés - Relations : Analyse Fonctionnelle Externe et Analyse Fonctionnelle Interne (AFI) : FBS+CTOC+CPM/PDD (Malmiry, 2016)
- Relations - Caractéristiques : CPM/PDD

1.3.2. Mesure de l'interaction entre les Propriétés et leurs Caractéristiques

Une bonne conception doit être capable de mesurer les relations Propriétés-Caractéristiques afin de déterminer l'impact d'une modification d'une Caractéristique sur une Propriété. Cela permet aux concepteurs d'anticiper les conséquences potentielles des modifications éventuelles des Caractéristiques sur le comportement des Propriétés. Afin de calculer l'impact qu'une modification apportée à un élément peut avoir sur la conception globale et basée sur l'arbre de traçabilité, une analyse plus approfondie donne du poids aux sommets qui établissent les liens entre les éléments

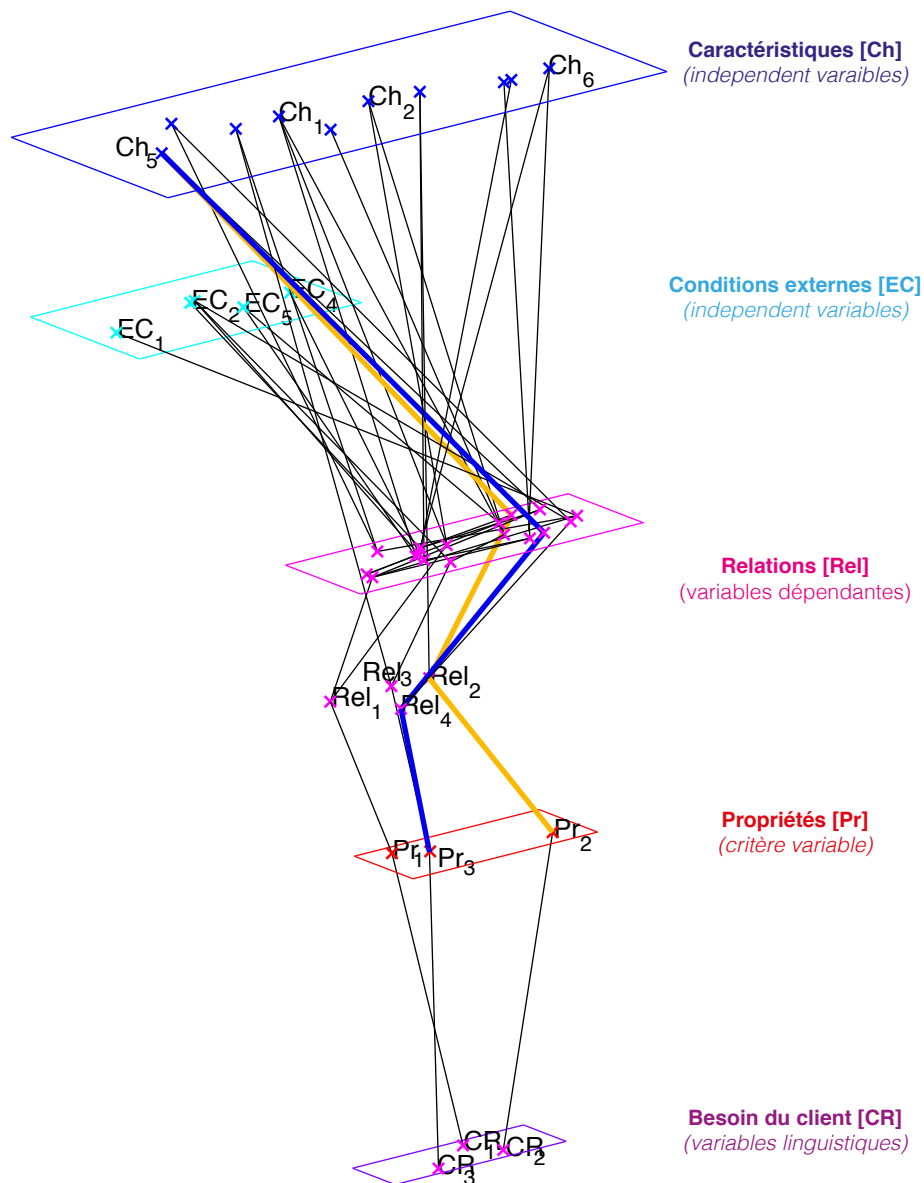

Figure 1.11 : Arbre de traçabilité complet basé sur CPM/PDD

de différentes couches. Ce poids permet de comprendre à quel point un élément est sensible à la variation d'un autre élément.

En ce qui concerne les liens tracés entre les exigences du client et les Propriétés, et afin de réduire l'impact des décisions subjectives, le poids de chaque sommet est déclaré 1,0, éliminant ainsi la subjectivité associée aux qualifications QFD. Aussi, les relations entre les Propriétés et les relations sont définies comme 1,0. Les connexions entre les relations, les Caractéristiques et les conditions externes sont définies en fonction de l'interaction pouvant être calculée entre elles.

Ce poids est calculé en utilisant une technique d'analyse de sensibilité, appelée *Indices de Corrélacion de Rangs Partiels* (PRCC). Cette technique a été choisie pour sa capacité à délivrer une valeur normalisée, où plus on se rapproche de 1, plus fort est le degré de relation entre les variables indépendantes et les variables dépendantes Hamby (1995). Cette technique est également utilisée pour analyser les problèmes de conception et pour présenter les résultats en triant les variables du plus influent au moins influent (Gagnon et al., 2018).

Cet attribut est nécessaire car il permet une meilleure comparaison. Par exemple, dans la Figure 1.11, Pr_2 et Pr_3 peuvent avoir des critères de mesure différents. Néanmoins, les deux Propriétés partagent Ch_5 . Il est donc nécessaire de développer un cadre permettant d'analyser l'impact de la modification de Ch_5 sur le comportement de Pr_2 et de Pr_3 .

1.3.2.1. Préparation d'analyse de sensibilité : simulation aléatoire des variables indépendantes

Une simulation de Monte Carlo est réalisée afin de comprendre le comportement des Caractéristiques et Conditions Externes. Dans cette analyse, le profil de variation et la distribution peuvent être définis par les concepteurs. Cette évaluation doit être centrée sur la compréhension de deux aspects : i) l'intervalle de variation, c'est-à-dire les valeurs minimale et maximale attendues pour les variables indépendantes ; ii) le profil de variation (distributions).

Définis ces distribution aléatoire des valeurs des Caractéristiques et Conditions Externes, les valeurs des Propriétés, Relations et sous-relations peuvent être estimés. La sortie sera la distribution aléatoire du comportement des Propriétés.

1.3.2.2. Interprétation d'analyse de sensibilité

La mise en oeuvre du PRCC produit les résultats suivants :

- Liste de hiérarchisation des Caractéristiques : Analyse de Sensibilité Globale (ASG) par PRCC.
- Poids des liens : Analyse de sensibilité locale (ASL) réalisée par le PRCC à tout niveau de *sous-relations - Caractéristiques / Conditions Externes*
- Comportement de la Propriété par la variation d'une Caractéristique : calculé par la dérivée partielle de la Propriété et de chaque Caractéristique.

Analyse de Sensibilité Globale d'une Propriété

L'ASG est centrée sur l'estimation de l'impact global d'une modification de Ch_i sur la Propriété Pr_j . Ensuite, ayant un ensemble de variables (avec des valeurs aléatoires), il est possible de calculer un résultat aléatoire de la Propriété, de la manière suivante : **Étant donné :**

X, ensemble aléatoire continu de valeurs réelles d'une variable indépendante

Y, ensemble aléatoire aléatoire de valeurs réelles d'une autre variable indépendante

C, variable dépendante suivant l'équation $C = X * Y$

Il y a :

C est une distribution de probabilité conjointe d'un ensemble continu aléatoire de valeurs réelles d'une variable dépendante, basée sur les opérations entre les variables indépendantes dont la distribution est composée.

Ensuite, l'indice de corrélation peut être calculé numériquement ou analytiquement. Lorsque les valeurs des variables indépendantes (X), qui font partie de la Propriété (C) sont connues, la corrélation ρ peut être obtenue par l'équation 1.1.

$$\rho_{XC} = \frac{N \sum_{i=1}^N r_{X_i} r_{C_i} - \sum_{i=1}^N r_{X_i} \sum_{i=1}^N r_{C_i}}{\sqrt{N \sum_{i=1}^N r_{X_i}^2 - \left(\sum_{i=1}^N r_{X_i}\right)^2} \sqrt{N \sum_{i=1}^N r_{C_i}^2 - \left(\sum_{i=1}^N r_{C_i}\right)^2}} \quad (1.1)$$

La sensibilité de chaque Propriété peut être calculée en fonction des données des Caractéristiques et des Conditions Externes. La Figure 1.12 montre la représentation de cette technique d'analyse de sensibilité pour les conditions externes et les Caractéristiques². Ce type de représentation permet de comprendre quelle est la Caractéristique qui influence le plus la Propriété.

Analyse de sensibilité local pour les Propriétés : poids du liens

Il est calculé en utilisant le PRCC, mais en utilisant les sous-relations. Par exemple, en utilisant l'équation 1.2, le PRCC est utilisé pour donner de poids aux sommets de l'arbre de traçabilité dans cette partie spécifique. Il est important de noter que l'équation d'aire équivalente (A_{eq}) est composée d'une Caractéristique (H_C) et d'une sous-relation de niveau inférieur, composée de deux autres Caractéristiques (L_C, W_C). Cela déterminera qu'il faut calculer un PRCC de niveau

²Pour la température interne d'une glacière portable, sur l'appendice A, équation A.13

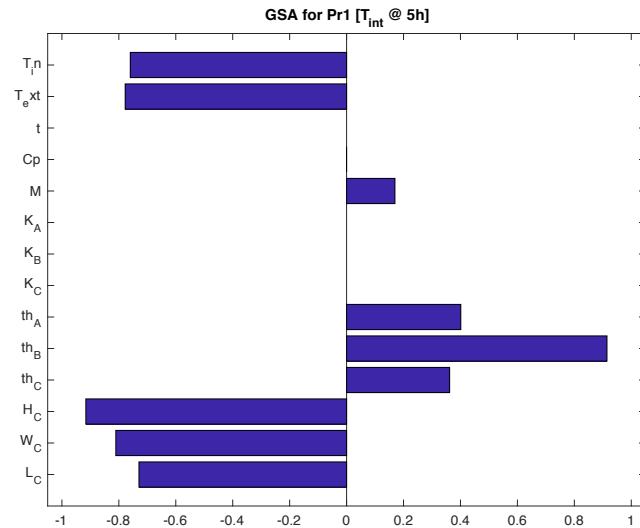
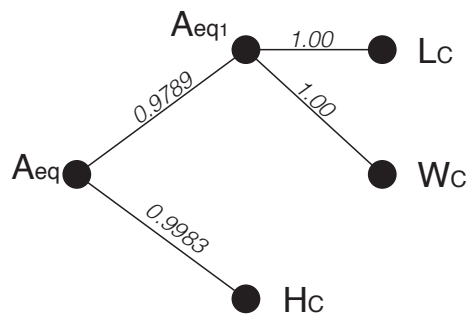
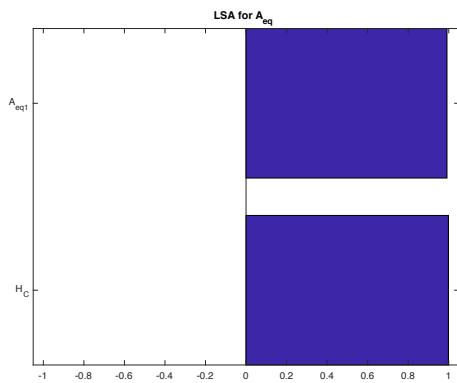

Figure 1.12 : Indice de corrélation pour la température interne après 5h

inférieur. Sur la Figure 1.13a montre les résultats de l'analyse de sensibilité et la Figure 1.13b montre le poids des Caractéristiques qui construisent la sous-relation.

$$A_{eq} = 2 * H_C * (L_C + W_C) \tag{1.2}$$



(a) Analyse de sensibilité de surface équivalente (b) Poids des liens de la surface équivalente

Figure 1.13 : Analyse de sensibilité locale de la surface équivalente (A_{eq})

1.3.2.3. Développement du cadre de traçabilité

Il est proposé de générer un graphe avec les informations générées lors du processus de conception. Ce graphique intègre les informations générées dans l'arbre de traçabilité et les résultats de l'analyse de sensibilité et les stocke. Le graphe est composé des liaisons entre Propriétés- Caractéristiques et du poids de ces liaisons.

Le graphe proposé est construit en adaptant les matrices générées de l'arbre de traçabilité et en les organisant de manière à produire une matrice d'adjacence. La structure de la matrice d'adjacence est visible dans l'équation 1.3.

$$AdjMat = \begin{bmatrix} - & CR_l & Pr_j & Rel_k & Ch_i & EC_m \\ CR_l & 0 & QFD & 0 & 0 & 0 \\ Pr_j & 0 & 0 & Pr2Rel & 0 & 0 \\ Rel_l & 0 & 0 & Rel2Rel^* & Rel2Pr^* & Rel2EC^* \\ Ch_i & 0 & 0 & 0 & 0 & 0 \\ EC_m & 0 & 0 & 0 & 0 & 0 \end{bmatrix} \quad (1.3)$$

Cette matrice d'adjacence comprend l'ensemble des informations sur les relations entre différentes couches d'informations stockées dans l'arbre de traçabilité. Il comprend également les informations relatives au poids des liaisons. Ceci est réalisé en indiquant le poids de chaque sommet comme résultat de l'ASL entre relations, sous-relations et Caractéristiques. La définition de cette matrice est importante car elle peut utiliser la théorie des graphes pour calculer des informations reliant les Propriétés et les Caractéristiques.

Avec la matrice d'adjacence, il est proposé de calculer trois indices afin d'améliorer la prise de décision :

- En relation avec l'ASL, l'index ψ est proposé. Cet index est lié au plus court chemin entre une Caractéristique et une Propriété. Cela permet de comprendre quand le chemin d'une Caractéristique est plus influent pour une Propriété. Par exemple, si Ch_1 a un index ψ de 0,9 à Pr_1 et 0,45 à Pr_2 , une modification de la Caractéristique influence plus haut Pr_1 .
- Sur la base des résultats de l'AGS de chaque Propriété, l'index ζ est proposé. Il est calculé comme la somme des résultats de l'ASG, ρ , et Permettre de mesurer l'influence des modifications des Caractéristiques. La Caractéristique avec la valeur la plus élevée est la Caractéristique avec la plus grande influence dans la conception.
- Basée sur les résultats de la sensibilité globale pondérée, il est proposé l'index χ . Cet indice mesure le niveau d'attachement des Propriétés, c'est-à-dire, quelle Propriété sera facile à résoudre et laquelle sera plus difficile à résoudre.

Index ψ

Cet index représente la somme normalisée des poids d'un chemin reliant deux éléments du graphique. En ce qui concerne les liaisons Propriété-Caractéristiques, l'index Ψ indiquera la somme

pondérée normalisée du chemin. Ceci est représenté comme :

$$\Psi_{Pr_j/Ch_i} = \frac{\sum |\rho \{Pr_j \rightarrow Ch_i\}|}{\#elements} \quad (1.4)$$

Parmi l'ensemble des informations, plusieurs liaisons partielles peuvent être établies dans n'importe quel graphe. Par conséquent, la définition de cet index permet de comprendre certaines liaisons. Considérant la conception de la glacière l'annexe A, un graphe partiel peut être présenté entre le Pr_1 et la Caractéristique H_C . Sur la Figure 1.14, trois chemins différents peuvent être identifiés entre Pr_1 et H_C . Pour chaque chemin, une somme pondérée est calculée (Voir Tableau 1.1). En fonction de Ψ_{Pr_1/H_C} , il est défini à la valeur la plus élevée de la somme. Ainsi, l'index Ψ_{Pr_j/Ch_i} , détermine le lien le plus fort entre une Propriété et sa Caractéristique.

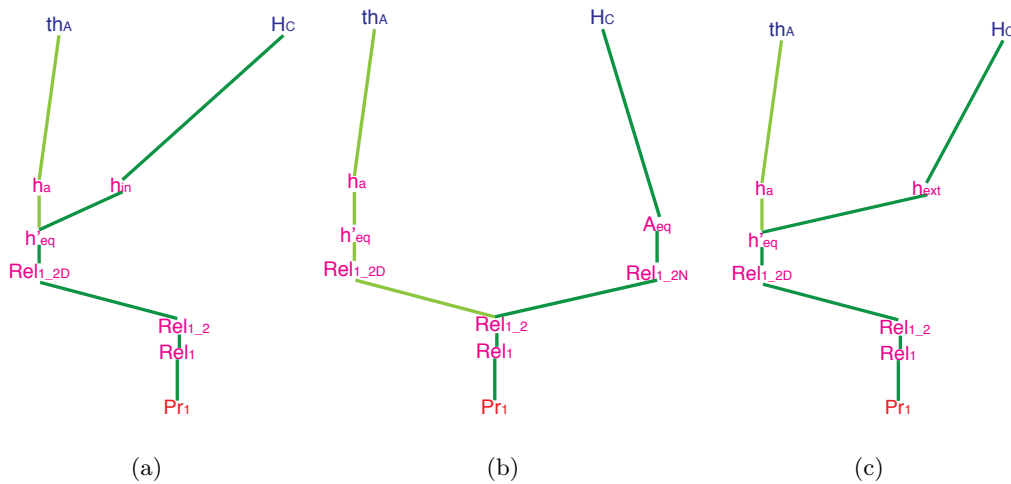

Figure 1.14 : Chemins de Pr_1 à th_A et H_C

Tableau 1.1 : Poids des chemins entre Pr_1 and H_C

Chemin	Somme de poids	Valeur normalisée
Figure 4.24a	4,9097	0,8182
Figure 4.24b	4,4,9664	0,9932
Figure 4.24c	4,9287	0,8214

L'analyse de ce graphe permet d'évaluer d'autres types de liaisons, telles que la liaison entre n'importe quelle paire de Caractéristiques. Ces liaisons peuvent déterminer un défi spécifique, notamment lorsqu'il est impossible de déterminer l'impact d'une modification sur le comportement du système. La Figure 1.14 montre les liaisons possibles entre th_A et H_C .

Pour ce faire, un concept permettant de comprendre ces liaisons (entre deux éléments) est le chemin le plus court. Ce concept peut être utile pour mesurer les liaisons collatérales, ce qui

permet aux concepteurs d'anticiper ces situations afin d'améliorer leurs processus décisionnels. De la Figure 1.14, le chemin plus court entre th_A et H_C est le chemin qui traverse la sous-relation h_{in} , résultant en un poids total de 2,9174 (Figure 1.14a).

Néanmoins, la situation la plus critique, dans la conception, se produira lorsqu'une modification d'une Caractéristique peut avoir un impact sur les Propriétés lorsqu'il n'existe pas de liaison directe disponible. Basé sur la théorie des graphes, il comprend comment utiliser la définition locale des chemins les plus courts.

Considérant :

Pr_a , qui est une Propriété qui est directement connectée à Ch_a mais non 's Ch_b

Pr_b , une Propriété qui est connecté à Ch_a et Ch_b

Il existe :

$Pr_a \rightarrow Ch_b$, qui est un chemin qui connecte Pr_a avec un Ch_b qui n'est pas directement connecté à la Propriété

L'index Ψ' peut être défini comme le chemin qui permet cette liaison, via des liaisons collatérales. Ces liaisons peuvent être utiles ou nocif. En outre, il indique laquelle des Caractéristiques domine l'autre sur cette corrélation collatérale. Sur la Tableau 1.2 les règles de cette situation sont énoncées, où :

$Chain_a$ est le chemin le plus court entre Pr_a and Ch_a

$Chain_2$ est le chemin le plus court entre Pr_b and Ch_a

$Chain_3$ est le chemin le plus court entre Pr_b and Ch_b

$Edge_a$ est le sommet partagé entre $Chain_1$ and $Chain_2$

$Edge_b$ est le sommet partagé entre $Chain_2$ and $Chain_3$

$Path_1$ est $Pr_a \rightarrow Edge_a$

$Path_2$ est $Edge_a \rightarrow Edge_b$

$Path_3$ est $Edge_b \rightarrow Ch_b$

Tableau 1.2 : Ψ' tableau de décision

Comparaison 1	Comparaison 2	Domine	Effet
$\Psi_{Path_1} > \Psi_{Path_2}$	$\Psi_{Path_2} > \Psi_{Path_3}$	Ch_a	Useful
$\Psi_{Path_1} > \Psi_{Path_2}$	$\Psi_{Path_2} < \Psi_{Path_3}$	Ch_b	Harmful
$\Psi_{Path_1} < \Psi_{Path_2}$	$\Psi_{Path_2} > \Psi_{Path_3}$	Ch_a	Useful
$\Psi_{Path_1} < \Psi_{Path_2}$	$\Psi_{Path_2} < \Psi_{Path_3}$	Ch_b	Harmful

Index ζ

L'index qui résume les résultats de l'analyse de sensibilité globale, calculé comme la somme des valeurs absolues de ρ des Caractéristiques. Cet index est noté avec la lettre grecque ζ . Cet index peut être représenté dans l'équation 1.5.

$$\zeta_i = \sum_{j=1}^{j_{max}} |\rho_{ch_i, Pr_j}| \quad (1.5)$$

Le calcul de ζ déterminera une valeur pour chaque Caractéristique qui indique l'influence globale qu'elle génère sur la conception globale. La Tableau 1.3 résume les valeurs ρ de l'AGS de la glacière de l'annexe A.

Tableau 1.3 : Analyse de sensibilité globale de la glacière portable

	LC	WC	HC	th_A	th_B	th_C	th_{lid}
Pr_1	-0,619	-0,7259	-0,938	0,2809	0,9393	0,2768	
Pr_2	0,9657			0,9768	0,958	0,9747	
Pr_3	-1			-1	-1	-1	
Pr_4		-1		-1	-1	-1	
Pr_5			-1	-1	-1	-1	-1
Pr_6	-0,8985	-0,9512	-0,9841	-0,989	-0,4845	-0,9835	
Pr_7	0,9511	0,9874	0,9905				
ζ	4,4343	3,6645	3,9126	5,2467	5,3818	5,235	1

Sur la base de ces résultats de la Tableau 1.3, la Caractéristique avec l'index le plus élevé est th_B avec $\zeta_{th_B} = 5,38$, et le plus bas est th_{lid} avec $\zeta_{th_{lid}} = 1$. On peut en conclure que th_B est plus critique pour la conception que th_{lid} et les autres Caractéristiques. Par conséquent, une hiérarchisation peut être établie en triant ζ de la valeur la plus grande à la valeur la plus basse.

Index χ

En plus de comprendre quelle Caractéristique est celle qui a le plus d'influence dans la conception, d'autres applications que l'on peut définir de ζ consiste à comprendre la complexité de la résolution d'une Propriété. Pour ce faire, il est proposé l'index χ . Cet index évalue le degré d'attachement de chaque Propriété. Une Propriété avec une valeur inférieure est moins connectée au jeu de Caractéristiques. Cet index calcule pour chaque Propriété sa relation avec l'index ζ de ses Caractéristiques. Sur l'équation 1.6 est présenté le calcul de χ .

$$\chi_j = \sum_{i=1}^{i_{max}} |\rho_{ch_i, Pr_j}| * \zeta_i \quad (1.6)$$

Par exemple, dans le cas de la glacière, Pr_7 est connecté à L_C , W_C et H_C . Le calcul de χ_7 est donné par :

$$\chi_7 = |\rho_{L_C, Pr_7}| * \zeta_{L_C} + |\rho_{W_C, Pr_7}| * \zeta_{W_C} + |\rho_{H_C, Pr_7}| * \zeta_{H_C}$$

$$\chi_7 = (0,9511) * 4,4343 + (0,9874) * 3,6645 + (0,9905) * 3,9126$$

$$\chi_7 = 11,7112$$

En suivant cette procédure pour calculer χ , les valeurs pour le reste des Propriétés peuvent être définies. L'interprétation de cet indice est liée à la complexité de la Propriété en cours de résolution. Cette complexité est liée à la quantité et à l'influence de la Caractéristique qui compose la Propriété. La Tableau 1.4 présente les valeurs de χ pour la conception de la glacière.

Tableau 1.4 : Niveau de complexité des Propriétés χ de la glacière

	χ
Pr_1	17,05288182
Pr_2	19,66549897
Pr_3	20,2978
Pr_4	19,528
Pr_5	20,7761
Pr_6	24,26537151
Pr_7	11,71122033

Quelques conclusions de la Tableau 1.4 sont : Pr_7 est la Propriété avec le moins d'implications à résoudre. En outre, on peut voir que Pr_1 et Pr_6 sont composés de six Caractéristiques, mais leurs valeurs de l'index χ sont différentes. Dans l'appendice A sont détaillés les arbres de traçabilité de Pr_1 (Figure A.14) et Pr_6 (Figure A.13). Dans ces Propriétés, on peut observer que, par exemple, la Caractéristique th_C est utilisée une fois dans Pr_1 mais elle est utilisée neuf fois dans Pr_6 . Le calcul de l'index χ permet de comprendre ces situations et permet ainsi de déterminer des valeurs plus élevées pour plus de Propriétés attachées.

1.3.3. Évaluation de l'interaction entre les Propriétés

L'arbre de traçabilité permet aux concepteurs de comprendre visuellement les relations entre les Propriétés et les Caractéristiques, même s'ils sont liées ou non par des relations. Ces situations sont assez courantes dans le processus de conception de produits, mais leur analyse peut devenir difficile. Pour cela, une méthode de conception interactive est proposée.

1.3.3.1. Impact de la modification des Caractéristiques

À fin d'améliorer les processus de prise de décision multi-critère, il est proposé un cadre pour structurer certaines informations générées lors de la conception initiale, permettant de comprendre l'impact qu'une modification de Caractéristique peut avoir sur le comportement des Propriétés. En utilisant les fonctions de désirabilité des Propriétés comme stratégie pour introduire la flexibilité, le processus de prise de décision est divisé en 5 intervalles (Voir Tableau 1.5), offrant un code de couleur : lorsque le besoin est extrêmement élevé, est vert, bon désir, jaune, moyen désirable, orange, désirable, rouge, et valeurs non désirées, noir.

Tableau 1.5 : Intervalles de désirabilité des Propriétés

Couleur	μ	Définition
Vert	$1 > \mu > 0,8$	Les valeurs dans cet intervalle représentent la valeur appropriée pour la Propriété
Jaune	$0,8 > \mu > 0,6$	Pas les meilleures valeurs, mais toujours accepté
Orange	$0,6 > \mu > 0,4$	Non désiré, mais pourrait être considéré en fonction de la situation
Rouge	$0,4 > \mu > 0$	Préférence d'acceptation la plus basse. Seulement si c'est nécessaire
Noir	$\mu = 0$	Les valeurs ne sont pas souhaitables

Ces intervalles visuels permettent aux concepteurs de prendre facilement une décision, tout en leur permettant de voir si leur modification s'oriente vers une section verte ou non. La Figure 1.15 montre la proposition interactive, dans laquelle une équipe de conception peut modifier manuellement une Caractéristique et connaître l'impact de cette modification sur la conception. Cette Figure présente l'analyse réelle du cas de conception de la glacière, où l'on évalue l'impact des modifications de th_A sur les Propriétés de la conception. Les directives d'utilisation du cadre sont résumées comme suit :

- (I) Définissez les premières valeurs des Caractéristiques comme valeurs nominales des distributions utilisées dans l'échantillonnage de Monte Carlo. Cette première solution s'appellera le « **Layout Préliminaire** ».
- (II) Sélectionnez la Caractéristique avec la valeur plus élevée de l'index ζ . Cette valeur représente la Caractéristique ayant le plus grand impact sur la conception.
- (III) Modifiez la valeur afin d'obtenir une meilleure combinaison de désirabilité des Propriétés.

Dans la conception du refroidisseur portable, la valeur nominale des Caractéristiques et conditions externes permet de générer une première solution. Sur la Tableau 1.6 on peut observer les valeurs de la désirabilité de la solution avec le « **Layout Préliminaire** ». Avec ces valeurs, on

peut en conclure que la solution ne répond pas aux spécifications de la conception, car Pr_6 poids total est en dehors des intervalles de désirabilité. En analysant les informations générées relatives à l'AGS, la Caractéristique la plus sensible pour cette Propriété est th_A . Sur la Figure 1.15 on peut observer l'égaliseur pour cette Caractéristique.

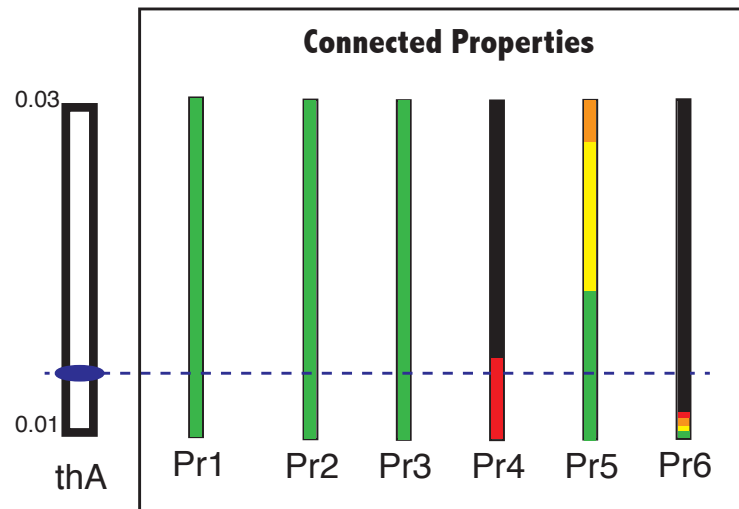

Figure 1.15 : Égaliseur for th_A

Sur la Figure 1.15, on peut observer l'un des défis des situations de modification de conception. Dans ce cas particulier, il n'existe pas de valeur th_A permettant à Pr_4 largeur externe d'être de couleur verte. Néanmoins, modifier th_A à la valeur minimale, qui est $th_A = 0,01m$ permettra une opportunité verte sur 5 de 6 Propriétés connectées. Aussi, un autre défi peut être apprécié, qui est lié au Pr_6 poids total, où une petite modification peut passer de la désirabilité verte à une opportunité nulle. Sur la Tableau 1.6, on peut observer le niveau de désirabilité de la solution après la modification de la Caractéristique à sa valeur minimale.

Tableau 1.6 : Niveau de désirabilité de la solution avec le layout préliminaire et le layout modifiée.

	Valeur (Solution ₁)	Désirabilité	Valeur (Solution ₂)	Désirabilité
Pr_1 =Température interne	4,228 °C	$\mu = 1,0$	4,361 °C	$\mu = 1,0$
Pr_2 =Résistance	8,124KPa	$\mu = 1,0$	8,952KPa	$\mu = 1,0$
Pr_3 =Longueur extérieure	0,454m	$\mu = 0,999$	0,446m	$\mu = 1,0$
Pr_4 =Largeur extérieure	0,421m	$\mu = 0,174$	0,412m	$\mu = 0,283$
Pr_5 =Hauteur externe	0,436m	$\mu = 0,747$	0,432m	$\mu = 0,801$
Pr_6 =Poids total	18,475Kg	$\mu = 0$	15,245Kg	$\mu = 0,803$
Pr_7 =Volume interne	37,984l	$\mu = 0,178$	37,984l	$\mu = 0,178$

Finalement, ce processus exploratoire peut être mené avec plusieurs Caractéristiques, afin de

modifier de manière interactive les valeurs permettant de définir une solution correcte où toutes les désirabilités sont positives ou proches aux intervalles verts. Néanmoins, avec la complexité et la variabilité élevées, la modification manuelle non contrôlée lors de la gestion de comportements multiples, demande une meilleure moyen pour résoudre de problème de conception. La section suivante présente un complément à la méthode exploratoire interactive et permettra l'utilisation de la méthodologie. Le complément proposé se concentrera sur le calcul d'une meilleure désirabilité des Propriétés.

1.4. Amélioration de la désirabilité globale des objectifs de conception

Jusqu'ici, la méthodologie présentée permet aux concepteurs de comprendre les relations entre Propriétés et Caractéristiques, et comment la modification d'une Caractéristique affecte le comportement de la solution. Néanmoins, l'utilisation de cette méthode pour donner des valeurs définitives aux Caractéristiques est limitée par la complexité de la conception : plus la quantité de Propriétés et de Caractéristiques, plus il est difficile de trouver manuellement des solutions. Par conséquent, il est proposé de compléter la méthode interactive en calculant une meilleure combinaison de valeurs des Caractéristiques.

La partie complémentaire est centrée sur la maximisation de la désirabilité globale des objectifs de conception et sur la définition d'une méthode de pré-dimensionnement, qui peut être ajustée à l'aide de la méthode interactive exploratoire. L'objectif de cette méthode est de donner des valeurs aux Caractéristiques afin d'améliorer la désirabilité général des Propriétés. Aussi, améliorer la prise de décision dans des situations de conception complexes, telles que le traitement de non convexités. La méthode de pré-dimensionnement comme une méthode « *interactive inductive* », pour trouver des valeurs pour les Caractéristiques, complétant la partie « *interactive exploratoire* ». L'utilisation des deux approches permettra d'affiner la solution.

Comme il a été dit précédemment, la définition des valeurs des Caractéristiques est attribuée par le layout préliminaire. Cette layout est basée sur les valeurs nominales de la distribution de chaque Caractéristique. La solution générée par l'utilisation du layout préliminaire, sera comprise comme la première solution du problème. Cette combinaison de valeurs sera nommée en tant qu'Espace de Caractéristiques de Conception (DCS) et est définie comme suit :

Given :

$\{Ch_1, Ch_2, \dots, Ch_i\}$, set de i Caractéristiques de conception avec une valeur définie.

Then exist :

$\{\mu_{(Pr_1)}, \mu_{(Pr_2)}, \dots, \mu_{(Pr_j)}\} \in \mathbb{R}$, set de désirabilités de j Propriétés, calculées avec les valeurs définies de Caractéristiques

Le calcul des fonctions de désirabilité $\mu_{(Pr_j)}$ de chaque Propriété ouvre la possibilité de définir une désirabilité globale, de chaque solution, qui peut être associé à chaque *DCS*. Le calcul de plusieurs *DSC* permettra de comparer les solutions, en fonction de leur désirabilité globale. La méthode de pré-dimensionnement est centrée sur la maximisation de la désirabilité agrégée des Propriétés. Cette désirabilité agrégée est basée sur l'évaluation de l'Index de Désirabilité Global (GDI) dans un niveau compensatoire. Le but de la méthode de pré-dimensionnement est de calculer une layout améliorée, définie comme suit :

$$\{Ch_1, Ch_2, \dots, Ch_i\} \mid \max_{Ch_i \in \mathbb{R}} f(\mu_{sln})$$

La définition du layout améliorée contraint le processus à établir un mécanisme permettant d'évaluer l'ensemble des possibilités, pour chaque Propriété, dans son ensemble. C'est-à-dire la définition d'une fonction GDI qui répond aux différents $\mu_{Pr_j} : F(\mu_{sln})$. De même, il est nécessaire de développer une méthode permettant de comparer différentes solutions. Ce layout améliorée est un *DCS* avec une plus grande désirabilité globale que le layout préliminaire, telle que :

$$\mu(DCS_{final}) \gg \mu(DCS_0)$$

1.4.1. Méthode de pré-dimensionnement pour maximiser la désirabilité globale de la solution

Afin de générer une solution dans laquelle l'index global de désirabilité est optimal, il est présenté une méthode itérative centrée sur la génération, l'évolution et l'évaluation de solutions de conception. Cette section propose une méthode de pré-dimensionnement, qui s'appellera SSNV, pour l'acronyme en anglais « *Structured Stepped Nominal Value* », Valeur nominale étagée structurée. Le nom de la méthode est donné en raison de la nature de la méthode elle-même :

- *Étagée Structurée* : l'étape itérative de la méthode n'est pas définie par des paramètres aléatoires, mais est structurée en fonction des informations de l'arbre de traçabilité. L'étape structurée est définie par la liste de priorité des Caractéristiques, qui est un ordre décroissant

triant l'influence des Caractéristiques avec la conception. Cette liste est l'une des entrées de la méthode.

- *Valeur nominale* : le point de départ de la méthode (DCS_0) est défini par le layout préliminaire. Cette structure est définie à partir de l'échantillonnage de Monte Carlo pour chaque Caractéristique, où il est proposé d'utiliser la valeur nominale comme point de départ de la séquence d'itérations.

Néanmoins, pour que la méthode calcule une solution appropriée, il est nécessaire de considérer la fonction de désirabilité. $\mu_{(Pr_j)}$ de chaque Propriété. Aussi, il est nécessaire de définir un mécanisme pour traduire la désirabilité des Propriétés à la couche des Caractéristiques.

La Figure 1.16 présente le diagramme du fonctionnement de la méthode.

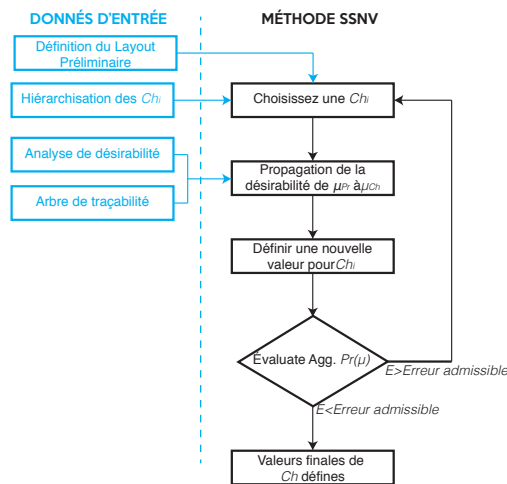

Figure 1.16 : SSNV diagramme de processus

1.4.1.1. Propagation de la désirabilité à la couche Caractéristiques

Sur la base de l'analyse des besoins du client (compilée dans le CdCF), l'équipe de conception peut définir un ensemble de fonctions de désirabilité μ pour chaque Propriété. La variation de ces fonctions est déterminée par la variation des Caractéristiques. On peut donc définir que :

$$\mu(Pr_j) = Fn(Ch_1, Ch_2, \dots, Ch_i) \quad (1.7)$$

De même, une Caractéristique peut faire partie de plusieurs Propriétés, ce qui déclenche l'analyse de la propagation prendre soin des différentes relations. Pour résoudre ce problème, l'utilisation

de CPM/PDD permet de gérer ces relations, permettant ainsi aux concepteurs d'effectuer une meilleure analyse dans les situations de prise de décision.

Par conséquent, la première partie de l'analyse est centrée sur le fait de savoir quelles Caractéristiques font partie de chaque Propriété. Généralement, ces informations sont déjà contenues dans le graphe de traçabilité, généré par la mise en œuvre de la méthodologie CPM/PDD. Pour un *DCS* donné, il est possible de calculer la valeur correspondante de μ de la Propriété. Considérant Pr_1 en fonction de Ch_1, Ch_2, Ch_3 (Équation 1.8), Pr_2 en fonction de Ch_1, Ch_2 (Équation 1.9), les fonctions de désirabilité décrites à la Figure 1.17, peuvent être établies. Les valeurs que peuvent prendre ces Caractéristiques sont indiquées sur la Tableau 1.7.

$$Pr_1 = \frac{Ch_1 * Ch_2^2}{Ch_3} \quad (1.8)$$

$$Pr_2 = Ch_1^{Ch_2} \quad (1.9)$$

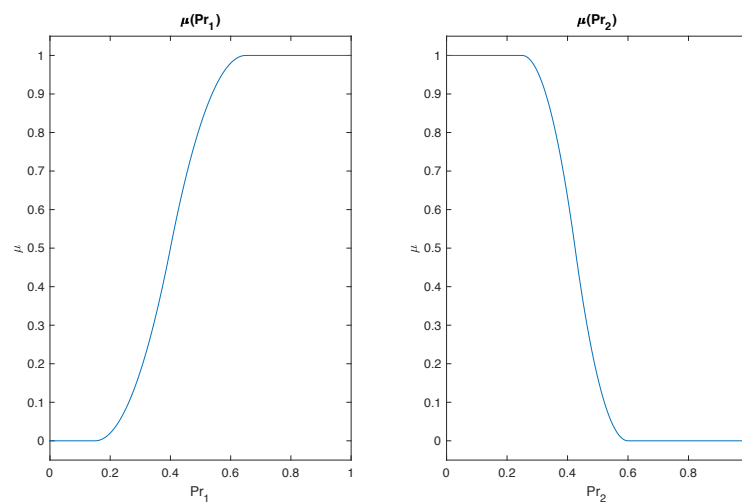

Figure 1.17 : Fonction de désirabilité pour Pr_1 et Pr_2

Tableau 1.7 : Exemple de propagation : Valeurs des Caractéristiques

Caractéristique	Intervalle	Valeur nominal
Ch_1	[0 – 0, 5]	0, 19
Ch_2	[0, 5 – 1]	0, 9
Ch_3	[0, 5 – 1]	0, 75

Le défi de la propagation de l'information de désirabilité doit être abordé progressivement. En conséquence, les étapes suivantes sont proposées afin d'évaluer le comportement de la fonction de désirabilité d'une Propriété, alors que les Caractéristiques changent :

- (I) Choisissez une Caractéristique
- (II) Fixer les Caractéristiques qui complètent cette Propriété
- (III) Identifier les valeurs de variation de la Caractéristique
- (IV) Évaluer la fonction de désirabilité en modifiant la Caractéristique sélectionnée

La nouvelle fonction peut être interprétée comme la désirabilité de la Propriété par la modification des Caractéristiques (Équation 1.10). Le comportement de ces fonctions dépend des valeurs de chaque *DCS*. Ces fonctions s'appelleront les Fonctions de Désirabilité Dynamique (DDF), car leur comportement varie pour chaque solution.

$$\mu(Pr_j)/Ch_i \quad (1.10)$$

Cette fonction représente l'évolution de la désirabilité de la Propriété en fonction de la modification dynamique des valeurs des Caractéristiques. Même si la fonction souhaitable est toujours liée à la Propriété, l'intervalle de la fonction est maintenant contrainte à l'intervalle où la Caractéristique peut varier. Sur la Figure 1.18 la représentation graphique des fonctions de désirabilité est affichée.

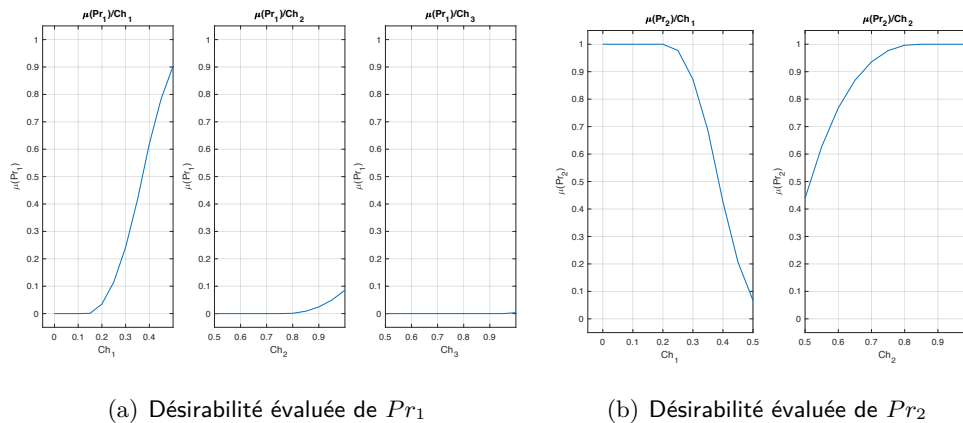

Figure 1.18 : Désirabilité évaluée des Propriétés par la variation de leurs Caractéristiques

1.4.1.2. Définition de la fonction de désirabilité des Caractéristiques

Basé sur les différents DDF $\mu(Pr_j)/Ch_i$, il est nécessaire de synthétiser leurs informations dans une seule fonction qui représente la désirabilité de la Caractéristique : $\mu(Ch_i)$. La définition de cette nouvelle fonction est basée sur l'agrégation des fonctions de désirabilité des Propriétés par la modification des Caractéristiques. (DDF, Équation 1.10). Le calcul de ces fonctions de

désirabilité des Caractéristiques est basé sur l'analyse des interactions Propriétés-Caractéristiques, représentées par $\mu_{(Pr_j)/Ch_i}$.

Ces types de diagrammes sont essentiels pour comprendre les relations entre les Propriétés avec Caractéristiques. L'utilisation du cadre de traçabilité proposé permet d'identifier les interactions entre les éléments du graphe. En termes d'interactions Propriétés-Caractéristiques, il est proposé d'utiliser l'index Ψ , qui indique le lien plus fort entre une Propriété et ses Caractéristiques. Par conséquent, selon l'exemple de graphe de la Figure 1.19, l'index Ψ est calculé comme :

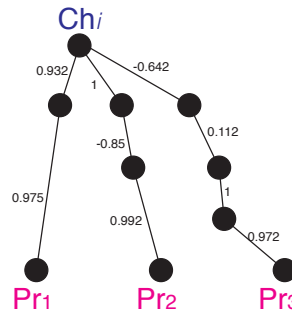

Figure 1.19 : Extrait d'un graphe reliant une Caractéristique à ses Propriétés

$$\Psi_{Pr_1/Ch_i} = 0.9535$$

$$\Psi_{Pr_2/Ch_i} = 0.9474$$

$$\Psi_{Pr_3/Ch_i} = 0.6815$$

L'analyse est divisée en deux éléments : i) l'interaction locale entre la Propriété et la Caractéristique, mesurée par Ψ_{Pr_j/Ch_i} ii) l'interaction entre la désirabilité de la Propriété (sous réserve de la modification de la Caractéristique) et l'influence des valeurs des Caractéristiques complémentaires $\mu_{(Pr_j)/Ch_i}$. Le calcul de la fonction de désirabilité pour la Caractéristique sera fonction de ces deux éléments, comme suit :

$$\mu(Ch_i) = Fn \left(\Psi_{Pr_j/Ch_i}, \mu_{(Pr_j)/Ch_i} \right) \quad (1.11)$$

De même, l'agrégation multi-critères peut être traitée sous deux principes différents : la concordance et la discordance. D'une part, la concordance est mise en œuvre lorsque le processus d'agrégation a tendance à respecter les valeurs de désirabilité supérieures des Propriétés. Par ailleurs, la discordance est centrée sur le respect des valeurs inférieures (pénalisant les valeurs de désirabilité des Propriétés inférieures), en privilégiant les actions équilibrées afin de permettre une réponse qui ne soit pas axée sur de petits avantages. Selon cela, la méthode proposée peut être classée

en tant que méthode de discordance. Ce raisonnement est basé sur l'évitement des intervalles permettant d'obtenir une désirabilité nulle. Voir Équation 1.12 où le $\mu(Ch_i)$ est présenté.

$$\mu(Ch_i) = \prod_{j=1}^j \Psi_{Pr_j/Ch_i} * \left(\mu_{(Pr_j)/Ch_i} \right) \quad (1.12)$$

LE $\mu(Ch_i)$ est calculé comme le produit entre l'index Ψ_{Pr_j/Ch_i} et le $\mu_{(Pr_j)/Ch_i}$. La première partie joue un rôle dans le processus d'agrégation. Fortes relations entre Propriétés et Caractéristiques (Ψ proche de 1) aura un impact important sur l'agrégation. Par exemple, pour le graphe de la Figure 5.7, la désirabilité de Pr_1 sera classé plus élevé que la désirabilité de Pr_3 à cause de la valeur de l'index Ψ

En ce qui concerne $\mu_{(Pr_j)/Ch_i}$, il représente le comportement de la désirabilité de la Propriété en fonction de la modification des Caractéristiques. Cette partie de la fonction contient les intervalles de désirabilité nuls et ceux où $\mu > 0$.

Par exemple, la Figure 1.20a et 1.20b présente les deux Propriétés ($\mu_{(Pr_j)/Ch_i}$) touchées par les variations de Ch_1 . Le graphique du bas présente la fonction agrégée qui représente la multiplication des fonctions $\mu_{(Pr_1)/Ch_1}$ et $\mu_{(Pr_2)/Ch_1}$, y compris leur poids (Ψ). Cela détermine la fonction de désirabilité résultante de la Caractéristique. La Figure 1.20c montre la désirabilité de cette Caractéristique.

Une particularité de cette agrégation est que les intervalles avec une désirabilité nulle, dans n'importe lequel des DFF, sont pénalisés. C'est le comportement attendu du modèle de discordance.

1.4.1.3. Définition du mécanisme d'évaluation

La propagation de la désirabilité de la Propriété jusqu'à la couche des Caractéristiques offre une opportunité intégrée avec la forme $\mu(Ch_i)$, qui contient implicitement la désirabilité conjointe des Propriétés. Cela facilite la prise de décision en ayant un impact positif sur les résultats de la conception. La Figure 1.20 montre les intervalles où les valeurs de Ch_1 produiront une désirabilité nulle $[0 - 0, 15]$ et les valeurs où la Caractéristique générera un meilleur niveau de désirabilité. Par conséquent, l'évaluation de la fonction de comportement détermine quelle valeur de la Caractéristique définit la meilleure valeur pour la conception. Par conséquent, une nouvelle valeur est attribuée à la Caractéristique, en fonction de la sélection de la valeur maximale dans la fonction de désirabilité propagée (Voir Équation 1.13) :

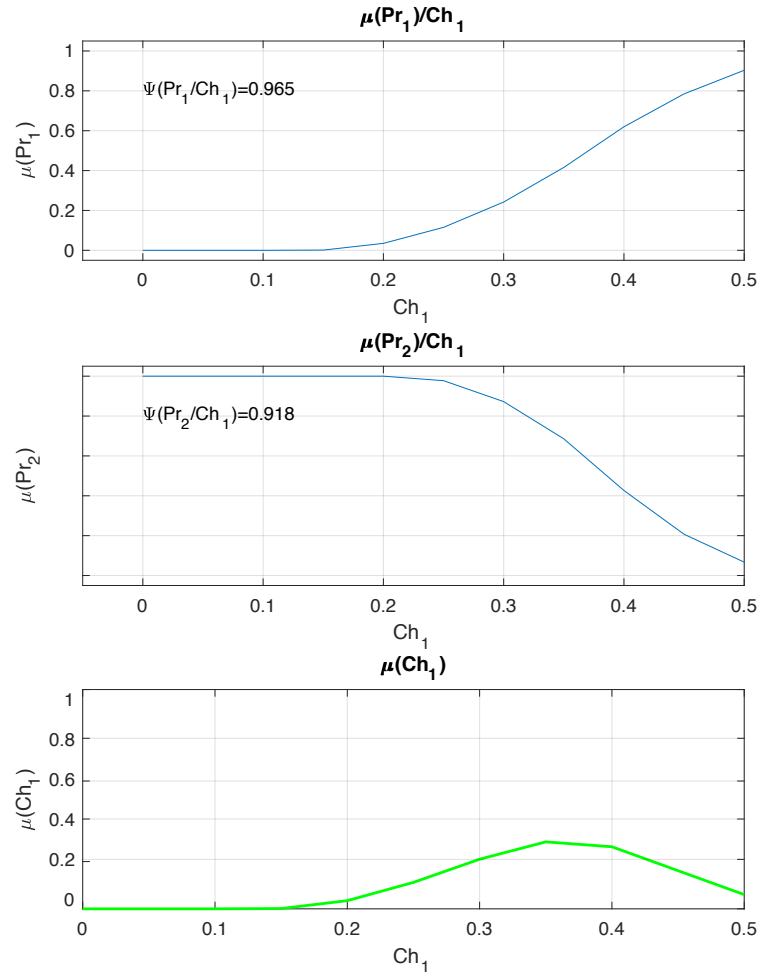
Figure 1.20 : Fonction de désirabilité propagé pour Ch_1

$$Ch_i.new = max(\mu(Ch_i)) \quad (1.13)$$

$$Ch_i.new = max\left(\prod\left(\Psi_{Pr_j/Ch_i} * \left(\mu(Pr_j)/Ch_i\right)\right)\right)$$

Sur la base de la nouvelle valeur, il est garanti que cela aura un impact positif sur la désirabilité des Propriétés. Cette nouvelle valeur permet de définir un nouveau DCS , permettant d'effectuer plusieurs évaluations : la première consiste à calculer la nouvelle valeur des Propriétés et à utiliser leur fonction de désirabilité pour évaluer la sortie. La Tableau 1.8 compare les valeurs entre DCS_0 et DCS_1 , obtenues avec la nouvelle valeur Ch_1 . Aussi, il est nécessaire de définir un cadre pour une comparaison complète. On introduit donc une GDI, calculée avec les valeurs de chaque DCS . Ayant le sous-index h consécutif à chaque calculé DCS , le GDI est défini comme suit :

$$Agg.\mu_h = \prod_{j=1}^j \mu(Pr_j) \quad (1.14)$$

Tableau 1.8 : Comparaison de valeurs entre solutions

Solution	$Pr_1 (Ch_1, Ch_2, Ch_3)$	$\mu(Pr_1)$	$Pr_2 (Ch_1, Ch_2)$	$\mu(Pr_2)$
DCS_0	0,1710	0,0035	0,2243	1,000
DCS_1	0,3150	0,2178	0,3887	0,6857

Cela permet de créer une solution ayant un comportement différent. Pour l'exemple présenté sur la Tableau 1.8, l'amélioration de la désirabilité pour Pr_1 est évidente, mais pour Pr_2 , la nouvelle valeur est inférieure. Par la suite, il est nécessaire d'évaluer la solution complète. En ce qui concerne le GDI, cela permet de comparer les deux solutions. La désirabilité agrégée pour la première solution est $Agg.\mu_0 = 0.0035$, alors que pour la solution calculée pour DCS_1 , $Agg.\mu_1 = 0.1494$. La nouvelle désirabilité agrégée est considérablement plus élevée que la désirabilité calculée initialement. Cette augmentation a été générée par l'attribution d'une nouvelle valeur de la Caractéristique, calculée pour générer le plus grand impact positif sur la solution.

Le prochain défi est centré sur la manière de contrôler les routines « *d'attribution des valeurs* ». Pour ce faire, il est proposé une routine itérative, basée sur les résultats de l'analyse de sensibilité globale condensée dans l'index ζ .

Basé sur les résultats de la conception de la glacière (Voir Tableau 1.3), on peut en conclure que la Caractéristique avec le plus bas ζ est la Caractéristique avec le plus faible impact sur la conception globale. De même, le plus haut ζ est la Caractéristique qui a plus d'influence sur les Propriétés.

Afin d'avoir un impact dans la conception d'un plus haut niveau depuis le début, il est proposé une boucle itération pour la routine itérative, qui est donnée par l'organisation de ζ_i de la valeur maximale à la valeur minimale. Pour la situation de la conception de la glacière, le vecteur arrangé est :

$$\begin{aligned} \left[\overrightarrow{\zeta_{boucle}} \right] & \therefore \zeta_{th_B} > \zeta_{th_A} > \zeta_{th_C} > \zeta_{L_C} > \zeta_{H_C} > \zeta_{W_C} > \zeta_{th_{lid}} \\ \overrightarrow{\zeta_{loop}} & = [th_B, th_A, th_C, L_C, H_C, W_C, th_{lid}] \end{aligned}$$

Ainsi, la définition de cette $\overrightarrow{\zeta_{boucle}}$ définira la manière dont les différentes solutions sont générées et évaluées. La stratégie de l'algorithme consiste à définir la valeur d'une Caractéristique et à évaluer le GDI du nouveau DCS . Par conséquent, le SSNV est centré dans la génération des fonctions de désirabilité agrégées des Caractéristiques. Sur la base de ces fonctions, la méthode cherche à maximiser la désirabilité global de la conception en maximisant les fonctions de désirabilité des Caractéristiques. Essentiellement, lorsque la préférence agrégée est maximisée, il s'agit

en fait de ce que le concepteur souhaite, et non d'une solution artificiellement contrainte par la géométrie de la conception (Antonsson, 2001).

Finalement, la routine itérative se termine lorsque l'erreur est faible. L'erreur est définie comme la différence entre une paire de *DCS* (voir Équation 1.15). La conception converge vers une solution lorsque l'erreur ϵ prend des valeurs proches de zéro.

$$\epsilon_h = |Agg.\mu_h - Agg.\mu_{h-1}| \quad (1.15)$$

En ce qui concerne les types de problèmes de conception, deux catégories principales de problèmes peuvent être identifiées : les problèmes convexes et non convexes. La méthode de pré-dimensionnement proposée est conçue pour s'appliquer dans les deux situations, en tenant compte de ces considérations :

- *Problèmes convexes complets* : cette situation sera comprise lorsque l'ensemble des Caractéristiques peut être modifié afin de maximiser la désirabilité de la solution.
- *Problèmes convexes contraints* : cette situation de conception est lorsque certaines Caractéristiques ne peuvent pas être modifiées. C'est-à-dire que les modifications de l'ensemble des Caractéristiques sont limitées. Par conséquent, il existe une limitation à la maximisation de la désirabilité agrégée de la solution.
- *Problèmes non convexes* : cette situation de conception est présente lorsque certaines Propriétés sont si étroitement contraintes que plusieurs points maximaux locaux peuvent apparaître pendant le processus de calcul.

1.4.2. Évaluation des problèmes convexes

Les problèmes convexes seront résolus par une approche d'analyse complète. En d'autres termes, l'approche de résolution de problèmes est centrée sur l'attribution de valeurs aux Caractéristiques, puis permet d'évaluer si ces valeurs répondent aux critères de conception des Propriétés. Ce processus d'attribution de valeurs n'est pas défini de manière aléatoire ; au contraire, il s'agit d'un processus structuré, qui suit la boucle itérative, où les Caractéristiques sont classées en fonction de leur impact sur la conception. La Figure 1.21 présente le déroulement du processus.

1.4.2.1. Préparation du méthode

Pour que la méthode fonctionne, il est nécessaire de mener le processus de conception (en utilisant la méthodologie montrée à la Figure 1.10). Les informations requises pour la méthode

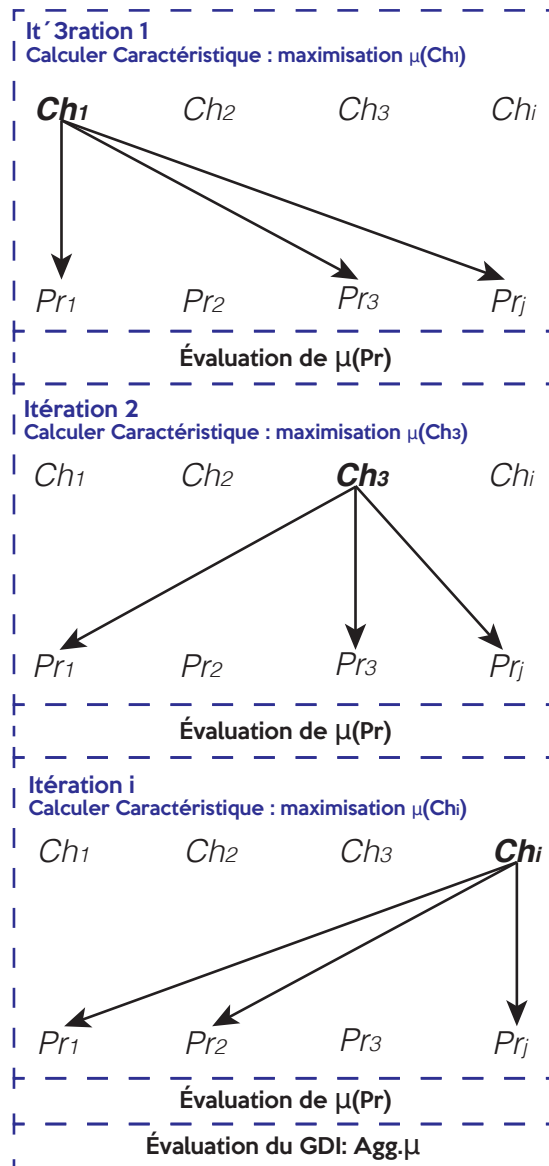

Figure 1.21 : Approche d'analyse pour résoudre des problèmes convexes

sont :

1. *Liste des Caractéristiques* : Il s'agit d'une matrice de taille $[i, 3]$, qui doit contenir le domaine des valeurs possibles pour chaque Caractéristique. Il doit inclure leurs valeurs maximale et minimale, ainsi que la valeur moyenne de leur distribution.
2. *Liste des $\mu_{(\text{Pr}_j)}$* : Cette liste doit inclure les fonctions de désirabilité j des Propriétés. Ces informations doivent inclure la valeur minimale acceptée, la valeur maximale acceptée et le type de fonction de désirabilité, pour chaque Propriété. Ces informations doivent être stockées dans une matrice de taille $[j, 5]$ (deux colonnes supplémentaires pour les fonctions

Pi).

3. *Liste des indexes Ψ* : le plus court chemin normalisé de chaque liaisons Propriété-Caractéristique. Cet index représente l'influence de la Caractéristique sur les Propriétés où elle fait partie. Cette information est stockée sous forme de vecteur.
4. *Arbre de traçabilité* : Le structure CPM/PDD qui permet de comprendre les liens entre les Propriétés et les Caractéristiques.

1.4.2.2. Mise en oeuvre de la méthode itérative

Ce schéma est divisé en trois parties. Dans les premières parties, il est nécessaire d'importer toutes les informations de la conception. Dans la deuxième partie, il est organisé et préparé la boucle d'itération, basée sur les valeurs de ζ . Enfin, la troisième partie est la routine itérative, qui calcule les nouvelles valeurs pour chaque *DCS*. De plus, à des fins d'évaluation, le modèle de propagation est exécuté de manière discrète afin de calculer la fonction de désirabilité des Caractéristiques.

1.4.2.3. Mise en oeuvre de la méthode de pré-dimensionnement dans les problèmes convexes

L'évaluation des problèmes convexes, à l'aide de la méthode de pré-dimensionnement, est la moins contraignante. Il est uniquement contraint par les limites de désirabilité de ses Propriétés, mais suffisamment étroit pour offrir la possibilité d'effectuer une analyse ouverte permettant de définir les valeurs finales des Caractéristiques qui maximisent le GDI de la désirabilité.

Considérant le cas de la conception de la glacière de l'appendice A, le problème est composé de 7 Caractéristiques et de 7 Propriétés. Il peut être écrit ainsi :

Given :

$DCS_0 \{th_A, th_B, th_C, W_C, L_C, H_C, th_{lid}\}$, Espace de Caractéristiques de Conception avec les valeurs du layout préliminaire

Maximiser :

$\max(Agg.\mu_h) \mid DCS_h \{Ch_1, Ch_2, \dots, Ch_i\} \in \mathbb{R}$, Espace de Caractéristiques de Conception qui maximise le GDI mesuré comme la désirabilité agrégée des Propriétés

Par conséquent, le *DCS* associé au layout préliminaire de la glacière est défini comme suit :

$$DCS_0 = \{th_A = 0,0140, th_B = 0,02729, th_C = 0,01384, \\ L_C = 0,3477, H_C = 0,3081, W_C = 0,3141, th_{iid} = 0,034\}$$

Avec les valeurs de DCS_0 , le GDI calculé est zéro ($Agg.\mu(Pr)$) (Voir Tableau 1.9), la solution ne peut pas être acceptée. Sur la base de la valeur de DCS_0 , le SSNV peut être implémenté. La Figure 1.22 présente l'évolution des fonctions de désirabilité après plusieurs boucles. La Figure présente le comportement de la Caractéristique th_B , qui est la Caractéristique avec l'index ζ plus haut (celle qui a le plus d'impact sur la conception). Dans les Figures 1.22b, 1.22d et 1.22f, sont présentés les fonctions de désirabilité propagées de th_B , pendant que dans les Figures 1.22a, 1.22c et 1.22e sont présentés la désirabilité des Propriétés par la modification de th_B .

Concernant les fonctions de désirabilité des Propriétés ($\mu(Pr_j)$) par la modification de th_B , dans la boucle 1, on peut voir la complexité de l'attribution de valeurs pour les Caractéristiques, notamment en raison de la présence de comportements opposés : sur certaines Propriétés, les valeurs élevées génèrent des désirabilités élevées et dans d'autres, des désirabilités nulles. Lorsque les boucles d'itération sont terminées, on peut voir comment le comportement de la solution change. Ce changement peut être vu dans les Figures 1.22b, 1.22d et 1.22f où la désirabilité des Caractéristiques est calculé.

Entre les boucles 1 et 3, le GDI évolue de : $Agg.\mu(Pr)_0 = 0$ comme point de départ ; à la boucle 1, $Agg.\mu(Pr)_1 = 0,006$. À la boucle 2, $Agg.\mu(Pr)_8 = 0,083$. À la boucle 4, $Agg.\mu(Pr)_{15} = 0,367$. Finalement, le processus itératif se poursuit jusqu'au ϵ est inférieur à 0,001, convergeant après 70 itérations et $\epsilon < 0,0001$ après 84 itérations. L'évolution du GDI peut être observée dans la Figure 1.23a où est présentée l'évolution des désirabilité des sept Propriétés à travers le processus itératif, et la Figure 1.23b qui montre la désirabilité agrégée des Propriétés.

De la Figure 1.23 on peut voir que la désirabilité des Propriétés converge et tend à être asymptotique autour de $\mu = 0,57$. Les valeurs des Propriétés à la fin du processus itératif peuvent être observées sur la Tableau 1.9. Ce maximum local de la désirabilité peut être défini comme un maximum global, suivant les Propriétés de ce type de problèmes convexes (Rockafellar, 2015). Considérant la conception de la glacière comme un problème convexe, les valeurs des Propriétés de DCS_{84} , qui maximisent la désirabilité agrégée, sont les suivantes :

$$DCS_{84} = \{th_A = 0,010, th_B = 0,0235, th_C = 0,010, \\ L_C = 0,4406, H_C = 0,2871, W_C = 0,3391, th_{iid} = 0,030\}$$

Sur la base de DCS_{84} , les valeurs des Propriétés peuvent être calculées, ainsi que les désira-

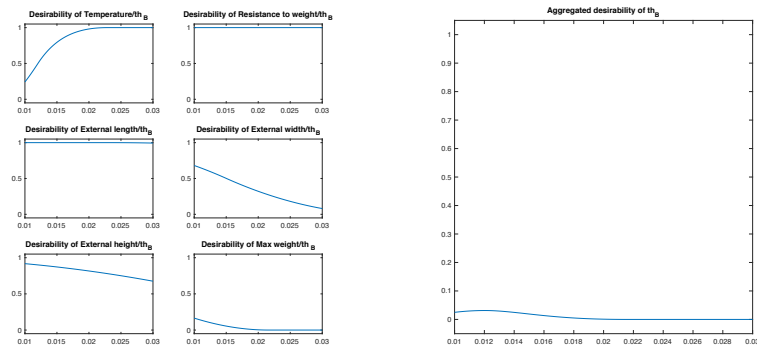

(a) Boucle 1 : $\mu (Pr_j/th_B)$

(b) Boucle 1 : $\mu (th_B)$

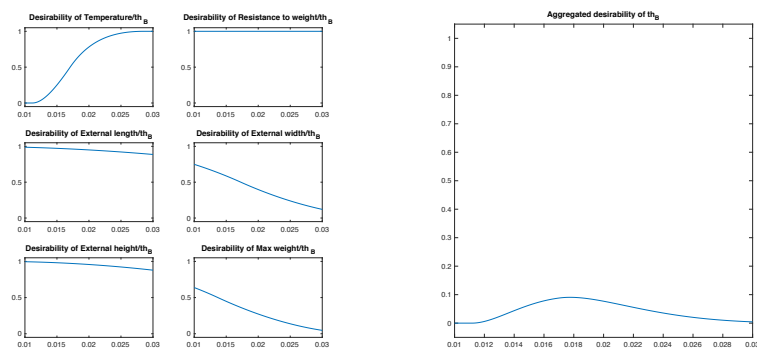

(c) Boucle 2 : $\mu (Pr_j/th_B)$

(d) Boucle 2 : $\mu (th_B)$

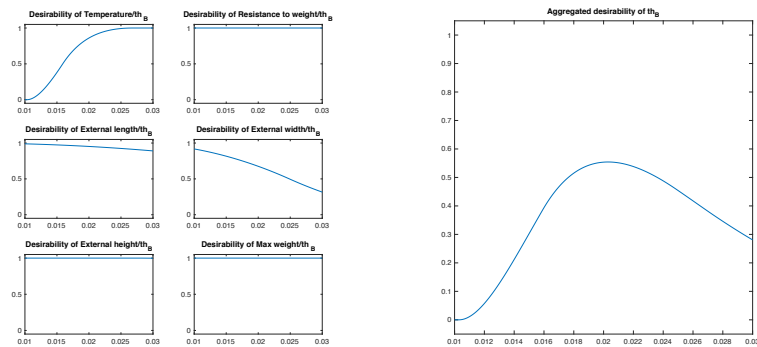

(e) Boucle 3 : $\mu (Pr_j/th_B)$

(f) Boucle 3 : $\mu (th_B)$

Figure 1.22 : Évolution des désirabilités à travers le processus itératif

bilités associées à ces valeurs des Propriétés. Ces résultats sont résumés sur la Tableau 1.9, où l'on peut conclure que l'utilisation de la routine de pré-dimensionnement permet de calculer une combinaison de valeurs des Caractéristiques qui maximise la désirabilité agrégée des Propriétés.

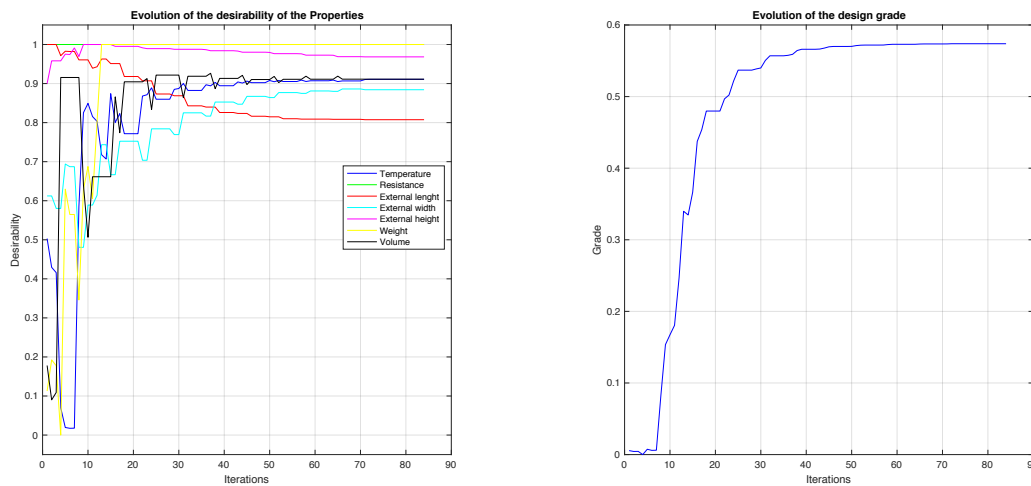

(a) Évolution de la désirabilité des Propriétés

(b) Évolution du GDI

Figure 1.23 : Évolution des indexes de désirabilité à travers le processus itératif

Tableau 1.9 : Valeurs des Propriétés pendant le processus itératif

Pr	Propriétés	Valeur DCS_0	$\mu(Pr_j)$	Valeurs DCS_{84}	$\mu(Pr_j)$
Pr_1	Température interne	4,228°C	1,00	5,345°C	0,911
Pr_2	Résistance	8,124KPa	1,00	8,5525KPa	1,000
Pr_3	Longueur extérieure	0,454m	0,999	0,528m	0,807
Pr_4	Largeur extérieure	0,421m	0,174	0,374m	0,884
Pr_5	Hauteur externe	0,436m	0,747	0,413m	0,968
Pr_6	Poids total	18,475Kg	0	13,717Kg	1,000
Pr_7	Volume interne	37,984l	0,178	42,894l	0,911
	Désirabilité moyenne des Propriétés	$\overline{\mu(Pr_j)}$	0,585	$\overline{\mu(Pr_j)}$	0,926
	Désirabilité des Propriétés agrégée (GDI)	$Agg, \mu(Pr)_0$	0	$Agg, \mu(Pr)_{84}$	0,574

1.4.3. Évaluation des problèmes non convexes

Une différence entre problèmes convexes (où le maximum local est un maximum global), dans les problèmes non convexes, plusieurs maximums locaux peuvent être obtenus, étant plus difficile de trouver un maximum global (avec l'incertitude qu'il n'existe qu'un seul).

En ce qui concerne la méthode SSNV, l'approche proposée pour calculer la propagation de la désirabilité des Propriétés aux Caractéristiques, pose un problème de fiabilité de la méthode SSNV. Dans les problèmes non convexes, la possibilité que le modèle d'agrégation fonctionne rechute dans une situation aléatoire. Ceci peut être observé sur la Figure 1.24, où il est présenté un ensemble de DFF. Sur cette figure, l'intervalle, dans lequel il existe une désirabilité positive

μ_i est donné par la physique du problème et il n'y a pas assez de mécanisme pour éviter que la multiplication de toutes les zones entraîne un nombre différent de zéro.

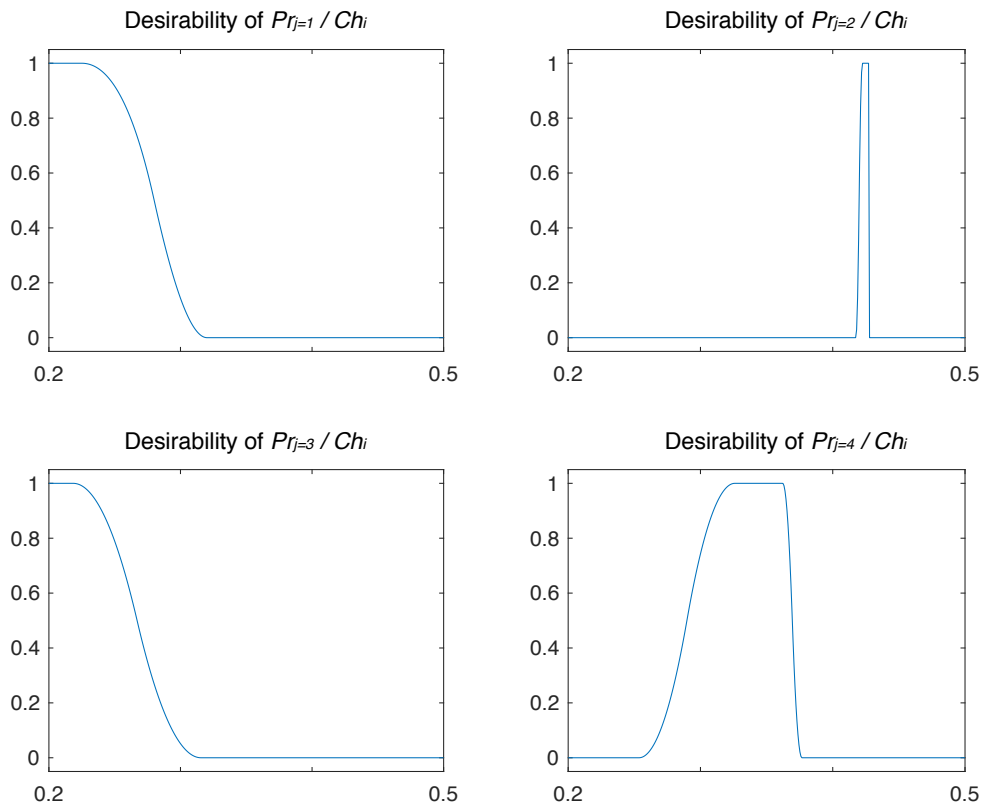

Figure 1.24 : Non-convex aggregation figures

Sur la Figure 1.24, la multiplication des désirabilités donnera zéro. Cela signifie qu'il n'y a pas d'intervalle où une valeur μ supérieure à zéro sera obtenue pour l'ensemble des Propriétés. Ces situations sont courantes dans les problèmes liés aux Propriétés non convexes. Étant donné que la méthode SSVN fonctionne en évaluant l'agrégation de la désirabilité des Caractéristiques, la méthode SSVN pourrait ne pas être en mesure de résoudre des problèmes de cette nature et doit être traitée différemment.

Pour ce type de problèmes, la meilleure stratégie consiste à effectuer une convexification du problème. Pour ce faire, il est proposé une approche « *Synthèse-Analyse* » dans laquelle, en premier lieu, on aborde la solution de la Propriété liée à la situation non convexe, par synthèse. Ensuite, sur la base des combinaisons qui résolvent la Propriété non convexe, une analyse SSVN est exécutée afin de déterminer les autres valeurs des Caractéristiques qui pouvant permettre d'avoir des valeurs élevées de μ pour les autres Propriétés.

La Figure 1.25 présente le schéma utilisé pour résoudre ce type de Problèmes. Les problèmes non convexes sont résolus en deux étapes. La première étape est centrée sur la convexification

du problème, qui est résolue par une approche de « *synthèse* ». La deuxième étape consiste à résoudre la partie convexe du problème, en utilisant l'approche « *analyse* » du SSNV.

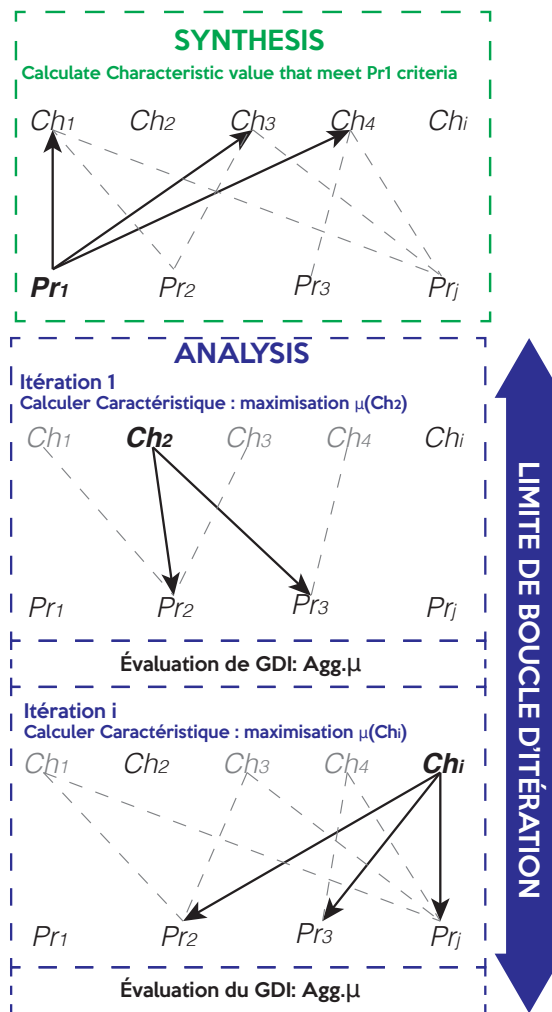

Figure 1.25 : Approche synthèse-analyse pour la résolution de problèmes non convexes

1.4.3.1. Méthode de convexification pour Propriétés non convexities

Pour résoudre un problème non convexe en utilisant la méthode SSNV, il est nécessaire de convexifier le problème. Compte tenu de la nature des problèmes non convexes, la première stratégie de résolution des problèmes est centrée sur la recherche d'une région faisable. Dans le contexte de cette thèse, le processus de recherche des combinaisons qui faisant partie de la région faisable de la solution est composé de trois étapes :

1. Déterminez la Propriété qui compose le problème (la Propriété qui génère la non-convexité) :
Il est important d'identifier quelles sont les Caractéristiques faisant partie du problème. \mathbb{R}^i

espace dimensionnel.

2. Compréhension de l'univers des réponses possibles : synthèse de la Propriété non convexe et définition des valeurs des Caractéristiques permettant un $\mu = 1$ pour la Propriété non convexe.
3. Résoudre les Propriétés à venir : Effectuer SSNV pour rechercher les valeurs permettant de maximiser la désirabilité agrégée des Propriétés.

Sur la Figure 1.26 le schéma proposé pour la convexification du problème est présenté. Le schéma est une version modifiée du SSNV. Pour ce faire, il est nécessaire de calculer un ζ' , en utilisant uniquement les valeurs ρ des relations entre le comportement de la Propriété non convexe et la Caractéristique. Finalement, trois types de problèmes non convexes sont identifiés :

- Application SSNV de problèmes avec une Propriété non convexe
- Application SSNV de problèmes avec plusieurs Propriétés non convexes
- Application SSNV de problèmes lorsque la Propriété non convexe maintient en place l'ensemble des Caractéristiques

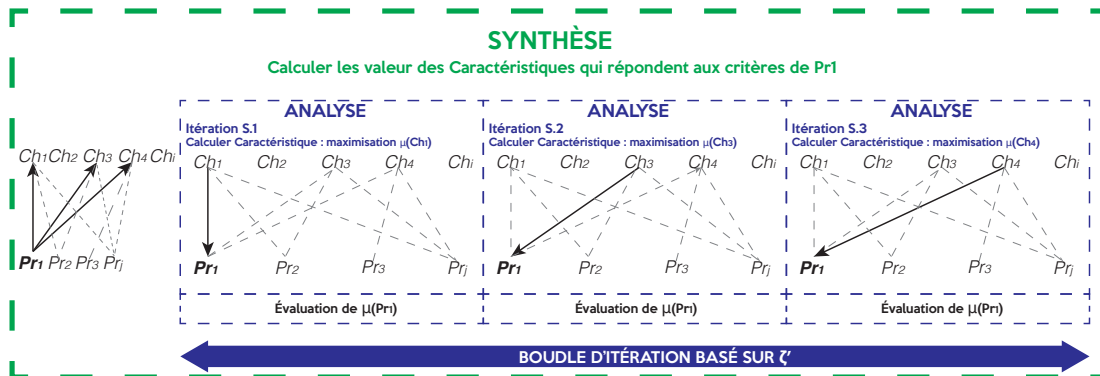

Figure 1.26 : Méthode d'analyse utilisée dans l'opération de convexification

Application SSNV de problèmes avec une ou plusieurs Propriétés non convexes

Cette évaluation est réalisée à l'aide d'une synthèse-analyse. Pour l'utilisation de la méthode de pré-dimensionnement, on examinera la conception de la glacière de l'appendice A et simuler une situation non convexe dans la fonction de désirabilité de la Propriété 5 (hauteur externe). Si on définit $\mu = 1.0$ seulement quand la valeur de la Propriété est $39 \text{ cm} \pm 1$, le problème peut être écrit comme :

État donné :

$DCS_0 \{th_A, th_B, th_C, W_C, L_C, H_C, th_{lid}\}$, valeurs du layout préliminaire

Maximiser :

$\max(Agg.\mu_h) \Rightarrow Pr_5^{non.convex} \mid DCS_h \{Ch_1, Ch_2, \dots, Ch_i\} \in \mathbb{R}$, DCS qui maximisent le GDI mesuré comme la désirabilité agrégée des Propriétés

Après la routine de convexification, il est prévu de calculer la boucle d'itération, basée sur les résultats de l'ASG. Cela permettra de définir l'index ζ' pour résoudre la Propriété avec la non-convexité.

$$\overrightarrow{\zeta'_{boucle}} = [H_C, th_A, th_B, th_C, th_{lid}]$$

De plus, une légère modification doit être envisagée dans l'utilisation de l'algorithme pour trouver la meilleure valeur agrégée de la Caractéristique, qui consiste à évaluer uniquement la Propriété non convexe. Concernant l'évaluation de la boucle, pour la routine de convexification, il est nécessaire de calculer l'erreur ϵ' comme suit :

$$\epsilon_h = |moyenne.\mu_h - moyenne.\mu_{h-1}|$$

Le calcul de ϵ' comme la désirabilité moyenne, plutôt que la désirabilité agrégée, permet de générer des solutions où la désirabilité est élevée, même s'il existe des Propriétés avec $\mu = 0$. Ces Propriétés sont destinées à être résolues lorsque le processus d'analyse est effectué.

Le processus de synthèse se termine par la définition des valeurs pour les Caractéristiques qui génèrent une solution dans laquelle la désirabilité de la Propriété est 1,0 qui est calculé en 10 itérations (qui sont en gras sur la Tableau 1.10). Cela permet de convexifier le problème, évoluant d'un problème composé de 7 Propriétés et 7 Caractéristiques, vers sa forme convexifiée, composée de 6 Propriétés et 3 Caractéristiques. Sous cette forme, 4 Caractéristiques sont déjà fixées. Plus tard pour la partie analyse, après 28 itérations, le résultat de l'algorithme produit une combinaison des valeurs de Caractéristiques qui permet de maximiser la désirabilité agrégée. Les résultats peuvent être observés sur la Tableau 1.10.

En analysant les résultats de la méthode SSNV, on peut en conclure que la méthode est capable d'obtenir une solution, différente de la solution convexifiée, qui présente le plus grand désirabilité pour les Propriétés. Néanmoins, la valeur du GDI est faible. Cela est dû au fait que le problème convexifié n'a pas assez de degrés de liberté permettant d'obtenir une grande désirabilité

Tableau 1.10 : Valeurs des Caractéristiques dans le problème convexifié

Solution	th_A	th_B	th_C	L_C	H_C	W_C	th_{id}
DCS_{10}	0,014	0,025	0,014	0,348	0,302	0,314	0,035
DCS_{28}	0,014	0,025	0,014	0,405	0,302	0,298	0,035

dans toutes les Propriétés. En fait, les μ de poids et de volume sont trop bas, mais restent dans la région réalisable. Cela se produit parce que le problème convexifié n'a pas assez de degrés de liberté qui permettent d'obtenir une désirabilité forte dans toutes les Propriétés. En fait, les μ de poids et de volume sont trop bas, mais ils restent dans la région faisable.

Application SSNV de problèmes lorsque la Propriété non convexe bloque tout le jeu de Caractéristiques

Une autre situation de problème non convexe peut survenir lorsque la non convexité se produit dans la Propriété qui contient la plus grande quantité de Caractéristiques (pouvant être mesurée à l'aide du cadre de traçabilité). Par exemple, dans le cas de la conception de la glacière, un espace contraint de solution de la température (ou du poids) va générer ce phénomène.

Dans ce cas, la convexification du problème ne convient pas, car le processus de convexification résout une Propriété en premier, puis les Propriétés complètes en parallèle. Dans la mesure où une Propriété non convexe contenant toutes les Propriétés ne fonctionnera pas avec ce modèle, il est nécessaire de définir un modèle capable de résoudre ce type de problèmes.

Le modèle convexe ne pourrait pas non plus fonctionner. Sur l'application convexe du SSNV, la boucle d'itération est donnée du maximum au minimum en termes d'impact ζ_{Ch} . Le problème de cette approche sur les problèmes non convexes survient lorsque, dans la première boucle, la Caractéristique ayant le plus grand impact n'arrive pas à calculer une valeur qui génère une opportunité positive, le système tout entier peut avoir tendance à mal calculer la désirabilité globale.

Ce phénomène sera expliqué par la simulation, une situation non convexe pour la Propriété de la température, définissant que $\mu = 1,0$ lorsque la température est $3.5^\circ \pm 1$. l'exécution du SSNV ne trouvera pas de solution et toutes les valeurs des Caractéristiques seront mal notées.

Afin d'éviter ce type de comportement, il est proposé d'utiliser une boucle d'itération inversée. C'est-à-dire que les valeurs du minimum ζ_{Ch} sont arrangées au maximum. Cela permettra d'atténuer d'abord l'influence des Caractéristiques les moins influentes. Pour cette situation, la méthode SSNV prend un certain nombre d'étapes afin de développer une combinaison de Caractéristiques qui maximise la désirabilité agrégée des Caractéristiques. Dans la situation où la température

doit être $3.5^\circ \pm 1$, la méthode SSNV prend 84 itérations pour développer une combinaison de Caractéristiques qui maximise la désirabilité agrégée des Caractéristiques.

1.4.4. Analyse de la méthodologie de conception proposé

Il a été proposé une méthode de pré-dimensionnement permettant de calculer la solution qui maximise la désirabilité agrégée des Propriétés. En ce qui concerne le cadre interactif, l'application de la méthode SSNV calculera une meilleure combinaison de valeurs vers un environnement d'optimisation multi-critères. La Figure 1.27 résume la méthodologie de conception interactive proposée dans cette thèse.

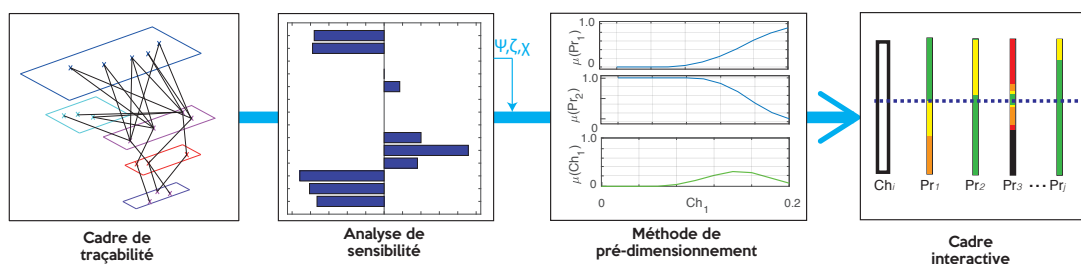

Figure 1.27 : Méthodologie de conception interactive

Avec la méthode de pré-dimensionnement, l'entrée pour le cadre interactif produit de meilleures performances dans la solution. Avec le *DCS* calculé, la modification des valeurs des Caractéristiques s'inscrit dans un scénario plus positif pour l'équipe de conception. C'est-à-dire que la modification d'une Caractéristique, afin d'améliorer une Propriété déterminée, est réalisée avec une incertitude réduite, ainsi que dans un scénario qui présente déjà l'intérêt d'un nombre élevé de Propriétés.

1.5. Validation de la méthodologie de conception préliminaire et interactive

Il est prévu d'appliquer la méthodologie de conception à un cas de conception réel afin de valider l'approche. Pour cette raison, un problème de conception réel a été sélectionné, ainsi qu'une approche de la littérature déjà résolue, afin de disposer d'un point de référence pour analyser les performances de la méthodologie proposée. L'étude de cas porte sur la conception préliminaire d'un Système Photo-Voltaïque Autonome (SAPV). Cette sélection permettra de définir un cadre de comparaison entre les deux solutions, celle de la littérature et celle développée en utilisant la

méthodologie proposée.

1.5.1. Description du cas

De nos jours, l'effet des gaz à effet de serre est l'une des menaces les plus critiques au monde. Les centrales à combustibles fossiles sont l'une des principales sources d'émission (Benson and Orr, 2008). Ces centrales produisent de l'électricité à partir de pétrole, de charbon ou de gaz naturel, générant des tonnes de CO₂ (Rao and Rubin, 2002).

Afin de réduire les gaz à effet de serre, des technologies différentes et plus durables ont vu le jour. L'une de ces technologies est la conversion de l'énergie solaire en électricité à l'aide de générateurs Photo-Voltaïques (PV) (Hoffert et al., 2002). Cette source d'énergie est souvent classée en deux types : i) lorsque le générateur PV est connecté au réseau ii) lorsque le générateur PV n'est pas connecté au réseau, qui s'appelle système photovoltaïque autonome (SAPV) (Akikur et al., 2013).

L'objectif principal d'un SAPV est de transformer le rayon solaire en électricité, où le processus de transformation se fait par l'utilisation de modules PV et le stockage d'énergie électrique à l'aide de batteries. Au milieu de ces deux systèmes, il est nécessaire d'installer un onduleur afin de convertir la sortie en courant continu (DC) du PV en courant alternatif (AC), pour le stockée dans les dispositifs de stockage.

Le principal problème des SAPV est lié à la gestion de l'énergie, aux problèmes liés à la production photo-voltaïque et à la consommation de charge. Cela signifie qu'il faut savoir quoi faire lorsque la charge est inférieure à l'énergie générée et comment gérer la charge lorsqu'il n'y a pas de soleil. C'est ici que les batteries jouent un rôle clé. Les batteries peuvent fournir de l'énergie électrique en transformant l'énergie potentielle stockée dans les produits chimiques, ce qui permet de stocker l'énergie. Cela permet de fournir une demande en énergie même si elle n'a pas été générée sur le même espace/temps de consommation (Fernández-Montoya et al., 2017). La clé de la conception des SAPV est la compréhension des problèmes entre la génération et la consommation de charge. Cette démarche est centrée sur l'équilibrage de la production et du stockage de l'électricité afin de répondre à une charge déterminée. Cette conception intègre les disciplines suivantes : mécanique, électronique et thermique, ce qui en fait une activité de conception multidisciplinaire.

Le contexte de la conception du SAPV sélectionnée est situé dans les régions rurales de l'Afrique subsaharienne. Dans cette zone, le taux de personnes sans accès à l'électricité est alarmant, avec seulement 8% environ (FALL, 2008). Semassou (2011) a proposé une étude pour

analyser la faisabilité de la mise en œuvre des SAPV au Bénin, un pays de l'Afrique subsaharienne situé en l'Afrique de l'ouest. La population du Bénin vit principalement dans les zones rurales.

L'analyse est effectuée pour une ville appelée Dekin qui est situé à 6.5°N, avec une irradiation horizontale globale de 1748 kWh/m² par an (World Bank Group, 2018). En raison de sa position proche de la ligne de l'équateur, le potentiel solaire de Dekin est utile pour une installation à énergie solaire. La consommation moyenne d'une maison rurale est déterminée par une charge de 7 lampes, une radio, un chargeur portable, une télévision, un réfrigérateur, un ventilateur, une machine à repasser et un lecteur DVD (Semassou, 2011).

Le modèle d'optimisation proposé par Semassou (2011) dispose d'un modèle de pondération qui permet de classer les différents objectifs de conception en fonction d'une importance définie par les experts. Ce processus a permis de définir une hiérarchie pour les différents objectifs de conception. Ensuite, la fonction objectif a été triée par ordre décroissant pour les différentes solutions de combinaison, où 3840 solutions candidates ont été évaluées. Ce processus a permis de transformer le problème d'optimisation multi-objectif en une optimisation mono-objectif, en concentrant les efforts sur la fonction de désirabilité globale (Semassou, 2011).

1.5.2. Conception interactive exploratoire : d'étude de cas du SAPV

La première étape nécessite de transformer les exigences du client dans la liste Propriétés. L'interprétation du problème décrit par Semassou (2011) permet d'identifier la liste des exigences du client, qui constitue l'entrée de la méthodologie proposée. Pour la conception des SAPV, trois besoin client sont définies :

- Garantir une viabilité économique [CR_1]
- Garantir un service rendu au consommateur [CR_2]
- Garantir un petit impact sur l'environnement [CR_3]

Sur la base de ces exigences client, l'AFE sera exécuté et définira les fonctions que le SAPV doit accomplir. À partir de ces fonctions, la liste des Propriétés peut être établie (Voir l'appendice D.1 pour le détail si l'utilisation de l'AFE). L'AFE permet de comprendre le comportement du système en établissant des fonctions axées sur le respect des exigences du client. Sur cette base, le CdCF peut être écrit en interprétant les fonctions dans Propriétés. Sur la Tableau 1.11 est lié le CdCF.

Étant donné que l'objectif de la conception est de minimiser les valeurs de Propriétés, la plupart des Propriétés sont interprétées avec les fonctions de désirabilité Z. Cela signifie que plus la valeur

Tableau 1.11 : Cahier de charges fonctionnelles pour le SAPV

F _n	Description	Acceptance criteria	Acceptance limit	μ fonction
FC ₁	Pr ₁ -Coût d'investissement initial	CoI < 5000 €	5000 €	Z [100,5000]
FC ₂	Pr ₂ -Coût de remplacement de composant	CoR < 5000 €	5000 €	Z [100,5000]
FC ₃	Pr ₃ -Coût de maintenance et de réparation	CoMR < 100 €	100 €	Z [0,100]
FC ₄	Pr ₄ -Coût lié à l'indisponibilité du système	NPC _{loss} < 100,000 €	100,000 €	Z [0-100000]
FC ₅	Pr ₅ -Temps de retour sur investissement	TRI < 20 years	20 years	Z [2,20]
FC ₆	Pr ₆ -Taux de délestage énergétique	LPSP < 20%	20%	Pi [0.01,0.02,0.19,0.20]
FC ₇	Pr ₇ -Taux de délestage temporel	LLP < 20%	20%	Pi [0.01,0.02,0.19,0.20]
FC ₈	Pr ₈ -Indicateur d'impact environnemental	C _{dom} < 10 €	10 €	Z [0,10]
FC ₉	Pr ₉ -Temps de Retour Energétique	TRE < 20 years	20 years	Z [3,20]
FC ₁₀	Pr ₁₀ -Émission de CO ₂	GES < 10E8g	10E8g	Z [10E6,10E8]
FS ₁	Pr ₁₁ -Sensibilité de NPC _{loss}	SNPC _{loss} < 20 €	20 €	Z [0,100]
FS ₂	Pr ₁₂ -Sensibilité de TRI	STRI < 10 years	10 years	Z [0,10]
FS ₃	Pr ₁₃ -Sensibilité de LPSP	SLPSP < 3%	3%	Z [0,0.03]
FS ₄	Pr ₁₄ -Sensibilité de LLP	SLLP < 3%	3%	Z [0,0.03]
FS ₅	Pr ₁₅ -Sensibilité de TRE	STRE < 10 years	10 years	Z [0,10]
FS ₆	Pr ₁₆ -Sensibilité de GES	SGES < 100g	100g	Z [0,100]

est basse, mieux c'est. Un autre type de fonction d'appartenance est évalué uniquement dans deux Propriétés : pour LPSP et LLP, on considère les fonctions Pi. Sur ces deux Propriétés, les valeurs hautes ou basses indiquent que le SAPV, soit sur-dimensionné, soit incapable de répondre à la demande énergétique. La définition du type de fonction de désirabilité pour chaque Propriété peut également être observée sur la Tableau 1.11.

En ce qui concerne la prochaine étape de la conception du produit, la recherche de concepts repose sur la compréhension physique de chacune des Propriétés, où les équations décrivant le phénomène sont décrites. Dans l'approche méthodologique proposée, par l'AFI on utilise le FBS + CPM proposé par Malmiry (2016) (Le détail de la mise en œuvre de l'AFI est documenté dans l'appendice E). La mise en œuvre de l'AFI donne lieu à un modèle composé de :

- 3 besoin clients
- 16 Propriétés
- 38 Relations et sous-relations
- 36 Caractéristiques

- 11 Conditions externes

La conception architecturale est composée par deux activités : le développement de la solution et l'amélioration de la solution. L'objectif de la première activité est de comprendre les Caractéristiques du problème afin de développer la première solution, appelée le « *layout préliminaire* ». Cette première solution ne produit pas toujours la meilleure désirabilité, pour lequel il est proposé une approche interactive pour améliorer la solution.

1.5.2.1. Développement systématique d'une solution possible

Parmi les Caractéristiques, trois catégories peuvent être définies : discrètes, deux-valeurs discrètes et fixes. Les variables discrètes sont celles qui peuvent être décrites comme des entiers, par exemple la quantité de modules PV. Les variables discrètes à 2 valeurs sont celles qui peuvent prendre deux valeurs, par exemple, la capacité de la batterie peut être de 75 Ah ou 100 Ah. Les variables fixes sont celles qui, selon la définition du type de composant, ont une valeur unique. En d'autres termes, ces Caractéristiques sont fixées par le concepteur. Par exemple, la durée de vie d'un module PV est de 20 ans. Depuis que le type de module PV a été sélectionné, la durée de vie est une Caractéristique héritée de cette sélection. Afin de définir le layout préliminaire, il est important de définir les intervalles de variation de chaque Caractéristique. Étant donné que le SAPV est composé de différents systèmes, le problème sera résolu sous-système par sous-système.

Analyse des Caractéristiques de chaque sous-système : exemple de module PV

La définition du module PV est directement liée à sept Caractéristiques. Parmi ces Caractéristiques, le type de module PV (T_{PV}) et la quantité de modules PV (N_{PV}) varient. En raison de la structure du toit, la taille des modules PV est limitée. Pour cette raison, T_{bat} est limité à 50 W et 80 W afin de s'adapter aux restrictions du toit.

En ce qui concerne les Caractéristiques complémentaires, celles-ci qui restent fixes depuis la définition du module PV, la définition des variables liées aux modules PV est présentée sur le Tableau 1.12. L'analyse des batteries, onduleur et câbles sont documenté en annexe dans les appendices F.1, F.2 et F.3, respectivement. Aussi, l'analyse des conditions externes est dans l'appendice F.4.

Définition du layout préliminaire

De manière générale, le problème de conception est composé de 7 Caractéristiques sujettes aux variations : N_{PV} , N_{bat} , T_{PV} , T_{bat} , T_{cable1} , T_{cable2} , T_{cable3} . Parmi ces Caractéristiques, deux sont des

Tableau 1.12 : Variables liées au module PV

Caractéristique	Type	Valeur
N_{PV}	Discrètes	[1-12]
T_{PV}	Deux-valeurs discrètes	50 W or 80 W
$Cost_{PV}$	Fixe	4 €/Wh (Thiaux, 2010)
$years_{PV}$	Fixe	20 ans
MMT_{PV}	Fixe	0 (Nema et al., 2010)
$Index_{energy-PV}$	Fixe	9.73 kWh/W
$Index_{GES-PV}$	Fixe	1.65 Kg CO ₂ /Wh

variables discrètes, tandis que les autres sont deux-valeurs discrètes. Pour l'analyse de sensibilité, il est nécessaire de définir les intervalles de variation et les préférences de distribution, défini comme :

- La quantité des modules PV (N_{PV}), qui varie entre [1-12] et souhaitait une distribution faible, cherchant un équilibre entre la production d'énergie et les coûts.
- La quantité des batteries (N_{bat}) qui varie entre [1-10] et souhaitait une distribution faible, cherchant un équilibre entre le stockage d'énergie et les coûts.
- Type de modules PV (T_{PV}), où l'on souhaite une distribution faible afin de maintenir le coût bas.
- Type de batterie (T_{bat}), où l'on souhaite une distribution faible afin de maintenir le coût bas.
- Pour la section transversale du câble 1 (T_{cable1}), où l'on souhaite une distribution faible afin de maintenir le coût bas.
- Section transversale du câble 2 (T_{cable2}), où l'on souhaite une distribution faible afin de maintenir le coût bas.
- Section transversale du câble 3 (T_{cable3}), où l'on souhaite une distribution faible afin de maintenir le coût bas.

Le layout préliminaire DSC_0 est défini sur la Tableau 1.13, avec les valeurs calculées à partir de la simulation Monte Carlo pour les variables discrètes et les deux-valeurs discrètes

Avec les Caractéristiques de DSC_0 , les Propriétés peuvent être calculées comme indiqué sur la Tableau 1.14. Avec cette solution, la désirabilité agrégée des Propriétés est égale à zéro.

Tableau 1.13 : Valeurs du layout préliminaire : DCS_0

Caractéristique	Paramètres de dimulation	Moyenne de Monte Carlo	Valeur définie
N_{PV}	[1-12], <i>low</i>	3,507	4
T_{PV}	[50-80], <i>low</i>	55,3644	50 W
N_{bat}	[1-10], <i>low</i>	2,73	3
T_{bat}	[75-100], <i>low</i>	79,92	75 Ah
T_{Cable1}	[0,45-0,55], <i>low</i>	0,4716	0,45 mm ²
T_{Cable2}	[4,84-12,88], <i>low</i>	6,559	4,84 mm ²
T_{Cable3}	[3,03-4,84], <i>low</i>	3,4093	3,03 mm ²

$Agg.\mu(Pr)$ ne pouvait pas obtenir une désirabilité positive car il y avait deux Propriétés à désirabilité nul, à savoir $LPSP$ et LLP , celles liées au service fourni au consommateur.

Tableau 1.14 : Désirabilité des Propriétés au layout préliminaire

Pr	Propriété	Value	$\mu(Pr_j)$
Pr_1	CoI : Coût d'investissement initial	2370 €	0,5706
Pr_2	CoR : Coût de remplacement de composant	2327 €	0,5869
Pr_3	$CoMR$: Coût de maintenance et de réparation	35 €	0,7550
Pr_4	NPC_{loss} : Coût lié à l'indisponibilité du système	547,5 €	1,00
Pr_5	TRI : Temps de retour sur investissement	3,1 years	0,9872
Pr_6	$LPSP$: Taux de délestage énergétique	64,62%	0,000
Pr_7	LLP : Taux de délestage temporel	63,93%	0,000
Pr_8	C_{dom} : Indicateur d'impact environnemental	3,2 €	0,7896
Pr_9	TRE : Temps de Retour Energétique	8,8 years	0,7669
Pr_{10}	GES : Émission de CO ₂	30854 g	1,00
Pr_{11}	$SNPC_{loss}$: Sensibilité de NPC_{loss}	6,8 €	0,9906
Pr_{12}	$STRI$: Sensibilité de TRI	0 years	1,00
Pr_{13}	$SLPSP$: Sensibilité de $LPSP$	0,4057%	0,80
Pr_{14}	$SLLP$: Sensibilité de LLP	0,4508%	0,70
Pr_{15}	$STRE$: Sensibilité de TRE	0,1 years	0,9998
Pr_{16}	$SGES$: Sensibilité de GES	0g	1,0
	Désirabilité agrégé des Propriétés $Agg.\mu(Pr)$		0,0000

Exploration de solutions : amélioration manuelle de la solution

Étant donné que le layout préliminaire ne produit pas de solution acceptable, on souhaite explorer des solutions en utilisant les égaliseurs du cadre interactive. La Figure 1.28 montre les égaliseurs pour la quantité des batteries (N_{bat}).

Avec la configuration du DCS_0 , aucune des valeurs possibles de N_{bat} ne produira de résultat

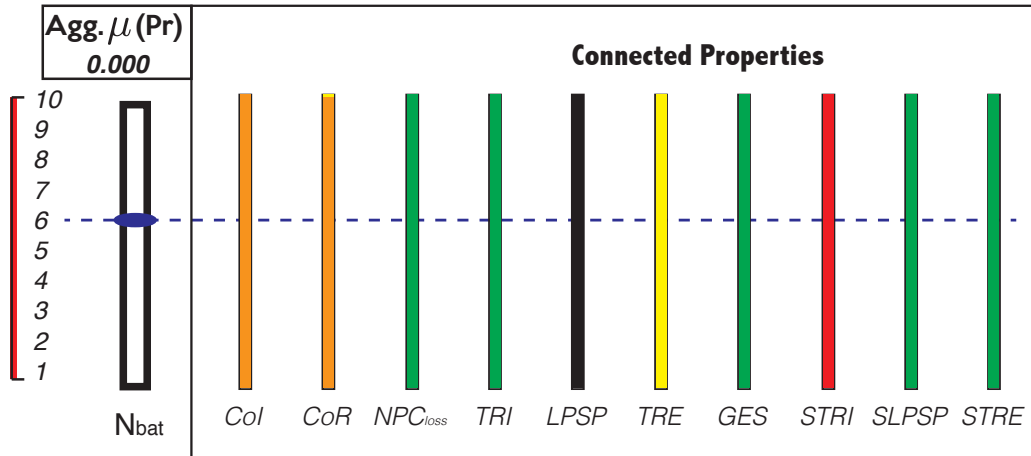

Figure 1.28 : Égaliseurs de la quantité des batteries (N_{bat}) après DCS_0

positif pour $Agg.\mu(Pr)$. Ceci peut être observé visuellement sur la barre rouge à gauche de l'égaliseur de la Figure 1.28

none of the possible values of N_{bat} will produce a positive $Agg.\mu(Pr)$. This can be visually observed on the red bar at the left of the equaliser of Figure 1.28. Néanmoins, le même comportement se produit sur les autres Caractéristiques, ce qui conduit à un scénario d'essais et d'erreur afin de rechercher une meilleure solution. Par exemple, si la quantité de batteries augmente, les valeurs des autres égaliseurs varieront. Par essais et erreurs, définir $N_{bat} = 6$ augmentera la capacité de stockage d'énergie du système SAPV, mais ne produira pas encore de solution souhaitable.

Même avec cette modification, la solution 2 ne produit pas de résultat positif pour $Agg.\mu(Pr)$.

Even with this modification, this solution 2 does not produces a positive $Agg.\mu(Pr)$. Considérant une Caractéristique différente, la vue d'ensemble peut être différente. Par exemple, en considérant la quantité de modules PV, la vue d'ensemble est différente. Sur la Figure 1.29 est présenté l'égaliseur pour la quantité de modules PV N_{PV} .

Avec la modification de $N_{bat} = 6$ et en utilisant l'égaliseur de quantité des modules PV $N_{PV} = 10$ de la Figure 1.29, le performance de la conception est différent. Avec la nouvelle combinaison de quantité de modules PV et de batteries, une solution 3 peut être obtenue. Cette solution produit un $Agg.\mu(Pr)$ positive. La Tableau 1.16 montre les valeurs des Propriétés et leur désirabilité, pour chaque solution explorée.

De la Tableau 1.16, on peut observer que l'approche manuelle pourrait être utilisée afin d'obtenir des solutions présentant une désirabilité positif $Agg.\mu(Pr)$. Néanmoins, le temps nécessaire pour trouver une solution peut être long et cela ne garantit pas que l'on arrive à une solution qui maximise l'GDI. Par conséquent, il est nécessaire d'utiliser la méthode de pré-dimensionnement

Figure 1.29 : Égaliseur pour la quantité des modules PV (N_{PV} .) après la modification du DCS_0

Tableau 1.15 : Valeurs des Caractéristiques du partie exploratoire

Solution	N_{PV}	T_{PV}	N_{bat}	T_{bat}	T_{Cable1}	T_{Cable2}	T_{Cable3}	$Agg, \mu (Pr)$
P,layout	4	50 W	3	75 Ah	0,45 mm ²	4,84 mm ²	3,03 mm ²	0
Solution ₂	4	50 W	6	75 Ah	0,45 mm ²	4,84 mm ²	3,03 mm ²	0
Solution ₃	10	50 W	6	75 Ah	0,45 mm ²	4,84 mm ²	3,03 mm ²	0,0009091

Tableau 1.16 : Évolution de la désirabilité des Propriétés pour l'approche exploratoire

Propriété	P.Layout		Solution ₂		Solution ₃	
	Valeur	μ	Valeur	μ	Valeur	μ
Pr_1-CoI	2370	0,5706	2386,2	0,5646	3577,2	0,1686
Pr_2-CoR	2327	0,5869	2390	0,5632	3554	0,1742
Pr_3-CoMR	35	0,7550	35	0,7550	35	0,7550
Pr_4-NPC	547,5	1,00	547,5	1,00	1368,8	0,9996
Pr_5-TRI	3,1	0,9872	3,1	0,9872	2,5	0,9982
Pr_6-LPSP	64,62%	0,000	57,80%	0,000	13,02%	1,00
Pr_7-LLP	63,93%	0,000	63,93%	0,000	9,84%	1,00
Pr_8-C_{dom}	3,2	0,7896	3,2	0,7896	3,2	0,7896
Pr_9-TRE	8,8	0,7669	8,8	0,7669	3,5	0,9981
$Pr_{10}-GES$	30854	1,00	32880	1,00	31728	1,00
$Pr_{11}-SNPC$	6,8	0,9906	6,8	0,9906	17,1	0,9906
$Pr_{12}-STRI$	0	1,00	0	1,00	0	1,00
$Pr_{13}-SLPSP$	0,4057%	0,80	0,4057%	0,80	1,014%	0,7714
$Pr_{14}-SLLP$	0,4508%	0,70	0,4508%	0,70	1,012%	0,7178
$Pr_{15}-STRE$	0,1	0,9998	0,1	0,9998	0	0,9998
$Pr_{16}-SGES$	0	1,00	0	1,00	0	1,00
$Agg, \mu (Pr)$		0,000		0,000		0,0009091

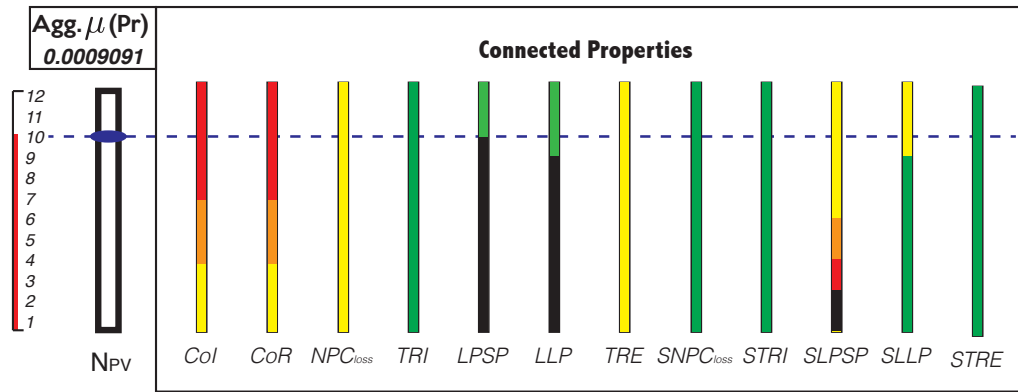
proposée afin de calculer une meilleure solution. Sur la Tableau 1.15 on peut observer les valeurs pour chaque Caractéristique des solutions exploré.

1.5.3. Maximisation de la désirabilité des Propriétés en utilisant la méthode SSNV

Basé sur les valeurs du Monte Carlo, les données d'entrée pour le SSNV peut être défini. Sur la Tableau 1.17 les résultats de l'ASG peuvent être observés.

Tableau 1.17 : Résultats de l'analyse de sensibilité global du SAPV

	N_{PV}	T_{PV}	N_{bat}	T_{bat}	T_{cable1}	T_{cable2}	T_{cable3}
Pr_1-CoI	0,9979	0,9006	0,0865	0,0123	0,0083	0,4361	0,0634
Pr_2-CoR	0,9979	0,9006	0,3944	0,046	0,0041	0,0055	0,0219
Pr_3-CoMR							
Pr_4-NPC	0,9979	0,9006	-0,0273	0,001	0,0043	0,0057	0,0219
Pr_5-TRI	-0,8528	-0,2228	0,021	-0,0081	0,0081	0,0077	0,0142
Pr_6-LPSP	-0,9979	-0,9006	-0,6588	-0,0725			
Pr_7-LLP	-0,9979	-0,9006					
Pr_8-C_{dom}		1					
Pr_9-TRE	-0,85	-0,2167	0,2879	0,0259			
$Pr_{10}-GES$	0,9979	0,9006	-0,0273	-0,027			
$Pr_{11}-SNPC$	0,9979	0,9006	-0,0273	0,001	0,0043	0,0057	0,0219
$Pr_{12}-STRI$	-0,8528	-0,2228	0,021	-0,0081	0,0081	0,0077	0,0142
$Pr_{13}-SLPSP$	0,9979	0,9006	-0,0273	-0,027			
$Pr_{14}-SLLP$	0,9979	0,9006					
$Pr_{15}-STRE$	-0,85	-0,2167	0,2879	0,0259			
$Pr_{16}-SGES$							
ζ	12,3867	9,9844	1,8667	0,2548	0,0372	0,4684	0,1575

Avec les résultats de la Tableau 1.17 l'index χ peut être calculé. On voit que $LPSP$ est la Propriété la plus complexe. En outre, il est constaté que $CoMR$ et $SGES$ n'ont pas de complexité (puisque ses Caractéristiques sont déjà fixées). Néanmoins, neuf Propriétés sont aussi complexes que $LPSP$ à résoudre. Cela indique les niveaux d'attachement de la conception. Ces résultats sont sur la Tableau 1.18.

Comprenant le problème en termes de Propriété qui serait le complexe à définir et de quelles Caractéristiques est le plus influent, la méthode SSNV peut être exécutée. Un premier passage de l'algorithme a mis en évidence des non convexités sur Pr_6-LPSP et Pr_7-LLP , qui est représenté par le comportement de singleton de ces deux Propriétés avec la Caractéristique la plus influente

Tableau 1.18 : Niveau de complexité χ des Propriétés du SAPV

Propriétés	Index χ	Propriétés	Index χ
Pr_1-CoI	21,73180566	Pr_9-TRE	13,23633673
Pr_2-CoR	22,10676382	Pr_{10-GES}	21,41047908
Pr_3-CoMR	0	$Pr_{11-SNPC}$	21,41013337
Pr_4-NPC	21,41013337	$Pr_{12-STRI}$	12,83531116
Pr_5-TRI	12,83531116	$Pr_{13-SLPSP}$	21,41047908
Pr_6-LPSP	22,60089353	$Pr_{14-SLLP}$	21,35263857
Pr_7-LLP	21,35263857	$Pr_{15-STRE}$	13,23633673
Pr_8-C_{dom}	9,9844	$Pr_{16-SGES}$	0

(N_{PV}), comme on peut observer sur la Figure 1.30, où il n'y a que des solutions lorsque $N_{PV} = 6$. D'autres valeurs pour les Caractéristiques seront déterminées dans une solution indésirable. Cet intervalle où μ sera positif est la région faisable, ce qui est très serré dans ce cas.

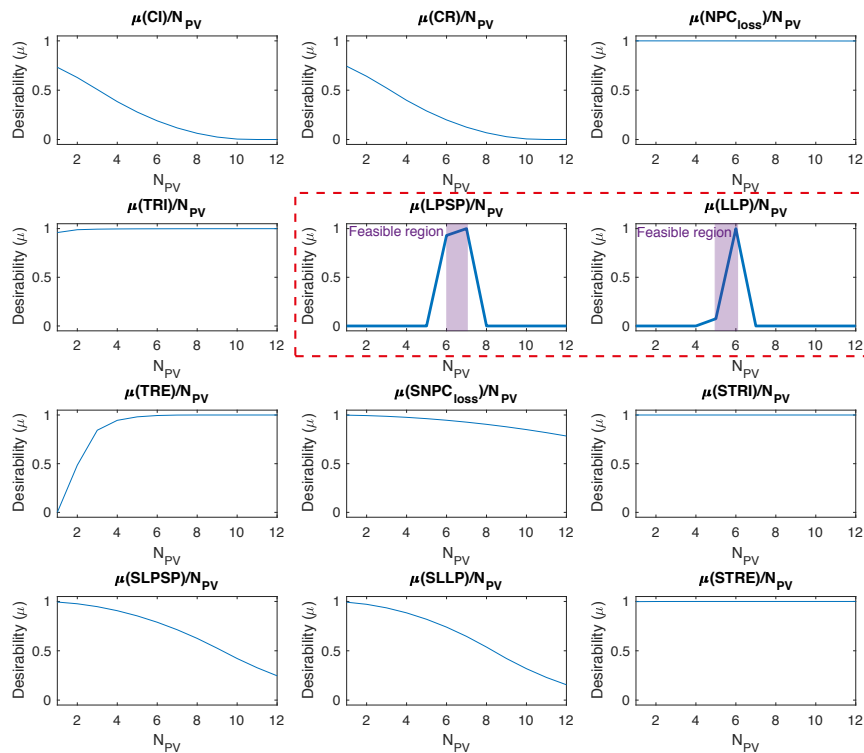

Figure 1.30 : Preuve de non convexités dans le problème

L'utilisation de la boucle d'itération détermine que le problème ne converge pas vers une solution maximisant le GDI, car l'algorithme est stagné dans la non-convexité. Sur les problèmes non convexes, le mécanisme est centré sur la convexification du problème. Les problèmes avec ces Propriétés, spécialement Pr_6-LPSP , où l'index χ est le plus élevé, en plus, d'être liée à la

quasi-totalité des Caractéristiques

Par conséquent, la convexification est centrée sur l'inversion de la boucle d'itération pour traiter en premier les Caractéristiques les moins influentes, qui, dans ce cas particulier le T_{cable3} (Voir la Tableau 1.17). La nouvelle boucle d'itération est définie comme suit :

$$\overrightarrow{\zeta}_{loop'} = [T_{cable3}, T_{cable1}, T_{bat}, T_{cable2}, N_{bat}, T_{PV}, N_{PV}] \quad (1.16)$$

À l'aide de la boucle d'itération modifiée, la méthode SSNV est implémentée afin de rechercher une solution qui maximise le GDI. Cette méthode de pré-dimensionnement calculera la désirabilité des Caractéristiques ($\mu_{(Ch_i)}$) en propageant les fonctions de désirabilité à partir des Propriétés. Le valeur maximum de la fonction $\mu_{(Ch_i)}$ sera défini comme la nouvelle valeur. Ce processus est exécuté de manière itérative, en organisant le processus d'itération à l'aide de la boucle d'itération modifiée.

1.5.3.1. Mise en oeuvre de la méthode de pré-dimensionnement

La méthode de pré-dimensionnement proposée est une approche itérative pour calculer le DCS qui maximise la désirabilité agrégée des Propriétés. Cette méthode est centrée en suivant cette procédure : i) Propager la désirabilité des Propriétés aux Caractéristiques ii) Calculer la désirabilité des Propriétés comme l'agrégation des Propriétés $\mu(Pr/Ch_i)$ iii) Sélection de la meilleure valeur Caractéristique en maximisant $\mu(Ch_i)$ iv) Évaluer le GDI en comme $Agg.\mu(Pr)$.

Cette routine est calculée pour chacune des Caractéristiques suivant la boucle d'itération et l'évaluation de l'erreur à la fin de chaque boucle. Lorsque l'erreur est constante, la solution est trouvée. Les sous-sections suivantes analysent chacune des boucles d'itération.

Évaluation de la boucle 1

Les Caractéristiques les plus importantes du SAPV sont la quantité de modules PV (N_{PV}), le type de module PV (T_{PV}) et la quantité de batteries (N_{bat}).

En utilisant la boucle d'itération de l'équation 1.16, l'analyse commence par T_{cable3} , suivi par T_{cable2} . La troisième Caractéristique de la boucle d'itération est l'évaluation du type de batterie (T_{bat}). Selon l'analyse d'arbre de traçabilité, cette Caractéristique fait partie de onze Propriétés : CoI , CoR , NPC_{loss} , TRI , $LPSP$, TRE , GES , $SNPC_{loss}$, $STRI$, $SLPSP$, $STRE$. Cette compréhension facilite le processus de propagation, car il est uniquement effectué sur des liaisons directes $Pr \rightarrow Ch$.

Pour la boucle 1 le $\mu(Pr/T_{bat})$ peut être observé dans la Figure 1.31a, et le $\mu(T_{bat})$ dans la Figure 1.31b. En analysant les possibilités, on peut observer qu'il existe un changement significatif dans le comportement de Pr_6-LPSP quand la capacité de la batterie est plus élevée. Cela détermine une tendance lors de la modification de la valeur de T_{bat} , car une valeur plus élevée améliorera la solution.

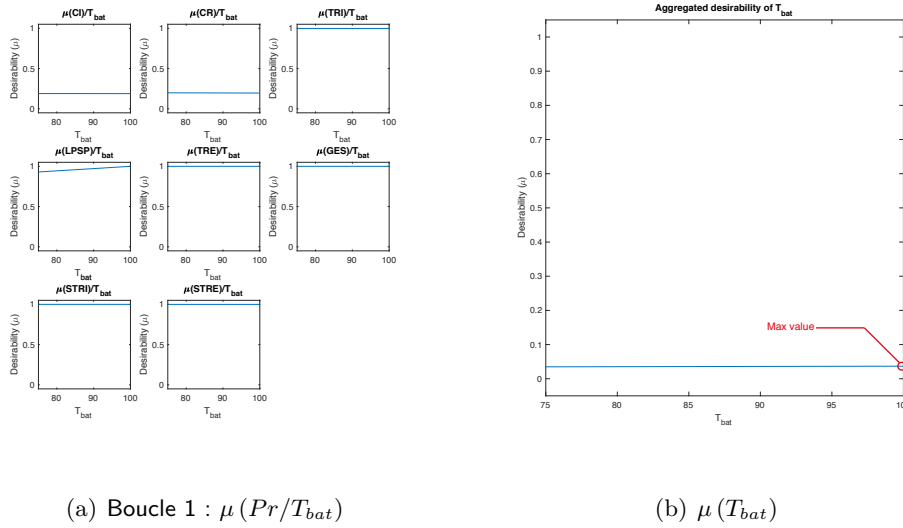

Figure 1.31 : Désirabilité de T_{bat} pour la boucle 1

Ensuite, à la cinquième itération, il est évalué la quantité des batteries N_{bat} . Cette Caractéristique est liée à CoI , CoR , NPC_{loss} , TRI , $LPSP$, TRE , GES , $SNPC_{loss}$, $STRI$, $SLPSP$, $STRE$. Le $\mu(Pr/N_{bat})$ peut être observé sur la Figure 1.32a, et le $\mu(N_{bat})$ sur la Figure 1.32b. En analysant ces desirabilités, on peut constater que, sur la première boucle, l'algorithme n'a pas pu atteindre un maximum pour $\mu(N_{bat})$. Puisque aucune combinaison de batteries a généré une valeur positive pour $LPSP$, aucune valeur supplémentaire de N_{bat} pourrait être définie.

Ensuite, à la sixième itération, le type de module PV T_{PV} est évalué. C'est la Caractéristique avec plus de liaisons, 14 : CoI , CoR , NPC_{loss} , TRI , $LPSP$, LLP , C_{dom} , TRE , GES , $SNPC_{loss}$, $STRI$, $SLPSP$, $SLLP$, $STRE$.

Le $\mu(Pr/T_{PV})$ est sur la Figure 1.33a, et le $\mu(T_{PV})$ sur la Figure 1.33b. On peut observer que les performances de la solution augmentent lorsque le T_{PV} est plus grand. La valeur maximale de la valeur de desirabilité de la Caractéristique correspond à la valeur maximale de son intervalle de variation : 80 W.

Finalement, pour N_{PV} le $\mu(Pr/N_{PV})$ est sur la Figure 1.34a, et le $\mu(N_{PV})$ sur la Figure 1.34b. Cette Caractéristique est liée à 12 Propriétés : CoI , CoR , NPC_{loss} , TRI , $LPSP$, LLP ,

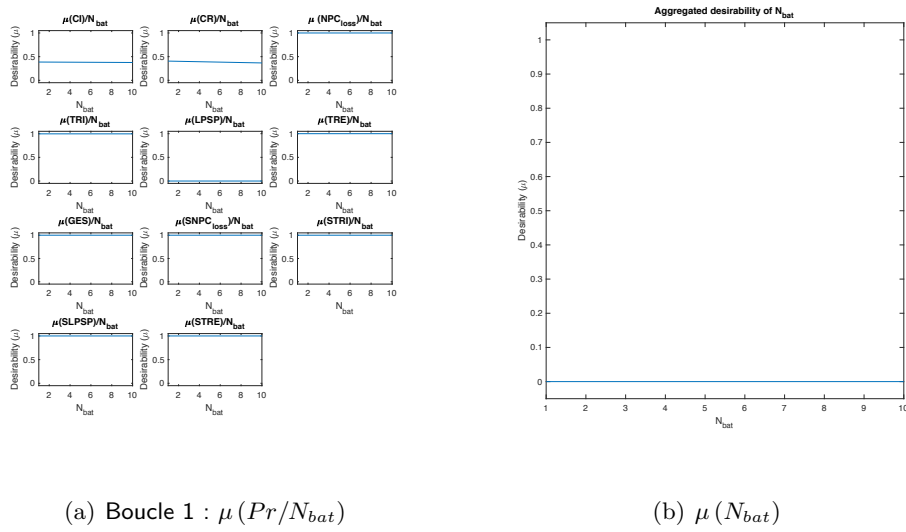

Figure 1.32 : Désirabilité de N_{bat} pour la boucle 1

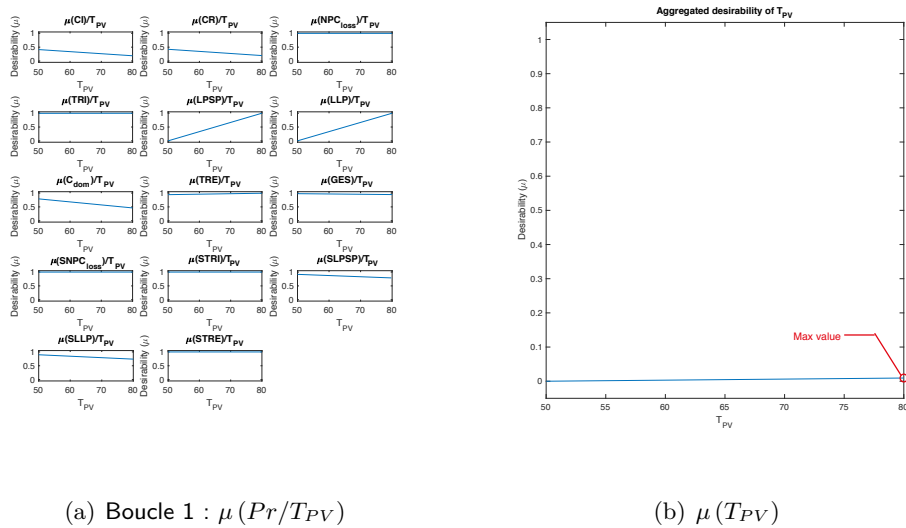
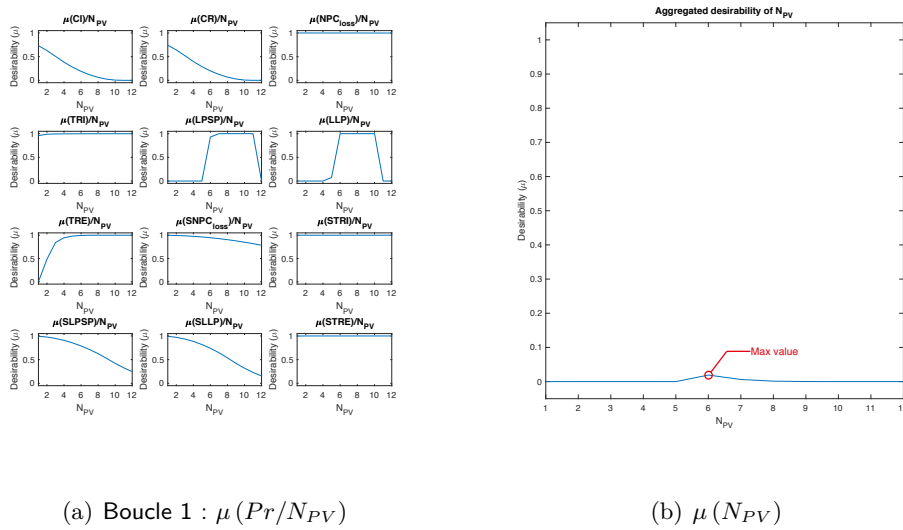

Figure 1.33 : Désirabilité de T_{PV} pour la boucle 1

$TRE, SNPC_{loss}, STRI, SLPSP, SLLP, STRE$.

L'analyse des résultats de calcul, pour $\mu(N_{PV})$ détermine que la désirabilité maximum se produit lorsque $N_{PV} = 6$. A partir de là, la désirabilité de la Caractéristique diminue à mesure que le nombre de modules augmente (Voir la Figure 1.34b.). Plus bas que cela, la désirabilité est nulle car le comportement de $LPSP$.

Aussi, de la Figure 1.34 on peut constater que le singleton sur Pr_6 et Pr_7 a disparu. À la Figure 1.34a, le comportement de Pr_6-LPSP et Pr_7-LLP permet des quantités de modules PV dans une intervalle plus large (Pr_6 [5-11] and Pr_7 [4-10]). L'effet de l'inversion de la boucle d'itération

Figure 1.34 : Désirabilité de N_{PV} pour la boucle 1

permet de fixer d'abord les Caractéristiques avec moins d'influence, ce qui réduit les degrés de liberté du problème. Finalement, sur la Tableau 1.19 les valeurs de la Caractéristique obtenue de la première boucle d'itération sont présentées³. Sur la Table, les valeurs en gras représentent un changement de valeur.

Tableau 1.19 : Valeurs des Caractéristiques pour la boucle 1

Solution	N_{PV}	T_{PV}	N_{bat}	T_{bat}	T_{Cable1}	T_{Cable2}	T_{Cable3}	$Agg.\mu(Pr)$
DCS_0	4	50 W	3	75 Ah	0,45 mm ²	4,84 mm ²	3,03 mm ²	0
DCS_1	4	50 W	3	75 Ah	0,45 mm ²	4,84 mm ²	3,03 mm ²	0
DCS_2	4	50 W	3	75 Ah	0,45 mm ²	4,84 mm ²	3,03 mm ²	0
DCS_3	4	50 W	3	100 Ah	0,45 mm ²	4,84 mm ²	3,03 mm ²	0
DCS_4	4	50 W	3	100 Ah	0,45 mm ²	4,84 mm ²	3,03 mm ²	0
DCS_5	4	50 W	3	100 Ah	0,45 mm ²	4,84 mm ²	3,03 mm ²	0
DCS_6	4	80 W	3	100 Ah	0,45 mm ²	4,84 mm ²	3,03 mm ²	0
DCS_7	6	80 W	3	100 Ah	0,45 mm ²	4,84 mm ²	3,03 mm ²	0,0066955

Évaluation de la boucle 2

Pour la boucle 2, T_{bat} , T_{PV} et les câbles restent sans changer. En ce qui concerne la quantité de batteries (N_{bat}), le comportement est différent de celui de la boucle 1. Sur la boucle 2, un maximum pour $\mu(N_{bat})$ peut être calculé, permettant la méthode d'attribution de $N_{bat} = 4$. Dans le cas de N_{PV} , il y a une légère amélioration de $LPSP$, avec une augmentation de la

³ DCS_1 , DCS_2 , DCS_4 sont les itérations pour les câbles

désirabilité lorsque $N_{PV} = 6$. Néanmoins, la valeur maximale est la même que celle calculée dans la boucle 1, mais avec une meilleure valeur pour la désirabilité de la Caractéristique qui est $Agg.\mu(Pr) = 0,007061$. Sur la Tableau 1.20 les valeurs de la Caractéristique calculées dans cette boucle d'itération sont présentées.

Tableau 1.20 : Valeurs des Caractéristiques pour la boucle 2

Solution	N_{PV}	T_{PV}	N_{bat}	T_{bat}	T_{Cable1}	T_{Cable2}	T_{Cable3}	$Agg.\mu(Pr)$
DCS_8	6	80 W	3	100 Ah	0,45 mm ²	4,84 mm ²	3,03 mm ²	0,0066955
DCS_9	6	80 W	3	100 Ah	0,45 mm ²	4,84 mm ²	3,03 mm ²	0,0066955
DCS_{10}	6	80 W	3	100 Ah	0,45 mm ²	4,84 mm ²	3,03 mm ²	0,0066955
DCS_{11}	6	80 W	3	100 Ah	0,45 mm ²	4,84 mm ²	3,03 mm ²	0,0066955
DCS_{12}	6	80 W	4	100 Ah	0,45 mm ²	4,84 mm ²	3,03 mm ²	0,0070615
DCS_{13}	6	80 W	4	100 Ah	0,45 mm ²	4,84 mm ²	3,03 mm ²	0,0070615
DCS_{14}	6	80 W	4	100 Ah	0,45 mm ²	4,84 mm ²	3,03 mm ²	0,0070615

Évaluation de la boucle 3

Les maximums pour $\mu(N_{PV})$ et $\mu(N_{bat})$ peut être calculée. Après cette boucle, tous les deux, N_{PV} et N_{bat} sont stables, indiquant la convergence de la méthode (aussi, la convergence de ϵ à zéro). Les valeurs des Caractéristiques sont présentées sur la Tableau 1.21.

Tableau 1.21 : Valeurs des Caractéristiques pour la boucle 3

Solution	N_{PV}	T_{PV}	N_{bat}	T_{bat}	T_{Cable1}	T_{Cable2}	T_{Cable3}	$Agg.\mu(Pr)$
DCS_{15}	6	80 W	4	100 Ah	0,45 mm ²	4,84 mm ²	3,03 mm ²	0,0070615
DCS_{16}	6	80 W	4	100 Ah	0,45 mm ²	4,84 mm ²	3,03 mm ²	0,0070615
DCS_{17}	6	80 W	4	100 Ah	0,45 mm ²	4,84 mm ²	3,03 mm ²	0,0070615
DCS_{18}	6	80 W	4	100 Ah	0,45 mm ²	4,84 mm ²	3,03 mm ²	0,0070615
DCS_{19}	6	80 W	4	100 Ah	0,45 mm ²	4,84 mm ²	3,03 mm ²	0,0070615
DCS_{20}	6	80 W	4	100 Ah	0,45 mm ²	4,84 mm ²	3,03 mm ²	0,0070615
DCS_{21}	6	80 W	4	100 Ah	0,45 mm ²	4,84 mm ²	3,03 mm ²	0,0070615

1.5.4. Analyse des résultats de la méthode SSNV sur la conception du SAPV

Après trois boucles d'itération, l'algorithme a convergé, calculant un total de 21 solutions sur le même nombre d'itérations en 29,022 secondes ⁴. Avec la combinaison des valeurs des Caractéristiques de DCS_{21} , La $Agg.\mu(Pr)$ a été calculé en 0,0070615. Les valeurs finales des Caractéristiques peuvent être vues sur la Tableau 1.22.

⁴Sur un 64bit Mac OS avec Matlab 2017a. Processeur 2.5GHz Intel Core i5. Memory 8Go 1600 MHz DDR3

Tableau 1.22 : Valeurs de la Caractéristique qui maximisent l'a désirabilité du SAPV

Solution	N_{PV}	T_{PV}	N_{bat}	T_{bat}	T_{Cable1}	T_{Cable2}	T_{Cable3}
DCS_{21}	6	80W	4	100Ah	0.45mm ²	4.84mm ²	3.03mm ²

En ce qui concerne les valeurs des Propriétés, la Tableau 1.23 résume la désirabilité calculée en utilisant les valeurs des Caractéristiques de DCS_{22} . On peut voir que 11 des Propriétés ont une $\mu > 0.75$ et la Propriétés avec la valeur inférieure de la désirabilité sont Pr_1-CoI et Pr_2-CoR , tous deux liés à la viabilité économique.

Tableau 1.23 : Désirabilité des Propriétés après 21 itérations

Pr	Property $\mu(Pr_j)$	Value	μ
Pr_1	CoI : Coût d'investissement initial	3495,7 €	0,1885
Pr_2	CoR : Coût de remplacement de composant	3468 €	0,1955
Pr_3	$CoMR$: Coût de maintenance et de réparation	35 €	0,7550
Pr_4	NPC_{loss} : Coût lié à l'indisponibilité du système	1324 €	0,9997
Pr_5	TRI : Temps de retour sur investissement	2,6 years	0,9981
Pr_6	$LPSP$: Taux de délestage énergétique	18,2137%	1,00
Pr_7	LLP : Taux de délestage temporel	13,45%	1,00
Pr_8	C_{dom} : Indicateur d'impact environnemental	5,2 €	0,4629
Pr_9	TRE : Temps de Retour Energétique	3,9 years	0,9947
Pr_{10}	GES : Émission de CO ₂	31125 g	1,00
Pr_{11}	$SNPC_{loss}$: Sensibilité de NPC_{loss}	14,4 €	0,9460
Pr_{12}	$STRI$: Sensibilité de TRI	0 years	1,00
Pr_{13}	$SLPSP$: Sensibilité de $LPSP$	0,9736%	0,7893
Pr_{14}	$SLLP$: Sensibilité de LLP	1,0818%	0,7399
Pr_{15}	$STRE$: Sensibilité de TRE	0 years	1,00
Pr_{16}	$SGES$: Sensibilité de GES	0g	1,00
	Désirabilité agrégé des Propriétés $Agg, \mu(Pr)$		0,0070615

Finalement, les Figures 1.35a-b-c représentent l'évolution de la désirabilité des Propriétés, selon les exigence de client ils font partie. Aussi, sur la Figure 1.36 on peut regarder l'évolution du GDI du système.

1.5.5. Discussion de la mise en œuvre de la méthodologie interactive

L'algorithme a été en mesure de proposer une solution qui maximise la $Agg, \mu(Pr)$. Cette solution proposait, pour les Caractéristiques les plus influentes, que la quantité de modules PV (N_{PV}) d'être six et la quantité de batteries (N_{bat}) d'être quatre. En ce qui concerne l'analyse faite par Semassou (2011), sa solution a donné les mêmes résultats : 6 modules PV de 80 W

(a) $\mu(Pr)$ de la viabilité économique(b) $\mu(Pr)$ de la viabilité environnementale(c) $\mu(Pr)$ du service fourni aux consommateurs

Figure 1.35 : Évolution des désirabilités des Propriétés du SAPVS à travers des itérations

et 4 batteries de 100 Ah. Le problème peut être résolu, soit en utilisant l'approche OIA, soit en maximisant la désirabilité du problème modelé sur CPM/PDD.

En ce qui concerne l'évaluation des résultats, l'analyse principale peut être réalisée sur la base de l'évolution de l'indice de désirabilité, qui représente la $Agg.\mu(Pr)$. Cette évolution peut être observée à la Figure 1.36. Sur cette figure, on peut voir que, sur les 3 premières itérations, la désirabilité de la solution était nulle. Plus tard, l'algorithme a commencé à trouver des combinaisons

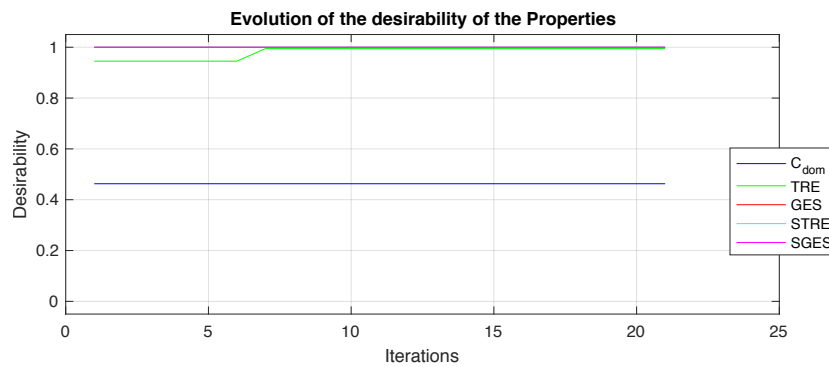
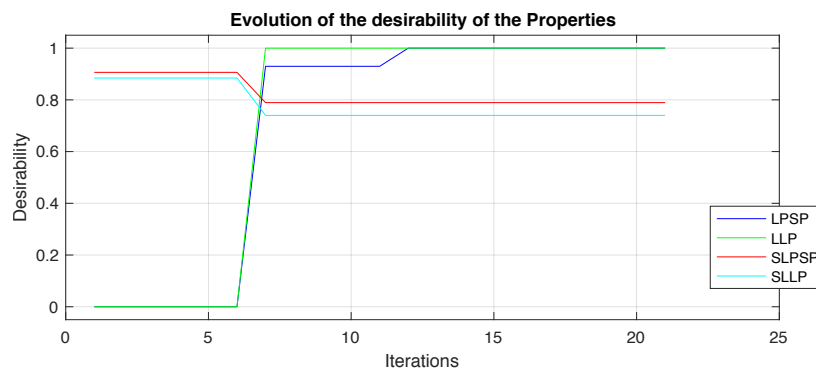
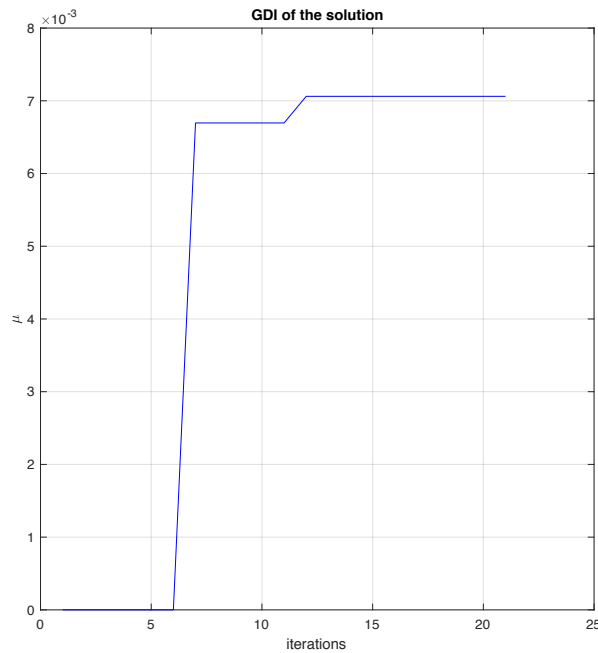

Figure 1.36 : Évolution de la désirabilité agrégée des Propriétés à travers des itérations

de valeurs des Caractéristiques pour finalement devenir asymptotique à $\mu = 0,07689$.

L'utilisation du cadre interactif peut être utilisée pour comprendre comment d'autres modifications des Caractéristiques affectent la désirabilité de chaque Propriété. Sur la Figure 1.37 il est présenté l'égaliseur pour la Caractéristique N_{bat} .

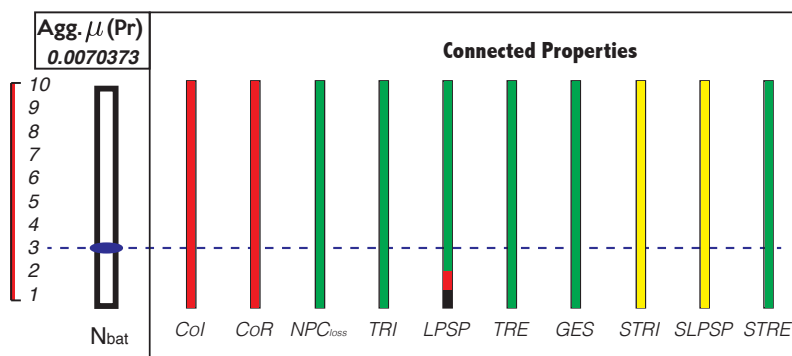

Figure 1.37 : Égaliseur de la quantité de la quantité des batteries

L'analyse de l'égaliseur pour N_{bat} , de la Figure 1.37, on peut constater qu'un nombre inférieur à 2 batteries détermine une désirabilité nulle de la $LPSP$. À partir de 3 batteries it can be observed that a number below 2 of batteries determines a null desirability of the $LPSP$ (Energy outage

rate). From 3 batteries, le système sera classé en fonction de la désirabilité positif, et après 4, en désirabilité vert ($\mu > 0,8$). En outre, on peut constater que, quelle que soit la quantité de batteries, les Propriétés liées au coût d'investissement et au coût de remplacement seront classées en rouge.

L'utilisation d'un cadre interactif améliore le processus de prise de décision en informant de la manière dont les modifications affectent la conception. Dans ce cas, le cadre permet de comprendre les limites des modifications d'une Caractéristique sélectionnée sur la performance de la conception. Dans ce cas, en utilisant les valeurs de DCS_{21} , celles qui maximisent la désirabilité, il n'existe aucune valeur de N_{bat} permettant de produire une désirabilité verte.

1.6. Conclusions et perspectives

Dans le cadre de la recherche, plusieurs problèmes relatifs au processus de conception préliminaire ont été identifiés. Essentiellement, les problèmes liés aux différentes relations entre les objectifs de conception et les variables de conception, représentant plusieurs problèmes d'interprétation. Cela a conduit à axer la recherche sur la définition d'un cadre permettant au processus de prise de décision de s'autonomiser. Ces problèmes peuvent être résumés en trois : i) comment classer les relations entre les objectifs de conception et les variables ii) comment visualiser ces relations iii) comment utiliser la compréhension de ces relations afin de soutenir le processus de prise de décision aux premières étapes de la conception .

La classification des relations entre les objectifs de conception et les variables de conception a conduit à la définition d'un programme de travail permettant la compréhension de ces connexions. Ainsi, la sélection de l'approche CPM/PDD permet de classer les différents types d'informations présentes dans un processus de conception, en déterminant les différentes couches d'informations : Besoins du client (CR), Propriétés (Pr), Relations (Rel), Caractéristiques (Ch) et Conditions externes (EC). Ce cadre est centré sur la compréhension des liens entre les objectifs de conception (Propriétés) et les variables (Caractéristiques), et son utilisation joue un rôle principal dans les conceptions multidisciplinaires complexes en raison de la quantité de relations pouvant exister (Weber and Werner, 2001).

L'utilisation de l'approche CPM/PDD permet de comprendre les relations entre les Propriétés et les Caractéristiques. Elle a donc été utilisée comme pierre angulaire de la méthodologie de développement de nouveaux produits proposée dans la thèse. La méthodologie de conception proposée est axée sur l'utilisation de différents outils de conception dans la conception initiale

avec un premier objectif de la construction d'un cadre de traçabilité : un modèle de gestion de l'information permettant l'interconnexion d'informations à la conception préliminaire, en reliant les informations des variables linguistiques jusqu'aux variables de conception. La sélection des outils visait les outils de sélection permettant de connecter des informations entre couches et de générer des informations précieuses sur chaque connexion du cadre de traçabilité.

Pour relier les informations entre les couches, la proposition incluait des outils bien structurés dans la littérature, tels que QFD qui génère des connexions entre les exigences du client (variables linguistiques) et les Propriétés (variable critères) et AFE qui définit la construction de la liste des Propriétés en fonction de la AV. En outre, des méthodes plus courantes ont également été envisagées. Par exemple, la méthode proposée par Malmiry en 2016, qui fusionne des outils d'analyse fonctionnelle internes, tels que FBS et CTOC, avec CPM/PDD afin de générer des connexions entre les Propriétés, les Caractéristiques et les Conditions externes.

L'objectif fondamental du cadre de traçabilité était de générer des informations précieuses qui renforceront le processus de prise de décision. Sa définition établit une frontière entre ce qui existe dans la littérature et quels sont les apports proposés par ce travail. Ces contributions peuvent être classées en deux catégories : contributions scientifiques et contributions techniques.

En ce qui concerne les contributions scientifiques, il est proposé une approche hybride : une partie interactive exploratoire, dans laquelle les concepteurs peuvent modifier les Caractéristiques et comprendre comment ces modifications peuvent avoir une incidence sur les Propriétés et une partie inductive interactive, axée sur la détermination de la meilleure combinaison de valeurs des Caractéristiques maximisant la désirabilité des Propriétés.

Les bases de la méthode SSNV⁵ ont été étayées par une analyse de sensibilité globale et locale et une théorie des graphes. L'utilisation des analyses de sensibilité avec Monte Carlo permet de quantifier l'incertitude en termes de compréhension de la sensibilité des relations et Propriétés à la variation de ses Caractéristiques. Les résultats ont permis de proposer trois indices :

- Index ζ , basé sur les résultats de l'analyse de sensibilité globale de chaque Propriété. La disposition des différents (ζ_i) définit la façon dont l'algorithme itératif résoudra le problème de la maximisation, en classant les Caractéristiques de plus influent à moins influent.
- Index ψ , basé sur l'analyse de sensibilité locale. Cet index est lié au chemin plus court entre une Caractéristique et une Propriété. Cet indice a été utilisé pour pondérer chaque Caractéristique dans le calcul du $\mu(Ch_i)$. Cela a permis d'améliorer la valeur des Propriétés

⁵La méthode de pré-dimensionnement permettant de déterminer la meilleure combinaison de valeurs des Caractéristiques maximisant l'attrait général des Propriétés

où la Caractéristique est plus influente, c'est-à-dire si Ch_1 a un index psi de 0.9 avec Pr_1 et 0.45 avec Pr_2 , une modification de la Caractéristique aura plus influence sur Pr_1 . De là, la fonction de désirabilité des Caractéristiques tient compte l'information de cet index.

- Index χ permet de comprendre à quel point les Propriétés sont attachées. Une Propriété avec une valeur faible est une Propriété moins attachée, c'est donc une Propriété plus facile à résoudre. Les Propriétés avec des valeurs plus élevées sont plus complexes à résoudre, car elles sont associées à plus de Caractéristiques et, de manière collatérale, à plus de Propriétés.

La définition de ces indices a permis de réduire la subjectivité de la manière comment la décision est prise dans la conception. La définition de l'algorithme itératif et la pondération de son calcul sont basées sur les résultats de l'analyse de sensibilité. Leur mise en œuvre est basée sur la gestion des incertitudes, ce qui permet de comprendre les modifications apportées dès la conception.

De plus, un des apports principaux de ce travail a été l'élaboration d'une méthode permettant de maximiser la désirabilité agrégée des Propriétés, soit la nature du problème (convexe ou non convexe). Il a également été procédé à des explorations sur la manière dont la méthode proposée fonctionnait sous différents types de problèmes : Caractéristiques contraignantes et définition de multiples fonctions de désirabilité de singleton sur les Propriétés.

Cette exploration a été réalisée dans le but de valider la robustesse de la méthode. La méthode SSNV a été utilisée pour maximiser la désirabilité des Propriétés agrégées dans les conditions de non convexité suivantes :

- Lorsque la non-convexité est présentée sur une Propriété qui ne contient pas l'ensemble des Caractéristiques, il est proposé une approche de synthèse-analyse. Tout d'abord, une approche de synthèse est effectuée afin de convexifier le problème en résolvant la Propriété avec la non-convexité et en définissant la valeur des Caractéristiques répondant à la restriction. Plus tard, l'approche d'analyse est réalisée afin de définir les valeurs des Caractéristiques pour les autres Propriétés.
- Lorsque la non-convexité est présentée sur deux Propriétés ou plus (qui ne contiennent pas toutes les Caractéristiques), la stratégie est centrée sur la convexification du problème et la recherche de la solution du problème sous une approche de synthèse-analyse.
- Lorsque la non-convexité est présentée sur une Propriété qui contient l'ensemble des Caractéristiques, la stratégie consiste à inverser le vecteur de boucle d'itération afin de laisser à

l'algorithme d'abord les Caractéristiques ayant le moins d'influence sur la conception. Cela permettra de réduire les degrés de liberté dans le problème en fixant d'abord les Caractéristiques les moins influentes, ce qui permettra de réduire la quantité de variables du problème à chaque itération.

En ce qui concerne la contribution technique, il a été proposé un ensemble d'outils afin de soutenir l'approche interactive exploratoire. L'utilisation de l'égaliseur a été utilisée pour faciliter le processus de prise de décision en informant les concepteurs de l'impact des modifications sur la désirabilité de chaque Propriété. De plus, l'utilisation de CPM/PDD pour la génération de l'arbre de traçabilité permet une vérification visuelle des liaisons entre les Caractéristiques et les Propriétés. Il est proposé d'intégrer les contributions techniques dans un cadre d'interface Web (voir l'appendice B) afin de faciliter l'interaction des utilisateurs. Sur la Figure 1.38, on peut observer le cadre interactif développé utilisé dans une surface multi-touche. Le cadre interactif facilite la modification des valeurs des Caractéristiques en glissant dans un égaliseur (Voir l'appendice B.1 pour plus d'informations sur l'application).



Figure 1.38 : Interactive framework equaliser in multi-touch surface

Finalement, en ce qui concerne la nouveauté de la méthode, bon nombre des méthodes d'amélioration de la conception évaluées dans cette thèse traitaient à la fois de la définition des fonctions de désirabilité pour les objectifs de conception et de l'agrégation en tant que technique de calcul de l'indice de désirabilité global, en particulier des méthodes OIA (Quirante(2012), Colignan(2012) and Semassou(2011)). À la différence de l'OIA, on a utilisé dans cette thèse une approche CPM/PDD permettant d'établir des liens directs avec les Caractéristiques et les Pro-

priétés. Le fait d'avoir ces connexions permet à la méthode d'aborder le problème sous un angle différent et permet de proposer la méthode SSNV et une nouvelle approche pour trouver une solution permettant de maximiser l'indice de désirabilité global sans recourir à des algorithmes génétiques.

Perspectives

Cette thèse était centrée sur le développement d'une méthodologie interactive pour soutenir les processus de prise de décision en conception multidisciplinaire. Néanmoins, le niveau d'interactivité est encore très manuel. Même si les égaliseurs facilitent la compréhension de l'impact d'une modification sur la conception, son utilisation doit être simplifiée.

Pour le moment, le cadre est construit dans Matlab et nécessite l'installation de ce logiciel et de deux bibliothèques spécifiques : *Fuzzy Logic Toolbox* (logique floue) et *Statistics and Machine Learning Toolbox* (Statistiques et apprentissage machine). Cela génère que la portabilité de l'outil est limitée. L'une des premières perspectives est centrée sur le développement d'un outil autonome, afin d'élargir la convivialité de la méthode interactive à d'autres plateformes. Cet outil doit être multi-plateforme et compatible avec multi-utilisateur.⁶

Jusqu'à présent, l'utilisation des outils et méthodes proposés n'a pas été testée avec les utilisateurs de l'industrie, mais avec des ingénieurs des centres de recherche. De toute façon, il est important que les ingénieurs ont niveau Master. Il est important que les utilisateurs de la méthode soient familiarisés avec la conception multidisciplinaire et possèdent une solide expérience en modélisation mathématique.

De même, il est prévu de valider à quel point il est facile pour les utilisateurs de manipuler la méthode. Dans la méthode proposée, le processus de maximisation est une « *maximisation de boîte transparente* », dans lequel plusieurs paramètres (fonctions de désirabilité) peuvent être facilement modifiés. Il est nécessaire que les ingénieurs comprennent le concept avant d'interagir avec la méthode.

⁶Qui supporte plusieurs interactions en utilisant simultanément la plate-forme

Part II

Thesis manuscript in English

Notations

List of sub-indexes:

l :	Quantity of Customer Requirements
j :	Quantity of Properties
i :	Quantity of Characteristics
k :	Quantity of Relations and sub-relations
m :	Quantity of External Conditions
h :	Quantity of Design Characteristic Spaces

Greeks letters:

μ	Membership functions for noting desirability
ρ	Influence of the Characteristic on the Property from GSA
ζ	Sum of the absolute value of Characteristic's ρ
ψ	Normalised sum of the path weights between two elements
ξ	Complexity of solving a Property

List of abbreviations used on Chapter 2:

<i>APTE</i>	APplication aux Techniques d' Entreprise
<i>CdCF</i>	Cahier des Charges Fonctionnelle
<i>CPM</i>	Characteristics-Properties Modelling
<i>CSP</i>	Constraints Satisfaction Problem

<i>CTOC</i>	Converter-Transmitter-Operator-Control
<i>DSM</i>	Design Structure Matrices
<i>EFA</i>	External Functional Analysis
<i>FA</i>	Functional Analysis
<i>FAST</i>	Function Analysis System Technique
<i>FBD</i>	Function Block Diagram
<i>FBS</i>	Function-Behaviour-Structure
<i>FC</i>	Constraint Functions
<i>FS</i>	Service Functions
<i>IFA</i>	Internal Functional Analysis
<i>OIA</i>	Observation-Interpretation-Aggregation
<i>PDS</i>	Product Design Specification list
<i>PDD</i>	Property-Driven Development
<i>QFD</i>	Quality Function Development
<i>SBF</i>	Structure-Behaviour-Function
<i>TF</i>	Technical Functions
<i>UM</i>	Uncertainty Management
<i>VA</i>	Value Analysis

List of abbreviations used on Chapter 3:

SA: Sensibility analysis

List of abbreviations used on Chapter 4:

GSA Global Sensibility Analysis
LSA Local Sensibility Analysis
PRCC Partial Rank Correlation Coefficient
PDF Probability Density Function

List of abbreviations used on Chapter 5:

AHP Analytic Hierarchy Process
DCS: Design Characteristic Space

<i>DDF</i>	Dynamic Desirability Functions: $\mu_{(Pr_j)/Ch_i}$
<i>DOI</i>	Desirability objective index
<i>DSM</i>	Design Structure Matrices
<i>GDI</i>	Global desirability index
<i>MCDM</i>	Multi-Criteria Decision-Making
<i>Mol</i>	Method of Imprecision
<i>OWA</i>	Ordered Weighted Averaging
<i>UT</i>	Utility Theory
<i>WPM</i>	Weighted Product
<i>WSM</i>	Weighted Sum Model

List of abbreviations used on Chapter 6:

<i>PV</i>	Photo-Voltaic
<i>SAPVS</i>	Standalone Photo-Voltaic System

CHAPTER 2

General Introduction

Decision-making processes in design often challenge designers to prioritise specifications and variables in order to develop solutions that are closer to product's requirements. To support their decisions, different tools and methods are used by engineers and designers allowing to reduce uncertainty in design. Nevertheless, many of these decision support systems are focused in late design stages, such as detailed design and manufacturing design, even if the possibility to influence a new product is higher in early stages (Wang et al., 2002).

The issues regarding decision-making situations are often to the multidisciplinary nature of design. The modification of geometric-related variables that affect the performance of a solution. Consequently, the fact of tracking the propose of such modifications might generate reprocessing and loss of time. The manually-tracking process in order to check how a modification impacts on the design leads to a reprocessing, especially when the relations between variables are complex and they are not easily identifiable by analysing equations, leading to a manual analysis of requirements. The problem is even complex when several optimal solutions could be determined for the solution of the design.

One of the preliminary purposes of this research is a traceability model. The model includes a structure to manage the input requirements (in the linguistic field) up to the variables definition (in the real numbers field). This empowers designers to understand the connection between design objectives and design variables, at any moment.

Based on the availability of the information of the relationship between objectives and variables,

it is intended to generate decision-making tool that supports engineers, whether it is necessary to improve a given design specification or to modify a variable without affecting the product performance. The main objective of this thesis is to generate a method that can obtain a trade-off among the aggregation of design objectives, by modifying the values of the design variables in a multidisciplinary design.

2.1. Context of the research

2.1.1. Basic principles of design context

Systematic and axiomatic design are considered among the most classic design theories. The systematic design approach is based on analysing the customer needs and performing a sequential decomposition of their requirements. The problem is addressed following this decomposition in stages and solving each stage at a time (Pahl et al., 2007). This process can be followed by implementing different tools to each stage and preparing determined deliverables to each stage. This methodology can be observed on Figure 2.1.

Regarding the axiomatic design, it is centred on analysing the transformation of customer needs into process variables, by empowering the analysis and decision-making process by the use of two axioms (Suh, 1990):

1. The Independence Axiom: a good design consists of breaking down a complex problem into independent subproblems of acceptable complexity, making functional requirements independent of one another.
2. Information Content Axiom. Minimise the information content of the design.

Different authors have performed comparisons between both approaches. Some differences can be summarised as (Drăghici and Banciu, 2007; Tate, 1999; Scaravetti, 2004):

- In systematic design, the solution finding process is centred in solving and identifying sub-function, and the process will allow finding a solution without omitting a sub-function. In axiomatic design, the process is centred in concepts of hierarchies and zigzagging between domains.
- In systematic design, there is one main function declare, and sub-functions are stated to satisfy the main function. In axiomatic design, this concept does not exist and the whole functional requirements are considered to be satisfied by its corresponding design parameter.

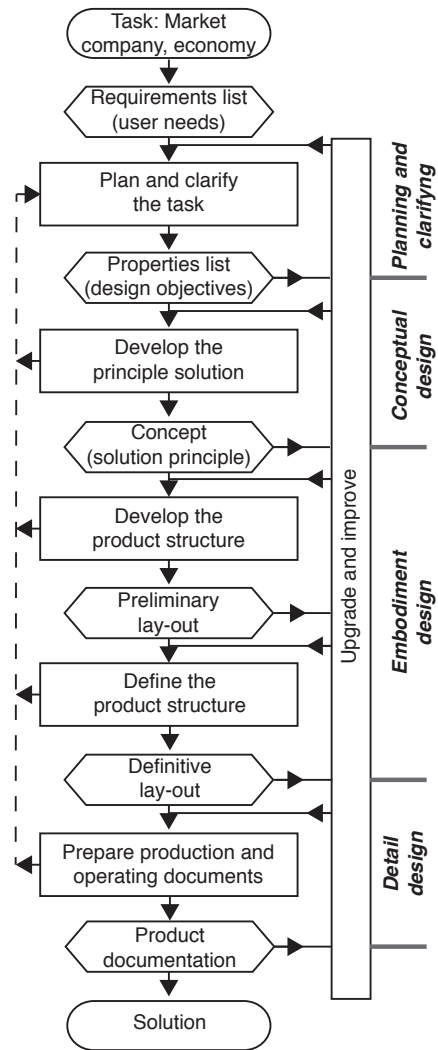

Figure 2.1: Systematic Design Methodology. Adapted (Pahl et al., 2007)

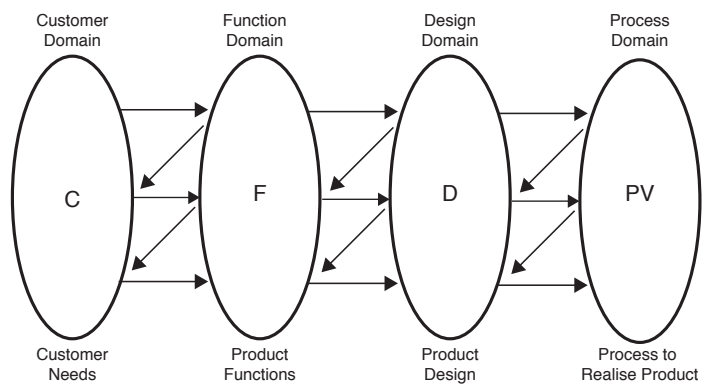

Figure 2.2: Axiomatic Design Methodology(Suh, 1990)

- Systematic design is emphasised into operational flows and identifying changes, while in axiomatic design the goal is to develop creative solutions.
- Systematic design is more oriented to develop a rearrangement of functional requirements while axiomatic design there is a synthesis of the solutions, in order to develop different design variants.
- The comparison between axiomatic design and systematic design determines that the second one allows to study relations between functions and constituents of a product. This enables to optimise the product concept by minimising the technical functions that does not add value.
- Axiomatic design is based on the hierarchical decomposition: It solves a general product function for continuing to the lowers ones. This establishes relationships between functions and solutions.
- While axiomatic design links the functional and physical domains at each level of the hierarchy, systematic design empowers a downward decomposition of the main function before approaching, in an ascending way, the final solution.
- The functional structure in systematic design, indicates how the inputs and outputs interact, thus the flows among the functions.

Since both approaches are used to address a new design project, it is necessary to select one to be used in this research. This thesis will be based on systematic design, particularly by the nomenclature of the design phases, treatment of the flows and interactions among functions.

Regarding the positioning of the thesis, Figure 2.3 relates the boundaries of the proposed method and the relation with design stages within systematic design. In this connection, the main input is the Requirements List, which is a deliverable that comes from marketing departments. The output that is intended to enrich is related to pre-sized values of the solution that fulfil the design objectives.

2.1.2. Tools and methods in design processes

As seen in Figure 2.1, systematic product design processes can be divided into four principal phases: clarification of the task, conceptual design, embodiment design and detail design (Pahl et al., 2007), where the first three can be considered as "*early design stages*".

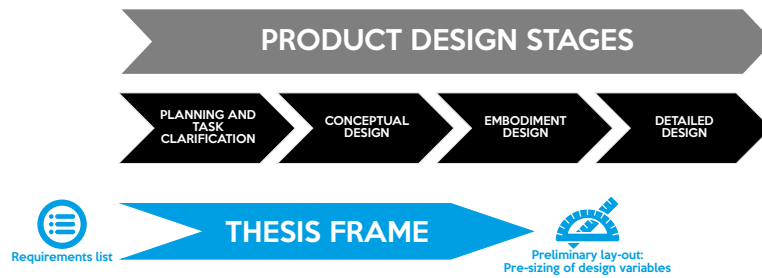

Figure 2.3: Positioning of the thesis

The designing job is centred in using tools and methods that support designers through that decision-making analysis, from external requirements up to products. The need that triggers the new product development is analysed through a requirement's list, resulting from the marketing research. This analysis allows writing functions and specifications in terms of the relationship of the product with the environment (Scaravetti et al., 2005).

For instance, let's take as an example the design process of a container for hot beverages. The first step is the research of the user's needs, where it might be found requirements such as the container must be big and light. The design team starts to analyse this information and make decisions, whether based on their experience or other sources of information (such as benchmarking). Eventually, designers define the specifications that fulfil those requirements, i.e., write specifications in terms of the volume and the weight of the product. This step is related to the "*planning and clarifying of the task*" from the systematic design methodology.

Afterwards, designers define several technical aspects of the product, in terms of the behaviour that determines those aspects that can be characterised into design variables (equations that determines the volume and weight of the product). This leads to the appearance of design variables (i.e. diameter, height and thickness). Depending on the values assigned to these variables will allow the product may fulfil the design specifications. Finally, by exploring different possibilities, designers must determine their final values and link them to different geometric features. These steps, related to the "*conceptual and embodiment design*", determine the end of the so-called early design stages and represents the beginning of the "*detailed design*". As this information undergoes from linguistic to numeric data, it is known in the literature that the imprecision of design decreases. This process allows designers to arrive at consisting solutions (Giachetti and Young, 1997).

Nevertheless, designers must somehow anticipate how their early decisions will affect the product performance. Even if design methodologies are developed to reduce this lack of awareness

in decision-making (Giachetti et al., 1997), this uncertainty is hooked-up to decision-making in design, as one of the main characteristics of the profession itself (Clarkson et al., 2004). In Figure 2.4 it can be observed how this uncertainty is refined as the design process progresses.

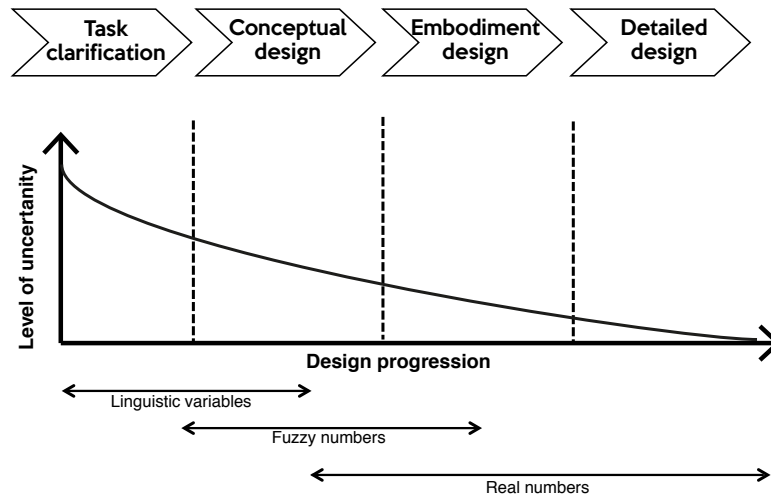

Figure 2.4: Uncertainty in design. Adapted (Giachetti et al., 1997)

Regarding early design stages, it is necessary to recall that almost 80% of the decisions are made in this stage, even if the availability of computer tools is not as high as other stages (Wang et al., 2002). In terms of knowledge management, many design approaches had failed to fully support early design. The reason is the lack of connection between the external requirements and design variables (Gero and Kannengiesser, 2004), which also has its impact on how the uncertainty propagates through design.

The following subsections are centred to explain how the use of certain tools supports decision-making processes in design. These tools are in charge of the translation of the information towards a solution that meets user requirements.

2.1.2.1. Planning and task clarification

In the first part of the early design stages, several tasks are accomplished by the designer in order to translate linguistic information into technical requirements. For instance, tools like Quality Function Development (QFD) are used to perform this commitment, by linking requirements in form of linguistic variables, with specifications (objective variables) (Prasad, 1998). Nevertheless, QFD might present several subjectivity issues. Even in some methods it is used as a way to support the prioritisation of technical design characteristics (Franceschini and Rossetto, 2002), further analysis is needed in order to complete the translation of the linguistic variables.

A further step to generate products specifications is External Functional Analysis (EFA), which can be used for exploiting the relationship between the product and the environment (Scaravetti et al., 2005). This EFA is focused on writing product specifications in terms of functions. Its result is a Product Design Specification list (PDS or *CdCF*¹, in French). The PDS is a document where the product requirements are linked to functions. Each function must include its criteria and its level of acceptance. Since this document is built based on Value Analysis (VA), the PDS allows evaluating the goals of the project and the research of concepts and solutions (Martin et al., 2004).

One of the most used approaches for building a PDS is centred in following the technical standard AFNOR NF-X50-150 (NF-X, 1991), focused on VA and Functional Analysis (FA). This standard contains different tools that support designers for writing a standard PDS. This approach is centred in APTE² technique, which understands two types of functions: Service Functions (FS) that respond to customer needs and Constraint Functions (FC) that are related to constraints from the environment. These functions are examined as an EFA and can be complemented by the use of another tool called FAST³. This tool connects the basic need and the architecture of a product, through SF, external to the product and Technical Functions (TF), internal to the product (Yannou, 1998).

Different approaches can be also noted for defining specifications for building a PDS. Eppinger and Ulrich (2015) propose a method for defining specifications by making a direct translation of design requirements into metrics for technically measuring those requirements. Every requirement must be interpreted by one or several metrics and those metrics should be design objectives. Later those metrics are written into specifications and listed into a PDS table (Eppinger and Ulrich, 2015).

Only after designers generate the specifications of the product, the QFD can be performed. This will allow to link the requirements (that are the result of user understanding) with the technical specifications, that the product must assure. Also, allow experts to understand the constraints and flexibility of each design objective. In Figure 2.5 it can be watched how these tools start to appear in the design process.

¹French for Cahier des Charges Fonctionnelle

²French for APplication aux Techniques d' Entrepise, Application of business techniques

³Function Analysis System Technique

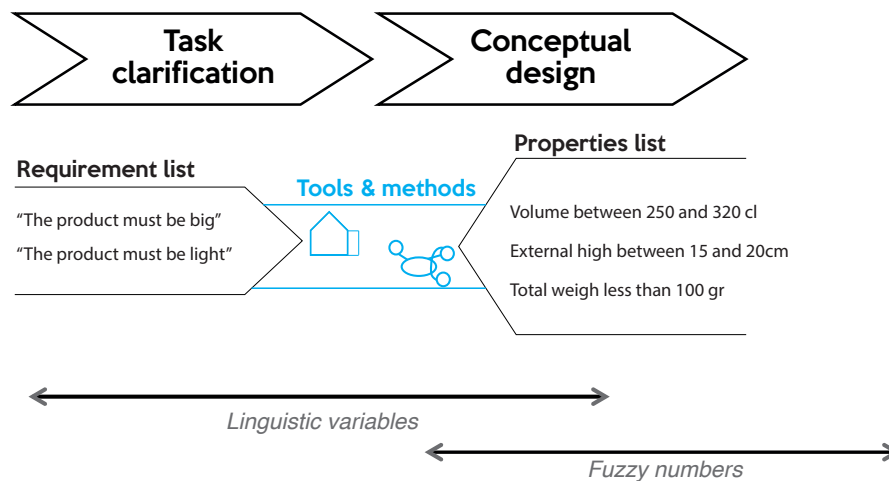

Figure 2.5: Design evolution at planning and task clarification stage

2.1.2.2. Conceptual design

Once the PDS is defined, the design can proceed to conceptual design. This second stage is centred on defining concepts that fulfil the PDS. In this situation, analysing different functions is necessary in order to empower designers to translate product needs into physical structures. To do so, it is crucial to have a formal way to define and model product's functions. For this reason, function modelling is a key task in product design processes (Hamida et al., 2015).

The connection of the conceptual design with the planning and task clarification through the FAST technique, empowers the Internal Functional Analysis (IFA), which is a cornerstone to understand how the elements of the product interact among themselves.

Several approaches can be listed as undermining functions. For example Gero (1990) proposes one of the most used approaches called Function-Behaviour-Structure (FBS). This FBS Framework allows understanding the transformation from functions to equations. With this method, the function is defined by understanding the needs and the behaviour of a system. The behaviour is centred in describing the expected attributes derived from the structure and the structure is related to the components of the solution (Gero, 1990).

Other function modelling methods introduce different function treatment Umeda et al. (1996) propose a Function-Behaviour-State⁴ framework. This approach is used when functions cannot be described objectively. The transformation between function and external behaviours is considered

⁴This method should not be confused with Gero function modelling approach. For that reason, acronyms are avoided for Umeda et al. proposal

as subjective, while the process between behaviour and state is based on physical phenomena (Umeda et al., 1996). The goal of this framework is empowering the designer team to disseminate the functions into easier to analyse sub-functions.

Goel and Stroulia (1996) propose a model called Structure-Behaviour-Function (SBF), that has its main difference compared with the Umeda et al. (1996) method, in the way behaviours are treated. In this method, the internal behaviour is preferred in order to analyse the internal causal processes in order to achieve a desired output behaviour of the solution (Goel and Stroulia, 1996).

Function modelling can be complemented by functional decomposition methods. One approach that supports this function modelling is the Converter-Transmitter-Operator-Control (CTOC) (Pailhès et al., 2011). This approach understands each of each flow as a CTOC set, determining functional surfaces in the product and feedback mechanisms, with each flow entering into the system. Its implementation allows simplifying functions by understanding how energy is transformed and which are the surfaces that act in the process.

Yuan et al. (2016) propose a method based on the decomposition of the principal function into physical aspects and sub-functions, representing the transformation between input fluxes and output fluxes. This approach defines two types of transformations: changes in flow-type and changes in the value of a flow. Then, physical aspects are defined as the possible solution principles (Yuan et al., 2016).

In complex design, authors like Gero (1990) say that the direct transition from a function to a physical structure does not correspond to a design job and limits the creativity level of the solution, implying that it is necessary to perform a deeper study.

Finally, the goal of the conceptual design stage is to generate a Function Block Diagram (FBD). It contains the whole information of the fluxes of energy, matter and information, as well as its relation to the functions. Finally, early design goes until embodiment design, which has the goal of integrating functions into a product architecture. In Figure 2.6, it can be seen how the information evolution happens going from the linguistic domain up to physical domain (shapes).

2.1.2.3. Embodiment design

Embodiment is developed based on the selected concepts, on solving the design problem. For this stage, two different approaches can be defined: "*analysis and synthesis*". Analysis occurs when design variables are defined and when an understanding of its interaction and behaviour is achieved. Then, the design objectives may be determined. Synthesis occurs the other way around.

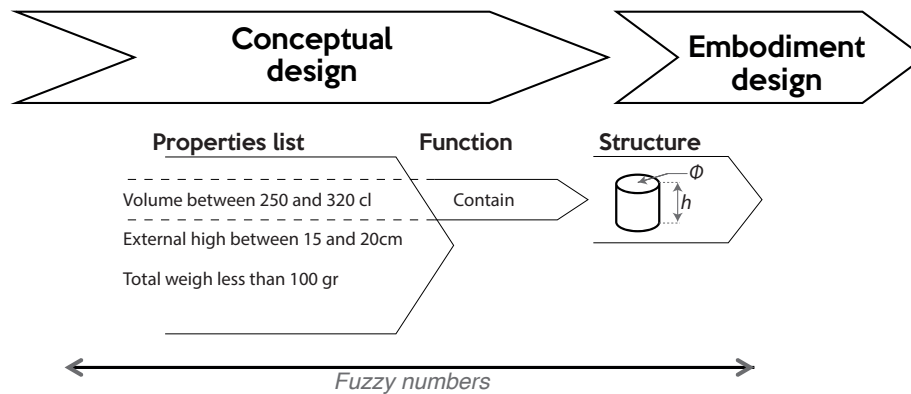

Figure 2.6: Design evolution at conceptual design

Design objectives are known and design variables are established, based on predictions related to the objective's behaviour (Tomiyama et al., 2009). Understanding when to use these approaches determine an strong adaptation capacity on tackling down a design process.

Regarding to analysis approaches, the equations that characterise the design problem are solved. Designers define different values and evaluate with behavioural models if this combination of design variables produces a proper output for the design objective. In analysis, different approaches can be used for undermining solutions, such as digital simulation, calculation and virtual mock-ups, among others. Many of the techniques for solving design may be considered as analysis techniques.

On the other hand, the availability of synthesis techniques is not as high as its counterpart, establishing an interest in its understanding. These strategies of synthesis can be defined in three (Han and Lee, 2006):

- Transformation strategy, centred in modifying an existing concept
- Refinement strategy, that begins from an incomplete solution towards a final solution
- Composition strategy, centred in developing construction blocks based on the design specifications.

Also, two types of approaches can be defined according to the extensive support of computer tools (Wyatt et al., 2012) for synthesis. Some of the most well-known strategies are:

- From Pahl et al. (2007) methodology, one strategy is centred in choosing forms and structures from morphological charts, that fulfil the goal of each function, performing a direct

transition among elements (Pahl et al., 2007). This allows to achieve solutions that are based on proven solutions.

- TRIZ ⁵ (Altshuller et al., 1997) is a Russian methodology developed during the second half of the XX century and it has been recognised as the most powerful tool used in the concept generation process (Ogot, 2004). This methodology is centred on patent search and analysis, helping to find innovative solutions by an extensive patent analysis that was performed by its creator Altshuller et al. (1997).

Nevertheless, the most relevant techniques are the automated synthesis processes which will be explained below. This is because the solution searching can be performed in a more exhaustive manner and they can result in assigning values to design variables. Some of the approaches of performing these activities are supported on different function modelling techniques.

For example, unrestricted combinatorial approaches can be used to determine a solution. Nevertheless, these approaches are extremely time-consuming, so different constraints are included in the computation method allowing to introduce techniques as Constraints Satisfaction Problem (CSP) (Scaravetti, 2004). CSP is a method that allows to exhaustively find all possible solutions within a range defined by experts, where the challenge is centred in defining the constraints that drive the design solution and the nature of the variables that will affect the final design (Yvars, 2009).

Design Structure Matrices (DSM) are methods proposed by Steward (1981) and are highly connected to the Function-Behaviour-State approach proposed by Umeda et al. (1996) This method is useful for understanding high levels of connectivity among design variables, defining where high levels of interdependence are located (Steward, 1981). Thus, DSM are useful in providing an indication of how a change is propagated through a product. This method, that can be also used in redesign situations, usually leads to understanding how the modification of one part of the product structure determines the influence of other parts (Clarkson et al., 2004).

CPM/PDD is a method proposed by Weber (2005), defining a Characteristics-Properties Modelling (CPM) based on a Property-Driven Development (PDD). It is a method that can connect the whole information generated in early design, providing explanations regarding the connections among the information elements generated on a product design process (Weber, 2005, 2007). CPM/PDD can also be used for risk assessment and management, improving the performance comparing to similar risk techniques, such as DSM (Köhler et al., 2008).

⁵Russian acronym for Teoriya Resheniya Izobretatelskikh Zadach or theory for solving inventive problems

Still, authors like Malmiry et al. (2016) have generated design methodologies centred on the use of CPM/PDD, supported by CTOC and FBS, exhibiting how the assembly of this tools can be conducted into a new product development methodology (Malmiry et al., 2016). Also, graphs usage and the integration to CPM/PDD allow proposing an integration of a synthesis/analysis approach. The *synthesis* is then used for the product model and the *analysis* for evaluating the impact of the design objectives on the system's output, based on the functional modelling from FBS approach (Ríos-Zapata et al., 2017a).

Finally, independent from the embodiment approach, the result is an architecture where each element is related to a function that interacts with a flow and that interaction can be quantified. The objective of this process is to determine the initial values of design variables. This process of undermining design values is called pre-sizing, and is the last task in early design and determines the beginning of detailed design. In Figure 2.7 is shown how the information evolves up to geometric attributes.

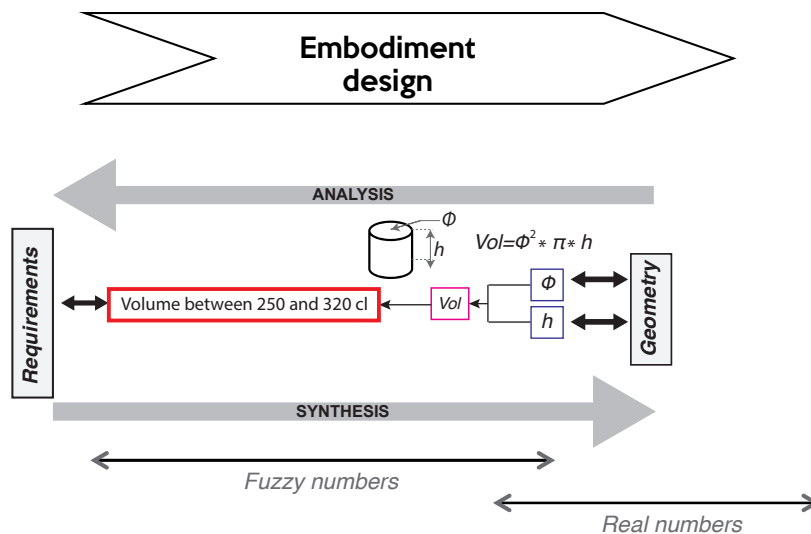

Figure 2.7: Design evolution at embodiment design

This thesis is located within these two stages, from the initial requirements and ending with the pre-sizing of the different design characteristics. An example of the usage of some of the tools explained in this section, for generating rich information in new product development process, is detailed in Appendix A.

2.2. Justification

2.2.1. Background of the research

One of the more natural aspects related to decision-making in design, recalls in coming ahead any unexpected interaction, which means that changing one "*design variable*" will not affect in a negative matter any "*design objective*". Managing this type uncertainty in early design stages is one of the main facets to study within the XXI century demands. Nowadays approaches are focused on stimulating the development of new technologies for early design stages, where the arrival of new tools has been a constant over the last few decades. Likewise, its usage is highly motivated by the automation of different task at those design stages (Robertson and Radcliffe, 2009a) and offering saves in time and money as well (Valle and Vázquez-Bustelo, 2009).

Regarding this work, this project has been jointly developed between the Institut de Mécanique et d'Ingénierie I2M from - Arts et Métiers ParisTech in Bordeaux (France) and the Design Engineering Research Group (GRID) from Univesidad EAFIT in Medellín (Colombia). In the I2M, some projects had contributed to support multidisciplinary process development. This thesis is connected to the works of Collignan (2012) and Malmiry (2016).

Collignan (2012) presents a method for decision-making processes to select a design solution. This method is called Observation-Interpretation-Aggregation (OIA). The "*observation*" part is related to the product behaviour. The "*interpretation*" part is related to the subjective preferences of designers. Finally the "*aggregation*" part is related to weighting approaches (Collignan, 2012).

This method empowers the use of desirability functions for understanding the flexibility in the design objectives and their relation with linguistic scales of qualification that goes from "*very good*" to "*not desirable at all*" (Collignan, 2012).

Regarding Malmiry (2016), he presents a robust modelling approach focused on managing uncertainty, complexity and centred in optimising the product, based on user needs. For doing so, the proposal is able to connect the information through design stages and then using the information for performing a tolerance optimisation of the product (Malmiry, 2016).

This work is centred in CPM/PDD and studying how the connections of the information, across the evolution process from linguistic requirements up to real values linked to geometric attributes, can be used to improve a design. The optimisation process is centred to be performed on one specific function of a product with the goal of increasing value of a product (Malmiry, 2016).

This thesis is centred on the development of a design method that can support multidisciplinary

design processes and ameliorate a product by calculating the best combination of design variables that allow maximising the design objective's desirability. However, the definition of the best design variables values is a task with a lot of uncertainty, especially because it is not known if a modification of a variable will impact the design objectives. Managing that uncertainty plays also an important role in how to carry out decision-making processes. On the next subsection, this concept of uncertainty in design will be explained.

2.2.1.1. The concepts of uncertainty and traceability in design

Information evolution takes place as the result of several decision-making processes. This allows to notice the evolution of variables with linguistic attributes up to quantities capable to represent geometric shapes of physical conditions. In order to handle this information, it is important to understand the information generation processes, so they can be arranged, stocked and exploited.

In terms of defining the type of information that is generated and shared as well, it is necessary to understand who generates it; which information is generated; why is generated and when is that information needed by other members of the development team. This process leads to a complexity of design management. Whenever that information is not available, the level of uncertainty is increased because of the assumptions that are needed to be made (Danilovic and Sandkull, 2005).

In design activities, two types of uncertainties can be described: aleatory and epistemic. The first type is related to the natural randomness of the product characteristics and physical properties. Epistemic is related to the imprecision that happens because of lack of knowledge (Malak et al., 2009). Moreover, epistemic can be divided into five categories: model, phenomenological, behavioural, ambiguity and interaction (Thunnissen, 2005).

The understanding of the epistemic uncertainty plays an important role on Uncertainty Management (UM). Having the possibility of anticipating to different types of situations determines an advantage on decision-making process. In this connection, CPM/PDD is used also as an UM in order to treat uncertainty and to handle both types of uncertainty (Malmiry et al., 2016). Within the interpretation of functions and its definitions into equations, CPM/PDD manages uncertainty by analysing: characteristics, properties, relation, external conditions, modelling conditions and required properties. Figure 2.8 shows hows uncertainty can be managed according to the use of several approaches.

All this information evolution process in early design stands several questions, such as *how is*

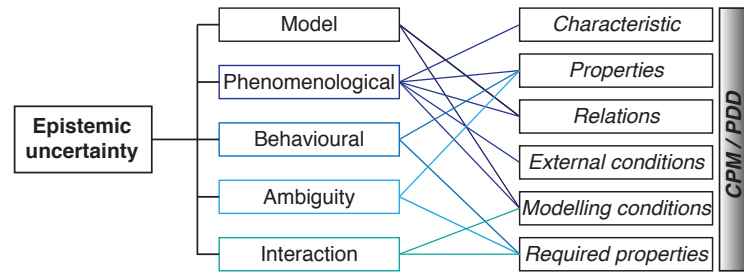

Figure 2.8: Epistemic uncertainty management in CPM. Adapted (Malmiry, 2016)

all information stored?, is there any connection-links between those kinds of information? and how designers took their decisions?.

It is inferable that there must exist any relationship between design objectives and variables, relations that helps to recognise the evolution of the product between the task and the final solution. According to the IEEE (1990.), the degree where relationships between two or more items can be established, especially where one item is the predecessor of other items, can be called *traceability* (IEEE, 1990).

The importance of having a high detail of information will determine the level of integration of the model traceability , which allows the granularity of the relationships between the different kinds of information (Königs et al., 2012). In this connection, a traceability tool must identify items that are potentially affected by a change in function of their connections. Finally, it is important to underline how the dependence is determined in design, which is measured in three variables (Ouertani et al., 2011).:

- Variability: how are the requirements set?
- Sensitivity: which is the risk in the design when a change occurs?
- Integrity: knowledge is required to achieve the task?

Regarding traceability models in product design, one of the most complete is related to the CATIA V6's RFLP (Requirements Functional Logical Physical) module. This tool is able to stock the whole information on the same platform. Nevertheless, the way information is stored and processed is not interactive (Carvajal-Arango et al., 2014), so, requirements and logical inputs are not necessarily connected to CAD model, but stored in the same file (Zheng et al., 2014). Also, it is important to recall that many product management models deal with poor data traceability especially at the exploration of the requirements definition (Igba et al., 2015).

Also, different approaches can be found on traceability for uncertainty management in design processes. Couturier et al. (2014) propose a framework based on Model-Based Systems Engineering to perform evaluations on a conceptual data model, allowing to identify potential impacts of modifications in the final product performance (Couturier et al., 2014). In this connection, it is necessary to stand the importance of considering traceability models for either design verification or validation models.

Finally, traceability models are supporting knowledge reuse in early design stages. For instance, Baxter et al. (2008) had defined a traceability framework centred on the performance analysis of specific requirements and the use of that information in order to optimise design solutions (Baxter et al., 2008).

2.2.1.2. Convex and non-convex design problems

In design optimisation problems, two types of problems can occur: convex and non-convex problems. On one hand and, convex problems there exist only one maximum. In other words, if a local minimum is calculated, the global minimum is obtained: *"a convex problem has no local minimum that is not a global"* (Bertsekas et al., 2003) (See Figure 2.9a for a representation of a convex problem).

On the other hand, in non-convex problems, several local minimums can be obtained. This hinders the possibility of calculating a global maximum. Even, there is always an uncertainty related to the existence of the global maximum (Panagiotopoulos, 2012). In Figure 2.9b is a representation of a non-convex problem with multiple maximums.

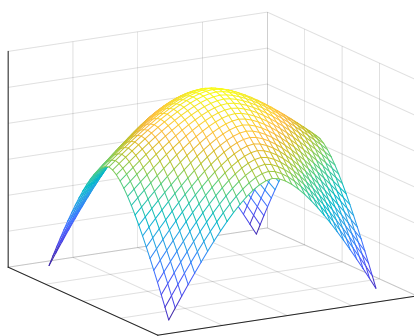

(a) Convex problem example

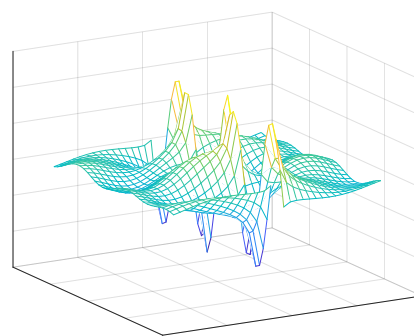

(b) Non-convex problem example

Figure 2.9: Types of design problems optimisation

Though, these non-convex problems can be treated as convex problem if a convexification of

the problem is perform. Hence, one of the trends in design is to develop methods that can address to this types of problems. Either convex problems, where a local optima is a global optima, as well as non-convex problems (Tomiyama et al., 2009). Regarding non-convex problems, they can be convexified by maintaining optimal its global minimum, that is to say, by defining the convex hull of the problem (Bertsekas et al., 2003).

The treatment of these kind of problems can be addressed following optimisation techniques, where two categories can be identified: mono-criteria optimisation and multi-criteria optimisation. On one hand, for mono-criteria optimisation, an algorithm calculates the optimal answer for the objective function (See Figure 2.10a). For this purpose different tools are used, such as, genetic algorithms and gradient techniques. In Sections §3.1 and §3.2. On the other hand, in multi-criteria optimisation, algorithms calculate solutions but is the user that selects the final solution, allowing prioritising the most critical design objective (Miettinen et al., 2008). One of the most used tools for this kind of optimisation is the Pareto front, that can be observed in Figure 2.10b. In multi-criteria optimisation the user can prioritise the objectives. For example in Figure 2.10b, the solutions within the red line (Pareto frontier) are optimal calculated solutions. Solution A has a better performance for Objective f1 and for solution B, the performance of Objective f1 is lower. The role of the designers is to select the best solution that meets the requirements.

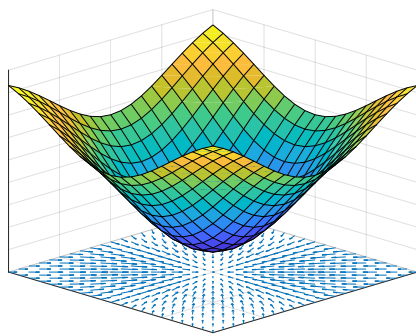

(a) Gradient optimisation

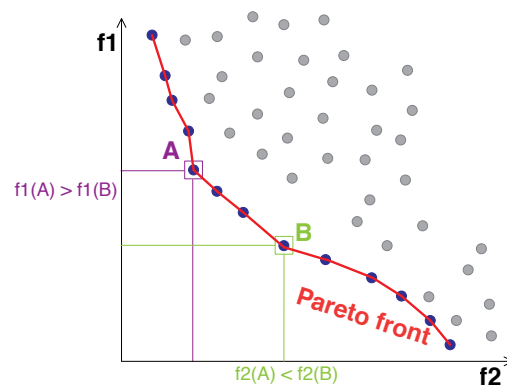

(b) Pareto front optimisation

Figure 2.10: Mono-criteria and multi-criteria optimisation

2.2.1.3. Influence of interactive design in decision-making

Nowadays design is very influenced by the support of different kind of computer tools, allowing design teams to better manage the information generated and to spend more time in added value activities than the detail (Robertson and Radcliffe, 2009b). Also, it is important to recall that, the

use of these tools influence how the task is resolved and not the task itself. (Nowacki, 2010). This influence between computer tools and design activities is studied under the concept of *interactive design*.

This concept is related to the use of advanced techniques that allow a better overview of the possible solutions by assisting designer to obtain valuable information during ideation phases and consequently an adequate solution, leading to a better comprehension of each possible solution and also promoting the basis for an adequate decision (Fischer and Nadeau, 2011; Fischer and Coutellier, 2006).

2.2.2. Problem definition and research questions

Product design process face several corroboration stages, called verification and validation process. These are activities conducted to ensure that the design output meets the input requirements (functional requirements and specifications) are part of the design verification, while the activities conducted to ensure that the resulting product meets the requirements for the specified application or intended use (customer needs) are part of the design validation (Ferreboeuf, 2014).

While verification is related to verify how each design objective is being accomplished, validation is related to how the assembly of objectives is being fulfilled.

Often the validation process depends on modifying design variables in order to have a final solution that satisfies customer needs. The problem is that this modification process can take a lot of time, especially when relations among players is unknown. Consequently, the need to generate a method that knows what to modify and in which measure, whether design objective or design variable, becomes important in modern design. Predicting how decisions will affect the output design is one of the most important challenges in multidisciplinary design (Sandberg et al., 2017)

This generates a concern about the understanding of the problem of unawareness of interaction among design objectives and design variables. Because of this, it is necessary to adopt a framework that is able to measure the relationships among design players. This framework must consider the influences between one objective and its variables and the influence of one objective on the others objectives. This lead to the importance of creating computer frameworks that empower traceability in design decisions (Wang, 2016).

Since this problem coexists with early design stages, where computer 3D-models are often not available, there exists a problem in how the information is visualised and manipulated. Also, there are no effective mechanisms starts in knowledge and how to use generated information to

support decision activities (Zha et al., 2008). This lead to the first problem:

It is necessary to generate a method that empower to measure the relationship among design objectives and design variables in multidisciplinary situations, in order to evaluate the influence of one design objective on the others.

Understanding the relationship among design objectives is only the tip of the iceberg in multidisciplinary decision-making processes. Furthermore, understanding that there is no single solution to a multi-criteria problem with conflicting objectives (Guirguis et al., 2017), that lead to different challenges. For instance, one of the goals in early design is to define values for pre-sizing of the variables.

This pre-sizing is the outcome of the embodiment design and the final milestone before entering into detail design stages. Different approaches for these design verification stage can be performed, nevertheless, the bigger the objectives list, the harder to undermine the ideal values for variables.

In this multi-objective/multidisciplinary environment, pre-sizing techniques are centred in finding optimal variables values centred into proposing solutions that meet design objectives. Still, as the complexity of the problem increases, the solution-finding process is more difficult and takes more computer time, determining big challenges. This complexity level is critical when non-convex problems are being tackled, because of the appearance of several optimal solutions for the design. Finally, based on the use fuzzy set theories for representing uncertainty (Nagy, 2012), the second problem can be stated as:

In order to maximise design objective's desirability, in non-convex multidisciplinary problems, it is necessary to develop a method for pre-sizing concepts in early design stages for offering solutions in less time rather than conventional solution algorithms.

Finally, this automated definition of variables is able to generate solutions that maximise the set of design objectives. Nevertheless, there are situations when a design team want to prioritise a specific objective over the other, desiring that any specific objective may have higher value of its desirability, no matter degradation of other objectives.

Another outcome of this process is that, not always, the values of variables are related to values that became constraints in further design stages. For example, consider that there is a hole diameter with a value of $50.108mm$. From that output several questions can be asked: Does the company has a drill with that specific diameter? What happens to the system if we change

that diameter from $50.108mm$ to $50mm$? If we change the diameter, what else do we have to change in order to preserve a high desirability of the set of objectives?

Regarding these situations, one potential answer must be linked in allowing designers to modify the values of the design variables.

The necessity of generating an interactive framework is evident when design teams are in the situation of modifying specific values without excessive degradation of the system desirability. This interactive approach must improve the decision-making process by informing which modifications are more suitable to solve the modification-situation that designers are facing.

2.3. Work description

Based on the problem, this thesis is centred into the development of an interactive approach that can be used on early design stages in order to define the values of the design variables in order to maximise design objective's desirability. The principal objective is defined as:

To develop an interactive decision support method for multiple design objectives trade-off in multidisciplinary design validation processes by the maximisation of the desirability of a global index.

2.3.1. Research objectives

Specific objectives:

1. To develop an interactive method that allows figuring out the information for increasing the understanding about relationships among design objectives and design variables.
2. To develop a method that measures the relationship among the design objectives, design variables and evaluates the influence of one design objective on the others.
3. To develop a method that allows desirability assurance of design objective method for pre-sizing in non-convex/convex situations.
4. To develop an interactive framework that indicates which variable modify and in which measure in order to fulfil the desirability of the set of design objectives.

2.3.2. Scope

The scope of the method is goes up to the design variables pre-sizing within a design process. These values are calculated in order to maximise the desirability of design objectives by computing a trade-off among them.

Also, regarding the interactivity, this method proposes an equaliser based interface for designers to modify the values of the design variables and informing in real time how this modifications may impact the desirability of design objectives.

2.3.3. Document structure

Chapter 3 is the scientific state of the art which is centred in making an analysis of how the three problems addressed in the introduction have been analysed and solved by different researchers. This part is going to be divided into three sections, each section dedicated to each problem.

Chapter 4 and 5 are related to the scientific part of the proposal of this thesis. Chapter 4 is related to the management and exploitation of the information in design processes. This chapter propose the generation of a method that empowers the management of the information generated throughout design stages. That is to say, the evolution from linguistics variables up to variables linked to product attributes. Also, this section includes a process to understand the relationship among design objectives by understanding which objectives declare contradictions, understanding which are the most critical design objectives in the design, understanding the impact of modifying the variables of one design objective and see how other objectives get affected.

Chapter 5 proposes a pre-sizing approach that can be used for convex and non-convex problems. The pre-sizing is performed by maximising the values of the desirability of the design objectives, allowing the method to define values for the design variables that maximise the aggregated desirability of the product.

Finally Chapter 6 is an applied case study of a design of a solar energy charging station. This design represents a multidisciplinary approach, empowering a design team on how to use the method in decision-making situations. Conclusions and further research are presented on the Chapter 7.

Following the problem definition addressed in Chapter 1, this Chapter is centred in understanding the State of the Art related to this research. The Chapter is divided in three sections, each section address each of the three research questions asked in Section §2.3.

3.1. Interaction among design objectives

The interaction between design objectives and design variables has been analysed by different authors, using different approaches. Basically, this is based on two transverse concepts (planning and organisation, and comparison and evaluation of different solutions) and can be divided into three general approaches:

- Making a prioritisation among design objectives and/or design variables
- Performing a design optimisation
- Using visualisation techniques in order to understand the interaction of information among objectives and variables

3.1.1. Prioritisation among design objectives and/or design variables

For the prioritisation problem, different authors have addressed the problem by the use of Sensibility Analysis (SA) in order to improve decision-making in multidisciplinary design.

Gagnon et al. (2018) performed different SA techniques in order to provide an overview of the most influential variables and interactions in multidisciplinary design situations, involving architects, mechanical engineers, electrical engineers, structural engineers and contractors. The SA was performed in order to evaluate the energy performance and thermal comfort in building design processes. Three SA techniques were implemented: Standard Regression Coefficients, Partial Rank Correlation Indexes and Sobol indices, following this methodology (Gagnon et al., 2018):

- Evaluate the linearity of the model by the use of Standard Regression Coefficients, which allow sorting variables according to their importance.
- When the model is not linear, perform Partial Rank Correlation Indexes in order to do the sorting.
- Perform Sobol indices in order to find the interaction between variables.

This methodology is compared with traditional methodologies where design variables are fixed sequentially, instead of evaluating its sensibility in the final design. The implementation of the methodology allows evaluating more design variables simultaneously in early design stages in order to achieve more sustainable products with the use of SA on Multi-objective Optimisation Strategies. The implementation of the methodology allowed to prioritise design variables by fixing the least influencers variables first (Gagnon et al., 2018). In this method, it is interesting to explore how different SA techniques perform different according to the nature of the data, still, exploring how the performance might change depending on whether the data is experimental or mathematically generated could be interesting.

Wang (2014) presented a multidisciplinary design, where there is an implementation of a Finite Difference Method Based SA that predicts the response of objective functions and/or constraints according to variations of a decision variable. That SA was used to choose decision variables that exert the most influence on optimisation objectives and constraints. This was implemented in the design of large mechatronics systems (Wang, 2014). The problem with this method is that its application, even if it is multidisciplinary, is necessary to be performed in detailed design.

Ekel et al. (2016) propose a multi-criteria decision making under conditions of uncertainty based on the Bellman-Zadeh approach and centred on the consideration of uncertainty and multi-criteria factors in design problems. These authors determine two types of situations where a multi-criteria can be used:

- If the solution is not estimated on the basis of a single criteria (problems related to the analysis of multi-physical models) (Ekel, 2002)
- If the uncertainty of the information does not allow to calculate the derivative of unique solutions, so it is possible to reduce these problems to multi-criteria decisions by applying additional criteria (Pedrycz et al., 2011).

According to this, authors propose a classification of decision-making processes into multi-objective (achieve multiple objectives while objectives are non-commensurable and conflict with each other) and multi-attribute (making preference decision over the alternatives that are characterised by multiple) (Ekel et al., 2016). Subsequently in the cited article, the multi-objective is resolved by the implementation of Pareto front and Bellman–Zadeh approach, while the multi-attribute is solved by the implementation of discrete optimisation of fuzzy intervals.

The problem with the use of fuzzy intervals is the weaknesses associated with the loss of information inherent to the conversion from a fuzzy quantity to a unique real number. The method is validated in an analysis of electric engineering problems, centred the prioritisation in distribution system maintenance planning (Ekel et al., 2016). Finally, the referenced method is addressed to answer two questions: "*what to do*" which answered by multi-objective the and "*how to do*" that is answered in the multi-attribute approach. However, one of the problems of the method, related by the authors themselves is the definition of a fuzzy interval for the variables. Authors do not consider issues when the fuzzy interval is calculated.

3.1.2. Optimisation techniques for understanding interaction

Optimisation is one of the most used techniques in order to find one solution in a multidisciplinary situation. That is to say, when designers need to find one solution that meets the whole set of requirements, the implementation of a method that helps to find the best value for variables allow to arrive at desired solutions.

Piedras et al. (2006) presented a mathematical programming technique for the concurrent optimisation of a product's customer requirements, using tools from early design stages, such as QFD. The article compared the parallel optimisation to a sequential approach, finding that sequential solutions do not necessarily lead to the best solution. The importance of the cited work is centred in the concern of understanding design objective's behaviour in early design stages in order to create awareness of unfeasible or inappropriate solutions (Piedras et al., 2006). Here it is interesting to see how decisions are being made based on design objectives. It recalls the

importance of understanding how this interaction impacts design. Nevertheless, it is still necessary to make connections between that interaction at the objectives level, with those interactions at the variables level, where the physics of the product is understood.

Lin and Gerber (2014) propose a framework that computes different trade-off analysis on the design objectives and makes it visible. The method was used in order to improve the energy performance related to decisions made on early design stages. Within the optimisation method adopted in the study, genetic algorithms were implemented because of its potential for addressing design problems with different degrees of parametric coupling, complexity and uncertainty (Lin and Gerber, 2014). This framework allows to calculate the best solution in terms of energy performance in the field of building design. Nevertheless, the solution is not easy to modify and it is necessary to define boundary conditions for the optimisation, in order to imitate the computation time and the number of feasible solutions.

Yano (2016) proposes a fuzzy decision-making method for obtaining a satisfactory solution for generalised multi-objective stochastic linear programming problems. The method is centred on probability maximisation and fractal optimisation. The research proposes two approaches for dealing with uncertainty: two-stage programming approaches and chance-constrained programming models. For the optimisation, a Pareto front is implemented. The fuzzy model is based on the definition of permissible objective levels and it is solved by the use of a fractal optimisation model for stochastic linear programming. The proposed model, which is centred in convex problems, grants its successes on the definition of the membership functions and how the variation of the objective's level is determined. Final results allow to prioritise variables, to detect those to affect affect the most the objective levels. Additionally it allows to have a resulting number for those variables (Yano, 2016).

Turrin et al. (2016) propose an optimisation model based on three main aspects:

- The complexity in the formulation of the optimisation.
- Assessing performance based on analysis for supporting the performance of simulation tools.
- The combination of design optimisation and design exploration via an interactive dashboard.

In the method, solutions are parametrically generated and for each solution, performance indicators are calculated. These solutions are optimised using Pareto front techniques in order to converge to optimal solutions (Turrin et al., 2016). This process, which is centred on optimising design objectives, grants a quick evaluation of different solutions, still, the computational load limits the usage of the tool.

3.1.3. Visualisation techniques in order to understand the interaction of information

Other approaches used to determine the interaction among design objectives are less automated, allowing engineers to better understand information interactions rather than automatically find solutions. Visualisation and organisation techniques are useful for exploring solutions.

Zha et al. (2008) proposes a decision support model, combining decision support problem technique and the fuzzy synthetic decision model, using a multi-agent framework to facilitate integration and collaboration for design decisions. In the fuzzy model, weights are given by the eigenvector associated with the highest eigenvalue of the pairwise comparisons matrix for different alternatives. This objective value is later discussed in different marketing groups, where decisions are made, based on the fuzzy premises and the fuzzy conclusions. The decision support problem technique implemented, whether parallel or sequential with the fuzzy model, allow achieving a hybrid decision support model (Zha et al., 2008). This method empowers novice engineers to better understand the problem by the integration of the knowledge of different disciplines, supporting decision-making in multidisciplinary environments, including those decision based on subjective information. The issue with the method is indeed the management of importance between objective and subjective decisions.

Cavallucci et al. (2015) propose a framework for facilitating TRIZ in multidisciplinary design situations. The framework is centred on the visualisation of hypothetical propagation of decisions using graphs. The implementation of this algorithm, that analyses relationships among decisions, improve significantly the robustness of decisions made in research and development groups (Cavallucci et al., 2015). This method allows designers to understand the risk of taking any decision, which allows to anticipate potential results. Its implementation showed that TRIZ solutions were an amelioration among other previous implementations. Yet, the method is not centred on identifying critical variables or objectives, only in how the use of information empowers decision-making by reducing the uncertainty. About this work, the most interesting contribution is centred in understanding the impact related to the propagation of decisions and their potential consequences.

Sandberg et al. (2017) present a method that allows the management and visualisation of information in multi-disciplinary models empowering parallel decision-making and allowing design optimisation. In the article, a Finite Element Analysis was conducted and the results of the simulation were analysed in a CAD tool. The method allows a connection between early design stages and detailed design (Sandberg et al., 2017). This method is more centred in connecting

information through design stages allowing design optimisation of an aggregated system-level, which misspends the possibility to impact the decisions in preliminary design, when the possibility to impact is superior.

Penas et al. (2017) in their work, regarding Cyber-Physical Systems design, implement a multi-scability requirement technique. This work is centred on managing a modelling of the information generated in early design stages and generating links between different functions evaluated in the IFA. The results of the method allow to evaluate the whole assembly of functions into a graph and evaluating relations (positive or negative or neutral), among functions, using adjacency matrices (Penas et al., 2017). This method allows to identify the relationship among features by storing the information using a structured method, but, the simulation framework is not centred on optimising or finding best couplings for providing the best design.

Thokala et al. (2016) propose a framework for Multi-Criteria Decision Analysis based on five steps (Thokala et al., 2016):

- Defining the decision problem involves understanding the problem by identifying the appropriate stakeholders and understanding the expected output.
- Selecting and structuring criteria, which must be centred in achieving completeness, non-redundancy, non-overlapping and preferential independence.
- Measuring performance and scoring alternatives, where scoring elicitation methods, whether compositional and decompositional, can be implemented.
- Weighting criteria, which is done based on stakeholders' preferences, which represent different trade-offs in order to generate a total value.
- Calculating aggregated scores, based on a decompositional method, where weighted scores are summed across the criteria in order to get a total value for each alternative.

In this work, the use of structured and explicit approaches of multi-criteria decisions can improve the quality of decision making and a set of techniques, nevertheless, the treatment of the weighting approaches is quite subjective, representing an opportunity for further solutions.

Wang (2016) presents a multidisciplinary design and analysis environment based on a cybernetic platform that integrates analysis techniques, including application and information integration, parameter mapping, data management and project scheduling for multidisciplinary design optimisation. This environment empowers engineering integration at different levels. First, information integration provides services for separately harnessing the computational data of the

products, that is to say, relevant information for aircraft design, which was the case study addressed in the referenced article. Second, information integration concentrates on reconciling inconsistencies among computational data. This information allows processing at the same time structural dynamics and aerodynamics (Wang, 2016). This work is more centred in organising the information of the work, by the use of an integrating framework and the use of that information into the specific case of design and optimising an aircraft based on the multidisciplinary analysis of different sources of information. Nevertheless, the method is centred on using huge amounts of information in detailed design, overlooking the possible impact in early design stages.

3.1.4. Analysis of the interaction among design objectives

Finally, Table 3.1 is related to the analysed approaches¹. Three major approaches are remarked from the literature: SA, Pareto front and fuzzy sets.

Table 3.1: Approaches boarded at interaction among design objectives

Approach	(Piedras et al., 2006)	(Zha et al., 2008)	(Wang, 2014)	(Cambaz et al., 2014)	(Lin and Gerber, 2014)	(Cavallucci et al., 2015)	(Yano, 2016)	(Ekel et al., 2016)	(Turrin et al., 2016)	(Thokala et al., 2016)	(Wang, 2016)	(Sandberg et al., 2017)	(Penas et al., 2017)	(Gagnon et al., 2018)	Application in searcher literature
Fuzzy models		■		■			■	■		■					23.8%
Pareto					■		■	■	■						19%
Finite difference Method			■								■				9.5%
Linear SA	■													■	9.5%
Understanding relations						■							■		9.5%
Bellman–Zadeh								■							4.8%
Finite Element Analysis												■			4.8%
Fractal optimisation							■								4.8%
Genetic Algorithm					■										4.8%
Non-Linear SA														■	4.8%
Sobol indices														■	4.8%

SA techniques were applied in 14.3% of the literature study. They allow to quantitatively measure the performance of the solution and how it might change depending on the modification

¹understanding by "approach" the model used to determine relationships among design objectives and variables

of the values of the variables. Among the investigated methods, it is important to recall which ones are suitable to use, depending on the nature of the data. That is to say, if data behaviour is linear or not. For instance, Partial Rank Correlation Indexes is a technique that has proven its performance with non-linear data (Gagnon et al., 2018), while many different techniques are found in literature for linear data. Finally, the most useful attribute of these techniques is the ability to identify the most important variables, in terms of influence with the design objectives.

19% of the the reviewed articles worked with Pareto front, which is an approach more centred in optimising solutions, but from their results, certain priorisations can be made. Nevertheless, one of the biggest issues with this techniques are related to the machine time, especially for Pareto front and genetics algorithms; as well as the difficulty to modify the solutions (Lin and Gerber, 2014). Finally, some insights regarding to this section are made by Turrin et al. (2016), where they propose a computer tool for a quick evaluation of the different solutions. This kind of interactive approaches will be addressed in Section §3.3.

Almost a quarter of the reviewed articles were related to the use of fuzzy models. First of all, it is necessary to stand that the usage of fuzzy models empowers engineers to understand the integration of knowledge from different disciplines, which is key in multidisciplinary design (Zha et al., 2008; Yano, 2016). Also, a positive element in fuzzy models is the capacity to propagate non-redundancy, non-overlapping and preferential independence models (Thokala et al., 2016). Thus, in fuzzy models, it is necessary to be aware of the loss of information that happens between the conversion from a fuzzy quantity to a real number (Ekel et al., 2016). More state of the art regarding fuzzy models will be addressed in Section §3.2.3.

3.2. Pre-sizing in non-convex multidisciplinary problems

New product development processes usually deal with non-convex problems. The challenge happens when there are convex and non-convex parallel problems to solve. In literature different approaches are addressed for sizing in these situations:

- Convexification of non-convex problems
- Multidisciplinary optimisation
- Membership function optimisation

3.2.1. Convexification of non-convex problems

Regarding non-convex optimisation and its convexification, Ni et al. (2018) propose the use of convex sets in order to quantify the uncertainty domain of uncertain-but-bounded parameters on non-convex problems. These sets are generated by the use correlation of matrices containing the uncertain parameters. The generated convex sets consider two types, the multidimensional ellipsoid model and the multidimensional parallelepiped model, both evaluated using Convex Correlation Coefficient and Sample Correlation Coefficient (Ni et al., 2018).

Also, different approaches are proposed in the field of applied mathematics in order to achieve the convexification of the problem. Bouchitté and Phan (2017) propose a recipe of duality techniques, centred to be used in n-dimensional topological space. Its challenge is centred in the definition of the necessity conditions of defining a global optimum in this method (Bouchitté and Phan, 2017). Mao et al. (2016) propose an algorithm that can project and linearise the non-convexity. The algorithm uses a penalty function and it is centred on the use of the first order information of the Jacobian matrix. This method grants the convergence to a local optimum (Mao et al., 2016).

Shishkin (2017) presents an algorithm for optimising problems with a convex objective after the convexification of the problem using linearisation. This method operates with Quadratic Matrix Inequalities for its decomposition into convex matrices functions (Shishkin, 2017).

Zhang et al. (2017a) proposes a penalty boundary sequential convex programming algorithm, which converges to a Karush-Kuhn-Tucker (KKT). This algorithm uses a series of convex programming for the convexification of nonlinear optimal control problems with non-convex cost functions. This penalty strategy allows to decrease the number of iterations (Zhang et al., 2017a), This algorithm was used by Zhang et al. (2017b) for a Unmanned Aerial Vehicle path planning, where the sequential convex programming problems were determined for the convexification of the non-convex parts. In their work, different pathing algorithms were compared, resulting in that the method proposed by authors performed better in trajectory planning, offering trajectories smoother and farther from the obstacles (Zhang et al., 2017b).

Different techniques of convexification of non-convex problems can be found in literature, which determines an indication of the necessary to solve this kind of problems by these techniques. Still, not the whole convexification methods are suitable for the whole kind of problems. Each method is suitable for a specific kind of problem, so the challenge is to implement the adequate convexification technique. This leads to centre the analysis to search on the literature how multidisciplinary optimisation in design is performed.

3.2.2. Multidisciplinary optimisation of non-convex problems

Some applications in general mechanics optimisation are based on Genetic Programming. Russo et al. (2017) use a bio-inspired metaheuristic technique capable of automatically evolving programs to tackle knowledge discovery problems. The novelty of the method is centred in three aspects: i) ensuring consistency of units ii) avoid trivial solutions iii) storing solutions in external archives in order to avoid overwriting. This method is centred in improving the original *innovisation algorithms* (Russo et al., 2017). The most remarkable aspect of this method is the possibility to explore every evolved solution, so the external storing allow to perform this action. The method is used in mechanical design, such as cantilever welded beams and metal cutting process (with variables such as cutting speed, power), nevertheless, the method only considers at the moment the optimisation of two objectives.

Liu and Gea (2018) proposes a two-level optimisation formulation for Robust Topology Optimisation based on the use of Wolfe duality to a generalised eigenvalue. The work studies uncertainties of loads (e.g. loads condition, material stiffness and design boundary) in the solution process in order to achieve a robust optimised structure. In the method, the upper level is centred into solving a topological optimisation problem under the worst load and the lower level solves the worst loading condition among the possible uncertain loads. This method is on identifying the worst load case at the lower level of the analysis (Liu and Gea, 2018).

In the field of structural systems design, Sakalkar and Hajela (2011) propose a methodology for non-deterministic design optimisation of hierarchically coupled structural systems. This method considers uncertainty and uncertainty propagation in hierarchical systems and it quantifies uncertainty and assesses reliability to solve local optimisation problems. The procedure followed in the method consists of three parts: i) initialise the system level variables and propagate them into the subsystem ii) solve each subsystem level problem by using the probabilistic formulation of the constraints iii) iterate and check the satisfaction of constraints at the coordination level (Sakalkar and Hajela, 2011). In this work, a propagation of constraints is being made by the decomposition of the problem and working in order to control the uncertainty in design. Still, the work is centred in multi-objective optimisation but in one domain of physics. For that, it is necessary to work in the multi-physics domain, but maintaining the approach of propagating restrictions from design objectives.

In the field of heaters design, Babu et al. (2018) propose an optimisation framework for the Regenerative Storage Heater of a wind tunnel. The design of this kind of systems is an iterative design process based on three parameters: energy, exit temperature of the air and the blow-down

duration. One of the novelties proposed in the work is the use of a GUI in Matlab where the multi-objective functions can be seen, allowing to study the design and analysis simultaneously (Babu et al., 2018). The mathematical model proposed in this work is centred in Genetic Algorithms and Finite Element Analysis, which are centred to later design stages. The use of a graphical interface in Matlab for the definition of constraints and parameters, allows integrating into the design the optimisation and analysis models.

Guirguis et al. (2017) propose a gradient-based multi-objective optimisation algorithm based on mathematical functions and their derivatives in order to optimise the distribution of wind farms. The optimisation process was based on the definition of gradients among the constraints. Also, authors propose a Pareto-based approach that provides to designers a set of non-dominated solutions, empowering them with informative insights into feasible quasi-optimal solutions (Guirguis et al., 2017). The limitation of the method is centred into the possibility of offering the best solution while other solutions are located in the neighbourhood. Also, authors suggest to validate the method with different CFD techniques.

Ng and Leng (2002) propose a nonlinear optimisation method based on genetic algorithms for the trade-off among design objectives (e.g. aerodynamics, stability, structural, performance) in the design of a micro-air vehicle. The selection of genetic algorithms was made because of its ability to move towards the global optimum solution, rather to fall into local maximum intervals. The works compare results to non-linear optimisation based on sequential quadratic programming, reporting that the time spent by the genetic algorithm was 41.9% longer (Ng and Leng, 2002). The proposed method is capable to arrive at an optimal solution by the use of genetic algorithms, granting the sizing of design variables, even when the problem presents several local minimums. The problem of this method is the time because it takes longer than other optimisation techniques.

Also, in the field of sizing, in aircraft design, Badufle et al. (2010) propose a method centred in the development of an heuristic-based framework that offers an analytical description of the design space, facilitating the exploration of the optimisation process. Also, genetic algorithms and CSP are used because of their ability to deal with robustness and their adaptation to multi-criteria optimisation problems. Finally, the optimisation is achieved by the use of Pareto front (Badufle et al., 2010). The proposed method is able to deal robustness, to manage continuous and discrete variables. The issue recalls in the interaction between Pareto front and CSP; depending whether algorithms are non-dominated or not, making necessary to spare solutions in different populations for further analysis.

Mastroddi and Gemma (2013) propose an optimisation method based in Pareto front in aircraft

design as well. This method includes the concept of Pareto optimum, which is when, at a given point there, does not exist a better trade-off between the objectives, according to constraints. This concept is used as filtering criteria. Also, the method empowers designers to choose the best design using a geometrical interpretation of the Pareto frontier, allowing the quantification of the compromise among objective functions (Mastroddi and Gemma, 2013). This method uses a commercial finite element and optimisation algorithm to perform the analyses. The use of commercial software prevents the algorithms from being modified and the scope of the result is limited to a special type of design.

Yang et al. (2018) present a multidisciplinary optimisation framework centred in the use of commercial finite element software and the implementation of an intelligent algorithm that is able to analyse the software results and obtain the optimal solution. The product analysed in the work was the cross-section layout of a sub-sea umbilical cable, including mechanical, geometric and thermal considerations into the multi-disciplinary optimisation process (Yang et al., 2018). The major contribution of this work is that authors remark that the proposed framework might be used by designers with less experience, allowing to shorten the time and reduce the cost of training.

For instance, besides optimisation in mechanical design, multi-disciplinary Pareto fronts are applied in different knowledge areas. For example, Gopakumar et al. (2018) propose the use of Pareto front to determine the performance and the suitability levels of different materials. Also, the work includes machine learning techniques in order to train datasets about the behaviour of different materials (Gopakumar et al., 2018). Reynoso-Meza et al. (2016) proposes multi-objective optimisation design for controller tuning, based on three steps; i) Define the multi-objective problem. ii) Evolutionary multi-objective optimisation. iii) Visualisation and decision-making. One of the most remarkable outputs of the work is the trade-off analysis of the controllers (Reynoso-Meza et al., 2016).

Hill and Schwarze (2016) also use Pareto front, but in the optimisation of ring tree networks problems. This method is related to optimising the edge installation costs, and develop a reliable topology that connects customers with different security requirements (Hill and Schwarze, 2016). Related to that graph optimisation problem, Wheeler et al. (2018) use Pareto front for optimising distribution routes in biomass supply chains, developing a structure for stakeholders to agree on a final solution, safely assessing the relative importance of the twelve conflicting objectives (e.g. respiratory effects, ionizing radiation, ecotoxicity) (Wheeler et al., 2018). Both authors, use optimisation techniques, not to improve the attributes of a product, but to improve networks and to reduce the cost related to them.

Information modelling techniques are often represented in terms of graphs, because defining traceability can be increased with their utilisation. Finally, some authors have worked in how uncertainty can be managed in multi-objective optimisation. Yao et al. (2011) defines the cornerstones of Uncertainty-Based Multidisciplinary Design Optimisation in three parts: i) listing the whole uncertainties exhaustively, that are going to be taken into account in the design optimisation process ii) selecting the appropriate mathematical models that represent the uncertainty iii) screening uncertainties with SA in order to reduce the scale of those uncertainties (Yao et al., 2011).

Some examples of mathematical modelling, can be, for example, the one presented by Wang et al. (2018a) propose the use of Gauss-Chebyshev quadrature, for defining fitting functions for an iterative method for propagating the uncertainty in multi-disciplinary problems. This method is quite useful in non-probabilistic methods (Wang et al., 2018a). Also Wang et al. (2018b) propose a method for non-probabilistic reliability based multidisciplinary design optimisation. In this approach, Taylor series expansion is used in order to propagate the uncertainty and then performing a direct optimisation. In that work, in the design of a wing of an aircraft studied non-probabilistic propagation for the introduction of the volume ratio and an interference model for theoretic stress-strength (Wang et al., 2018b).

Finally Table 3.2 summarises the mathematical approaches used in multidisciplinary design. In this table, it can be seen that Pareto front and Genetic algorithms are among the most used approaches, in order to carry out an optimisation process. Mostly, those techniques are selected because of the ability to clear with a local maximum. Nevertheless, many authors have boarded this problem by the use of Fuzzy sets, which is explained on Section §3.2.3.

Table 3.2: Approaches boarded multidisciplinary design

Approach	(Ng and Leng, 2002)	(Baduffe et al., 2010)	(Sakaikar and Hajela, 2011)	(Mastroddi and Gemma, 2013)	(Hill and Schwarze, 2016)	(Mao et al., 2016)	(Reynoso-Meza et al., 2016)	(Bouchitté and Phan, 2017)	(Guirguis et al., 2017)	(Shishkin, 2017)	(Russo et al., 2017)	(Zhang et al., 2017a)	(Babu et al., 2018)	(Gopakumar et al., 2018)	(Liu and Gea, 2018)	(Ni et al., 2018)	(Wang et al., 2018a)	(Wang et al., 2018b)	(Yang et al., 2018)	Application in searched literature
2D Pareto front		■		■	■				■					■						21.7%
Genetic Algorithm	■	■							■		■		■							21.7%
Multilevel decomposition			■		■															8.7%
3D Pareto front				■																4.3%
Correlation matrix																■				4.3%
CSP		■																		4.3%
Gauss-Chebyshev quadrature																	■			4.3%
Γ convergence								■												4.3%
Gradient																		■		4.3%
Jacobian Matrix						■														4.3%
Karush-Kuhn-Tucker												■								4.3%
Linearisation										■										4.3%
Particle swarm optimisation																			■	4.3%
Wolfe duality														■						4.3%

3.2.3. Membership function optimisation

Using fuzzy sets to perform optimisation processes has been a hot spot for several decades. Since 1975, Zimmermann (1975) proposes the use of fuzzy approaches to perform optimisation. His proposal is centred on how fuzzy logic can be used to manage uncertainty. The process followed by the author characterises design objectives and constraints with a membership function allowing a more clean analysis (Zimmermann, 1975). Since the 80's, the use of genetic algorithms (one of the most used approaches mentioned in Section §3.2.2) is common on fuzzy optimisation. Goldberg et al. (1987) propose the use of multi-modal optimisation based on genetic algorithms and the definition of sharing functions, which can be defined as a function that determines the degradation of an objective, due to the interaction with other objectives. The use of these sharing functions allowed to maintain stability propagated samples in appropriate sizes (Goldberg et al., 1987).

In the late 90's, authors have started to mention issues regarding fuzzy optimisation and their usage with biological inspired strategies². One of this author is de Oliveira (1999) who introduced the semantics properties, that membership functions should have. The work is centred in constraining the optimisation for preserving semantics in order to prevent the degradation of the fuzzy system's performance. In order to achieve this, some comprehensive semantic properties are proposed: i) relatively instead of absolute meaning ii) moderate number of membership functions iii) distinguishability iv) normality v) natural zero positioning vi) coverage (de Oliveira, 1999). A remarkable contribution of this work is the understanding of how unconstrained optimisation methods are susceptible to get stuck in local minimums.

Esmin and Lambert-Torres (2007) develop a comparison between evolutionary algorithms, applied to fitting fuzzy membership functions. The work studied the performance of genetic algorithms, particle swarm optimisation and the hybrid particle swarm optimisation. The final results showed how the performance was better with the evolutionary algorithms, needing in average 25% fewer interactions that the process developed with the membership functions (Esmin and Lambert-Torres, 2007).

In literature, two types of optimisation are presented in terms of fuzzy sets. Product optimisation and fuzzy set optimisation. Related to the second one, authors like Zadeh (2001), Kharrati et al. (2012), Song et al. (2017) propose different approaches and applications. On one hand, Zadeh (2001) propose a method for annealing using Cauchy distribution, for the probability density on fuzzy sets, allowing easier access to test local minimum. Finally a simulated annealing

²Neural networks learning rules, genetic algorithms, evolutionary optimisation techniques

optimisation method was implemented in the fuzzy set (Zadeh, 2001).

On the other hand, Kharrati et al. (2012) propose two hybrid optimisation strategies for fuzzy sets: i) a genetic algorithm that extracts the best possible number and sequence of fuzzy rules. Later, after the convergence of the genetic algorithm, the parameters of membership functions are optimised by extended Kalman filtering. ii) the structure of the genetic algorithm is modified for including the parameters of membership functions and the arrangement of the fuzzy rule, allowing the optimisation simultaneously. These strategies force the algorithm to use all rules resulting from linguistic variables for the best arrangement. The results allow measuring an improvement in the performance criteria and robustness of the solution (Kharrati et al., 2012). Finally, Song et al. (2017) propose the use of fitness functions for evaluating the number of association rules generated for the fuzzy sets. Also, authors propose fuzzy decimal bat optimisation method. They compare it to uniform fuzzy partition and genetic algorithms, resulting the proposal with a higher fitness and more association rules (Song et al., 2017).

For instance, several other authors use fuzzy sets membership functions for optimising product design. For example:

- Pape et al. (2015) propose a method for identifying attributes in order to assess system architecture definition. This method empowers the adjustments of the elements of a fuzzy inference system and trapezoidal membership functions in order to improve the solution, developing a sufficiently autonomous algorithm which is able to make a good choice among alternatives (Pape et al., 2015).
- Safaee and Mashhadi (2016) proposes method for drones design optimisation. It is based on a fuzzy logic control approach, which is able to compensate the uncertainties related to the flight control algorithm, even if the exact mathematics is not available. This method is centred in the use of particle swarm optimisation and genetic algorithm (Safaee and Mashhadi, 2016).
- Yin et al. (2018) propose the optimisation of uncertain structural-acoustic system, under a fuzzy sets approach. This method, in order to reduce calculations time, introduce a transformation of calculation of constraints into a double-loop nested problem. This approach is able to handle uncertainties in engineering optimisation problems by the use of a probabilistic model (Yin et al., 2018).

3.2.4. Analysis and insights of pre-sizing techniques

The first conclusion regarding the non-convex multidisciplinary problems in design is centred on the convexification of the problem as the best approach to deal with this kind of problems. Also, by analysing the Table 3.2, it is found that the most popular approaches are Pareto front and Genetic Algorithms.

About Genetic Algorithms, the most important capability is their *global optimisation goal*, which can be complemented with Pareto front and their capability of identifying solutions in multi-objective situations. The problem with these approaches is that they are excessive time-consumer (Yao et al., 2011).

Regarding to other approaches, several insights can be enumerated:

- Optimisation is centred in pre-sizing variables for late design stages, specially in detailed design (Badufle et al., 2010; Ng and Leng, 2002). This lead to the opportunity to focus into early design stages.
- Many optimisation techniques are focused on arriving to a global maximum, even if the solution time is long (Ng and Leng, 2002).
- Gradient-based methods allow the designer to control the analysis process and to focus research in well- defined areas (Mastroddi and Gemma, 2013).
- A design framework empower less experienced designers to perform better and faster in different decision-making processes in design (Yang et al., 2018).
- It would be necessary to include mechanism that allow to understand the degradation among design objectives, such as sharing functions (Goldberg et al., 1987).

3.3. Interactive design and decision-making empowerment

3.3.1. State of the Art of interactive design

Alam et al. (2015) propose a framework in the boundary of preliminary design and detailed design, for the optimisation of an underwater vehicle (light-weight submarine). The interactivity of the model is based on empowering the design team to choose, whether a low-fidelity model or a high-fidelity model. The difference between models is the way the drag is estimated. That is to say, while in the low-fidelity model drag is estimated using empirical estimates, in high-fidelity, drag is estimated using CFD analysis. The optimisation framework is embedded with a geometry

representation module, allowing a better understanding of the characteristics of the design (Alam et al., 2015).

In this work, an evolutionary algorithm is used for the optimisation, allowing the high-fidelity model to obtain a 22% of the change in the drag calculation. Nevertheless, this analysis is highly computational consuming, circa 7000 more computational times rather than the low-fidelity model. Considering that the evaluated submarine was short in size and weight (weight restriction to 0.450 kg), the scalability of the framework is questionable (Alam et al., 2015).

Bénabès et al. (2013) propose a framework for layout optimisation problem. In the work, a genetic algorithm is used to solve the optimisation problem and later solutions are hierarchically organised in a Pareto front. The interactivity of the method is presented in the analysis of the solutions, where designers use an interactive environment, that can be seen in Figure 3.1. It is used for comparing and interacting with different layouts. The method offers three interactive features: i) Explore Pareto-front solutions ii) Visualise the solution in 2D or 3D iii) Manually modify the layout by changing the position of components (Bénabès et al., 2013). The most powerful output of this work is allowing designers to explore and modify the proposed solution by the genetic algorithm, in order to find a new solution.

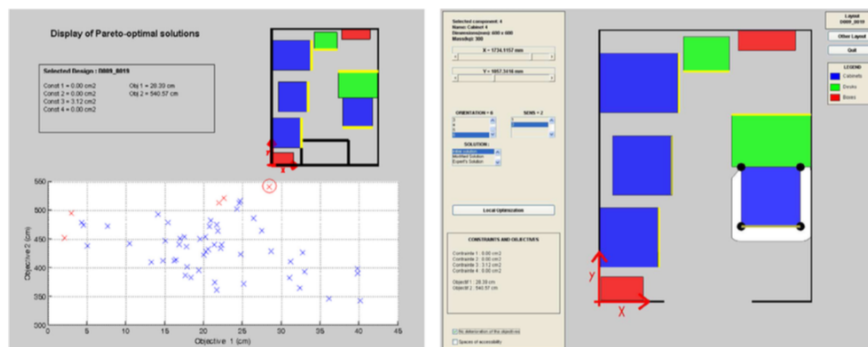

Figure 3.1: Surfaces selection framework. Taken from (Bénabès et al., 2013).

Chirkin and Koenig (2016) propose a machine learning algorithm, which is able to perform a multi-criteria optimisation. The work presents a five steps method: i) Designers create a design ii) The program analyse the design and makes hypothesis of the design goals iii) Based on these goals, the machine suggests modifications to the design iv) Designers can choose among suggested modifications or to refine the machine model v) The designer can finish the work or continue creating designs. The proposed approach is centred on the reinforcement learning model with human interaction, which is where the interactivity relies on (Chirkin and Koenig, 2016). In this work, the proposed method is useful in terms of evaluating design alternatives and in the

conjunction of developing a better design.

(Chiu and Bloebaum, 2009) propose a visualisation method that allows users to explore the desired design space, for generating new design candidates in an optimisation problem solved by Hyperspace Pareto Frontier. The proposed visualisation method is a Hyper-Radial Visualisation (HRV) which is based on a radial calculation concept to transfer high-dimensional data to a low-dimensional data representation. Some features of the Hyper-Radial Visualisation are: i) They can be used to enable implementation of trade-off studies ii) The radius of each Pareto point corresponds to a function of its normalised objective function values iii) Grouping objective functions will result in the Pareto point falling on the same indifference curve. In the work, authors develop an interactive graphical computer tool that assists the decision-making process by the implementation of a design steering approach. This approach enables designers to change the parameters of a problem to turn the design solution, rather than waiting for the algorithm finish its computation in order to get results (Chiu and Bloebaum, 2009). This method seems to show its better performance in Pareto-front decision-making, allowing designers to localise the best solution in the neighbourhood, if no other better solutions can be found.

Eisenmann et al. (2014) propose probabilistic decision-making algorithms for crossover and mutation operators for interactive evolutionary algorithms. The goal of these algorithms is to help users to avoid designed fatigue in the form-seeking stage. This work uses two approaches of sensitivity analysis in order to assign measures to each parameter of the model. The analysis consists of three stages: i) Sampling model inputs. ii) Evaluation of the model. iii) Analysing model outputs. The used approaches are Elementary Effects and Variance-Based Analysis (Eisenmann et al., 2014). This method generates different surfaces for the user to select and its interactivity recalls in an interface where users can directly manipulate components of the solution (as it can be seen on Figure 3.2). About the sensitivity analysis, the method needs a large number of model evaluations in order to avoid negative total sensitivity indices, requiring significantly more CPU time.

Gao et al. (2013) propose a virtual reality environment for optimising a riveted assembly for aircraft design. This method empower users, through an immersive virtual environment, to manually modify the position of rivets and the quantity of them. This method makes a comparison with the results presented by Collignan et al. (2012), where an OIA optimisation method, thorough genetic algorithms, were presented. The interactive method evaluates the design in a multidisciplinary environment, including stress and manufacturing items. Thanks to a visual feedback, designers are able to understand if the design is good or not. The final results of the

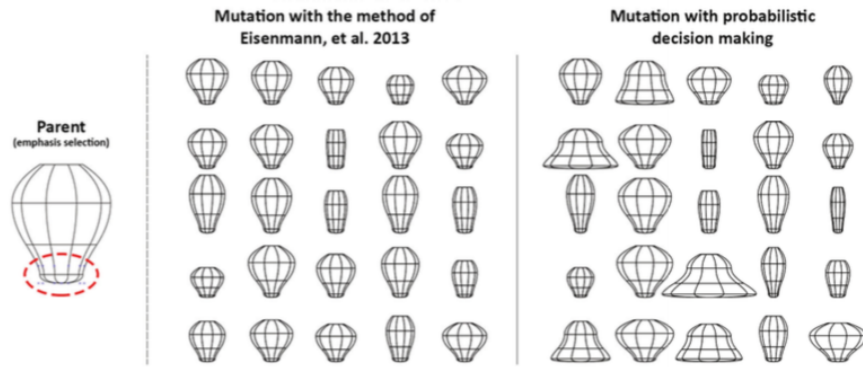

Figure 3.2: Surfaces selection framework. Taken from (Eisenmann et al., 2014).

comparison show that the time reduction drops from 4520 seconds to 257 seconds. Additionally, the solution performance obtained with genetic algorithms was 0.9052 while the performance obtained in the interactive method was 0.9024 (Gao et al., 2013). One of the major insights from this work is understanding how users interaction can present results as good as the results that came from optimisation studies. Nevertheless, this assumption cannot be taken as granted in other areas of knowledge, but the fact that considering how the user interaction might speed things is interesting. Finally, Figure 3.3 includes a screenshot of the interactive environment where designers can modify the position of the rivets and receive feedback in real time.

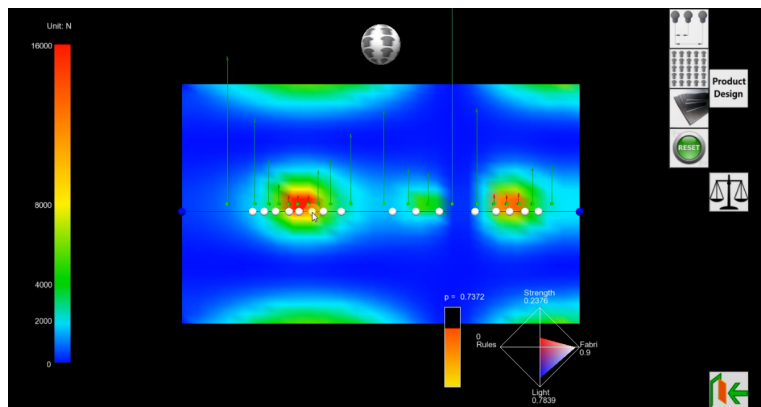

Figure 3.3: Interactive environment for rivets positioning. Taken from (Gao et al., 2013).

Koyama (2016) proposes a computational method for measuring aesthetics in product design. This method estimates a preference distribution using crowdsourced human computation and then uses this preference in a design interface to facilitate interactive design exploration. The framework integrates the information and it can be seen in Figure 3.4 (Koyama, 2016). This method, which is centred in assessing aesthetics, can be an inspiration of how to develop a framework, especially

when showing which is a good modification and which is not.

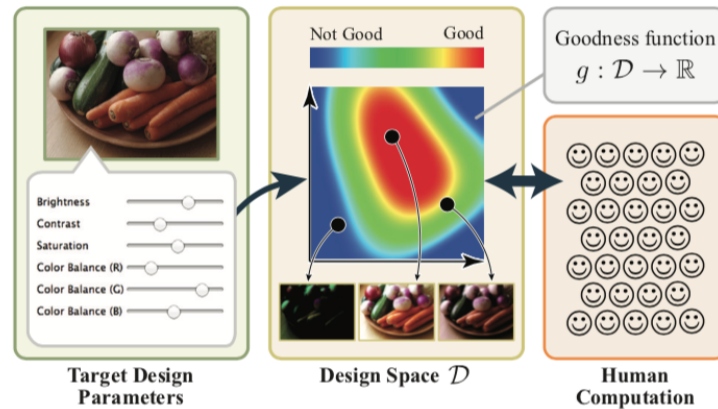

Figure 3.4: Framework for assessing necessary preference data in aesthetics selection. Taken from (Koyama, 2016).

Regarding data visualisation, Qu et al. (2017) propose a complex graph layout and visualisation, introducing the CW^3 topological spaces. The left side of the figure 3.5 presents a comparison of a traditional graph representation of relations between sources of information, while the right side presents a planar CW complex layout. One of the remarks presented by these CW is that they are able to graphic present algebraic intersections, which can be noticed in the overlapping polygons (Qu et al., 2017). Depending on the goal of designing, this kind of tools can be used for isolating nodes, in order to reduce interdependences among different sources of information.

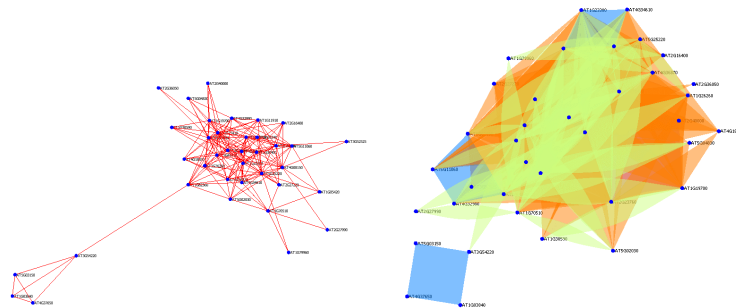

Figure 3.5: Comparison between graphs visualisation techniques . Taken from (Qu et al., 2017)

3.3.2. Analysis and insights of interactive design

The work of Bénabès et al. (2013) allow designers to compare and interact with the solution through an interactive environment (Bénabès et al., 2013). In this thesis, we will be centred

³CW: Closer-finite Weak topology.

in allowing this feature, but also, informing users about which variable is more suitable to be modified. Connected to this, it is necessary to research different visualisation techniques for this regard. For instance, those presented by Koyama (2016) can facilitate the designers to know where to modify.

Also, works from Alam et al. (2015) and Gao et al. (2013) allow to understand the power of interactivity in design, in terms of its dramatically time reduction. It can be analysed that interactivity can reduce time in almost 93% (Gao et al., 2013) in specific design situations. Nevertheless, the complex the design, the harder for the designers to arrive to a *quasi-optimal* solution by trial and error. Also in multidisciplinary environments, with non-convex problems, manual allocation of design variables is less likely to arrive to a solution without the support of any mathematical calculation.

Likewise, this thesis will be centred in proposing a model-based approach that can help to define values for the design variables, in multidisciplinary environments with non-convex problems. The objective is to generate a high desirability for the design objectives, but also, offering to designers the possibility to modify the calculated values, interactively suggesting how to produce the minimum impact of the design objective's desirability.

Interaction among design objectives

This chapter is centred in understanding the relationship among different design objectives in a product design process. This understanding allows to anticipate about how a modification in a variable's value will affect the performance of the global solution.

In product design processes, the generation of information is a permanent process. The management of this information is a critic aspect, not only because of the importance of storing the information in the correct format, but also because by understanding their connections and implications, it will allow to anticipate behaviours. Consequently, it is necessary to adapt a reference model to interpret the relationships among different types of information.

Different models are used in design engineering for storing the information in design. The evolution from this information also takes different nomenclature in literature, understanding as the evolution as the process that happens when the design objectives are transformed into design variables.

These design objectives are found with different names in the literature. For example, in Hubka and Eder (2012) methodology, objectives are called the "*external properties*", on Suh (2001) axiomatic design "*functional requirements*", on Pahl et al. (2007) systematic design "*demands*" or in Andreasen (1980) design theory as "*properties*". Likewise, the design variables are named in literature, following the same order, as "*internal properties*", "*design parameters*", "*constraints*" and "*characteristics*".

One of the first challenges is to define a framework for managing the information in design.

Further, this framework should facilitate the design decision-making processes and empower amelioration of the design. It is important to recall that the optimisation and amelioration of given design objectives, within partly conflicting design variables, can only be optimised for a particular set of circumstances because the customer requirements change with time (Pahl et al., 2007).

Due to this, the design framework must be flexible enough to empower whether synthesis or analysis processes, but even more important, to support the design team in understanding how modifications of design variables may affect design objectives.

Consequently, it is important to use a model focused in understanding the duality of objectives and variables, in the mathematical modelling in design processes. Weber and Werner (2001) propose a process for product development centred in understanding the relationship between variables and objectives for describing products and their behaviour. This process is called CPM/PDD, containing a modelling part (CPM¹) and design process part (PDD²). This methodology is designed to understand connections between design objectives and variables. This aspect takes a main role in complex multidisciplinary design, when dozens of objectives and hundreds of variables can take part.

Thus, the nomenclature of the CPM/PDD process will be adopted in this thesis. The CPM part, *Characteristics-Properties-Modelling*, is a modelling approach and its nomenclature is described as (Weber et al., 2003; Weber, 2005, 2007):

1. *Properties*: these refer to **design objectives**. These Properties are related to the product behaviour and the parameters that the product must accomplish, but cannot be directly modified by the user (Pr_j).
2. *Required Properties*: the design criteria that the product is desired to accomplish (RP_j).
3. *Characteristics*: the independent **design variables**. These are the variables that designers can modify in order to obtain solutions that meet the design goals. These Characteristics consist parts structure, shape, dimensions, materials and surfaces of a product (Ch_i).
4. *Relation*: the relationships between Properties and Characteristics. These can be noted as dependent variables (Rel_k).
5. *External conditions*: the parameters that designers cannot modify nor control and are defined by an external environment (EC_m).

¹Characteristics-Properties Modelling

²Property-Driven Development

These CPM nomenclature is connected to the PDD (Property-Driven Development) strategy (Weber et al., 2004; Weber, 2014). This PDD allow to tackle different strategies of how the new development process can be performed. This nomenclature empowers the understanding of the analysis and synthesis processes (See Section §2.1.2.3) and the connection between Customer Requirements and geometry.

Hence, on one hand, Analysis is centred in determining and predicting the product's Properties from known or given Characteristics. On the other hand, Synthesis is centred in determining and assigning the product's Characteristics from given or required Properties (Weber and Werner, 2001). These strategies are addressed as follows (Tomiyaama et al., 2009) and they can be seen in Figure 4.1:

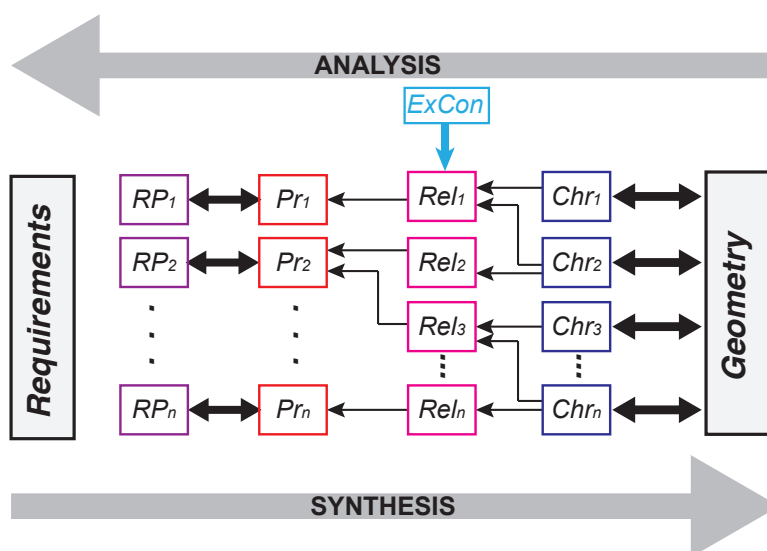

Figure 4.1: Design process strategies. Adapted from (Weber, 2005)

- *Analysis*: Allows to generate more precise information about the product, generating a better understanding of the Properties behaviour. According to Figure 4.1, it can be seen that, for a set of given Characteristics, the Properties can be calculated. This means that, for an incomplete set of known Characteristics, the Pr are still variable in a narrow domain of values.
- *Synthesis*: While the design process is being developed more Characteristics are generated and its value's determined in order to fulfil the Properties of the product. In other words, for a fixed value of Properties, Characteristics have infinite possible combination of values when trying to deduce them from the fixed set of Pr . This concept is key to address concepts

downstream.

Also, these CPM/PDD strategy empowers the distinction between Characteristics and Properties and, by doing so, it allows to understand the relations between these two. These relations can be exploited in parallel by synthesis or analysis techniques. Several evaluation cycles can be performed in order to guarantee that the product meets design Properties.

In this thesis, one of the first contributions is the proposal of an information management framework, where the information of a product design problem may be stored and visualised. For arranging the information, it is proposed a visual representation that is able to handle the information evolution from Customer Requirements, in form of linguistic variables, up to Characteristics. Figure 4.2 depicts how this evolution is tracked and how information can be visually adapted, using a CPM/PDD structure (Ríos-Zapata et al., 2017b).

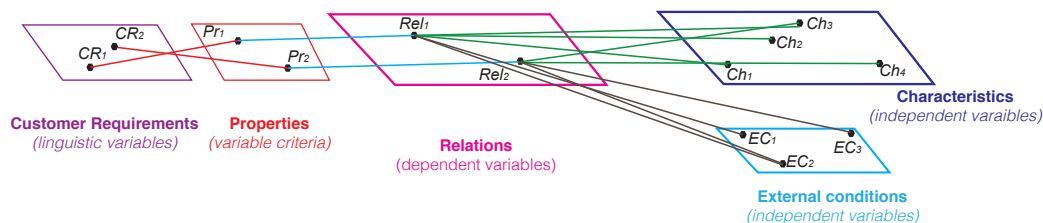

Figure 4.2: Information evolution through design processes

Once information deployment (Properties and Characteristics) is clear, it is intended to develop a method that allow design team to modify values of Characteristics, while at the same it informs about how that modification interacts with the values of the Properties. Characteristics may be modified in order to develop solutions that can meet design objectives. Nevertheless, for guaranteeing a solution that can meet the set of objectives, the solution should meet the design criteria for the whole set of Properties.

Handling this constraint represents several challenges, especially on multidisciplinary design where the amount of contradictions among Properties increases. Also, it is necessary to be aware when making modifications, about how they can impact the different design objectives. For dealing with those situations, one strategy is to introduce certain flexibility into the criteria for the design goals. For example, in the design of a portable cooler, one criteria might be defined as "guarantee a temperature of 10°C".

According to this, sharp definition of one value, a solution like 10.01°C is unacceptable. Also a solution with 9.99°C may be considered as good, probably, as good as a solution of 5°C. Based on

the understanding of the criteria is set as Internal Temperature $< 10.0^{\circ}C$, these three statements are true.

Consequently, the introduction of flexibility concepts into the analysis and evaluation of design objectives seems to be necessary. Due to this, under the frame of this thesis, this flexibility will be addressed by the use of the "*desirability*" concept.

This desirability can be understood into the generation of functions that can be associated to a membership function, which is a dimensionless value between 0 and 1. These desirability functions, noted with the Greek letter μ , are easy to set up and are widely used in problems where flexibility for evaluating Properties is needed (Pasandideh and Niaki, 2006).

In these functions, the way the result is interpreted is based in understanding that a value of $\mu = 0$ is totally unacceptable, while a value of $\mu = 1$ is entirely satisfactory. This concept allows to tackle the flexibility problem of design objectives. In literature, different approaches are proposed for defining these desirability for Properties, such as Harrington (1965) and Derringer and Suich (1980) functions.

Harrington (1965) propose several functions for complexity reduction in multi-criteria decision-making processes centred in three aspects: increasing, decreasing and targeting. Widely use in the literature, these functions that empower the multi-criteria optimisation (Jeong and Kim, 2009) represent a major contribution in how the uncertainty in design can be manipulated and represented by the use of fuzzy sets (Antonsson and Otto, 1995).

Based on these previous work Derringer (1994) proposes an evolution of the increasing, decreasing and targeting membership functions of Harrington, based on two modifications. The first is the proposition of membership functions on parts, were discontinuities are defined in parts functions (Derringer and Suich, 1980) and by the extension of the desirability approach by including a relative weight variable in the global desirability function (Derringer, 1994). Nevertheless, the introduction of discontinuities is difficult to be justified in product design problems (El Amine, 2015), so the usage of Derringer functions on the frame in this thesis will not be addressed.

In other words, the increasing, decreasing and targeting concepts are defined as functions as. This functions may be, but not exclusively, in the form of:

- S membership function: which is used for increasing values, for example when, in the Property, the higher the better. For example, if there is a Property related to the duration of a product in years: the higher the better. Equation 4.1 express the equation of the function and it can be seen in Figure 4.3a.

$$f(x; a, b) \begin{cases} 0 & x \leq a \\ 2 \left(\frac{x-b}{b-a} \right)^2 & a \leq x \leq \frac{a+b}{2} \\ 1 - 2 \left(\frac{x-a}{b-a} \right)^2 & \frac{a+b}{2} \leq x \leq b \\ 1 & x \geq b \end{cases} \quad (4.1)$$

- Z membership function: that can be used for decreasing values; the lower the better. For example, in the portable cooler it is desired that the temperature to be low: it is better when the temperature is close to 0°C , bad when it is close to 10°C , and total undesired if is higher than that. Equation 4.2 shows the equation of the function and it can be seen in Figure 4.3b.

$$f(x; a, b) \begin{cases} 1 & x \leq a \\ 1 - 2 \left(\frac{x-a}{b-a} \right)^2 & a \leq x \leq \frac{a+b}{2} \\ 2 \left(\frac{x-b}{b-a} \right)^2 & \frac{a+b}{2} \leq x \leq b \\ 0 & x \geq b \end{cases} \quad (4.2)$$

- Pi membership function: which is used when the value of the Property must be within certain interval of values. For example, it is desired that the height of the seat of a chair is between 65 and 75 centimetres. Smaller than this value is insufficient and not ergonomically adequate; taller than this is equally harmful as well. Equation 4.3 shows the equation of the function and it can be seen in Figure 4.3c.

$$f(x; a, b, c, d) \begin{cases} 0 & x \leq a \\ 2 \left(\frac{x-b}{b-a} \right)^2 & a \leq x \leq \frac{a+b}{2} \\ 1 - 2 \left(\frac{x-a}{b-a} \right)^2 & \frac{a+b}{2} \leq x \leq b \\ 1 & b \leq x \leq c \\ 1 - 2 \left(\frac{x-c}{d-c} \right)^2 & c \leq x \leq \frac{c+d}{2} \\ 2 \left(\frac{x-d}{d-c} \right)^2 & \frac{c+d}{2} \leq x \leq d \\ 0 & x \geq d \end{cases} \quad (4.3)$$

The introduction of these desirability concepts, as an enhancer of decision-making in multi-criteria situations, can be understood in Figure 4.5. The proposal of this thesis includes an *exploratory interactive method* where the design team can modify any specific Characteristic and immediately be warned about how this modification may impact the Properties. The introduction of flexibility, accompanied with a colour code, empowers the designer to understand how the

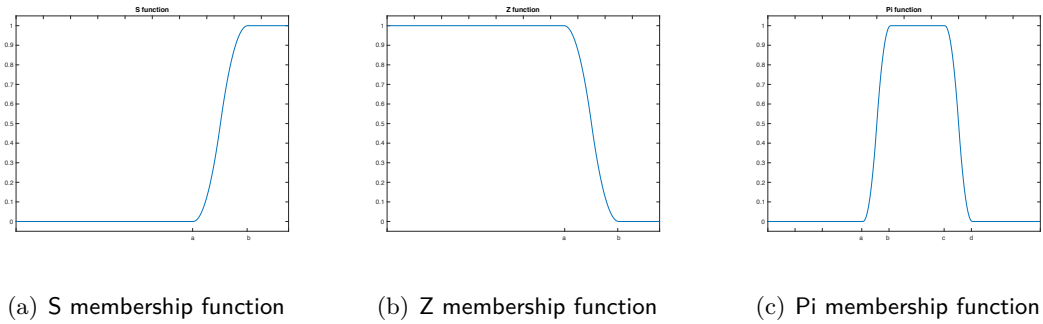

Figure 4.3: Membership Functions

modification of the Characteristics impacts the design. This colour code can be seen in Figure 4.4 and allows to understand that green values are related to high desirability values, red to bad desirability values and black to null desirability values.

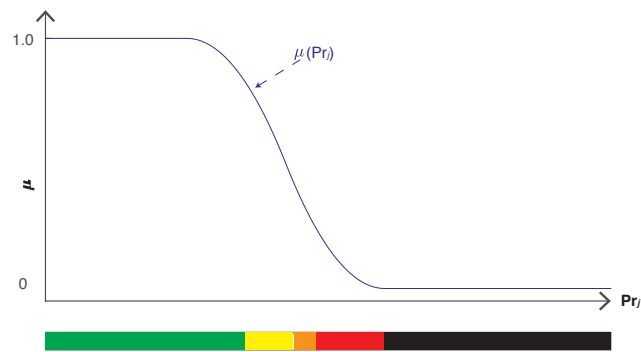

Figure 4.4: Membership function interpretation into colours

The Figure 4.5 presents an equaliser-like diagram that uses visual intervals for supporting decision-making of designers. In this diagrams, a design team can manually modify a Characteristic and understand how that modification impacts the design.

From Figure 4.5, the definition of Ch_i in a value close to 2.2 allow to have a "green" desirability on the desirability of all the Properties. Also, a value of Ch_i close to 1 will determine a null desirability for Pr_3 . This equaliser-like diagram indicates rapidly to the design team that those values should be avoided. This diagram will be explained in detail in Section §4.3.2.

It is important to recall that the proposed method demands certain input information for producing results: the construction of the information management framework and its exploitation, as an exploratory method. Due to this, it is necessary the use some specific tools that will allow the method to have the information it needs, in order to properly work. consequently, it is proposed a design process that can be observed on Figure 4.6.

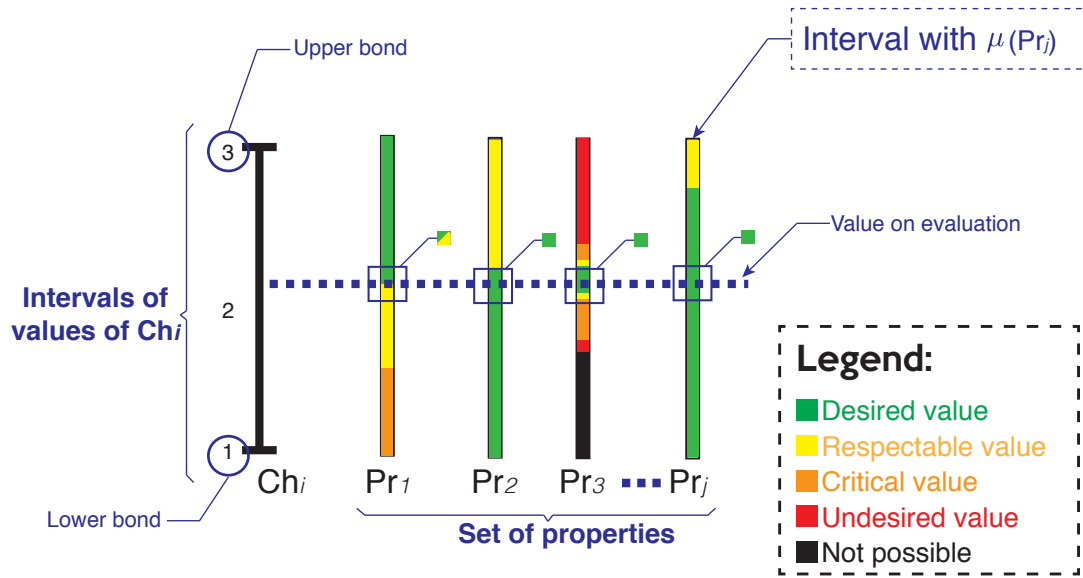

Figure 4.5: Interactive method proposal

The Figure Figure 4.6 includes, not only the design stages in a new product development process, but also design activities, tools and deliverables. In the Figure, the deliverables are related to icons, design activities are related to rectangles and tools are related to rounded rectangles. Likewise, different colours are used to identify the tools: dark blue is related to well-known tools from the literature, while purple tools are the proposed activities used in this method.

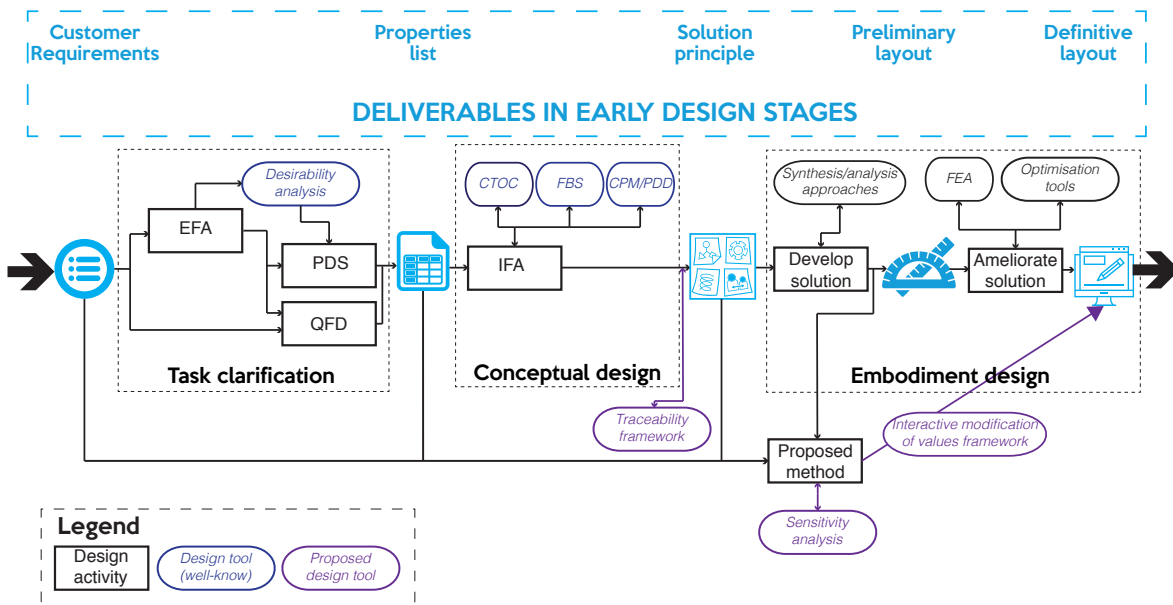

Figure 4.6: Design methodology proposal

To that end, this chapter is organised in three sections:

- (I) Understanding relationships in product design processes: this section is centred into the development of the information management framework which is based on a visual representation of the information generated in product design processes, based on CPM/PDD nomenclature. This structure allows to visualise the evolution of the information from a linguistic field to Characteristics and geometric attributes.
- (II) Measuring interaction between Properties and its Characteristics: it is intended to understand the influence of a Characteristic in the behaviour of the Property. In this section global influences are calculated from the Characteristics over the Properties, as well as the local influences among Characteristics and sub-relations.
- (III) Evaluation of interaction among Properties: it is proposed an evaluation method for the interaction among Properties. This section allows to define a prioritisation list of the Characteristics in the design and use that information for the proposition and usage of an interactive exploratory method.

To implement this, a detailed view of Figure 4.6 can be seen in Figure 4.7, where it can be observed the proposed process in order to build an interactive method. This figure is divided in two, having in its left side the input activities and in its right side the proposed activities. The explanation of the usage of these activities is described on the following subsections.

Finally, regarding the input and output of the method, this information can be summarised as:

<p>Input for the method:</p> <ul style="list-style-type: none"> -Set of $CR_l, RP_j, Pr_j, Rel_k, Ch_i, EC_m$ -Preliminary layout: initial values of Characteristics -Desirability μ_j for every Property
<p>Output:</p> <ul style="list-style-type: none"> -Traceability tree -Prioritisation of Characteristics by their influence -New values of Characteristics

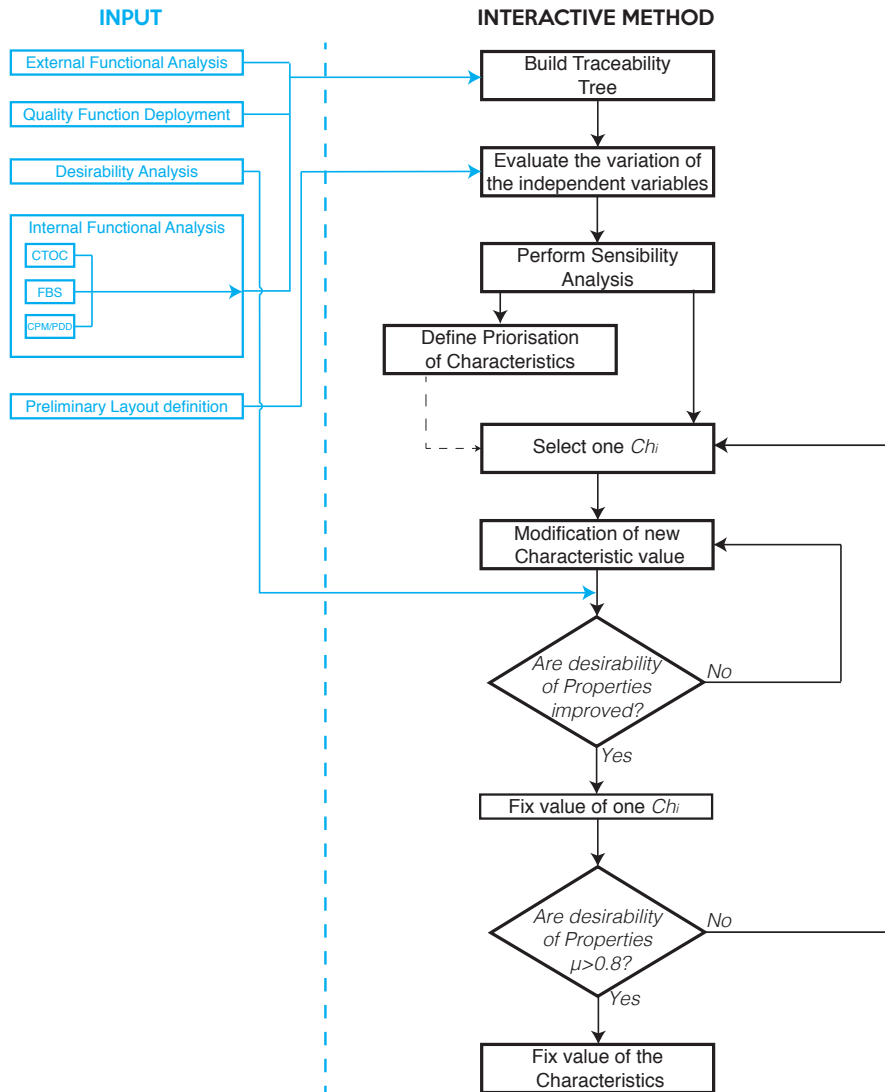

Figure 4.7: Process diagram

4.1. Understanding relationships in product design processes

This section recalls the development of a method that is able to store and manage the information generated through a design process. This method, based on CPM/PDD, is an information management structure based on well-known design methodologies, with the objective of creating a traceability tree that can support decision-making processes.

This kind of information management models allow the interconnection of information at early design stages, linking information that is in a linguistic form, to design variables, and likewise in further information from detailed design. These models can enhance the decision-making process by using the product life-cycle information rather than basing decisions in the experience of the

designers team, especially when correlations are not obvious. For instance, on Figure 4.2, Pr_1 and Pr_2 are apparently unrelated. However, since both Properties share Ch_3 , a small influence of one Property over the other can be inferred.

In order to understand these interactions, it is possible to exploit the information, by using the graphic representation, to identify how the information evolves through the design process. In this thesis, this representation is called the "*traceability tree*" and it will enable users to understand the evolution and how the relationship among CPM elements happens.

The traceability tree's structure stores the information throughout the design process. During each stage, some specific task must be performed in order to make the connection between different types information, i.g., connecting from linguistic domains to numbers domains. This types of information will be understood as "*layers of information*" in this thesis. The following subsections explain the process for building the tree, according each design stage.

The first part in a new product development process is the definition of the "*Properties list*". This list must be based on the EFA. This approach suggests the construction of the properties list and the associated PDS using the standard AFNOR NF-X50-150 (NF-X, 1991). This standard is focused on VA and FA. It is centred in understanding two types of functions: FS³ that correspond to customer needs and FC⁴ that are related to constraints from the environment. These functions are the result of the implementation of a so-called *octopus diagrams*, allowing to understand product's information based on the interaction of the product with the environment (Scaravetti et al., 2005). These functions are then written as design properties, which endorse the attributes on the PDS list. See Appendix A.1 for an example of a functional analysis performed for the design of a portable cooler.

Regarding the association between Properties, Functions and Relationships it is crucial to understand the importance of EFA and IFA. Figure 4.8 represents an example of an octopus diagram. This diagram recalls the functions of a product according to its relation with elements from the environment. Table 4.1 collects the relations between Properties and Functions, as it is stated on the PDS.

The definition of the EFA allows to generate a list of Properties. These Properties are related to the product behaviour and to what the product must accomplish. However they are not connected to the customer requirement list. Having said that, Weber et al. (2004) recall the importance of understanding these user requirements, but the connection with linguistic variables is no boarded in CPM/PDD (Weber et al., 2004).

³Service Functions

⁴Constraint Functions

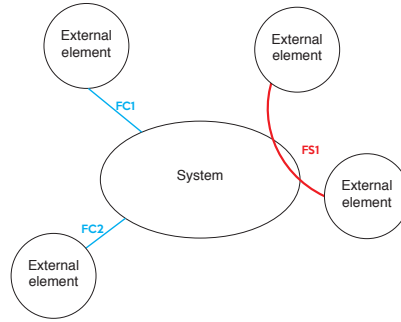

Figure 4.8: External Functional Analysis example

Table 4.1: Properties and Functions [Pr2Fn]

$$\begin{bmatrix} & FS1 & FC1 & FC2 \\ PR_1 & 1 & 0 & 0 \\ PR_2 & 0 & 1 & 0 \\ PR_3 & 0 & 0 & 1 \end{bmatrix}$$

Regarding the connection between linguistic information and technical requirements, one of the most suitable tools in the literature is the QFD (Prasad, 1998). QFD proposes an approach that enables the translation of customer expectations of the product into product specifications (Hassan, 2010).

QFD allow to establish qualitative relations between the first two layers of information: i) Customer Requirements, that represent the "*whats*" on the tool and corresponds to the customer needs. ii) Properties, that represents the "*hows*" and correspond to what the customer expects the product. An example of this tool, can be seen in Table 4.2, which is an extract from the full QFD matrix. This matrix presents the correlation part, which makes a connection between both, "*Customer Requirement*" (in linguistic field) and *Properties*. It is important to recall that the QFD might not always be a diagonal matrix. A bigger example of a QDF can be seen in Table A.5 in Appendix A.1.

Table 4.2: QFD extract: Customer Requirements and Properties [CR2Pr]

	Importance	Pr_1	Pr_2	Pr_3
CR_1	5	●		
CR_2	3			●
CR_3	2		●	

Finally, in Figure 4.9 it is shown the connection between Required Properties and Properties.

This stands for the foundations of the design, in the bottom of the traceability tree. The definition of design objectives and the relationship among them, as well as the user requirements are stored in this part. This will allow to integrate QFD with CPM/PDD which was not considered by Weber et al. (2004) on its proposal. In terms of decision-making, it will increase the traceability up to linguistic variables. Even if in these types of variables the uncertainty is higher, offering the possibility to connect the information will empower the understanding of the process on a design team.

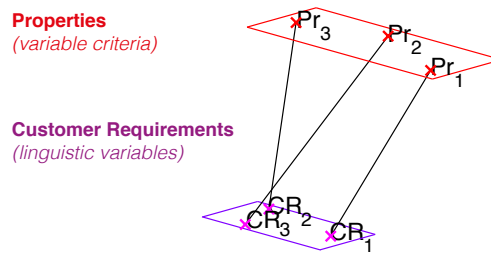

Figure 4.9: Connection between Customer Requirements and Properties

Once connections between the first two layers are defined, the process can proceed to the conceptual design stage, in order to undermine the Functions into elements that enables to define the attributes of the product. This thesis is centred in using the IFA Modelling proposed by Malmiry (2016). This modelling technique merges into a single framework, three conceptual design techniques: CTOC, FBS and CPM/PDD (Malmiry, 2016).

This procedure is necessary to be repeated with all functions. The use of this technique allows a better understanding of the fluxes that enter into the system that is being designed. An example of this conceptual modelling technique can be seen in Figure 4.10. Next, based on these diagrams, a list of relations between Functions and Relations can be consolidated. This list can be seen in Table 4.3.

Table 4.3: Functions and Relations [Rn2Rel]

	Rel_1	Rel_2	Rel_3	Rel_4
$FS1$	1	0	0	0
$FC1$	0	1	0	0
$FC2$	0	0	1	1

Finally, to obtain connections between Properties and Relations, a mathematical operation must be performed between matrices from Table 4.1 and 4.3. The resulting matrix can be seen

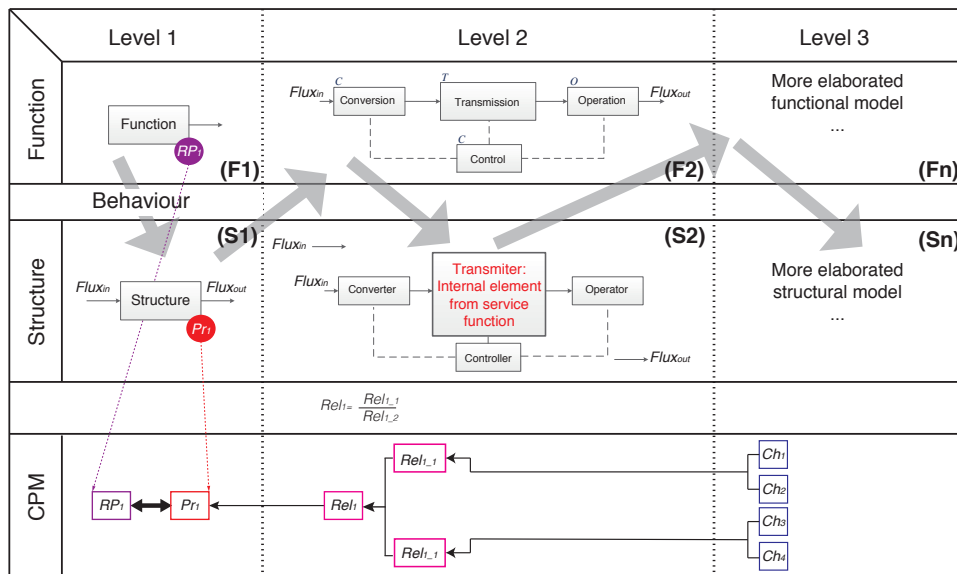

Figure 4.10: Conceptual modelling technique: CTOC, FBS and CPM/PDD. Adapted from (Malmiry, 2016).

on Table 4.4 and connections are depicted in Figure 4.11.

Table 4.4: Properties and Relations [Pr2Rel]

$$\begin{bmatrix}
 & FS1 & FC1 & FC2 \\
 PR_1 & 1 & 0 & 0 \\
 PR_2 & 0 & 1 & 0 \\
 PR_3 & 0 & 0 & 1
 \end{bmatrix}
 \times
 \begin{bmatrix}
 & Rel_1 & Rel_2 & Rel_3 & Rel_4 \\
 FS1 & 1 & 0 & 0 & 0 \\
 FC1 & 0 & 1 & 0 & 0 \\
 FC2 & 0 & 0 & 1 & 1
 \end{bmatrix}
 =
 \begin{bmatrix}
 & Rel_1 & Rel_2 & Rel_3 & Rel_4 \\
 PR_1 & 1 & 0 & 0 & 0 \\
 PR_2 & 0 & 1 & 0 & 0 \\
 PR_3 & 0 & 0 & 1 & 1
 \end{bmatrix}$$

This translation of Functions into Relations using the IFA conceptual modelling, allows to associate to dependent variables with their independent variables. This is the part where the use of CPM/PDD becomes extremely important, in order to develop a model that facilitates the design problem interpretation, by connecting the Properties directly with Characteristics. As an example, let's consider the Relations form Equations 4.4, 4.5, 4.6, 4.7.

$$Rel_1 = \frac{Ch_1 - Ch_2}{\frac{Ch_3}{EC_1 * Ch_4} + \frac{Ch_5}{EC_2 * Ch_6} + \frac{Ch_7}{EC_3 * Ch_8} + \frac{EC_5 * Ch_9}{Ch_{10} * EC_4}} \quad (4.4)$$

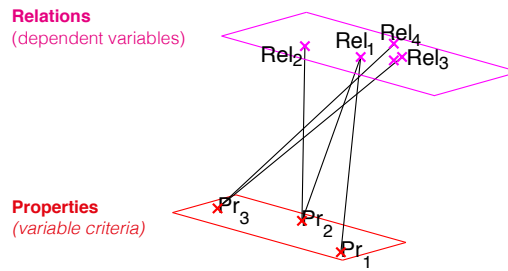

Figure 4.11: Connection between Properties and Relations

These Relations might be represented by two different approaches. On one hand, the first approach connects directly the Relation with the Variables, whether Characteristics or External Conditions. This approach leads to high computation time, because of how the information is arranged. A representation of this can be seen in Figure 4.12a. On the other hand, the approach proposed by CPM/PDD empowers the deployment in several sub-relations. This can be observed in Figure 4.12b.

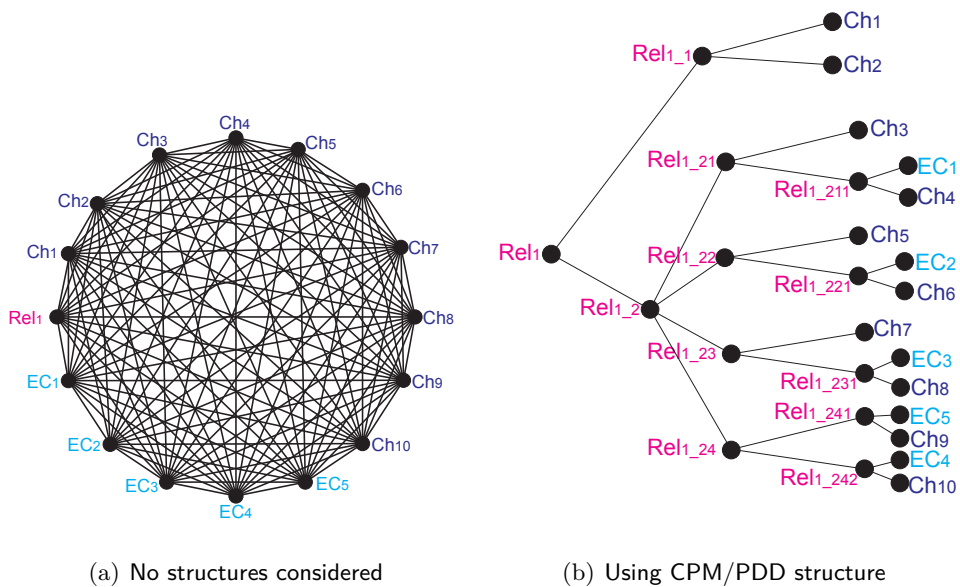

Figure 4.12: Relation representation

About how to express sub-relations, more examples may be found in Figure 4.13. These examples are related to Equations 4.5, 4.6, 4.7. The goal of using CPM/PDD is to express Relations and sub-relations as simple and reduced as possible. It is suggested to define as sub-relation any fraction, splitting the numerator and denominator elements.

$$Rel_2 = \frac{Ch_5}{Ch_1 * EC_5} - Ch_8 \tag{4.5}$$

$$Rel_3 = \frac{(Ch_1 + Ch_2)^{EC_3}}{Ch_3} \tag{4.6}$$

$$Rel_4 = \frac{^{EC_3}\sqrt[3]{Ch_4}}{Ch_5 - Ch_6} \tag{4.7}$$

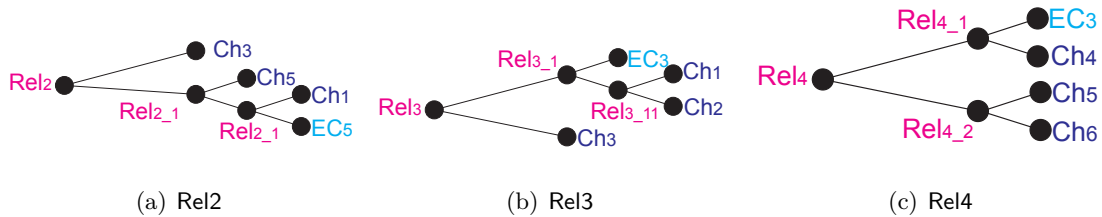

Figure 4.13: Relation representation

Also, this approach of declaring several sub-relations, requires to build a matrix for making connections between Relations and both, Characteristics and External Conditions. This relationship can be found in Table 4.5.

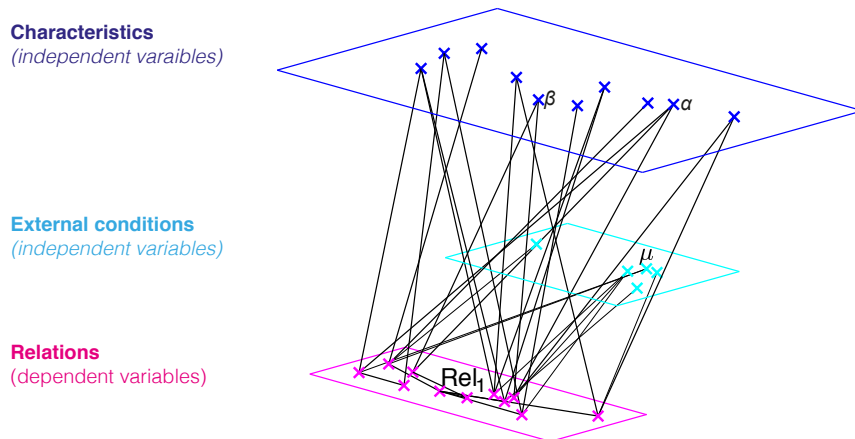

Figure 4.14: Connection between Relations, Characteristics and External Conditions

Finally, by doing this the construction of this information framework allows to elicitate relationships among design information. This framework, defined as a traceability tree, allows to understand and discern different layers of the information.

Also, it is important to define that this traceability tree allows to figure out how the uncertainty evolves during a design process, making it clear about how design methodologies reduce the lack of awareness in decision-making (Giachetti et al., 1997).

Still, since tree takes its structure from the CPM/PDD, the design team is able to manage and understand how the aleatory and epistemic uncertainty interacts with the design (See Figure

2.8 on Section §2.2.1.1).

Finally, in Figure 4.15 a representation of a full Traceability Tree is presented.

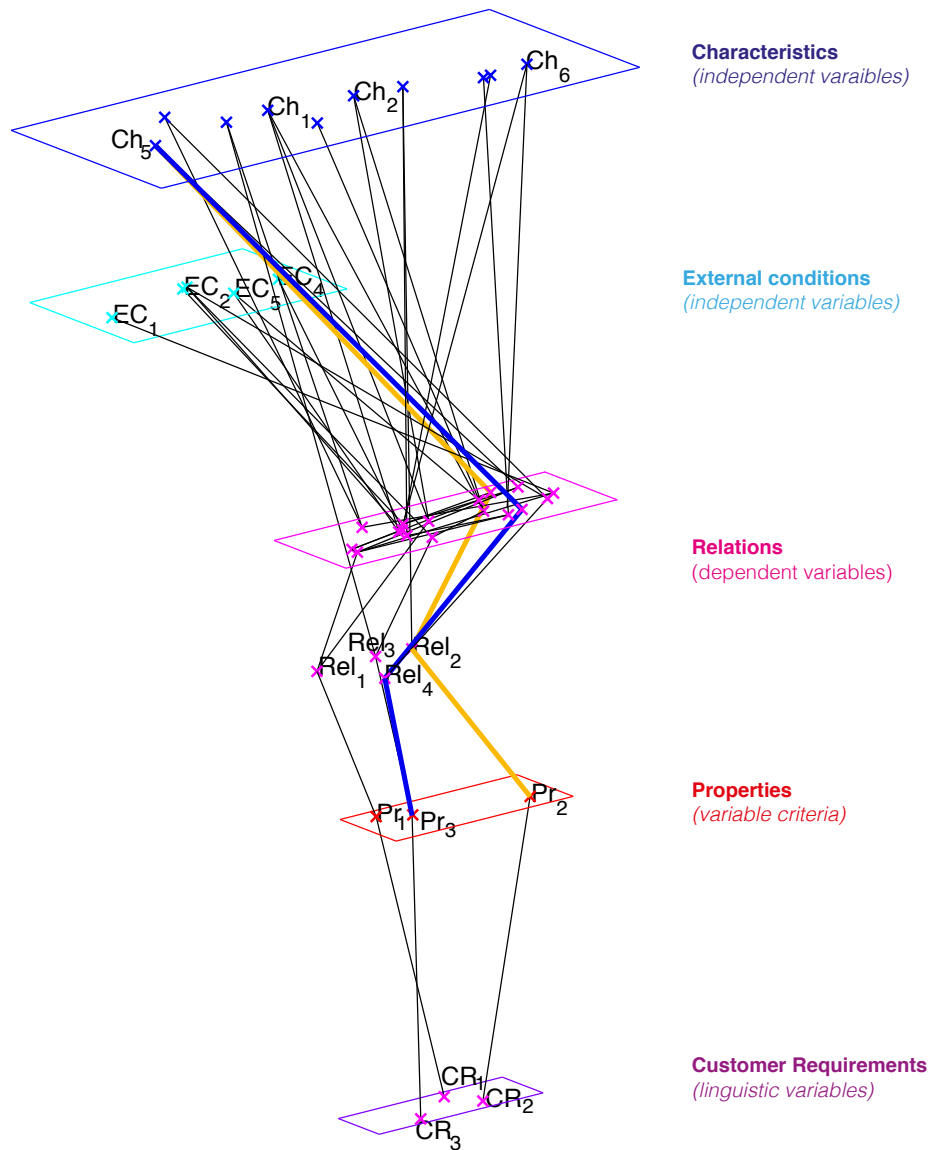

Figure 4.15: Full traceability tree based on CPM/PDD

Table 4.5: Relations to Characteristics and External Conditions [Rel2Var]

Relations	Sub-relations																Characteristics										Ext. Conditions														
	Rel1	Rel11	Rel12	Rel121	Rel1211	Rel122	Rel1221	Rel123	Rel1231	Rel124	Rel1241	Rel1242	Rel2	Rel21	Rel211	Rel3	Rel31	Rel311	Rel4	Rel41	Rel42	Ch1	Ch2	Ch3	Ch4	Ch5	Ch6	Ch7	Ch8	Ch9	Ch10	EC1	EC2	EC3	EC4	EC5					
Rel1		1	1																																						
Rel11																						1	1																		
Rel12				1		1		1		1																															
Rel121					1																																				
Rel1211																							1	1																	
Rel122							1																			1															
Rel1221																											1														
Rel123									1																			1													
Rel1231																																									
Rel124											1	1																													
Rel1241																																									
Rel1242																																									
Rel2														1																											
Rel21							1								1																										
Rel211																						1																			
Rel3																																									
Rel31																																									
Rel311																																									
Rel4																																									
Rel41																																									
Rel42																											1	1													

Note: Blank spaces represent zero. Left blank intentionally for representation reasons.

4.2. Measuring interaction between Properties and its Characteristics

Previous section was centred in explaining how to build a traceability framework that manages the whole information generated in product design processes, in order to understand the relationships of the design information. Nevertheless, a proper design understanding must be able to measure those relationships in order to figure out how a modification of a Characteristic impacts a Property. This empower designers to anticipate how potential modifications in the Characteristics, may impact the Properties behaviour.

Based on the traceability tree, a deeper analysis can be made. In this thesis, it is proposed to weight the vertices that make the tracelinks⁵ between elements from different layers in order to calculate how a modification in one item can impact the overall design. This weighting allows to comprehend how sensible is one element to the variation of other element.

The weighting strategy is divided in two parts: connections among Customer Requirements, Properties and Relations and connections among Relations, Characteristics and External Conditions.

Regarding to the tracelinks between Customer Requirements and Properties, and in order to reduce the impact of subjective decisions, the weight of each vertex is declared as 1.0, eliminating the subjectivity associated to the QFD qualifications (0.9, 0.3 and 0.1 for high, medium and low relationships). Also, relationships between Properties and Relations are defined as 1.0 as well.

Connections among Relations, Characteristics and External Conditions are defined according to the interaction that can be calculated among them. One of the most used techniques in the literature, for measuring these interactions, is the Sensitivity Analysis. Among the reviewed articles from Section §3.1, SA were used in almost the 20% of the articles.

The interpretation of this SA rely on the ability of this method to identify the most influential variable regarding a defined design goal. That is to say, this kind of methods are able to inform the design team, about which Characteristics may be modified, in order to achieve certain output behaviour on the Properties.

Different SA models can be found in literature. Authors such as Hamby (1994) had compared some of these techniques, according to different applications and constraints. The application of certain SA methods allow to compare different features. Consequently, it is necessary to understand what to measure in order to perform an analysis of the results (Hamby, 1994).

⁵link connecting two elements in the traceability tree

In this thesis, *Partial Rank Correlation Coefficient* (PRCC) is implemented. This technique has been chosen because to its capacity to deliver a normalised value, where the closer to 1, the stronger the degree of relationship between independent variables (Characteristic or External Condition) and dependent variables is (Property) Hamby (1995). This technique is also present in the state of the art for analysing design problems and for presenting results by sorting variables from the most influencer, to the least influencer (Gagnon et al., 2018).

Likewise, one of the most remarkable reasons for selecting the PRCC technique is based in the way the correlation index can be addressed: **normalised**.

This attribute is necessary because it empowers a better comparison. For example, in Figure 4.15, Pr_2 and Pr_3 might have different measurement criteria. Nevertheless, both Properties share Ch_5 . Thus, it is necessary to develop a framework that allows to make an analysis about how the modification of Ch_5 may impact, for better or worse, the behaviour of Pr_2 and Pr_3 ⁶.

By understanding how the modification of certain Characteristic have more possibility of affecting the output behaviour of the Properties, it will be clear the need of structure and store this information. In the proposed model, this sensibility attribute will be stored as the weight of each vertex in the traceability tree.

The process for *measuring the interaction between Properties and its Characteristics* is proposed in Figure 4.16. For doing so, it is necessary to have defined a preliminary layout of the solution, where an initial value of the Characteristics and the External Conditions are already set.

The following subsections are centred in explaining the process from Figure 4.16. This process is divided in two parts: the first part is to define the variation limits of the Characteristics and External Conditions. The second part is related to the use of sensitivity analysis techniques in order to calculate the influence of the Characteristics on the Properties.

4.2.1. Evaluation of independent variables variation

The first step in the process is to evaluate both, External Conditions and Characteristics. This evaluation must be centred in understanding two aspects among them. The first one is the variation range, which is to say, the minimum and maximum value expected on independent variables. The second one, is the variation profile.

For example, let's say Ch_i takes values from the interval of 0.01 and 0.03. Then, it is necessary to define a variation profile. The variation profile is the trend of how the independent variable

⁶This connections can be seen in the traceability tree in a different colour. See Figure 4.15, where yellow and blue trcelinks highlight this particular case

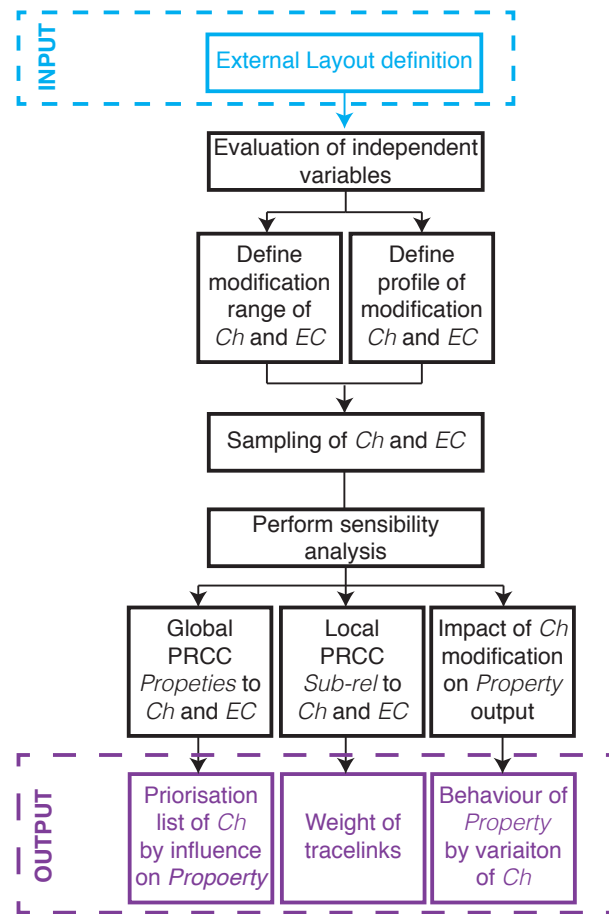

Figure 4.16: Process for calculate interaction Properties and its Characteristics

may change. This variation corresponds to the distribution of the variable, which is to say, if the variable should be close to its lower bound, centred or upper bound.

For defining the variation profile, the design team must understand the variable nature's. The different sampling options can be observed in Figure 4.17 where Probability Density Function (PDF) is presented according the variation of the Characteristics. The distributions are:

- Forced low: recommended when lower values are mandatory. (Exponential distribution $\lambda = 1/0.3$).
- Low: recommended when the Characteristic or External Condition should be kept in low levels (Weibull distribution $\lambda = 1$ $k = 1.5$), but not necessarily the lower bound.
- Normal: when the values should follow a normal distribution, with \bar{x} and σ^2 from the analysed variable.
- Centred: recommended to centred values (Weibull $\lambda = 1$ $k = 3.5$). Its difference with

normal is the presence of shorter tails. It might be recommended when the preference is unknown.

- High: recommended when values should be kept in high levels (Weibull $\lambda = 1$ $k = 10$), but not necessarily the upper bound.
- Forced high: recommended when higher values are mandatory. (Beta distribution $\alpha = 5$ $\beta = 1$).

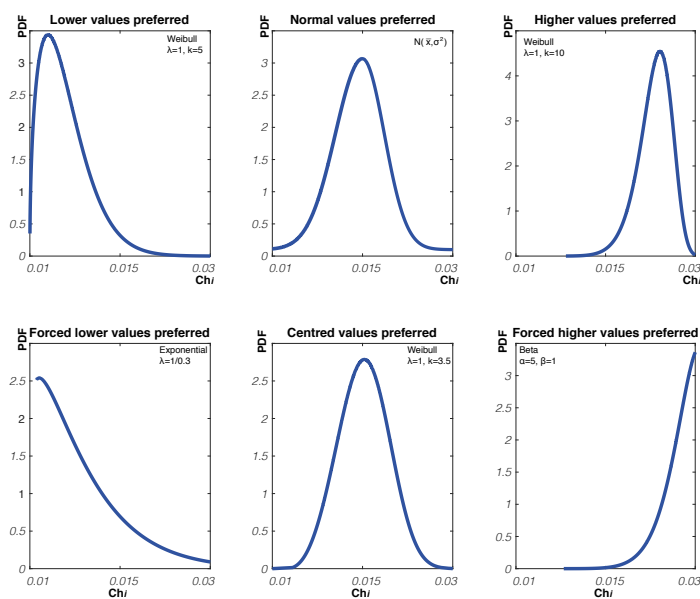

Figure 4.17: Possible variables' distributions

Once variation profiles of the Characteristics and External Conditions are defined, designers can proceed to perform a Monte Carlo sampling, by using the distributions defined in each variation profile.

Defined those random distribution of the values of the Characteristics and External Conditions, the values of the Properties, Relations and sub-relations can be estimated. The output will be the random distribution of the behaviour of the Properties.

From the sampling results, designers can proceed with the SA, to help to understand the impact of modifications of the Characteristics in the overall design. In Figure 4.18 it can be seen it can be generated the distribution of the Property, based on the equation and the sampling of its Characteristics and External Conditions.

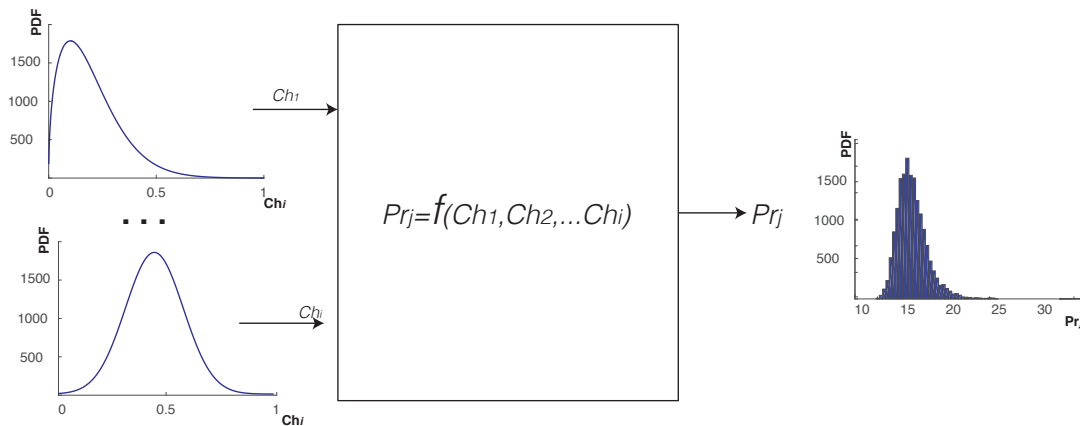

Figure 4.18: Generation of Properties distribution from Monte Carlo sampling

4.2.2. Interpretation of sensibility analysis

As it was mentioned before, the PRCC is the SA technique used in this thesis. This technique is used for two of the three expected outputs:

- Prioritisation list of Characteristics: Global Sensibility Analysis (GSA) by PRCC.
- Tracelinks weighting: Local Sensibility Analysis (LSA) by PRCC performed at any level of *sub-relations - Characteristics/External Conditions*.
- Behaviour of the Property by the variation of a Characteristic: calculated by the partial derivative of the Property and each Characteristic.

4.2.2.1. Global sensibility analysis of a Property

Regarding influences of the PRCC, this technique evaluates how the variation of the Characteristics influences the Property. While the local analysis is centred in understanding the interaction between a sub-relation and its Characteristics, the global analysis is centred in understating the global impact of a Ch_i modification on the Property Pr_j . Subsequently, having a set of real variables, taking random values, it is possible to calculate a random outcome of the Property, in the following way:

Given:

X, random continuous set of real values of an independent variable

Y, random continuous set of real values of other independent variable

C, dependent variable following the equation $C = X * Y$

Then:

C is a joint probability distribution of random continuous set of reals values of a dependent variable based on the operations between variables it is composed of.

Then, the correlation index can be calculated numerically or analytically. When the values of the Independent Variables (X), that make part of the Property (C) are known, the correlation ρ can be obtained following Equation 4.8.

$$\rho_{XC} = \frac{N \sum_{i=1}^N r_{X_i} r_{C_i} - \sum_{i=1}^N r_{X_i} \sum_{i=1}^N r_{C_i}}{\sqrt{N \sum_{i=1}^N r_{X_i}^2 - \left(\sum_{i=1}^N r_{X_i}\right)^2} \sqrt{N \sum_{i=1}^N r_{C_i}^2 - \left(\sum_{i=1}^N r_{C_i}\right)^2}} \quad (4.8)$$

This method can be applied when there is an analytical equation between Independent Variables and Properties. Thus, the Variables' partial derivatives with respect the Property, can be calculated. Later, in order to calculate the Correlation Index, it is necessary to normalise the results.

The sensibility for each Property can be calculated, based on the data for Characteristics and External Conditions. Figure 4.19 shows the sensibility analysis of a given Property for both, External Conditions and Characteristics and it will be further explained.

For representation purposes, it is selected a Property from the example of Appendix A, corresponding to a design of a portable cooler. The Relation connected to the internal temperature Property is shown in Equation 4.9 from the context detailed in Appendix A.2.1.4⁷.

$$T = T_5 + e^{\frac{t \ 2 H_C (L_C + W_C) (T_0 - T_5)}{C_p M \left(\frac{1}{5.6 \left(\frac{\Delta T_{i,in}}{H_C T_5}\right)^{1/4}} + \frac{1}{5.6 \left(\frac{\Delta T_{i,ext}}{H_C T_0}\right)^{1/4}} + \frac{th_A}{K_A} + \frac{th_B}{K_B} + \frac{th_C}{K_C} \right)}} \quad (4.9)$$

The full preliminary design of the product can also be seen on Appendix A; nevertheless a brief summary of its specifications can be made. This portable cooler should meet a volume of 50 litres and should keep the aliments below 10°C. The architecture of the cooler is simple. Its wall is composed by a three-layer element, where the external and internal walls are in a regular plastic (Polypropylene) and the middle wall is an insulator element (Foam). This architecture is able to isolate the interior of the cooler from the external air, which has a higher temperature.

One of the Properties of this cooler represents the internal temperature after 5 hours. The Relation related to this Property is the one related on Equation 4.9. This Property is represented by a non-linear equation.

⁷See Equation A.13 for a detailed explanation of the Equation definition.

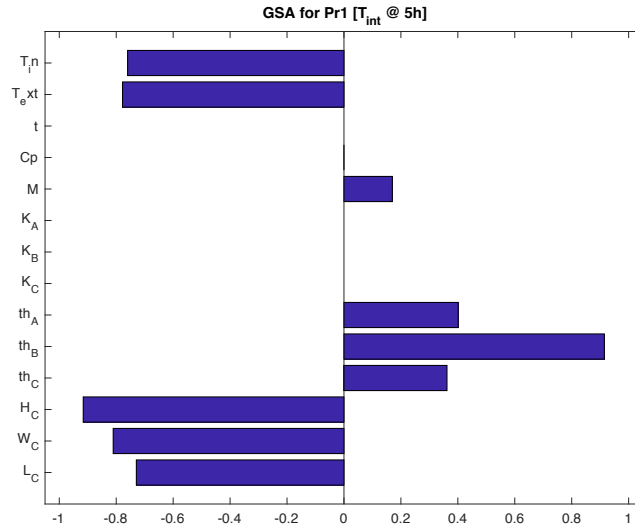

Figure 4.19: Correlation Index for Internal Temperature after 5h

By analysing Figure 4.19, issued from the cooler design case, it can be concluded that the most influencers variables for the internal temperature Property Pr_1 are th_B and H_C . th_B is the thickness of the insulator wall and the results of the SA showing that is the most influencer in general terms (among positive or negative) and it has the bigger positive impact. In contrast, H_C has the worst impact. This Characteristic (H_C) is the internal height of the cooler and it can be concluded that the higher is the value of this Characteristic, the higher will be the temperature. A behaviour which is not desirable in the product.

Also, from Figure 4.19, it can be observed the impact that T_{ini} and T_{ext} have on the cooler. Still, the design team is not able to control these independent variables because both are External Conditions. It is important for the design team, to have in mind the influence on the design of the External Conditions and this kind of sensibility analysis empowers the understanding of these situations.

4.2.2.2. Local sensitivity analysis of a Property: tracelinks' weight

According to the vertices' weight in the traceability tree, the same procedure of PRCC can be implemented, as well as the results of the interactions between sub-relations with Characteristics and External Conditions. For instance, it will be considered the sub-relation of equivalent area of heat transfer. This sub-relation can be seen on Equation 4.10.

$$A_{eq} = 2 * H_C * (L_C + W_C) \quad (4.10)$$

Implementing a PRCC on this sub-relation will allow to weight the vertices of the traceability tree in this specific part. It is important to notice that the equivalent area equation (A_{eq}) is composed by a Characteristic (H_C) and a lower level sub-relation, that is composed by two more Characteristics (L_C, W_C). This will determine that a lower level PRCC is necessary to be implemented.

For instance, Figure 4.20 shows the result of the sub-relation of equivalent area (A_{eq}). In Figure 4.20a the results of the SA are shown. Since the sub-relation is lineal, it was expected that the results were close to 1.0. Yet, it can be concluded that the influence of H_C is bigger than the influence generated by the sub-relation that contains L_C and W_C . Complementary Figure 4.20b shows the trancelinks' weight of the Characteristics that build the sub-relation.

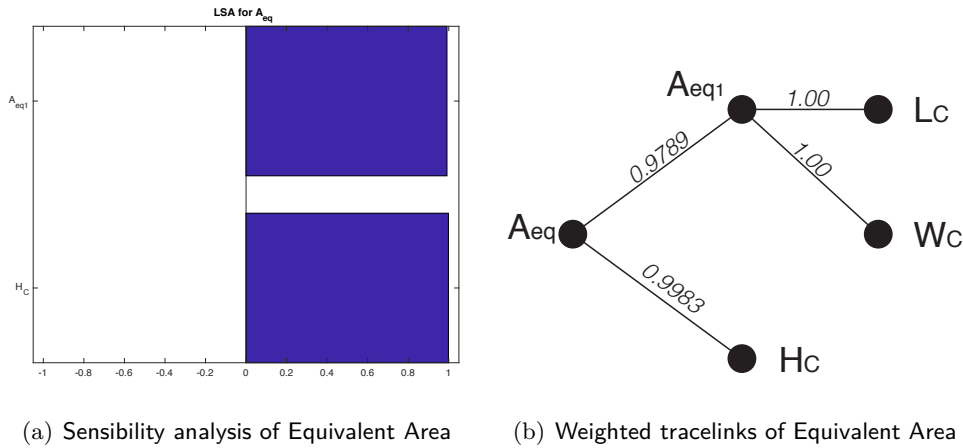

Figure 4.20: Local sensibility analysis of equivalent area (A_{eq})

The importance of weighting trancelinks is centred in the interpretation of the traceability tree as a graph. This enables to use graph theory for paths analysis in order to measure the influence between two elements in the traceability tree. These analysis and their implications are explained in detail in Section §4.3.

4.2.2.3. Properties' behaviour by modification of its constituents Characteristics

Finally, the last part of the SA interpretation is related to the detailed evaluation of the influence on a Characteristic, a Property and the behaviour of the modifications. This analysis is divided in two parts: i) Analyse the Property (Equation 4.11) as a function of one specific Characteristic. ii) Calculate the partial derivative of the Property with respect to the Characteristic (Equation 4.12).

$$Pr_j = f(Ch_i) \quad (4.11)$$

$$\frac{\partial Pr_j}{\partial Ch_i} \quad (4.12)$$

Later, the analysis continues with the evaluation of the Property and the partial derivative by the modification of a variable. For this it is necessary to lock the variation of the rest of External Conditions and Characteristic, in order to modify the selected Ch_i between their minimum and maximum values. This will allow to have a visual representation of the behaviour of Equation 4.11 and Equation 4.12.

Considering again the cooler design case, as seen in Figure 4.19, the most influencer Characteristics were th_B and H_C . Among these Characteristics, it is important to recall their variation intervals, where th_B varies between 0.01 and 0.03cm and H_C varies between 0.2 and 0.5cm. Evaluating the behaviour of Pr_1 with respect to th_B , the partial derivative can be calculated, as seen in Equation 4.13.

$$\frac{\partial Pr_1}{\partial th_B} = - \frac{2 H_C t e \left(\frac{C_p M \left(\frac{5}{28 \left(\frac{\Delta T_{in}}{H_C T_5} \right)^{1/4} + \frac{5}{28 \left(\frac{\Delta T_{ext}}{H_C T_0} \right)^{1/4} + \frac{th_A}{K_A} + \frac{th_B}{K_B} + \frac{th_C}{K_C}} \right)}{28 \left(\frac{\Delta T_{in}}{H_C T_5} \right)^{1/4} + \frac{5}{28 \left(\frac{\Delta T_{ext}}{H_C T_0} \right)^{1/4} + \frac{th_A}{K_A} + \frac{th_B}{K_B} + \frac{th_C}{K_C}} \right) (L_C + W_C) (T_0 - T_5)}{C_p K_B M \left(\frac{5}{28 \left(\frac{\Delta T_{in}}{H_C T_5} \right)^{1/4} + \frac{5}{28 \left(\frac{\Delta T_{ext}}{H_C T_0} \right)^{1/4} + \frac{th_A}{K_A} + \frac{th_B}{K_B} + \frac{th_C}{K_C}} \right)^2} \quad (4.13)$$

Varying th_B between its intervals will allow to evaluate its behaviour in both, the influence in the Property (Equation 4.9) and the partial derivative (Equation 4.13). These visual representations of $Pr_1 = f(th_B)$ and $\frac{\partial Pr_1}{\partial th_B}$ can be observed in Figure 4.21a. Also, the same analysis can be performed on the variation of H_C and is depicted in Figure 4.21b.

For th_B , the within between its interval (0.01 and 0.03cm) has an impact of 1°K in the output that represents around 0.35%. Analysing Figure 4.21a, for this Characteristic, the bigger the value, the lower the temperature, which is the goal of this case. In detail, it can be observed that the bigger the value, the slope (that can be seen in the partial derivative) starts to get smaller. This can be understood that in the highest interval, the impact of modifying th_B gets lower and lower.

On the same time, for H_C (Figure 4.21b) the higher the value, the higher the Temperature, which is an unexpected output. For this Characteristic, within the whole interval of variation,

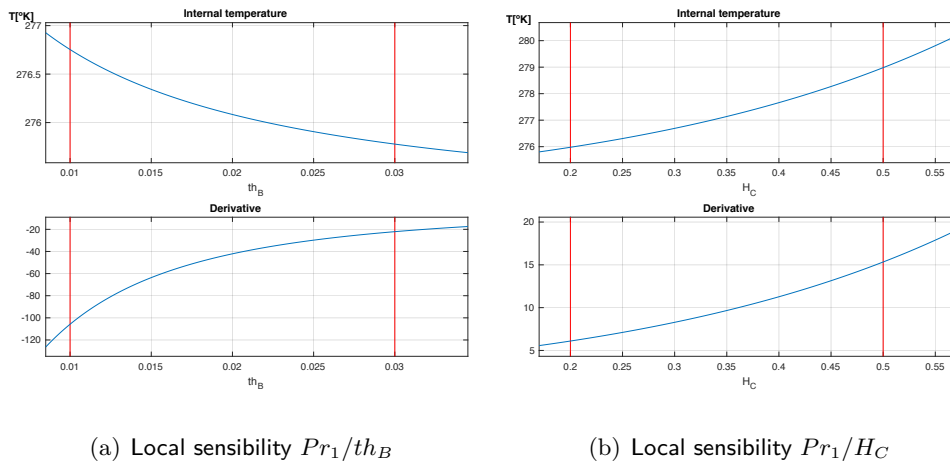
Figure 4.21: Local sensibility for Pr_1

the temperature changes around 3°K (circa 1.09%), but, the interval of variation is bigger. An average comparison of slopes determines that the impact of modification of H_C , centimetre by centimetre can be calculated as 10 times shorter.

For the design team, getting access to this information, allows them to understand the interaction between the Properties and its Characteristics. It is important to guarantee the easy access to this information and to guide them in the understanding on how to use this information, in order to take decisions in a situation where modifications are needed in product design processes.

Finally, as a summary of this subsection, Figure 4.22 represents the connection between the sampling and the analysis. The method is centred in users to generate distributions for the Characteristics and the External Conditions. With these values, and based in Relations, a distribution of the possible values of the Properties can be generated. Connected to this, to each Property, a SA can be performed in order to generate the list of the most influencer Characteristics, as well as to understand how is the impact of a modification of each Characteristic. The usage of this information is expanded in Section §4.3.

4.2.3. Development of a traceability framework

Previous subsections were focused in the generation of an information management structure, based on CPM/PDD, as well as the calculation of how happens the interactions between Properties and Characteristics. The evaluation of both approaches lead to define a framework that allow to understand how Properties-Characteristics-Properties interactions take place.

It is proposed to generate a graph with the information generated on the design process. This graph integrates the information generated from Section §4.1 about the traceability tree and the

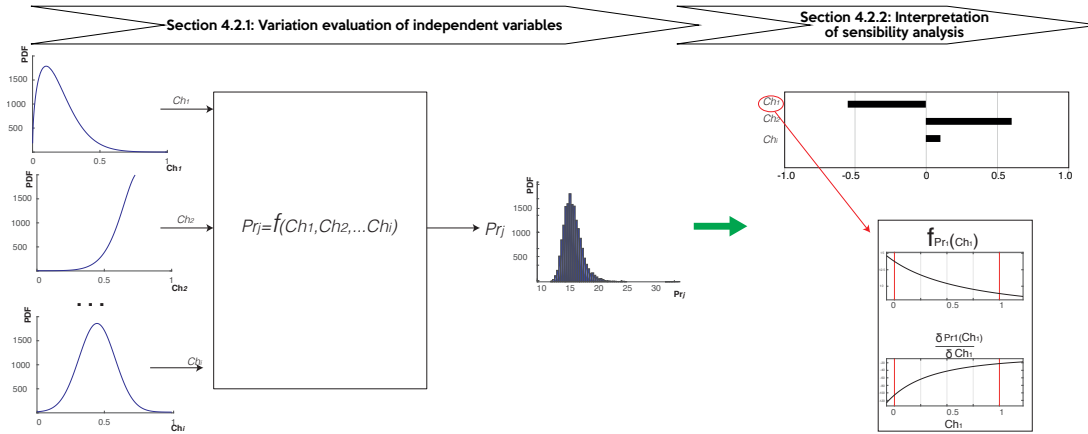

Figure 4.22: From Monte Carlo sampling to Sensibility Analysis

LSA from Section §4.2: the first represents the connections among Properties-Characteristics and the second represents the weight of those connections.

The proposed graph is built adapting the generated matrices of the traceability tree and arranging them in order to produce an adjacency matrix. The structure of the adjacency matrix can be seen on Equation 4.14.

$$AdjMat = \begin{bmatrix} - & CR_l & Pr_j & Rel_k & Ch_i & EC_m \\ CR_l & 0 & QFD & 0 & 0 & 0 \\ Pr_j & 0 & 0 & Pr2Rel & 0 & 0 \\ Rel_l & 0 & 0 & Rel2Rel^* & Rel2Pr^* & Rel2EC^* \\ Ch_i & 0 & 0 & 0 & 0 & 0 \\ EC_m & 0 & 0 & 0 & 0 & 0 \end{bmatrix} \quad (4.14)$$

This adjacency matrix includes the entire information of the relationships among different layers of information stored in the traceability tree. It also includes the information related the weight of the tracelinks. This is made by labelling the weight of each vertex as the result of the value of the local sensibility analysis (See Section §4.2.2.2) between Relations, sub-relations and Characteristics. The definition of this matrix is important, because, as it was mentioned before, it is intended to use graph theory for paths analysis and the adjacency matrix definition allows to do these calculations.

Also, for the construction of the tracelinks' weights, it is used $Rel2Rel^*$, $Rel2Pr^*$ and $Rel2EC^*$ from Equation 4.14. The calculation of the size of the matrix is given by the sum of the elements of CR_l , Pr_j , Rel_k , Ch_i , EC_m .

Considering, again, the design of the portable cooler from the Appendix A, it includes: 5

Customer Requirements (CR), 7 Properties (Pr), 31 Relations and sub-relations (Rel), 13 Characteristics (Ch) and 6 External Conditions (EC). The traceability graph that can be built with the information of this design, can be seen in Figure A.12 within the Appendix. Likewise, the size of the corresponding adjacency matrix will be 65x65.

Understanding that the traceability tree can be treated as a graph, this enables the use of graph theory methods in order to analyse the possible relations that can happen in a design between Properties and Characteristics. For example, Figure 4.23 depicts, an extract of the traceability graph, represents the graph of Property 1.

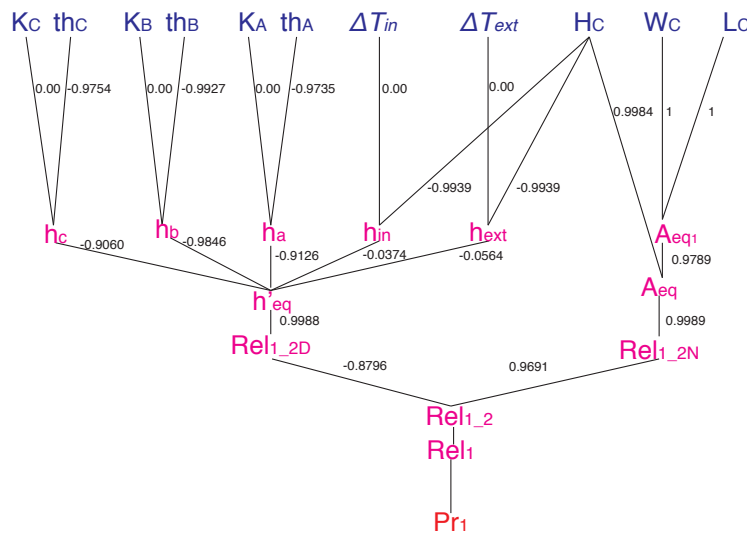

Figure 4.23: Traceability tree for Pr_1 (Characteristics only)

The partial graph from Figure 4.23 connects the Property to its Characteristics. Among the whole set of information, several partial connections can be established. For analysing those possible interactions, whether Property-Characteristic or Characteristic-Characteristic, it is introduced the concept of *vertices weight index*. This will be noted by the Greek letter Ψ , which represents the normalised sum of the weights of a path that connects two elements of the graph. Regarding to Property-Characteristic connections, the Ψ index will indicate the normalised weighted sum of the path. This is represented as:

$$\Psi_{Pr_j/Ch_i} = \frac{\sum |\rho\{Pr_j \rightarrow Ch_i\}|}{\#elements} \quad (4.15)$$

For instance, the definition of this index allow to understand certain connections. For example on Figure 4.23, three different paths can be identified between Pr_1 and Hc . In detail, those paths can be observed in Figure 4.24, where several paths can be identified. For each path, a weighted

sum is calculated (See Table 4.6). In terms of Ψ_{Pr_1/H_C} , it is assigned to the highest value of the sum. Thus, the Ψ_{Pr_j/Ch_i} index, determines the most strong connection between a Property and its Characteristic.

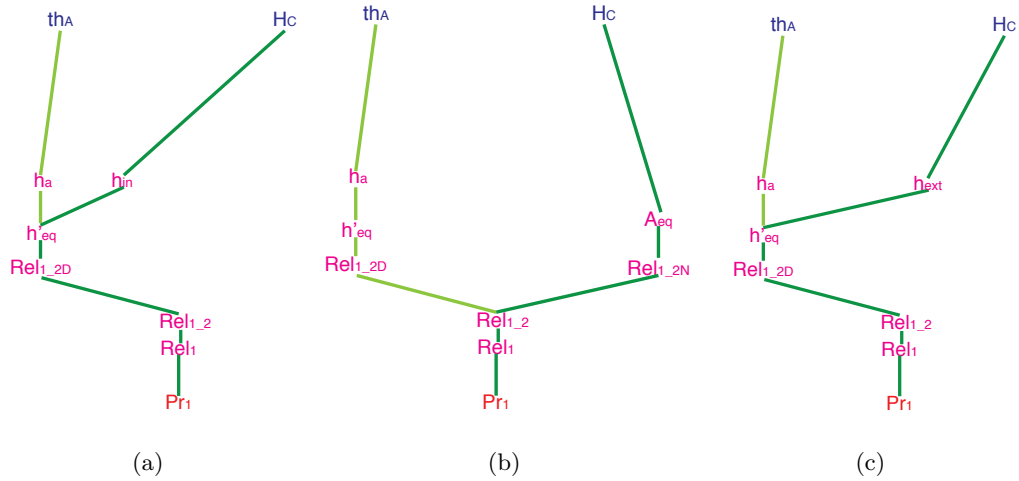

Figure 4.24: Paths from Pr_1 to th_A and H_C

Table 4.6: Weight of paths between Pr_1 and H_C

Path	Sum of weights	Normalised value
Figure 4.24a	4.9097	0.8182
Figure 4.24b	4.4.9664	0.9932
Figure 4.24c	4.9287	0.8214

Likewise, the analysis of this graph allows to evaluate other types of connections, such as the connection between any pair of Characteristics. These connections can determine a specific challenge, specially when it is unknown about how a modification will impact the system's behaviour. Figure 4.24 shows the possible connections between th_A and H_C .

To do so, a concept that allow to understand those connections (between two elements) is the *shortest path*. A shortest path is defined as the sequence where the sum of the weights of its constituent edges is minimum. Therefore, one criteria for connecting these both Characteristics from Figure 4.24 is the shortest path, which may be useful to measure the collateral connections, allowing designers to anticipate those situations in order to improve their decision-making processes. From Figure 4.24, the shortest path between th_A and H_C is the path that passes through the sub-relation h_{in} , resulting into a total weight of 2.9174 (Figure 4.24a).

Nevertheless, the most critical situation, in design, will occur when a modification of a Characteristic can impact the Properties where there is not a direct connection available. Based on

graph theory, an understanding on how the local definition of shortest paths can be used. To do so, it is proposed a method for calculating the shortest path between any pair of elements in the traceability graph. The method works as follows:

Given:

- Pr_a , which is a Property that is directly connected to Ch_a but no to Ch_b
- Pr_b , a Property that is connected to Ch_a and Ch_b

There exist:

$Pr_a \rightarrow Ch_b$, which is a path that connects Pr_a with a Ch_y that is not directly connected to the Property

The procedure for finding this path, the Algorithm 1 is defined:

Algorithm 1: Find path between unconnected Properties-Characteristic

- 1 **Set** $Chain_a$ as the shortest path between Pr_a and Ch_a
 - 2 **Set** $Chain_2$ as the shortest path between Pr_b and Ch_a
 - 3 **Set** $Chain_3$ as the shortest path between Pr_b and Ch_b
 - 4 **Set** Edge $Edge_a$ as the shared edge between $Chain_1$ and $Chain_2$
 - 5 **Determine** Edge $Edge_b$ as the shared edge between $Chain_1$ and $Chain_3$
 - 6 **Define** $Path_1$ as $Pr_a \rightarrow Edge_a$
 - 7 **Define** $Path_2$ as $Edge_a \rightarrow Edge_b$
 - 8 **Define** $Path_3$ as $Edge_b \rightarrow Ch_b$
 - 9 **Define full path** $\{Path_1; Path_2; Path_3\}$
-

This path allows defining connections between unrelated Properties and Characteristics, defined according to its shortest path. This new path, does not answer to the GSA and LSA analysis, so it is necessary to define a framework for its evaluation and comparison.

It is proposed to weight the new paths with an instantiation of the Ψ index that will allow to evaluate the graph. To do so, it is proposed to evaluate: Ψ_{Path_1} , Ψ_{Path_2} and Ψ_{Path_3} . This calculations allow to assess if the influence of the Characteristic is positive or negative on the Property. Equation 4.16 represents the Ψ' index of a Property Pr_a and the collateral correlation of Ch_x by Ch_y

$$\Psi'_{Pr_a:Ch_a/Ch_b} = \Psi_{Path_1}, \Psi_{Path_2}, \Psi_{Path_3} \quad (4.16)$$

$$\Psi' Pr_a : Ch_a/Ch_b = \left(\sum \rho \{Pr_a \rightarrow Edge_a\} \right), \left(\sum \rho \{Edge_b \rightarrow Edge_a\} \right), \left(\sum \rho \{Edge_b \rightarrow Ch_b\} \right) \quad (4.17)$$

The use of the proposed Ψ' index is valuable in situations of collateral relationships. For example, lets take again the cooler design case. It will be considered the relationship between $Pr_7=internal\ volume$ and $th_A=thickness\ of\ the\ external\ wall$. The thickness th_A is not part of the equation of internal volume (See Equation A.20). Nevertheless, it is required to know which kind of relationship exist between both, the Property and the Relationship. In Figure 4.25 it can be observed a representation of this connection and the paths in green that connects Pr_7 and th_A , as well as the weights of their vertices are the following.

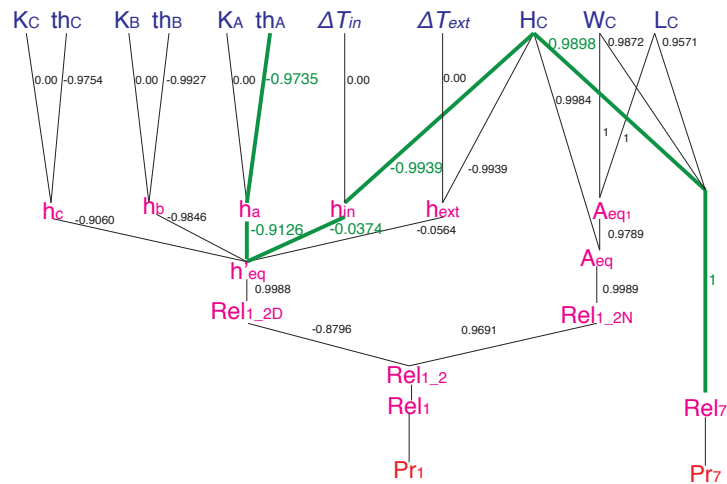

Figure 4.25: Connection between Pr_7 to th_A

Based on the weight of the vertices presented in Figure 4.25, the definition of the shortest path composed by $Path_1$, $Path_2$ and $Path_3$ is given and evaluated as:

$$Path_1 = Pr_7 \rightarrow H_C, \quad \Psi_{Path_1} = 1.9898/2 = 0.9949$$

$$Path_2 = H_C \rightarrow h_{eq}, \quad \Psi_{Path_2} = 1.013/2 = 0.5065$$

$$Path_3 = h_{eq} \rightarrow th_A, \quad \Psi_{Path_3} = 11.8861/2 = 0.94305$$

Further, evaluating and comparing the obtained Ψ , it can be concluded that:

$$\Psi_{Path_3} > \Psi_{Path_2}$$

$$\Psi_{Path_1} > \Psi_{Path_2}$$

Analysing the collateral correlation, Pr_7 is related to the internal volume of the cooler, where Pr_a is Pr_7 , Ch_x is H_C and Ch_y is th_A . The collateral relationship with th_A is given due to a connection with $Edge_b=h_{eq}$, which makes part of $Pr_1 = \text{Internal temperature}$. Since $Edge_b=h_{eq}$ it contains both $Ch_x=H_C$ and $Ch_y=th_A$, their interactions are in charge to fulfil Pr_1 , but at the same could affect the fulfilment of Pr_7 . Since the Ψ index on $Path_3$ is bigger on $Path_2$, that represents that the influence of th_A is bigger on the design, and the influence of the modifications will determine a harmful situations for Pr_7 .

That influence is understood by analysing the shared Characteristic on $Edge_a$, the modification of th_A , for assuring that Pr_1 meets the required criteria, reduces the possible values that H_C can take for meeting the required criteria of Pr_1 . Consequently, to reduce the interval where H_C can variate, will represent a negative effect on the definition of Pr_7 , because the possible combinations of their Characteristics are now reduced.

Finally, the analysis of Ψ' can be summarised on Table 4.7. In this table, two types of conclusions can be taken, depending if the collateral connection is whether useful or harmful. Also, it indicates which of the Characteristics dominates over the other on this collateral correlation. Lastly, in Section §4.3.3 it will be expanded those consequences of collateral correlations, targeting to measure the impact: understand how a modification of a Characteristic limits the range of manoeuvre that the other Characteristic has.

Table 4.7: Ψ' decision chart

Comparison 1	Comparison 2	Dominates	Effect
$\Psi_{Path_1} > \Psi_{Path_2}$	$\Psi_{Path_2} > \Psi_{Path_3}$	Ch_a	Useful
$\Psi_{Path_1} > \Psi_{Path_2}$	$\Psi_{Path_2} < \Psi_{Path_3}$	Ch_b	Harmful
$\Psi_{Path_1} < \Psi_{Path_2}$	$\Psi_{Path_2} > \Psi_{Path_3}$	Ch_a	Useful
$\Psi_{Path_1} < \Psi_{Path_2}$	$\Psi_{Path_2} < \Psi_{Path_3}$	Ch_b	Harmful

4.3. Evaluation of interaction among Properties

The traceability tree allows designers to visually understand the relationships between Properties and Characteristics, whether they are connected by Relations or not. These situations are quite common in product design process, but their analysis might get difficult. Figure 4.26 presents a connection between two independent variables, which are Pr_2 and Pr_3 . Figure 4.26a presents the traceability tree for Pr_2 (wider line) and Pr_3 . In this situation, both Properties

share Ch_5 , so one relationship between both can be established. The implication of this relation can determine that a modification on Ch_6 (part of Pr_3) has an implicit impact on Pr_2 , even if this Ch_6 does not make part of the relationship (Figure 4.26b). Understand the impact of this collateral relationships is one of the objectives of this thesis. Understanding this challenge helps to answer to the research question.

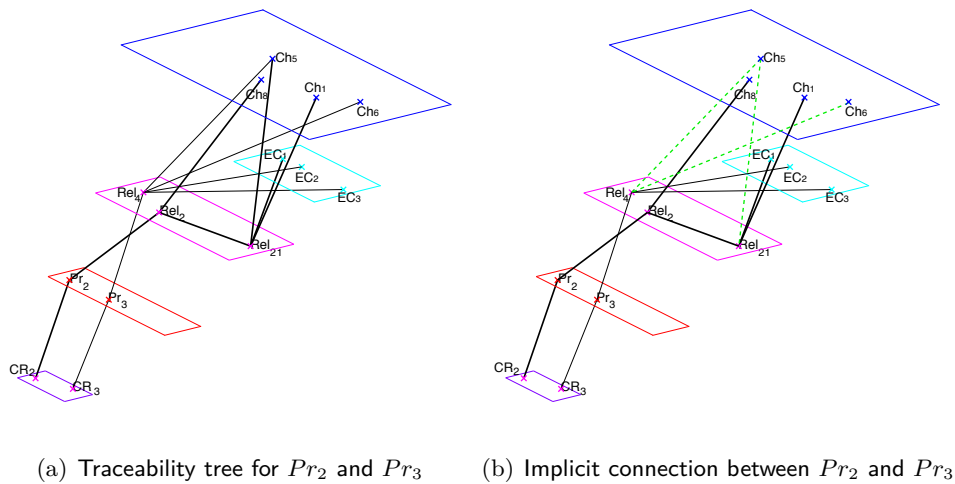

Figure 4.26: Collateral relationships between Properties

The strategy to understand these collateral relationships and anticipate the interaction among Properties is addressed in this chapter, in three parts: i) Frame for multi-property evaluation and definition of prioritisation of the Characteristics. ii) Determine if there are connections between any pair of Pr and Ch that are not directly connected through a Relation. iii) Interactive framework and evaluation of collateral connections among Characteristics.

4.3.1. Prioritisation of the Characteristics

Previous section (§4.2.3) explained how to measure collateral connections between Properties and Characteristic that do not share Relations. Likewise, it is important to understand the broad-view of the system interactions. Any Characteristic might be part of several Properties. Indeed, this is the essence of the impact of the collateral relationships. This subsection is centred in generating a prioritisation list of the Characteristics, regarding to its interaction with the design Properties.

A first hypothesis for understanding the influence of the Characteristics for making a prioritisation is to prioritise, based on the quantity of Characteristics that are being used. For example, if Ch_1 is part of three Properties, Ch_2 is part of four Properties, Ch_3 is part of one Property and Ch_4 is part of two Properties, the prioritisation list will be Ch_2 , Ch_1 , Ch_4 , Ch_3 .

The problem with the use of this hypothesis is that it ignores the correlation index calculated in the GSA (§4.2.2.1) that represents the influence of the Characteristic over the Property. In order to evaluate this influence, it is proposed to calculate another index that includes the results of the GSA for prioritising the Characteristics. The proposed index, noted with the Greek letter ζ , is the result of the sum of the absolute value of the ρ of the Characteristic, according to Properties it makes part of. This Index can be understood in Equation 4.18.

$$\zeta_i = \sum_{j=1}^{j_{max}} |\rho_{ch_i, Pr_j}| \quad (4.18)$$

Calculating ζ will determine a value for each Characteristic that indicates the overall influence that it generates on the overall design. Table 4.8 summarises the ρ values from the GSA of the cooler from the Appendix A. For exemplification purposes these values will be used for calculating the ζ values of the cooler design Characteristics.

Table 4.8: Global sensitivity analysis of portable cooler

	L_C	W_C	H_C	th_A	th_B	th_C	th_{lid}
Pr_1	-0.619	-0.7259	-0.938	0.2809	0.9393	0.2768	
Pr_2	0.9657			0.9768	0.958	0.9747	
Pr_3	-1			-1	-1	-1	
Pr_4		-1		-1	-1	-1	
Pr_5			-1	-1	-1	-1	-1
Pr_6	-0.8985	-0.9512	-0.9841	-0.989	-0.4845	-0.9835	
Pr_7	0.9511	0.9874	0.9905				
ζ	4.4343	3.6645	3.9126	5.2467	5.3818	5.235	1

Based on this results of the Table 4.8, the Characteristic with the highest index is th_B with $\zeta_{th_B} = 5.38$, and the lowest one is th_{lid} ⁸ with $\zeta_{th_{lid}} = 1$. It can be concluded that th_B is more critic for the design that th_{lid} and the other Characteristics. Therefore, a prioritisation can be established by sorting ζ from the bigger value to the lowest value.

Besides understanding which Characteristic is the one with more influence in the design, one of the applications that can be ruled out from ζ is to understand the complexity of solving a Property. To do so, it is proposed to define another index, called ξ . This index evaluates how "attached" is each Property; a Property with a lower value is less connected to the Characteristics set. This index computes for each Property its relationship with the ζ of its Characteristics. On Equation 4.19 is presented calculation of χ .

⁸Thickness of the lid

$$\chi_j = \sum_{i=1}^{i_{max}} |\rho_{ch_i, Pr_j}| * \zeta_i \quad (4.19)$$

For instance, in the cooler case, Pr_7 is connected to L_C , W_C and H_C . The calculation of χ_7 is given by:

$$\begin{aligned} \chi_7 &= |\rho_{L_C, Pr_7}| * \zeta_{L_C} + |\rho_{W_C, Pr_7}| * \zeta_{W_C} + |\rho_{H_C, Pr_7}| * \zeta_{H_C} \\ \chi_7 &= (0.9511) * 4.4343 + (0.9874) * 3.6645 + (0.9905) * 3.9126 \\ \chi_7 &= 11.7112 \end{aligned}$$

Following this procedure for calculating χ , the values for the rest of the Properties can be defined. The interpretation of this index is related to the complexity of the Property that is being solved. This complexity is related to the quantity and the influence of the Characteristic that compose the Property. Table 4.9 presents the χ values of the cooler design case.

Table 4.9: Complexity level of Properties χ of cooler design case

	χ
Pr_1	17.05288182
Pr_2	19.66549897
Pr_3	20.2978
Pr_4	19.528
Pr_5	20.7761
Pr_6	24.26537151
Pr_7	11.71122033

Some conclusions from Table 4.9 are that, Pr_7 is the Property with the fewer implications in order to be solved. Also, it can be seen that Pr_1 and Pr_6 are composed by six Characteristics, but their χ values are different. Appendix A are shown in detail the traceability trees of Pr_1 (Figure A.14) and Pr_6 (Figure A.13). In these Properties, it can be observed that, for example, the Characteristic th_C is used once in Pr_1 but it is used nine times in Pr_6 . The calculation of χ enables to understand these situations and for that reason it makes possible to determine higher values for more "attached" Properties.

4.3.2. Impact of modifying Characteristics

In order to empower the multi-criteria decision-making, it is intended to propose a framework to structure some information generated in early design, enabling to understand how a Characteristic

modification may impact on the Properties behaviour. As it was mentioned before, the desirability function of the Properties, is a strategy to introduce flexibility. In order to facilitate the decision-making process, this desirability is simplified into 5 intervals (See Table 4.10), offering a colour code: when the desirability is extremely high is green, good desirability yellow, medium desirability orange fair desirability red, and undesired values black.

Table 4.10: Intervals of desirability of Properties

Colour	μ	Meaning
Green	$1 > \mu > 0.8$	Values in this interval represent the appropriate value for the Property
Yellow	$0.8 > \mu > 0.6$	Not the best values, but still accepted
Orange	$0.6 > \mu > 0.4$	Not desired, but might get considered according to the situation
Red	$0.4 > \mu > 0$	Lowest preference of acceptance. Only if it is necessary
Black	$\mu = 0$	Values are outside desirability range

These visual intervals allow designers to easy take a decision, while visually seen if their modification if moving towards a green section or not. Figure 4.27 is shows the interactive proposal, where a design team can manually modify a Characteristic and be aware of how that modification may impact the design. In this Figure it is presented the real analysis of the cooler design case, where it is being evaluated how the modifications of th_A impact on the design Properties.

In order to properly use the framework, it is suggested to define the first values of the Characteristics as the nominal values of the distributions used in the Monte Carlo sampling. This first solution will be named the "**Preliminary Layout**". A guideline to use the framework is summarised as follows:

- (I) Select the Characteristic with the higher ζ value. This value represents the Characteristic with the highest impact on the design.
- (II) Modify the value in order to obtain a combination of better Properties's desirability.
- (III) From Figure 4.28, in the lower frame, the designer can choose a Property in order to access to the information. In the left part, it is shown the behaviour of the Characteristics, presented as the derivative. Understanding this behaviour is a key for designers in order to understand until which point a modification has more gain.

For instance, in the design of the portable cooler, the nominal value of the Characteristics and External Conditions enables to generate a first solution. On Table 4.11 can be observed the values

of desirability of the solution of the Preliminary Layout. With this values, it can be concluded that the solution does not meets the design specification, because $Pr_6=Total\ weight$ is outside the desirability ranges. By analysing the generated information related to GSA (see Table 4.8), the most sensible Characteristic for this Property is the th_A . In figure 4.27 it can observed the equaliser for this Characteristic.

Table 4.11: Desirability level of the solution with Preliminary layout

	Value	Desirability
$Pr_1=Internal\ temperature$	4.228 °C	$\mu = 1.0$
$Pr_2=Resistance$	8.124KPa	$\mu = 1.0$
$Pr_3=External\ length$	0.454m	$\mu = 0.999$
$Pr_4=External\ width$	0.421m	$\mu = 0.174$
$Pr_5=External\ height$	0.436m	$\mu = 0.747$
$Pr_6=Total\ weight$	18.475Kg	$\mu = 0$
$Pr_7=Internal\ volume$	37.984l	$\mu = 0.178$

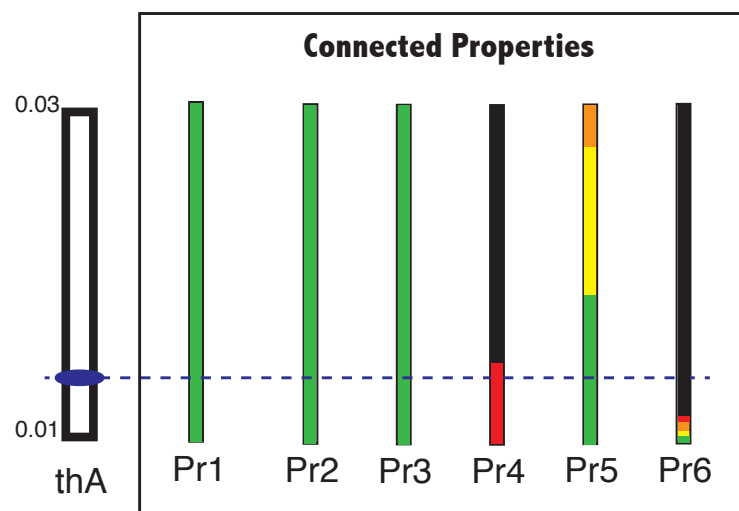
Figure 4.27: Equaliser for th_A

On Figure 4.27 it can be observed one of the challenges in design modification situations. In this particular case, it does not exist a value of th_A that makes $Pr_4=External\ width$ to be in green desirability. Nevertheless, modifying th_A to the minimum value, which is $th_A = 0.01m$ will enable a green desirability on 5 from 6 connected Properties. Also, another challenge can be appreciated, which is related to the $Pr_6=Total\ weight$, where a little modification can switch from green desirability to a null desirability. In Table 4.12 it can be observed the desirability level of the solution after the modification of the Characteristic to its minimum value.

Table 4.12: Desirability level of the solution after th_A modification

	Value	Desirability
Pr_1 =Internal temperature	4.361 °C	$\mu = 1.0$
Pr_2 =Resistance	8.952 KPa	$\mu = 1.0$
Pr_3 =External length	0.446m	$\mu = 1.0$
Pr_4 =External width	0.412m	$\mu = 0.283$
Pr_5 =External height	0.432m	$\mu = 0.801$
Pr_6 =Total weight	15.245 Kg	$\mu = 0.803$
Pr_7 =Internal volume	37.984l	$\mu = 0.178$

Finally, this exploratory process can be conducted with several Characteristics, in order to interactively modify values that allow to define a correct solution where all desirabilities are positive or closer to green intervals. A guide to understand until which level designers can modify a Characteristic, is explained in Section §4.2.2.3 by the calculation of the derivatives.

For example, in Figure 4.21a it is presented the function and the derivative, calculated between Pr_1 and th_B . Analysing this function, the bigger the value of th_B , the lower the value of the temperature (which is the desired objective). Nevertheless, by analysing the derivative it can be seen the progression of the slope, which is very high on the lower values of th_B (between 1 to 2 cm), but it tends to stagnate around 2.5cm. In terms of Pr_1 even if higher values are desired, the values between 2.5 to 3 cm are still good, but might generate undesired behaviours. In Figure 4.28 it is presented a model of an interactive interface where the equaliser and the calculations about the model (function and derivatives), as well as information about the early design, is merged (See Appendix B).

4.3.3. Evaluation of collateral connections among Characteristics

Previous section was centred in studying the impact on the Properties by the modification of the Characteristics in a multi-properties environment. Nevertheless, the modification of a Characteristics for fulfilling a Property, may have a hidden impact on how other Characteristics can be modified. These influences can be considered as a "collateral impact". For example, previous section explained how the output of the system was impacted by the modification of th_A . Nevertheless any modification of this Characteristic may impact the other Characteristics. It is the case of H_C , as it can be seen in Figure 4.29 where it can be observed the equaliser for the Characteristic H_C in three situations of th_A : where $th_A = min$, correspond to a th_A with values near to its lower bound. Equivalently to $th_A = mean$ and $th_A = max$.

In Figure 4.29 it can be observed the behaviour of these collateral impact. For example, for

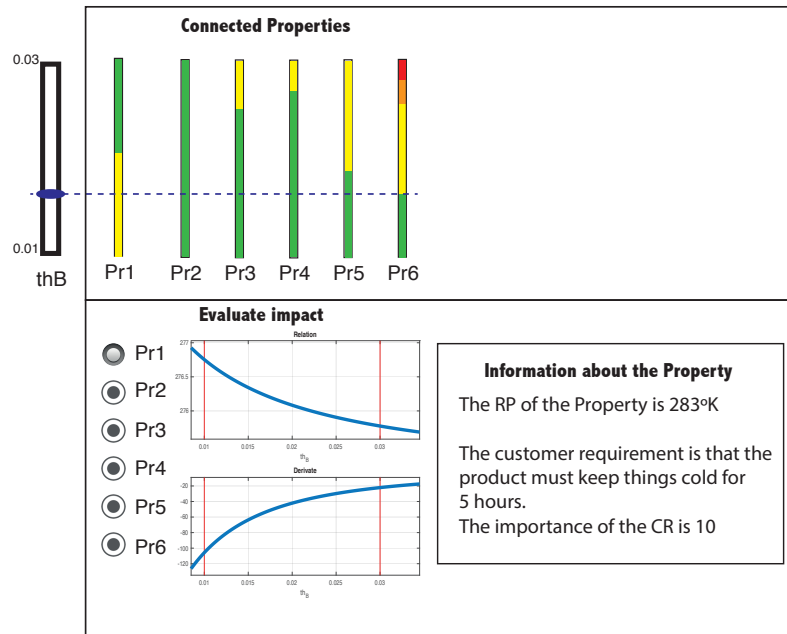

Figure 4.28: Interactive interface: Equaliser of th_B and its supporting information

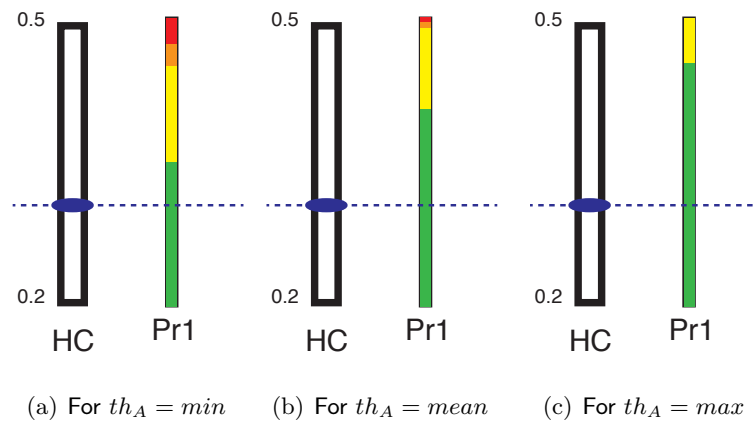

Figure 4.29: Equaliser of H_C for $Pr1$ according to the modifications of th_A

the cooler design case, even if H_C is not modified, the way it can be modified will depend on the variations of th_A modifications. In the Figure, three different situations are appreciated: i) Figure 4.29a, when th_A is close to its lower bound, there are positions of H_C that will determine a good desirability (lower values), while bad desirabilities of the Property are presented on higher values. ii) Figure 4.29b, when th_A is close to its mean value, the quantity of values that H_C generating good desirability is better higher the previous situation. iii) In Figure 4.29c, when the value of th_A is the close to its upper bound, it generates more possibilities to H_C to generate good desirability. It can be concluded, on the local analysis of these two Characteristics,

under the same Property that the lower the th_A value, the lower the chance of H_C to generate good desirabilities in the evaluated Property (Pr_1)

In this situation, the behaviour is positive and this understanding should facilitate the decision-making process. The validation is made by analysing the GSA of the design. In Table 4.8 the results for the cooler design case are listed.

The GSA is simple, in single-property situations. In the example for H_C and th_A for Pr_1 , the comparison of the ρ values, of both Characteristics, will determine that the influence of H_C is higher and opposite to th_A . This will result in a positive behaviour.

The problem in decision-making processes in design engineering is related to the multiple connections that happen. H_C makes part of four Properties, whereof shares three Properties with th_A and even in this situation a collateral relation can be identified (As it was shown in Section §4.2.3).

The interaction between these two Characteristics can be summarised as:

- On Pr_1 the modifications on th_A determine a positive impact on H_C .
- On Pr_5 and Pr_6 , the impact is negative, as the modification of th_A will reduce the range of possibilities of H_C to change. Regarding to the collateral connections, with Pr_7 the Ψ' index also indicates a harmful relationship between both Characteristics. Still, even if calculating these interactions among Characteristics is critic, the key is to understand how to handle this information in order to support decision-making processes in multi-criteria design.

Consequently, it is proposed to calculate intervals' variation of a Characteristic b after a Characteristic a is modified. The result will allow to validate which is the new available interval for the Characteristic b . For example, in Figure 4.29c, the values of H_C for generating a good desirability were between $[0.2, 0.47]$, but when th_A was minimum (Figure 4.29a) the values for good desirability were reduced to $[0.2, 0.35]$.

This calculation, that must be performed for the whole set of Properties, whereof the Characteristic makes part, is presented to the user as a visual tool. This visual tool that enables to understand the information generated by interactions among Characteristics. This visual tool needs an interactive interface to better support the multi-criteria decision-making approach, by allowing a fast understanding of the variation of the interval of the Characteristic.

Thereafter, in Figure 4.30 is presented an evolution from the equalisers from the Figure 4.29. In this new Figure is introduced a multi-Property evaluation. On the left is presented the

Characteristic intervals of variation. In this section, it is included a red bar, which is the results of the calculation of the interactions. This bar summarises the intervals where the Characteristic will produce a positive desirability.

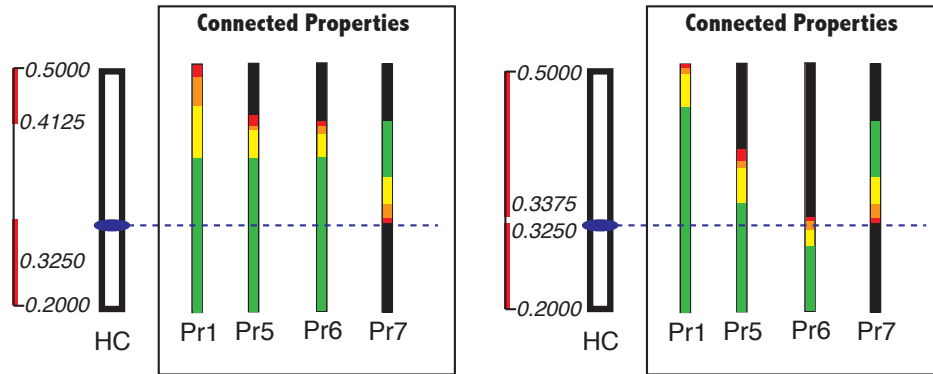
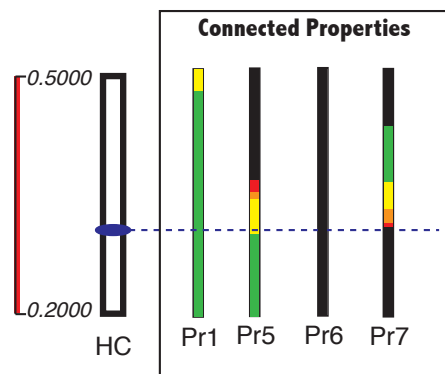
(a) Equaliser for $th_A = \min$ (b) Equaliser for $th_A = \text{mean}$ (c) Equaliser for $th_A = \max$ Figure 4.30: Equaliser of H_C with interval restriction by the variation of th_A

From Figure 4.30, it can be observed the equaliser with the interval modification for the whole set of Properties where H_C is present. From Figure 4.30, the following conclusions can be established:

- On the single-property analysis made for Pr_1 (Figure 4.29) it was found that the bigger the value of th_A , the easiest to define a value for H_C for a good desirability of Pr_1 . This argument was found to be false after the multi-property analysis was performed, together with the interpretation of the collateral correlation index Ψ' .
- The interval where H_C produces a solution, disappear when th_A is maximum. This was expected, because the harmful relationship was calculated for 2 shared Properties and the unconnected Property (3 from 4 Properties).

- The behaviour of the system, when th_A is used minimum or in the mean value, determines that H_C is highly conditioned. When mean values of th_A are used, nearly 80% of values of H_C can be used (See Figure 4.30b). When minimum values are used, 32% (See Figure 4.30a) of values of H_C can be used.
- Considering the behaviour of the system, the design should focus in defining the lower values for th_A in order to conserve a wider range of possibilities for H_C .

Consequently, given the high complexity and variability of the non-controlled manual modification when managing multiple behaviours as consequence of modifications of a Characteristics, it is necessary to define a better way to tackle the design problem. To do so, Chapter 5 presents a complement to the interactive exploratory method and will empower the use of the methodology. The proposed complement will focus in calculating a higher desirability for Properties.

Chapter conclusions

It was developed an information management framework that allows to manage the generated information in product design processes. That is to say, storing the information from Customer Requirements (linguistic variables) and Properties (variable criteria) up to Characteristics (independent variables). The proposed framework was not only able to store the information, but arranging the information in layers and connecting the items between layers, developing a traceability framework called "*traceability tree*". The fundamental objective of the traceability framework was to generate valuable information that will empower the decision-making process.

Regarding the decision-making process, it was also proposed an interactive framework that allows designers to modify the values of the Characteristics and informing in real time the impact of each modification in the performance of each of the design objectives. Likewise, in order to allow flexibility in the solution-finding process, the desirability concept for each of the Properties was included. This allow to compare different Properties, regardless of its physical magnitude.

Finally, with the implementation graph theory for define the connection between elements within the traceability tree and PRCC as a sensibility analysis technique, it was proposed a guide to understand how the interaction among Characteristics and Properties happen. The result was the generation of three indices that summarise the interaction: i) ψ index for understanding collateral relations ii) ζ index for understanding global interactions between Properties and its Characteristics iii) χ index for understanding how attached are the Properties.

The usage of interactive framework supported by the interpretation of these three indices

empower the designers in the decision-making process in order to modify Characteristics for improving the performance of the solution. Nevertheless, the pitfall of the method is related with the initial solution, which in this case, is calculated with the results of the Monte Carlo simulation.

In Figure 4.31 the methodology of the thesis can be watched, where the information contained in the traceability framework and the sensibility analysis is used in the interactive framework. The input is the initial solution, called *Preliminary Layout*, which represents a solution where the values of the Characteristics produce a Properties' desirability level that is not necessarily the best value. Moreover, the modification process can be exhausting and produce reprocessing. For that reason it is necessary to develop a method for supporting the interactive framework by calculating a better combination of values of the Characteristics.

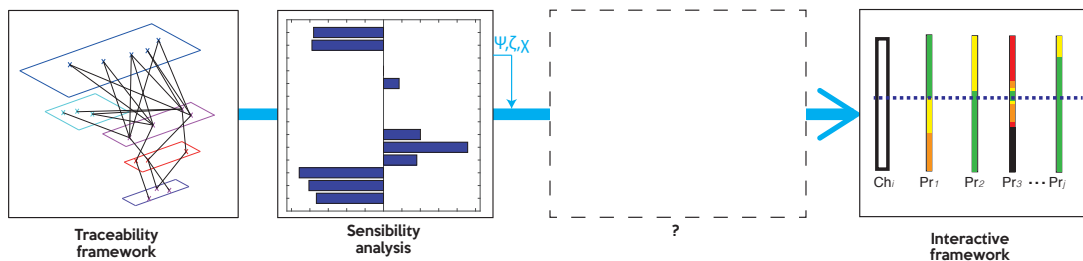

Figure 4.31: Interactive design methodology

Chapter 5 contains the proposed method for modifying the *Preliminary Layout* for generating a solution that has a better desirability level for the Properties.

Amelioration of the global desirability of design objectives

The previous chapter proposed an exploratory interactive method for early design stages. This method allow designers to understand relations among Properties and Characteristic, as well as how the modification of a Characteristic affects the behaviour of the solution. Nevertheless, the use of this method for assigning definitive values of the Characteristics is limited by the complexity of the design, where the bigger the amount of Properties and Characteristics, the harder to manually find solutions. Therefore, it is proposed a complement to the interactive method, centred in determining the best combination of values of the Characteristics. This complement introduces a modification on the design methodology already explained in Chapter 4 (Figure 4.6). The complement introduced in this chapter is based on the execution of new supporting tasks, that are shown as purple rounded rectangles in Figure 5.1.

The proposal of maximising the global desirability of design objectives is centred in defining a pre-sizing method, that can be tuned with the exploratory interactive method. The objective of this method is to assigning values of the Characteristics in order to ameliorate the global desirability of the Properties. Also, empowering decision-making in complex design situations, such as dealing with non-convexities.

The pre-sizing routine is understood as an *interactive inductive* method for finding values for the Characteristics, complementing the *exploratory interactive method*. The use of both approaches is centred on the refinement of the solution.

The main difference between the usage of the exploratory interactive method (Chapter 4) is

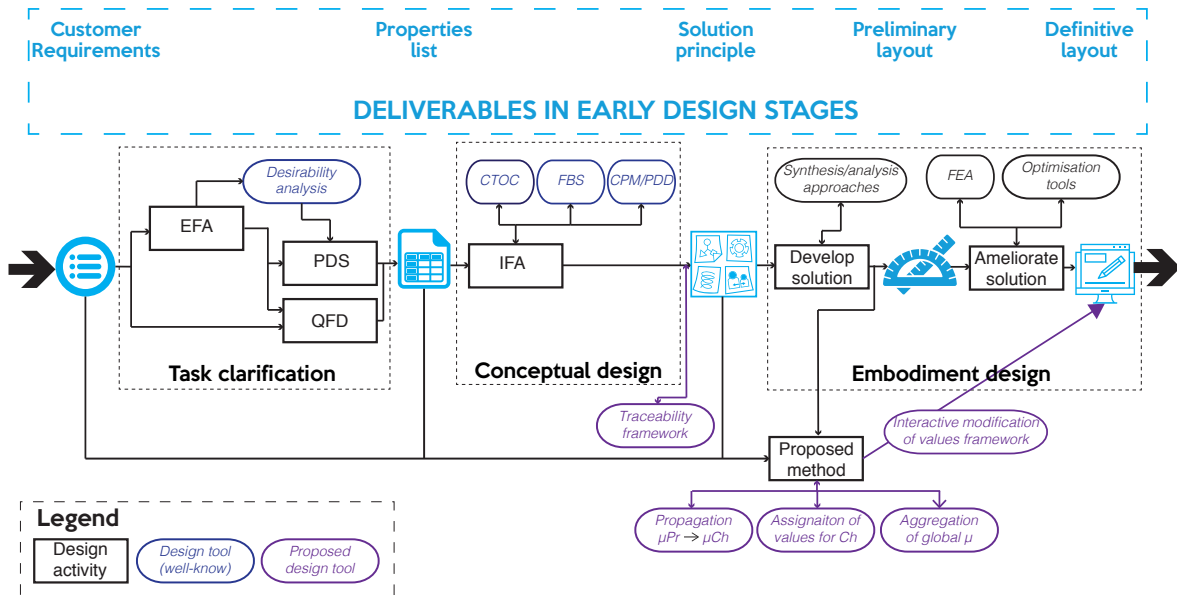

Figure 5.1: Design methodology proposal

based on the nature of the values of the Characteristics. Replacing the values defined by the user with values calculated for maximising the desirability, offers designers a better model for refining the solution.

The new activities in the design methodology for pre-sizing method allow to reduce to the level of uncertainty related to the modification of the Characteristics, and how a modification affects different Properties and reduces the range in which other Characteristics can vary: On §4.3.1 and §4.3.2 it was shown how modifying the value of a Characteristic impacts the full set of Characteristics and Properties.

As it was stated before, the definition of the values of the Characteristics is assigned by its preliminary layout. This layout is based on the nominal values of the distribution of each Characteristic. The solution generated by the use of the preliminary layout, will be understood as the first solution of the problem. This combination of values will be named as **Design Characteristic Space (DCS)** and is defined as:

Given:

$$\{Ch_1, Ch_2, \dots, Ch_i\}, \text{ set of } i \text{ Characteristics of the design with a defined value.}$$

Then exist:

$\{\mu(Pr_1), \mu(Pr_2), \dots, \mu(Pr_j)\} \in \mathbb{R}$, set of the desirabilities of j Properties, calculated with the defined values of the Characteristics.

The calculation of the desirability functions $\mu_{(Pr_j)}$ of each Property opens the possibility to define a global desirability, of each solution, that can be associated to each Design Characteristic Space. The calculation of several *DSCs* will allow to make a comparison among solutions, based on their global desirability. This comparison is a problem broadly addressed in the literature of Multi-Criteria Decision-Making (MCDM) processes. In these processes, it is allowed to focus the problem into a solution that meets the expected criteria, so, it will allow to compare the global desirability of the solutions. In MCDM, different strategies can be found in literature for the evaluating a given number of alternatives. For example, Triantaphyllou (2000) presents comparative study in MCDM methods. Some of the most used techniques are (Triantaphyllou, 2000):

- WSM (Weighted Sum Model) is one of the most used approaches, especially in single dimension problems. In this method, ruled by the additive utility assumption, determines that the best solution is the solution with the highest value of the sum. The use of WSM is easy, but it cannot be used on multi-dimensional problems. The use of different dimensions and units, violates the additive utility assumption and determines the non-use of the method.
- WPM (Weighted Product Model) calculates a ratio between two solutions, determining which solution is the most desired. It is calculated by dividing the values of the j Property of two solutions and multiplying this values. This method allows to have a dimensionless analysis, which empowers multi-disciplinary problems analysis.
- AHP (Analytic Hierarchy Process) decomposes a complex problem into a system of hierarchies represented in a matrix with the relative importance of the alternatives. AHP makes comparisons by eliciting numerical evaluations from experts and decision makers.
- ELECTRE (*ELimination Et Choix Traduisant la REalité*, in French or elimination and choice translating reality) is centred in dealing with the outranking relation by the use of pairwise comparisons among alternatives and the use of its criteria separately. This method is often use for choosing, ranking and sorting solutions. Many variants of this method have been proposed on literature, being TOPSIS (Technique for Order Preference by Similarity to Ideal Solution) one of the most used.

These MCDM strategies are used for many purposes, such as amelioration and optimisation techniques in different knowledge areas. Due to the fact that defining an exact description of real

life physical situations is virtually impossible (due to the high degree of imprecision involved in real (Triantaphyllou, 2000)), it defines a challenge on the definition of a MCDM model in design situations.

Otto and Antonsson (1993) prepared a comparison among the two most used MCDM evaluation approaches: utility theory and the method of imprecision. Both of these methods represent the uncertainty attached to decision-making processes with 0 to 1 ranking (Otto and Antonsson, 1993). Understanding that this type of fuzzy sets theory can be used for representing real life problems in decision-making (Bellman and Zadeh, 1970) characterises the importance of this type of models.

The difference between utility theory and the method of imprecision, relies in the use of additive metrics. The utility theory (UT), originally developed for economics, but with applications on engineering (Hazelrigg, 1998; Antonsson and Otto, 1995), is an analytical method based on taking a decision given a set of multiple criteria (Morgenstern and Von Neumann, 1953). Utility theory proposes a set of axioms for restricting the way a designer makes preferential judgements among design options (Otto and Antonsson, 1993).

In the method of imprecision (Mol), developed for negotiate a design problem, as desired by a designer, the desired performance of the solution can be directly stated by the performance criteria of the components (Otto and Antonsson, 1991). This method proposes a core set of axiomatic restrictions for governing the preferential judgements of a designer over design options (Otto and Antonsson, 1993).

Then, depending if UT or Mol constraints are believed true, then a designer must use these constraints when making decision. The additional constraints of Mol imply particular combination metrics and also the possibility to consider iterative design (Otto and Antonsson, 1993). Finally, it is necessary to declare that the evaluation on UT is given by additive metrics, precluding the evaluation for different units in design objectives.

Consequently, Mol is a method for negotiating among design objectives, especially when imprecision is present. In Mol the term imprecision is related to epistemic uncertainty in choosing among several alternatives (Antonsson and Otto, 1995). An example of this imprecision was explained in Chapter 4 with the introduction of the *flexibility concept* in the Properties evaluation (e.g. the criteria of guaranteeing a temperature of 10°C or a volume between 35 and 50 litres).

Since a design solution is judged, on the basis of more than one preference, the Mol allows to calculate an explicit aggregation of all preferences to compare and combine different aspects of performance (Scott, 1999). These combinations of preferences are combined with an aggregation

function $F(P)$ which, in this thesis, will be defined as the function of desirability $F(\mu_{sln})$.

Consequently, and connecting MoI with decision-making in design, Quirante (2012) proposes a model for decision support on robust design where the use of aggregation techniques plays a main role in the evaluation of potential solutions. In this work, it is important to recall the design criteria's satisfaction level interpretation. This is summarised in two indices: Design Objective Indexes and Global Desirability Index:

- Desirability Objective Index (DOI) (Sebastian et al., 2010) measures the ability of a solution to satisfy one particular Property. DOI is expressed as a desirability level μ_{Pr_j}
- Global Desirability Index (GDI) (Quirante et al., 2010), is introduced as the result of the DOIs aggregation. The GDI measure the ability of a solution to meet design specifications.

Different approaches have been used for calculating the GDI in design processes. Collignan (2012) evaluates and compares different types of aggregations: weighted sum, product, minimum, continue (Collignan, 2012):

- Weighted sum aggregation: is one of the most used aggregation techniques. The GDI is calculated by the sum of the multiplication of each DOI with a weighted weight.
- Weighted product aggregation: this multiplicative aggregation is one of the most used strategies that are linked to the use of the Harrington membership functions (Derringer, 1994). Here the GDI is calculated by the multiplication of the whole set of DOI.
- Aggregation by the minimum: Proposed by Kim and Lin (2000) the aggregation is made by the selection of the minimum DOI. This selection will determine the GDI. This aggregation technique is considered as one of the most conservatives approaches in design (Kim and Lin, 2000).
- Combined aggregation techniques: Proposed by Yager (2004) as the name of Ordered Weighted Averaging (OWA). It allows to unify into the same evaluation function, different arithmetic means with the membership functions (Yager, 2004). Some of the means included among the OWA are the harmonic mean, geometric mean, arithmetic mean and quadratic mean.

Based on this, Collignan (2012) compares their implementation regarding their appropriateness level in design. The techniques are divided in two, "*design appropriate*" and "*super compensative*". Among design appropriate techniques it can be found techniques as *aggregation by the minimum*,

harmonic mean aggregation, which can be noted as the most conservative techniques. Regarding super compensative techniques, it can be found *arithmetic mean aggregation*, *weighted product sum* and *quadratic mean aggregation*. Also, there are more compensatory techniques that can be located in the middle of both: *geometric mean aggregation* and *weighted product aggregation*. These techniques are summarised in Figure 5.2.

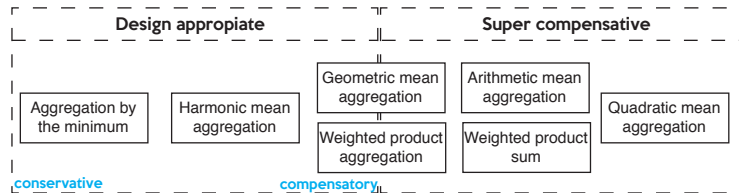

Figure 5.2: Aggregation techniques comparison. Adapted from (Collignan, 2012)

Regarding to the use of these aggregation techniques, for decision-making in design, it is necessary to recall some remarks. The problem with weighted product sum, even if it is the most used aggregation technique, its use for selecting a solution in design is limited. This happens because the way GDI is calculated, in this approach, DOI equal to zero can be permitted and might not affect the final aggregated value. On the other hand, product aggregation considers the whole DOI values and if a zero value is present, the GDI will be zero. Besides, lower values of DOI will dramatically decrease the GDI final value, so this method centres its aggregation in having DOI values in higher levels. The arithmetic mean of OWA allows to evaluate in different scenarios. For instance, the harmonic mean will return a most conservative GDI than the weighted product aggregation, and the quadratic mean a most compensated value. Finally, the aggregation by the minimum, might be considered too conservative for MCDM and too limited for improving a design.

This chapter will focus in a pre-sizing method centred in maximising the aggregated desirability of the Properties. This aggregated desirability is based in the evaluation of the GDI in a compensatory level. The goal of the pre-sizing method is to calculate an Ameliorated Layout, defined as:

$$\{Ch_1, Ch_2, \dots, Ch_i\} \mid \max_{Ch_i \in \mathbb{R}} f(\mu_{sln})$$

The definition of an ameliorated layout, constrains the process to establish a mechanism where the set of desirabilities, for each Property, is evaluated as a whole. That is to say, the definition of a GDI function that responds to the different $\mu_{Pr_j}: F(\mu_{sln})$. Likewise, it is necessary to develop

a method to compare different solutions. This ameliorated layout is a *DCS* with a higher global desirability than the preliminary layout, such that:

$$\mu(DCS_{final}) \gg \mu(DCS_0)$$

Finally, the use of this pre-sizing method may be triggered by different type of design situations, either convex or non-convex situations. This will be addressed in this Chapter, which structure is divided in: i) Description of the pre-sizing method. ii) Use of the method in convex situations iii) Use of the method in non-convex situations and non-convex situations: when to do analysis or synthesis?. According to the input and output of the method, this information can be summarised as:

<p>Input for the method:</p> <ul style="list-style-type: none"> -Preliminary layout: initial values of Characteristics -Desirability μ for every Property -Prioritisation of Characteristics by their influence -Ψ index: normalised shortest path weigh of connections $Pr - Ch$
<p>Output:</p> <ul style="list-style-type: none"> -Ameliorated layout: new values of Characteristics

5.1. Pre-sizing method for maximising global desirability of the solution

In order to generate a solution where the Global Desirability Index is optimal, it is presented an iterative method centred in the generation, evolution and evaluation of design solutions. This section presents such a pre-sizing method, which will be proposed for this thesis. It will be called SSNV, for the acronym *Structured Stepped Nominal Value*. The name of the method is given due to the nature of the method it self:

- *Structured Stepped*: the iterative step of the method is not defined by random parameters, but is structured given the information from the traceability tree. The structured step is defined by the prioritisation list of the Characteristics (Section §4.3.1), which is a descending order sorting the influence of the Characteristics with the design. This list is one of the inputs for the method.

- *Nominal Value*: the starting point of the method (DCS_0) is defined by the preliminary layout. This layout is defined from the Monte Carlo sampling (Section §4.2.1) for each Characteristic, where it is proposed to use the nominal value as the starting point for the iteration sequence.

Still, in order for the method to reach a proper solution, it is necessary to consider the desirability function $\mu_{(Pr_j)}$ of each Property. Together with the definition of the DCS . In Figure 5.3 it is presented the diagram of how the method works. On the following subsections the procedure for the implementation of the method will be explained in detail.

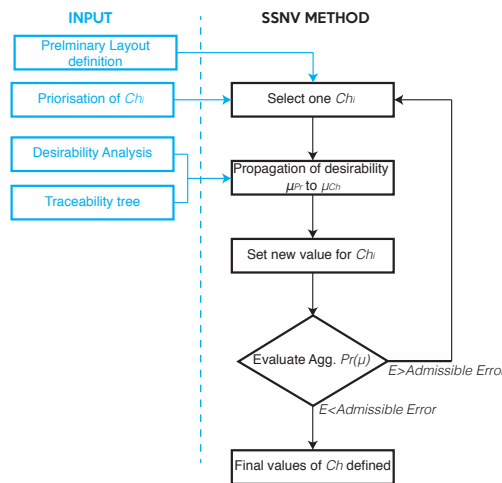

Figure 5.3: SSNV process diagram

Therefore, the proposed method intends to obtain a DCS where the desirability of the solution can be maximised. The desirability concept is proposed to be used as a target because its importance in negotiation situations in design, especially because of their capacity for enabling flexibility. The introduction of desirability functions at Properties level was established by Harrington (1965), allowing to introduce complexity reduction in MCDM processes (Harrington, 1965) and allowing a better manipulation of uncertainty in design by using fuzzy sets (Antonsson and Otto, 1995).

Nevertheless, the approach to define flexibility is intended to be performed at Properties level, but the influence on the design can be identified by modifying Characteristics. This situation leads to define a mechanism to translate the desirability $\mu_{(Pr_j)}$ from Properties' layer to the Characteristics' layer. To do so, it is intended to define a process to translate desirability from Properties to Characteristics.

Translating information among different layers of variables and objectives in design, is a critic

task that has been addressed by several authors in the literature. Four different aspects were found that need to be considered on these processes: i) Direct connections ii) Indirect connections (collateral connections) iii) Component connectivity iv) Propagation paths (Keller et al., 2005). The first three aspects are similar regardless, the application, however the propagation task depends on how the application is performed and what it is expected.

Some other applications, outside the design engineering domain, were found for the translation, which plays important roles, specially on informatics. For example, triple graph grammars is an approach for bidirectional model transformations¹. Ehrig et al. (2013) propose a model for the transformation of the information between business and IT models. This model is based on the definition of strong functional behaviour in order to define consistent constraints into the model transformation network. The propagation is made by the connections established in a directed graph (Ehrig et al., 2013). In this study, the use of graphs allowed its application on bidirectional model transformations, integration and synchronisations, providing techniques for the verification and validation of the translation of the information among different layers.

Another application of information translation was found in supply chain problems, where several multi-agent approaches, based on CS, had been proposed. Sitek et al. (2014) propose a constraint propagation model that explicitly blocks values of some variables of a problem, because their subset of constraints cannot be satisfied. This allowed a reduction of the combinatorial problem. The work proposes a hybrid method that use constraint logic programming and mathematical programming, in order to solve optimisation problems that are intractable by the use of the two methods alone (Sitek et al., 2014). This method is recommended not only for supply chain but also for several MCDM and optimisation problems.

In the design engineering domain, two different types of applications of translations between different layers can be considered: Characteristics to Properties and Properties to Characteristics. Among the first one, change management is one of the most used applications. In this process, it is evaluated the propagation from Characteristics, to other Characteristics and Properties based on the use Design Structure Matrices (DSM). The mechanism is centred on propagation networks that are built using representation matrices for visualising connectivity data (Keller et al., 2005).

Based on DSM, Change Propagation Models are used for controlling how a modification on a Characteristic propagates and affects Properties. The Change Propagation Models are based on Propagation trees, allowing to consider direct and indirect connections (Clarkson et al., 2004).

¹The relationship between Properties-Characteristics can be considered as bidirectional model transformations too.

The results of the Change Propagation Model determine that the model allows to track how a modification impacts the design.

In terms of supporting a whole design process, Fischer et al. (2002) propose an Inverted Integrated Design methodology for the pre-sizing of mechanical structures. This methodology is focused in the translation of design problems for capitalising the knowledge of the experts, related to the interpretation of the physics of the problem. This is made by the definition of an objective function (based on fuzzy logic) that is able to measure the level of acceptance of solutions. Those solutions were generated by the use of CSP, where each solution must meet the design objectives, where optimisation does not intend to minimise the objective function, but to affect the degree of fuzzy acceptability (Fischer et al., 2002).

This methodology allows to translate the information from Properties to Characteristics, in order to define solutions using CSP. The methodology results in the reduction of iterative loops, by reducing trial-and-error phases and consequently, reducing time. The Inverted Integrated Design allow to define solutions, where Characteristics inherit constraints of the Properties (Fischer et al., 2002).

Some other applications using CSP in design of CSP, such as the one from Tchertchian et al. (2013), who had included CSP to support the calculation of intervals of the Characteristics, to meet design objectives. The used propagation technique was based on the principle of inference, allowing to translate the information contained in a constraint to neighbouring constraints. Those inferences allow to filter domains, developing great flexibility for expressing knowledge and modifying models (Tchertchian et al., 2013).

Recapitulating, many translation techniques of information between layers are related to propagation techniques, which makes it suitable for the task of translating the critical information from Properties to Characteristics (Tchertchian et al., 2013; Fischer et al., 2002; Sitek et al., 2014; Ehrig et al., 2013). Those structures allowed to define a model where the requirements of the problem are inherited through variables, allowing to define a solution that meets design objectives.

The case of DSM is focused in the propagation of $Ch \rightarrow Pr$ based on trees (Clarkson et al., 2004). As described in Chapter 4, the information generated allow to build the traceability graph, where relations between Properties and Characteristics are identifiable (See Section §4.2.3). Based on the reciprocity principle of the traceability graph, it is proposed a propagation technique that will synthesise the information of the CPM/PDD in order to interpret the desirability up to the Characteristic layer: a propagation model $Pr \rightarrow Ch$, based on the traceability graph.

Thus, with the definition of a desirability function for the Characteristics, directions can be directly taken from the FA and the PDS. For example, Jeong and Kim (2009) had proposed a model for tightening and relaxation of desirability functions, in order to facilitate the preference articulation process (Jeong and Kim, 2009). Köksalan and Plante (2003) proposed a method for interactive multi-criteria optimisation, that was centred into the maximisation of the utility function, which was being evaluated in an iterative routine (Köksalan and Plante, 2003).

Also, several approaches of optimisation are also focused on the treatment of desirability functions. For instance, on Multi-Response surface Optimisation (MRO), the problem can be tackled as a multi-criteria optimisation, by optimising the behaviour of the desirability functions. Park and Kim (2005) proposed to re-write desirability functions as an optimisation problem, for later feasible region analysis. Lee et al. (2011) define their MRO model based on the optimisation of the utility function, having as novelty, the definition of weighting indexes for the trade-off among design objectives (Lee et al., 2011).

Finally, the proposed desirability model maximisation to be used in this thesis is explained in detail in the following subsections. In Section §5.1.1 the propagation model is proposed, where the desirability information is translated from Properties to Characteristics. In Section §5.1.2 is described the definition of the Desirability function for Characteristic $\mu_{(Ch_i)}$ and in Section §5.1.3 is defined the evaluation mechanism of the method.

5.1.1. Propagation of desirability to Characteristics layer

Based on the analysis of the Customer Requirements (compiled in the PDS), the design team can define a set of desirability functions μ for each property. The variation of these functions is determined by the variation of the Characteristics, so, it can be defined that:

$$\mu(Pr_j) = Fn(Ch_1, Ch_2, \dots, Ch_i) \quad (5.1)$$

Likewise, a Characteristic can make part of several Properties (See Figure 5.4), triggering the propagation analysis to take care of different relationships. To solve this issue, the use of CPM/PDD allows to manage those relations, enabling designers to perform a better analysis in decision-making situations.

Therefore, the first part of the analysis is centred in being aware of which Characteristics make part of each Property. Typically, this information is already contained in the traceability graph, generated by the implementation of the CPM/PDD methodology. For a given *DCS*, it can be calculated the corresponding value of μ of the Property. Considering Pr_1 as a function

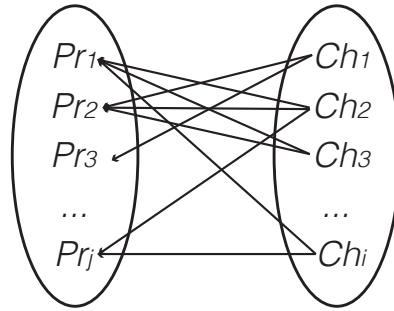

Figure 5.4: Properties and Characteristics

of Ch_1, Ch_2, Ch_3 (Equation 5.2), Pr_2 as a function of Ch_1, Ch_2 (Equation 5.3), the desirability functions depicted in Figure 5.5, can be established. The values that those Characteristic can take, are shown in Table 5.1.

$$Pr_1 = \frac{Ch_1 * Ch_2^2}{Ch_3} \tag{5.2}$$

$$Pr_2 = Ch_1^{Ch_2} \tag{5.3}$$

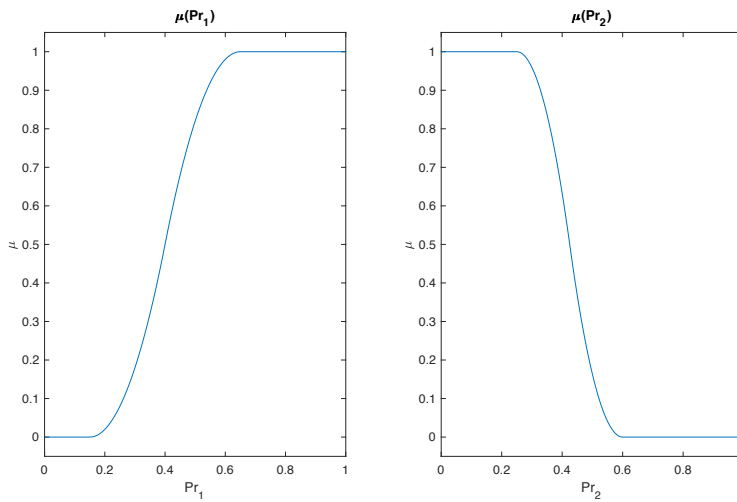

Figure 5.5: Desirability function for Pr_1 and Pr_2

Table 5.1: Propagation example: Values of Characteristics

Characteristic	Range	Nominal value
Ch_1	[0, 0.5]	0.19
Ch_2	[0.5, 1]	0.9
Ch_3	[0.5, 1]	0.75

With the information of the Characteristic, the first DCS can be calculated. This will be DCS_0 , which is related to the preliminary layout. For the Property 1 (Pr_1), the calculation of its value is given as:

$$Pr_1 = Fn(Ch_1, Ch_2, Ch_3)$$

$$Pr_1 = \frac{0.19 * 0.9^2}{0.75}$$

$$Pr_1 = 0.1710$$

And the evaluation of desirability function of Pr_1 for the DCS_1 (See Figure 5.5) is:

$$\mu_{(Pr_1)} = 0.0035$$

Following the same procedure, the value of Pr_2 can be calculated and its desirability evaluated from Figure 5.5, resulting in values of $Pr_2 = 0.2243$ and $\mu_{(Pr_2)} = 1$.

The challenge of propagating the information of desirability must be tackled progressively. As a result, the following steps are proposed, in order to evaluate the behaviour of the desirability function of a Property, while Characteristics are changing:

- (I) Select a Characteristic
- (II) Fix the Characteristics that complement that Property
- (III) Identify the variation values of the Characteristic
- (IV) Evaluate the desirability function by modifying of the selected Characteristic

The new function can be interpreted as the desirability of the Property given the variation of the Characteristic (Equation 5.4). The behaviour of these functions depends on the values of each DCS . This functions will be defined as as Dynamic Desirability Functions (DDF), because their behaviour vary for each solution.

$$\mu_{(Pr_j)/Ch_i} \tag{5.4}$$

This function represents how the desirability of the Property varies according the dynamic modification of the values of the Characteristics. Even if the desirability function is still related to the Property, the range of the function is now constrained to the range where the Characteristic can vary. In Figure 5.6 the graphic representation of the desirability functions is shown.

A quick analysis of Figure 5.6 allows to interpret the behaviour of Characteristics. For example, for Ch_1 there is no possible manner to achieve a $\mu = 1$ for Pr_1 ; also, for Ch_3 , almost any

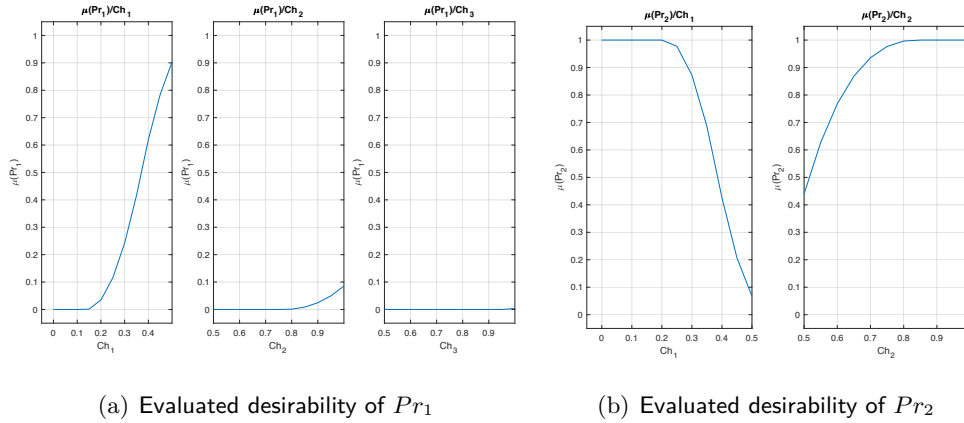

Figure 5.6: Evaluated desirabilities of Properties by the variation of their Characteristics

combination of values will not allow a $\mu > 0$, only values bigger than 0.95. Likewise, for Pr_1 , the bigger Ch_1 the better, but for Pr_2 the behaviour is completely different. This kind of situations evidenced the need of a characterisation method of desirability functions for the Characteristics.

5.1.2. Definition of desirability function of Characteristics

Based on the different DDF $\mu(Pr_j)/Ch_i$, it is necessary to synthesise their information into a single function that represents the desirability of the Characteristic: $\mu(Ch_i)$.

The definition of this new function is based on the aggregation of the desirability functions of the Properties by the modification of the Characteristics (DDF, Equation 5.4). Since the different Properties represent a MCDM problem, it can be considered as a multi-criteria aggregation. The calculation of these desirability functions of the Characteristics, is based on the analysis of the interactions Properties-Characteristics, represented as $\mu(Pr_j)/Ch_i$.

The study of the interactions Properties-Characteristics was addressed in Section §4.2.3, where those interactions were synthesised in the traceability graph. It is important to notice that in the traceability graph, the vertices are weighted according the results of the LSA. One example of a graph can be observed in Figure 5.7.

These kind of diagrams are key to understand the relations among Properties with Characteristics. The use of the proposed traceability framework allows to identify interactions among elements of the graph. In terms of interactions Properties-Characteristics, is proposed to calculate the Ψ index, which indicates the stronger connection between a Property and its Characteristics (See Equation 4.15). Therefore, based in Figure 5.7, the Ψ indexes were calculated as:

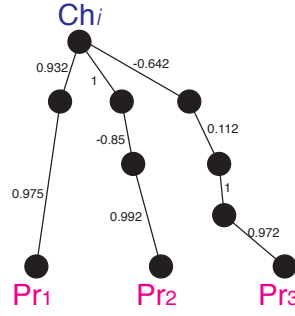

Figure 5.7: Extract of a graph connecting a Characteristic with Properties

$$\Psi_{Pr_1/Ch_i} = 0.9535$$

$$\Psi_{Pr_2/Ch_i} = 0.9474$$

$$\Psi_{Pr_3/Ch_i} = 0.6815$$

Hence, the analysis is divided in two elements: i) the local interaction between the Property and the Characteristic, measured by Ψ_{Pr_j/Ch_i} ii) the interaction between the desirability of the Property (subject to the modifications of the Characteristic) and the influence of the values of the complementing Characteristics $\mu_{(Pr_j)/Ch_i}$. The calculation of the desirability function for the Characteristic will be a function of these two elements, as follows:

$$\mu(Ch_i) = Fn \left(\Psi_{Pr_j/Ch_i}, \mu_{(Pr_j)/Ch_i} \right) \quad (5.5)$$

Likewise, the multi-criteria aggregation can be addressed under two different principles: concordance and discordance. On one hand, concordance is implemented when in the aggregation process is a trend to respect higher Properties' desirability values. On the other hand, discordance is focused in respecting lower values (penalising lower Properties' desirability values), privileging balanced actions in order to allow a response that does not focus on small advantages. According to this, the proposed method can be categorised as a discordance method. This reasoning is based on avoiding intervals where null desirability is obtained. See Equation 5.6 where the $\mu(Ch_i)$ is presented.

$$\mu(Ch_i) = \prod_{j=1}^j \Psi_{Pr_j/Ch_i} * \left(\mu_{(Pr_j)/Ch_i} \right) \quad (5.6)$$

The $\mu(Ch_i)$ is calculated as the product between the Ψ_{Pr_j/Ch_i} index and the $\mu_{(Pr_j)/Ch_i}$. The first part acts a weight in the aggregation process. Strong Properties-Characteristics relationships (Ψ close to 1) will strongly impact the aggregation. For example, for the graph from Figure 5.7,

the desirability by Pr_1 will be graded higher than the desirability by Pr_3 because of Ψ value.

Regarding $\mu_{(Pr_j)/Ch_i}$ (calculated in Section §5.1.2) represents the behaviour of the desirability of the Property according the modification of the Characteristics. This part of the function contains the intervals of null desirability and those where $\mu > 0$.

For example, for the functions in Figure 5.6, considering those affected by Ch_1 variations, the multiplication of the functions $\mu_{(Pr_1)/Ch_1}$ and $\mu_{(Pr_2)/Ch_1}$, including their weight (Ψ), will determine the resulting desirability function of the Characteristic. Figure 5.8 shows the desirability of this Characteristic.

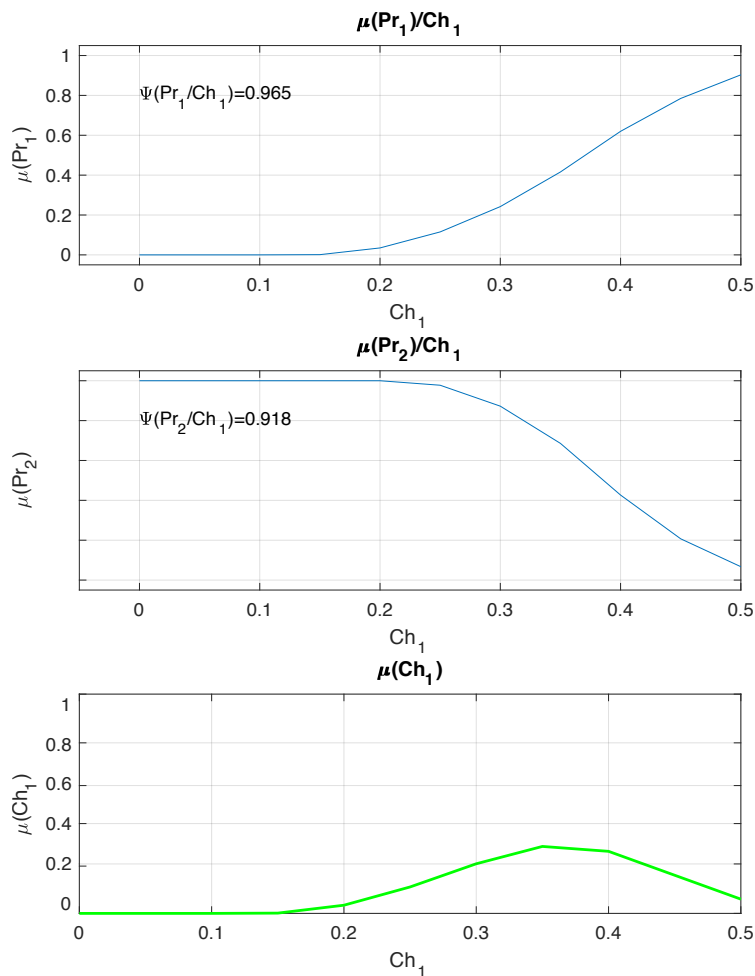

Figure 5.8: Propagated desirability function for Ch_1

Figure 5.8 presents the two $\mu_{(Pr_j)/Ch_i}$ and the bottom graph presents the aggregated function that represents the $\mu(Ch_i)$. This new function is the product of both $\mu_{(Pr_j)/Ch_i}$, weighted by their each Ψ_{Pr_j/Ch_i} . A particularity of this aggregation is that the intervals with null desirability, in any of the DFF, are penalised. This is the expected behaviour of the discordance model.

Finally, the resulting desirability of the Characteristics $\mu(Ch_i)$, is a function where the information from Properties' is translated to the Characteristics, thanks to an aggregation model process.

5.1.3. Definition of an evaluation mechanism

The desirability propagation from Properties to the Characteristic offers an integrated desirability with the form $\mu(Ch_i)$, that implicitly contains the joint desirability from Properties. This helps in decision-making by impacting in a positive manner the design output. Figure 5.8 shows the intervals where values of Ch_1 will produce a null desirability $[0, 0.15]$ and values where the Characteristic will generate a better desirability level. Therefore, the evaluation of the behaviour function determines which value of the Characteristic defines the best value for the design. Consequently, a new value is assigned to the Characteristic, based on the selection of the maximum value in the propagated desirability function (See 5.7):

$$Ch_i.new = max(\mu(Ch_i)) \quad (5.7)$$

$$Ch_i.new = max\left(\prod\left(\Psi_{Pr_j/Ch_i} * \left(\mu(Pr_j)/Ch_i\right)\right)\right)$$

Based on the new value, it is guaranteed that it will impact in a positive way the desirability of the Properties. This new value allows to define a new *DCS*, enabling to perform several evaluations: the first one, is to calculate the new value of the Properties and use their desirability function to evaluate the output. Table 5.2 compares values between the DCS_0 and DCS_1 , that are obtained with the new Ch_1 value.

Table 5.2: Comparison of values between solutions

Solution	$Pr_1(Ch_1, Ch_2, Ch_3)$	$\mu(Pr_1)$	$Pr_2(Ch_1, Ch_2)$	$\mu(Pr_2)$
DCS_0	0.1710	0.0035	0.2243	1.000
DCS_1	0.3150	0.2178	0.3887	0.6857

This enables to create a solution that has a different behaviour. For the example presented on Table 5.2, the improvement of desirability for Pr_1 is clear, but for Pr_2 , the new value is lower. Subsequently, it is necessary to evaluate the complete solution.

Consequently, it is key to perform an evaluation of each *DCS*: first by proposing a modification on the value of a Characteristics and then, evaluating the solution using the GDI. Therefore, it is proposed the GDI as a mean to compare different generated solutions. This GDI is an aggregation of the set of $\mu(Pr_j)$, based on a discordance model, which means that is focused in respecting

lower values. Equation 5.8 shows the GDI calculated with values of each DCS . Having sub-index h as the consecutive of each calculated DCS , the GDI is defined as:

$$Agg.\mu_h = \prod_{j=1}^j \mu(Pr_j) \quad (5.8)$$

This GDI allows to compare, for example, the two solutions from Table 5.2. The aggregated desirability for the first solution is $Agg.\mu_0 = 0.0035$, while for the solution calculated for DCS_1 , $Agg.\mu_1 = 0.1494$. The new aggregated desirability is considerably much higher than the initial calculated desirability. This increase was generated by the assignation of a new value of the Characteristic, calculated to generate the greatest positive impact on the solution.

The next challenge is to define how to control those *values assignation* routines. To do so, it is proposed an iterative routine. with an order that is conceived to generate the biggest impact between two consecutive pair of DCS .

Seeking to understand how the biggest impact on design can be measured, in Section §4.3.1 the global impact of the GSA was evaluated in a design. In this section, several indexes were calculated to represent the sensibility between a Property and its Characteristics. This index, related to each GSA of the Property is called ρ index (as seen in Section §4.2.2.1). Likewise, it was also calculated the ζ index, which was calculated for each Characteristic (Equation 4.18) and represented the sum of the global impact on the design of each Characteristics (Section §4.3.1).

As an example, this analysis was performed in the portable cooler design case. Table 4.8 shows the different ρ calculated on the SA and Table 5.3 shows the calculated values of ζ .

Table 5.3: ζ_i index of portable cooler Characteristics

	L_C	W_C	H_C	th_A	th_B	th_C	th_{lid}
ζ	4.4343	3.6645	3.9126	5.2467	5.3818	5.235	1

As a result, it can be concluded that the Characteristic with lowest ζ is the Characteristic with the lowest impact on the overall design. Likewise, the highest ζ is the Characteristic that has more influence on the Properties of the design. Based on this, and seeking to impact the design in a higher level since the beginning, it is proposed an iteration loop for the iterative routine, which is given by the arranging of ζ_i from maximum value to minimum value. This arrangement can be observed in Figure 5.9.

For the design situation of the portable cooler, the arranged vector is:

$$\begin{aligned} \overrightarrow{[\zeta_{loop}]} & \therefore \zeta_{th_B} > \zeta_{th_A} > \zeta_{th_C} > \zeta_{L_C} > \zeta_{H_C} > \zeta_{W_C} > \zeta_{th_{lid}} \\ \overrightarrow{\zeta_{loop}} & = [th_B, th_A, th_C, L_C, H_C, W_C, th_{lid}] \end{aligned}$$

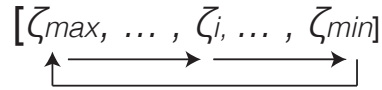

Figure 5.9: Iteration loop

Thus, the definition of this $\overrightarrow{\zeta_{loop}}$ will define the way the different solutions are generated and evaluated. The strategy of the algorithm is to define a value of a Characteristic and evaluate the GDI of the new *DCS*. Consequently, the SSNV is centred in the generation of the Characteristics' aggregated desirability functions. Based on these functions, the method seeks to maximise the overall desirability of the design by the maximisation of the Characteristics' desirability functions.

Essentially, when the aggregated preference is maximised, it is actually what the designer desires, and not a solution artificially constrained by the geometry of the design (Antonsson, 2001).

Finally, the iterative routine ends when the error is low. The error is defined as the difference between a pair of *DCS* (see Equation 5.9). The design converges toward a solution, when the error ϵ take values close to zero.

$$\epsilon_h = |Agg.\mu_h - Agg.\mu_{h-1}| \quad (5.9)$$

Regarding different MCDM, two big categories of problems can be identified: convex and non-convex problems. The proposed pre-sizing method is conceived to apply in both situations. Nevertheless, the use of the method must consider several aspects, in order to be implemented in one or another. Following sections will address these considerations.

In order to clarify the concept, in design context, several possible scenarios could be identified as:

- *Full convex problems*: this design situation will be understood when the whole set of Characteristics can be modified in order to maximise the aggregated desirability of the solution.
- *Constrained convex problems*: this design situation is when certain Characteristics cannot be modified. That is to say, that modifications of the set of Characteristics are limited, Consequently, there is a limitation for maximising the aggregated desirability of the solution.
- *Non-convex problem*: this design situation is present when certain Properties are so-tightly constrained, that several multiple local maximal points can appear during the calculation process.

5.2. Convex problems evaluation

Convex problems will be solved by a full analysis approach (See Figure 4.1 on page 137). That is to say, that the problem-solving approach is centred into assigning values to the Characteristics, then evaluate if those values meet the design criteria of the Properties. This process of assigning values is not randomly defined, conversely, it is a structured process, designed to generate a bigger impact at each modification. This process was explained in §5.1.3 and corresponds to an iterative loop, where Characteristics are ranked according to their impact on the design. Figure 5.10 presents how the process is performed.

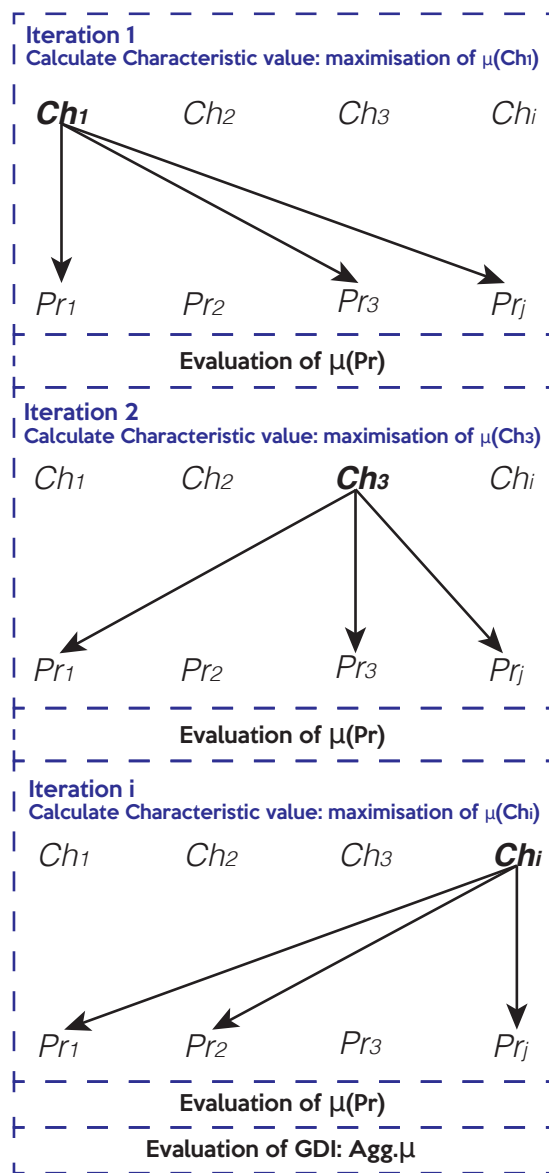

Figure 5.10: Analysis approach for solving convex MCDM

The process of completing the iteration loop vector will be called *iteration loop* and it will represent the iterations between Ch_1 to Ch_i . This concept is important to define, because the evaluation of the error ϵ (Equation 5.9) is made, not at the end of each iteration, but at the end of each loop. This mechanism aims to minimise the impact of local maximums.

5.2.1. Preparation of the method

For the method to work is necessary to conduct the design process (using the methodology shown in Figure 5.1). The required information for the method is:

1. *List of Characteristics*: This is a matrix sized $[i, 3]$, that must contain the domain of possible values for each characteristics. It must include their maximum and minimum value, as well as the mean value of their distribution.
2. *List of $\mu_{(Pr_j)}$* : This list must include the j desirability functions of the Properties. This information must include the minimum accepted value, maximum accepted value and the type of desirability function, for each Property. This information must be stored in a matrix sized $[j, 5]$ (two extra columns for Pi functions).
3. *List of Ψ indexes*: the normalised shortest path of each Property-Characteristic connection. This index represent the influence that the Characteristic has with the Properties where it makes part. This information is stored as a vector.
4. *Traceability tree*: The CPM/PDD structure that allows to understand the connection between Properties and Characteristics.

5.2.2. Implementation of the iterative method

The programming of the method must be performed following the defined iteration loop (See Section §5.1.3). Figure 5.11 presents the steps used for the pre-sizing routine.

This schema is divided in three parts. In the first parts, it is necessary to load the whole information of the design. In the second part, it is arranged and prepared the iteration loop, based on the values of ζ . Finally, the third part is the iterative routine, which is performed using the Function shown on Algorithm 2 which has 5 inputs: the current evaluated Characteristic, the matrix of domains $[i, 3]$, the Desirability limits matrix $[j, 5]$, the current DCS and the Ψ vector. Regarding its outputs, 4 items are obtained: new value of the evaluated Characteristic, the actual desirability of the Characteristics $\mu(Ch_i)$ evaluated value, the evaluated desirability of the Properties $\mu(Pr_j)$ and the evaluated values of the Properties.

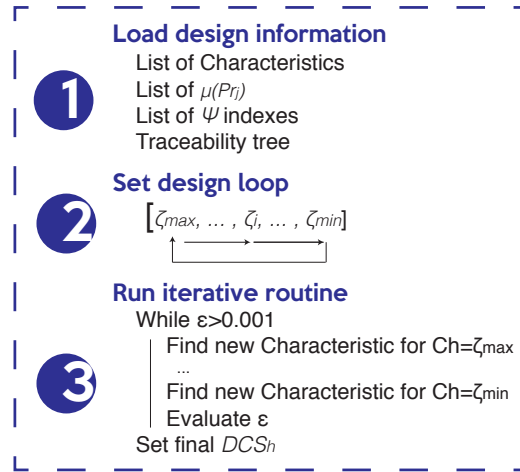

Figure 5.11: Schema of the iterative pre-sizing routine

Finally, for evaluation purposes, the propagation model is performed in an discretised manner (for example, evaluating the function in 500 points within its interval), in order to calculate the desirability function of the Characteristics.

5.2.3. Implementation of the pre-sizing method in convex problems

The evaluation of convex problems, using the pre-sizing method, is the most unconstrained situation. It is only constrained by the desirability limits of its Properties, but untightened enough to offer the possibility to perform an open analysis that allow to define the final values of the Characteristics that maximise the GDI of the desirability.

Considering the case of the portable cooler design, from Appendix A, the problem is composed by 7 Characteristic and 7 Properties, and it can be written as:

Given:

$DCS_0 \{th_A, th_B, th_C, W_C, L_C, H_C, th_{lid}\}$, Design Characteristic Space of values from the preliminary layout

Maximise:

$\max(Agg.\mu_h) \mid DCS_h \{Ch_1, Ch_2, \dots, Ch_i\} \in \mathbb{R}$, Design Characteristic Space of values that maximise the GDI measured as the aggregated desirability of the Properties

Algorithm 2: Find Best Aggregated Value of Characteristic

Result: Best new value of a Characteristic

1 **function input:** Ch_i , Domaines, DesLimits, DCS, PsiVector

2 **function output:** NewChValue, BestAggDesirabilty, PrDesirabilities, PrValues

3 %%Evaluate the Properties in term of Ch_i

4 **set** $Pr_1 = fn(Ch_i)$ %% Let complementing characteristics in their current DCS value

5 **set** $Pr_2 = fn(Ch_i)$

6 **set** $Pr_j = fn(Ch_i)$

7 %%Definition of the Characteristic as vector

8 $Ch_i.vector = [Domaines(i, 1) : (Domaines(i, 2) - Domaines(i, 1))/499 :$
 $Domaines(i, 2)];$

9 **for** $step = 1$ **to** 500 **do**

10 | %%Calculation of the Desirability of the Properties by the variation of Ch_i

11 | $\mu(Pr_1/Ch_i) = \mu(Pr_1(Ch_i), [DesLimits(j = 1, 1), DesLimits(j = 1, 2)])$

12 | $\mu(Pr_2/Ch_i) = \mu(Pr_2(Ch_i), [DesLimits(j = 2, 1), DesLimits(j = 2, 2)])$

13 | $\mu(Pr_j/Ch_i) = \mu(Pr_j(Ch_i), [DesLimits(j, 1), DesLimits(j, 2)])$

14 | %%Calculation of the Desirability of Ch_i

15 | $\mu(Ch_i) = \prod \Psi_{Pr_j/Ch_i} * (\mu_{(Pr_j)/Ch_i})$

16 **end**

17 %%From Desirability of Ch_i vector

$[BestAggDesirabilty, BestPosition] = max(\mu(Ch_i))$

18 $NewChValue = \mu(Ch_i)_{[1, BestPosition]}$

19 **set** DCS_h . Modify $Ch_i = NewChValue$

20 %%Calculate new Properties values at current DCS

21 **set** $Pr_1.eval = fn(DCS_h)$

22 **set** $Pr_2.eval = fn(DCS_h)$

23 **set** $Pr_j.eval = fn(DCS_h)$

24 $PrValues = [Pr_1.eval, Pr_2.eval, \dots, Pr_j.eval]$

25 $PrDesirabilities = [\mu(Pr_1.eval,), \mu(Pr_2.eval,), \dots, \mu(Pr_j.eval,)]$

Therefore, the DSC associated to the preliminary layout of the portable cooler is defined as:

$$DCS_0 = \{th_A = 0.0140, th_B = 0.02729, th_C = 0.01384,$$

$$L_C = 0.3477, H_C = 0.3081, W_C = 0.3141, th_{lid} = 0.034\}$$

With this *DCS* the values of the Properties can be calculated as shown in Table 5.4 where the initial values and the desirability calculated from those values of Properties are listed.

Table 5.4: Properties values on preliminary layout

Pr	Property	Value	$\mu(Pr_j)$
Pr_1	Internal temperature	4.228°C	1.00
Pr_2	Resistance	8.124KPa	1.00
Pr_3	External length	0.454m	0.999
Pr_4	External width	0.421m	0.174
Pr_5	External height	0.436m	0.747
Pr_6	Total weight	18.475Kg	0
Pr_7	Internal volume	37.984l	0.178
Mean Desirability of Properties		$\overline{\mu(Pr_j)}$	0.585
Aggregated Desirability of Properties (GDI)		$Agg.\mu(Pr)_0$	0

In Table 5.4, the calculated GDI is zero ($Agg.\mu(Pr)$), the, the solution cannot be accepted. Based on the value of the DCS_0 , and following the process explained on Figure 5.11 with the Algorithm 2 on page 203, the iterative process can be initialised. Figure 5.12 presents the evolution of the desirability functions after several loops. The Figure presents the behaviour of the Characteristic th_B , which is the Characteristic with the highest ζ index, being the one that impacts the most the design. In Figures 5.12b, 5.12d and 5.12f, are presented the propagated desirability functions of th_B , while in Figures² 5.12a, 5.12c and 5.12e are presented the desirability of the Properties by the modification of th_B .

Regarding desirability functions of the Properties ($\mu(Pr_j)$) by the modification of th_B , in the loop 1 it can be seen the complexity of assigning values for the Characteristics, especially because of the presence of opposite behaviours: on some Properties, high values produces high desirabilities and in other produces null desirabilities. As the iteration loops are completed, it can be seen how the behaviour of the solution changes. This change can be seen in Figures 5.12b, 5.12d and 5.12f where the desirability of the Characteristic is calculated.

Between loop 1 and 3, the GDI evolves from: $Agg.\mu(Pr)_0 = 0$ as starting point; at loop 1, $Agg.\mu(Pr)_1 = 0.006$; ; at loop 2, $Agg.\mu(Pr)_8 = 0.083$; at loop 3, $Agg.\mu(Pr)_{15} = 0.367$. Finally, the iterative process continues until the ϵ is lower than 0.001, finally converging after 70 iterations and evaluated with $\epsilon < 0.0001$ converging at 84 iterations. The evolution of the GDI can be observed in Figure 5.13a where the evolution of the desirabilities of the seven Properties through the iterative process is presented, and Figure 5.13b shows the aggregated desirability of

²These Figures represent the DDF.

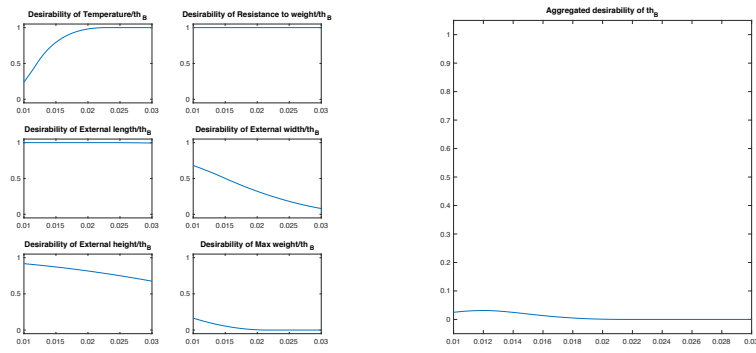

(a) Loop 1: $\mu (Pr_j/th_B)$

(b) Loop 1: $\mu (th_B)$

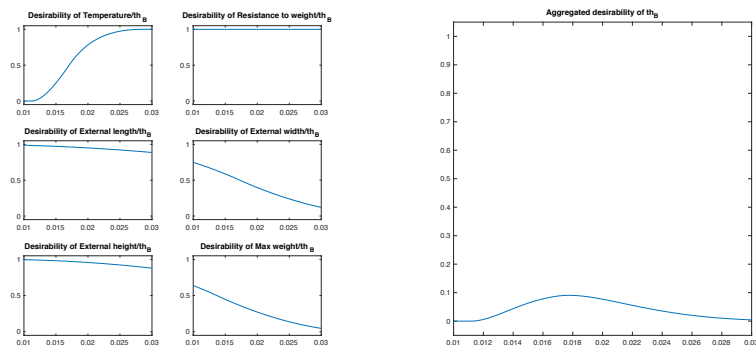

(c) Loop 2: $\mu (Pr_j/th_B)$

(d) Loop 2: $\mu (th_B)$

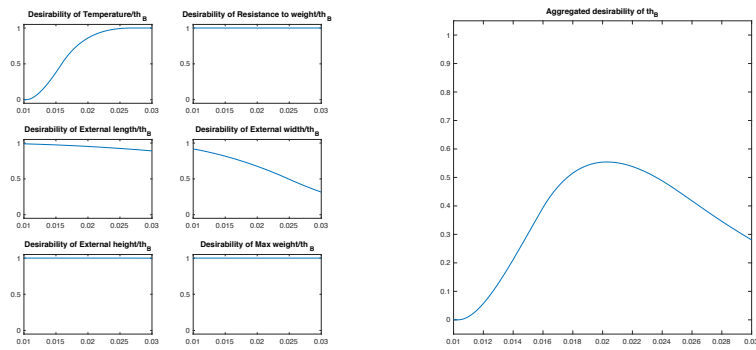

(e) Loop 3: $\mu (Pr_j/th_B)$

(f) Loop 3: $\mu (th_B)$

Figure 5.12: Evolution of desirabilities through the iterative process

the Properties.

From Figure 5.13 it can be seen that the desirability of the Properties converges and tends to be asymptotic around $\mu = 0.57$. The values of the Properties at the end of the iterative process can be observed in Table 5.5. This local maximum of the desirability can be defined as

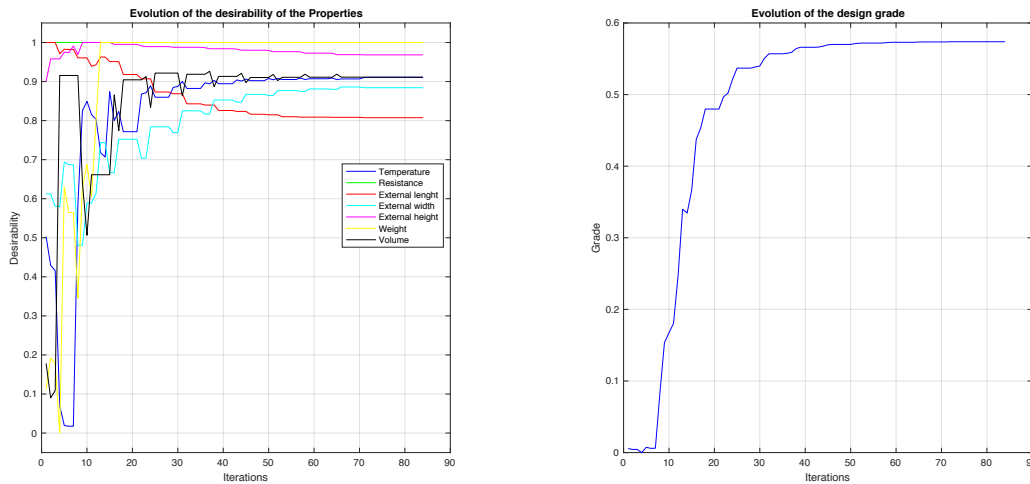

(a) Evolution of the desirabilities of the Properties

(b) Evolution of GDI

Figure 5.13: Evolution of the desirability indexes through the iterative process

a global maximum, following the properties of this type of convex problems (Rockafellar, 2015). Considering the design of the portable cooler as a convex problem, Properties' values of DCS_{84} , that maximise the aggregated desirability, are:

$$DCS_{84} = \{th_A = 0.010, th_B = 0.0235, th_C = 0.010, \\ LC = 0.4406, H_C = 0.2871, W_C = 0.3391, th_{lid} = 0.030\}$$

Based on the set DCS_{84} , values of the Properties can be calculated, as well as the desirabilities associated to those values of the Properties. This results are summarised in Table 5.5, where it can be concluded that the use of the pre-sizing routine allow to calculate a combination of values of the Characteristics that maximises the aggregated desirability of the Properties.

Table 5.5: Properties values after the iterative process

Pr	Property	Value	$\mu(Pr_j)$
Pr_1	Internal temperature	5.345 °C	0.911
Pr_2	Resistance	8.5525 KPa	1.000
Pr_3	External length	0.528m	0.807
Pr_4	External width	0.374m	0.884
Pr_5	External height	0.413m	0.968
Pr_6	Total weight	13.717 Kg	1.000
Pr_7	Internal volume	42.894 l	0.911
	Mean Desirability of Properties	$\overline{\mu(Pr_j)}$	0.926
	Aggregated Desirability of Properties	$Agg.\mu(Pr)_{84}$	0.574

5.2.4. Implementation of pre-sizing method in constrained convex problems

It may happen in certain design situations that, the possibility of modifying a specific Characteristic might not be permitted. This completely changes the landscape on how the problem should be addressed. It is intended to evaluate the performance of the SSNV method, under these situations.

Based on the design case of the portable cooler, it was decided to constrain the value of the Characteristic that impacts the most the design, th_B , in order to explore how the system and the method performs under this situation. Hence, three different scenarios were evaluated

- (I) When th_B is constrained to $0.20m$, which is close to the value that generates that maximises the desirability.
- (II) When th_B is constrained to $0.15m$.
- (III) Identify the variation values of the Characteristic
- (IV) When th_B is constrained to $0.10m$ which is the minimum value that the Characteristic can take.

The modelling of the problem follows the same structure used in Section. §5.2.3, without considering th_B in the iteration loop (build based on the ζ index). Figure 5.14 presents the solution evolution for the three scenarios, being Figures 5.14a and 5.14b those related to $th_B = 0.20$, Figures 5.14c and 5.14d those related to $th_B = 0.15$ and Figures 5.14e and 5.14f those related to $th_B = 0.10$.

The behaviour of the problem when $th_B = 0.20$, shown in Figures 5.14a and 5.14b is quite similar to the one obtained in the unconstrained problem. The reason is that, in both situations, the value of th_B is close to the value that maximised the desirability of the problem. For this analysis, the iterative process converges to a solution after 54 iterations, showing that the solution could not be improved further more with variations of less than from final value, with a difference of 14.8% of the GDI and 1.7% of the mean desirability. When $th_B = 0.15$ and $th_B = 0.10$, the behaviour is completely different. On one hand, solution converges after 96 and 84 iterations respectively. On the other hand, Figures 5.14c and 5.14e show desirabilities related to Volume and Temperature, where even if they presented an harmonic behaviour, the method arrived to calculate a *DCS* that maximised the GDI. Finally in Table 5.6 list the Characteristics values of each *DCS* calculated and in Table 5.7 list the Properties values calculated to the *DCS* that maximised their aggregated desirability.

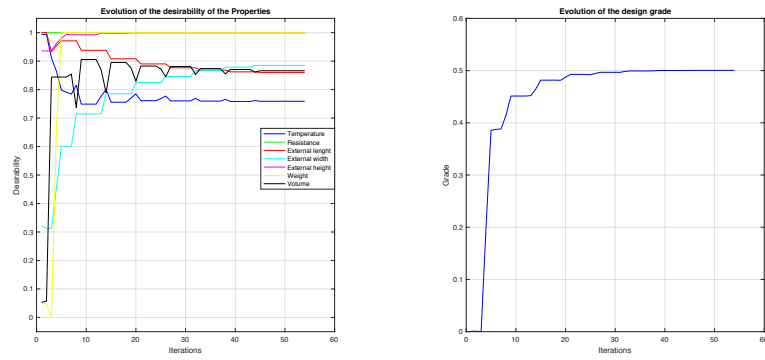

(a) $th_B = 0.20$: desirabilities evolution (b) $th_B = 0.20$: evolution of the GDI

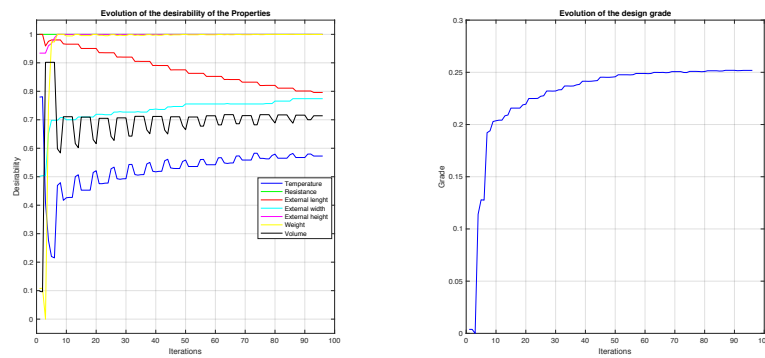

(c) $th_B = 0.15$: desirabilities evolution (d) $th_B = 0.15$: evolution of the GDI

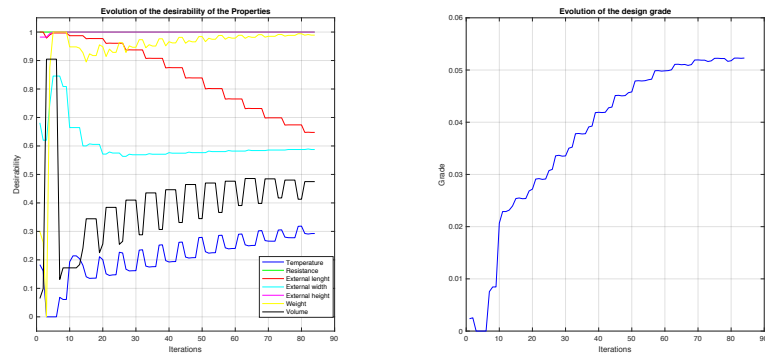

(e) $th_B = 0.10$: desirabilities evolution (f) $th_B = 0.10$: evolution of the GDI

Figure 5.14: Evolution of desirabilities through the iterative process in a constrained situation

The goal of the SSNV method was to pursue an analytic approach to solve this nature problems (convex). Both, applications in Section §5.2.3 and Section §5.2.4 were used for solving convex design problems, arriving to calculate a *DCS* that maximised the global desirability of the design. Next section is centred in using the SNNV method in "non-convex" situations.

Table 5.6: Values of the Characteristic on constrained problems

Solution	th_B	th_A	th_C	L_C	H_C	W_C	th_{lid}
DCS_{54}	0.20	0.10	0.10	0.4361	0.2940	0.3308	0.030
DCS_{96}	0.15	0.10	0.126	0.4546	0.3084	0.2940	0.030
DCS_{84}	0.10	0.136	0.106	0.4867	0.3272	0.2504	0.030

Table 5.7: Properties values after the iterative process after constraining th_B

Pr	Property	$th_B = 0.20$		$th_B = 0.15$		$th_B = 0.10$	
		Value	$\mu(Pr_j)$	Value	$\mu(Pr_j)$	Value	$\mu(Pr_j)$
Pr_1	Internal temperature	5.888 °C	0.759	6.349 °C	0.573	6.970 °C	0.293
Pr_2	Resistance	9.504 KPa	1.000	9.846 KPa	1.000	10.365 KPa	1.000
Pr_3	External length	0.516 m	0.860	0.530 m	0.796	0.555 m	0.648
Pr_4	External width	0.374 m	0.885	0.384 m	0.774	0.395 m	0.588
Pr_5	External height	0.401 m	1.000	0.362 m	1.000	0.314 m	1.000
Pr_6	Total weight	13.259 Kg	1.000	14.038 Kg	1.000	14.293 Kg	0.989
Pr_7	Internal volume	42.413 l	0.866	41.219 l	0.714	39.872 l	0.713
	Mean μ of Properties	$\overline{\mu(Pr_j)} =$	0.910	$\overline{\mu(Pr_j)} =$	0.837	$\overline{\mu(Pr_j)} =$	0.713
	Agg. μ of Properties	$Agg.\mu(Pr)_{54} =$	0.500	$Agg.\mu(Pr)_{96} =$	0.252	$Agg.\mu(Pr)_{84} =$	0.052

5.3. Non-Convex problems evaluation

Non-convex problems offers a different challenge in MCDM. As a difference with convex problems (where the local maximum is a global maximum), in non-convex problems, several local maximums can be obtained, being more difficult to find a global maximum (with the uncertainty that it exists).

Regarding the SSNV method, the proposed approach to calculate the propagation of the desirability from Properties to Characteristics, trigger a reliability issue of the SSNV method (See the DFF $\mu_{(Pr_j)/Ch_i}$ in Section §5.1.1). In non-convex problems, the possibility that the aggregation model relapses into a randomness situation. This can be observed in Figure 5.15, where it are presented a set of DFF. In this Figure, the interval, where there is a positive desirability μ , is given by the problem's physics and there are not enough mechanism to avoid that multiplication of all areas will result in a number different than zero.

In Figure 5.15, the multiplication of desirabilities will result in zero. This means that there is no interval where a μ value over zero will be obtained for the whole set of Properties. These situations are common in problems with non-convex Properties. Since the SSNV method works by evaluating the aggregation of the desirability of the Characteristics, SSNV method might be incapable to solve problems of this nature and it must be addressed differently.

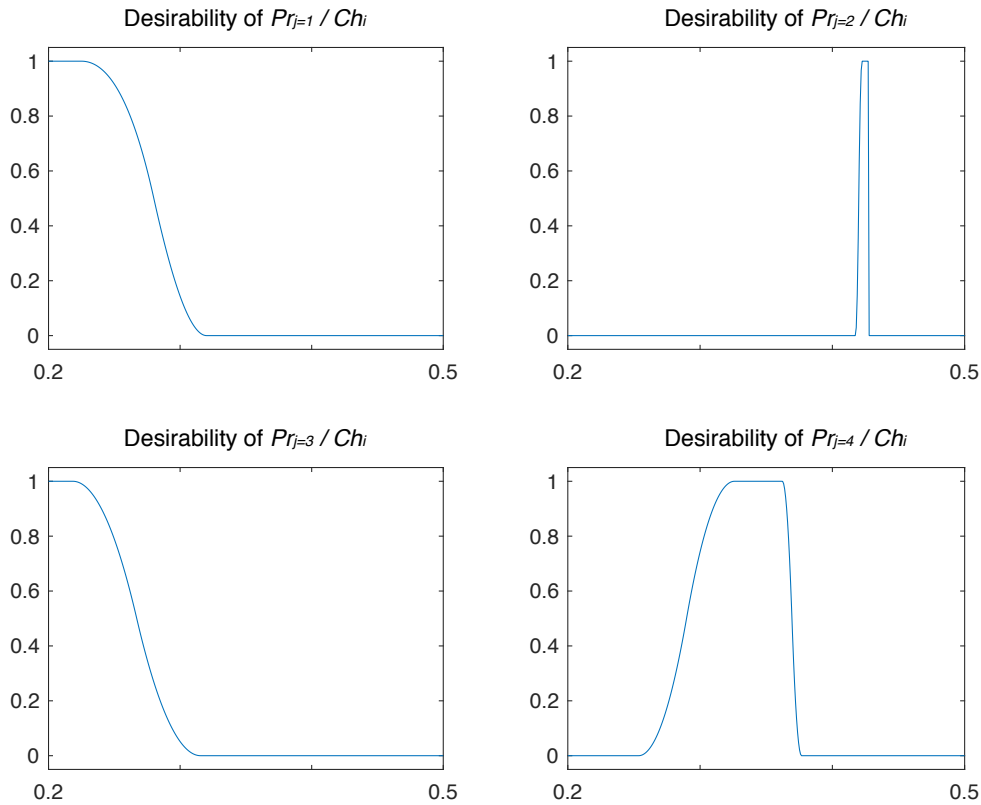

Figure 5.15: Non-convex aggregation figures

For this kind of problems, as it was established in the State of the Art (Section §3.2.1), the best strategy is to perform a convexification of the problem. To do so, it is proposed a Synthesis-Analysis approach where, first, it is addressed the solution of the Property related to the non-convex situation, by a Synthesis manner. Afterwards, based on the combinations that solve the non-convex Property, it is executed a SSNV analysis in order to determine the other Characteristic values that might allow having high values of μ for the other Properties.

Figure 5.16 presents the schema used for solving this kind of problems. Non-convex problems are solved in two stages. The first stage is centred in the convexification of the problem, which is solved using a synthesis approach. The second stage is solving the convex-part of the problem, using the SSNV analysis approach.

5.3.1. Method for convexification of non-convex Properties

In order to address the non-convex problem using the SSNV method, is necessary to convexify the problem. Some definitions for the convexification routine are:

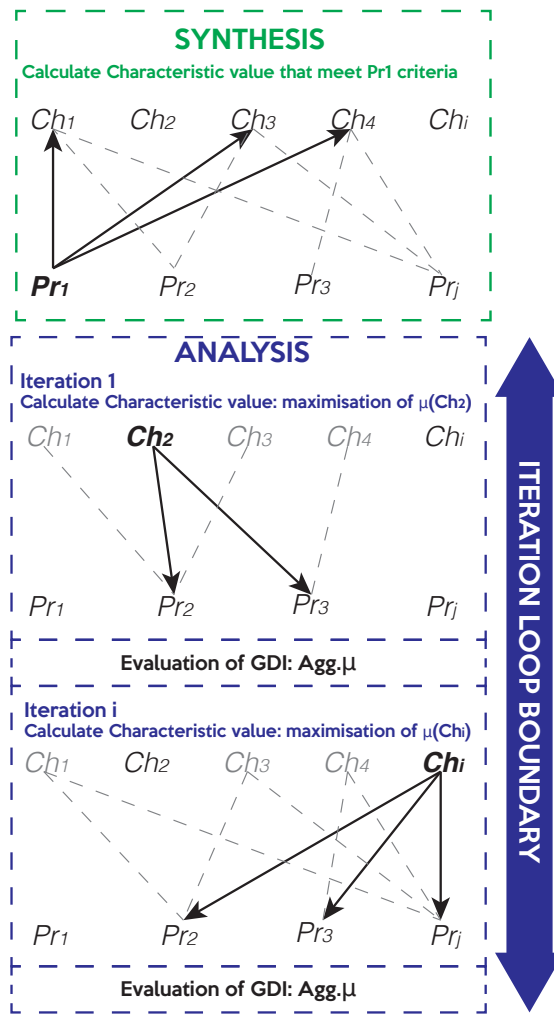

Figure 5.16: Synthesis-Analysis approach for solving non-convex MCDM

- $Pr(Ch_1, Ch_2, \dots, Ch_i)$ a Property with i Characteristics
- \mathbb{R}^i is a i -Dimensional space
- f quantity of combinations that allow $\mu(Pr) = 1$
- $Sl_f = [Ch_1, Ch_2, \dots, Ch_d]^T$ a vector composed by the f Characteristics that allow a $\mu(Pr) = 1$
- $Sl_f \in \mathbb{R}^i$ The vector is in i -Dimensional space
- $Sl = [Sl_1, Sl_2, \dots, Sl_j]$ a matrix with all vectors that allow a $\mu(Pr) = 1$

In order to proceed to a final solution, it is necessary to first solve the Property in the non-convex situation. Given the nature of the non-convex problems, the first strategy into solving problems is centred in finding a feasible region. Many methods have been used to tackle problems, such as CSP, genetic algorithms, multilevel decomposition, among others.

The use of a technique for calculating and evaluating the feasible region becomes necessary in order to obtain the Sl matrix, with fxi size, that contains the whole set of DCS that allows to have a solution of $\mu(Pr) = 1$ for the non-convex property. Nevertheless, the challenge is to evaluate those partial solutions in order to assign values for the other Characteristic that make part of the design. In the context of this thesis, the process of finding those combinations that are part of the feasible region of the solution of the Property is composed by three steps:

1. Determine the Property that compose the problem (the Property that generates the non-convexity): It is important to identify which are the Characteristics that are part of the \mathbb{R}^i dimensional space.
2. Understanding universe of possible answers: Synthesis of non-convex Property and definition of the values of the Characteristics that allow a $\mu = 1$ for the non-convex Property.
3. Solving forthcoming Properties: Performing the SSNV for finding the values that allow maximising the aggregated desirability of the Properties.

In Figure 5.17 it is presented the proposed diagram for convexificating the problem³, which is based on using a modified version of the SSNV. For doing so it is necessary to calculate a ζ' , using only the ρ values of the relationships between the non-convex Property behaviour and the Characteristic.

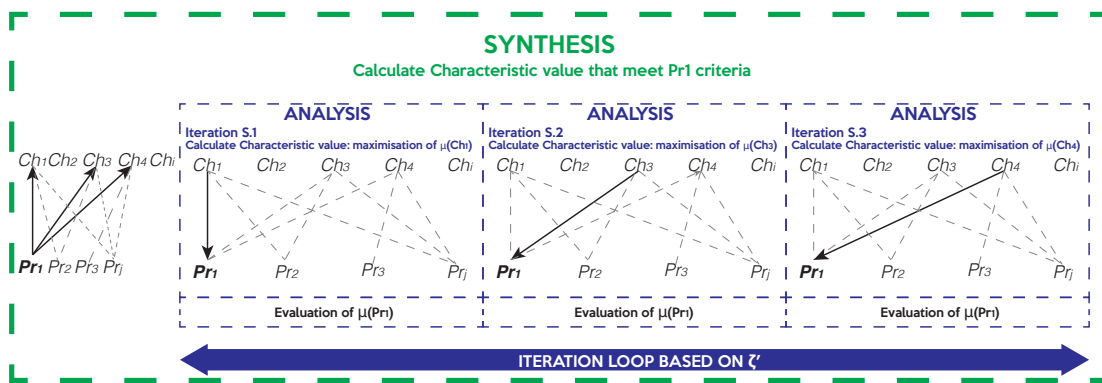

Figure 5.17: Analysis approach used in the convexification operation

The routine for maximising desirability of the non-convex Property, will allow to calculate several DCS , that can be arranged into the Sl , where the Sl_f vector will complement the DCS_h , that includes the whole set of desirabilities.

³The convexification process is based as an analysis approach

Instead of evaluating the full set of solutions, that meet the $\mu(Pr) = 1$, it is intended to only evaluate the solution that was the output of the iterative process based on the SSNV method. Before this evaluation, it is verified if the DCS_h can generate results that meet the design criteria ($\mu > 0$ for the whole Properties). In the following subsections it is evaluated how the SSNV method performs on non-convex problems.

5.3.2. SSNV application of problems with one non-convex Property

For the evaluation of non-convex problems using the pre-sizing method it is going to be considered the case of the portable cooler design from Appendix A and simulate a non-convex situation within the desirability function of the Property 5, (External height). Defining that $\mu = 1.0$ only when the value of the Property is $39 \text{ cm} \pm 1$. The problem can be written as:

Given:

$$DCS_0 \{th_A, th_B, th_C, W_C, L_C, H_C, th_{lid}\}, \text{ values from the preliminary layout}$$

Maximise:

$\max(Agg.\mu_h) \Rightarrow Pr_5^{non.convex} \mid DCS_h \{Ch_1, Ch_2, \dots, Ch_i\} \in \mathbb{R}, \text{ Design Characteristic Space of values that maximise the GDI measured as the aggregated desirability of the Properties}$

Once the non-convex situation is detected, the next step is to identify which are the Characteristics that make part of that Property. In the cooled design case, the Property is the following (Equation A.17):

$$H_{ext} = H_C + th_C + th_B + th_A + th_{lid}$$

Following the convexification routine, it is intended to calculate the iteration loop, based in the GSA of the Property. The ζ' for solving the Property with the non-convexity.

$$\overrightarrow{\zeta'_{loop}} = [H_C, th_A, th_B, th_C, th_{lid}]$$

Also, a slight modification must be considered in the use of the algorithm for finding the best aggregated value of the characteristic (Algorithm 2), which consists in only evaluating the non-convex property. Regarding the evaluation of the loop, for the convexification routine, it is necessary to calculate the error e' as:

$$\epsilon_h = |\text{mean}.\mu_h - \text{mean}.\mu_{h-1}| \quad (5.10)$$

The calculation of ϵ' , as the average desirability, rather than the aggregated desirability allows to generate solutions where the desirability is high, even if there are Properties with $\mu = 0$. Those Properties are intended to be solved where the "Analysis" process is performed. Figure 5.18 shows the evolution of the Characteristics' desirability.

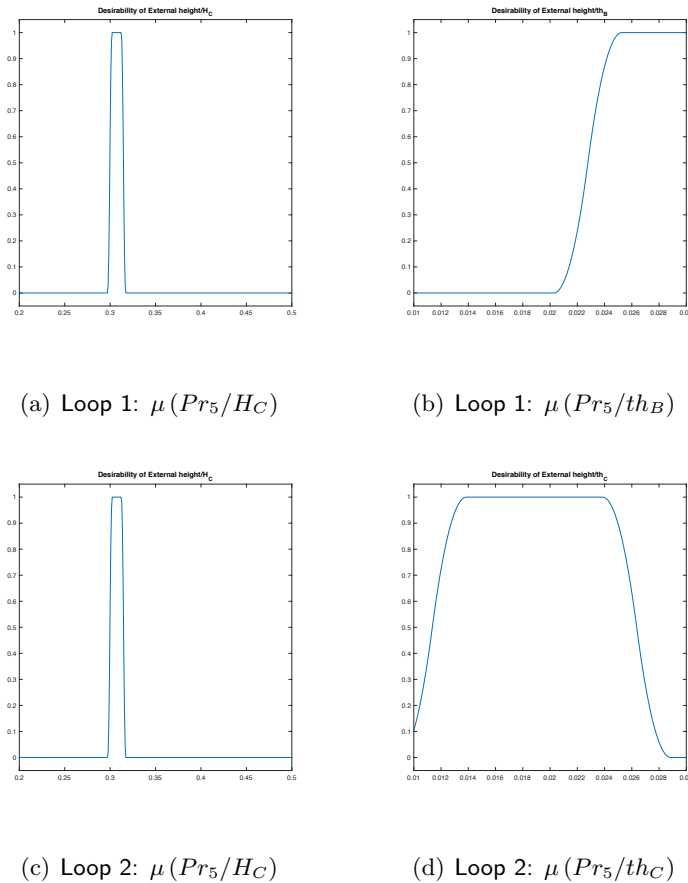

Figure 5.18: Evolution of desirabilities of Characteristics through the iterative process

From Figure 5.18 it can be observed that the most critical Characteristic was, indeed, H_C , since it had less possibilities for modification. This is because the variation of H_C is big, but the range where the Property is accepted is very limited. Also it was observed that other Characteristics have different behaviours of desirability. For instance, for th_B on the loop 1, the higher the better, but for th_C (on the loop 2) were the intermediate values those that generated higher desirability. Finally, in Figure 5.19 there can be observed the evolution of the Property's desirability. In this Figure it can be observed that the Property's μ is calculated as 1 since the iteration 2. From that point, the algorithm evaluates different combinations of values that allow to have a better solution

(in the "Synthesis" approach, the ϵ is evaluated using the mean). Also, Table 5.8 shows the results of the Properties, after the convexification process, which was obtained after 10 iterations.

Table 5.8: Properties' values after convexification

Pr	Property	Value	$\mu(Pr_j)$
Pr_1	Internal temperature	3.562 °C	1.000
Pr_2	Resistance	8.124 kPa	1.000
Pr_3	External length	0.454 m	0.999
Pr_4	External width	0.421 m	0.174
Pr_5	External height	0.390 m	1.000
Pr_6	Total weight	17.375 Kg	0.000
Pr_7	Internal volume	37.984 l	0.178
Mean Desirability of Properties		$\overline{\mu(Pr_j)} =$	0.634
Aggregated Desirability of Properties		$Agg.\mu(Pr)_{10} =$	0.000

Table 5.9: Values of the Characteristics in the convexified problem

Solution	th_A	th_B	th_C	L_C	H_C	W_C	th_{iid}
DCS_{10}	0.014	0.025	0.014	0.348	0.302	0.314	0.035

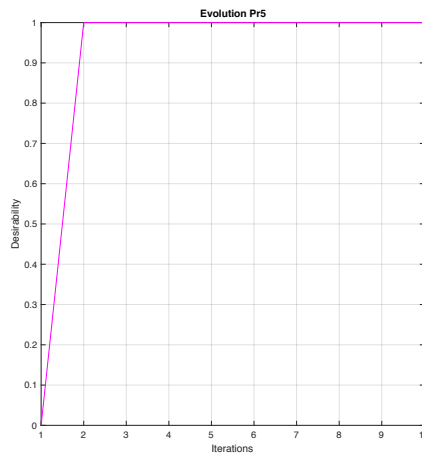

Figure 5.19: Evolution of the desirability of the Property

The synthesis process finish with the values definition for the Characteristics that generate a solution where the Property has its desirability in 1.0 (See Table 5.9 for the values, which are in bold). This allow to convexificate the problem, evolving of a problem composed by 7 Properties and 7 Characteristics, to its convexified form, composed by 6 Properties and 3 Characteristics. In this form 4 Characteristics are already fixed.

Before continuing with the "Analysis", it is necessary to validate that a solution meets the constraint of maximising the aggregated desirability. To do so, it is calculated the possible distribution of solutions, of the convexified form of the problem. With the evaluation of the forthcoming Characteristics⁴, the distribution of solutions can be observed on Figure 5.20, where the vertical line in red represents the limit in which the desirability is accepted or not. Analysing Figure 5.20, it can be observed that the convexified problem produces a feasible region. That is to say, there will be a combination of *DCS* values, that will generate a positive aggregated desirability, therefore, the aggregated desirability can be maximised. In Table 5.10 it can be observed the percentage of possibilities that can generate a solution within desirability limits.

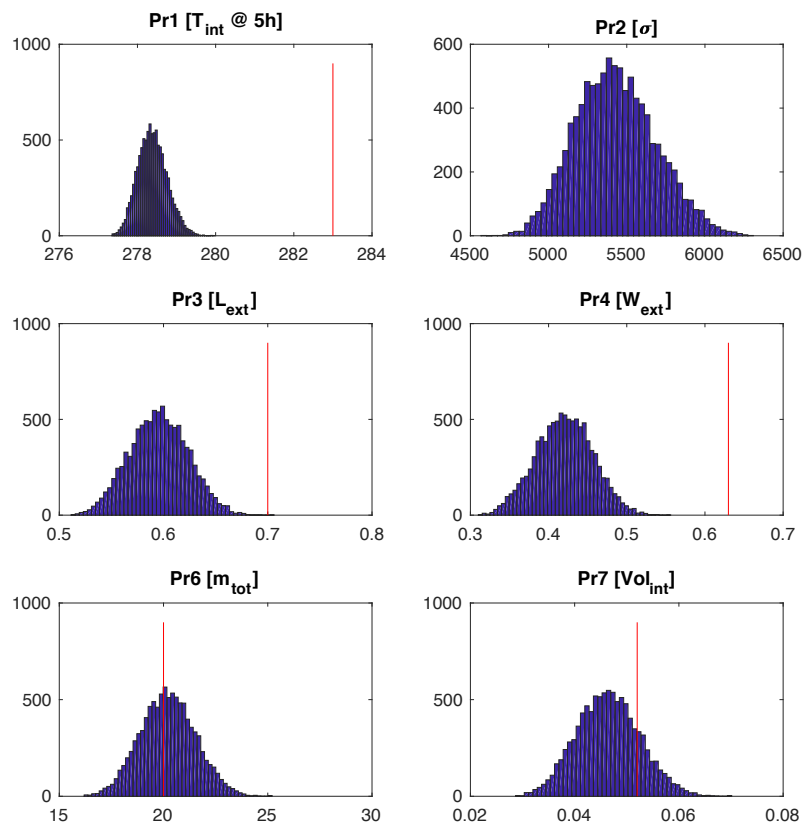

Figure 5.20: Distribution of possible solutions of the problem after the convexification process

Analysing results from Figure 5.20 and Table 5.10 for the cooler design case, it can be con-

⁴The calculation is made by evaluating the maximum and minimum values of the Characteristics, according to its defined distribution. The use of this distribution is explained on Section §4.2.1

Table 5.10: Percentage of solutions within desirability range

Property	Percentage of solutions within desirability range
Temperature	100%
Resistance	100%
External length	99.99%
External width	100%
Total weight	43.96%
Internal volume	81.80%

cluded that, for Temperature, Resistance, Length and Width, no matter which value of Characteristics is calculated, the desirability will be positive. The challenge of the "Analysis" is to calculate solutions that meet Weight and Volume (specially for Weight where more than half of the combinations produce a $\mu = 0$). The procedure for solving the convexified form of the problem is to follow the process as a convex problem (See Section §5.2). This means, to calculate ζ index in order to determine the order of the iterative process for maximising the aggregated desirability. In Figure 5.21 it can be seen the Properties' desirability by the modification of the Characteristics.

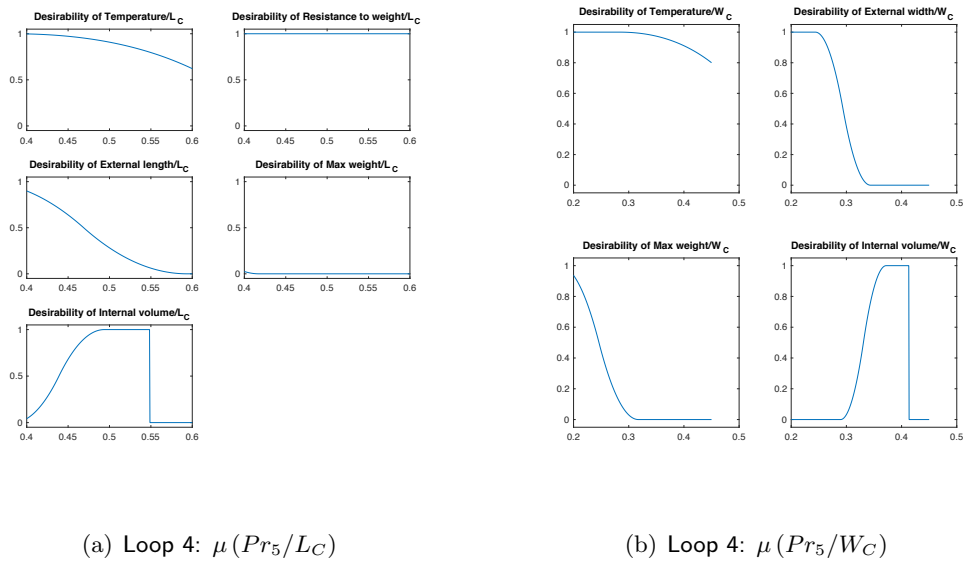

Figure 5.21: Evolution of desirabilities of Characteristics on analysis part of non-convex evaluations

After 28 iterations, the result of the algorithm produces a combination of Characteristics' values that allow to maximise the aggregated desirability. In Table 5.11 the results of the Properties can be observed, and in Table 5.12 the final values of the Characteristics.

To maximise the desirability of the convexified problem, the result of the SSNV method, find

Table 5.11: Properties values after the application of the SSNV method

Pr	Property	Value	$\mu(Pr_j)$
Pr_1	Internal temperature	4.741 °C	0.993
Pr_2	Resistance	6.285 KPa	1.000
Pr_3	External length	0.511 m	0.880
Pr_4	External width	0.404 m	0.424
Pr_5	External height	0.390 m	1.000
Pr_6	Total weight	17.574 Kg	0.023
Pr_7	Internal volume	36.448 l	0.042
Mean Desirability of Properties		$\overline{\mu(Pr_j)}$	0.623
Aggregated Desirability of Properties		$Agg.\mu(Pr)_{28} =$	0.000353

Table 5.12: Values of the Characteristic that maximise desirability

Solution	th_A	th_B	th_C	L_C	H_C	W_C	th_{iid}
DCS_{28}	0.014	0.025	0.014	0.405	0.302	0.298	0.035

a combination of values of the Characteristics. In Figure 5.22 it can be seen the evolution of the desirabilities of the Properties and the evolution of the GDI.

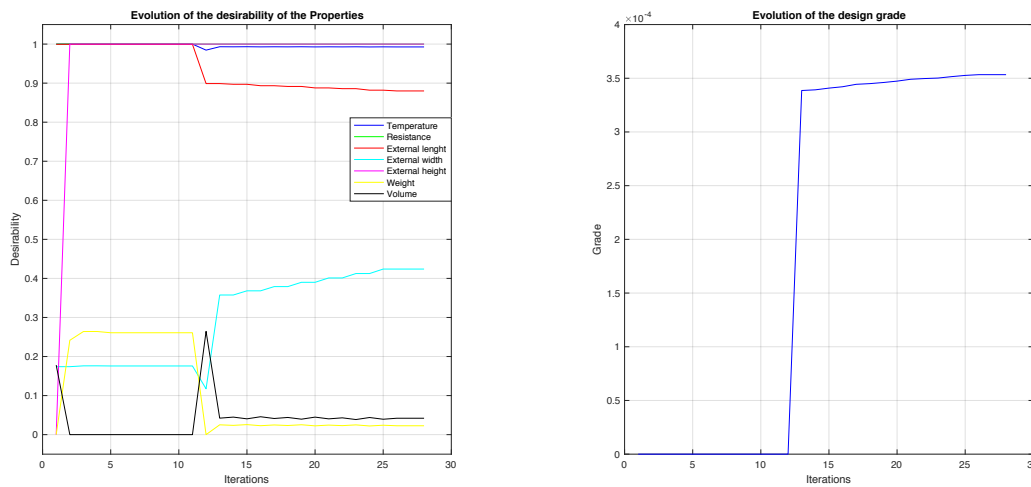

(a) Evolution of the desirabilities of the Properties

(b) Evolution of GDI

Figure 5.22: Evolution of the desirability indexes through the iterative process on non-convex problem

Analysing the results of the SSNV method, it can be concluded that the method is able to obtain a solution, different to the convexified one, that has the biggest desirability of the Properties. In fact, within the convexification process, it was never generated a solution where

Weight and Volume had a positive desirability. The proposed method allow to obtain solutions that were able to generate a positive desirability for those two Properties, without harming the desirability of the other Properties. This can be see in Figure 5.22a where it can be observed how the behaviour has some values with high desirabilities and other with lower or null desirabilities (for Weight and Volume). After iteration 10, when the convexification of the process is done, behaviour starts to change, improving the μ of Weight and Volume, by slightly decreasing the μ of External Length. Finally, in Figure 5.22b can be observed the evolution of the GDI, with was stagnant in zero while the convexification process during the "Synthesis". Later, on the "Analysis" of the application, the GDI increased until having an asymptotic behaviour close to 3.53×10^{-4} . This value, while not zero, is low. This happens because the convexified problem does not have enough degrees of freedom that allow obtaining a high desirability in all the properties. In fact, the μ of Weight and Volume is too low, but still in the feasible region.

5.3.2.1. SSNV application of problems with more than one non-convex Property

Other situations of non-convexities can be evaluated. For instance, for the case of the portable cooler design case, two hyper-constrained Properties can develop a more complex non-convex situation. Let's sat, for example that $\mu = 1.0$ when Height is $39\text{cm} \pm 1$ and Length 50 ± 1 . This can generate a more complex situation. The convexification of the problem moves from 7 Properties and 7 Characteristics, to a convexified one, composed by 5 Properties and 1 Characteristic. In this situation, the "Synthesis" solves big part of the problem. Nevertheless, it is still necessary to evaluate if there will be a feasible solution. The distribution of the possible solutions can be observed in Figure 5.23.

In Table 5.13, it can be observed the percentage of solutions that will meet the positive desirability criteria, after the development of a convexified solution. In this situation, since the problem is more constrained, the possibility of finding certain solutions, is constrained. This can be observed in Figure 5.24a. By comparing the GDI, the problem with two convexities produces a different behaviour, having its maximal value in 0.1081×10^{-3} . Nevertheless, the system is able to arrive to a solution that maximises the aggregated desirability for this situation, even if it is considerably lower compared to the convex problem.

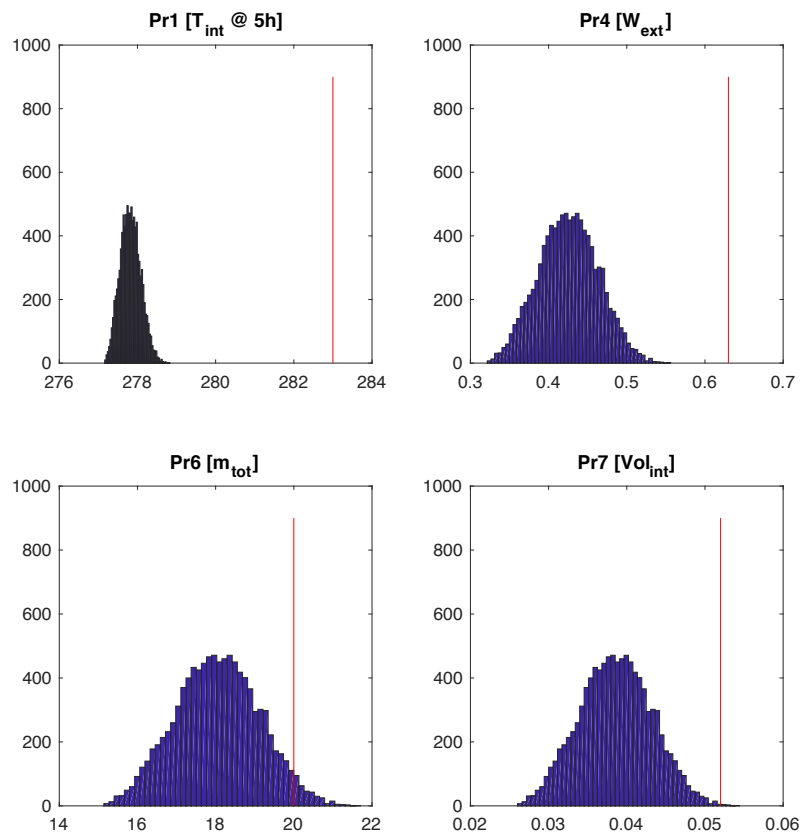
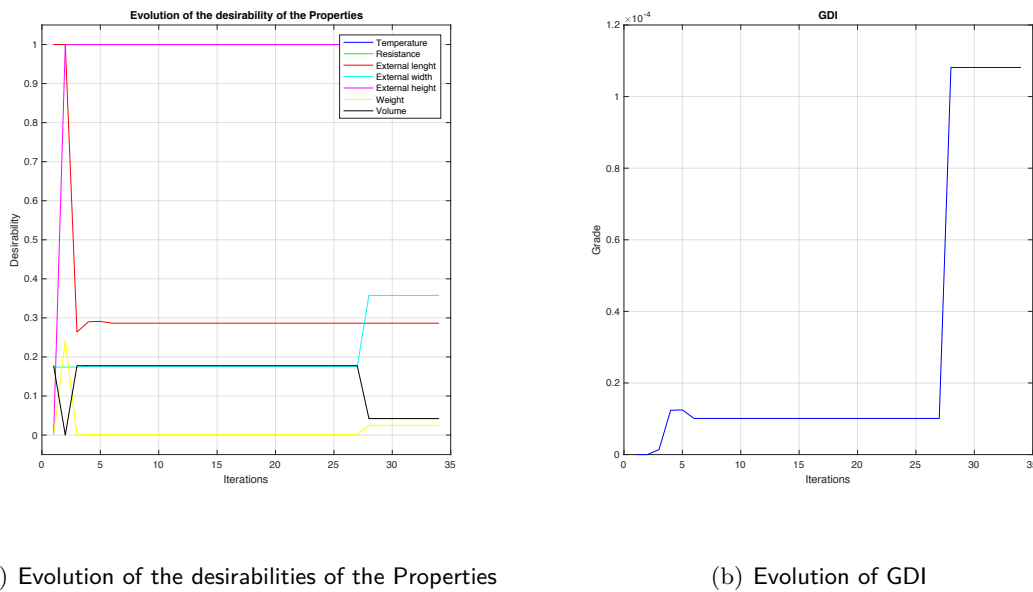

Figure 5.23: Distribution of possible solutions of the problem after the convexification process for 4 Properties

Table 5.13: Percentage of solutions within desirability range for non-convex problem of two Properties

Property	Percentage of solutions within desirability range
Temperature	100%
Resistance	100%
External width	100%
Total weight	96.93%
Internal volume	99.92%



(a) Evolution of the desirabilities of the Properties

(b) Evolution of GDI

Figure 5.24: Evolution of the desirability indexes through the iterative process on non-convex problem of two Properties

5.3.2.2. SSNV application of problems when the non-convex Property holds-up the whole Characteristics set

Another situation of non-convex problem can happen when the non-convexity occurs in the Property that holds the biggest quantity of the Characteristics (which can be measured using the Traceability Framework). For instance, on the case of the design of the portable cooler, a constrained space of solution of the Temperature (or the Weight) will generate this phenomena.

For this situations, the convexitication of the problem does not fit, because the convexitication process solves one Property first, and the solves the completing Properties in parallel. Since a non-convex Property that holds all the Properties will not work under that model, it is necessary to define a model that can solve those kind of problems.

The convex model could not work neither. On the convex application of the SSNV, the iteration loop is given from the maximum to minimum in terms of the impact ζ_{Ch} . The problem of that approach on non-convex problems occurs when in the first loop, the Characteristic with the highest impact does not arrive to calculate a value of that generates a positive desirability, the whole system might tend to miscalculate, generating a solution with null aggregated desirability.

This phenomena is going to be explained by the simulation a non-convex situation for Property of Temperature, defining that $\mu = 1.0$ when Temperature is $3.5^\circ \pm 1$. On Figure 5.25 it can be watched what happens when the iteration loop is bad defined. The system could not find a

solution and the whole values of the Characteristics are bad graded.

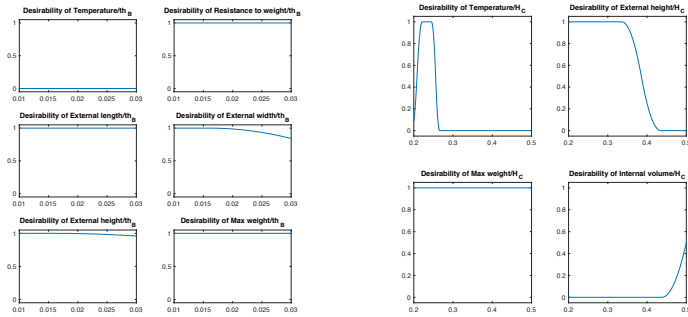

(a) Loop 1: $\mu(P_{r1}/th_B)$

(b) Loop 1: $\mu(P_{r1}/H_C)$

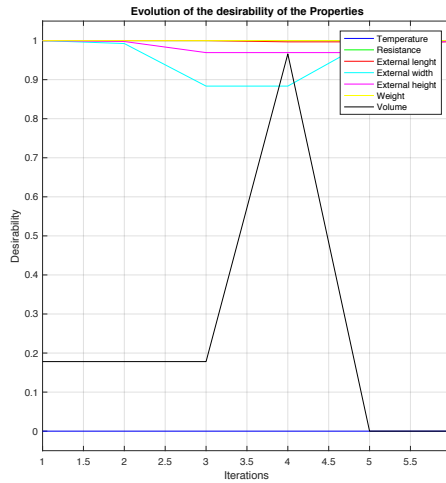

(c) Evolution of the desirabilities of the Properties

Figure 5.25: Evolution of the desirability of Properties in non-convex situations with a bad definition of iteration loop

In order to avoid that kind of behaviours, and considering how delicate are non-convex problems to a modification of a value, it is proposed to use an inverted iteration loop. That is to say, that arrange the values from the minimum ζ_{Ch} to the maximum. This will enable a decrease the degrees of freedom within the iteration loop by fixing the less influencer Characteristics first.

Evaluating the same non-convex situation, but implementing a different iteration loop, a solution can be calculated. The SSNV method takes 84 iterations in order to develop a combination of Characteristics that maximises the aggregated desirability of the Characteristics. In Figure 5.26 it can be observed the evolution of the desirabilities of the Properties and the GDI. Also, in Table 5.14 and Table 5.15 it can be observed the final values of the Properties and the values of the

Characteristics.

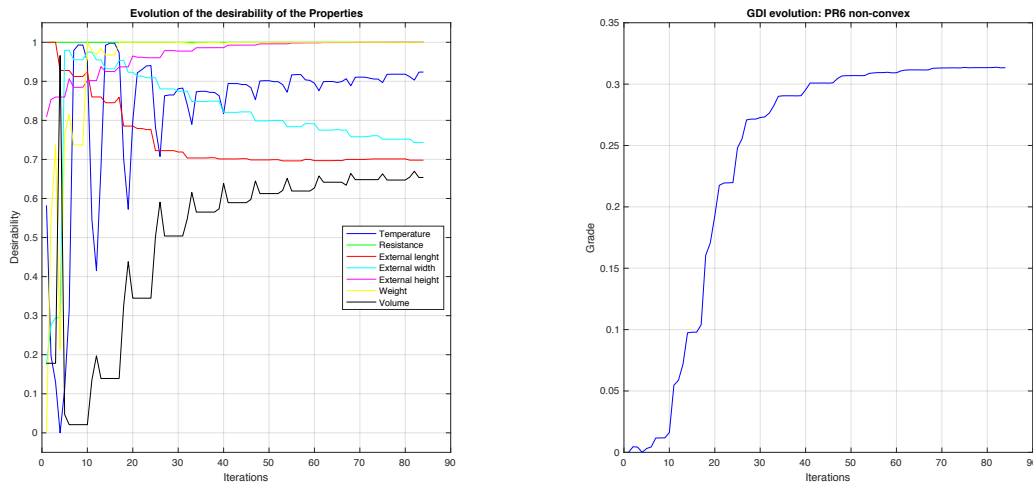

(a) Evolution of the desirabilities of the Properties

(b) Evolution of GDI

Figure 5.26: Evolution of the desirability indexes through non-convex problems using modified design loop

Table 5.14: Properties values after the SSNV application for non-convex problems using modified design loop

Pr	Property	Value	$\mu(Pr_j)$
Pr_1	Internal temperature	4.098 °C	0.924
Pr_2	Resistance	7.285 KPa	1.000
Pr_3	External length	0.547m	0.698
Pr_4	External width	0.386m	0.743
Pr_5	External height	0.400m	1.000
Pr_6	Total weight	13.750 Kg	1.000
Pr_7	Internal volume	40.840	0.313
	Mean Desirability of Properties	$\overline{\mu(Pr_j)}$	0.860
	Aggregated Desirability of Properties	$Agg.\mu_{10}$	0.313

Table 5.15: Values of the Characteristic that maximise desirability for non-convex problems using modified design loop

Solution	th_A	th_B	th_C	L_C	H_C	W_C	th_{iid}
DCS_{84}	0.0100	0.0300	0.0100	0.4471	0.3195	0.2858	0.03

Regarding the results, compared to the solution of the convex situation, the results are con-

gruent. The aggregated desirability was lower on the non-convex situations, but the values of the Properties were able to generate good values of the desirability. Also, the results were similar because the non-convexity was on the region of $\mu_{Pr1} < 0.95$ of the convex problem, so the results should forcefully be similar, in terms of values of Properties and quantity of iterations. For instance, simulating a non-convexity on Temperature with $\mu = 1.0$ when Temperature is $7^\circ \pm 1$, or a non-convexity on Weight on with $\mu = 1.0$ when weight $15\text{Kg} \pm 0.5$ could get to the solution on 224 and 119 respectively.

Chapter conclusions

It was proposed a pre-sizing method that allows to calculate a lay-out that maximises the aggregated desirability of the Properties. Regarding the interactive framework, the application of the SSNV method will calculate a better combination of values towards a multi-criteria optimisation environment. Figure 5.27 summarises the full interactive design methodology proposed in this thesis.

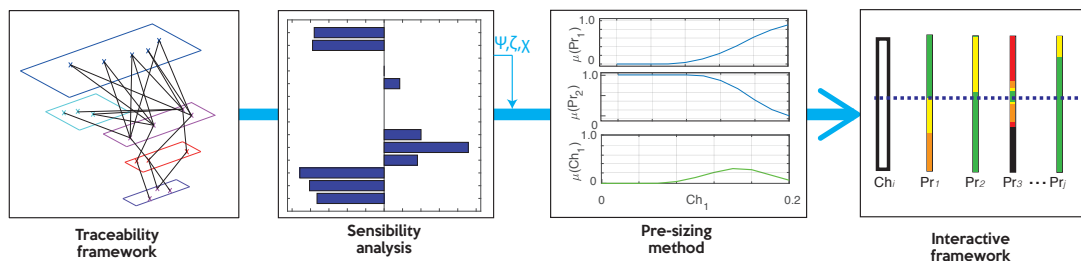

Figure 5.27: Interactive design methodology

With the pre-sizing method, the input for the interactive framework produces better performance in the solution. With the calculated *DCS*, the modification of the values of the Characteristics is located in a more positive scenario for the design team. This is to say, the modification of a Characteristics, in order to improve determined Property, is made with a reduce uncertainty, as well as in a scenario that already has the Properties' desirability in a high number.

Also, it was explored the robustness of the SSNV method, by evaluating the method on convex situations, but also, on non-convex situations, where the strategy is centred in two approaches: i) convexifying the problem, that can be used when is detected a non-convexity associated to a Property and a synthesis-analysis is performed ii) Modifying the iteration loop and conducting an analysis, which is used when the Property that has the non-convexity holds the whole quantity of Characteristics of the problem.

Finally, in Chapter 6 a Case study will be performed, where the proposed design methodology will be applied to a design case. In this chapter, the interactive framework will be addressed in two different manners: i) using the values of the Characteristics calculated in the Monte Carlo simulation ii) using the values calculated with the SSNV method, values that maximise the aggregated desirability of the Properties' desirability.

Interactive-preliminary design methodology validation

In this chapter the proposed design methodology is applied to a real design case in order to validate the approach. For that reason, a real design problem was selected, together with an already solved approach from the literature, in order to have a reference point to analyse the performance of the proposed methodology described in Chapters 4 and 5. This methodology is based on the use of some tools throughout the design stages in order to generate the information needed for using the proposed interactive pre-sizing method (SSNV method). In Figure 6.1 it is presented the methodology, which is divided in three stages: task clarification stage, conceptual design stage and embodiment design stage, where the new pre-sizing method is implemented.

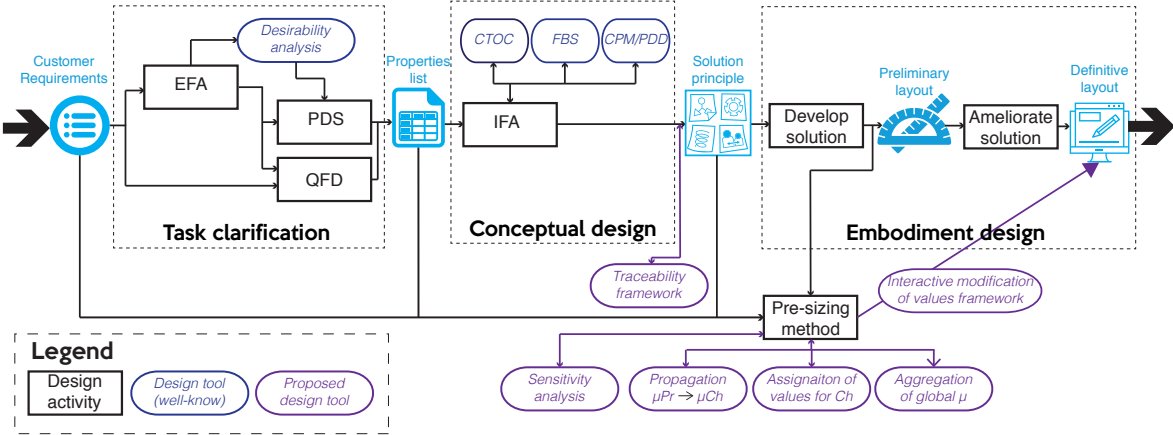

Figure 6.1: Design methodology proposal

6.1. Description of the case

6.1.1. Solar energy systems

Nowadays, the effect of the greenhouse gases is one of the most critical threats, worldwide speaking. One of the major emissions are the fossil-fuel power stations (Benson and Orr, 2008). Those stations generate electricity from burning petroleum, coal or natural gas, resulting in the emissions of tons of CO₂ (Rao and Rubin, 2002).

In order to reduce greenhouse gases, different and more sustainable technologies have emerged. One of those technologies is the solar energy conversion to electricity using Photo-Voltaic (PV) generators (Hoffert et al., 2002). This source of energy is often categorised in two types: i) When the PV generator is connected on the grid ii) When the PV generator is not connected on the grid, which is called Standalone Photo-Voltaic System (SAPV) (Akikur et al., 2013).

The case study is focused on the preliminary design of a SAPVs. For instance, an already solved non-convex problem will be addressed. This selection will allow to define a framework of comparison between both solutions, the one from the literature and the one developed using the methodology. This Chapter will be divided in four sections: i) A description of the case study ii) Modelling of the problem following the proposed methodology and implementing an interactive exploratory design for finding solutions iii) Using the pre-sizing method for maximising the desirability of solution iv) Discussion of the SSNV method implementation.

The main objective of a SAPV is to transform sun's ray into electricity, where the transformation process is made by the use of PV modules and the electricity energy storage using batteries. In the middle of these two systems, it is necessary to install a power inverter, in order to convert the Direct Current (DC) output from the PV into Alternating Current (AC) that can be stored in the storage devices. In Figure 6.2 a representation of a SAPV can be observed.

The main issue with the SAPVS is related to the energy management, the issues from the PV generation and the load consumption. This means to understand what to do when the load is less than the generated energy and how to manage the load when there is no sun. Here is when batteries play a key role. Batteries are able to provide electric energy by transforming the potential energy stored in chemicals, supplying the need of storing energy. This allow to provide energy demand even if it was not generated on the same space/time of consumption (Fernández-Montoya et al., 2017). The key of the design of a SAPVS is the understanding of the issues between generation and the load consumption. This is centred in balancing electricity generation and storage in order to fulfil a determined load. This design integrates the following disciplines:

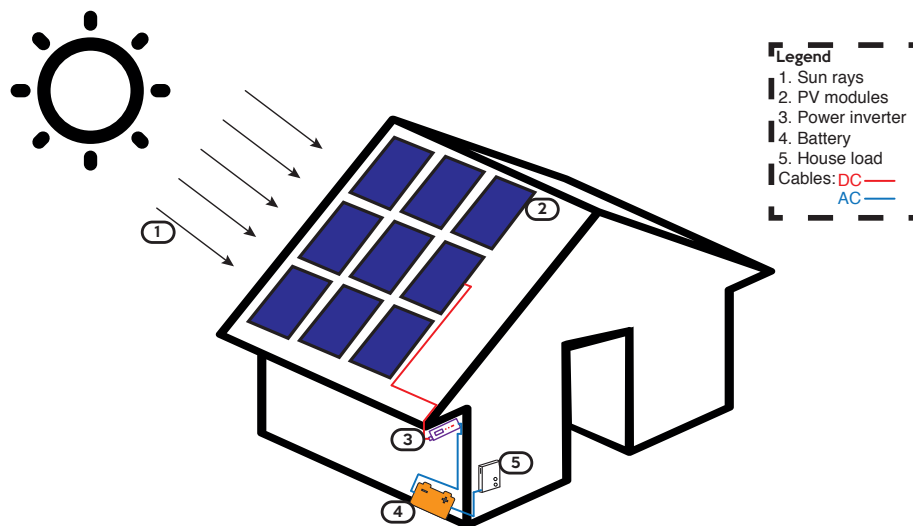

Figure 6.2: Representation of a standalone photo-voltaic system

mechanics, electronics and thermal, whereby, it can be understood as a multidisciplinary design activity.

The validation process is focused in addressing the problem proposed by Semassou (2011). In this study, the author presented the design of a SAPVS for fulfilling the energy needs of a rural home. Within his work, different energy systems were analysed and modelled in order to generate the criteria for calculating an optimal solution. This application will be described in the following subsections.

6.1.2. Development of energetic systems for developing countries

The context of the selected SAPVS design is located in the rural area of the sub-Saharan Africa. In this area, the ratio of people without access to electricity is alarmingly low, with only around 8% (FALL, 2008). Semassou (2011) proposed a study to analyse the feasibility of implementation of SAPVS on Benin, a sub-Saharan country located in the west Africa. The population of Benin lives mostly in rural areas. In Figure 6.3 are presented different types of houses presented on the rural areas of Benin, specifically at Dekin.

Dekin is located at 6.5°N , with a global horizontal irradiation of 1748 kWh/m^2 per year (World Bank Group, 2018); due to its position close to the equator line, the solar potential of Dekin is useful to a solar energy installation. An average consumption of a rural house is determined by a load of 7 lamps, radio, mobile charger, TV, fridge, fan, iron machine and a DVD player (Semassou, 2011).



Figure 6.3: Types of rural houses on Benin. Taken from (Semassou, 2011)

Several authors have addressed to the development of SAPVS for developing countries. Specifically for the case of Colombia, Arias-Rosales and Mejía-Gutiérrez (2018) develop a SAPVS for the rural zone of San Vicente, Colombia¹. In this work it was intended to maximise the energy generation without the cost of an automatic tracking system. For that reason it was developed the design of of a SAPVS by the implementation V-Trough PV concentrators (Arias-Rosales and Mejía-Gutiérrez, 2018).

This kind of projects represented the cornerstone of forthcoming projects is PV energy generation at Colombia and the Design Engineering Research Group. As a matter of fact, the Research Group is actually working several national projects², which are centred in taking advantage of the country's energy potential. In this matter, it is important to recall the geographical position of the country, in the tropics with a high potential of solar energy generation.

Going back to the point of the SAPVS, this kind projects can be understood as a resource allocation problem: it is necessary to calculate the optimal quantity of PV modules and batteries in order to fulfil the specific load.

The optimisation model proposed by Semassou (2011) implemented an OIA³ approach (Sebastian et al., 2010; Quirante, 2012; Collignan, 2012), complemented with genetic algorithms. These process permitted to define an objective function, which for this case, is composed by three decision criteria: economic viability, environmental viability and service provided.

The optimisation model implemented a weighting model that allows to categorise the different design objectives according to an importance defined by experts. This process allowed to set a hierarchy for the different design objectives. Later, the objective function was sorted in descending order regarding the different combination solutions, where 3840 candidate solutions

¹Rural area in the department of Antioquia, located at 6.25°N with a global horizontal irradiation of 1964 kWh/m²(World Bank Group, 2018). It is important to recall that this rural area is not connected to the grid

²"*Colombia Científica*", national Government program with projects related to Energy-Sustainable Construction and Sustainable Mobility

³Observation-Interpretation-Aggregation

were evaluated. This process allowed to transform the multi-objective optimisation problem into a mono objective optimisation, focusing the efforts on the global desirability function (Semassou, 2011).

This problem was modelled as a multidisciplinary problem, composed by four elements:

- A PV module, that transforms the solar energy into electric energy.
- An inverter that transform the generated direct current (DC), output from the PV module, into alternating current (AC)
- A rack of batteries for stocking the electric energy.
- A set of cables that transmit the energy between the elements.

6.2. Exploratory interactive design: SAPVS case study system

6.2.1. Task clarification stage for SAPVS design

The first stage requires to transform Customer Requirements into the Properties list. Interpreting the problem described by Semassou (2011) allows to identify the information that can be defined as the Customer Requirements list, which is the input of the proposed methodology. For the design of the SAPVS three Customer Requirements are established:

- Guarantee an economic viability [CR_1]
- Guarantee a service provided to the consumer [CR_2]
- Guarantee a small impact on the environment [CR_3]

Based on these Customer Requirements the EFA will be performed as described in Section §4.1. This EFA method will define the functions that the SAPVS must accomplish and from those functions, the Properties list can be established.

6.2.1.1. EFA: Guarantee an economic viability

Since the implementation of the SAPVS is focused on developing country applications, the economic viability (CR_1) plays an important role. For this reason, the declared functions must seek the fulfilment of this economic constraint. In Figure 6.4 it can be observed the EFA related to this requirement. The analysis of this Figure determines several functions, from those functions

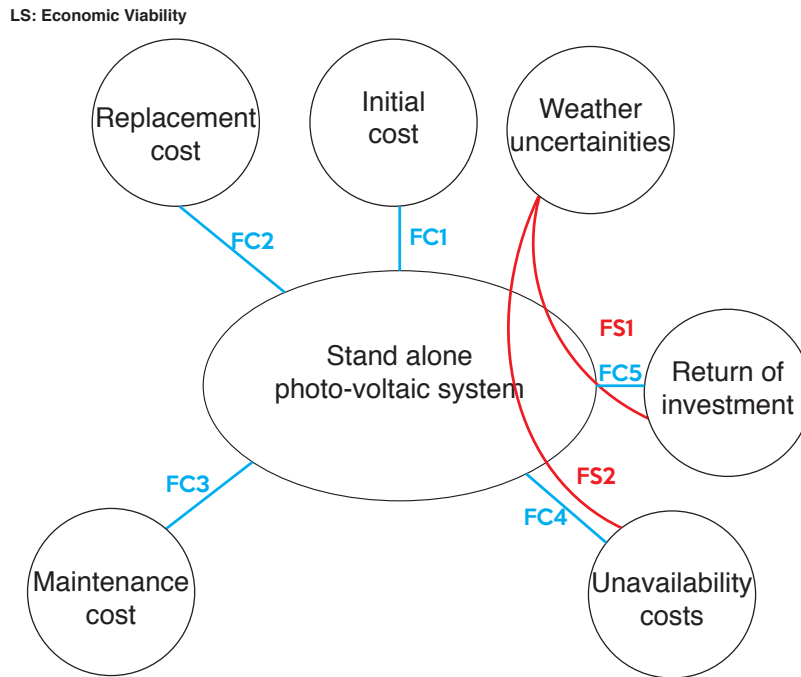

Figure 6.4: EFA for economic viability

three of them are going to be analysed in this subsection to clarify the approach and the others are explained in detail in Appendix D.1.

- FC_1 : The system must have a low initial investment cost
- FC_5 : The system must have a short internal rate of return
- FS_1 : The costs due to weather uncertainties should be low

As these functions are defined to guarantee an economic viability, it is necessary to define the limits for each function. Later, those limits will be assigned to each Property (see Section §6.2.1.2) and based on those values, the desirability functions for each Property may be defined.

- As FC_1 is related to considerable investments for the SAPVS building, the selection of the PV modules, batteries, inverter and cables technologies play an important role. The upper limit to these investments should be set on 5000 € (Semassou, 2011).
- FC_5 is related to the internal rate of return of the project. For this kind of projects, the lifespan is defined as 20 years, constrained by PV module's lifespan.
- Finally, FS_2 is related to the weather uncertainties and its effects on a reduced electricity

generation⁴

The definition of the complementing functions related to CR_1 , as well as the analysis of CR_2 and CR_3 is explained in detail in the Appendix D.1, D.1 and D.1 respectively. For the whole set of functions, it is intended to create a list of Properties with a defined range of variation. This list can be seen in the definition of the PDS in Table 6.1.

6.2.1.2. Outputs from the task clarification stage

The EFA allows to understand the behaviour of the system by establishing functions that are focused in fulfilling the Customer Requirements. By the analysis of these Customer Requirements list, the objectives of the design can be summarised in three: reduce the investments costs, reduce the outage possibility and reduce the environmental impact. Based on this, and the PDS can be written down by the interpretation of the functions into Properties. Table 6.1 refers to the PDS of the SAPVS.

Table 6.1: Product Design Specifications of SAPV system

Fn	Description	Acceptance criteria	Acceptance limit	μ function
FC_1	Pr_1 -Initial investment cost	$CoI < 5000 \text{ €}$	5000 €	$Z [100,5000]$
FC_2	Pr_2 -Component replacement cost	$CoR < 5000 \text{ €}$	5000 €	$Z [100,5000]$
FC_3	Pr_3 -Maintenance and repair costs	$CoMR < 100 \text{ €}$	100 €	$Z [0,100]$
FC_4	Pr_4 -System unavailability cost	$NPC_{loss} < 100,000 \text{ €}$	100,000 €	$Z [0-100000]$
FC_5	Pr_5 -Return on investment time	$TRI < 20 \text{ years}$	20 years	$Z [2,20]$
FC_6	Pr_6 -Energy outage rate	$LPSP < 20\%$	20%	$Pi [0.01,0.02,0.19,0.20]$
FC_7	Pr_7 -Temporal outage rate	$LLP < 20\%$	20%	$Pi [0.01,0.02,0.19,0.20]$
FC_8	Pr_8 -Environmental impact indicator	$C_{dom} < 10 \text{ €}$	10 €	$Z [0,10]$
FC_9	Pr_9 -Energy Return Time	$TRE < 20 \text{ years}$	20 years	$Z [3,20]$
FC_{10}	Pr_{10} -Emission of CO ₂	$GES < 10E8g$	10E8g	$Z [10E6,10E8]$
FS_1	Pr_{11} -System unavailability sensitivity	$SNPC_{loss} < 20 \text{ €}$	20 €	$Z [0,100]$
FS_2	Pr_{12} -Return on investment sensitivity	$STRI < 10 \text{ years}$	10 years	$Z [0,10]$
FS_3	Pr_{13} -Energy outage rate sensitivity	$SLPSP < 3\%$	3%	$Z [0,0.03]$
FS_4	Pr_{14} -Temporal outage rate sensitivity	$SLLP < 3\%$	3%	$Z [0,0.03]$
FS_5	Pr_{15} -Energy Return sensitivity	$STRE < 10 \text{ years}$	10 years	$Z [0,10]$
FS_6	Pr_{16} -CO ₂ emission sensitivity	$SGES < 100g$	100g	$Z [0,100]$

⁴An increase of the temperature reduces the efficiency of the PV modules, producing less energy. Also the presence of clouds, rain, or another element that blocks the sun's rays, will reduce the amount of energy produced.

Since the objective of the design is to minimise the Properties values, the most of Properties are interpreted with Z membership functions. This represents that the lower the value, the better. Only in two Properties another type of membership function is evaluated: For *LPSP* and *LLP* are considered pi functions. On these two Properties, high or low values represent that the SAPVS is either oversized or will not be able to deliver the energy demand. The definition of the type of desirability function for each Property can be also observed in Table 6.1. Also in Figure 6.5 can be watched the desirability functions of some Properties.

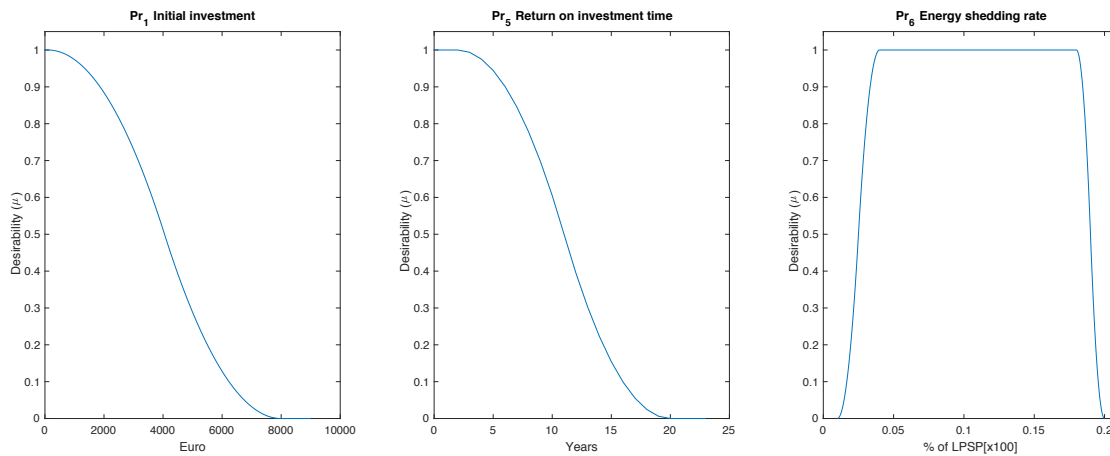

Figure 6.5: Desirability of certain Properties

Regarding the traceability framework (As explained in Section §4.1), the result from this design stage is to establish connections among Customer Requirements and Properties. The connection between these two layers is supported with the QFD analysis, specifically, with the correlation matrix. In Table 6.2, it can be observed the extract of the QFD correlation matrix, that enables to build tracelinks between *CR* and *Pr*, necessary for the construction of the traceability framework in Figure 6.6).

Table 6.2: Customer Requirements to Properties for the SAPVS design case

	<i>Pr</i> ₁ - <i>CoI</i>	<i>Pr</i> ₂ - <i>CoR</i>	<i>Pr</i> ₃ - <i>CoMR</i>	<i>Pr</i> ₄ - <i>NPC</i>	<i>Pr</i> ₅ - <i>TRI</i>	<i>Pr</i> ₆ - <i>LPSP</i>	<i>Pr</i> ₇ - <i>LLP</i>	<i>Pr</i> ₈ - <i>C_{dom}</i>	<i>Pr</i> ₉ - <i>TRE</i>	<i>Pr</i> ₁₀ - <i>GES</i>	<i>Pr</i> ₁₁ - <i>SNPC</i>	<i>Pr</i> ₁₂ - <i>STRI</i>	<i>Pr</i> ₁₃ - <i>SLPSP</i>	<i>Pr</i> ₁₄ - <i>SLLP</i>	<i>Pr</i> ₁₅ - <i>STRE</i>	<i>Pr</i> ₁₆ - <i>SGES</i>
<i>CR</i> ₁	●	●	●	●	●						●	●				
<i>CR</i> ₂						●	●						●	●		
<i>CR</i> ₃								●	●	●					●	●

The definition of the EFA allow to define the Properties of the design. Also, the use of the QFD, the traceability framework will allow to make connections among these Properties with

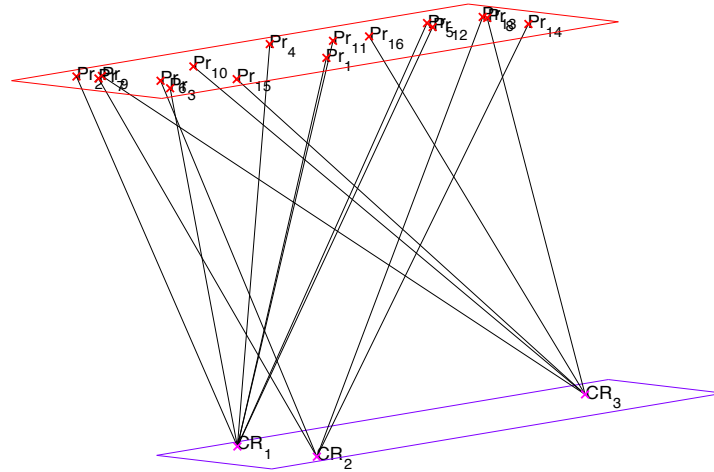

Figure 6.6: Traceability framework: CR to Pr

linguistic variables. Likewise, the EFA allows to define a flexibility framework with the introduction of the desirability functions to each of the Properties. Later in the design, the performance of the solutions will be measured by the evaluation of the results using these desirability functions. The next step in the methodology is the development of the IFA, which is addressed in the next subsection.

6.2.2. Conceptual design: implementation of CPM/PDD for SAPVS design

The conceptual design stage is based in the physical understanding of each of the Properties, where the equations that describe the phenomena are described. In the proposed methodological approach it is used the FBS+CPM proposed by Malmiry (2016) for the IFA (As described in Section §4.1).

Let's consider the first Property (Pr_1) from the PDS, which is CoI . This Property, as seen in Figure 6.6, has influence in the economic viability CR_1 . This costs is related to the up-front purchases of the SAPVS elements for its installation. That is to say, this cost (CoI) is defined by the purchases value of the PV modules, batteries, inverter and cables. This relation is defined by the Equation 6.1.

$$CoI = CoI_{panel} + CoI_{bat} + CoI_{ond} + CI_{ond} + CoI_{cable} \quad (6.1)$$

Where,

CoI_{panel}	Initial investment cost of the PV modules
CoI_{bat}	Initial investment cost of the batteries
CoI_{ond}	Initial investment cost of the inverter
CoI_{cable}	Initial investment cost of the cables

In the Figure 6.7, and according to the methodology (Section §4.1), is presented the FBS and its connection to the CPM. As shown in Figure 6.2, the system is composed by a set of modules that are connected to cable box, from the cable box to the inverter in order to transform the current from DC to AC and finally connected to the batteries. This help to define the structure as well as the definition of the CPM, allowing to undermine each of the components of the system (PV module, batteries, inverter and cables). In this particular situation, six elements compose the system. In detail, those elements can be described more in detail with the following Characteristics:

N_{PV}	Quantity of PV modules
T_{PV}	Type of PV module
$Cost_{PV}$	Cost of PV module [€/W]
N_{bat}	Quantity of batteries
T_{bat}	Type of battery
$Cost_{bat}$	Cost of battery [€/Wh]
P_{ond}	Power of the inverter
$Cost_{ond}$	Cost of the inverter [€/VA]
L_{PV2bor}	Length of cable between PV and connection box [m]
$L_{bor2ond}$	Length of cable between connection box and inverter [m]
$L_{ond2bat}$	Length of cable between inverter and batteries [m]
T_{cable1}	Type of cable between PV and connection box [m]
T_{cable2}	Type of cable between connection box and inverter [m]
T_{cable3}	Type of cable between inverter and batteries [m]

For determining the Characteristic list it is necessary to define as many as sub-relations can have the behaviours in order to define the list of the independent variables. Them with the use of the CPM, Characteristics can be arranged with sub-relations and then with Relations. Following the defined structure from Figure 6.7, the sub-relations that serves as inputs are:

$$CoI_{panel} = N_{PV} * T_{PV} * Cost_{PV} \quad (6.2)$$

$$CoI_{bat} = N_{bat} * T_{bat} * Cost_{bat} \quad (6.3)$$

$$CoI_{ond} = P_{ond} * Cost_{ond} \quad (6.4)$$

$$CoI_{cable} = (L_{PV2bor} * T_{cable1}) + (L_{bor2ond} * T_{cable2}) * (L_{ond2bat} * T_{cable3}) \quad (6.5)$$

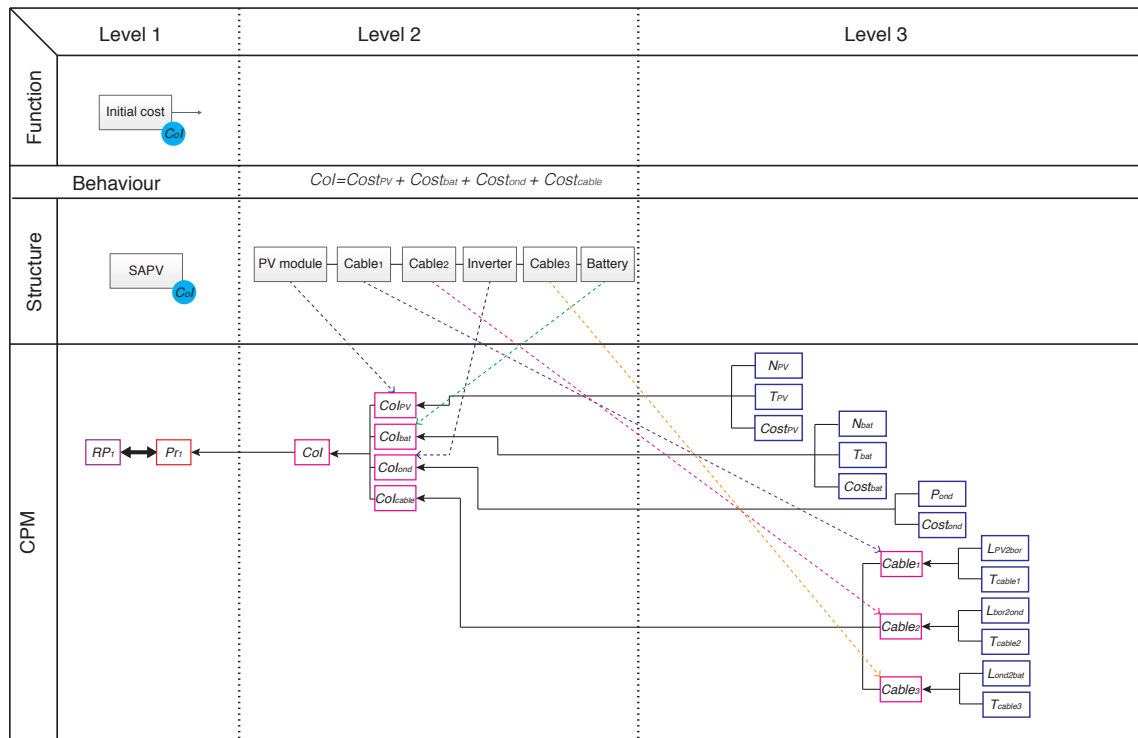

Figure 6.7: FBS + CPM for Pr_1 - cost of investment (CoI)

Finally, in order to expand the understanding of the problem, the whole set of variables (dependent and independent) can be identified as shown in Table 6.3, that clarifies the set of Properties, Relations, Characteristics and External Conditions in this case for Pr_1 .

Table 6.3: Variables related to Pr_1 : Initial investment cost

List of Properties	List of Relations	List of Characteristics	List of External Conditions
CoI	$CoI_{panel}, CoI_{bat}, CoI_{ond}, CoI_{cable}$	$N_{PV}, T_{PV}, Cost_{PV}, N_{bat}, T_{bat}, Cost_{PV}, P_{ond}, Cost_{ond}, LPV_{2bor}, L_{bor2ond}, L_{ond2bat}, T_{cable1}, T_{cable2}, T_{cable3}$	

This execution of the IFA must be repeated for each of the 16 defined Properties. The detail of this procedure is documented in Appendix E. This implementation results in a model composed by:

- 3 Customer Requirements
- 16 Properties

- 38 Relations and sub-relations
- 36 Characteristics
- 11 External Conditions

For managing this information, it is proposed to use the traceability framework (Section §4.1), which is able to store different layers of information in a traceability tree structure. In Figure 6.8 is presented the tree for the SAPVS design.

6.2.3. Embodiment design: Definition of preliminary layout

The embodiment design is composed by two activities: the develop of the solution (Section §6.2.3.1) and the amelioration of the solution (Section §6.2.3.2). The objective of the first activities is to understand the problem's Characteristics in order to develop the first solution, called the "*Preliminary layout*". This first solution not always produce the better desirability, whereby, it is proposed an interactive approach for ameliorating the solution. Consequently, subsection §6.2.3.2 describes an exploratory approach and, later, in Section §6.3 the pre-sizing method (Proposed in Section §5.1) is implemented.

6.2.3.1. Systematic development of a possible solution

Even if the size of the problem is considerable (36 Characteristics), many of these independent variables might be easily fixed, given the modelling of the problem, especially, those that are inherited according to the type of component (type of PV module, of battery, etc.). Among Characteristics, three categories can be defined: discrete, 2-values discrete and fixed. The discrete variables are those that can be described as integers, e.g., the quantity of PV modules. The 2-value discrete variables are those that can take two values, e.g., the capacity of the battery can be 75 Ah or 100 Ah. The fixed variables are those that according to the definition of the type of component, they have a unique value. In other words, these Characteristics are fixed by the designer. For example, the life-span of a PV module is 20 years. Since the type of PV module was selected, the life-span is a inherited Characteristic from this selection.

In order to define the preliminary layout, it is important to define the variation ranges of each Characteristics. Considering that the SAPVS system is composed by different systems, the problem will be addressed sub-system by sub-system.

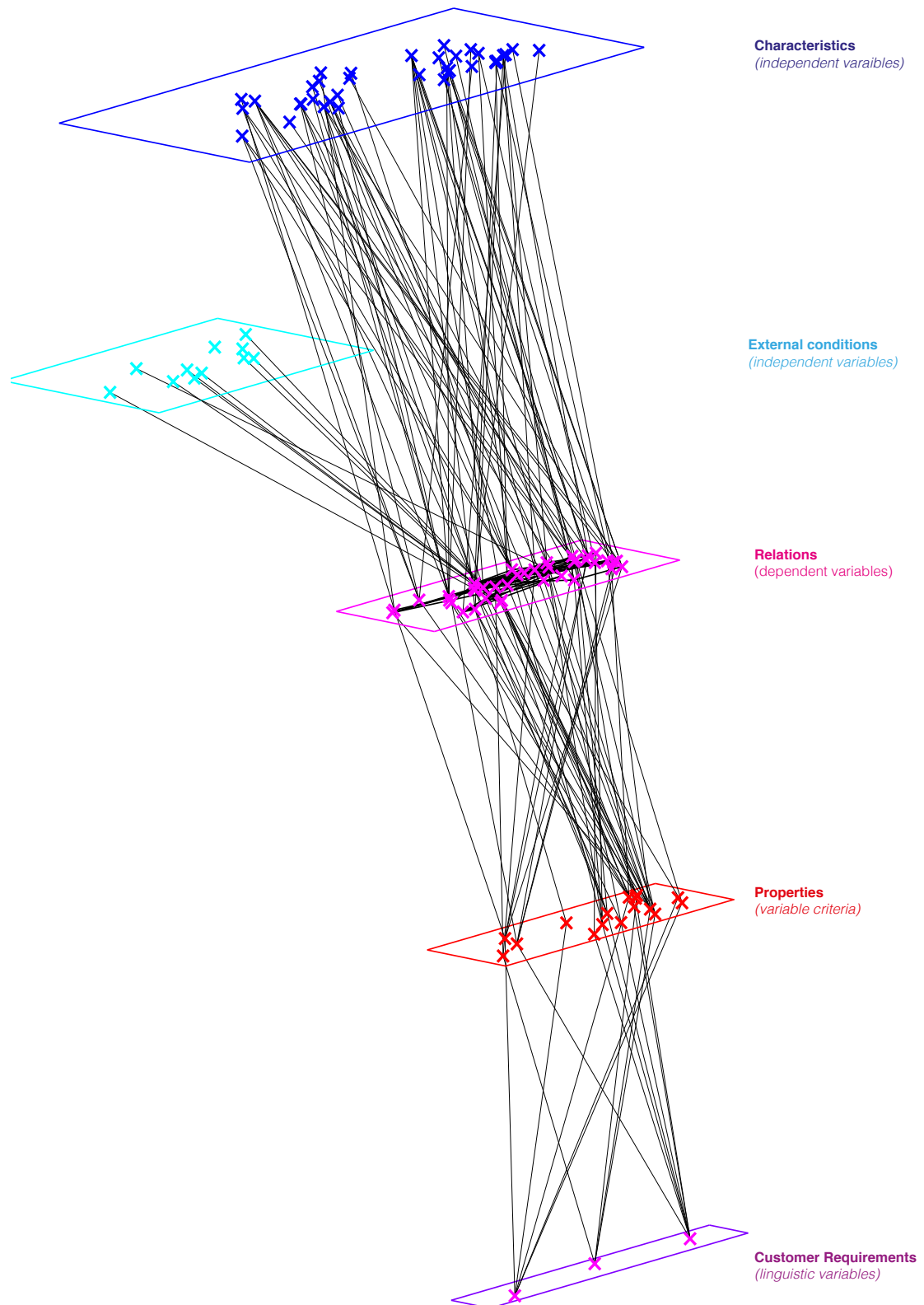

Figure 6.8: Traceability tree of a SAPVS design

Analysis of the Characteristics of each sub-system: PV module example

The PV module definition is related directly to seven Characteristics. Among these Characteristics, the type of PV module (T_{PV}) and the quantity of PV modules (N_{PV}) vary. In Figure 6.3 is presented the different houses in the rural area of Benin. Due to the roof structure, the size of the PV modules is limited. For this reason, T_{bat} is limited to 50 W and 80 W in order to fit the roof restrictions.

Regarding the complementing Characteristics related these remain fixed, since they are related to the type of PV module. The definition of the variables related to the PV modules is presented in Table 6.4.

Table 6.4: Variables related to the PV module

Characteristic	Type	Value
N_{PV}	Discrete	[1-12]
T_{PV}	2-value discrete	50 W or 80 W
$Cost_{PV}$	Fixed	4 €/Wh (Thiaux, 2010)
$years_{PV}$	Fixed	20 years
MMT_{PV}	Fixed	0 (Nema et al., 2010)
$Index_{energy-PV}$	Fixed	9.73 kWh/W
$Index_{GES-PV}$	Fixed	1.65 Kg CO ₂ /Wh

*All references values from (Semassou, 2011), except when indicated.

Regarding the analysis of batteries, inverter, cables Characteristics, its analysis is documented in Appendix F.1, F.2 and F.3, respectively. Also, the analysis of the External Conditions can be observed in Appendix F.4. Likewise, in Figure 6.9 is presented the connections among two Characteristics (quantity of PV modules N_{PV} and quantity of batteries N_{bat}) and the Properties that they make part.

Preliminary layout definition

In general terms, the design problem is composed by 7 Characteristics that are subject to variations: $N_{PV}, N_{bat}, T_{PV}, T_{bat}, T_{cable1}, T_{cable2}, T_{cable3}$. Among these Characteristics, two are discrete variables, while the others are 2-value discrete. In order to perform the SA, it is necessary to define the intervals of variation and distribution preference (See Section §4.2.1 for definition of inputs of the SA). The intervals and its preference is defined as:

- Quantity of PV module (N_{PV}) varies between [1-12] and it desired a low distribution, seeking for a balance between energy generation and costs.

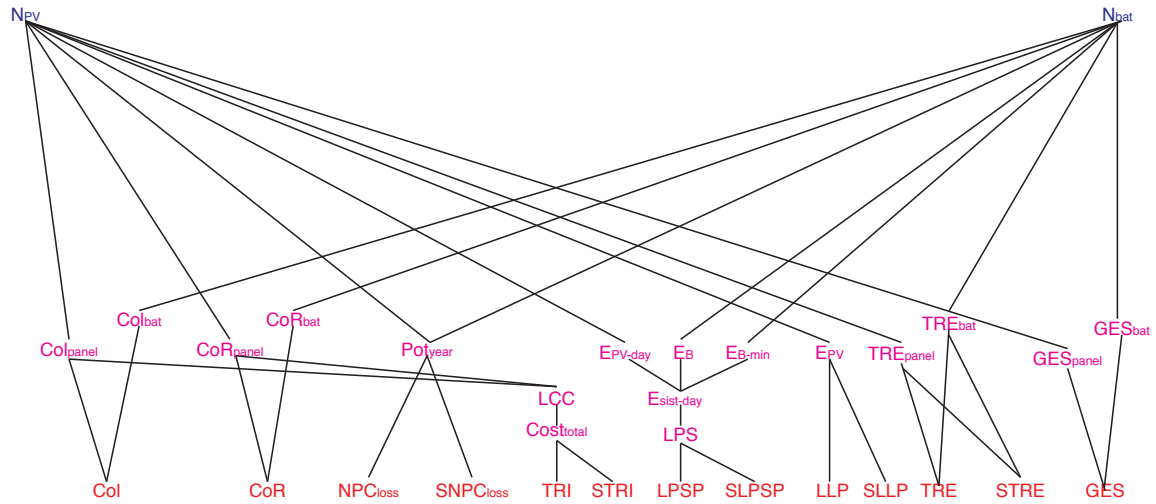

Figure 6.9: Connections between Properties with N_{PV} and N_{bat}

- Quantity of batteries (N_{bat}) varies between [1-10] and it desired a high distribution, seeking for a balance between energy stocked and costs.
- Type of PV modules (T_{PV}) is desired a low distribution in order to keep the cost low.
- Type of battery (T_{bat}) is desired a low distribution in order to keep the cost low.
- For cross-section of cable 1 (T_{cable1}) is desired a low distribution in order to keep the cost low.
- Cross-section of cable 2 (T_{cable2}) is desired a low distribution in order to keep the cost low.
- Cross-section of cable 3 (T_{cable3}) is desired a low distribution in order to keep the cost low.

The preliminary layout DSC_0 (as defined in Chapter 5) is defined in table 6.5, with the values calculated form the Monte Carlo simulation for discrete variables and the selected 2-value discrete values.

With the Characteristics from DSC_0 , Properties can be calculated as shown in Table 6.6. With this solution, the aggregated desirability of the Properties is equal to zero. $Agg.\mu(Pr)$ could not get a positive desirability because there were two Properties with null desirability, which are $LPSP$ and LLP , those related to the service provided to the consumer.

6.2.3.2. Exploration of solutions: manually amelioration of the solution

Since the preliminary layout does not produce an acceptable solution, it is intended to explore solutions using the equalisers that empowers the understanding among Properties and Charac-

Table 6.5: Values of the preliminary layout: DCS_0

Characteristic	Simulation parameters	Monte Carlo mean	Defined Value
N_{PV}	[1-12], <i>low</i>	3.507	4
T_{PV}	[50-80], <i>low</i>	55.3644	50 W
N_{bat}	[1-10], <i>low</i>	2.73	3
T_{bat}	[75-100], <i>low</i>	79.92	75 Ah
T_{Cable1}	[0.45-0.55], <i>low</i>	0.4716	0.45 mm ²
T_{Cable2}	[4.84-12.88], <i>low</i>	6.559	4.84 mm ²
T_{Cable3}	[3.03-4.84], <i>low</i>	3.4093	3.03 mm ²

Table 6.6: Properties desirability on Preliminary layout

Pr	Property	Value	$\mu(Pr_j)$
Pr_1	CoI : Initial investment cost	2370 €	0.5706
Pr_2	CoR : Component replacement cost	2327 €	0.5869
Pr_3	$CoMR$: Maintenance and repair costs	35 €	0.7550
Pr_4	NPC_{loss} : Cost related to the unavailability of the system	547.5 €	1.00
Pr_5	TRI : Return on investment time	3.1 years	0.9872
Pr_6	$LPSP$: Energy outage rate	64.62%	0.000
Pr_7	LLP : Temporal outage rate	63.93%	0.000
Pr_8	C_{dom} : Environmental impact indicator	3.2 €	0.7896
Pr_9	TRE : Energy Return Time	8.8 years	0.7669
Pr_{10}	GES : Emission of CO ₂	30854 g	1.00
Pr_{11}	$SNPC_{loss}$: Sensitivity of the unavailability of the system	6.8 €	0.9906
Pr_{12}	STR : Sensitivity of return on investment time	0 years	1.00
Pr_{13}	$SLPSP$: Sensitivity of energy outage rate	0.4057%	0.80
Pr_{14}	$SLLP$: Sensitivity of temporal outage rate	0.4508%	0.70
Pr_{15}	$STRE$: Sensitivity of energy Return Time	0.1 years	0.9998
Pr_{16}	$SGES$: Sensitivity of emission of CO ₂	0g	1.0
	Aggregated Desirability of Properties $Agg.\mu(Pr)$		0.0000

teristics, as proposed in Section §4.3. Figure 6.10 shows the equalisers for quantity of batteries (N_{bat}).

With DCS_0 configuration, none of the possible values of N_{bat} will produce a positive $Agg.\mu(Pr)$. This can be visually observed on the red bar at the left of the equaliser of Figure 6.10. Still, the same behaviour occurs on the other Characteristics, leading to an scenario of trial and error in order to seek a better solution. For instance, if the quantity of batteries increases, the values of the other equalisers will vary. By trial and error, defining $N_{bat} = 6$, will increase the energy storing capacity of the SAPV system, nevertheless, will not produce a desirable solution yet.

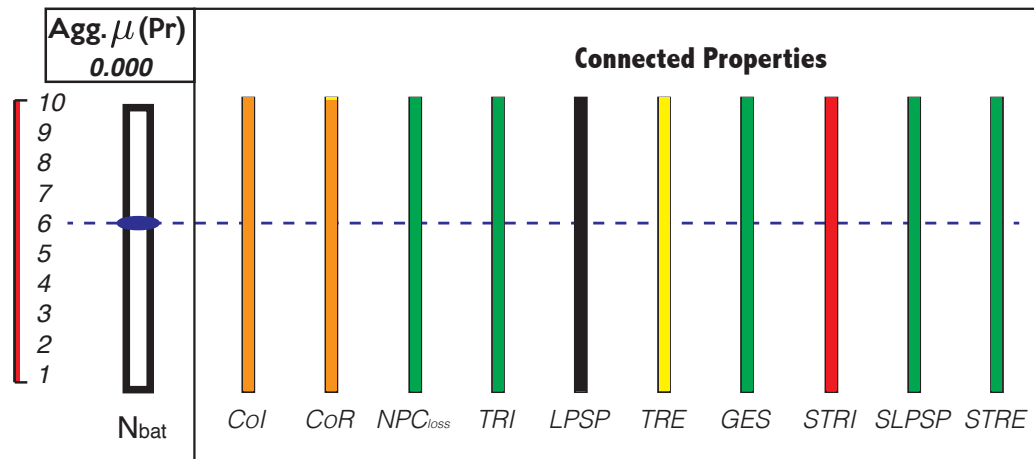

Figure 6.10: Equaliser of the quantity of batteries (N_{bat}) after DCS_0

Even with this modification, this solution 2 does not produce a positive $Agg.\mu(Pr)$. Considering a different Characteristic, the overview might be different. For example, considering the quantity of modules. In Figure 6.11 is presented the equaliser for the quantity of PV modules N_{PV} .

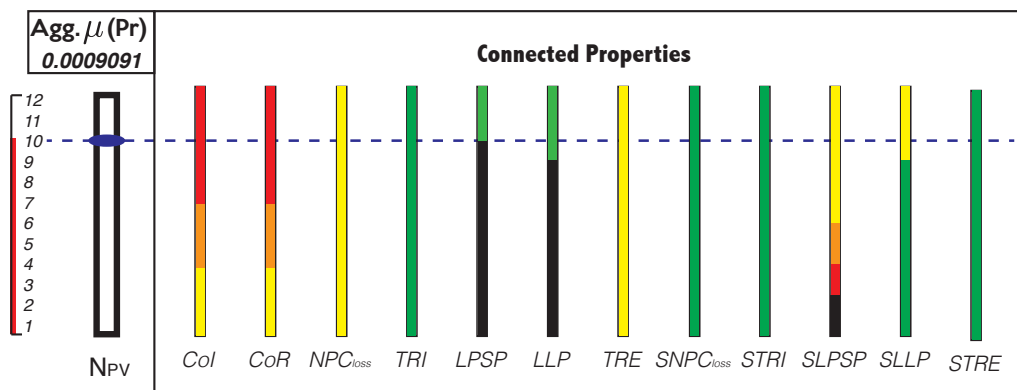

Figure 6.11: Equaliser of the quantity of PV modules (N_{PV}) after DCS_0 modified

With the modifications of $N_{bat} = 6$ and using the equaliser of quantity of PV modules $N_{PV} = 10$ from Figure 6.11, the overview of the design is different. Defining $N_{PV} = 10$, a new solution can be calculated. With the new combination of quantity of PV modules and batteries, a solution 3 can be obtained. At this time an $Agg.\mu(Pr)$ positive is found. Table 6.7 shows the values of the Properties and its desirability, for each explored solution.

From Table 6.7, it can be observed that a manual approach could be used in order to get solutions with a positive desirability $Agg.\mu(Pr)$. Nevertheless, the time to get to a solution

Table 6.7: Properties desirability evolution on exploratory approach

Property	P.Layout		Solution ₂		Solution ₃	
	Value	μ	Value	μ	Value	μ
Pr ₁ -CoI	2370	0.5706	2386.2	0.5646	3577.2	0.1686
Pr ₂ -CoR	2327	0.5869	2390	0.5632	3554	0.1742
Pr ₃ -CoMR	35	0.7550	35	0.7550	35	0.7550
Pr ₄ -NPC	547.5	1.00	547.5	1.00	1368.8	0.9996
Pr ₅ -TRI	3.1	0.9872	3.1	0.9872	2.5	0.9982
Pr ₆ -LPSP	64.62%	0.000	57.80%	0.000	13.02%	1.00
Pr ₇ -LLP	63.93%	0.000	63.93%	0.000	9.84%	1.00
Pr ₈ -C _{dom}	3.2	0.7896	3.2	0.7896	3.2	0.7896
Pr ₉ -TRE	8.8	0.7669	8.8	0.7669	3.5	0.9981
Pr ₁₀ -GES	30854	1.00	32880	1.00	31728	1.00
Pr ₁₁ -SNPC	6.8	0.9906	6.8	0.9906	17.1	0.9906
Pr ₁₂ -STRI	0	1.00	0	1.00	0	1.00
Pr ₁₃ -SLPSP	0.4057%	0.80	0.4057%	0.80	1.014%	0.7714
Pr ₁₄ -SLLP	0.4508%	0.70	0.4508%	0.70	1.012%	0.7178
Pr ₁₅ -STRE	0.1	0.9998	0.1	0.9998	0	0.9998
Pr ₁₆ -SGES	0	1.00	0	1.00	0	1.00
Agg. μ (Pr)		0.000		0.000		0.0009091

might be long and it does not assure reaching a solution that maximises the GDI. Consequently, it is necessary to use the proposed pre-sizing method in order to calculate a better solution (As proposed in Chapter 5). Likewise, in Table 6.8 it can be observed the values for each Characteristic.

Table 6.8: Values of the Characteristic on exploratory mode

Solution	N_{PV}	T_{PV}	N_{bat}	T_{bat}	T_{Cable1}	T_{Cable2}	T_{Cable3}	Agg. μ (Pr)
P.layout	4	50 W	3	75 Ah	0.45 mm ²	4.84 mm ²	3.03 mm ²	0
Solution ₂	4	50 W	6	75 Ah	0.45 mm ²	4.84 mm ²	3.03 mm ²	0
Solution ₃	10	50 W	6	75 Ah	0.45 mm ²	4.84 mm ²	3.03 mm ²	0.0009091

6.3. Maximisation of Properties desirability using SSNV method

Based on the information modelled in Section §6.2, regarding to the EFA and IFA, the SSNV method can be executed. As it was analysed before, even if the problem has 36 Characteristics, only 7 vary, while the other 27 are fixed and 2 are repeated (T_{bat}' and P_{ond}').

In Section §6.2.3, it was defined the values for performing the Monte Carlo simulation for the

distributions of the Characteristics. Based on those values the SA⁵ can be performed. In Table 6.9 it can be seen the results of the GSA.

Table 6.9: Global sensitivity analysis of SAPV system

	N_{PV}	T_{PV}	N_{bat}	T_{bat}	T_{cable1}	T_{cable2}	T_{cable3}
Pr_1-CoI	0.9979	0.9006	0.0865	0.0123	0.0083	0.4361	0.0634
Pr_2-CoR	0.9979	0.9006	0.3944	0.046	0.0041	0.0055	0.0219
Pr_3-CoMR							
Pr_4-NPC	0.9979	0.9006	-0.0273	0.001	0.0043	0.0057	0.0219
Pr_5-TRI	-0.8528	-0.2228	0.021	-0.0081	0.0081	0.0077	0.0142
Pr_6-LPSP	-0.9979	-0.9006	-0.6588	-0.0725			
Pr_7-LLP	-0.9979	-0.9006					
Pr_8-C_{dom}		1					
Pr_9-TRE	-0.85	-0.2167	0.2879	0.0259			
Pr_{10-GES}	0.9979	0.9006	-0.0273	-0.027			
$Pr_{11-SNPC}$	0.9979	0.9006	-0.0273	0.001	0.0043	0.0057	0.0219
$Pr_{12-STRI}$	-0.8528	-0.2228	0.021	-0.0081	0.0081	0.0077	0.0142
$Pr_{13-SLPSP}$	0.9979	0.9006	-0.0273	-0.027			
$Pr_{14-SLLP}$	0.9979	0.9006					
$Pr_{15-STRE}$	-0.85	-0.2167	0.2879	0.0259			
$Pr_{16-SGES}$							
ζ	12.3867	9.9844	1.8667	0.2548	0.0372	0.4684	0.1575

In the bottom row of the Table 6.9 it is presented the ζ index for the Characteristics. This index represents which is the overall influence of the Characteristics on the design. In this case, the most influencer Characteristic is N_{PV} , with a $\zeta_{N_{PV}} = 12.39$. The second is T_{PV} with $\zeta_{T_{PV}} = 9.98$ and the third is N_{bat} with a $\zeta_{N_{bat}} = 1.86$, which is as five times smaller than the type of the PV module.

Yet, due to the fact that it is a 2-value discrete variable, it reduces the possibilities of modifying the design. With the ζ values of the Characteristics, the iteration loop for the iterative algorithm can be defined as:

$$\vec{\zeta}_{loop} = [N_{PV}, T_{PV}, N_{bat}, T_{cable2}, T_{bat}, T_{cable1}, T_{cable3}]$$

The GSA results allow to calculate the χ index, which evaluates how "attached" is each Property. It is found that $LPSP$ is the most complex Property. Also, it is found that $CoMR$ and

⁵The SA technique implemented was the Partial Rank Correlation Coefficient (PRCC). See §4.2 for detailed explanation

SGES do not have complexity (since its Characteristics are already fixed). Still, nine Properties are as complex as *LPSP* to solve. This indicates the levels of attachments within the design. In Table 6.10 these indices can be observed.

Table 6.10: Complexity level of Properties χ of SAPVS design case

Property	χ index	Property	χ index
Pr_1-CoI	21.73180566	Pr_9-TRE	13.23633673
Pr_2-CoR	22.10676382	$Pr_{10}-GES$	21.41047908
Pr_3-CoMR	0	$Pr_{11}-SNPC$	21.41013337
Pr_4-NPC	21.41013337	$Pr_{12}-STRI$	12.83531116
Pr_5-TRI	12.83531116	$Pr_{13}-SLPSP$	21.41047908
Pr_6-LPSP	22.60089353	$Pr_{14}-SLLP$	21.35263857
Pr_7-LLP	21.35263857	$Pr_{15}-STRE$	13.23633673
Pr_8-C_{dom}	9.9844	$Pr_{16}-SGES$	0

Understanding the problem in terms of which Property would be the complex to define and which Characteristics is the most influencer, the SSNV method can be executed. A first run of the algorithm evidenced non-convexities on Pr_6-LPSP and Pr_7-LLP , which is represented by the singleton behaviour of these two Properties with the most influencer Characteristic (N_{PV}), as observed in Figure 6.12. In the Figure it can be observed that there is only solutions when $N_{PV} = 6$; other values for the Characteristics will determine in a undesirable solution. These interval where μ will be positive is the feasible region, that for this case, it is very tight.

The use of the iteration loop determines that the problem does not converge to a solution that maximises the GDI, because the algorithm is stagnated in the non-convexity. In Section §5.3.2.2 it was explained a mechanism to be implemented when the problem is non-convex. On convex problems, the solution mechanism is based in addressing first the most influencer Characteristic in order to develop *DCS* that empowers a desirability augmentation. Nevertheless, for non-convex problems the mechanism is different and it is centred in the convexification of the problem. The convexification approach is divided in two types:

1. When the non-convexity is presented on a Property that does not hold the whole set of Characteristics, it is proposed a "*Synthesis-Analysis*" approach.
2. When the non-convexity is presented on a Property that holds the whole set of Characteristics, the strategy is to invert the iteration loop. This enables a decrease the degrees of freedom in the problem by fixing the less influencer Characteristics first. This allow to reduce the quantity of variables of the problem.

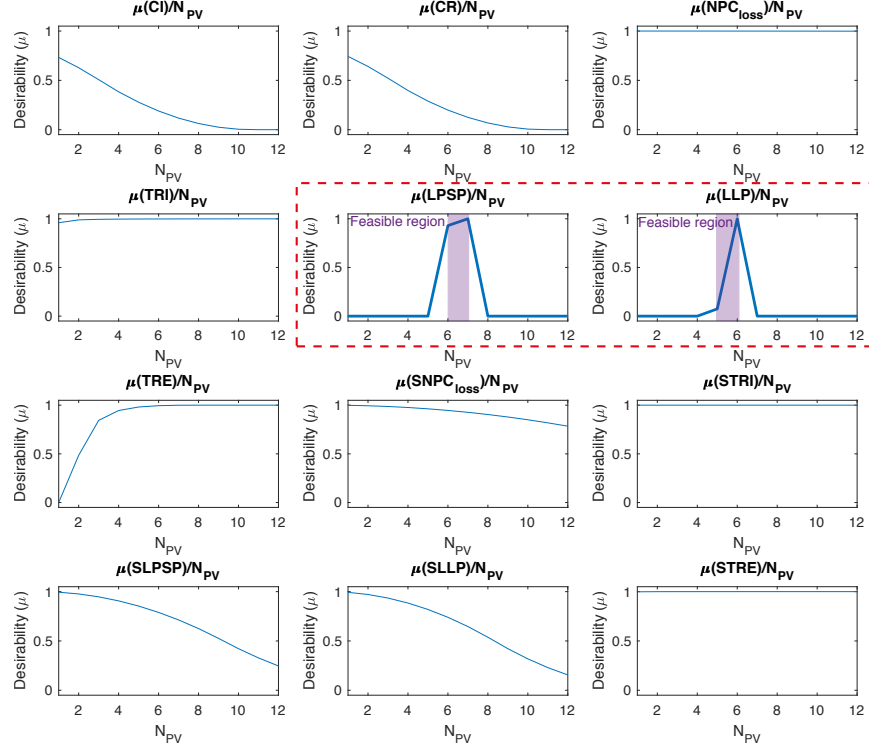

Figure 6.12: Evidence of non-convexities in the problem

The issues with these Properties, specially Pr_6 - $LPSP$, is that it is the Property with the higher χ index, besides to be related to almost the whole set of Characteristics. Consequently, the convexification is centred in inverting the iteration loop for tackling first the less influencer Characteristics, which, for this particular case, will be T_{cable3} (See Table 6.9). The new iteration loop is defined as:

$$\overrightarrow{\zeta}_{loop} = [T_{cable3}, T_{cable1}, T_{bat}, T_{cable2}, N_{bat}, T_{PV}, N_{PV}] \quad (6.6)$$

Using the modified iteration loop (Equation 6.6), the SSNV method is implemented in order to seek for a solution that maximises the GDI. This pre-sizing method will calculate the desirability of the Characteristics ($\mu_{(Ch_i)}$) by propagating the desirability functions from the Properties. The maximum value of the $\mu_{(Ch_i)}$ function will be defined as the new value. This process is performed in an iterative manner, arranging the iteration process using the modified iteration loop. Next subsection will explain the implementation of the method.

6.3.1. Implementation of the pre-sizing method

The proposed pre-sizing method (See Section §5.1) is an iterative approach for finding *DCS* that maximises the aggregated desirability of the Properties. This method is centred in following this procedure:

- (I) Propagating the Properties' desirability to the Characteristics' desirability
- (II) Calculating the Characteristics' desirability as the aggregation of the $\mu(Pr/Ch_i)$
- (III) Selecting the best Characteristic value by maximising $\mu(Ch_i)$
- (IV) Evaluating the GDI as the $Agg.\mu(Pr)$

This routine is calculated for each of the Characteristics following the iteration loop and evaluating at the end of each loop the error. When the error is steady, the solution is found. The following subsections analyse each of the iteration loops.

6.3.1.1. Loop 1 evaluation

The most important Characteristics in the SAPVS is the quantity of PV modules (N_{PV}), the PV module (T_{PV}) type and the quantity of batteries (N_{bat}).

Following the iteration loop from Equation 6.6, the analysis begins with T_{cable3} , followed by T_{cable2} . However, its explanation in detail will be pass over. The third Characteristic in the iteration loop is the evaluation the type of batteries (T_{bat}). By the analysis of the CPM, this Characteristic makes part of eleven Properties: CoI , CoR , NPC_{loss} , TRI , $LPSP$, TRE , GES , $SNPC_{loss}$, $STRI$, $SLPSP$, $STRE$. . Understanding this, facilitates the propagation process, because it is only done performed where there exist direct connections $Pr \rightarrow Ch$.

For the loop 1, the $\mu(Pr/T_{bat})$ can be observed in Figure 6.13a, while the $\mu(T_{bat})$ is in Figure 6.13b. Analysing the desirabilities, it can be observed that there is a significant change on the behaviour of Pr_6-LPSP when the capacity of the battery is higher. This will determine a trend during modification of the value of T_{bat} , because a higher value will improve the solution.

Next, on the fifth iteration (According to Equation 6.6) is evaluated the quantity of batteries N_{bat} . This Characteristic is related to CoI , CoR , NPC_{loss} , TRI , $LPSP$, TRE , GES , $SNPC_{loss}$, $STRI$, $SLPSP$, $STRE$. The $\mu(Pr/N_{bat})$ can be observed in Figure 6.14a, while the $\mu(N_{bat})$ is in Figure 6.14b. Analysing these desirabilities it can be watched that, on the first loop, the algorithm was not able to reach a maximum for $\mu(N_{bat})$. Since no combination of batteries generated a positive value for $LPSP$, no further value of N_{bat} could be defined.

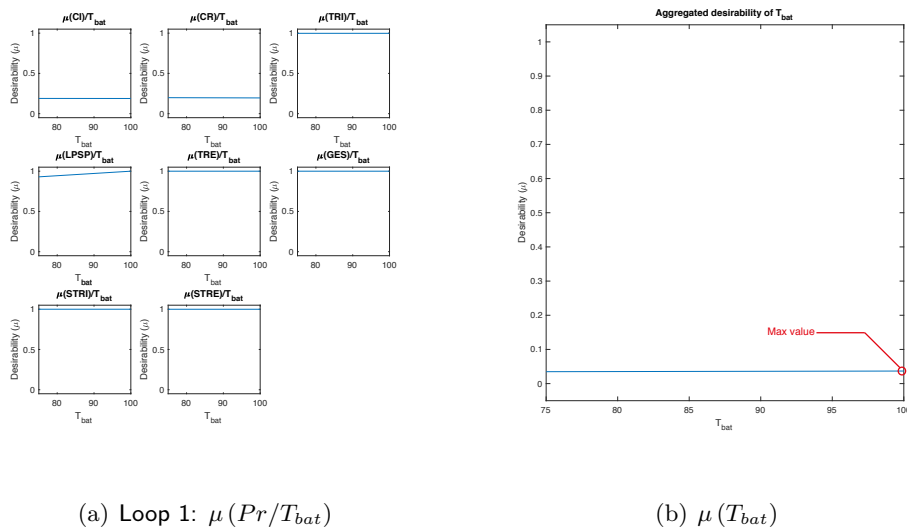

Figure 6.13: Desirability of T_{bat} in Loop 1

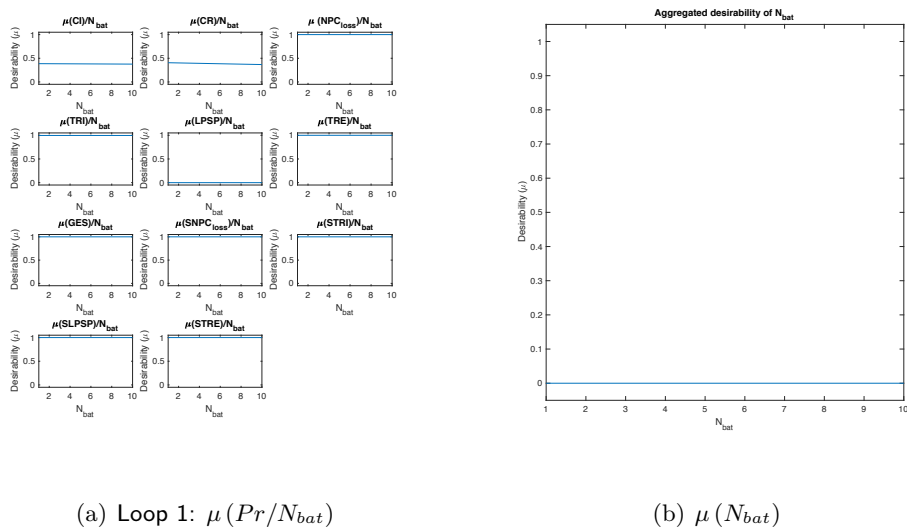

Figure 6.14: Desirability of N_{bat} in Loop 1

Next, on the sixth iteration (According to Equation 6.6) is evaluated the type of PV module T_{PV} and is the Characteristic with more connections, 14: CoI , CoR , NPC_{loss} , TRI , $LPSP$, LLP , C_{dom} , TRE , GES , $SNPC_{loss}$, $STRI$, $SLPSP$, $SLLP$, $STRE$.

The $\mu(Pr/T_{PV})$ can be observed in Figure 6.15a, while the $\mu(T_{PV})$ is in Figure 6.15b. It can be observed that the performance of the solution increases when the T_{bat} is bigger. The maximum value from the desirability value of the Characteristic is on the maximum value of its variation range: 80 W.

Finally, for N_{PV} the $\mu(Pr/N_{PV})$ can be seen in Figure 6.16a, while the $\mu(N_{PV})$ is in Figure

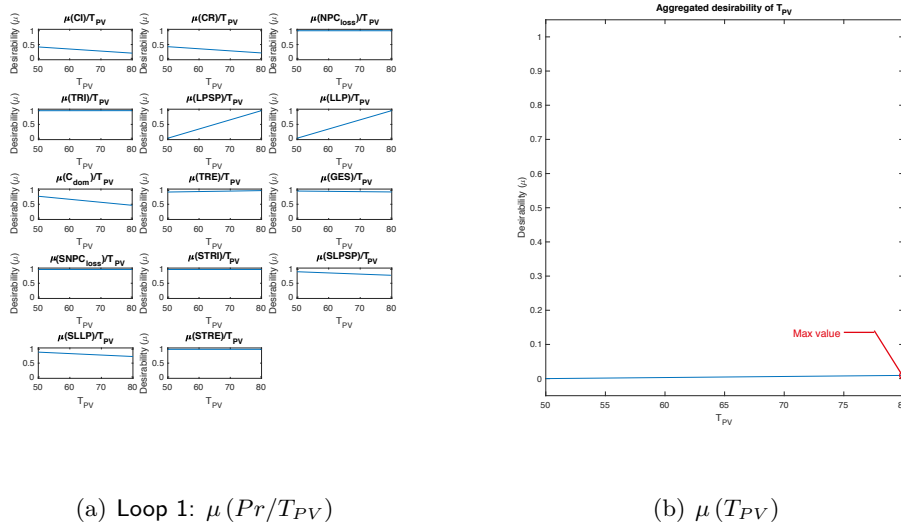

Figure 6.15: Desirability of T_{PV} in Loop 1

6.16b. This Characteristic is connected with 12 Properties: CoI , CoR , NPC_{loss} , TRI , $LPSP$, LLP , TRE , $SNPC_{loss}$, $STRI$, $SLPSP$, $SLLP$, $STRE$.

Analysing the results of calculation, for $\mu(N_{PV})$ a maximum can be desirabilities when $N_{PV} = 6$. From that point on, the Characteristic's desirability decreases as the number of modules increases (See Figure 6.16b.). Lower than that point, the desirability is null because the behaviour of $LPSP$.

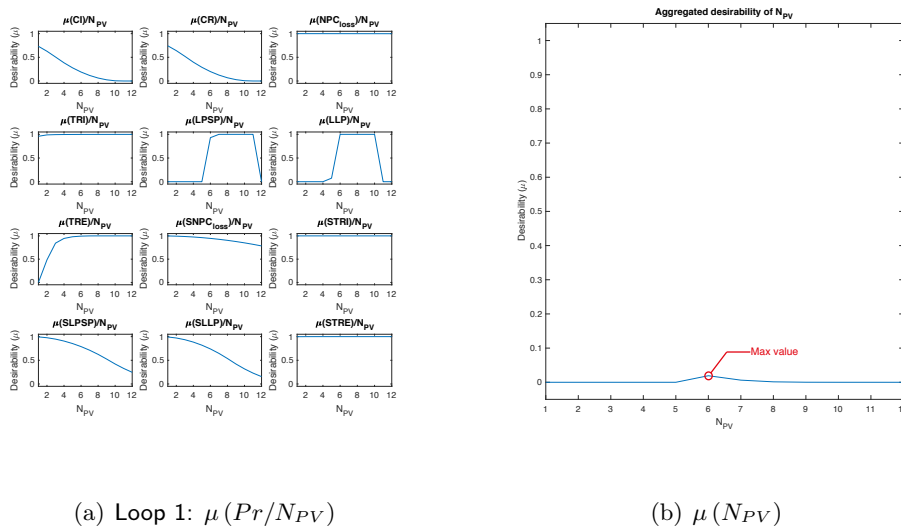

Figure 6.16: Desirability of N_{PV} in Loop 1

Further, from Figure 6.16 it can be observed that the singleton on Pr_6 and Pr_7 has disappeared, when in Figure 6.16a, the behaviour of Pr_6-LPSP and Pr_7-LLP allows quantities of PV

modules in a wider range (Pr_6 [5,11] and Pr_7 [4,10]). The effect of inverting the iteration loop allow to fix first the Characteristics with fewer influence, reducing the degrees of freedom of the problem. Finally, in Table 6.11 the obtained Characteristic's values from the first iteration loop are presented⁶. In the table, bold values represent a change of value.

Table 6.11: Values of the Characteristic on loop 1

Solution	N_{PV}	T_{PV}	N_{bat}	T_{bat}	T_{Cable1}	T_{Cable2}	T_{Cable3}	$Agg.\mu(Pr)$
DCS_0	4	50 W	3	75 Ah	0.45 mm ²	4.84 mm ²	3.03 mm ²	0
DCS_1	4	50 W	3	75 Ah	0.45 mm ²	4.84 mm ²	3.03 mm ²	0
DCS_2	4	50 W	3	75 Ah	0.45 mm ²	4.84 mm ²	3.03 mm ²	0
DCS_3	4	50 W	3	100 Ah	0.45 mm ²	4.84 mm ²	3.03 mm ²	0
DCS_4	4	50 W	3	100 Ah	0.45 mm ²	4.84 mm ²	3.03 mm ²	0
DCS_5	4	50 W	3	100 Ah	0.45 mm ²	4.84 mm ²	3.03 mm ²	0
DCS_6	4	80 W	3	100 Ah	0.45 mm ²	4.84 mm ²	3.03 mm ²	0
DCS_7	6	80 W	3	100 Ah	0.45 mm ²	4.84 mm ²	3.03 mm ²	0.0066955

6.3.1.2. Loop 2 evaluation

In the loop 2, T_{bat} , T_{PV} and the cables remain without changing. Regarding N_{bat} and N_{PV} the analysis is: For N_{bat} the $\mu(Pr/N_{bat})$ can be seen in Figure 6.17a, while the $\mu(N_{bat})$ is in Figure 6.17b. Regarding N_{PV} , the $\mu(Pr/N_{PV})$ can be observed in Figure 6.17c, while the $\mu(N_{PV})$ is in Figure 6.17d.

In Figure 6.17, it can be observed the propagated desirability for N_{PV} and N_{bat} . Regarding to the quantity of batteries (N_{bat}), the behaviour is different to loop 1. On loop 2, a maximum for $\mu(N_{bat})$. can be calculated, permitting the method to assigning $N_{bat} = 4$. In the case of N_{PV} there is a slight improvement in $LPSP$, with an increasing in the desirability when $N_{PV} = 6$. Still, the maximum value is the same calculated in loop 1, but with a better value for the desirability of the Characteristic which is $Agg.\mu(Pr) = 0.007061$. In Table 6.12 they are presented the Characteristic's values calculated in this iteration loop.

6.3.1.3. Loop 3 evaluation

For Loop 3, N_{bat} the $\mu(Pr/N_{bat})$ can be seen in Figure 6.18a, while the $\mu(N_{bat})$ is in Figure 6.18b. Regarding N_{PV} the $\mu(Pr/N_{PV})$ can be observed in Figure 6.18c, while the $\mu(N_{PV})$ is in Figure 6.18d.

⁶ DCS_1 , DCS_2 , DCS_4 are the iterations for the cables

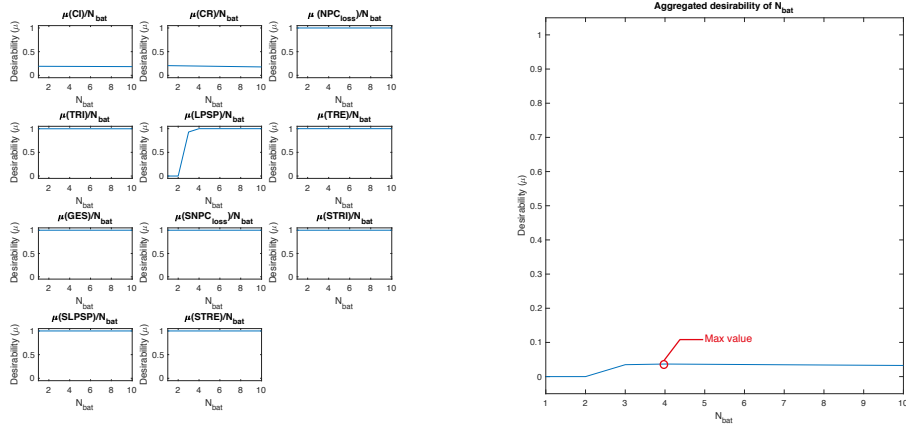

(a) Loop 2: $\mu (Pr/N_{bat})$

(b) $\mu (N_{bat})$

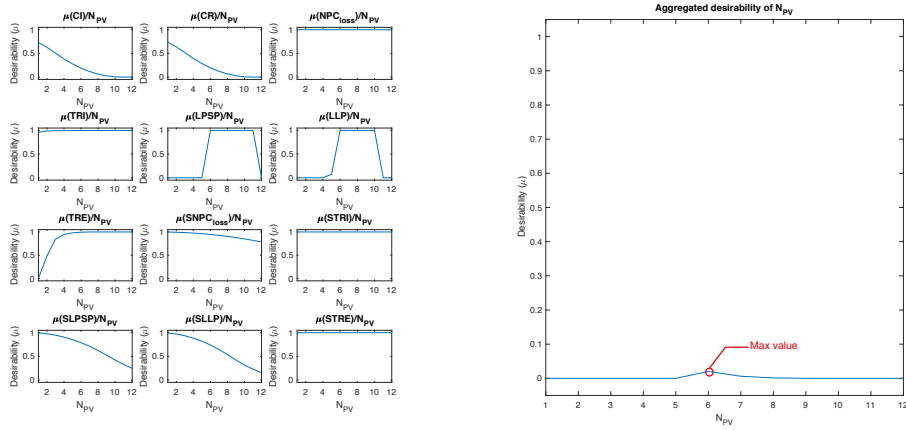

(c) Loop 2: $\mu (Pr/N_{PV})$

(d) $\mu (N_{PV})$

Figure 6.17: Desirability of N_{bat} and N_{PV} on Loop 2

Table 6.12: Values of the Characteristic on loop 2

Solution	N_{PV}	T_{PV}	N_{bat}	T_{bat}	T_{Cable1}	T_{Cable2}	T_{Cable3}	$Agg.\mu (Pr)$
DCS_8	6	80 W	3	100 Ah	0.45 mm ²	4.84 mm ²	3.03 mm ²	0.0066955
DCS_9	6	80 W	3	100 Ah	0.45 mm ²	4.84 mm ²	3.03 mm ²	0.0066955
DCS_{10}	6	80 W	3	100 Ah	0.45 mm ²	4.84 mm ²	3.03 mm ²	0.0066955
DCS_{11}	6	80 W	3	100 Ah	0.45 mm ²	4.84 mm ²	3.03 mm ²	0.0066955
DCS_{12}	6	80 W	4	100 Ah	0.45 mm ²	4.84 mm ²	3.03 mm ²	0.0070615
DCS_{13}	6	80 W	4	100 Ah	0.45 mm ²	4.84 mm ²	3.03 mm ²	0.0070615
DCS_{14}	6	80 W	4	100 Ah	0.45 mm ²	4.84 mm ²	3.03 mm ²	0.0070615

From Figure 6.18, maximums for $\mu (N_{PV})$ and $\mu (N_{bat})$ can be calculated. After this loop, both, N_{PV} and N_{bat} are steady, indicating the convergence of the method. In Table 6.13 are

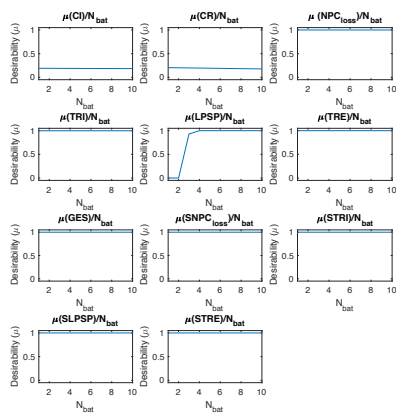

(a) Loop 3: $\mu(Pr/N_{bat})$

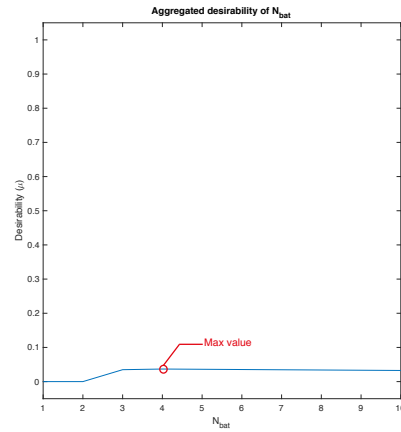

(b) $\mu(N_{bat})$

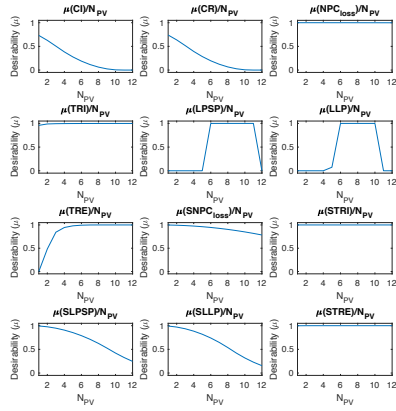

(c) Loop 3: $\mu(Pr/N_{PV})$

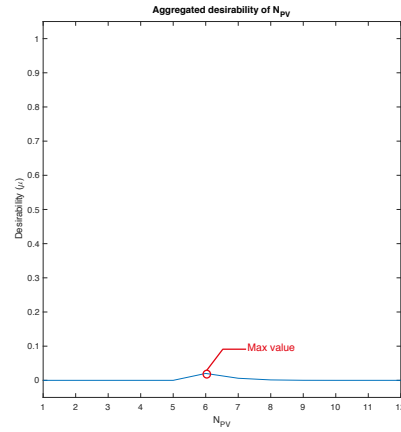

(d) $\mu(N_{PV})$

Figure 6.18: Desirability of N_{bat} and N_{PV} on Loop 3

presented the Characteristic's values for the final iteration.

Table 6.13: Values of the Characteristic on loop 3

Solution	N_{PV}	T_{PV}	N_{bat}	T_{bat}	T_{Cable1}	T_{Cable2}	T_{Cable3}	$Agg.\mu(Pr)$
DCS_{15}	6	80 W	4	100 Ah	0.45 mm ²	4.84 mm ²	3.03 mm ²	0.0070615
DCS_{16}	6	80 W	4	100 Ah	0.45 mm ²	4.84 mm ²	3.03 mm ²	0.0070615
DCS_{17}	6	80 W	4	100 Ah	0.45 mm ²	4.84 mm ²	3.03 mm ²	0.0070615
DCS_{18}	6	80 W	4	100 Ah	0.45 mm ²	4.84 mm ²	3.03 mm ²	0.0070615
DCS_{19}	6	80 W	4	100 Ah	0.45 mm ²	4.84 mm ²	3.03 mm ²	0.0070615
DCS_{20}	6	80 W	4	100 Ah	0.45 mm ²	4.84 mm ²	3.03 mm ²	0.0070615
DCS_{21}	6	80 W	4	100 Ah	0.45 mm ²	4.84 mm ²	3.03 mm ²	0.0070615

6.3.2. Analysis of the results of the SSNV method on the SAPVS design

After three iteration loops, the algorithm was able to converge, calculating a total of 21 solutions through the same number of iterations in 29.022 seconds⁷. With the combination of values of the Characteristics of DCS_{21} , the $Agg.\mu(Pr)$ was calculated in 0.0070615. The final values of the Characteristics can be seen in Table 6.14.

Table 6.14: Values of the Characteristic that maximise desirability of the SAPV system

Solution	N_{PV}	T_{PV}	N_{bat}	T_{bat}	T_{Cable1}	T_{Cable2}	T_{Cable3}
DCS_{21}	6	80W	4	100Ah	0.45mm ²	4.84mm ²	3.03mm ²

Regarding the values of the Properties, Table 6.15 summarises the calculated desirability by using values of the Characteristics from DCS_{22} . It can be seen that 11 of the Properties have a $\mu > 0.75$ and the Properties with the lower desirability are Pr_1-CoI and Pr_2-CoR , both related to the economic viability. In the Appendix G, it can be observed the complete values of the Properties (Table G.1) and its desirability (Table G.2) through the iterative process.

Table 6.15: Properties desirability results after 21 iterations

Pr	Property $\mu(Pr_j)$	Value	μ
Pr_1	CoI : Initial investment cost	3495.7 €	0.1885
Pr_2	CoR : Component replacement cost	3468 €	0.1955
Pr_3	$CoMR$: Maintenance and repair costs	35 €	0.7550
Pr_4	NPC_{loss} : Cost related to the unavailability of the system	1324 €	0.9997
Pr_5	TRI : Return on investment time	2.6 years	0.9981
Pr_6	$LPSP$: Energy outage rate	18.2137%	1.00
Pr_7	LLP : Temporal outage rate	13.45%	1.00
Pr_8	C_{dom} : Environmental impact indicator	5.2 €	0.4629
Pr_9	TRE : Energy Return Time	3.9 years	0.9947
Pr_{10}	GES : Emission of CO ₂	31125 g	1.00
Pr_{11}	$SNPC_{loss}$: Sensitivity of the unavailability of the system	14.4 €	0.9460
Pr_{12}	$STRI$: Sensitivity of return on investment time	0 years	1.00
Pr_{13}	$SLPSP$: Sensitivity of energy outage rate	0.9736%	0.7893
Pr_{14}	$SLLP$: Sensitivity of temporal outage rate	1.0818%	0.7399
Pr_{15}	$STRE$: Sensitivity of energy Return Time	0 years	1.00
Pr_{16}	$SGES$: Sensitivity of emission of CO ₂	0g	1.00
	Aggregated Desirability of Properties $Agg.\mu(Pr)$		0.0070615

Finally, in Figures 6.19a-b-c depict the evolution of the desirability of the Properties, separated

⁷Run on Matlab 2017a, on a 64bit Mac OS. Processor 2.5GHz Intel Core i5. Memory 8GB 1600 MHz DDR3

by the Customer Requirement they make part. Also, on 6.20 it can be watched the evolution of the GDI of the system. The results will be discussed on next section.



(a) $\mu(Pr)$ of economic viability properties

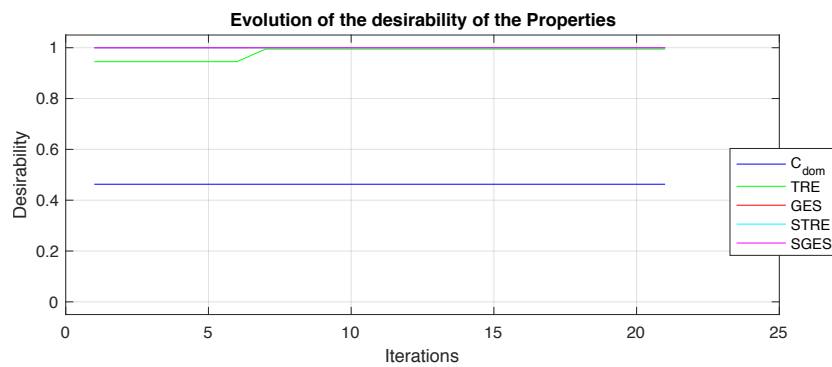

(b) $\mu(Pr)$ of environmental viability properties

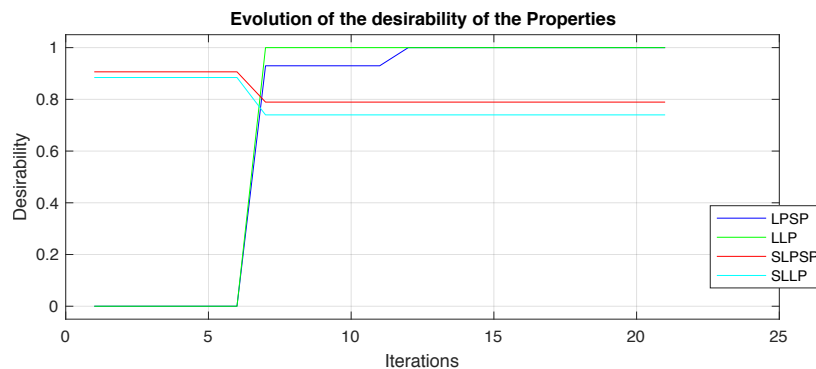

(c) $\mu(Pr)$ of service provided to the consumer properties

Figure 6.19: Evolution of the desirabilities of the SAPVS system through iterations

The use of the pre-sizing method allow to calculate which values of the Characteristic will improve the desirability of the solution. The use of CPM allow to understand which Characteristics make part of which Property, whether by the analysis of the equations or by the use of the traceability tree. In the next section, the discussion of the implementation of the method will be

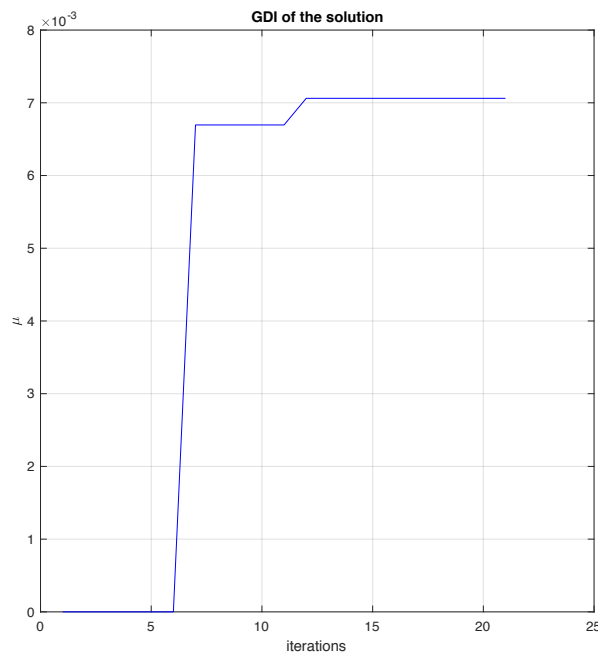

Figure 6.20: Aggregated properties desirability evolution through iterations

discussed.

6.4. Discussion of the SSNV method implementation

The algorithm was able to propose a solution that maximised the $Agg.\mu(Pr)$. This solution proposed, for the most influencer Characteristics, that the quantity of PV modules (N_{PV}) is six and the quantity of batteries (N_{bat}) is four. in Table 6.14 the complete results can be seen.

Regarding to the analysis made by Semassou (2011), the proposed algorithm produced the same results: 6 PV modules of 80 W and 4 batteries of 100 Ah. The problem got to be solved, either by the use on an OIA approach, or by maximising the desirability of a problem modelled on CPM/PDD.

Concerning to the evaluation of the results, the principal analysis can be performed based on the desirability index evolution, which represents the $Agg.\mu(Pr)$. This evolution can be observed in Figure 6.20. In this Figure, it can be seen that, on the first 3 iterations, the desirability of the solution was zero. Later the algorithm started to find combinations of values of the Characteristics for finally become asymptotic in $\mu = 0.07689$.

Section §6.3.1 shows the evolution of the $\mu(Pr/Ch_i)$ and $\mu(Ch_i)$ for the quantity of PV

modules and batteries. In Figure 6.18a it is presented the information regarding the influence of the modification of the batteries on the system. Nevertheless, the manual analysis of the propagated desirability functions is hard to understand.

Hence, the use of the interactive framework can be used in order to understand how further modifications of the Characteristics affect desirability of each Property. In Figure 6.21 it is presented the equaliser for the N_{bat} Characteristic.

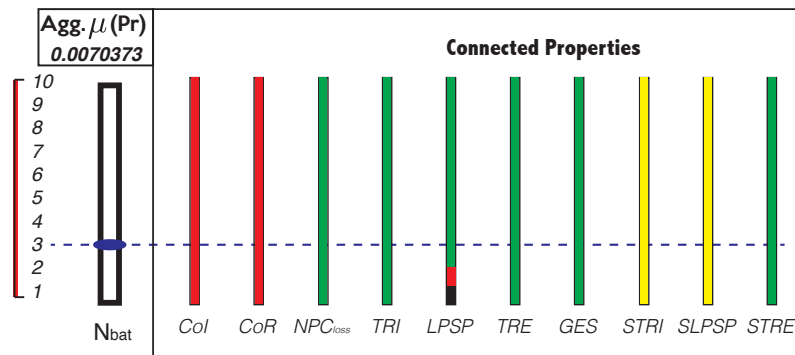

Figure 6.21: Equaliser of the quantity of batteries

Analysing the equaliser for N_{bat} in Figure 6.21, it can be observed that a number below 2 of batteries determines a null desirability of the $LPSP$ (Energy outage rate). From 3 batteries, the system will be graded under a green desirability, that is to say, $\mu > 0.8^8$. Also, it can be seen, that no matter the quantity of batteries, Properties related to the investment cost and replacement cost will be graded as red.

The use of an interactive framework improves the decision-making process by informing how modifications affect the design. In this case, the framework allows to understand boundaries of the modifications of a selected Characteristic on the performance of the design. In this case, using the values of the DCS_{21} , the ones that maximise the desirability, there is no value of N_{bat} that allows to produce a green desirability.

Finally, in order to explore the robustness of the method, the following scenarios were evaluated by modifying the preliminary layout. The results are documented in Appendix H:

1. Modifying $N_{bat}=1$, $N_{PV}=1$, which is defining the lowest quantity of batteries and PV modules. The algorithm converges, to a different local minimum. ($\mu=0.001409$)
2. Modifying $N_{bat}=3$, $N_{PV}=1$, which is letting the quantity of batteries in the mean value and defining the quantity of PV modules in the minimum value. The algorithm converges

⁸See Table 4.10 for the grading of the desirabilities according colours

in 3 iterations loops.

3. Modifying $N_{bat}=10$, $N_{PV}=4$ which is letting the quantity of PV modules in the mean value and defining the quantity of batteries in the minimum value. The algorithm converges in 3 iterations loops.
4. Modifying $N_{bat}=10$, $N_{PV}=12$, which is defining the maximum quantity of batteries and PV modules. The algorithm converges, to a different local minimum. ($\mu=0.003648$)

Also, since the SSNV method is an interactive maximisation approach, several aspects, such as Properties desirability limits, ranges of the Characteristics, may be modified. For instance, the acceptance levels of the Properties can be easily modified. Considering Pr_1-CoI , Pr_2-CoR , Pr_6-LPSP Pr_7-LLP , a different problem can be analysed. In Table 6.16 the new limits are defined, which are centred in developing a more cheap and flexible solution. The new investment limit is set on 3000 € and its $LPSP$ is allowed until 50%.

Table 6.16: Modified acceptance levels of some Properties

Description	Acceptance criteria	Acceptance limit	μ function
Pr_1 -Initial investment cost	$CoI < 3000 \text{ €}$	3000 €	$Z [100,3000]$
Pr_2 -Component replacement cost	$CoR < 3000 \text{ €}$	3000 €	$Z [100,3000]$
Pr_6 -Energy outage rate	$LPSP < 50\%$	50%	$Pi [0.01,0.02,0.49,0.50]$
Pr_7 -Temporal outage rate	$LLP < 50\%$	50%	$Pi [0.01,0.02,0.49,0.50]$

With the definition of the new boundaries, the SSNV method is able to arrive to a solution, with a maximised value of desirability of 0.0000148. Comparing to the original SAPVS design problem, the performance of this solution is worse, but in terms of the general problem, it is able to produce the energy to supply the load, with a cost that is below 3000 €.

According the solution, the algorithm takes 21 iterations to calculate a solution. The values of the Characteristics can be observed in Table 6.17, while the values of the Properties is in Table 6.18. Regarding to the evolution of the GDI, this can be observed in Figure 6.22.

Table 6.17: Values of the Characteristic of modified SAPV problem

Solution	N_{PV}	T_{PV}	N_{bat}	T_{bat}	T_{Cable1}	T_{Cable2}	T_{Cable3}
$DCS - m_{21}$	4	80W	1	100Ah	$0.45mm^2$	$4.84mm^2$	$3.03mm^2$

Table 6.18: Properties desirability of modified SAPV problem

Pr	Property $\mu(Pr_j)$	Value	μ
Pr_1	CoI : Initial investment cost	2846 €	.0056
Pr_2	CoR : Component replacement cost	2702 €	0.0103
Pr_3	$CoMR$: Maintenance and repair costs	35 €	0.7550
Pr_4	NPC_{loss} : Cost related to the unavailability of the system	876 €	0.9998
Pr_5	TRI : Return on investment time	2.8 years	9965
Pr_6	$LPSP$: Energy outage rate	47.09%	1.00
Pr_7	LLP : Temporal outage rate	42.30%	1.00
Pr_8	C_{dom} : Environmental impact indicator	5.2 €	0.4629
Pr_9	TRE : Energy Return Time	5.8 years	0.9452
Pr_{10}	GES : Emission of CO ₂	30288 g	1.00
Pr_{11}	$SNPC_{loss}$: Sensitivity of the unavailability of the system	10.9 €	0.9760
Pr_{12}	$STRI$: Sensitivity of return on investment time	0 years	1.00
Pr_{13}	$SLPSP$: Sensitivity of energy outage rate	0.6491%	0.9064
Pr_{14}	$SLLP$: Sensitivity of temporal outage rate	0.7212%	0.8844
Pr_{15}	$STRE$: Sensitivity of energy Return Time	0.1 years	0.999
Pr_{16}	$SGES$: Sensitivity of emission of CO ₂	0g	1.00
Aggregated Desirability of Properties $Agg.\mu(Pr)$			0.0000148

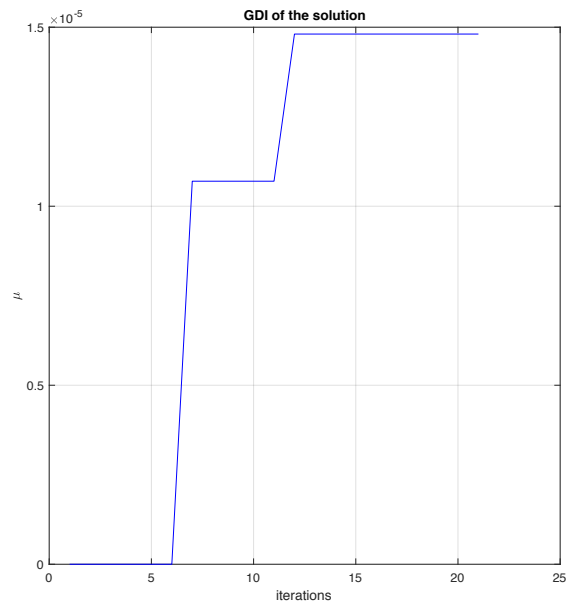

Figure 6.22: GDI Evolution of modified SAPV problem

Conclusions of the SSNV application

One of the first conclusions about the method applications is centred in how sensible it is to the DCS_0 definition, especially in non-convex situations. While the DCS_0 is defined in the mean value calculated in the Monte Carlo simulation, the solution will converge to the global maximum. In the design case of the SAPVS evaluated by Semassou (2011), the SSNV method converges to the best solution when is respected the mean values as the starting point (To the global maximum obtained to the genetic algorithm proposed by Semassou).

In Table 6.19 it can be observed how the modification of the starting point affects the local maximum calculated by the SSNV method. While it is respected the use of the mean values, the algorithm will converge to a global maximum, but when this condition is not respected, the algorithm will converge to a different maximum, to a local maximum. This happens due to the non-convexity of the problem.

Table 6.19: Comparison of the obtained solutions by the modification of the input of the method

SSNV application	$Agg.\mu$	N_{PV}	T_{PV}	N_{bat}	T_{bat}
Using Mean values	0.007061	6	80 W	4	100 Ah
Using minimum values	0.001409	10	50 W	1	75 Ah
Using maximum values	0.003648	9	50 W	9	100 Ah
Using Mean and maximum	0.007061	6	80 W	4	100 Ah
Using Mean and minimum	0.007061	6	80 W	4	100 Ah
Modifying Properties μ ranges	0.0000148	4	80 W	1	100 Ah

However, this situation cannot be seen as an adverse situation, but as an opportunity. This enables an interactive design framework: the design team can modify the first solution DCS_0 in order to explore different solution scenarios, e.g., scenarios with more panels or more batteries. The modification of the DCS_0 can guide the solution towards different solution spaces.

Finally, the interactivity of the proposed method can be categorised in two types:

- For convex problems (local maximum=global maximum), the SSNV method can be used for calculating the combination of Characteristics that maximise the Properties' desirability. With those values, the equaliser can be used to mortify the solution.
- For non-convex problems (many local maximum), the SSNV method is used for calculating a combination of Characteristics that maximise the Properties' desirability. Still, the method may converge to different maximums depending the first solution DCS_0 introduced to the method.

It can be concluded that the proposed method is interactive in different manners: i) By manually modifying values with the mouse (or a finger in a multi-touch screen) using the equalisers
ii) By modifying the DCS_0 in non-convex problems in order to explore different solution scenarios.

Conclusions and further research

The present research was conducted as a work between two laboratories, I2M-IMC at Arts et Métiers ParisTech at Bordeaux, France and Design Engineering Research Group at Universidad EAFIT at Medellín, Colombia. The thesis gathered the expertise from both research centres, either design amelioration and information management, in order to propose an interactive design method for early design stages.

Within the research, it was identified several issues on the preliminary design process. Essentially, issues related to different relationships between design objectives and design variables, representing several challenges regarding its interpretation. This lead to focus the research into the definition of a framework that empowers decision-making processes. Those issues can be summarised in three: i) how to classify the relationships between design objectives and variables ii) how to visualise those relationships iii) how to use the understanding of those relationships in order to support the decision-making process on early design stages.

The classification of the relationships between design objectives and design variables led to the definition of a scheme of work that support the understanding of those connections. Thus, the selection of the CPM/PDD approach allow to classify the different types of information present in a design process, determining the different layers of information: Customer Requirements (*CR*), Properties (*Pr*), Relations (*Rel*), Characteristics (*Ch*) and External Conditions (*EC*). This framework is centred in the understanding the connections between design objectives (Properties) and variables (Characteristics), and its usage plays a principal role in complex multidisciplinary

design because of the quantity of the relationships that might happen (Weber and Werner, 2001).

Regarding the Characteristics, within this thesis two types could be defined: Characteristics and Fixed Characteristics. This second group has also been called "*intermediate property*" by Malmiry (2016). This type of variable is characterised because its value is assigned by other variables (e.g., the selection of material defines variable density). In this work, it was decided to call them "*Fixed Characteristics*", since the name proposed by Malmiry could lead to confusion, especially because in this thesis the Properties are related to the objectives.

The utilisation of the CPM/PDD approach empowers the understanding the relationships between Properties and Characteristics, therefore, it was used as the cornerstone for the methodology for developing new products proposed in the thesis. The proposed design methodology is focused in the use of different design tools in early design with a first objective of the construction of a traceability framework: an information management model that allows the interconnection of information at early design stages, connecting information from linguistic variables to design variables (See §4.1). The selection of the tools was aimed into the selecting tools that allow to connect information between layers and generate valuable information about each connection in the traceability framework.

For connecting information between layers, the proposal included well-structured tools in the literature, such as QFD that generates connections between Customer Requirements (linguistic variables) and Properties (variable criteria), and EFA that defines the construction of the Properties list based on VA. In addition, more current methods were also considered. For example, the method proposed by Malmiry in 2016, that merges internal functional analysis tools, like FBS and CTOC, with CPM/PDD in order to generate connections among Properties, Characteristics and External Conditions.

The fundamental objective of the traceability framework was to generate valuable information that will empower the decision-making process. Its definition sets the boundary between what exist in the literature and which are the contributions proposed by this work. These contributions can be categorised in two: scientific contributions and technical contributions.

Concerning scientific contributions, it is proposed a hybrid approach: an exploratory interactive part, where the designers can modify the Characteristics understanding how those modifications can impact the Properties and an interactive inductive part, focused in determining the best combination of values of the Characteristics that maximise the overall desirability of the Properties.

The foundations of the SSNV method¹ were supported on global and local sensibility analysis

¹Pre-sizing method for determining the best combination of values of the Characteristics that maximise the

and graph theory. The use of SA with Monte Carlo allow to quantify the uncertainty in terms of understanding how sensible are Relations and Properties to the variation of its Characteristics. The results allowed to propose three indices:

- ζ index, based on the results of global sensibility analysis of each Property. The arrangement of the different (ζ_i) defined the way the iterative algorithm will tackle-down the maximisation problem, classifying the Characteristics from more influencer to less influencer.
- ψ index, based on the local sensibility analysis. This index, is related to the shortest path between a Characteristic and a Property. This index was used for weighting each Characteristics in the calculation of the $\mu(Ch_i)$. It allowed to enhance value to the Properties where the Characteristic is more influencer, i.e. if Ch_1 has a ψ index of 0.9 to Pr_1 and 0.45 to Pr_2 , a modification of the Characteristic influences higher Pr_1 , thence, the desirability function of the Characteristics considers that information.
- χ index, which allow to understand how attached are the Properties. A Property with a low value is a Property that is less attached, wherefore, is a Property easier to solve. The Properties with higher values are more complex to solve, because they are connected with more Characteristics, and collaterally, to more Properties.

The definition of those indices permitted to reduce subjectivity in the way the decision is made in the design. Both, the way the iterative algorithm is defined and the way its calculation is weighted is based on the results of sensitivity analysis. The implementation of these is based on the uncertainty management, empowering the understanding of the modification on early design.

Moreover, one of the principal contributions of this work was the development of a method for the maximisation of the aggregated desirability of the Properties, whether the problem is convex or non-convex. It was also made explorations of how the proposed method performed under different types of problem: constraining Characteristics and the definition of multiple singleton desirability functions on the Properties.

This exploration was performed seeking to validate the robustness of the method. On Sections §5.2.3 and §5.2.4, the SSNV method was used to maximising the aggregated Properties' desirability, on one hand, for convex problems, performing without any obstacles on the unconstrained problem. Likewise, the problem was also used on problems where the most influencer Characteristic was constrained, without problems to find a solution to the problem. On the other hand, several non-convex problems were explored on Section §5.3.2, where the SSNV method overall desirability of the Properties

was able to perform without any issues. Yet, some considerations in the definition of the *iteration loop* must be considered:

- When the non-convexity is presented on a Property that does not hold the whole set of Characteristics, it is proposed a synthesis-analysis approach. First, a synthesis approach is performed in order to convexify the problem by solving the Property with the non-convexity and defining the value of the Characteristics that meet the restriction. Later, the analysis approach is made in order to define the values of the Characteristics that MoADP.
- When the non-convexity is presented on two or more Properties, that not all of the Characteristics are held, the strategy is centred too in convexifying the problem and finding the solution of the problem under a synthesis-analysis approach
- When the non-convexity is presented on a Property that holds the whole set of Characteristics, the strategy is to invert the iteration loop vector, in order to let the algorithm evaluate first the Characteristics with the less influence on the design. This enables a decrease the degrees of freedom in the problem by fixing the less influencer Characteristics first, allowing to reduce the quantity of variables of the problem in each iteration.

Besides of validating the method under different constrained scenarios, it was also explored the performance of the method with the use of different types of variables. It was evaluated continuous and discrete variables. Either the type of variable, the method is able to calculate the desirability of each variable by the propagation of the desirability function from the Properties. The exploration of types of problems (convex and non-convex) and types of Characteristics was used to prove the robustness of the method.

About the technical contribution, it was proposed a set of tools in order to support the exploratory interactive approach. The use of equaliser was used to support the decision-making process by informing designers how modifications will affect the desirability of each Property. Also, the use of CPM/PDD for the generation of the traceability tree allow to visual verification of connections between Characteristics and Properties. The technical contributions are proposed to be integrated into a web interface framework (See Appendix B) in order to facilitate the interaction of the users. In Figure 7.1 it can be observed the developed framework being used in a multi-touch surface. The interactive framework facilitates the modification of the Characteristic's values by sliding in an equaliser (See Appendix B.1 for information about the application)

Finally, regarding the novelty of the method, many of the design amelioration methods evaluated on this thesis considered both, definition of desirability functions for design objectives and



Figure 7.1: Interactive framework equaliser in multi-touch surface

aggregation as a technique for calculating the global desirability index, especially OIA methods (Quirante(2012), Collignan(2012) and Semassou(2011)). As a difference to OIA, in this thesis it was used a CPM/PDD approach that allows to establish direct connections with Characteristics and Properties. The fact of having those connections, allow the method to tackle down the problem from a different perspective and allowed to propose the SSNV method and a novel approach to find a solution where the global desirability index is maximised, without the use of genetic algorithms.

Further research

This thesis was centred on the development of a interactive methodology for supporting decision-making processes on multidisciplinary design. Nevertheless the level of interactivity is still very manual. Even if the equalisers facilitate the understanding of how a modification will impact the design, its utilisation must be taken to a more simplified framework.

At the moment, the framework is built in Matlab and requires to have installed this software and two specific libraries: *Fuzzy Logic Toolbox* and *Statistics and Machine Learning Toolbox*. This produces that the portability of the tool is limited. One of the first perspectives is centred into the development of a standalone tool, in order to enlarge the usability of the interactive method to other platforms. This tool should be multi-platform and multi-user² compatible.

Also, it is also among the further research to validate the methods. So far, the usability has

²That supports several interacting using the platform at the same time

not been tested with users. Considering the scope of the proposed methodology on this thesis, this method is centred to be used at Master level engineers. It is important that the users of the method to be familiarised with multidisciplinary design and to have a solid mathematical modelling background.

Likewise, it is intended to validate how easy is for users to manipulate the method. In the proposed method, the maximisation process is a "*transparent box maximisation*", where several parameters (desirability functions) can be easily modified. It is necessary if engineers understand the concept before interacting with the method.

Also, it was verified that the problem was able to solve non-convex problems, whether with the portable cooler or with the SAPVS design case. Still, it is wished to validate the algorithm with further non-convex problems.

Finally, the method is wished to be validated on a real industrial scenario, with real users, that is to say engineers from industry, not from research laboratories. This final validation needs to consider the effects of weighting or not weighting the different parameters using subjective parameters and specially the size of the project in terms of time of modelling of the project and the iteration process too.

References

- Abouzahr, I. and Ramakumar, R. (1990). Loss of power supply probability of stand-alone wind electric conversion systems: A closed form solution approach. *IEEE Transactions on Energy Conversion*, 5(3):445–452.
- Akikur, R. K., Saidur, R., Ping, H. W., and Ullah, K. R. (2013). Comparative study of stand-alone and hybrid solar energy systems suitable for off-grid rural electrification: A review. *Renewable and Sustainable Energy Reviews*, 27:738–752.
- Alam, K., Ray, T., and Anavatti, S. G. (2015). Design optimization of an unmanned underwater vehicle using low-and high-fidelity models. *IEEE Transactions on Systems, Man, and Cybernetics: Systems*.
- Alsema, E. and de Wild, M. J. (2005). Environmental impact of crystalline silicon photovoltaic module production. *MRS Online Proceedings Library Archive*, 895.
- Altshuller, G., Shulyak, L., and Rodman, S. (1997). *40 Principles: TRIZ keys to innovation*, volume 1. Technical Innovation Center, Inc.
- Andreasen, M. M. (1980). Machine design methods based on a systematic approach—contribution to a design theory. *Dissertation, Department of Machine Design, Lund University, Sweden*.
- Antonsson, E. K. (2001). *Imprecision in Engineering Design*. Division of Engineering and Applied Science, California Institute of Technology.
- Antonsson, E. K. and Otto, K. N. (1995). Imprecision in engineering design. *Journal of Vibration and Acoustics*, 117(B):25–32.

- Arias-Rosales, A. and Mejía-Gutiérrez, R. (2018). Optimization of v-trough photovoltaic concentrators through genetic algorithms with heuristics based on weibull distributions. *Applied Energy*, 212:122–140.
- Babu, S. N., Prabu, T., Yadav, D. R., and Rao, G. A. P. (2018). A mathematical framework for design and optimization of regenerative storage heater. *Applied Thermal Engineering*.
- Badufle, C., Blondel, C., Druot, T., Bès, C., and Hiriart-Urruty, J.-B. (2010). A heuristic-based framework to solve a complex aircraft sizing problem. *Engineering Applications of Artificial Intelligence*, 23(5):704–714.
- Baxter, D., Gao, J., Case, K., Harding, J., Young, B., Cochrane, S., and Dani, S. (2008). A framework to integrate design knowledge reuse and requirements management in engineering design. *Robotics and Computer-Integrated Manufacturing*, 24(4):585–593.
- Bellman, R. E. and Zadeh, L. A. (1970). Decision-making in a fuzzy environment. *Management science*, 17(4):B–141.
- Bénabès, J., Poirson, E., and Bennis, F. (2013). Integrated and interactive method for solving layout optimization problems. *Expert Systems with Applications*, 40(15):5796–5803.
- Benson, S. M. and Orr, F. M. (2008). Carbon dioxide capture and storage. *MRS bulletin*, 33(4):303–305.
- Bertsekas, D. P., Nedi, A., and Ozdaglar, A. E. (2003). *Convex analysis and optimization*. Athena Scientific.
- Boitier, V. and Alonso, C. (2005). Dimensionnement d'un système photovoltaïque.
- Borowy, B. S. and Salameh, Z. M. (1996). Methodology for optimally sizing the combination of a battery bank and pv array in a wind/pv hybrid system. *IEEE Transactions on energy conversion*, 11(2):367–375.
- Bouchitté, G. and Phan, M. (2017). A duality recipe for non-convex variational problems. *Comptes Rendus Mécanique*.
- Canbaz, B., Yannou, B., and Yvars, P.-A. (2014). Preventing design conflicts in distributed design systems composed of heterogeneous agents. *Engineering Applications of Artificial Intelligence*, 28:142–154.

- Carvajal-Arango, R., Zuluaga-Holguín, D., and Mejía-Gutiérrez, R. (2014). A systems-engineering approach for virtual/real analysis and validation of an automated greenhouse irrigation system. *International Journal on Interactive Design and Manufacturing (IJIDeM)*, pages 1–13.
- Cavallucci, D., Fuhlhaber, S., and Riwan, A. (2015). Assisting decisions in inventive design of complex engineering systems. *Procedia engineering*, 131:975–983.
- Chirkin, A. M. and Koenig, R. (2016). *Concept of Interactive Machine Learning in Urban Design Problems*. ACM.
- Chiu, P.-W. and Bloebaum, C. (2009). Visual steering for design generation in multi-objective optimization problems. In *47th AIAA Aerospace Sciences Meeting including The New Horizons Forum and Aerospace Exposition*, page 1167.
- Clarkson, P. J., Simons, C., and Eckert, C. (2004). Predicting change propagation in complex design. *Journal of Mechanical Design*, 126(5):788–797.
- Collignan, A. (2012). Méthode d'optimisation et d'aide à la décision en conception mécanique : Application à une structure aéronautique.
- Collignan, A., Sebastian, P., Pailhes, J., and Ledoux, Y. (2012). Arc-elasticity and hierarchical exploration of the neighborhood of solutions in mechanical design. *Advanced Engineering Informatics*, 26(3):603–617.
- Couturier, P., Lô, M., Imoussaten, A., Chapurlat, V., and Montmain, J. (2014). Tracking the consequences of design decisions in mechatronic systems engineering. *Mechatronics*, 24(7):763–774.
- Danilovic, M. and Sandkull, B. (2005). The use of dependence structure matrix and domain mapping matrix in managing uncertainty in multiple project situations. *International journal of project management*, 23(3):193–203.
- de Oliveira, J. V. (1999). Semantic constraints for membership function optimization. *IEEE Transactions on Systems, Man, and Cybernetics-Part A: Systems and Humans*, 29(1):128–138.
- Derringer, G. and Suich, R. (1980). Simultaneous optimization of several response variables. *Journal of quality technology*, 12(4):214–219.
- Derringer, G. C. (1994). A balancing act-optimizing a products properties. *Quality Progress*, 27(6):51–58.

- Drăghici, G. and Banciu, F. (2007). Parallelism between algorithmic (systematic) design and axiomatic design. *Annals of the Oradea University, Fascicle of Management and Technological Engineering*, 6:1583–0691.
- Ehrig, H., Hermann, F., Schölzel, H., and Brandt, C. (2013). Propagation of constraints along model transformations using triple graph grammars and borrowed context. *Journal of Visual Languages & Computing*, 24(5):365–388.
- Eisenmann, J., Lewis, M., and Parent, R. (2014). Probabilistic decision making for interactive evolution with sensitivity analysis. In *International Conference on Evolutionary and Biologically Inspired Music and Art*, pages 1–12. Springer.
- Ekel, P., Kokshenev, I., Parreiras, R., Pedrycz, W., and Pereira Jr, J. (2016). Multiobjective and multiattribute decision making in a fuzzy environment and their power engineering applications. *Information Sciences*, 361:100–119.
- Ekel, P. Y. (2002). Fuzzy sets and models of decision making. *Computers & Mathematics with Applications*, 44(7):863–875.
- El Amine, M. (2015). *Intégration de la maturité des connaissances dans la prise de décision en conception mécanique: application à un système solaire*. PhD thesis, Ecole nationale supérieure d'arts et métiers-ENSAM.
- Eppinger, S. and Ulrich, K. (2015). *Product design and development*. McGraw-Hill Higher Education.
- Esmín, A. A. A. and Lambert-Torres, G. (2007). Evolutionary computation based fuzzy membership functions optimization. In *Systems, Man and Cybernetics, 2007. ISIC. IEEE International Conference on*, pages 823–828. IEEE.
- FALL, L. (2008). Les besoins spécifiques liés à l'électrification rurale en Afrique. *Liaison énergie francophonie*, (80):88–93.
- Fernández-Montoya, M., Arias-Rosales, A., Osorio-Gómez, G., and Mejía-Gutiérrez, R. (2017). Nominal energy optimisation method of constrained battery packs through the iteration of the series-parallel topology. *International Journal of Energy Research*, 41(12):1709–1729.
- Ferreboeuf, C. (2014). *Qualité en conception-méthodologie et mise en œuvre*.

- Fischer, X. and Coutellier, D. (2006). *Research in interactive design: proceedings of virtual concept 2005*. Springer Science & Business Media.
- Fischer, X. and Nadeau, J.-P. (2011). Interactive design: then and now. pages 1–5.
- Fischer, X., Nadeau, J.-P., Sébastien, P., and Joyot, P. (2002). Conception inversée intégrée: prédimensionnement de produits par satisfaction de contraintes. *Mécanique & industries*, 3(6):593–605.
- Franceschini, F. and Rossetto, S. (2002). Qfd: an interactive algorithm for the prioritization of product's technical design characteristics. *Integrated Manufacturing Systems*, 13(1):69–75.
- Gagnon, R., Gosselin, L., and Decker, S. (2018). Sensitivity analysis of energy performance and thermal comfort throughout building design process. *Energy and Buildings*.
- Gao, Y., Merienne, F., and Pailhes, J. (2013). Virtual reality aided detailed design: application to riveted joints in aeronautics. Technical report, Institut de Mécanique et d'Ingénierie I2M. Arts et Métiers ParisTech. Bordeaux, France.
- Gero, J. S. (1990). Design prototypes: a knowledge representation schema for design. *AI magazine*, 11(4):26.
- Gero, J. S. and Kannengiesser, U. (2004). The situated function–behaviour–structure framework. *Design studies*, 25(4):373–391.
- Giachetti, R. E. and Young, R. E. (1997). A parametric representation of fuzzy numbers and their arithmetic operators. *Fuzzy sets and systems*, 91(2):185–202.
- Giachetti, R. E., Young, R. E., Roggatz, A., Eversheim, W., and Perrone, G. (1997). A methodology for the reduction of imprecision in the engineering process. *European Journal of Operational Research*, 100(2):277–292.
- Goel, A. K. and Stroulia, E. (1996). Functional device models and model-based diagnosis in adaptive design. *AI EDAM*, 10(4):355–370.
- Goldberg, D. E., Richardson, J., et al. (1987). Genetic algorithms with sharing for multimodal function optimization. In *Genetic algorithms and their applications: Proceedings of the Second International Conference on Genetic Algorithms*, pages 41–49. Hillsdale, NJ: Lawrence Erlbaum.

- Gopakumar, A. M., Balachandran, P. V., Xue, D., Gubernatis, J. E., and Lookman, T. (2018). Multi-objective optimization for materials discovery via adaptive design. *Scientific reports*, 8(1):3738.
- Guirguis, D., Romero, D. A., and Amon, C. H. (2017). Gradient-based multidisciplinary design of wind farms with continuous-variable formulations. *Applied energy*, 197:279–291.
- Hamby, D. (1994). A review of techniques for parameter sensitivity analysis of environmental models. *Environmental monitoring and assessment*, 32(2):135–154.
- Hamby, D. (1995). A comparison of sensitivity analysis techniques. *Health physics*, 68(2):195–204.
- Hamida, S. B., Grandou, A., Jankovic, M., Eckert, C., Huet, A., and Bocquet, J.-C. (2015). A comparative case study of functional models to support system architecture design. *Procedia Computer Science*, 44:325–335.
- Han, Y.-H. and Lee, K. (2006). A case-based framework for reuse of previous design concepts in conceptual synthesis of mechanisms. *Computers in Industry*, 57(4):305–318.
- Harrington, E. C. (1965). The desirability function. *Industrial quality control*, 21(10):494–498.
- Hassan, A. (2010). *Proposition et développement d'une approche pour la maîtrise conjointe qualité/coût lors de la conception et de l'industrialisation du produit*. PhD thesis, Arts et Métiers ParisTech.
- Hazelrigg, G. A. (1998). A framework for decision-based engineering design. *Journal of mechanical design*, 120(4):653–658.
- Hill, A. and Schwarze, S. (2016). Exact algorithms for bi-objective ring tree problems with reliability measures. *Preprint, Optimization-Online*.
- Hoffert, M. I., Caldeira, K., Benford, G., Criswell, D. R., Green, C., Herzog, H., Jain, A. K., Kheshgi, H. S., Lackner, K. S., Lewis, J. S., et al. (2002). Advanced technology paths to global climate stability: energy for a greenhouse planet. *science*, 298(5595):981–987.
- Hubka, V. and Eder, W. E. (2012). *Design science: introduction to the needs, scope and organization of engineering design knowledge*. Springer Science & Business Media.
- IEEE (1990). IEEE standard glossary of software engineering terminology. *IEEE Std 610.12-1990*, 121990:1–84.

- Igba, J., Alemzadeh, K., Gibbons, P. M., and Henningsen, K. (2015). A framework for optimising product performance through feedback and reuse of in-service experience. *Robotics and Computer-Integrated Manufacturing*, 36:2–12.
- Jeong, I.-J. and Kim, K.-J. (2009). An interactive desirability function method to multiresponse optimization. *European Journal of Operational Research*, 195(2):412–426.
- Kato, K., Murata, A., and Sakuta, K. (1998). Energy pay-back time and life-cycle co2 emission of residential pv power system with silicon pv module. *Progress in Photovoltaics: Research and Applications*, 6(2):105–115.
- Keller, R., Eger, T., Eckert, C., and Clarkson, P. (2005). Visualising change propagation. In *DS 35: Proceedings ICED 05, the 15th International Conference on Engineering Design, Melbourne, Australia, 15.-18.08. 2005*.
- Kharrati, H., Khanmohammadi, S., Zeiaee, A., Navarbafe, A., and Alizadeh, G. (2012). Design of optimized fuzzy model-based controller for nonlinear systems using hybrid intelligent strategies. *Proceedings of the Institution of Mechanical Engineers, Part I: Journal of Systems and Control Engineering*, 226(9):1152–1165.
- Kim, K.-J. and Lin, D. K. (2000). Simultaneous optimization of mechanical properties of steel by maximizing exponential desirability functions. *Journal of the Royal Statistical Society: Series C (Applied Statistics)*, 49(3):311–325.
- Köhler, C., Conrad, J., Wanke, S., and Weber, C. (2008). A matrix representation of the cpm/pdd approach as a means for change impact analysis.
- Köksalan, M. and Plante, R. D. (2003). Interactive multicriteria optimization for multiple-response product and process design. *Manufacturing & Service Operations Management*, 5(4):334–347.
- Königs, S. F., Beier, G., Figge, A., and Stark, R. (2012). Traceability in systems engineering—review of industrial practices, state-of-the-art technologies and new research solutions. *Advanced Engineering Informatics*, 26(4):924–940.
- Koyama, Y. (2016). Computational design driven by aesthetic preference. In *Proceedings of the 29th Annual Symposium on User Interface Software and Technology*, pages 1–4. ACM.
- Lee, D.-H., Kim, K.-J., and Köksalan, M. (2011). A posterior preference articulation approach to multiresponse surface optimization. *European Journal of Operational Research*, 210(2):301–309.

- Lin, S.-H. and Gerber, D. J. (2014). Evolutionary energy performance feedback for design: Multidisciplinary design optimization and performance boundaries for design decision support. *Energy and Buildings*, 84:426–441.
- Liu, J. and Gea, H. C. (2018). Robust topology optimization under multiple independent unknown-but-bounded loads. *Computer Methods in Applied Mechanics and Engineering*, 329:464–479.
- Malak, R. J., Aughenbaugh, J. M., and Paredis, C. J. (2009). Multi-attribute utility analysis in set-based conceptual design. *Computer-Aided Design*, 41(3):214–227.
- Malmiry, R. B. (2016). *Managing Complexity and Uncertainty by a Modelling Approach for Decision Making in Integrated Product Process Design*. PhD thesis, École Nationale Supérieure d'Arts et Métiers - Paristech.
- Malmiry, R. B., Dantan, J.-Y., Pailhès, J., and Antoine, J.-F. (2016). A product functional modelling approach based on the energy flow by using characteristics-properties modelling. *Journal of Engineering Design*, 27(12):817–843.
- Mao, Y., Szmuk, M., and Açıkmeşe, B. (2016). Successive convexification of non-convex optimal control problems and its convergence properties. In *Decision and Control (CDC), 2016 IEEE 55th Conference on*, pages 3636–3641. IEEE.
- Martin, P., Lossent, L., Abt, L., and Brassat, F. (2004). Conception de machines spéciales: méthodologie d'élaboration de cahier des charges. *Mechanics & Industry*, 5(3):305–316.
- Mastroddi, F. and Gemma, S. (2013). Analysis of pareto frontiers for multidisciplinary design optimization of aircraft. *Aerospace Science and Technology*, 28(1):40–55.
- Miettinen, K., Ruiz, F., and Wierzbicki, A. P. (2008). Introduction to multiobjective optimization: interactive approaches. In *Multiobjective Optimization*, pages 27–57. Springer.
- Morgenstern, O. and Von Neumann, J. (1953). *Theory of games and economic behavior*. Princeton university press.
- Nadeau, J. and Sebastian, P. (2006). *Energétique Industrielle*. Cours polycopié, ENSAM. CER de Bordeaux.
- Nagy, E. (2012). Fuzzy membership function optimization. *AIP Conference Proceedings*, 1493(1):684–690.

- Nema, P., Nema, R., and Rangnekar, S. (2010). Pv-solar/wind hybrid energy system for gsm/cdma type mobile telephony base station. *international journal of energy and environment*, 1(2):359–366.
- NF-X, A. (1991). X 50-150 analyse de la valeur, analyse fonctionnelle. *Expression fonctionnelle du besoin et cahier des charges fonctionnel*.
- Ng, T. and Leng, G. (2002). Application of genetic algorithms to conceptual design of a micro-air vehicle. *Engineering Applications of Artificial Intelligence*, 15(5):439–445.
- Ni, B., Jiang, C., and Huang, Z. (2018). Discussions on non-probabilistic convex modelling for uncertain problems. *Applied Mathematical Modelling*, 59:54–85.
- Nowacki, H. (2010). Five decades of computer-aided ship design. *Computer-Aided Design*, 42(11):956–969.
- Ogot, M. (2004). Ems models: Adaptation of engineering design black-box models for use in triz. *ETRIA TRIZ Futures 2004 Conference*.
- Otto, K. N. and Antonsson, E. K. (1991). Trade-off strategies in engineering design. *Research in Engineering Design*, 3(2):87–103.
- Otto, K. N. and Antonsson, E. K. (1993). The method of imprecision compared to utility theory for design selection problems. *Design Theory and Methodology–DTM'93*, pages 167–173.
- Ouertani, M.-Z., Baïna, S., Gzara, L., and Morel, G. (2011). Traceability and management of dispersed product knowledge during design and manufacturing. *Computer-Aided Design*, 43(5):546–562.
- Pahl, G., Beitz, W., Feldhusen, J., and Gote, H. (2007). *Engineering design: A systematic approach*. Springer Verlag.
- Pailhès, J., Sallaou, M., Nadeau, J.-P., and Fadel, G. M. (2011). Energy based functional decomposition in preliminary design. *Journal of mechanical design*, 133(5):051011.
- Panagiotopoulos, P. D. (2012). *Inequality Problems in Mechanics and Applications: Convex and nonconvex energy functions*. Springer Science & Business Media.
- Pape, L., Agarwal, S., and Dagli, C. (2015). Selecting attributes, rules, and membership functions for fuzzy sos architecture evaluation. *Procedia Computer Science*, 61:176–182.

- Park, K. S. and Kim, K.-J. (2005). Optimizing multi-response surface problems: how to use multi-objective optimization techniques. *IIE Transactions*, 37(6):523–532.
- Pasandideh, S. H. R. and Niaki, S. T. A. (2006). Multi-response simulation optimization using genetic algorithm within desirability function framework. *Applied Mathematics and Computation*, 175(1):366–382.
- Pedrycz, W., Ekel, P., and Parreiras, R. (2011). *Fuzzy multicriteria decision-making: models, methods and applications*. John Wiley & Sons.
- Penas, O., Plateaux, R., Patalano, S., and Hammadi, M. (2017). Multi-scale approach from mechatronic to cyber-physical systems for the design of manufacturing systems. *Computers in Industry*, 86:52–69.
- Piedras, H., Yacout, S., and Savard, G. (2006). Concurrent optimization of customer requirements and the design of a new product. *International Journal of Production Research*, 44(20):4401–4416.
- Posadillo, R. and Luque, R. L. (2008). Approaches for developing a sizing method for stand-alone pv systems with variable demand. *Renewable Energy*, 33(5):1037–1048.
- Prasad, B. (1998). Review of qfd and related deployment techniques. *Journal of manufacturing Systems*, 17(3):221.
- Qu, B., Kumar, P., Zhang, E., Jaiswal, P., Cooper, L., Elser, J., and Zhang, Y. (2017). Interactive design and visualization of n-ary relationships. In *SIGGRAPH Asia 2017 Symposium on Visualization*, page 15. ACM.
- Quirante, T. (2012). *Modelling and numerical optimization methods for decision support in robust embodiment design of products and processes*. PhD thesis, Université de Bordeaux 1.
- Quirante, T., Ledoux, Y., and Sebastian, P. (2010). Design optimization of two-stage flash evaporator: a trade-off between design objectives. *Research in Interactive Design*, Springer Paris Berlin Heidelberg New York, Bordeaux.
- Rao, A. B. and Rubin, E. S. (2002). A technical, economic, and environmental assessment of amine-based co2 capture technology for power plant greenhouse gas control. *Environmental science & technology*, 36(20):4467–4475.

- Reynoso-Meza, G., Sanchis, J., Blasco, X., and Martínez, M. (2016). Preference driven multi-objective optimization design procedure for industrial controller tuning. *Information Sciences*, 339:108–131.
- Ríos-Zapata, D., Osorio-Gómez, G., and Mejía-Gutiérrez, R. (2014). Development of a technology-based design environment focused on improving user experience. *Procedia CIRP*, 21:276–281.
- Ríos-Zapata, D., Pailhès, J., and Mejía-Gutiérrez, R. (2017a). Information model for tracelinks building in early design stages. pages 147–154.
- Ríos-Zapata, D., Pailhès, J., and Mejía-Gutiérrez, R. (2017b). Multi-layer graph theory utilisation for improving traceability and knowledge management in early design stages. *Procedia CIRP*, 60:308–313.
- Riza, D., Gilani, S., and Aris, M. (2015). Standalone photovoltaic systems sizing optimization using design space approach: case study for residential lighting load. *Journal of Engineering Science and Technology*, 10(7):943–957.
- Robertson, B. and Radcliffe, D. (2009a). Impact of CAD tools on creative problem solving in engineering design. *Computer-Aided Design*, 41(3):136–146.
- Robertson, B. and Radcliffe, D. (2009b). Impact of cad tools on creative problem solving in engineering design. *Computer-Aided Design*, 41(3):136–146.
- Rockafellar, R. T. (2015). *Convex analysis*. Princeton university press.
- Russo, I. L., Bernardino, H. S., and Barbosa, H. J. (2017). Knowledge discovery in multiobjective optimization problems in engineering via genetic programming. *Expert Systems with Applications*.
- Safaei, B. and Mashhadi, S. K. M. (2016). Fuzzy membership functions optimization of fuzzy controllers for a quad rotor using particle swarm optimization and genetic algorithm. In *Control, Instrumentation, and Automation (ICCIA), 2016 4th International Conference on*, pages 256–261. IEEE.
- Sakalkar, V. and Hajela, P. (2011). Multilevel decomposition based nondeterministic design optimization for structural systems. *Advances in Engineering Software*, 42(1-2):1–11.

- Sandberg, M., Tyapin, I., Kokkolaras, M., Lundbladh, A., and Isaksson, O. (2017). A knowledge-based master model approach exemplified with jet engine structural design. *Computers in Industry*, 85:31–38.
- Scaravetti, D. (2004). *Formalisation parable d'une problème de conception, pour l'aide à la décision en conception préliminaire*. PhD thesis, École Nationale Supérieure d'Arts et Métiers Centre de Bordeaux.
- Scaravetti, D., Nadeau, J.-P., Pailhès, J., and Sebastian, P. (2005). Structuring of embodiment design problem based on the product lifecycle. *International Journal of Product Development*, 2(1):47–70.
- Scott, M. J. (1999). *Formalizing negotiation in engineering design*. PhD thesis, California Institute of Technology Pasadena, CA.
- Sebastian, P., Quirante, T., Tiat, V. H. K., and Ledoux, Y. (2010). Multi-objective optimization of the design of two-stage flash evaporators: Part 2. multi-objective optimization. *International Journal of Thermal Sciences*, 49(12):2459–2466.
- Semassou, C. (2011). *Aide à la décision pour le choix de sites et systèmes énergétiques adaptés aux besoins du Bénin*. PhD thesis, Université de Bordeaux 1.
- Shen, W. (2009). Optimally sizing of solar array and battery in a standalone photovoltaic system in Malaysia. *Renewable Energy*, 34(1):348–352.
- Shishkin, S. L. (2017). Optimization under non-convex quadratic matrix inequality constraints with application to design of optimal sparse controller. *IFAC-PapersOnLine*, 50(1):10754–10759.
- Sitek, P., Nielsen, I. E., and Wikarek, J. (2014). A hybrid multi-agent approach to the solving supply chain problems. *Procedia Computer Science*, 35:1557–1566.
- Song, A., Song, J., Ding, X., Xu, G., and Chen, J. (2017). Utilizing bat algorithm to optimize membership functions for fuzzy association rules mining. In *International Conference on Database and Expert Systems Applications*, pages 496–504. Springer.
- Steward, D. V. (1981). The design structure system: A method for managing the design of complex systems. *IEEE transactions on Engineering Management*, (3):71–74.
- Suh, N. P. (1990). *The principles of design*. Number 6. Oxford University Press on Demand.

- Suh, N. P. (2001). *Axiomatic design: Advances and applications (the oxford series on advanced manufacturing)*.
- Tate, D. D. E. (1999). *A roadmap for decomposition: activities, theories, and tools for system design*. PhD thesis, Massachusetts Institute of Technology.
- Tchertchian, N., Yvars, P.-A., and Millet, D. (2013). Benefits and limits of a constraint satisfaction problem/life cycle assessment approach for the ecodesign of complex systems: a case applied to a hybrid passenger ferry. *Journal of cleaner production*, 42:1–18.
- Thiaux, Y. (2010). *Optimisation des profils de consommation pour minimiser les coûts économique et énergétique sur cycle de vie des systèmes photovoltaïques autonomes et hybrides-Evaluation de la technologie Li-ion*. PhD thesis, École normale supérieure de Cachan-ENS Cachan.
- Thokala, P., Devlin, N., Marsh, K., Baltussen, R., Boysen, M., Kalo, Z., Longrenn, T., Mussen, F., Peacock, S., Watkins, J., et al. (2016). Multiple criteria decision analysis for health care decision making—an introduction: report 1 of the ispor mcda emerging good practices task force. *Value in health*, 19(1):1–13.
- Thunnissen, D. P. (2005). *Propagating and mitigating uncertainty in the design of complex multidisciplinary systems*. PhD thesis, California Institute of Technology.
- Tomiyaama, T., Gu, P., Jin, Y., Lutters, D., Kind, C., and Kimura, F. (2009). Design methodologies: Industrial and educational applications. *CIRP Annals-Manufacturing Technology*, 58(2):543–565.
- Triantaphyllou, E. (2000). Multi-criteria decision making methods. In *Multi-criteria decision making methods: A comparative study*, pages 5–21. Springer.
- Turrin, M., Yang, D., D'Aquilio, A., Sileryte, R., and Sun, Y. (2016). Computational design for sport buildings. *Procedia engineering*, 147:878–883.
- Umeda, Y., Ishii, M., Yoshioka, M., Shimomura, Y., and Tomiyama, T. (1996). Supporting conceptual design based on the function-behavior-state modeler. *Ai Edam*, 10(4):275–288.
- Valle, S. and Vázquez-Bustelo, D. (2009). Concurrent engineering performance: Incremental versus radical innovation. *International Journal of Production Economics*, 119(1):136–148.
- Wang, C. (2014). Insights from developing a multidisciplinary design and analysis environment. *Computers in Industry*, 65(4):786–795.

- Wang, C. (2016). A multidisciplinary design and analysis environment and its application to aircraft flight dynamics analysis. *Journal of Industrial Information Integration*, 1:14–19.
- Wang, L., Shen, W., Xie, H., Neelamkavil, J., and Pardasani, A. (2002). Collaborative conceptual design—state of the art and future trends. *Computer-Aided Design*, 34(43):981–996.
- Wang, L., Xiong, C., Wang, X., Xu, M., and Li, Y. (2018a). A dimension-wise method and its improvement for multidisciplinary interval uncertainty analysis. *Applied Mathematical Modelling*.
- Wang, X., Wang, R., Wang, L., Chen, X., and Geng, X. (2018b). An efficient single-loop strategy for reliability-based multidisciplinary design optimization under non-probabilistic set theory. *Aerospace Science and Technology*, 73:148–163.
- Weber, C. (2005). Cpm/pdd—an extended theoretical approach to modelling products and product development processes. In *Proceedings of the 2nd German-Israeli Symposium on Advances in Methods and Systems for Development of Products and Processes*, pages 159–179.
- Weber, C. (2007). Looking at “dfx” and “product maturity” from the perspective of a new approach to modelling product and product development processes. In *The Future of Product Development*, pages 85–104. Springer.
- Weber, C. (2014). Modelling products and product development based on characteristics and properties. In *An Anthology of Theories and Models of Design*, pages 327–352. Springer.
- Weber, C., Steinbach, M., Botta, C., and Deubel, T. (2004). Modelling of product-service systems (pss) bases on the pdd approach. In *DS 32: Proceedings of DESIGN 2004, the 8th International Design Conference, Dubrovnik, Croatia*.
- Weber, C. and Werner, H. (2001). Schlussfolgerungen für dfx aus der perspektive eines neuen ansatzes zur modellierung von produkten und produktentwicklungsprozessen. In *DFX 2001: Proceedings of the 12th Symposium on Design for X, Neukirchen/Erlangen, Germany, 11.-12.10. 2001*.
- Weber, C., Werner, H., and Deubel, T. (2003). A different view on product data management/product life-cycle management and its future potentials. *Journal of engineering design*, 14(4):447–464.

- Wheeler, J., Páez, M., Guillén-Gosálbez, G., and Mele, F. (2018). Combining multi-attribute decision-making methods with multi-objective optimization in the design of biomass supply chains. *Computers & Chemical Engineering*.
- World Bank Group (2018). Global solar atlas. <https://globalsolaratlas.info/>. Last checked on Sep 09, 2018.
- Wyatt, D. F., Wynn, D. C., Jarrett, J. P., and Clarkson, P. J. (2012). Supporting product architecture design using computational design synthesis with network structure constraints. *Research in Engineering Design*, 23(1):17–52.
- Yager, R. R. (2004). Generalized owa aggregation operators. *Fuzzy Optimization and Decision Making*, 3(1):93–107.
- Yang, Z., Lu, Q., Yan, J., Chen, J., and Yue, Q. (2018). Multidisciplinary optimization design for the section layout of umbilicals based on intelligent algorithm. *Journal of Offshore Mechanics and Arctic Engineering*, 140(3):031702.
- Yannou, B. (1998). Analyse fonctionnelle et analyse de la valeur. *Conception de produits mécaniques. Méthodes, modèles et outils*, pages 77–104.
- Yano, H. (2016). Fuzzy decision making for multiobjective stochastic programming problems. *Fuzzy Sets and Systems*, 296:97–111.
- Yao, W., Chen, X., Luo, W., van Tooren, M., and Guo, J. (2011). Review of uncertainty-based multidisciplinary design optimization methods for aerospace vehicles. *Progress in Aerospace Sciences*, 47(6):450–479.
- Yin, H., Yu, D., Yin, S., and Xia, B. (2018). Possibility-based robust design optimization for the structural-acoustic system with fuzzy parameters. *Mechanical Systems and Signal Processing*, 102:329–345.
- Yuan, L., Liu, Y., Sun, Z., Cao, Y., and Qamar, A. (2016). A hybrid approach for the automation of functional decomposition in conceptual design. *Journal of Engineering Design*, 27(4-6):333–360.
- Yvars, P.-A. (2009). A csp approach for the network of product lifecycle constraints consistency in a collaborative design context. *Engineering Applications of Artificial Intelligence*, 22(6):961–970.

- Zadeh, H. S. (2001). Membership function optimisation of a fuzzy logic controller for a non-linear system. *International Journal of Uncertainty, Fuzziness and Knowledge-Based Systems*, 9(06):839–850.
- Zha, X. F., Sriram, R. D., Fernandez, M. G., and Mistree, F. (2008). Knowledge-intensive collaborative decision support for design processes: A hybrid decision support model and agent. *Computers in Industry*, 59(9):905–922.
- Zhang, Z., Jin, G., and Li, J. (2017a). Penalty boundary sequential convex programming algorithm for non-convex optimal control problems. *ISA transactions*.
- Zhang, Z., Li, J., and Wang, J. (2017b). Sequential convex programming for nonlinear optimal control problem in uav path planning. In *American Control Conference (ACC), 2017*, pages 1966–1971. IEEE.
- Zheng, C., Bricogne, M., Le Duigou, J., and Eynard, B. (2014). Survey on mechatronic engineering: A focus on design methods and product models. *Advanced Engineering Informatics*, 28(3):241–257.
- Zimmermann, H.-J. (1975). Description and optimization of fuzzy systems. *International Journal of General System*, 2(1):209–215.

Appendices

Preliminary design example: portable cooler

This appendix is centred in exemplifying the use of the design tools that are used for generating the information for the methods presented in this thesis.

In this chapter it is intended to present the whole information related to the design of a portable cooler for food and beverages storing.

A.1. Planning and task clarification

In this section it is explained the translation of the information from Customer Requirements to Properties. This is made by understanding the input information and executing an External Function Analysis that allows to write functions and Properties related to the information that is the result from marketing activities.

The first task according in the methodology is to determine the Customer Requirements. This information was generated after a survey performed on 30 persons from 20 to 50 years old that covered five nationalities ¹ and a analysis validated with in a *focus group* composed by 6 persons form 22 to 29 years old².

The analysis of this information allow to write the design requirements of the product. Following the CPM/PDD nomenclature, this information is called Required Propeties and is listed in in Table A.1:

¹Colombian, French, Portuguese, Mexican and North American

²The group was composed by a 50-50 gender rate by Colombian persons

Table A.1: Customer Requirements list

N	Customer Requirements	Importance
CR1	Keep things cool	10
CR2	Easy to carry	6
CR3	Good Capacity	10
CR4	Easy to store	7
CR5	To be use as a sit	6

Considering this Customer Requirements is necessary because they allow to define a frame of the design centred in what the user needs. In this case, the most important requirements are centred in the *cooling capacity* and the *volume* of the cooler. Also, considering the requirements, it is possible to define the life situations of the product centred in the user too.

The use of functional analysis will determine the generation of a Product Design Specifications (PDS). Based in the understanding of the life situations of the product.

For the functional analysis it is necessary to understand the life situations that the product will experiment within its life cycle. It is based on the life situations described in Table A.2

Table A.2: Life situations of portable cooler

N	Life situation	N	Life situation
LS1	Design	-	LS6 Filled-up
LS2	Manufacture	-	LS7 Cleaned-up
LS3	Distribution	-	LS8 Stored
LS4	Stand by in use	-	LS9 Recycled
LS5	Transport		

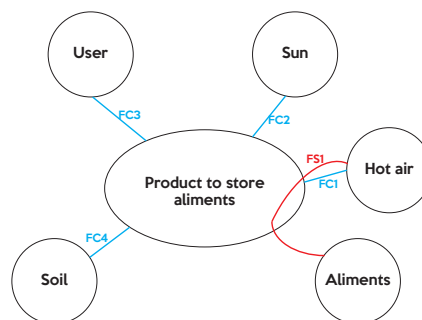

Figure A.1: LS4: Stand by in use

After the definition of the life situations, the next steps is analysing everyone of them in an octopus diagram. In Figure A.1 it is analysed the *stand by in use* situation. On Table A.3 are

listed some functions related to LS4 to LS6, which are related to the usage of the product.

Table A.3: Service and constraint functions on usage stage of portable cooler

Life Situation	Function description
LS4	FS1: Must keep the aliments cold in a warm environment for more than 5 hours
	FC1: Must resist the hot air
	FC2: Must resist the sun radiation
	FC3: Must resist the weight of a 80 Kg user
	FC4: Must stand still
LS5	FC5: Must fit into a car boot ³
	FC6: Must be carried by the user without effort
	FC7: Must have gripping surfaces
	FC8: Must resist any impact with other luggage
LS6	FS2: Must accomplish the volume required by the user
	FC9: Must have an ice compartment
	FC10: Must have a compartment for beverages
	FC11: Must have a compartment for solid food

Table A.4: Properties and CdCF

N	Function	Criteria	Level	Acceptance level
Pr1	Must keep the aliments cold	$temp < temp\ limit$	$temp\ limit = 8\ o\ C$	$temp\ ac = 10\ o\ C$
Pr2	Must resist the weight of a 80 Kg user	Resistance > Stress by user weight	Max user weight < 80Kg	Max user weight ac = 80Kg
Pr3	Must fit into a car boot	External lenght < MaxExt lenght	Max external lenght = 70cm	Max external lenght ac = 70cm
Pr4	Must fit into a car boot	External width < MaxExt width	Max external width = 35cm	Max external width ac = 35cm
Pr5	Must fit into a car boot	External height < MaxExt height	Max external height = 50cm	Max external height ac = 58cm
Pr6	Must be carried by the user without effort	Max empty weight < Empty weight	Empty weight < 15Kg	Empty weight ac = 17Kg
Pr7	Must accomplish the volume required by the user	Effective volume > Min internal volume	Min internal volume > 50l	Min internal ac > 45l

For demonstration purposes, only some functions are selected in this appendix . The selected functions are written in terms of properties into the Product Design Specifications (PDS) which is observed in Table A.4. In terms of information evolution, Customer Requirements (linguistic variables) evolved into *fuzzy numbers* in terms of Properties. This can be interpreted as "keep things cool" evolved into the function "must keep the aliments cold", which has associated to a

criteria, a level and an acceptance level.

The connection between Customer Requirements to Properties is made by the use of QFD matrix, that will make the connection between the two levels. Table A.5 relates only an extract from a full QFD matrix, and shows only what is relevant for the proposal to work. The extracted matrix features the correlation part, which indeed makes a connection between both parts *Customer Requirements* in linguistic field and *Properties*. Table A.5 contains the QFD extract of the correlation matrix between Customer Requirements to Properties.

Table A.5: Matrix 1: QFD extract of the cooler

<i>CR/Pr</i>	<i>Pr</i> ₁	<i>Pr</i> ₂	<i>Pr</i> ₃	<i>Pr</i> ₄	<i>Pr</i> ₅	<i>Pr</i> ₆	<i>Pr</i> ₇
<i>CR</i> ₁	●						
<i>CR</i> ₂						●	
<i>CR</i> ₃							●
<i>CR</i> ₄			●	●	●		
<i>CR</i> ₅		●					

Regarding to the connections between Properties and Functions, made on the External Functional Analysis, these connections can be watched on Table A.6.

Table A.6: Properties to functions of cooler

<i>PR/Fn</i>	<i>FS1 : Fn</i> ₁	<i>FC3 : Fn</i> ₂	<i>FC5 : Fn</i> ₃	<i>FC6 : Fn</i> ₄	<i>FS2 : Fn</i> ₅
<i>Pr</i> ₁	1				
<i>Pr</i> ₂		1			
<i>Pr</i> ₃			1		
<i>Pr</i> ₄			1		
<i>Pr</i> ₅			1		
<i>Pr</i> ₆				1	
<i>Pr</i> ₇					1

Finally, it is necessary to understand the flexibility levels of each Property. This flexibility is calculated by defining desirability functions μ .

In reference to the Property 1, it is needed that the temperature inside of the cooler be in a temperature adequate for the food and beverages. In this connection, the definition of this parameter should be centred in meeting the limitations of this products. For instance, some canned beverages are recommended to be drunk below 8°C, nevertheless, surveys with users indicate that ththose beverages can be drunk up to 10°C.

For Property 1, the proper membership function is Z, which can be used for decreasing values. it is needed that the temperature is low, so the closer to 0°C is better, and when it is close to

$10 \circ C$ is bad.

In the other hand, Property 7 is more related to the use of Pi function. Pi membership function is used when the value of the Property must be within certain values. For example, for the cooler the volume must be close to 50 liters, but if it is higher than 50 liters is harmful, but if its smaller than 40 liters is insufficient. Finally, the definition of the limit values and the type of membership function selected for the properties can be seen in the Table A.7. Lastly in Figure A.2 are shown the desirabilities functions of the Properties.

Table A.7: Intervals of desirability of Properties

	Type	a	b	c	d
$Pr_1 [oK]$	Z	277	283	-	-
$Pr_2 [Pa]$	Z	70×10^6	80×10^6	-	-
$Pr_3 [m]$	Z	0.45	0.7	-	-
$Pr_4 [m]$	Z	0.35	0.45	-	-
$Pr_5 [m]$	Z	0.4	0.5	-	-
$Pr_6 [kg]$	Z	14	18	-	-
$Pr_7 [l]$	Pi	35	45	50	50

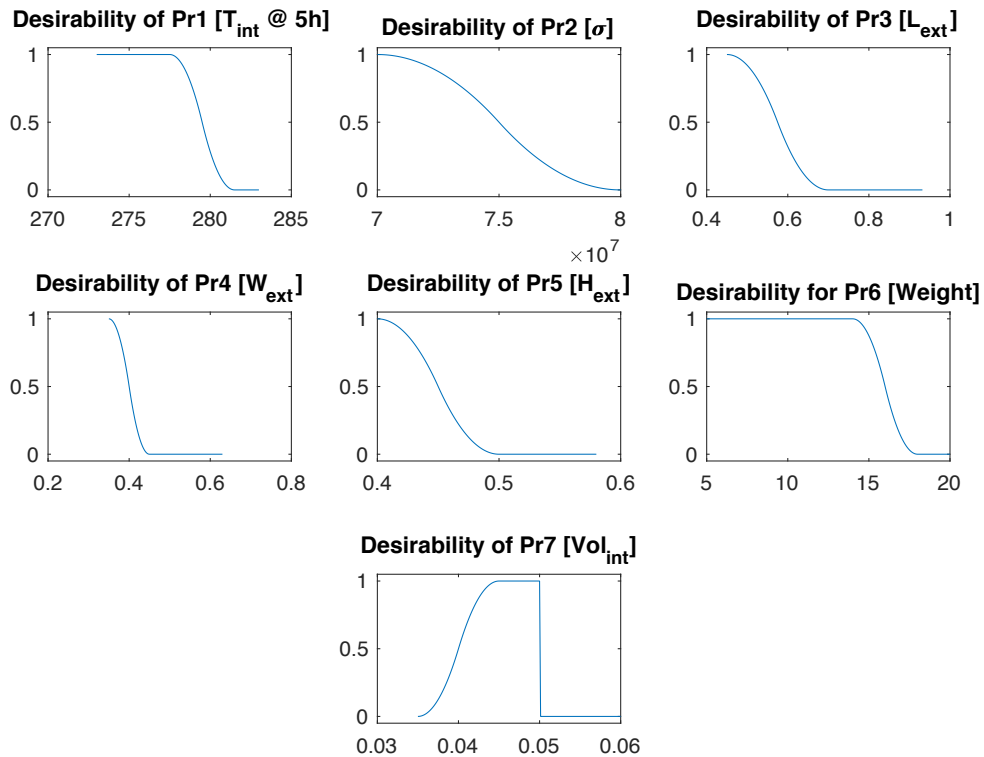

Figure A.2: Property desirability for the system

A.2. Conceptual design

Conceptual design is based on CPM/PDD + CTOC methodology proposed by Roozbeh et Al. (Malmiry et al., 2016). This tool is selected to be used in the proposed method because it empowers the analysis of each Property and its evolution into Relations and their variables (characteristics and external conditions).

In Figure A.3 is related the Function Block Diagram for the entire cooler. From this diagram, the function of *holding*, connected to Pr1, is extracted and analysed. This function is analysed under the FBS+CTOC+CPM/PDD approach proposed by Malmiry et al..

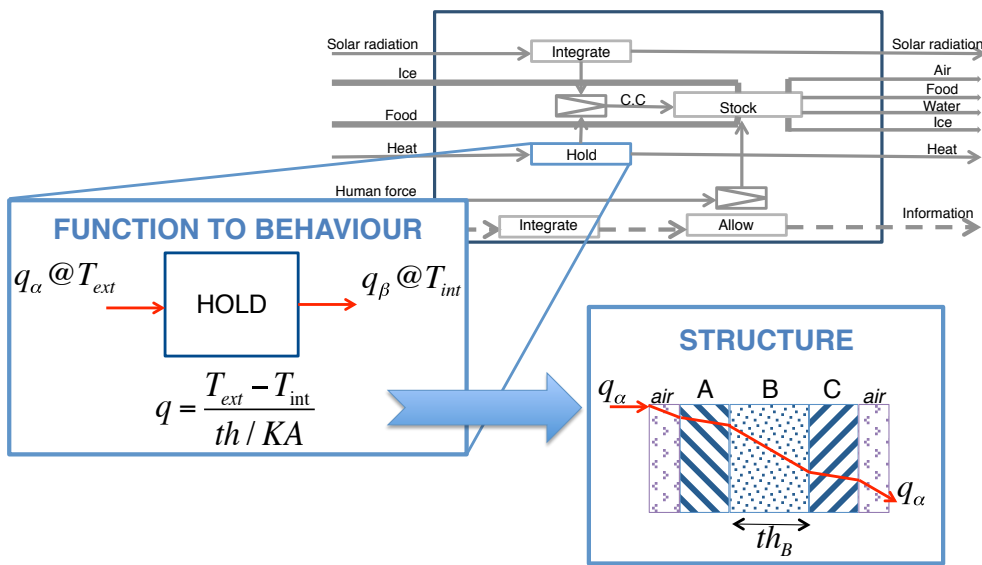

Figure A.3: Function Block Diagram for cooler and Pr1 extraction

Understanding the transition between function to behaviour, it is determined how the physics rules the system. In this situation, it is determined that heat transfer process is a parallel circuit, of convection and conduction of heat.

In the transition between behaviour to structure, the cooler architecture is defined, describing its wall as the composition of three parallel plates: external surface (a), thermal insulator (b) and internal surface (c). Figure A.7 represents the results of the FBS+CTOC+CPM/PDD.

The relation that represents the thermal flux advancing through cooler walls is described in Equation A.1.

$$T = T_5 + e^{\frac{A_{eq} t (T_{ext} - T_0)}{C_p M h'_{eq}}} \tag{A.1}$$

A.2.1. Conceptual development for Pr_1

In detail, the heat transfer process is defined, along the wall as a convection-conduction-convection process. In Figure A.4 is the wall disposition of the product. In this process, the heat transfer must be analysed under two different phenomena. At the external air and internal air, there is a convection process, while through the walls of the product, there are conduction processes.

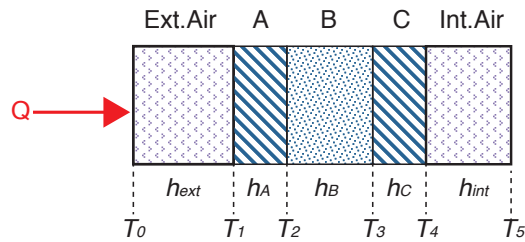

Figure A.4: Wall disposition

In order to propose frame for evaluating the temperature inside the cooler, it is necessary to define the first hypothesis, which is related to the homogeneity of the Mass in T_5 .

Hypotesis A:

$$Biot = \frac{h}{\lambda e} = \frac{h_{eq}}{\lambda} < 1$$

True:

The problem is thermally simple: uniform temperature fields inside the body

False:

Non-uniformity of temperature fields within the object

The second hypothesis is related to the loses. If $M_i C p_i$ between the layers is negligible or not.

Hypotesis B:

$$\begin{aligned} M_A C p_A \frac{\partial T_A}{\partial t} &= Q_1 - Q_2 \\ 0 &= Q_1 - Q_2 \\ 0 &= h_{ext} A_{Ef} (T_1 - T_0) - \frac{K_A}{th_A} A_{Ef} (T_2 - T_1) \end{aligned}$$

Where A_{Ef} is the heat transfer area in a closed box:

$$A_{Ef} = 2 * H_C * (L_C + W_C)$$

Based in the true of the Hypothesis B, that the heat flux is constant, the following equations are defined:

$$Q = h_{ext}A_{Ef} (T_1 - T_0) \quad (A.2)$$

$$Q = \frac{K_A}{th_A} A_{Ef} (T_2 - T_1) \quad (A.3)$$

$$Q = \frac{K_B}{th_B} A_{Ef} (T_3 - T_2) \quad (A.4)$$

$$Q = \frac{K_C}{th_C} A_{Ef} (T_4 - T_3) \quad (A.5)$$

$$Q = h_{int}A_{Ef} (T_5 - T_4) \quad (A.6)$$

$$MCp \frac{\partial T_5}{\partial t} = Q \quad (A.7)$$

So, using Equations A.2, A.3, A.4, A.5, A.6, equalising the heat flow Q :

$$A_{Ef}Q \left(\frac{1}{h_{ext}} + \frac{1}{K_A/th_A} + \frac{1}{K_B/th_B} + \frac{1}{K_C/th_C} + \frac{1}{h_{int}} \right) = T_5 - T_0 \quad (A.8)$$

Where

$$\frac{1}{h_{eq}} = \frac{1}{h_{ext}} + \frac{1}{K_A/th_A} + \frac{1}{K_B/th_B} + \frac{1}{K_C/th_C} + \frac{1}{h_{int}} \quad (A.9)$$

A.2.1.1. Natural convection

In natural convection the motion of the fluid are only due to the variation in density, which represents the variation in temperature of the fluid. The exchange coefficient is a function of the delta of temperature between the fluid and the wall. In vertical walls with the air, is defined in the Equation A.10 (Nadeau and Sebastian, 2006, p. 11).

$$h_{conv} = 5.6 \left(\frac{\Delta T}{H_C T_{air}} \right)^{0.25} \quad (A.10)$$

This Equation A.10 regulates the behaviour for both convection situations, external air with external wall and internal air with internal wall. Nevertheless, the ΔT for both situations is unknown, so it is necessary to determine in an algebraically manner.

For doing so, an iterative approach is proposed in order to determine the ΔT to any design condition.

A.2.1.2. Convergence of ΔT in natural convection phenomena

1. The first step is to define initials ΔT_{ext0} and ΔT_{int0} in order to be evaluated. For example, $\Delta T = 3 \text{ } \circ K$ for both variables can be defined.
2. The next step is to calculate h_{ext} and h_{in} based in Equation A.10.
3. The equivalent h for the system is calculated. h_{eq} is calculated using the equation A.9. For the heat conduction elements, it is necessary to know the material and the thickness of each layer.
4. Later, it is necessary to solve the heat flux from Equation A.8:

$$Q = h_{eq} A_{Ef} (T_0 - T_5)$$

5. Having the heat flux, the next step is recalculating a new ΔT_{ext} and ΔT_{int} .

$$\Delta T_{ext} = \frac{Q}{h_{ext} A_{Ef}}$$

$$\Delta T_{int} = \frac{Q}{h_{int} A_{Ef}}$$

6. Finally, it is evaluated the difference between ΔT_{ext} and ΔT_{ext0} (for ΔT_{int} and ΔT_{int0}).

$$\epsilon = |\Delta T_{ext} - \Delta T_{ext0}|$$

7. If the error $\epsilon > 0.1 \text{ } \circ K$, then the iterative process is repeated, by defining new values of ΔT_{ext0} and ΔT_{int0} .

$$\text{New} \Delta T_{ext0} = \text{Old} \Delta T_{ext0} + 0.1$$

A.2.1.3. Evaluation of iterative process

The evaluation is made using the values from the *Preliminary Layout* that are related in Table A.14 In Figure A.5 is related the evolution of the error ϵ .

With the values of $\Delta T_{ext} = 6.8 \text{ } \circ K$ and $\Delta T_{int} = 6.7 \text{ } \circ K$, the values of the temperatures in each layer of the system can be calculated. Table A.8 relates those values.

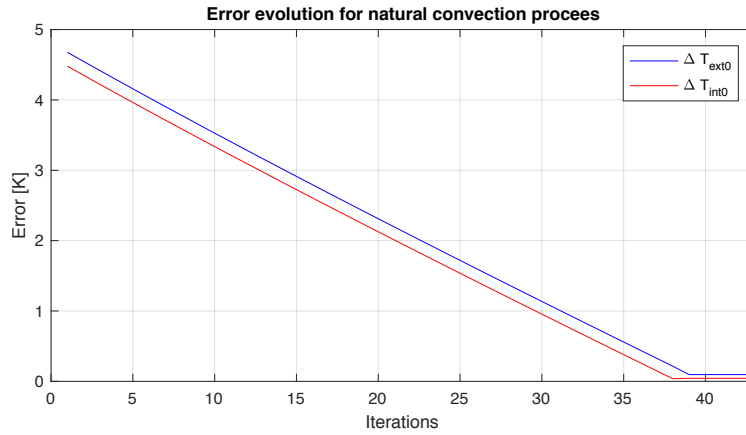

Figure A.5: Error evolution of the iterative process

Table A.8: Values of temperatures

Temperature	Value [°K]
T_0	303
T_1	296.2
T_2	294.6
T_3	281.2
T_4	279.7
T_5	273

A.2.1.4. Internal Temperature equation

Finally, Heat Flux equations can be written as (replacing $h'_{eq} = \frac{1}{h_{eq}}$):

$$Q = \frac{1}{h'_{eq}} A_{Ef} (T_0 - T_5) \quad (\text{A.11})$$

$$Q(t) = -MCp \frac{\partial T}{\partial t} \quad (\text{A.12})$$

An by equating A.11 and A.12, it is possible to write the temperature in function of the time:

$$\frac{1}{h'_{eq}} A_{Ef} (T_0 - T_5) = -MCp \frac{\partial T}{\partial t}$$

$$\partial t = -\frac{h'_{eq} MCp}{A_{Ef} (T_0 - T_5)} \partial T$$

Integrating in both sides of the equation:

$$\int_0^t \partial t = \int_{T_5}^T -\frac{h'_{eq} MCp}{A_{Ef} (T_0 - T_5)} \partial T$$

$$t = \left(-\frac{MCp}{A_{Ef}(T_0 - T_5)} \right) (\ln(T) - \ln(T_5))$$

$$\frac{A_{Ef}(T_0 - T_5)t}{h'_{eq}MCp} = -(\ln(T) - \ln(T_5))$$

$$\ln(T) = \ln(T_5) + \frac{A_{Ef}(T_0 - T_5)t}{h'_{eq}MCp}$$

And clearing logarithm in both sides of the equation:

$$e^{\ln(T)} = e^{\ln(T_5)} + e^{\frac{A_{Ef}(T_0 - T_5)t}{h'_{eq}MCp}}$$

$$T = T_5 + e^{\frac{A_{Ef}(T_0 - T_5)t}{h'_{eq}MCp}}$$

Finally, replacing h'_{eq} and A_{Ef} , the internal temperature can be written as:

$$T = T_5 + e^{\frac{t \cdot 2 H_C (L_C + W_C) (T_0 - T_5)}{C_p M \left(\frac{1}{5.6 \left(\frac{\Delta T_{in}}{H_C T_5} \right)^{1/4} + \frac{1}{5.6 \left(\frac{\Delta T_{ext}}{H_C T_0} \right)^{1/4} + \frac{th_A}{K_A} + \frac{th_B}{K_B} + \frac{th_C}{K_C}} \right)}}} \quad (A.13)$$

A.2.1.5. CPM/PDD

Afterwards, the CPM diagram can be build. The diagram can watched on Figure A.6. The use of these diagrams allow to build the traceability tree. Also its usage supports the writing of the expanded Equation A.1, which can be watched on Equation A.13.

As a summary, Pr_1 can be represented in one relation (Rel1), six subrelations, six characteristics and eight external conditions. Its Characteristics are:

- $th_A[m]$: Thickness of the external wall
- $th_B[m]$: Thickness of the insulator wall
- $th_C[m]$: Thickness of the internal wall
- $L_C[m]$: Internal length of the cooler
- $W_C[m]$: Internal width of the cooler
- $H_C[m]$: Internal height of the cooler
- $t_{id}[m]$: Thickness of the lid
- Mat_1 : Material of the external wall and internal wall. It will determine the density and heat transfer coefficient.
- Mat_2 : Material of insulator wall. It will determine the density and heat transfer coefficient.

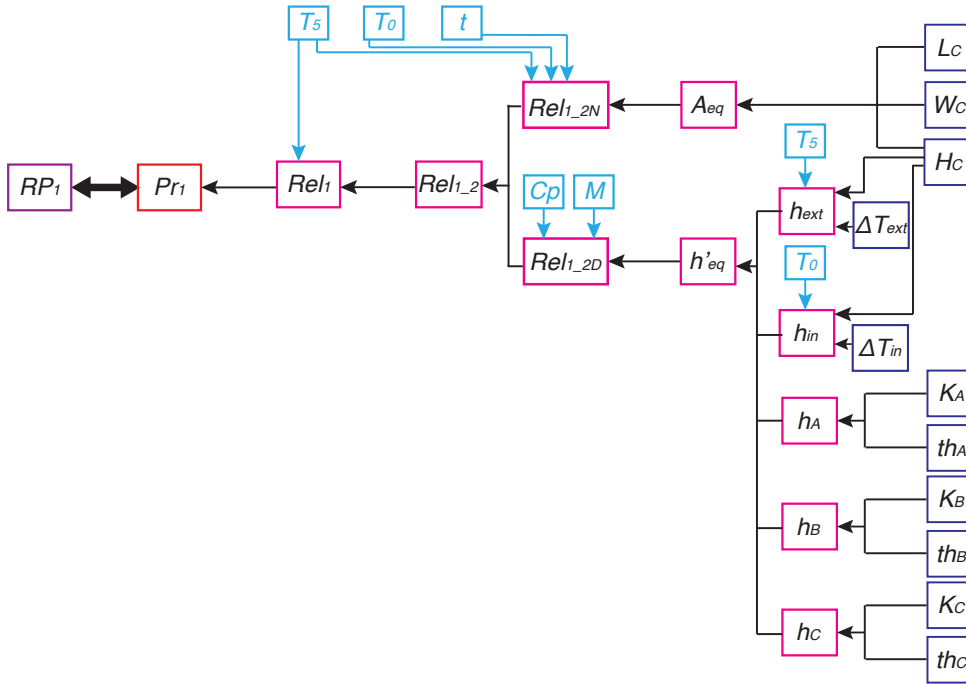

Figure A.6: CPM representation for Pr1

Regarding the External conditions, these are:

- $T_{ext} [^{\circ}K]$: External temperature
- $T_0 [^{\circ}K]$: Initial temperature inside the cooler
- $M [kg]$: Mass of beverages inside the cooler
- $Cp [\frac{J}{K}]$: Heat Capacity of food inside the cooler (water)
- $t [s]$: Time. Defined as 18,000 seconds (5 hours)
- $m_{user} [kg]$: Mass of the user

Finally, on A.7 can be watched the CTOC + FBS + CPM/PDD diagram that summarises the understanding of the physics of the Property and the translation of the information into Characteristics.

A.2.2. Conceptual development for Pr_2

In Figure A.9 is shown the representation of the interaction of the mass of the user with the cooler. The equation that represents this behaviour is listed in A.14.

$$\sigma = \frac{M_{user} * 9.81}{(th_A + th_B + th_C) L_C +} \tag{A.14}$$

A.2.3. Conceptual development for Pr_3 - Pr_5

In order to formulate the equations for external length, width and height, Figure A.10 is presented. This figure shows a lateral section of the geometry of the cooler.

Property 3 is related to the external length, and its shown in Equation A.15, Property 4, external width is in Equation A.16, and Property 5, external height is in Equation A.17.

$$L_{ext} = L_C + 2 * th_C + 2 * th_B + 2 * th_A \quad (A.15)$$

$$W_{ext} = W_C + 2 * th_C + 2 * th_B + 2 * th_A \quad (A.16)$$

$$H_{ext} = H_C + th_C + th_B + th_A + th_{lid} \quad (A.17)$$

A.2.4. Conceptual development for Pr_6

Property 6 is mostly defined by the weight of the cooler. This is calculated as:

- C_{part} : Internal part of the cooler, composed by the internal wall of the product. See Equation A.18
- B_{part} : Insulator layer.
- A_{part} : External part, layer of external wall.

$$C_{part} = ((H_C + th_C) (L_C + 2 th_C) (W_C + 2 th_C) - H_C L_C W_C) * \rho_C \quad (A.18)$$

The form for Part B and A is similar to Partc C.Finally, the weight is calculated as the sum of the three parts and expressed as:

$$m_{tot} = C_{part} + A_{part} + B_{part} \quad (A.19)$$

A.2.5. Conceptual development for Pr_7

Property 7 is defined as the internal volume which is related in Equation A.20

$$V_C = L_C * W_C * H_C \quad (A.20)$$

A.2.6. Matrices for traceability tree

Regarding to the construction of the traceability tree, these are the needed information. On Table is presented the relationships between Functions and Relations. The multiplication of Table A.6 and Table A.9 allow to have the connection between Properties and Relations.

Table A.9: Functions to Relations of cooler

F_n/Rel	Rel_1	Rel_2	Rel_3	Rel_4	Rel_5	Rel_6	Rel_7
F_{n_1}	1						
F_{n_2}		1					
F_{n_3}			1	1	1		
F_{n_4}						1	
F_{n_5}							1

Table A.10: Properties to Relations of cooler

Pr/Rel	Rel_1	Rel_2	Rel_3	Rel_4	Rel_5	Rel_6	Rel_7
Pr_1	1						
Pr_2		1					
Pr_3			1				
Pr_3				1			
Pr_4					1		
Pr_5						1	
Pr_7							1

Regarding to the relationship among Relations and Characteristics and External Conditions, these relationship is composed by three matrices: Relations to sub-relations (Table A.11), Relations to Characteristics (Table A.12) and Relations to External Conditions

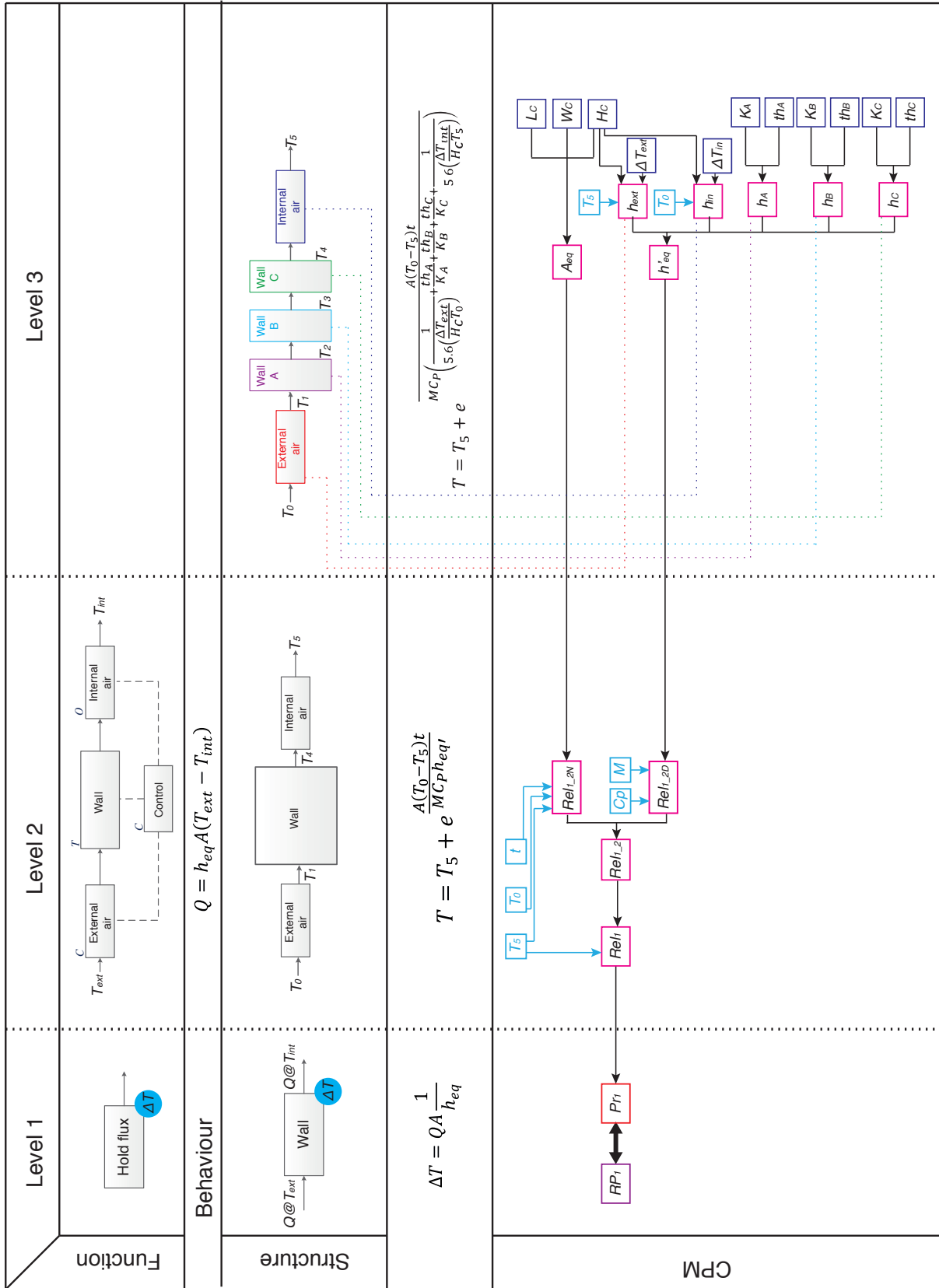

Figure A.7: Extract of CTOC + FBS diagram for P_{r1}

Figure A.8: CPM representation for Pr2

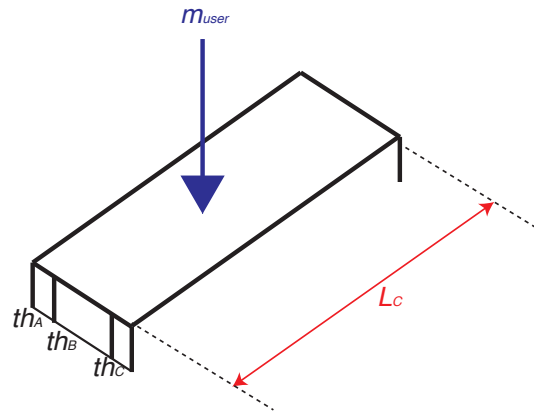

Figure A.9: Geometric representation

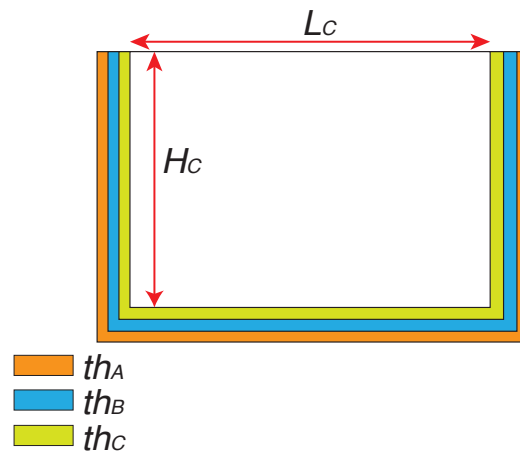

Figure A.10: Lateral section of the cooler

Table A.11: Relations to sub-relations of cooler

	<i>Rel</i> ₁	<i>Rel</i> ₂	<i>Rel</i> ₃	<i>Rel</i> ₄	<i>Rel</i> ₅	<i>Rel</i> ₆	<i>Rel</i> ₇	<i>Rel</i> ₁₂	<i>Rel</i> _{12N}	<i>Rel</i> _{12D}	<i>Rel</i> _{12D¹}	<i>Rel</i> _{12D²}	<i>Rel</i> _{12D³}	<i>Rel</i> _{2D}	<i>Rel</i> _{2D1}	<i>Rel</i> _{2D2}	<i>Rel</i> ₆₋₁	<i>Rel</i> ₆₋₂	<i>Rel</i> ₆₋₃	<i>Rel</i> ₆₋₄	<i>Rel</i> ₆₋₅	<i>Rel</i> ₆₋₆	<i>A</i> _A	<i>A</i> _B	<i>A</i> _C	<i>L</i> _A	<i>W</i> _A	<i>H</i> _A	<i>L</i> _B	<i>W</i> _B	<i>H</i> _B			
<i>Rel</i> ₁								1																										
<i>Rel</i> ₂															1																			
<i>Rel</i> ₃																																		
<i>Rel</i> ₄																																		
<i>Rel</i> ₅																																		
<i>Rel</i> ₆																	1	1	1															
<i>Rel</i> ₇																																		
<i>Rel</i> ₁₂									1	1																								
<i>Rel</i> _{12N}																																		
<i>Rel</i> _{12D}											1	1	1																					
<i>Rel</i> _{12D¹}																						1												
<i>Rel</i> _{12D²}																							1											
<i>Rel</i> _{12D³}																								1										
<i>Rel</i> _{2D}															1	1																		
<i>Rel</i> _{2D1}																																		
<i>Rel</i> _{2D2}																																		
<i>Rel</i> ₆₋₁																							1	1										
<i>Rel</i> ₆₋₂																								1										
<i>Rel</i> ₆₋₃																									1									
<i>Rel</i> ₆₋₄																																		
<i>Rel</i> ₆₋₅																																		
<i>Rel</i> ₆₋₆																																		
<i>A</i> _A																																		
<i>A</i> _B																																		
<i>A</i> _C																																		
<i>L</i> _A																																		
<i>W</i> _A																																		
<i>H</i> _A																																		
<i>L</i> _B																																		
<i>W</i> _B																																		
<i>H</i> _B																																		

Table A.12: Relations to Characteristics of cooler

	th_A	th_B	th_C	L_C	W_C	H_C	th_{id}	K_A	K_B	K_C	ρ_A	ρ_B	ρ_C
Rel_1													
Rel_2													
Rel_3	1	1	1	1									
Rel_4	1	1	1		1								
Rel_5	1	1	1			1	1						
Rel_6													
Rel_7				1	1	1							
Rel_{1_2}													
Rel_{1_2N}													
Rel_{1_2D}													
Rel_{1_2D1}	1							1					
Rel_{1_2D2}		1							1				
Rel_{1_2D3}			1							1			
Rel_{2D}													
Rel_{2D1}	1	1	1										
Rel_{2D2}													
Rel_{6-1}											1		
Rel_{6-2}												1	
Rel_{6-3}													1
Rel_{6-4}													
Rel_{6-5}													
Rel_{6-6}													
A_A		1	1	1	1								
A_B			1	1	1								
A_C				1	1								
L_A		1	1	1									
W_A		1	1		1								
H_A		1	1			1							
L_B			1	1									
W_B			1		1								
H_B			1			1							

Table A.13: Relations to External Conditions of cooler

	$T_{initial}$	T_{ext}	t	M	C_p	W
Rel_1	1					
Rel_2						1
Rel_3						
Rel_4						
Rel_5						
Rel_6						
Rel_7						
Rel_{1_2}						
Rel_{1_2N}	1	1	1			
Rel_{1_2D}				1	1	
Rel_{1_2D1}						
Rel_{1_2D2}						
Rel_{1_2D3}						
Rel_{2D}						
Rel_{2D1}						
Rel_{2D2}						
Rel_{6-1}						
Rel_{6-2}						
Rel_{6-3}						
Rel_{6-4}						
Rel_{6-5}						
Rel_{6-6}						
A_A						
A_B						
A_C						
L_A						
W_A						
H_A						
L_B						
W_B						
H_B						

Finally, the traceability tree of the information of the cooler can be watched in Figure A.11 and the corresponding traceability graph in Figure A.12.

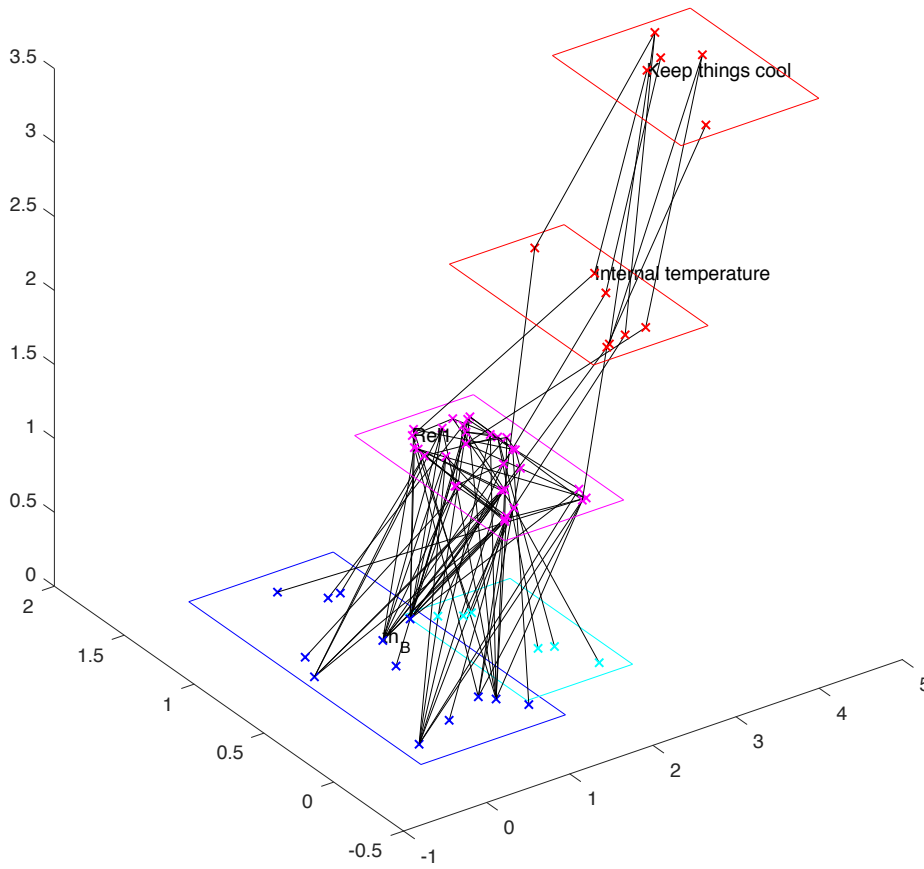

Figure A.11: Traceability tree of the cooler

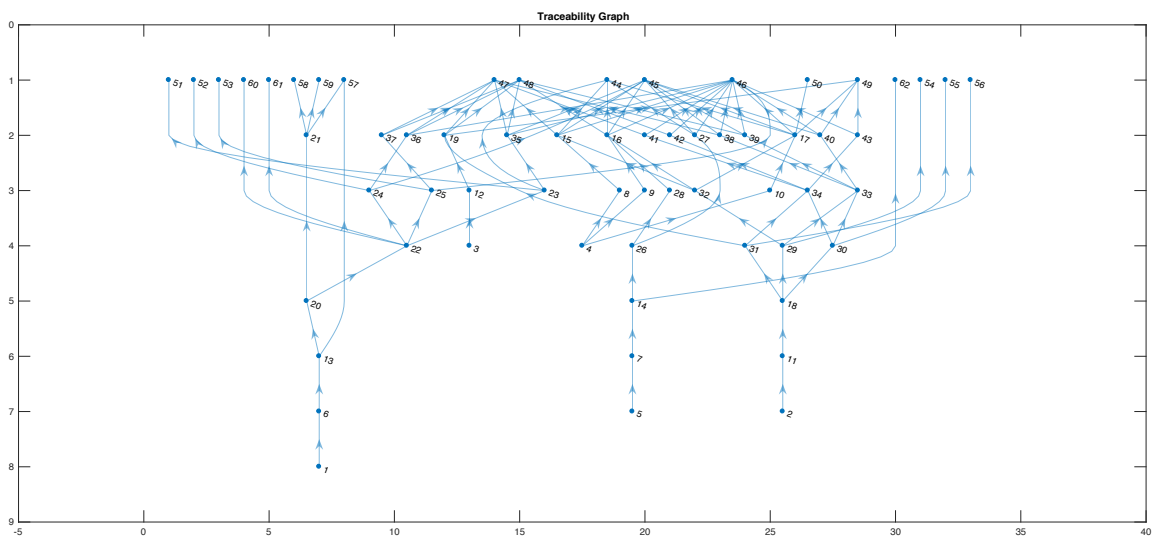

Figure A.12: Traceability graph

A.3. Embodiment design

In embodiment design, functions are solved, resulting into values that shape the characteristics. The order of how functions must be solved is aleatory Pahl et al. (2007). For the cooler it is suggested to regulate first the function with most geometrical influence, which is internal volume, represented in Equation A.20.

In Table A.4 is declared that the volume of the cooler must be 50 liters. In this connection, there are assigned values to L_C , W_C , H_C in order to make that the internal volume gets to 50 liters.

Another reason to abroad first the Internal Volume Property recalls in that is one of the easier equations to undermine. This is because it does not have influence of External Conditions, and has the lower Characteristics members. For instance, Rel_6 , Weight, has a more complex behaviour, that is shown in Figure A.13, where there are Characteristics, such as th_C , that are used nine times within the equation. Also, in Figure A.14 is the tree of Pr_1 , where the same Characteristics are presented, but also there is presence of External Conditions.

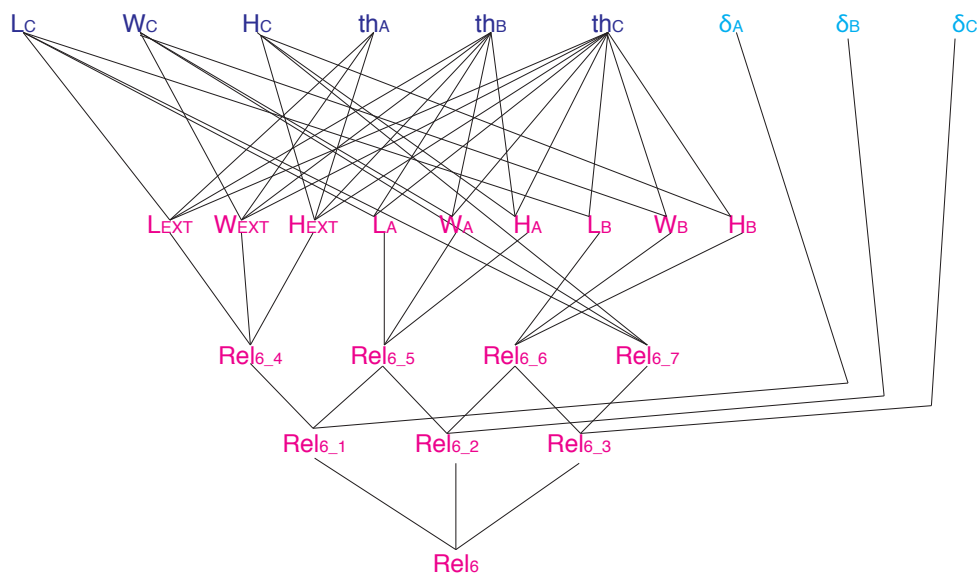

Figure A.13: Rel_6 tree

Defined values for Volume as $L_C = 0.4$, $W_C = 0.3125$, $H_C = 0.4$, the design process can continue by defining the values for the other characteristics. Also, the design team must define intervals for each Characteristic wherein the variables can be modified. Finally, in Table A.14 are shown the initial values for the Characteristics and External Values. The next step in a design methodology is to improve the product performance, which is the major contribution in this

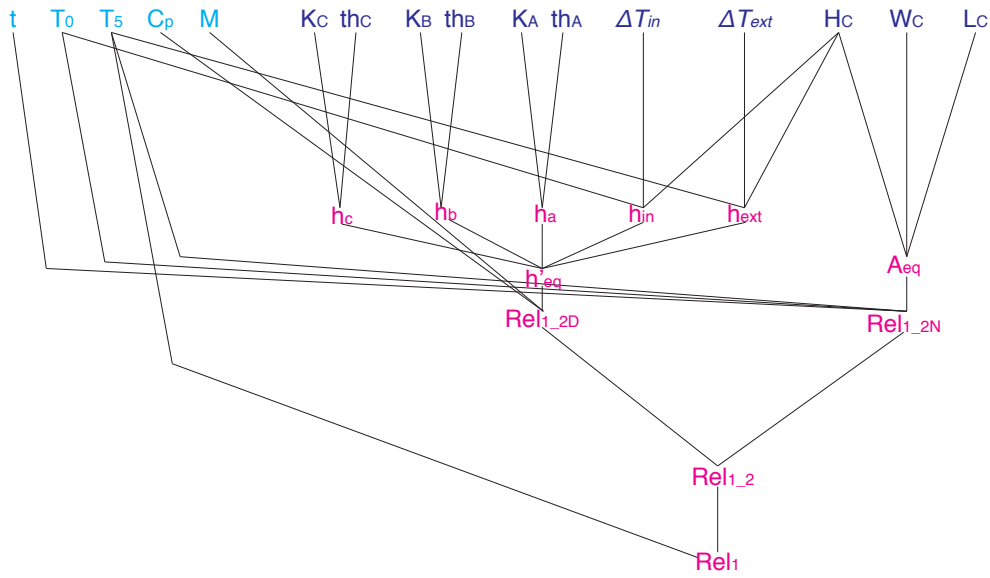

Figure A.14: Rel_1 tree

document and is explained in Chapters 4 and 5.

Table A.14: Characteristics and External Conditions intervals

Characteristic	In.Value	Min.	Max.	Preference		External Condition	Min.	Max.	Preference
$th_A[m]$	0.014	0.01	0.03	l		$T_{ext}[^{\circ}K]$	295	310	h
$th_B[m]$	0.027	0.01	0.03	h		$T_0[^{\circ}K]$	273	278	l
$th_C[m]$	0.014	0.01	0.03	l		$M[kg]$	20	30	fh
$L_C[m]$	0.34	0.40	0.60	c		$Cp[\frac{J}{K}]$	4181.3	4181.3	c
$W_C[m]$	0.31	0.20	0.45	c		$t[s]$	18000	18000	c
$H_C[m]$	0.30	0.20	0.50	c		$m_{user}[kg]$	60	80	c
$t_{iid}[m]$	0.034	0.03	0.04	c					
Mat_1	PP	-	-	-	-				
Mat_2	Foam	-	-	-	-				

APPENDIX B

Interactive framework and Website proposal

Regarding the interactive framework, it was developed an interface that empowers a a multi-user interface for decision-making, performing the the design validation can be performed in a multi-touch table (Figure B.1), granting the interaction of several designers at the same time.



Figure B.1: Multi-touch table at Universidad EAFIT

The interactive framework can be programmed in order to support this processes. This ap-

pendix is divided in two: Section §B.2 related a website proposal for the integration of the whole information of within the design process. and Section §B.1 relates the result of the programming of an interactive interface for the cooler design.

B.1. Interactive framework application

In order to facilitate the modification of the Characteristic's values, it was developed an application to support the traceability framework and the interactive framework.

This applications was developed with 3rd year Computer Science students at Universidad EAFIT in Colombia, in a collaborative work between the GRID research group and the subject "*Proyecto Integrador*"¹.

The name of the developed application is *SAAM*, and was written by the Students Julian Sánchez, Sebastián Ospina and Esteban Echavarría and supervised by myself, David Ríos-Zapata. The credits of the application can be observed in Figure B.2.

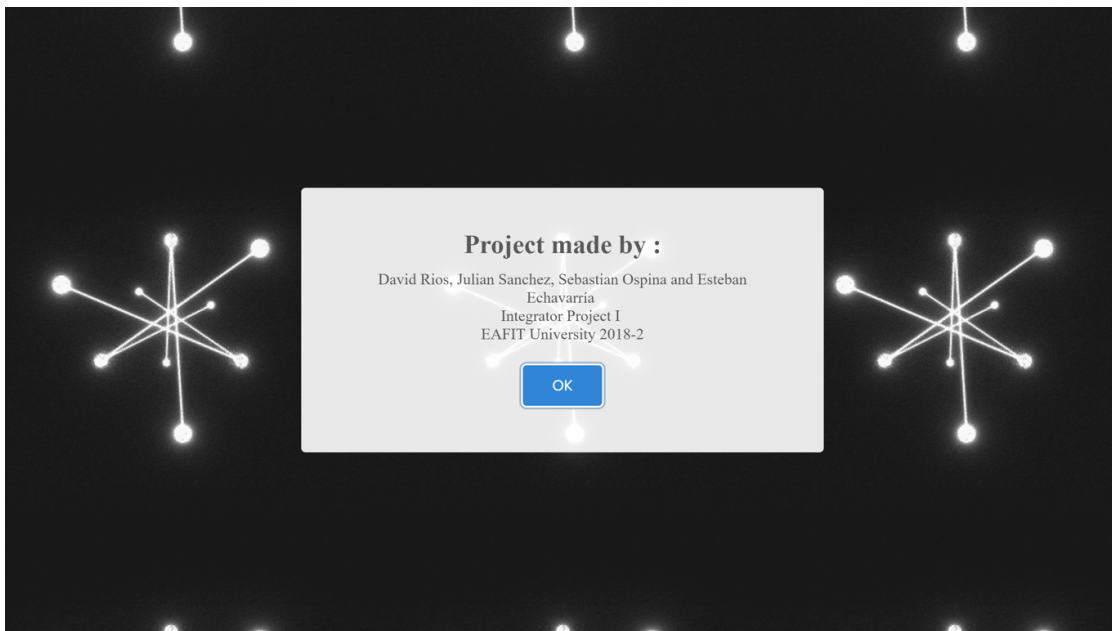

Figure B.2: Interactive framework credits

The application was developed for offering a platform for supporting the design team while interacting with the generated information through a design process. The Figure B.3 is a screenshot of the home page of the application, where the members of the team must register.

After the log-in process, the design team can watch an interact with the traceability tree of the

¹Spanish for Integrating Project

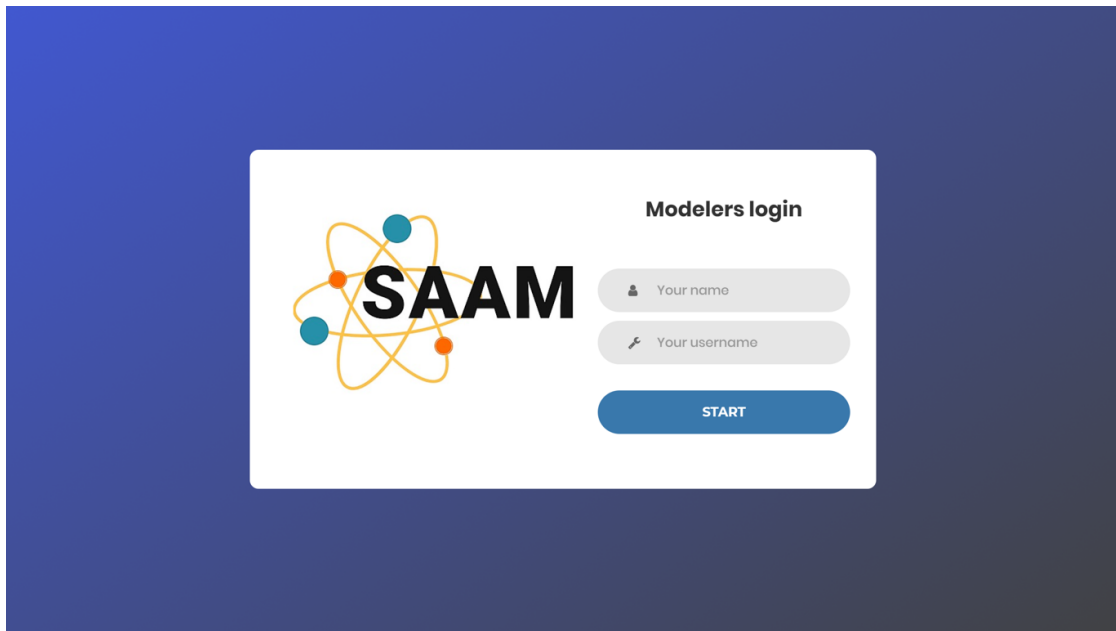

Figure B.3: Interactive framework homepage

design (See Figure B.4). The members of the design team can take of the elements and navigate in the tree, allowing them to understand the different connections that exist in the design. Figure B.5 represents the navigation between a Characteristic (th_A) and the Relations and sub-relations it makes part.

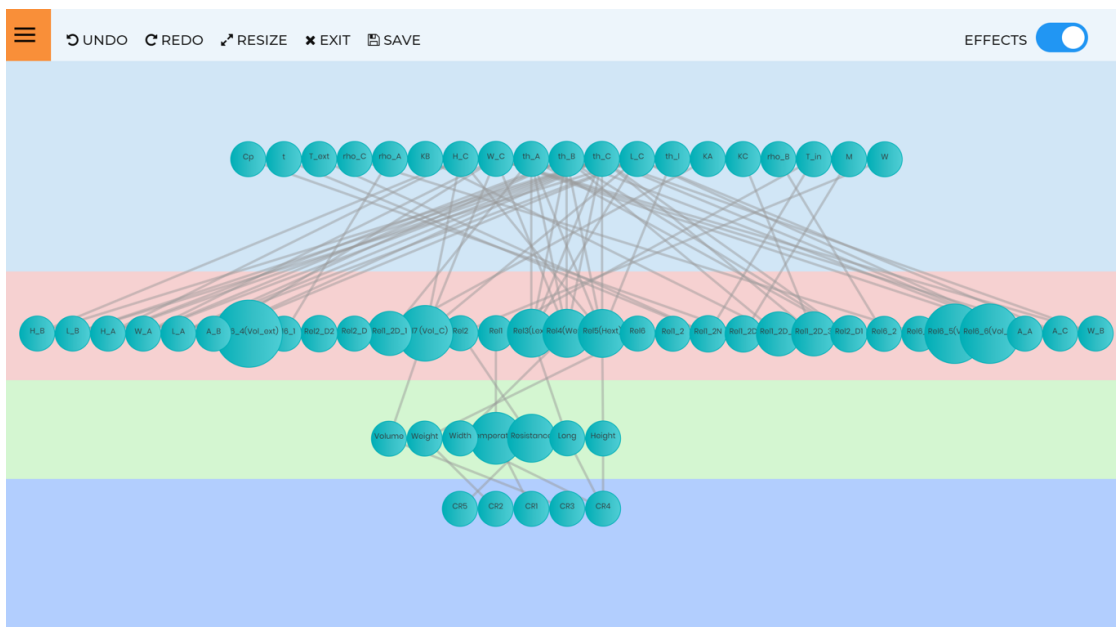

Figure B.4: Interactive framework traceability tree

Finally, by pressing any of the Characteristics, the equalisers will load. In Figure B.6 it can be

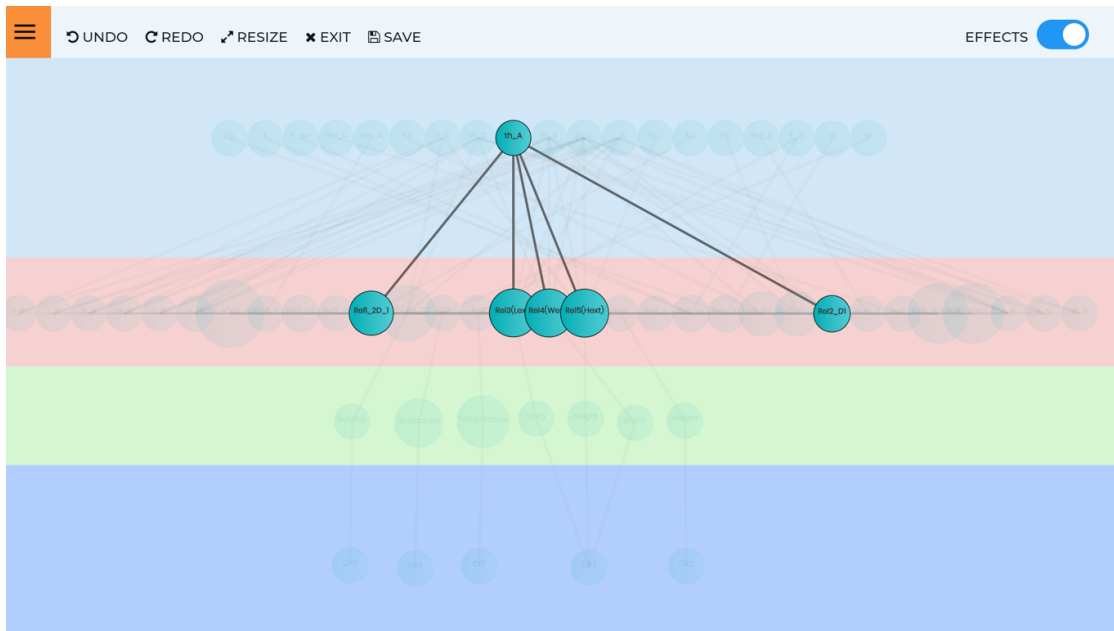

Figure B.5: Interactive framework traceability tree detail

observed the equaliser of a Characteristic (Th_A). The users can slide the value in the equaliser or set a value.

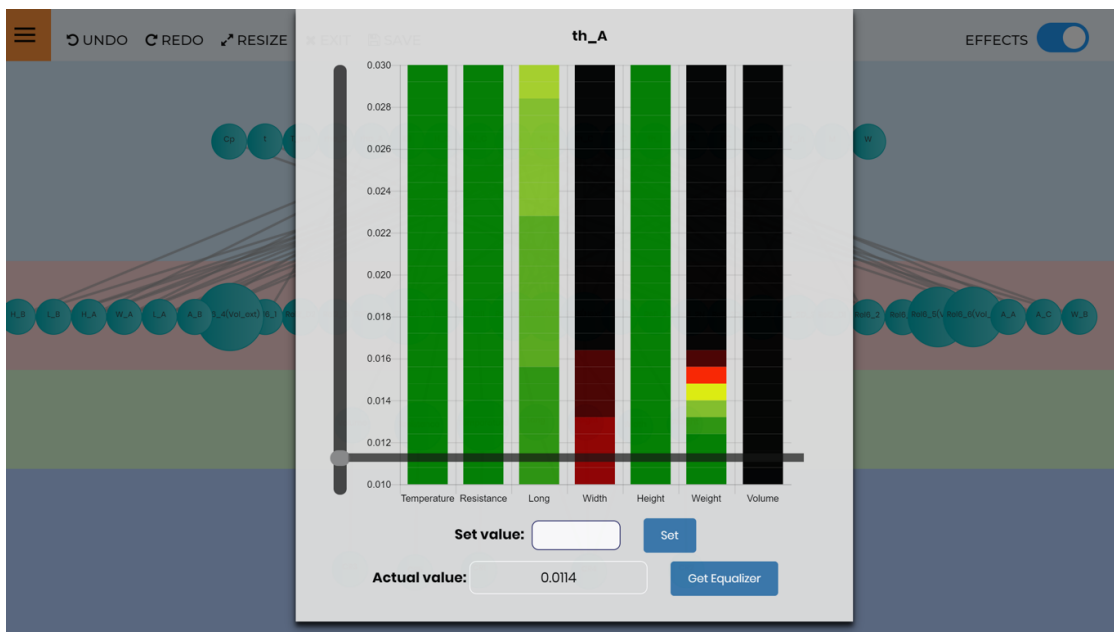

Figure B.6: Interactive framework equaliser

The application, SAAM, was build for being compatible with multi-touch interfaces. The libraries used in the programming of the application allow several users to interact with the application at the same time. It will depend on the hardware specifications, how many users can

interact. For example, for the table on Figure B.1, six persons can interact at the same time².

B.2. Website Proposal

The website integration allows to integrate the whole information into a single database. The website-framework is composed by several parts, merging the information related within the product development process. The for parts that compose the framework are:



- Connected properties in framework
- Unconnected properties in framework
- Evaluate impact in framework
- Information about the Property in framework

The proposed website is organised in different levels according to the information shown. The home menu is shown on Figure B.7. In this menu is stored information regarding the to the design team and any design log which is wished to be stored. Also, in this menu, the design team can select any Property to analyse. Also, the Property is shown in the μ colour that has in the present moment.

Figure B.8 is related to the Properties. In a given Property menu, the design team can see the the sensibility analysis and their related Characteristics. Also, it is presented the unrelated Characteristic and an indicator if the collateral relation is positive or negative. Also, two buttons are available if the design team want to see the associated Customer Requirement or the associated Required Property.

Figure B.9 is related to the Characteristics menu, were is presented the values of global sensibility analysis that the Property has with the Properties that it makes part. Also the behaviour were the design team can choose to watch or not. Finally, there is a button for entering on the framework for modifying the value of the Characteristics, that can be watched on Figure B.10.

²Table developed in the Universidad EAFIT in 2012 (Ríos-Zapata et al., 2014)

-home-

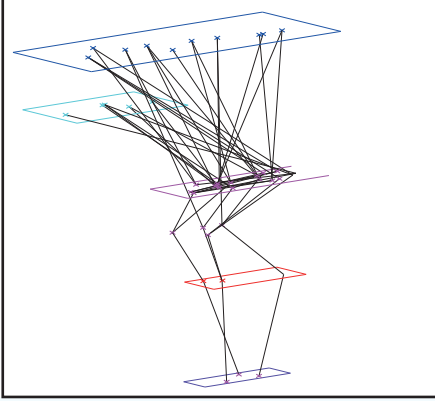

DESIGN NAME PROJECT

Design team Design team

Reviewer Reviewer

RELATED PROPERTIES

PR1

PR2

PR3

DESIGN LOG

01.06.2018 - DAVID. Modification of Ch1, Pr1 now in green desirability

28.05.2018 - DAVID. Definition of sensibility analysis for PR3

25.05.2018 - DAVID. Definition of sensibility analysis for PR1 and PR2

15.05.2018 - DAVID. Characteristics and Properties definition

02.05.2018 - DAVID. Creation of new project

Figure B.7: Website home

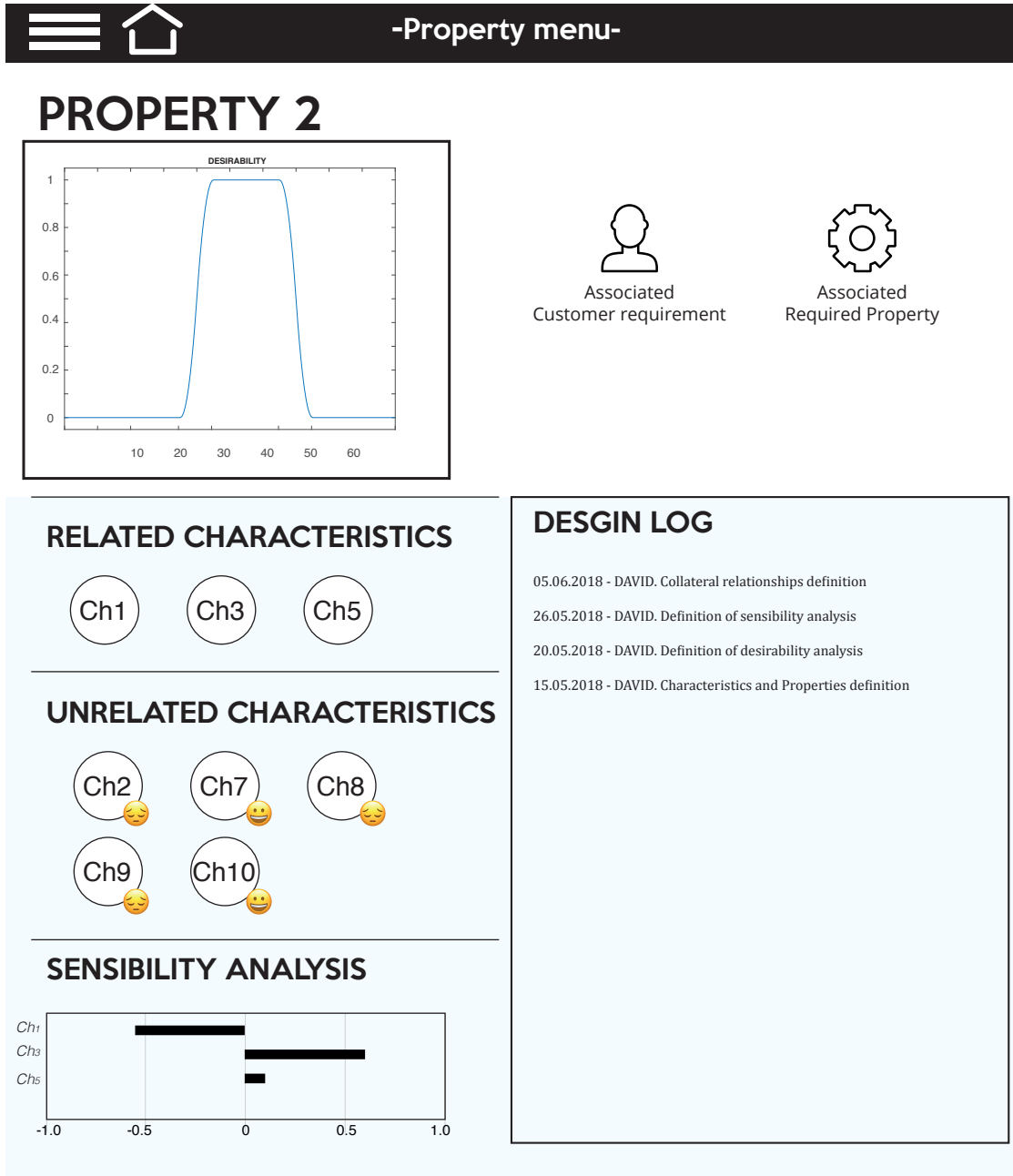

Figure B.8: Properties menu

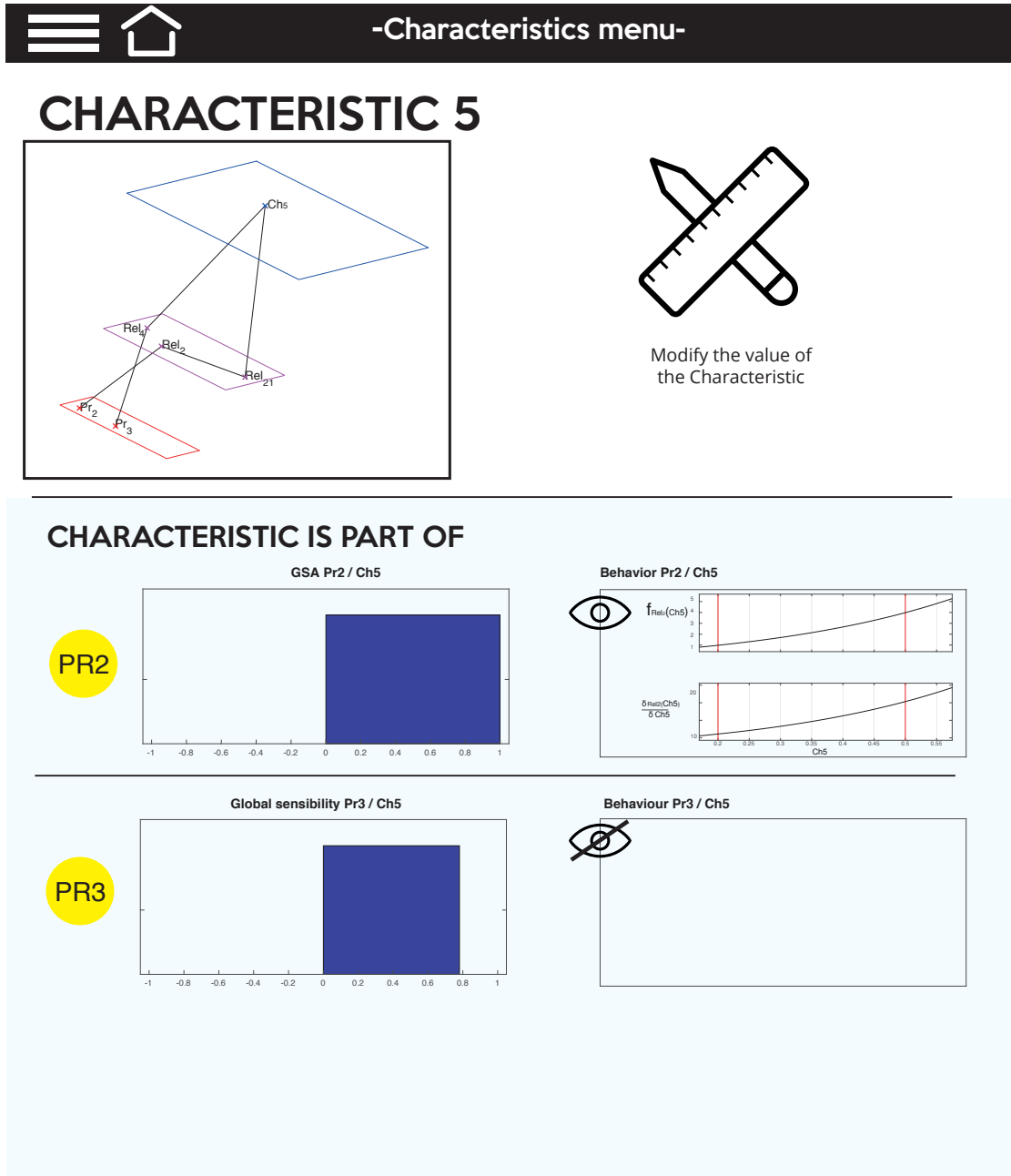

Figure B.9: Characteristics menu

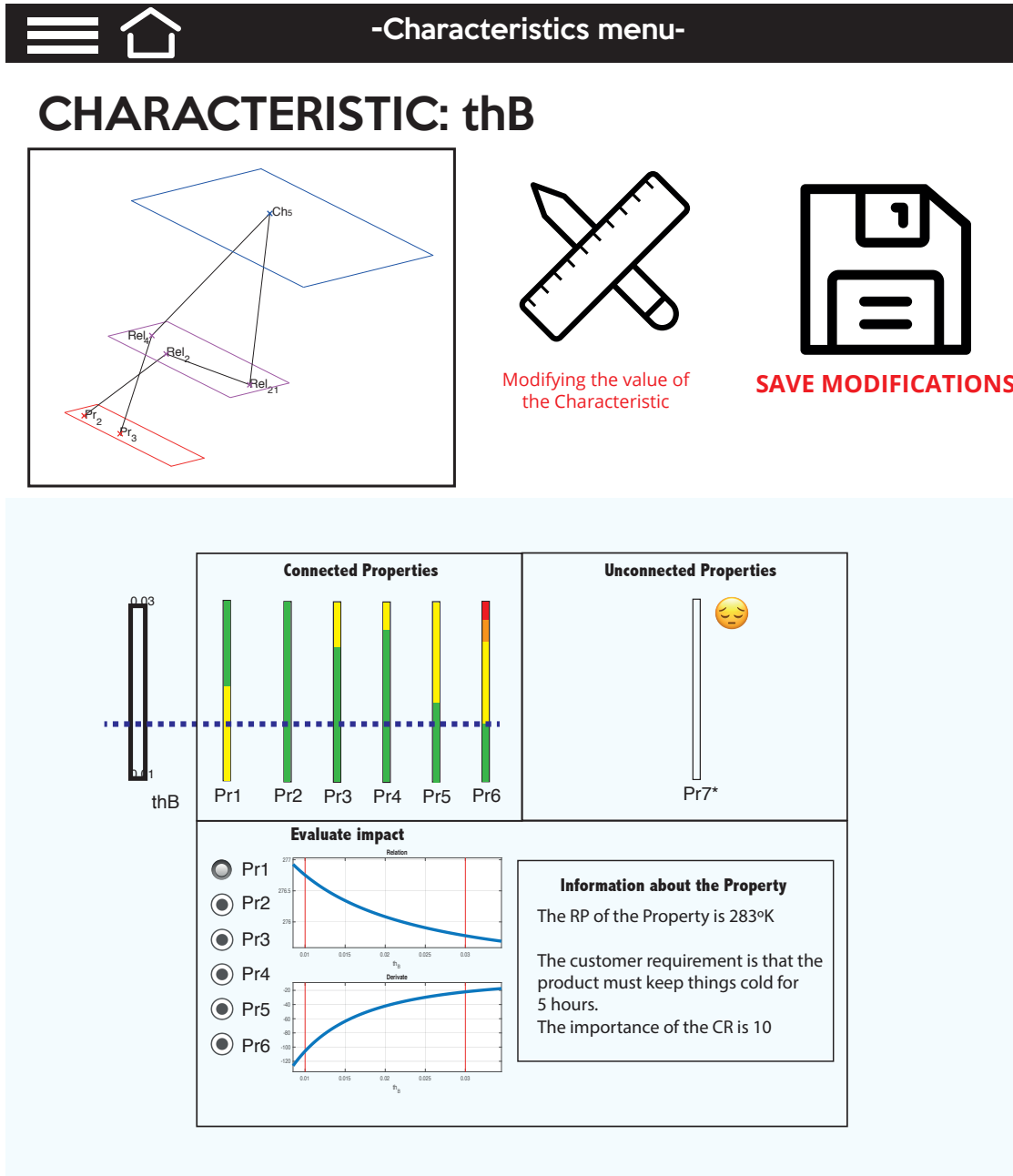

Figure B.10: Characteristics menu with modification framework

 SAPV system: Modelling of its components

C.1. Modelling of the PV module

PV module is an electric generator of DC by the transformation of solar energy into electrical energy. This transformation process depend on their operation conditions. The generation of the PV module depends on the radiation and the external temperature, and not current or voltage of operation.

The effect of the radiation on the behaviour of the PV module, must be categorised into two types: it is direct to the short-circuit current and has a logarithmic with the open-circuit voltage. Regarding the temperature, the generation depends on the temperature of the cells of the PV module, whence, the lower the temperature, lower the performance.

The physical behaviour, for determining the equivalent circuit and current output, can be modelled as (Borowy and Salameh, 1996):

$$I_{mp} = I_{CC} \left(1 - C1 \left(e^{\frac{V_m}{C2 * C_{CO}}} \right) \right) + \Delta I \quad (C.1)$$

$$V_{mp} = V_m \left(1 + 0.0539 * \log_{10} \left(\frac{G}{G_0} \right) \right) + \beta \Delta T \quad (C.2)$$

$$C1 = \left(1 - \frac{I_m}{I_{CC}} \right) e^{-\frac{V_m}{C2 * C_{CO}}} \quad (C.3)$$

$$C2 = \frac{\frac{V_m}{V_{CO}} - 1}{\ln\left(1 - \frac{I_m}{I_{CC}}\right)} \quad (C.4)$$

$$\Delta I = \alpha_0 \frac{G}{G_0} \Delta T + \left(\frac{G}{G_0} - 1\right) I_{CC} \quad (C.5)$$

$$\Delta T = T_C - T_r \quad (C.6)$$

$$T_C = T_a + \left(\frac{NOCT - 20}{800}\right) G \quad (C.7)$$

Where,

I_{mp}	[A]	Current intensity at maximum point (eq. C.1)
V_{mp}	[V]	Voltage intensity at maximum point (eq. C.2)
I_{CC}	[A]	Short-circuit current of the module
V_{CO}	[V]	Open-circuit voltage of the module
I_m	[A]	Maximum current of the module on standard conditions
V_m	[V]	Maximum open-circuit voltage of the module on standard conditions
G	[W/m ²]	Solar irradiation on an inclined plane
G_0	[W/m ²]	Solar irradiation on reference (1000 W/m ²)
α_0	[A/°C]	Temperature coefficient of I_{CC}
β_0	[A/°C]	Temperature coefficient of V_{CO}
T_C	[°C]	Temperature of the PV module (eq. C.7)
T_a	[°C]	Ambient temperature
T_r	[°C]	Reference temperature of the PV module

With the information of the module, the power output can be calculated as:

$$P_{mp} = I_{mp} * V_{mp} \quad (C.8)$$

And the loses of the system can be calculated as:

$$P_1(t) = N_{PV} \left(2 * \rho_c * \frac{L_1}{S_1}\right) I_{PV}^2(t) \quad (C.9)$$

$$P_2(t) = N_{PV}^2 \left(2 * \rho_c * \frac{L_2}{S_2}\right) I_{PV}^2(t) \quad (C.10)$$

$$P_3(t) = 2 * \rho_c * \frac{L_3}{S_3} I_{bat}^2(t) \quad (C.11)$$

Where,

P_{mp}	Power output of a PV module
$P_1(t)$	Power losses between module and connection box
$P_2(t)$	Power losses between connection box and inverter
$P_3(t)$	Power losses between module inverter and batteries
ρ_c	Resistivity of the copper electrical cable
L_1	Length of cable between PV and connection box
L_2	Length of cable between connection box and inverter
L_3	Length of cable between inverter and batteries
S_1	Cross-section area of cable between PV and connection box
S_2	Cross-section area of cable between connection box and inverter
S_3	Cross-section area of cable between inverter and batteries
N_{PV}	Quantity of PV modules
I_{PV}	Current of PV modules
I_{bat}	Current of batteries

C.2. Modelling of the storing system

The output power of a PV module is used to charge the battery. This output depends, first, on the time of the day, but also of the ambient temperature and the solar radiation. These fluctuations make complex the definition of the battery charge, known as State of Charge (SOC) (Shen, 2009). Still, the SOC is function of the charging current, affecting the performance of the battery (Boitier and Alonso, 2005).

The modelling of the energy storing system is necessary in order to calculate the SOC in order to define an energy management system that allows to optimise the SAPV system. The batteries can be mathematical described as (Shen, 2009):

$$E_B(t) = E_B(t-1)(1-\sigma) + \left(E_{PV}(t) - \frac{E_L(t)}{\eta_{ond}} \right) \quad (C.12)$$

$$I_{bat}(t) = \frac{P_{mp}(t)}{V_{bat}(t)} \quad (C.13)$$

$$V_{bat} = N_{b,s} \left(VF + b * \log(SOC(t)) + I_{bat}(t) \left(r1 + r2 * SOC(t) + \frac{1}{r3 + r4 * SOC(t)} \right) \right) \quad (C.14)$$

$$SOC(t) = \frac{E_B(t)}{C_{bn}} \quad (C.15)$$

Where,

$E_B(t)$	[Wh]	Energy stored in a battery per hour (eq. C.12)
$E_B(t - 1)$	[Wh]	Energy stored in a battery last hour
$E_{PV}(t)$	[Wh]	Energy generated by the PV module
$E_L(t)$	[Wh]	Energy demanded
t	[h]	Time of simulation. $t = 1h$
$I_{bat}(t)$	[A]	Current of the battery (eq. C.13)
P_L	[W]	Power demanded $t = 1h$
$V_{bat}(t)$	[A]	Voltage of the battery (eq. C.14)
$N_{b,s}$		Number of batteries installed in series
VF	[V]	Voltage on battery terminals
$b, r1 - r4$		Constants related to the characteristics of the battery (Table C.1)
σ		Hourly rate of self-discharge

Table C.1: Constants for lead–acid battery

Parameter	VF [V]	b	r1 [Ω]	r2 [Ω]	r3 [Ω]	r4 [Ω]
Charging	13.250	0.810	0.062	0.046	95.638	52.671
Discharging	12.662	0.724	0.055	-0.010	4.270	-100.730

SAPV system: External Functional Analysis

D.1. Guarantee an economic viability

Since the implementation of the SAPV system is focused to a developing country, the economic viability is plays an important role in the definition of the design. In Figure 6.4, in Section §6.2 was presented the EFA related to this requirement.

The analysis of the Figure 6.4 determines that the problem can be written in seven functions, five FC and two FS:

- FC_1 : The system must have a low initial investment cost
- FC_2 : The system must have a low component replacement cost
- FC_3 : The system must have a low maintenance cost
- FC_4 : The system must have a low costs related to the unavailability
- FC_5 : The system must have a short internal rate of return
- FS_1 : The costs due to weather uncertainties should be low
- FS_2 : The variation of internal rate of return due to weather uncertainties should be low

These set of functions are defined in order to guarantee the fulfilment of the economic viability. In this connection, it is necessary to define the limits for each function; later those limits will be

assigned to each Property, and based on those values, the desirability functions for each Property can be defined.

FC_1 , FC_5 and FS_1 , were already addressed in Section §6.2

Regarding the FC_2 , it is related to the replacement investments necessary for the SAPV system. PV modules, batteries, inverter and cables technologies have a determined life span, whereby, the impact of replacing components must be considered. The upper limit for this function should be set on 5000 €. About FC_3 , it is related to the maintenance cost, and its limit should be set in 100 €.

Connected to this Customer Requirement, there is also necessary to evaluate other aspects. FC_4 is related to the economic consequences of the failure of a component of the system and it allows calculate the cost related to the unavailability of the system, which is defined with an upper limit of 100,000 €. FS_1 , which is the service function related to the weather uncertainties should have an upper limit of 10 €.

For the whole set of functions, it is intended to create a list of Properties with a defined range of variation. CR_1 can be broken down in seven Properties, that can be watched on the PDS on Table 6.1 on Section §6.2.1.2.

D.2. Guarantee a service provided to the consumer

This Customer Requirement is related to performance of the SAPV system, specifically to the probability of losing power supply. In this connection, the Properties defined for fulfilling CR_2 are related to the quantity of electric energy generated by the PV modules, the energy stored by the batteries and the demanded load. To much batteries and PV modules, and the probability is low but the SAPV is oversized; to many batteries and PV modules, and the SAPV might not be able to satisfy the demand. On Figure D.1 is presented the EFA related to this CR.

The analysis of the Figure D.1 determines three FC and one FS:

- FR_6 The system must transform the solar energy in electric energy.
- FR_7 The systems allows to supply energy to electronic devices
- FR_8 The system must avoid an energy blackout
- FS_3 The variation of energy generation due to weather uncertainties should be low

FR_6 is related to generated energy of the PV modules. The objective of this energy is to supply energy to a determined load generated by electronic devices (FR_7). Still, what the SAPV

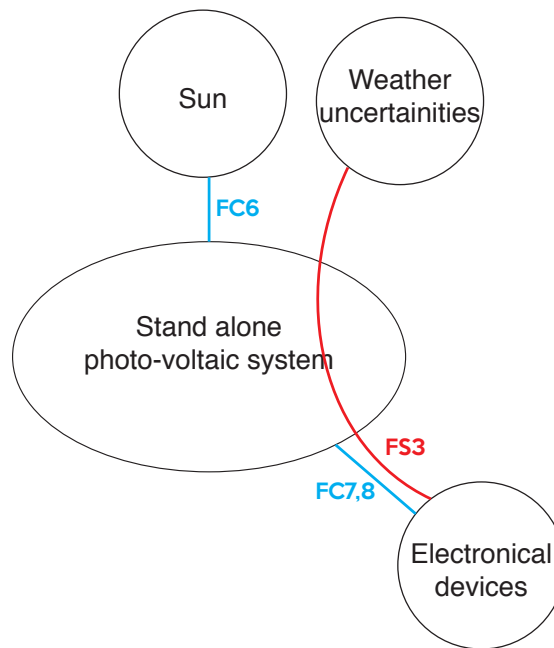

Figure D.1: EFA for energy provided

system must be centred is in avoiding energy blackouts. For measuring FR_8 it will be necessary to calculate the probability of the system experiencing a shortage at a given time.

In this connection, values of generated and stored energy (FR_6 and FR_7), the limits of FR_8 can be defined. The values of the probability should vary between 1% and 20 %. This definition will help to develop a solution that falls short in supplying electric energy and falling into situation of over-sizing of the system neither. FS_3 , which is the service function related to the weather uncertainties should variation between 0 a 3%.

These functions allow to define 4 Properties, two related to energy blackout rate and its sensibility due to uncertainties and two related to temporal blackout rate and its sensibility. In Section §6.2.1.2 can be seen the PDS with the definition on the Properties (Table 6.1).

D.3. Guarantee a small impact on the environment

As it was mentioned before, one of the tendencies of the XXI century is the development of more sustainable techniques for electricity generation. One of those techniques is the solar energy, where the energy is generated by PV modules. Nevertheless, the construction of these modules might generate a high number of greenhouse gases (Kato et al., 1998). The EFA (Figure D.2) must look forward meeting these environmental constraints.

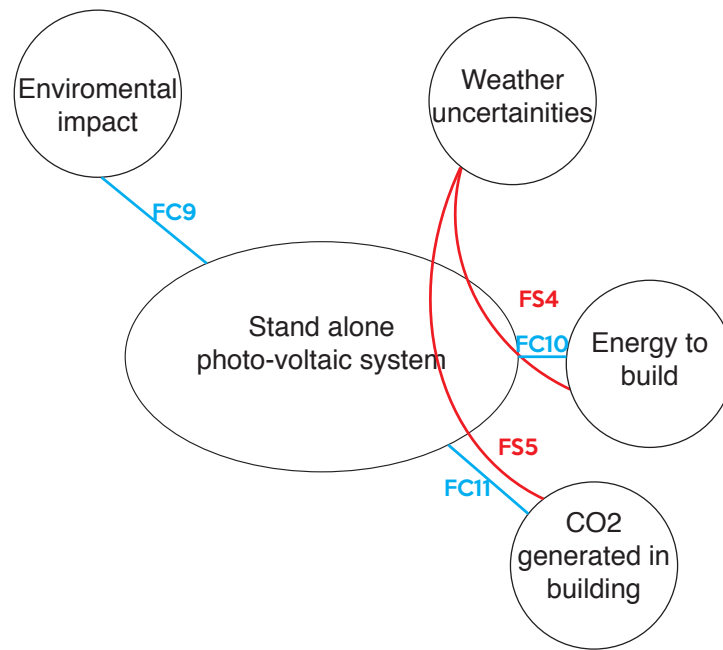

Figure D.2: EFA for environmental viability

Five functions can be written from the analysis of the Figure D.2:

- FR_9 The system must have a low environmental impact
- FR_{10} The systems must have a short energy return time
- FR_{11} The building of system must produce few CO^2 gases
- FS_4 The variation of energy return time due to weather uncertainties should be low
- FS_5 The variation of the production of CO^2 gases due to weather uncertainties should be low

The first of these functions, FR_9 , is centred in calculating the impacts on the environment and the on human health due to the manufacture of a PV system. This indicator can be measured on terms of money, and its upper limit will be defined in 10 €.

Regarding to the FR_{10} , this is related to the time need for the SAPV to produce the same energy that it was necessary to built the PV modules, batteries, inverters and cables. The upper limit for this Property is also set on 20 years. For FS_4 , the sensibility of the energy return time, the uppeer limit is defined in 10 years.

Regarding the emission of CO^2 , FR_{11} is related quantity of greenhouse gasses generated in the building process of the PV modules, batteries, inverters and cables; the limit of this Property

is set on $10e8$ g of CO_2 , while for its sensibility, the upper values is defined as 100g. On Table 6.1 are defined the limits for the Properties

SAPV system: Internal functional analysis

This appendix documents the development of the IFA for the SAPVS design.

E.1. Pr_1 - Initial investment cost

See Section §6.2.2 for its definition.

E.2. Pr_2 - Component replacement cost (CoR)

This Property is part of the economic viability category. The component replacement cost depends on the nature of each component and the years considered for the project to work. Concerning to the components life span, it is 20 years, 4 years, 15 years and 50 years to PV module, battery, inverter and cable respectively (Semassou, 2011). The Component replacement cost is defined by the Equation E.1.

$$CoR = QTY_{PV} * CI_{panel} + QTY_{bat} * CI_{bat} + QTY_{ond} * CI_{ond} + QTY_{cable} * CI_{cable} \quad (E.1)$$

Where,

- QTY_{PV} Quantity of PV modules during the project (Eq. E.2)
- QTY_{bat} Quantity of batteries during the project (Eq. E.3)
- QTY_{ond} Quantity of inverters during the project (Eq. E.4)
- QTY_{cable} Quantity of cables during the project (Eq. E.5)

In detail, the quantity of components is related as:

$$QTY_{PV} = \text{ceil}(\text{years}_{\text{project}}/\text{years}_{PV}) - 1 \quad (\text{E.2})$$

$$QTY_{\text{bat}} = \text{ceil}(\text{years}_{\text{project}}/\text{years}_{\text{bat}}) - 1 \quad (\text{E.3})$$

$$QTY_{\text{ond}} = \text{ceil}(\text{years}_{\text{project}}/\text{years}_{\text{ond}}) - 1 \quad (\text{E.4})$$

$$QTY_{\text{cable}} = \text{ceil}(\text{years}_{\text{project}}/\text{years}_{\text{cable}}) - 1 \quad (\text{E.5})$$

Where,

$\text{years}_{\text{project}}$ Years of the project considered in the analysis: 20.

On Table E.1 are related the Relations and Characteristics for this Property.

Table E.1: Variables related to Pr_2 : Component replacement cost

List of Properties	List of Relations	List of Characteristics	List of External Conditions
CR	QTY_{PV} , QTY_{bat} , QTY_{ond} , QTY_{cable} CI_{panel} , CI_{bat} , CI_{inv} , CI_{ond} , CI_{cable}	$\text{years}_{\text{project}}$, years_{PV} , $\text{years}_{\text{bat}}$, $\text{years}_{\text{ond}}$, $\text{years}_{\text{cable}}$ N_{PV} , T_{PV} , $Cost_{PV}$, N_{bat} , T_{bat} , $Cost_{PV}$, P_{ond} , $Cost_{\text{ond}}$, $L_{PV2\text{bor}}$, L_{bor2ond} , L_{ond2bat} , T_{cable1} , T_{cable2} , T_{cable3}	

E.3. Pr_3 - Maintenance and repair costs ($CoMR$)

Maintenance is part of the economic viability category. This Property is related to repairing cost that the SAPV most consider for the 20 years of the project. The maintenance cost is defined by the Equation E.6.

$$CoMR = \text{years}_{\text{project}} * (MMT_{PV} + MMT_{\text{bat}} + MMT_{\text{ond}} + MMT_{\text{cable}}) \quad (\text{E.6})$$

Where,

- MMT_{PV} Maintenance cost per year of a PV module: 0 €.
- MMT_{bat} Maintenance cost per year of the batteries: 7 €.
- MMT_{ond} Maintenance cost per year of an inverter: 28 €.
- MMT_{cable} Maintenance cost per year of the cables: 0 €.

On Table E.2 are related the Relations and Characteristics for this Property.

Table E.2: Variables related to Pr_3 : Maintenance and repair costs

List of Properties	List of Relations	List of Characteristics	List of External Conditions
$CoMR$		$years_{project}$, MMT_{PV} , MMT_{bat} , MMT_{ond} , MMT_{cable}	

E.4. PR_4 - Cost related to the unavailability of the system (NPC_{loss})

This Property is part of the economic viability category. It is related to the economic consequences of the failure of a component of the system. That is to say, NPC_{loss} is related to the cost of a kWh not provided due to the unavailability of the system (Semassou, 2011). This Property is defined by the Equation E.7.

$$NPC_{loss} = NPC_{loss-cte} * Pot_{year} / prix_{energy} \quad (E.7)$$

Where,

$NPC_{loss-cte}$	Loss of Energy Expectation
Pot_{year}	Power generated by the PV system in a year
$prix_{energy}$	Price of the energy

On Table E.3 are related the Relations and Characteristics for this Property,

Table E.3: Variables related to Pr_4 : cost related to the unavailability of the system

List of Properties	List of Relations	List of Characteristics	List of External Conditions
NPC_{loss}	CI_{panel} , Pot_{year}	N_{PV} , T_{PV} , $NPC_{loss-cte}$	$prix_{energy}$

E.5. Pr_5 - Internal Rate of Return (TRI)

Internal rate of return is part of the economic viability category, and it is related to the time when the incomes of the project exceeds the investment for the initiation of this one. This rate is defined by the Equation E.8.

$$TRI = Cost_{total} / (Pot_{year} / prix_{energy}) \quad (E.8)$$

With,

$$Cost_{total} = LCC + LCC_{loss} \quad (E.9)$$

$$LCC = CI + CR + CMR * PWA \quad (E.10)$$

$$LCC_{loss} = NPC_{loss} * PWA \quad (E.11)$$

$$PWA = \frac{(1 + ir)^{years} - 1}{ir(1 + ir)^{years}} \quad (E.12)$$

Where,

- $Cost_{total}$ Total economic cost of system life-cycle (Eq. E.9)
 LCC Life-cycle cost of the system (Eq. E.10)
 LCC_{loss} Losses related to life-cycle cost (Eq. E.11)
 PWA Annual value update coefficient (Eq. E.12)
 ir Interest rate

On Table E.4 are related the Relations and Characteristics for this Property.

Table E.4: Variables related to Pr_5 : Internal Rate of Return

List of Properties	List of Relations	List of Characteristics	List of External Conditions
TRI	$LCC, LCC_{loss}, PWA, Pot_{year}, CI_{panel}, CI_{bat}, CI_{inv}, CI_{ond}, CI_{cable}, Qty_{PV}, Qty_{bat}, Qty_{ond}, Qty_{cable}$	$NPV, TPV, NPC_{loss-cte}, years_{project}, Cost_{PV}, N_{bat}, T_{bat}, Cost_{PV}, P_{ond}, Cost_{ond}, LPV_{2bor}, L_{bor2ond}, Lond_{2bat}, T_{cable1}, T_{cable2}, T_{cable3}, years_{project}, years_{PV}, years_{bat}, years_{ond}, years_{cable}, MMT_{PV}, MMT_{bat}, MMT_{ond}, MMT_{cable}$	$price_{energy}, ir$

E.6. Pr_6 - Energy outage rate ($LPSP$)

Loss of power supply probability is related to the service provided to the consumer. This technique calculates the probability of the system experiencing a shortage at a given time, and its

calculation is important in the development of SAPV systems (Abouzahr and Ramakumar, 1990). LPSP defined by the Equation E.13 (Riza et al., 2015; Borowy and Salameh, 1996).

$$LPSP = \frac{LPS}{E_{L-day}} \quad (E.13)$$

With,

$$LPS = E_{L-day} - E_{Sist-day} * \eta_{ond} \quad (E.14)$$

$$E_{Sist-day} = (E_{PV-day} + E_B - E_{B-min}) \quad (E.15)$$

$$E_{B-min} = (1 - DOD) * T_{bat} * N_{bat} \quad (E.16)$$

$$E_B = fn(N_{bat}, T_{bat}) \quad (E.17)$$

$$E_{PV-day} = fn(N_{PV}, T_{PV}) \quad (E.18)$$

$$E_{L-day} = 7 * Lamp + Radio + Mobile + TV + Fridge + Fan + Iron + DVD \quad (E.19)$$

Where,

LPS	Loss of Power Supply (Eq. E.14)
$E_{Sist-day}$	Energy generated by the system in a day (Eq. E.15)
E_{B-min}	Minimum energy stocked in the battery (Eq. E.16)
E_B	Energy stocked in the battery in a day (Eq. E.17)
E_{PV-day}	Energy generated by the PV modules in a day (Eq. E.18)
E_{L-day}	Load of energy consumed in a day (Eq. E.19)
η_{ond}	Efficiency of the inverter

On Table E.5 are related the Relations and Characteristics and External Conditions for this Property.

Table E.5: Variables related to Pr_6 : Energy outage rate

List of Properties	List of Relations	List of Characteristics	List of External Conditions
$LPSP$	$LPSP, E_{Sist-day}, E_{B-min}, E_B, E_{PV-day}, E_{L-day}, E_{L-day}$	$T_{PV}, N_{PV}, T_{bat}, N_{bat}, DOD, \eta_{ond}$	$C_{Lamp}, C_{Radio}, C_{Mobile}, C_{TV}, C_{Fridge}, C_{Fan}, C_{Iron}, C_{DVD}$

E.7. Pr_7 - Temporal outage rate (LLP)

Loss of Load Probability is related to the service provided to the consumer and its value is related to the probability that the system is unable to meet the demand. This Property is defined by the Equation E.20 (Posadillo and Luque, 2008).

$$LLP = \frac{\int_t E_{PV-t}}{\int_t E_{L-t}} \quad (E.20)$$

Where,

E_{PV-t} Energy generated by the system in t

E_{L-t} Load of energy consumed in t

On Table E.6 are related the Relations and Characteristics and External Conditions for this Property.

Table E.6: Variables related to Pr_7 : Temporal outage rate

List of Properties	List of Relations	List of Characteristics	List of External Conditions
LLP	$E_{Sist-t}, E_{PV-t}, E_{L-t}$	T_{PV}, N_{PV}	$C_{Lamp}, C_{Radio}, C_{Mobile}, C_{TV}, C_{Fridge}, C_{Fan}, C_{Iron}, C_{DVD}$

E.8. Pr_8 - Environmental impact indicator (C_{dom})

The Environmental impact indicator is part of the environmental viability category. It was considered on the Semassou study for calculating the impacts on the environment and the on human health due to the manufacture of a PV system. This impact seeks to limit the negative impacts and it is defined by the Equation E.21 (Semassou, 2011).

$$C_{dom} = \frac{Index_{energyPV} * (T_{PV})}{Cost_{environmentPV}} \quad (E.21)$$

Where,

$Index_{energyPV}$	Overall energy consumed during PV module manufacture
T_{PV}	Type of PV module
$Cost_{environmentPV}$	Environmental cost of PV module manufacture

On Table E.7 are related the Relations, Characteristics and External Conditions for this Property.

Table E.7: Variables related to Pr_8 : Environmental impact indicator

List of Properties	List of Relations	List of Characteristics	List of External Conditions
C_{dom}		$Index_{energyPV}, T_{PV}$	$Cost_{environmentPV}$

E.9. Pr_9 - Energy Pay Back Time (TRE)

This is part of the environmental viability category. The Energy pay back time is related to the needed time for the system to produce the same energy that it was necessary to built it systems. This index is defined by the Equation E.22 (Semassou, 2011).

$$TRE = \frac{(TRE_{PV} + TRE_{bat} + TRE_{ond} + TRE_{cable})}{Pot_{year}} \quad (E.22)$$

Where,

TRE_{PV}	Energy consumed for the PV module construction (Eq. E.23)
TRE_{bat}	Energy consumed for the batteries construction (Eq. E.24)
TRE_{inv}	Energy consumed for the inverter construction (Eq. E.25)
TRE_{cable}	Energy consumed for the cables construction (Eq. E.26)

In detail, the energy consumer of the components is related as:

$$TRE_{panel} = Index_{energyPV} * T_{PV} * N_{PV} \quad (E.23)$$

$$TRE_{bat} = Index_{energy-bat} * T_{bat} \quad (E.24)$$

$$TRE_{ond} = Index_{energy-ond} * P_{ond} \quad (E.25)$$

$$TRE_{cable} = Index_{energy-cable} * (L_{PV2bor} + L_{bor2ond} + L_{ond2bat}) \quad (E.26)$$

Where,

- $Index_{energy-bat}$ Overall energy consumed during battery manufacture
 $Index_{energy-ond}$ Overall energy consumed during inverter manufacture
 $Index_{energy-cable}$ Overall energy consumed during cables manufacture

On Table E.8 are related the Relations, Characteristics for this Property.

Table E.8: Variables related to Pr_9 : Energy Return Time

List of Properties	List of Relations	List of Characteristics	List of External Conditions
TRE	TRE_{panel} , TRE_{bat} , TRE_{inv} , TRE_{ond}	$Index_{energyPV}$, T_{PV} , N_{PV} , $Index_{energy-nat}$, T_{bat} , $Index_{energy-ond}$, P_{ond} , $Index_{energy-cable}$, L_{PV2bor} , $L_{bor2ond}$, $L_{ond2bat}$	

E.10. Pr_{10} - Emission of CO^2 (GES)

Emission of CO^2 is part of the environmental viability category. This index is related to the gases emissions generated for the manufacture, installation, maintenance and end of life of a SAPV. The emissions of greenhouse gases is defined by the Equation E.27 (Semassou, 2011).

$$GES = GES_{PV} + GES_{bat} + GES_{ond} + GES_{cable} \quad (E.27)$$

Where,

- GES_{PV} Greenhouse gases generated by PV module construction (Eq. E.28)
 GES_{bat} Greenhouse gases generated by batteries construction (Eq. E.29)
 GES_{inv} Greenhouse gases generated by the inverter construction (Eq. E.30)
 GES_{cable} Greenhouse gases generated by the cables construction (Eq. E.31)

In detail, the energy consumer of the components is related as:

$$GES_{panel} = Index_{GES-PV} * T_{PV} * N_{PV} * QTY_{PV} \quad (E.28)$$

$$GES_{bat} = Index_{GES-bat} * T_{bat} * N_{bat} * N_{bat} * QTY_{bat} \quad (E.29)$$

$$GES_{ond} = Index_{GES-ond} * P_{ond} * QTY_{ond} \quad (E.30)$$

$$GES_{cable} = Index_{GES-cable} * QTY_{cable} * (L_{PV2bor} + L_{bor2ond} + L_{ond2bat}) \quad (E.31)$$

Where,

$Index_{GES-PV}$	Overall Greenhouse gases generated during PV module manufacture: 1650 kg CO ² /Wh (Alsema and de Wild,
$Index_{GES-bat}$	Overall Greenhouse gases generated during battery manufacture: 0.06 kg CO ² /Wh
$Index_{GES-ond}$	Overall Greenhouse gases generated during inverter manufacture: 125 kg CO ² /kW
$Index_{GES-cable}$	Overall Greenhouse gases generated during cables manufacture: 65 kg CO ² /m

Finally, on Table E.9 are related the Relations, Characteristics for this Property.

Table E.9: Variables related to Pr_10 : Emission of CO²

List of Properties	List of Relations	List of Characteristics	List of External Conditions
GES	$GES_{panel},$ $GES_{bat}, GES_{inv},$ GES_{ond} $QTY_{PV}, QTY_{bat},$ $QTY_{ond},$ QTY_{cable}	$Index_{GES-PV}, T_{PV}, N_{PV},$ $Index_{GES-bat}, T_{bat}, N_{bat},$ $Index_{GES-ond}, P_{ond}, Index_{GES-cable},$ $L_{PV2bor}, L_{bor2ond}, L_{ond2bat}$ $years_{project}, years_{PV}, years_{bat},$ $years_{ond}, years_{cable}$	

E.11. Adjacent Properties: Sensitivity to climate uncertainties

The SAPV system is sensitive to several climate variations. For example, variations of the temperature increment the efficiency of the battery, but impacts the efficiency of the PV module; also, variation of the radiation decreases the capacity of the PV module to transform solar energy into electric energy.

The uncertainties on the temperature and irradiation are respectively $\mp 2^{\circ}C$ and $\mp 10W/m^2$ (Semassou, 2011). Those variations of temperature and radiation affect directly the following Properties: $NPC_{loss}, TRI, LPSP, LLP, TRE, GES$. Considering the variation by the uncertainty, complementing Properties can be calculated, representing a sensitivity indicator for the mentioned properties. On Table E.10 can be watched the list of those adjacent sensitivity Properties.

The sensitivity indicator can be calculated as the absolute value of the difference of the Property's values, where the maximum and minimum values are defined by influence of the system to the temperatures and radiation variations.

Table E.10: Adjacent Properties: Sensitivity to climatic uncertainties

Pr	Description
Pr ₁₁	<i>SNPCLoss</i> : Sensitivity of the unavailability of the system
Pr ₁₂	<i>STRI</i> : Sensitivity of return on investment time
Pr ₁₃	<i>SLPSP</i> : Sensitivity of energy outage rate
Pr ₁₄	<i>SLLP</i> : Sensitivity of temporal outage rate
Pr ₁₅	<i>STRE</i> : Sensitivity of energy Return Time
Pr ₁₆	<i>SGES</i> : Sensitivity of emission of CO ²

 Analysis of SAPVS sub-systems' Characteristics

F.1. Analysis of the Characteristics of the batteries

The batteries definition is related directly to seven Characteristics¹. Among these Characteristics, the type of battery (T_{bat}) and the quantity of batteries (N_{bat}) might change. The complementing Characteristics are fixed and related to the nature of the technology of the battery, which is lead-acid battery. In Table F.1 is presented the values for the Characteristics.

Table F.1: Variables related to the batteries

Characteristic	Type	Value
N_{bat}	Discrete	[1-10]
T_{bat}	2-value discrete	75Ah or 100 Ah
T_{bat}'	2-value discrete	0.9 kWh or 1.2 kWh
$Cost_{bat}$	Fixed	0.4 €/Wh (Thiaux, 2010)
$years_{bat}$	Fixed	4 years (Nema et al., 2010)
MMT_{bat}	Fixed	7 €/year (Nema et al., 2010)
$Index_{energy-bat}$	Fixed	359 kWh/kWh
$Index_{GES-bat}$	Fixed	0.06 Kg CO ₂ /Wh

*All references values from (Semassou, 2011), except when indicated.

¹Type of battery Property is declared twice, depending on the equation: T_{bat} is related to Ah and T_{bat}' to kWh

F.2. Analysis of the Characteristics of the inverter and cables

For the inverter, seven Characteristics² are defined. The whole set of Characteristics is fixed, inherited by the selection of the inverter. in Table F.2 the values can be watched.

Table F.2: Variables related to the inverter

Characteristic	Type	Value
P_{ond}	Fixed	3000 VA
P_{ond}'	Fixed	240 kW
η_{ond}	Fixed	0.9
$Cost_{ond}$	Fixed	0.5 €/VA (Thiaux, 2010)
$years_{ond}$	Fixed	15 years (Nema et al., 2010)
MMT_{ond}	Fixed	28 €/year (Nema et al., 2010)
$Index_{energy-ond}$	Fixed	0.4 kWh/VA
$Index_{GES-ond}$	Fixed	125 Kg CO ₂ /Kw

*All references values from (Semassou, 2011), except when indicated.

F.3. Analysis of the Characteristics of cables

Regarding the cables, 11 Characteristics are related to them. Among the set, eight are fixed, including geometry values such as the length of each of the segments. Those that vary are related to the transverse area of each of the segments, setting 2-value discrete variables for these three Characteristics. in Table F.3 are related the values.

F.4. Definition of complementing Characteristics and External Conditions

Finally, two more fixed Characteristics complement the set of 36: $years_{project}=20$ and $NPC_{loss-cte}=0.15$. Regarding to the eleven External Conditions, eight of them are linked to the load to be nourish and are related to the load by different electric appliances (See Table F.4). The other three External Conditions are $i_r=0.06$. $price_{energy}=0.16$ €/kW, and $Cost_{environmentPV}=0.15$ €/kWh (Semassou, 2011).

²Power of the inverter is declared twice, depending on the equation: P_{ond} is measured in VA and P_{ond}' in KW

Table F.3: Variables related to the cables

Characteristic	Type	Value
L_{PV2bor}	Fixed	7 m
$L_{bor2ond}$	Fixed	10 m
$L_{ond2bat}$	Fixed	4 m
T_{cable1}	2-value discrete	0.45 mm ² or 0.55 mm ²
T_{cable2}	2-value discrete	4.84 mm ² or 12.88 mm ²
T_{cable3}	2-value discrete	3.03 mm ² or 4.84 mm ²
$Cost_{cable}$	Fixed	0.45 €/m for a 2.5 mm ² , 0.55 €/m for a 4 mm ² cable, 3.03 €/m for a 25 mm ² cable, 4.84 €/m for a 35 mm ² cable and 12.88 €/m for a 50 mm ² cable
$years_{cable}$	Fixed	50 years
MMT_{cable}	Fixed	0
$Index_{energy-cable}$	Fixed	144 kWh/m
$Index_{GES-cable}$	Fixed	64.61 Kg CO ₂ /m

*All references values from (Semassou, 2011), except when indicated.

Table F.4: Variables related to the External conditions

E.Condition	Value (Semassou, 2011)
C_{Lamp}	52.56 kWh/year
C_{Radio}	14.6kWh/year
C_{Mobile}	0.16 6kWh/year
C_{TV}	87.6k Wh/year
C_{Fridge}	776.5 kWh/year
C_{Fan}	162 kWh/year
C_{Iron}	187.2 kWh/year
C_{DVD}	35.6 kWh/year

SAPV system: Values of the Properties within iterative evaluation

In this Appendix are related the final values after the SSNV implementation with the SAPVS design:

- In Table G.1 is related the Properties' values for each of the iterations.
- Table G.2 presents the obtained Properties' desirability at each of the iterations.

The evaluated Properties were:

Pr_1	CoI : Initial investment cost
Pr_2	CoR : Component replacement cost
Pr_3	$CoMR$: Maintenance and repair costs
Pr_4	NPC_{loss} : Cost related to the unavailability of the system
Pr_5	TRI : Return on investment time
Pr_6	$LPSP$: Energy outage rate
Pr_7	LLP : Temporal outage rate
Pr_8	C_{dom} : Environmental impact indicator
Pr_9	TRE : Energy Return Time
Pr_{10}	GES : Emission of CO ₂
Pr_{11}	$SNPC_{loss}$: Sensitivity of the unavailability of the system
Pr_{12}	$STRI$: Sensitivity of return on investment time
Pr_{13}	$SLPSP$: Sensitivity of energy outage rate
Pr_{14}	$SLLP$: Sensitivity of temporal outage rate
Pr_{15}	$STRE$: Sensitivity of energy Return Time
Pr_{16}	$SGES$: Sensitivity of emission of CO ₂

Table G.2: Properties desirability

	DCS1	DCS2	DCS3	DCS4	DCS5	DCS6	DCS7	DCS8	DCS9	DCS10	DCS11	DCS12	DCS13	DCS14	DCS15	DCS16	DCS17	DCS18	DCS19	DCS20	DCS21
Pr1	0.3841	0.3841	0.3841	0.3841	0.3841	0.3841	0.1893	0.1893	0.1893	0.1893	0.1893	0.1885	0.1885	0.1885	0.1885	0.1885	0.1885	0.1885	0.1885	0.1885	0.1885
Pr2	0.3973	0.3973	0.3973	0.3973	0.3973	0.3973	0.1986	0.1986	0.1986	0.1986	0.1986	0.1955	0.1955	0.1955	0.1955	0.1955	0.1955	0.1955	0.1955	0.1955	0.1955
Pr3	0.7550	0.7550	0.7550	0.7550	0.7550	0.7550	0.7550	0.7550	0.7550	0.7550	0.7550	0.7550	0.7550	0.7550	0.7550	0.7550	0.7550	0.7550	0.7550	0.7550	0.7550
Pr4	0.9998	0.9998	0.9998	0.9998	0.9998	0.9998	0.9997	0.9997	0.9997	0.9997	0.9997	0.9997	0.9997	0.9997	0.9997	0.9997	0.9997	0.9997	0.9997	0.9997	0.9997
Pr5	0.9964	0.9964	0.9964	0.9964	0.9964	0.9964	0.9981	0.9981	0.9981	0.9981	0.9981	0.9981	0.9981	0.9981	0.9981	0.9981	0.9981	0.9981	0.9981	0.9981	0.9981
Pr6	0.0000	0.0000	0.0000	0.0000	0.0000	0.0000	0.9298	0.9298	0.9298	0.9298	0.9298	1.0000	1.0000	1.0000	1.0000	1.0000	1.0000	1.0000	1.0000	1.0000	1.0000
Pr7	0.0000	0.0000	0.0000	0.0000	0.0000	0.0000	1.0000	1.0000	1.0000	1.0000	1.0000	1.0000	1.0000	1.0000	1.0000	1.0000	1.0000	1.0000	1.0000	1.0000	1.0000
Pr8	0.4629	0.4629	0.4629	0.4629	0.4629	0.4629	0.4629	0.4629	0.4629	0.4629	0.4629	0.4629	0.4629	0.4629	0.4629	0.4629	0.4629	0.4629	0.4629	0.4629	0.4629
Pr9	0.9452	0.9452	0.9452	0.9452	0.9452	0.9452	0.9947	0.9947	0.9947	0.9947	0.9947	0.9947	0.9947	0.9947	0.9947	0.9947	0.9947	0.9947	0.9947	0.9947	0.9947
Pr10	1.0000	1.0000	1.0000	1.0000	1.0000	1.0000	1.0000	1.0000	1.0000	1.0000	1.0000	1.0000	1.0000	1.0000	1.0000	1.0000	1.0000	1.0000	1.0000	1.0000	1.0000
Pr11	0.9760	0.9760	0.9760	0.9760	0.9760	0.9760	0.9460	0.9460	0.9460	0.9460	0.9460	0.9460	0.9460	0.9460	0.9460	0.9460	0.9460	0.9460	0.9460	0.9460	0.9460
Pr12	1.0000	1.0000	1.0000	1.0000	1.0000	1.0000	1.0000	1.0000	1.0000	1.0000	1.0000	1.0000	1.0000	1.0000	1.0000	1.0000	1.0000	1.0000	1.0000	1.0000	1.0000
Pr13	0.9064	0.9064	0.9064	0.9064	0.9064	0.9064	0.7893	0.7893	0.7893	0.7893	0.7893	0.7893	0.7893	0.7893	0.7893	0.7893	0.7893	0.7893	0.7893	0.7893	0.7893
Pr14	0.8844	0.8844	0.8844	0.8844	0.8844	0.8844	0.7399	0.7399	0.7399	0.7399	0.7399	0.7399	0.7399	0.7399	0.7399	0.7399	0.7399	0.7399	0.7399	0.7399	0.7399
Pr15	0.9999	0.9999	0.9999	0.9999	0.9999	0.9999	1.0000	1.0000	1.0000	1.0000	1.0000	1.0000	1.0000	1.0000	1.0000	1.0000	1.0000	1.0000	1.0000	1.0000	1.0000
Pr16	1.0000	1.0000	1.0000	1.0000	1.0000	1.0000	1.0000	1.0000	1.0000	1.0000	1.0000	1.0000	1.0000	1.0000	1.0000	1.0000	1.0000	1.0000	1.0000	1.0000	1.0000

Exploring the robustness of the SSNV with the SAPVS design

The exploration for studying the robustness of the method is evaluated by the modification of the preliminary layout (DSC_0), following this order:

- Scenario 1: modifying $N_{bat}=1$, $N_{PV}=1$, which is defining the lowest quantity of batteries and PV modules. The algorithm converges, to a different local minimum.
- Scenario 2: modifying $N_{bat}=3$, $N_{PV}=1$, which is letting the quantity of batteries in the mean value and defining the quantity of PV modules in the minimum value. The algorithm converges in 3 iterations loops.
- Scenario 3: modifying $N_{bat}=10$, $N_{PV}=4$ which is letting the quantity of PV modules in the mean value and defining the quantity of batteries in the minimum value. The algorithm converges in 3 iterations loops.
- Scenario 4: modifying $N_{bat}=10$, $N_{PV}=12$, which is defining the maximum quantity of batteries and PV modules. The algorithm converges, to a different local minimum.

H.1. Scenario 1

In the scenario 1, the SSNV method converges to solution in 21.12 seconds in 14 iterations. The proposed solution sets minimum quantity of batteries and the maximum of PV modules. In Table H.1 the Characteristics values can be seen.

Table H.1: Values of the Characteristic on scenario 1

Solution	N_{PV}	T_{PV}	N_{bat}	T_{bat}	T_{Cable1}	T_{Cable2}	T_{Cable3}
DCS_{14}	10	50W	1	75Ah	$0.45mm^2$	$4.84mm^2$	$3.03mm^2$

Also, in Figure H.1 it can be observed the evolution of the Properties' desirability. It can be watched how the μ of the Cost of Investment is very low. This happens because of the solution calculated 10 PV modules, which increases the price of the system dramatically. Finally, in Figure H.2 is presented the evolution of the GDI. The $Agg.\mu(Pr)$ was calculated in 0.0014095.

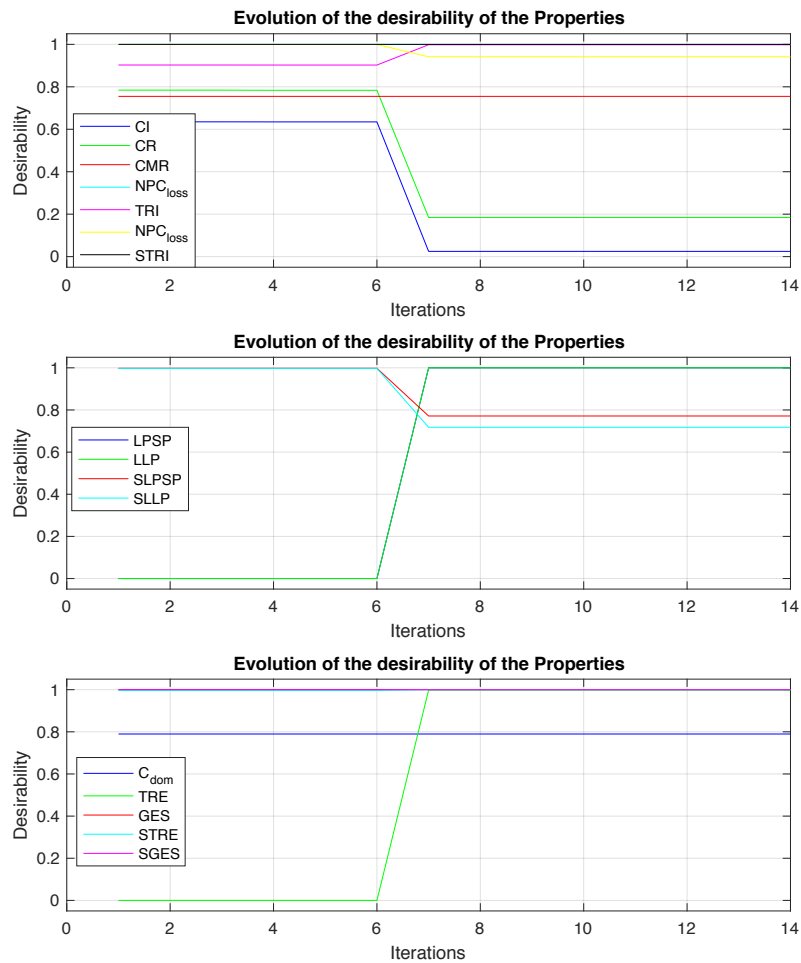

Figure H.1: Properties' desirability evolution in scenario 1

H.2. Scenario 2 and 3

For the scenarios 2 and 3, the SSNV method converges in 21 iterations, which is the same behaviour that occurred using the preliminary layout defined by the means of the Monte Carlo

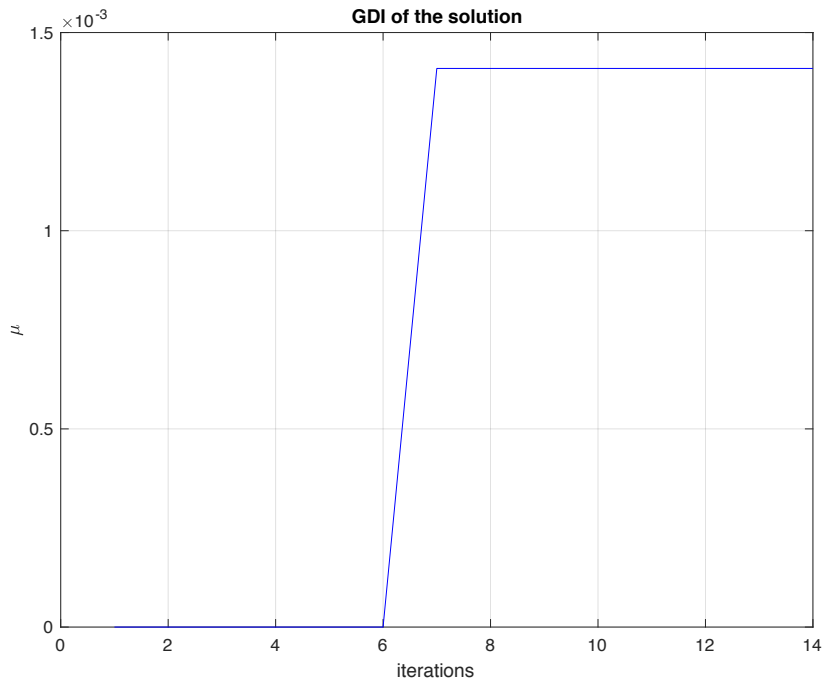

Figure H.2: GDI evolution in scenario 1

simulation, with an aggregates desirability of 0.007061. In Figure H.3 is presented the Properties' desirability evolution and in Figure H.4 the GDI can be observed. Finally, the used time for the calculations were:

- Scenario 2: 25.74 seconds
- Scenario 3: 25.10 seconds

H.3. Scenario 4

In the scenario 4, the SSNV method converges to solution in 24.551 seconds in 21 iterations. In Table H.2 the Characteristics values can be seen.

Table H.2: Values of the Characteristic on scenario 4

Solution	N_{PV}	T_{PV}	N_{bat}	T_{bat}	T_{Cable1}	T_{Cable2}	T_{Cable3}
DCS_{21}	9	50W	9	100Ah	0.45mm ²	4.84mm ²	3.03mm ²

Also, in Figure H.5 it can be observed the evolution of the Properties' desirability. It can be watched how the μ of the Cost of Investment is very low. This happens because of the solution calculated 9 PV modules, which increases the price of the system dramatically. Finally, in Figure H.6 is presented the evolution of the GDI. The $Agg.\mu(Pr)$ was calculated in 0.0036487.

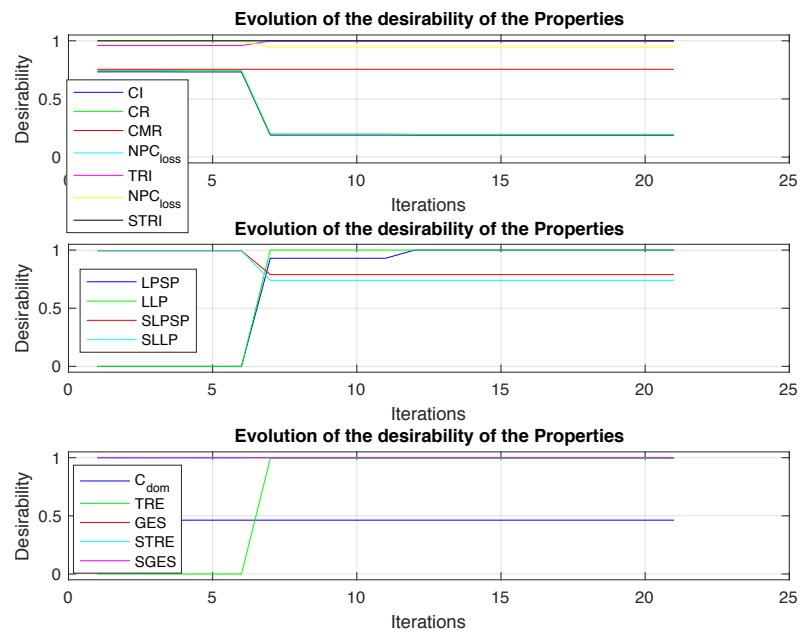

Figure H.3: Properties' desirability evolution in scenario 2

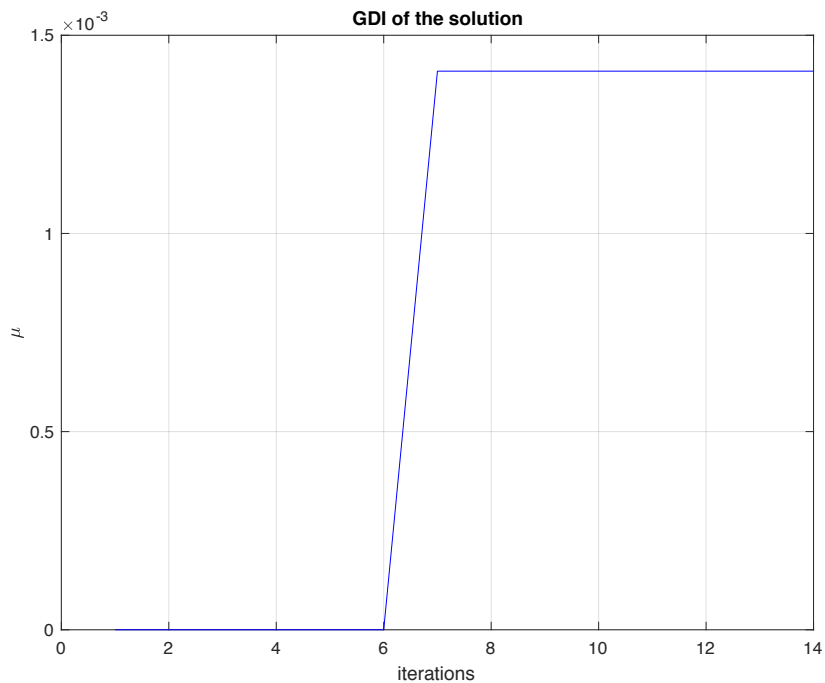

Figure H.4: GDI evolution in scenario 2

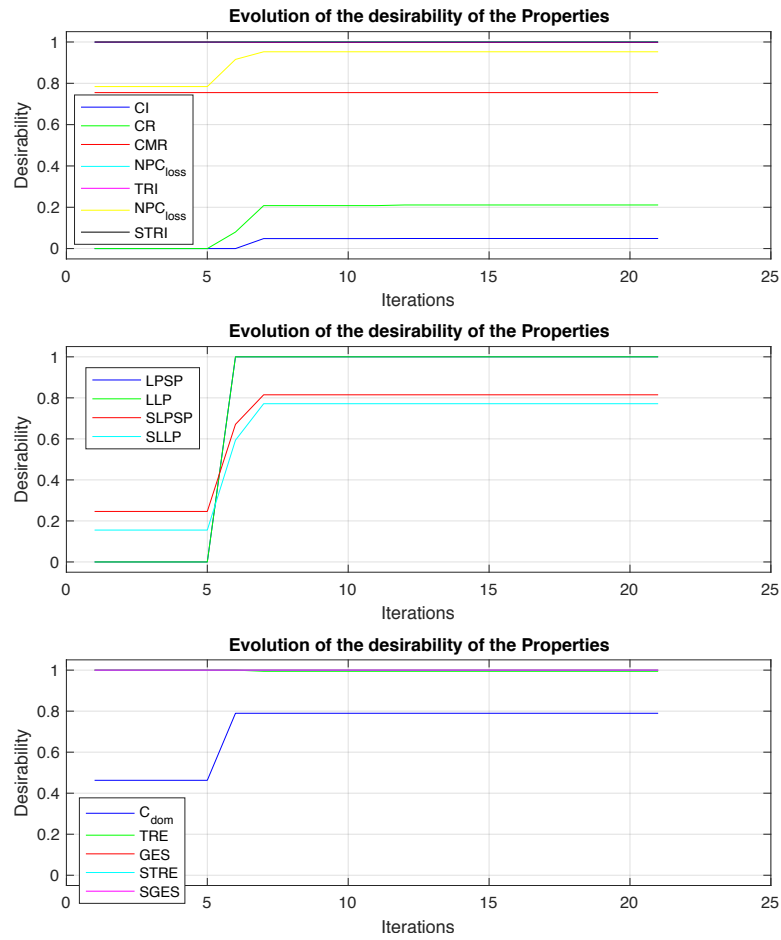

Figure H.5: Properties' desirability evolution in scenario 4

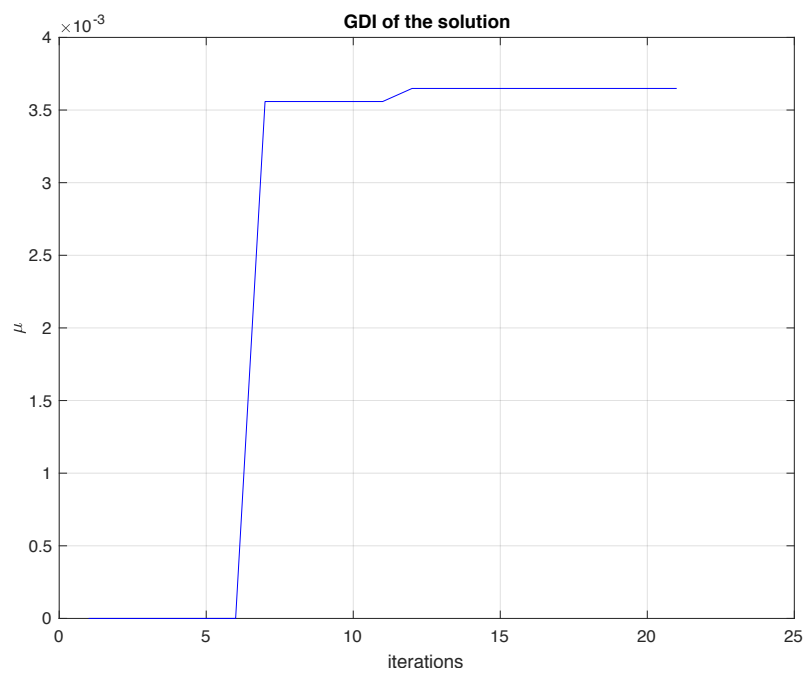

Figure H.6: GDI evolution in scenario 4

DÉMARCHE MÉTHODOLOGIQUE POUR LA CONCEPTION PRÉLIMINAIRE ET INTERACTIVE

RESUME : Les processus de prise de décision dans la conception demandent aux concepteurs de prioriser les spécifications et les variables afin de développer des solutions plus proches des objectifs du produit. Néanmoins, la taille de l'information est souvent volumineuse et difficile à comprendre : garder la trace de la liste des variables et des objectifs de conception est une tâche complexe, avec potentiellement des retraitements et perd de temps. L'objectif de cette thèse est de proposer une méthode qui permettant d'obtenir un compromis entre les objectifs de conception, basé sur deux aspects : i) le développement d'un modèle de traçabilité, gérant les informations à partir des exigences du produit (linguistiques) jusqu'à la définition des variables (nombres réels). ii) un cadre d'amélioration de la conception, fondé sur la définition des fonctions de désirabilité des objectifs de conception pour maximiser l'index global de désirabilité de la solution. La proposition de thèse est une approche hybride, comprenant une partie exploratoire interactive et une partie interactive inductive. Sur la partie exploratoire, les concepteurs peuvent modifier les variables à l'aide d'outils visuels afin de comprendre en temps réel l'impact de ces modifications sur les objectifs de conception. Sur la partie inductive, les concepteurs utilisent une méthode de pré-dimensionnement proposée, qui calcule les valeurs des variables qui maximisent la désirabilité des objectifs de conception. Cette méthode fonctionne sur un environnement de conception multidisciplinaire, avec des problèmes convexes ou non-convexes.

Mots clés : Conception interactive préliminaire, optimisation multi-critère, cadre de traçabilité, méthodologie de conception, maximisation de la désirabilité.

METHODOLOGICAL APPROACH FOR INTERACTIVE PRELIMINARY-DESIGN

ABSTRACT : Decision-making processes in design require designers to prioritise specifications and variables for developing solutions that are closer to the product's goals. Nevertheless, the size of the information is large and difficult to understand: keeping track of the variables' list and design goals is a complex task, with potentially reprocessing and waste of time. The objective of this thesis is to propose a method that allows a trade-off between the design objectives, based on two aspects: i) the development of a traceability model, managing information from the linguistic requirements up to the numeric variables. ii) a design amelioration framework based on the definition of the design objectives' desirability functions for maximising the global desirability of the solution. The thesis proposal is a hybrid approach, including an interactive exploratory part and an interactive inductive part. On the exploratory part, designers can modify variables using visual tools to understand in real time the impact of these modifications on design goals' behaviour. On the inductive part, designers use a proposed pre-sizing method, that calculates the values of the variables that maximise the desirability of the design. This method works on a multidisciplinary design environment, with convex or non-convex problems.

Keywords : Preliminary interactive design, multicriteria optimisation, traceability framework, design methodology, desirability maximization.