



**HAL**  
open science

# Methodology for the evaluation of the flexibility of heat integration solutions in eco industrial parks

Christina Kachacha

► **To cite this version:**

Christina Kachacha. Methodology for the evaluation of the flexibility of heat integration solutions in eco industrial parks. Thermics [physics.class-ph]. Université Paris sciences et lettres, 2018. English. NNT : 2018PSLEM089 . tel-02479095

**HAL Id: tel-02479095**

**<https://pastel.hal.science/tel-02479095>**

Submitted on 14 Feb 2020

**HAL** is a multi-disciplinary open access archive for the deposit and dissemination of scientific research documents, whether they are published or not. The documents may come from teaching and research institutions in France or abroad, or from public or private research centers.

L'archive ouverte pluridisciplinaire **HAL**, est destinée au dépôt et à la diffusion de documents scientifiques de niveau recherche, publiés ou non, émanant des établissements d'enseignement et de recherche français ou étrangers, des laboratoires publics ou privés.



**THÈSE DE DOCTORAT**  
**DE L'UNIVERSITÉ PSL**

Préparée à MINES ParisTech

**Méthodologie pour l'évaluation de la flexibilité des solutions d'intégration énergétique des éco-parcs industriels**

**Methodology for the evaluation of the flexibility of heat integration solutions in eco industrial parks**

Soutenue par

**Christina KACHACHA**

Le 19 décembre 2018

Ecole doctorale n° 432

**Sciences des Métiers de l'Ingénieur**

Spécialité

**Énergétique et procédés**

Composition du jury :

Khalil, EL KHOURY Professeur, Université Libanaise	<i>Président</i>
Mahmoud, EL HALWAGI Professeur, Texas A&M	<i>Rapporteur</i>
Catherine, AZZARO-PANTEL Professeur, Ensiacet	<i>Rapporteur</i>
Sylvain, SERRA Maitre de conférences, Université de Pau et des Pays de l'Adour	<i>Examineur</i>
Cong-Toan, TRAN Maitre de conférences, Mines Paristech	<i>Co-encadrant</i>
Assaad, ZOUGHAIB Professeur, Mines Paristech	<i>Directeur de thèse</i>



## Acknowledgements

First, I would like to express my sincere gratitude to my PhD supervisor Pr. Assaad Zoughaib who gave me the opportunity to undertake this PhD research within CES. I greatly appreciate his patience and immense knowledge. I also would like to thank Dr. Cong Toan Tran for his valuable suggestions and concise comments.

I would like to thank the members of my thesis jury Pr. Khalil EL Khoury, Pr. Mahmoud El-halwagi, Pr. Catherine Azzaro-Pantel and Dr. Sylvain Serra who accepted to invest time for reading this work and providing interesting feedback.

My special thanks are extended to the members of Mines ParisTech CES “centre efficacité énergétique des systèmes”: the PhD students, researchers, trainees and the administrative staff for creating a good working atmosphere. I would like to thank Alaa for the advices and guidance in the start of this thesis. I especially thank Hala, Sylvain, Marie, Kevin, and Franck for the best discussions we had.

For my family in France: Nassim, Jamil, Sarah, Sandra, Rebecca, Maya and Hussein: Thanks guys for the support and for always being there for me.

Of course, some special words of gratitude go to my amazing family: my parents and my brothers for their continuous support and constant encouragement during my Phd and my life in general. This thesis is dedicated to my beloved niece Mira.



## Table of Context

Chapter 1: Context and challenges .....	1
1.1    General Context.....	1
1.2    Energy efficiency .....	4
1.2.1    Energy efficiency in industry .....	4
1.3    Integrated process design .....	5
1.4    Eco-industrial parks.....	5
1.5    Heat Integration at process and site scales .....	6
1.5.1    Pinch method for heat integration at the process scale.....	7
1.5.2    Mathematical programming for heat exchanger network synthesis .....	9
1.5.3    Heat integration at total site scale.....	9
1.6    The problematic of variability and flexibility assessment.....	13
1.6.1    Process design techniques integrating flexibility and uncertainty.....	13
1.6.2    Flexible heat exchanger network synthesis .....	17
1.6.3    Variation consideration in the TSA.....	18
1.7    Problem Statement and methodology.....	19
1.8    Conclusion.....	22
Chapter 2: Multi-period side wide heat integration solution in eco-industrial parks .....	23
2.1    Introduction .....	23
2.2    Problem Statement and methodology.....	23
2.3    Mathematical Formulation .....	25
2.3.1    Energy Balance in each temperature interval .....	28
2.3.2    Heat exchange via network .....	29
2.3.3    Economic cost of utilities .....	31
2.3.4    Heat exchangers modelling and cost .....	32
2.3.5    Hydraulic Modeling.....	35
2.3.6    Unique investment for heat exchangers and pipes in all periods.....	40
2.3.7    Objective function .....	41
2.4    Case studies .....	41
2.4.1    Liquid heat recovery network case study .....	41
2.4.2    Steam Case Study .....	44
2.5    Conclusions .....	50
Chapter 3: A methodology for the flexibility assessment of side wide heat integration scenarios .....	51
3.1    Introduction .....	51
3.2    Problem Statement and methodology.....	51
3.3    Model formulation.....	52
3.3.1    Heat and mass balances .....	53
3.3.2    Introduced degree of freedom .....	56

3.3.3	Objective function .....	56
3.4	Case studies .....	57
3.4.1	Case study using steam network.....	57
3.4.2	Case study using liquid intermediate network.....	64
3.5	Conclusions .....	70
Chapter 4:	Industrial Case study.....	71
4.1	Introduction .....	71
4.1	Description of the studied Eco Park .....	72
4.1.1	Data of the processes .....	72
4.1.2	Geographical data.....	73
4.1.3	Problematic heat demand variation .....	75
	Relation between the average ambient temperature and the amount of heat required .....	75
4.2	Methodology and implementation.....	76
4.3	Mono periodical study.....	79
4.4	Two periods design .....	81
4.5	Three periods design 23600 11600 4000: Design 2 .....	85
4.6	Three periods 23600 11600 2000 : Design 3.....	88
4.7	Economical analysis .....	90
4.8	Conclusion.....	91
References	.....	94

# List of figures

Figure 1: World total gross domestic product 1990-2040 (trillion 2010 dollars) [3] .....	1
Figure 2: World energy Consumption [3] .....	2
Figure 3: World energy consumption by energy source [3] .....	2
Figure 4: OECD and Non-OECD energy related carbon dioxide emissions, 1990-2040 (billion metric tons) [3] .....	3
Figure 5: World energy consumption by end-use sector [3] .....	5
Figure 6: Industrial energy consumption in OECD and non-OECD [3] .....	5
Figure 7: Kalundborg eco industrial park and the interaction between different actors [6] .....	6
Figure 8: Matching hot and cold process streams .....	7
Figure 9: Hot and Cold Composite Curves .....	8
Figure 10: Utility use, heat exchanger area and cost variation with $\Delta T_{min}$ .....	8
Figure 11: Grand Composite Curve .....	9
Figure 12: Total Site profiles .....	10
Figure 13: Schematic representation of the common utility system of the TSA concept .....	11
Figure 14: Flexibility Concept .....	13
Figure 15: Flexibility test problem .....	14
Figure 16: Flexibility Index Problem .....	15
Figure 17: Algorithm for flexibility and controllability of a process design .....	17
Figure 18: Methodology proposed for flexible heat transport network design .....	21
Figure 19: Initial temperature scale .....	25
Figure 20: Final temperature scale .....	26
Figure 21: Geographical representation .....	28
Figure 22: Energy balance at each interval .....	29
Figure 23: heat exchanger superstructure .....	32
Figure 24: heat exchanger surface cost linearized function .....	35
Figure 25: Example of a plant contribution at a node .....	36
Figure 26: Geographical positioning of the processes .....	41
Figure 27 : Geographical positioning of the processes .....	45
Figure 28 : GCC scenario 1,3 .....	45
Figure 29 : GCC Scenario 2,4 .....	46
Figure 30: Comparison of cost for the four scenarios .....	46
Figure 31 : GCC scenario 1,2,4 .....	47
Figure 32 : GCC scenario 3 .....	48
Figure 33: Comparison of cost for the three scenarios .....	48
Figure 34 : Comparison of operating cost in nominal and two cases of duration of the variation .....	49
Figure 35: Representation of the heat transfer network .....	52
Figure 36: Model superstructure .....	53
Figure 37: Connections of process C .....	59
Figure 38: Simulation results case 1 (C1 capacity flow rate 390 kJ/K) .....	60
Figure 39: Simulation Results case 2(C1 capacity flow rate 390 kJ/K) .....	60
Figure 40: Feasibility envelope of process C with the generated random variations (CF stands for heat capacity flow rate variation) .....	61
Figure 41: Simulation results without bypass (C1 capacity flow rate 380 kJ/K) .....	62
Figure 42: Simulation results with bypass (C1 capacity flow rate 380 kJ/K) .....	62
Figure 43: Feasibility of process C within the eco-park(CF stands for heat capacity flow rate variation) .....	63
Figure 44: Geographic data .....	65
Figure 45: GCC for nominal parameters .....	65
Figure 46: Schematic representation .....	66

Figure 47: Simulation results with one degree of freedom (network's temperature).....	67
Figure 48: Simulation results with two degrees of freedom (network's temperature and local cold utility of the source plant) .....	67
Figure 49: Simulation results with three degrees of freedom (network's temperature and local temperature of the utilities) .....	68
Figure 50: Results with bi pass.....	69
Figure 51 : Industrial park layout.....	74
Figure 52 : Average ambient temperature curves for several years in the studied region.....	75
Figure 53 : The relation between the heat demand and the ambient temperature. ....	76
Figure 54 : The corresponding heat demand variation based on the average ambient temperature for the twelve months of the different years. ....	76
Figure 55: schematic representation of the methodology.....	78
Figure 56 : Simulation results (winter condition) with one degree of freedom.....	80
Figure 57 : Simulation results (spring condition) with one degree of freedom.....	80
Figure 58 : : Simulation results (winter conditions) with three degrees of freedom .....	81
Figure 59: Simulation results (spring conditions) with three degree of freedom .....	81
Figure 60 : Network lay-out .....	82
Figure 61 : Simulation results with one degree of freedom .....	84
Figure 62 : Variation of the network's temepature .....	84
Figure 63 : Simulation results for additional degrees of freedom .....	85
Figure 64 : Additional areas on heat exchangers.....	85
Figure 65 : Total heat delivered to district heating and heat demand withdrawn from each process ....	85
Figure 66 : Network layout .....	86
Figure 67 : Simulation results of the NLP model.....	87
Figure 68: Simulation results using one additional manipulated variable.....	88
Figure 69: Simulation results of NLP model using network 's temperatures as a degree of freedom ..	89
Figure 70 : Total heat recovered for each variation.....	89
Figure 71 : Comparison between the investments costs and revenue of sold heat for three different designs.....	90

# List of tables

Table 1: Streams' characteristics at nominal condition .....	41
Table 2: Results for nominal conditions.....	42
Table 3: Diameter size of pipes and its costs .....	42
Table 4: Description of variations in different cases.....	43
Table 5: Network results for cases 1,2 .....	43
Table 6: Network results for cases 3,4 .....	43
Table 7: Network results for case 5, 6.....	44
Table 8: Streams' characteristics .....	44
Table 9: geographical coordinates.....	45
Table 10 : Results for nominal conditions scenario1,3 .....	46
Table 11 : Results for nominal conditions scenario2,4 .....	46
Table 12 : Network's characteristics and interaction with the processes for scenario 1 .....	47
Table 13 : Network's characteristics and interaction with the processes for scenario 2,4 .....	47
Table 14 : Network's characteristics and interaction with the processes for scenario 3 .....	48
Table 15 : Network's characteristics and interaction with the processes for scenario 1 .....	49
Table 16 :Network's characteristics and interaction with the processes for scenario 2,4 .....	49
Table 17 : Network's characteristics and interaction with the processes for scenario 3 .....	49
Table 18: Total cost for each case for each scenario.....	50
Table 19 : Stream's characteristics.....	58
Table 20 : Relation between process and tertiary networks .....	58
Table 21 : Heat exchangers areas .....	59
Table 22: Variation of heat load on the nodes of the second stream.....	62
Table 23: Total utility load and networks temperatures for selected feasible conditions .....	63
Table 24: Streams' data for the processes .....	64
Table 25: Structure of the streams of process 2 withdrawn from the network.....	66
Table 26: Structure of the streams of process 2 withdrawn from the network.....	66
Table 27 : Streams' characteristics.....	73
Table 28: Geographical coordinates.....	74
Table 29 : Path lengths and connections .....	74
Table 30 : Winter heat demand design results.....	80
Table 31: Spring heat demand design results .....	80
Table 32: Results of two periods design.....	82
Table 33:Heat export network piping properties .....	83
Table 34: Investment costs .....	83
Table 35: Multi period three period design .....	86
Table 36: Hydraulic results .....	86
Table 37: Investment costs .....	87
Table 38: Results of two periods design.....	88
Table 39: Hydraulic results .....	89
Table 40 : Investment costs .....	89

# Nomenclature

<i>Anpe, Apne</i>	Heat exchanger area installed between a cold, hot stream and the network
$A_i$	Lower limit for heat exchanger area at interval $i$
$A$	heat exchanger area ( $m^2$ )
$a$	Cross sectional area
$A, B$	Coefficients of linearization for pressure drop calculation
$AA, BB$	Coefficients of linearization for pumping calculation
<i>actu</i>	Actualisation parameter
<i>binarynetworks</i>	Binary variable to indicate the presence of a network
<i>binaryexchangerpn</i>	Binary variable to indicate the presence of a heat exchanger
<i>binaryexchangernp</i>	Binary variable to indicate the presence of a heat exchanger
<i>binaryvvp, binaryvvn</i>	Binary variable to indicate the presence of a flow in a certain path
<i>costpipes</i>	Cost of pipes
<i>costpumping</i>	Pumping Cost
<i>costutilities</i>	Cost utilities
<i>Costexchangers</i>	Cost of heat exchangers
CP	Heat capacity flow rate kW/C
CS	Set of cold streams
CAPEX	Investments costs
$F$	Fixed cost for heat exchangers
$g$	Gravitational acceleration
GCC	Grand composite curve
$H$	Friction head
HS	Set of hot streams
<i>lmtd</i>	Logarithmic mean temperature difference(K)
$l$	Length
$lp$	Ratio of the duration of the period
<i>mcp</i>	Heat capacity flow rate ( kW/K)
<i>Nbresmax</i>	Maximum number of networks
<i>NbOpHours</i>	Number of operating hours
<i>Nnodes</i>	Number of nodes
<i>Nsplit</i>	Number of splits
$N_{net}$	Number of tertiary networks
<i>pinch</i>	Pinch location at the temperature scale
$Q$	Heat load (kW)
$qs,$	Hot utility (kW)
$qw$	Cold utility (kW)
$qch$	Heat flowing in a certain path
$q$	Sum of streams' enthalpies (heat excess or deficit)
$qp_n, qnp$	Heat delivered, supplied to liquid network (kW)
$qps, qsp$	Heat delivered, supplied to steam network (kW)
$Q_{max}$	Maximum energy availability
<i>qsteamutility</i>	Capacity of site utility
<i>qnetwork</i>	Capacity of the network
<i>qpne</i>	Heat received by a stream in defined temperature intervals (kW)
<i>qnpe</i>	Heat supplied by a network in defined temperature intervals (kW)
$qo$	Heat surplus presented by a specific stream within an interval
$r$	Remainder heat cascaded to the lower interval
$T$	Temperature ( °C)
<i>taux</i>	Interest rate

$T_{in}$	Stream inlet temperature
$T_{out}$	Stream outlet temperature
$Tu_{net}$	Network upper temperature
$Tl_{net}$	Network lower temperature
$U$	exchanger heat transfer coefficient (kW/m <sup>2</sup> .K)
$V1, V2$	Upper and lower limit of the velocity interval
$Vp, Vn$	Velocity in pipes
$V$	Variable cost for heat exchangers
$\Delta T_{min}$	Minimum temperature difference for internal heat exchange
$\Delta T_{net}$	Minimum temperature difference for heat exchange with intermediate network
$\rho$	Density of the fluid

## Subscripts and superscripts

$b$	Branch used to split a stream
$i$	Hot source stream
$j$	Cold sink stream
$k$	Node of stream
$m$	Process
$n, nn, ns$	Temperature interval
$net$	Network
$node$	Node
$o$	Stream
$p$	Period
$path$	Path
$z$	Diameter
$v$	Velocity

# Résumé étendu

## 1. Introduction

D'après les études de l'agence internationale de l'énergie (IEA), les dernières décennies se caractérisent par une forte croissance économique et démographique; cette croissance est accompagnée par une augmentation de la consommation d'énergie. La majorité de l'augmentation se produit spécifiquement dans les pays non membres de l'OCDE afin de répondre à l'expansion de l'industrialisation et de l'urbanisation de ces pays. D'autre part, le rythme actuel d'extraction des ressources fossiles, nécessaire pour subvenir à la dépendance de l'énergie, contribue à l'épuisement de ces ressources. Actuellement, face à ces problèmes, plusieurs mesures ont été prises pour encourager les politiques d'efficacité énergétique qui permettent de réduire la consommation d'énergie et d'améliorer son usage. En effet, l'efficacité énergétique dans l'industrie joue un rôle clé pour atteindre les objectifs environnementaux puisque ce secteur compte environ 30% de la consommation d'énergie et 16% des émissions directes de CO<sub>2</sub> à l'échelle mondiale.

Le concept d'intégration énergétique des procédés a été développé afin d'améliorer l'efficacité énergétique dans l'industrie. C'est une méthodologie qui analyse, d'une façon systémique et systématique, les flux énergétiques dans les procédés industriels pour identifier les sources d'inefficacités énergétiques en déterminant concrètement les moyens de récupération de la chaleur. L'idée de conception de procédés intégrés peut être étendue à plusieurs procédés favorisant ainsi la mutualisation des synergies énergétiques dans les territoires industriels. Le concept d'éco-parc représente une application des symbioses industrielles où plusieurs sites sont engagés pour échanger leurs ressources en énergie, eau ou matière. La proximité géographique des sites est une opportunité pour réaliser des synergies énergétiques améliorant l'efficacité énergétique et présentant une solution aux différents problèmes environnementaux. Plusieurs méthodes ont été développées pour résoudre le problème d'intégration énergétique. Les deux techniques principales sont : l'analyse de pincement basée sur des analyses thermodynamiques et la programmation mathématique basée sur des modèles mathématiques plus ou moins complexes et résolus à l'aide de méthodes numériques. Ces derniers sont classés suivant deux grandes catégories: la programmation linéaire où la fonction objectif du modèle et les contraintes sont des équations linéaires et la programmation non linéaire où la fonction objectif du modèle mathématique et les contraintes sont des équations non-linéaires.

## 2. Méthodes d'intégration énergétique à l'échelle des procédés

Deux méthodes principales ont été développées pour résoudre le problème d'intégration énergétique à l'échelle des procédés :

- La méthode de pincement est la première méthode systématique qui fixe des valeurs cibles de consommation énergétique minimale. Elle permet l'identification du potentiel de récupération de la chaleur. Elle est basée sur des outils graphiques: les courbes composites chaudes et froides qui représentent séparément les besoins de chauffage et les besoins de refroidissement d'un procédé et la Grande Courbe Composite (GCC) qui



est utilisée pour identifier le choix le plus approprié du niveau de température et de la puissance des utilités.

- Les techniques de programmation mathématique sont utilisées pour la synthèse du réseau d'échangeurs de chaleur (HEN) et pour une meilleure évaluation du compromis entre le gain énergétique et le gain économique qui inclut les coûts des échangeurs et des utilités.

### **3. Méthodes d'intégration énergétique à l'échelle territoriale**

Les méthodes d'intégration énergétique à l'échelle des procédés ont été étendues à l'échelle territoriale. La méthode d'intégration énergétique multi-sites « TSA » permet d'identifier la possibilité d'échange de chaleur entre plusieurs procédés en utilisant un système d'utilité en commun. Elle est basée sur des outils graphiques (profile de source et de puits) qui permettent l'analyse des échanges de chaleur à différents niveaux de température. Plusieurs auteurs ont contribué au développement de cette méthode. Des valeurs de la différence de température minimale  $DT_{min}$  spécifiques pour chaque procédé et pour les échanges de chaleur avec les utilités ont été utilisés afin de fournir une meilleure évaluation du compromis entre les coûts et le gain énergétique. En plus, le concept d'intégration énergétique multi-sites a été étendu pour inclure des procédés de différents secteurs: résidentiel, commerce, services et agriculture. En parallèle, des méthodes de programmation mathématiques utilisant des modèles linéaires (LP) et des modèles mixtes, linéaires et combinatoires (MILP) ont été aussi développés pour optimiser l'emplacement du réseau tertiaire d'échange de chaleur entre les différents procédés.

### **4. Introduction du concept de flexibilité dans les méthodologies d'intégration énergétique**

L'implémentation des solutions d'intégration énergétique est importante afin d'améliorer l'efficacité énergétique et spécifiquement à l'échelle territoriale. Des approches thermodynamiques ont été développées à l'échelle du procédé et à l'échelle territoriale. Des approches de programmation mathématique ont également été utilisées pour inclure des aspects supplémentaires tel que le compromis entre les coûts d'investissement et les coûts opératoires. Toutefois les interactions majeures résultants de cette intégration, ainsi que les fluctuations opérationnelles dans les conditions de fonctionnement autour de valeurs nominales qui sont inévitables pourraient constituer un risque pour les industriels. Ainsi les concepteurs doivent considérer la flexibilité comme un point majeur de leur stratégie. Certains chercheurs ont tenté de définir la flexibilité et de la quantifier, tandis que d'autres ont tenté d'intégrer les fluctuations possibles lors de la phase de synthèse.

#### Techniques d'intégration de la flexibilité et des incertitudes dans les méthodologies de conception de procédés.

Les analyses de flexibilité et son intégration dans les étapes de synthèse ont occupé une place importante dans l'ingénierie des procédés. En effet, le problème de flexibilité peut être introduit dans les étapes de synthèse en incluant dans les modèles d'optimisation des contraintes de flexibilité. En plus la flexibilité peut être évaluée pour une configuration fixe qui fonctionne sous différentes variations dans les conditions opératoires. En parallèle, plusieurs approches sont développées pour intégrer le problème des incertitudes dans les modèles d'optimisation :

- L'approche d'optimisation robuste vise à trouver une solution de conception qui est réalisable pour l'ensemble des variations du paramètre incertain.
- La stratégie d'optimisation stochastique ne détermine pas les variables de décision en une seule étape, mais consiste à déterminer progressivement des actions à différentes étapes pour surmonter les variations. La programmation stochastique est basée sur une approche de scénarios pour représenter les incertitudes.

En plus, ces méthodes ont été étendu pour lier le problème de flexibilité à d'autres objectifs comme la contrôlabilité. Elles peuvent être représentées par une approche itérative entre une étape de synthèse multi-périodique et une étape de sélection des variables de contrôle et d'analyse de flexibilité dynamique. La deuxième étape permet l'identification de paramètres critiques que la conception ne peut pas traiter. Le but est de trouver à chaque itération un nouveau design plus robuste. À la fin, une configuration optimale est obtenue lorsque la faisabilité est garantie pour les perturbations et les incertitudes possibles.

#### Intégration de la flexibilité dans la synthèse de réseaux d'échangeurs

L'intégration des aspects de flexibilité dans les méthodologies de synthèse des réseaux d'échangeurs de chaleur est un problème qui a été étudié de manière approfondie par plusieurs chercheurs. En effet, le HEN doit s'adapter aux variations inévitables due à des variations dans les conditions de fonctionnement qui peuvent priver la conception de son efficacité thermodynamique et économique. Des chercheurs ont développé le concept de résilience d'un HEN. Ils identifient un nombre de scénarios les plus défavorables (chauffage maximal, refroidissement maximal et échange maximal), déterminent les configurations optimales sous ces conditions et combinent les configurations obtenues. D'autres chercheurs ont développé une procédure systématique de deux étapes afin d'obtenir un HEN capable de faire face à des variations de température et de débit. Chaque étape inclut une procédure itérative entre une étape de synthèse et une étape d'analyse de flexibilité. La première étape permet de définir les échanges entre les flux froids et chauds ; elle est suivie d'une étape d'analyse de flexibilité établie sur les points extrêmes de la plage des paramètres incertains. La deuxième étape permet de générer la structure du réseau d'échangeurs de chaleur ; elle est suivie d'une étape d'analyse de flexibilité afin de garantir l'opérabilité face à des points critiques supplémentaires. En plus, une approche de trois étapes itératives a été développée ; La première étape permet une synthèse d'un HEN qui prend en compte un nombre fini des conditions opératoires ayant un coût annuel minimal. Le problème est formulé en multi-période mixte combinatoire non linéaire (MINLP) dont le but est de minimiser le coût global annuel. La deuxième étape permet d'analyser la flexibilité du réseau obtenu pour pouvoir déterminer s'il est faisable sur toute la plage de perturbation et cela en résolvant le problème d'index de flexibilité pour la structure du réseau. La dernière étape élimine les réseaux infaisables.

#### Intégration des aspects de variabilités dans les méthodologies d'intégration énergétique multi-site

Plusieurs auteurs ont proposé des solutions pour traiter les variations des conditions opératoires dans les méthodologies d'intégration énergétique à l'échelle territoriale. Un outil numérique a été identifié ; d'abord il cible les besoins de chauffage et de refroidissement et les économies énergétiques. Ensuite, un tableau de distribution des utilités et un tableau d'analyse de sensibilité sont établis pour analyser les besoins en chauffage et refroidissement de chaque

procédé pour différents scénarios d'arrêts ou de variations. En parallèle, certains auteurs ont proposé l'intégration des énergies renouvelables comme source de chaleur pour surmonter les variations de la demande de chauffage ou de refroidissement. D'autres auteurs ont répertorié les problèmes industriels liés à l'implémentation de l'intégration énergétique à l'échelle territoriale, tels que les problèmes opérationnels, de conception et ont développé une matrice pour pondérer l'impact de ces problèmes à l'aide d'une approche heuristique. D'autres chercheurs ont proposé un modèle mathématique combinatoire non linéaire stochastique multi-période basé sur une superstructure multi-site. Cette dernière est une extension de la superstructure de réseau d'échangeur de chaleur développée à l'échelle de procédé. Le modèle permet d'optimiser le niveau de pression des utilités intermédiaires et le coût total.

En résumé, la revue bibliographique des paragraphes précédents résumait plusieurs approches proposées par les auteurs pour traiter le problème de la flexibilité dans la procédure de synthèse de procédés, dans les méthodologies d'intégration énergétique et dans la synthèse des réseaux d'échangeurs de chaleur. Cependant, à l'échelle territoriales, peu de travaux ont intégré les fluctuations dans la phase de synthèse et aucune méthodologie structurée qui tient en compte de la flexibilité n'a été proposée. Cette thèse propose une méthodologie pour l'évaluation de la flexibilité des solutions d'intégration énergétique des éco-parcs industriels.

## **5. Méthodologie pour l'évaluation de la flexibilité des solutions d'intégration énergétique des éco-parcs industriels**

L'implémentation des méthodologies d'intégration énergétique à l'échelle des procédés ou à l'échelle territoriale peut améliorer considérablement l'efficacité énergétique en limitant les consommations des utilités et par conséquent elle peut diminuer les coûts opératoires. Cependant, les fluctuations dans les conditions de fonctionnement des procédés et les écarts par rapport aux valeurs nominales sont inévitables. Elles peuvent priver le système d'intégration énergétique installé de son efficacité énergétique et économique, spécifiquement avec la présence d'interactions majeures entre les différents acteurs industriels. Les outils développés à l'échelle territoriale utilisent des conditions de fonctionnement fixes ou un nombre limité de scénarios pour obtenir une architecture du réseau de transport de chaleur. En conséquence, la synthèse des procédés et des réseaux de transport de chaleur qui se basent uniquement sur des critères économiques et sur des hypothèses de paramètres nominaux et fixes peut conduire à des installations incontrôlables ayant des comportements inattendus à cause des perturbations et des incertitudes. C'est pourquoi, l'introduction des aspects de variabilité dans la formulation mathématique du problème d'intégration énergétique est indispensable pour obtenir une configuration du réseau de transport de chaleur capable de fonctionner efficacement dans toutes les conditions de fonctionnement possibles.

L'état de l'art montre qu'il est possible d'apporter, via l'approche multi-période, une première solution aux fluctuations prévisibles. Cette approche permet de réaliser la synthèse du réseau de synergie énergétique en représentant les fluctuations par une série de conditions statiques sous forme de périodes. Ainsi, en considérant l'ensemble des variations prévisibles qui peuvent intervenir, il s'agit de représenter le cycle de période autant de fois que des scénarios possibles existent. Il est clair qu'un nombre élevé de scénarios augmente la taille du problème. Ce dernier peut devenir complètement insolvable par les moyens numériques actuels. Cette approche semble insuffisante vu le grand nombre de scénarios de variations supplémentaires

imprévisibles et de combinaisons de variations qui peuvent intervenir. C'est pourquoi une deuxième étape séquentielle et itérative est nécessaire. En s'inspirant des travaux de synthèse de réseaux d'échangeurs de chaleur flexibles, une méthodologie de deux étapes permettant l'intégration progressive des scénarios critiques est proposée afin d'obtenir une conception flexible après plusieurs itérations. Cette méthodologie permet un compromis entre un temps de calcul important et une génération de solutions ayant un degré de flexibilité de plus en plus élevé. Ainsi, dans une première étape, un ensemble de scénarios initial est représenté et pris en compte pour la synthèse d'un réseau de synergie énergétique à l'aide de l'approche multi-période. Ces variations peuvent être de type saisonnier liées aux conditions ambiantes ou à un fonctionnement non continu sur une journée. Ce type de variation est modélisé d'une façon déterministe. Ensuite, dans la deuxième étape, le réseau de transport de chaleur, conçu à l'aide de l'approche multi-période, est éprouvé par modélisation de son opérabilité face à un nombre supplémentaire de variations générées aléatoirement. Les scénarios infaisables représentant des scénarios critiques ou extrêmes sont ajoutés à la liste initiale et une nouvelle configuration du réseau est établie. Par conséquent, cette méthodologie proposée est une approche progressive d'intégration de scénarios considérés comme critiques ce qui permettrait d'éviter la représentation de tous les scénarios simultanément.

#### **6. Première étape de la méthodologie : Solution du problème d'intégration énergétique multi-sites en utilisant l'approche multi-période**

L'introduction des aspects de variabilités dans l'étape de synthèse du réseau de transport de chaleur multi-site est fondamentale pour obtenir une configuration du réseau capable de d'être opéré dans les différentes conditions opératoires. L'approche multi-période est adoptée pour pouvoir représenter ces variations dans les conditions opératoires. En effet, les méthodes d'intégration énergétique à l'échelle territoriale, proposées dans la littérature (thermodynamique ou programmation mathématique), sont utiles pour établir des cibles de récupération de la chaleur dans le but de réduire au maximum les ressources externes de chaleur ou de refroidissement dans les éco-parcs. Cependant ces méthodes doivent être étendues pour inclure le dimensionnement des échangeurs et des tuyaux nécessaires pour établir l'échange et connecter les procédés aux réseaux d'utilités. Cela permettra d'évaluer le compromis entre le gain énergétique de la récupération de la chaleur et les coûts d'investissement.

La première étape de la méthodologie consiste à développer un modèle mathématique pour une synthèse complète du réseau de transport de chaleur multi-sites, opérable dans les périodes définies avec un coût annuel total minimal. Ce dernier inclut les coûts opératoires, les coûts des échangeurs de chaleur, les coûts de la tuyauterie et les coûts des pompes.

Le modèle mathématique développé prend en compte les aspects suivants :

- Les variations dans les conditions de fonctionnement en utilisant l'approche multi-période.
- L'optimisation des températures des réseaux de transport
- La superstructure des échangeurs de chaleur installés entre les flux sélectionnés et les réseaux intermédiaires pour établir l'échange
- Les aspects hydrauliques incluant le réseau de tuyauterie à installer entre les procédés
- La localisation géographique des procédés.

Ces extensions sont importantes car elles permettent de représenter un compromis plus réaliste entre les coûts et le gain énergétique de la solution d'intégration énergétique multi-sites.

Le problème est résolu en utilisant une approche d'optimisation mathématique basée sur un modèle de programmation mixte linéaire et combinatoire (MILP). Cette approche représente le problème complexe de manière systématique en le décomposant en un ensemble d'équations et en incluant des caractéristiques spécifiques dans la fonction objectif à optimiser. Ces équations décrivent le fonctionnement du système, les contraintes et les limites auxquelles les variables sont soumises. Le choix d'une formulation de programmation linéaire garantit une robustesse numérique plus élevée et une convergence de la solution. Par conséquent, les contraintes du problème non linéaire sont linéarisées, ce qui augmente la difficulté de formulation. Les équations du modèle sont écrites dans le langage GMPL (Mathematic Programming Language). CPLEX est utilisé comme solveur pour résoudre le problème d'optimisation.

Le résultat final est une configuration optimale du réseau de récupération de chaleur en spécifiant son type (vapeur ou liquide), sa température, sa capacité opérable dans toute les séries de variations des paramètres. En plus, le modèle dimensionne les échangeurs de chaleurs pour établir les échanges entre les procédés et le réseau tertiaire et détermine la puissance des pompes nécessaires. En plus il prend en considération l'emplacement géographique des procédés. La fonction objectif économique à minimiser inclut les coûts d'investissement et les coûts opératoires des utilités.

#### **Formulation mathématique du modèle**

Le modèle mathématique formulé décompose le problème de conception d'architecture d'intégration énergétique multi-sites en plusieurs équations et contraintes afin d'obtenir la solution optimale qui minimise la fonction objectif. D'abord l'utilisateur définit les paramètres d'entrées comme les caractéristiques des flux et la localisation géographique des procédés. La première étape du modèle consiste à identifier une échelle de température unique à partir des caractéristiques des flux de chaque procédé. A l'aide de cette méthode, tous les flux des procédés peuvent participer à un échange de chaleur interne dans le procédé et/ou à un échange avec le réseau tertiaire. La température du réseau est une variable à optimiser et sera déduite de l'échelle de température déjà définie, tout en prenant en considération la différence de température minimale entre la température des flux des procédés et les températures des réseaux. En plus, la localisation géographique pré-planifiée de chaque procédé ainsi que les routages possibles et faisables entre les procédés sont définis par l'utilisateur. Le modèle est découpé en plusieurs parties.

- Bilan énergétique sur les intervalles de l'échelle de température

Le modèle est basé sur une cascade énergétique sur les intervalles de l'échelle de température déjà définie pour chaque flux de chaque procédé. Un bilan énergétique à chaque intervalle est établi afin d'étudier les différentes possibilités d'installation de réseaux tout en satisfaisant les besoins de chauffage et de refroidissement de tous les flux de chaque procédé. Les composants qui interagissent dans chaque intervalle sont : excès ou besoin de chaleur, chaleur fournie au réseau et chaleur reçue du réseau. Le reste de la chaleur sera cascadié à des intervalles de température plus basse. Pour boucler le bilan énergétique, une utilité chaude peut être ajoutée à l'intervalle le plus élevé pour compléter le besoin de chauffage du procédé et des utilités froides

peuvent être ajoutées aux intervalles les plus basses pour satisfaire le besoin de refroidissement de chaque procédé.

- Echange entre les flux/procédés et les réseaux

Chaque réseau tertiaire, installé pour assurer l'échange de chaleur entre les différents procédés, ne stocke pas de l'énergie. C'est pourquoi une contrainte vérifiant que la somme de la chaleur fournie par tous les procédés à un réseau est égale à la somme de la chaleur transférée du réseau à tous les procédés à chaque période est intégrée. Le solveur teste toutes les combinaisons possibles de réseau. Des variables binaires caractérisant la présence des réseaux sont introduites pour limiter le nombre des réseaux à un nombre maximum fixé par l'utilisateur. A noter que le nombre de réseaux choisis par le modèle est le même pour toutes les périodes.

- Modélisation des échangeurs de chaleur

Pour aller plus loin, le solveur examine toutes les combinaisons possibles permettant l'échange de chaleur entre chaque flux de chaque procédé avec les réseaux. La chaleur échangée avec le réseau pourrait avoir lieu aux intervalles de l'échelle de température en respectant les critères thermodynamiques de différence de température positive entre les températures du flux et les températures du réseau. La somme des échanges possibles de tous les flux appartenant au même procédé avec un réseau doit être égale à la chaleur échangée entre ce réseau et le procédé. La capacité échangée entre les flux et les réseaux aux intervalles spécifiques est limitée à l'excès ou au déficit de chaleur de ces flux sur les intervalles. En effet, la chaleur échangée par un flux chaud spécifique avec un réseau entre deux intervalles est inférieure ou égale au surplus de chaleur du flux sur ces intervalles. De même, la chaleur fournie à un flux froid entre deux intervalles est inférieure ou égale au déficit de chaleur sur ces intervalles. Par conséquent, la surface de l'échangeur de chaleur à installer entre le flux et le réseau dans des intervalles bien définies est calculée. A noter que les différences de température logarithmique moyenne DTLM sont pré-calculées et le coefficient de transfert de chaleur global est fixé par l'utilisateur.

Le coût des échangeurs de chaleur est inclus dans la fonction objectif à minimiser. En effet, le coût de l'échangeur thermique qui dépend principalement du type de matériau et du type d'échangeur est une fonction non linéaire. Toutefois, pour conserver la linéarité du modèle, une fonction linéarisée du coût des échangeurs est définie et utilisée. Les paramètres de la fonction linéaire sont calculés en utilisant la technique d'interpolation sur la fonction non linéaire initiale.

- Modélisation des aspects hydrauliques

L'échange de chaleur indirect entre les procédés nécessite des réseaux de tuyauterie adaptés. Le modèle prend en compte les chemins possibles définis par l'utilisateur, détermine le meilleur routage des canalisations en fonction des distances entre les procédés au sein de l'éco-parc. Les équations hydrauliques comprennent: bilan énergétique aux nœuds, équilibre de pression dans les mailles, calcul de la vitesse dans les conduites et détermination de leur diamètre. Le bilan énergétique est établi sur chaque nœud pour éviter le stockage de chaleur. La chaleur fournie à un procédé ou reçue du procédé à un nœud sera transférée à d'autres nœuds via les chemins connectés à ce nœud. Le modèle choisit le diamètre de la tuyauterie à partir d'un ensemble des

diamètres prédéfinis par l'utilisateur. Une discrétisation est établie pour le calcul de la vitesse pour pouvoir linéariser l'équation de la perte de charge. Le coût de la tuyauterie, étroitement lié au diamètre choisi, est ajouté à la fonction objective.

Pour compléter la modélisation hydraulique, des calculs de perte de charge sont ajoutés au modèle. L'équation du calcul de la perte de charge dans un tuyau est non linéaire. Néanmoins, dans ce modèle, le calcul de la perte de charge est linéarisé en fonction de la vitesse. La linéarisation consiste à trouver les coefficients de la fonction linéaire pour chaque tronçon de vitesse établi par la discrétisation de la vitesse. En plus, le modèle hydraulique prend en compte l'équilibre de la perte de charge dans les boucles qui commencent et se terminent par le même nœud.

La puissance de pompage nécessaire pour effectuer le transport de chaleur peut également être calculée, en utilisant la perte de charge dans les conduites et le débit des réseaux. La forme initiale de l'équation est non linéaire mais elle est remplacée par des fonctions linéarisées afin d'obtenir la puissance de pompage nécessaire dans chaque période. Les coûts du pompage et des pompes sont ajoutés à la fonction objectif.

- Investissement unique pour les échangeurs de chaleur et les tuyaux dans toutes les périodes

Malgré les variations périodiques, un réseau optimal de récupération de chaleur est choisi et il est opérables sur toutes les périodes. La surface des échangeurs de chaleur, le routage des tuyaux et leur diamètre sont déterminés par le modèle et ne peuvent pas varier pour chaque période. Un ensemble d'équations est introduit dans le modèle afin d'avoir la même configuration du réseau pour toutes les périodes même si ses conditions opérationnelles varient.

- Fonction objectif

Le but de ce modèle est de déterminer une configuration du réseau de récupération de chaleur opérable sur toutes les périodes qui représentent les différentes conditions de fonctionnement, tout en minimisant le coût total. Ce dernier comprend les coûts des échangeurs de chaleur, les conduites du réseau et les coûts opératoires des utilités. A noter que les coûts d'investissement et opératoires sont exprimés sur la même échelle de temps.

Le modèle développé décrit ci-dessus est appliqué sur deux études de cas.

#### **Etudes de cas :**

- Etude de cas pour la synthèse d'un réseau de récupération de chaleur liquide

L'objectif de cette étude est déterminer la faisabilité technique et économique de l'installation d'un réseau tertiaire liquide entre trois procédés (A, B et C) capable de fonctionner sous plusieurs conditions opératoires. Les caractéristiques des flux des 3 procédés (température d'entrée et de sortie et les débits des flux) et le positionnement géographique des procédés sont définis. Dans une première étape, afin d'avoir un cas de référence, le modèle est utilisé avec une période représentant les conditions nominales de fonctionnement. Les résultats montrent que la chaleur est récupérée du procédé C et est fournit au procédé A et B. Le modèle optimise la température de réseau tertiaire et définit la surface des échangeurs à installer sur chaque procédé. Dans une deuxième étape, plusieurs variations dans les conditions opératoires ont été

introduites sous forme de périodes afin de démontrer la capacité du modèle à trouver le réseau optimal qui peut faire face à ces variations. Les variations incluent des augmentations et des diminutions du besoin de chauffage. En résumé, les résultats montrent que le modèle compense les faibles augmentations du besoin de chaleur du procédé A par des utilités chaudes locales, cependant avec des augmentations significatives du besoin de chauffage le modèle détermine pour les périodes de ce cas des surfaces d'échangeurs de chaleur plus élevées avec des variations de la température du réseau pour chaque période afin de s'adapter pour les conditions opératoires de chaque période. Dans le cas où des besoins de chauffage supplémentaires dans le procédé B interviennent, le modèle tend à limiter l'échange avec le procédé A voir exclure cet échange et par conséquent éviter l'installation des tuyauteries ce qui va réduire les coûts.

- Etude de cas pour un réseau de récupération de chaleur vapeur

La deuxième étude de cas inclut deux procédés ; le but est de minimiser la consommation des utilités en étudiant le potentiel de récupération de la chaleur via un réseau de vapeur intermédiaire capable de fonctionner sous différentes conditions opératoires. Pour ce cas, l'utilisation des utilités locales n'est pas possible et tout le besoin de chaleur sera fourni par les réseaux intermédiaires et/ou par des utilités chaudes centrales. Le positionnement géographique des procédés est défini ainsi que des contraintes sur l'emplacement des utilités chaudes centrales. Ce cas d'étude traite trois aspects :

- Le modèle est testé pour une période unique avec des conditions nominales de fonctionnement. Le modèle est testé pour quatre scénarios de positionnement des utilités centrales indépendamment. Pour chaque scénario une architecture du réseau et des interactions spécifiques entre les procédés et les réseaux intermédiaires sont obtenus. En parallèle, les coûts opératoires et d'investissement pour chaque scénario sont comparés et analysés. Effectivement, le besoin en utilité est identique pour les quatre scénarios étant donné un unique coût de chaleur.
- Le modèle est testé pour deux périodes de même durée. Une diminution de la demande de chaleur du procédé 2 dans une deuxième période de fonctionnement est testée pour les quatre scénarios d'emplacement des utilités centrales. Les résultats montrent la variation de la température du réseau dans la deuxième période. En parallèle un choix optimal des utilités intermédiaire est déterminé par le modèle pour compenser la diminution de la chaleur à récupérer du procédé.
- Le modèle est testé pour deux périodes de durée différentes. La diminution du besoin de chaleur du procédé B est considérée effective juste sur 10% de sa durée totale.

## **7. Deuxième étape de la méthodologie : méthodologie pour l'évaluation de la flexibilité des solutions d'intégration énergétique multi-sites**

La méthodologie de la thèse propose une approche itérative de deux étapes. La première étape intègre l'approche multi-période aux modèles de synthèse de réseaux de récupération de chaleur multi-sites. Cette approche permet de représenter les perturbations et les variabilités prédictibles ; elles sont modélisées sous forme de période. L'objectif est d'obtenir une configuration opérable sur toutes les périodes tout en déterminant la quantité de chaleur échangée, la capacité des utilités et les dimensions des équipements nécessaires comme les



échangeurs de chaleur, les pompes et les tuyaux. Cette approche est insuffisante vu le grand nombre de scénarios de variations supplémentaires imprévisibles qui peuvent intervenir ; le problème devient insolvable numériquement. C'est pourquoi une deuxième étape séquentielle et itérative est nécessaire. La deuxième étape de la méthodologie permet l'évaluation de la flexibilité de la conception obtenue dans la première étape face à un nombre supplémentaire de variations imprévues et générées aléatoirement. Le modèle détermine l'effet des variations des conditions de fonctionnement des procédés sur l'ensemble du site. En plus, le modèle permet de déterminer les degrés de liberté de la configuration en tant qu'alternatives structurelles ou opérationnelles permettant le bon fonctionnement du réseau face aux variations. Les informations sur l'enveloppe de flexibilité seront analysées afin d'ajouter des conditions critiques à la première étape de synthèse multi-période de manière séquentielle. Le problème d'optimisation de cette étape inclut des contraintes non linéaires. Le modèle est donc codé à l'aide du langage AMPL et utilise baron, un solveur non linéaire, pour calculer la solution optimale.

### **Formulation mathématique du modèle**

L'architecture de l'intégration énergétique multi-sites, obtenue à partir du modèle multi-période, est caractérisée par le nombre de réseaux intermédiaires, leurs températures, la capacité échangée, la capacité des utilités froides et chaudes locales et territoriales. En plus, elle est caractérisée par l'emplacement de chaque échangeur de chaleur. La stratégie proposée vise à résoudre un modèle de programmation mathématique non linéaire NLP pour identifier la capacité de la configuration à gérer une gamme de conditions de fonctionnement variables. Les résultats de ce modèle montrent si la configuration du réseau est faisable ou non dans la plage des variations et déterminent les degrés de liberté nécessaires pour s'adapter à ces variations. Le modèle mathématique comprend les bilans énergétiques et les contraintes sur les températures, sur les capacités des réseaux et sur la surface des échangeurs de chaleur. Il est basé sur une division nodale des flux des procédés ; les flux sont caractérisés par un nombre de nœuds et de branches en fonction du type d'échange (les échanges avec les réseaux intermédiaires, les utilités ou les flux du même procédé) et par conséquent indiquant la présence d'un échangeur de chaleur. Une équation du bilan énergétique est appliquée sur chaque nœud pour définir la quantité de chaleur reçue ou fournie et pour déterminer les températures des nœuds. La surface des échangeurs de la configuration générée est un paramètre défini, cependant une variable est ajoutée pour quantifier la surface supplémentaire requise pour garantir l'échange en présence des fluctuations. Cette variable est introduite dans la fonction objectif à minimiser en tant que pénalité. En plus, le modèle garantit le bilan énergétique global sur chaque flux. La capacité de chaque flux est égale à la somme de la chaleur échangée avec les flux du procédé, avec les réseaux tertiaires ou avec les utilités. La température de sortie de chaque flux est soumise à des contraintes de limites : l'utilisateur définit un écart maximal admissible de la température de sortie ciblée par rapport à la valeur nominale. Les réseaux ne stockent pas la chaleur par suite une équation qui égalise la somme de la chaleur fournie aux procédés à la somme de la chaleur récupérée des procédés est introduite. L'introduction des degrés de liberté qui permettent au système d'échange de tolérer les variations exige l'intégration de plusieurs contraintes afin d'identifier les variables à manipuler et de les quantifier (bypasse d'échangeurs, débits des utilités locales et territoriales, température des utilités).

L'objectif est de déterminer si la conception est capable de maintenir la température de sortie des flux des procédés face à un ensemble de perturbations et de fluctuations tout en minimisant les consommations des utilités. La faisabilité technique d'une configuration doit être garantie par l'utilisation des échangeurs de chaleur définis à l'étape de synthèse multi-période. Dans la formulation mathématique, l'utilisation d'un degré de liberté numérique (surface supplémentaire pour les échangeurs de chaleur) contribue à faciliter la résolution. Une configuration réalisable ne devrait pas utiliser des surfaces supplémentaires pour les échangeurs de chaleur pour répondre aux besoins de chauffage ou de refroidissement; par conséquent, cette variable doit également être minimisée dans la fonction objectif. C'est pourquoi, une pénalité (P) est associée à la surface supplémentaire d'échangeurs de chaleur, pour satisfaire le besoin de chauffage et de refroidissement en cas de fluctuations et de variations, est également ajouté à la fonction objectif. Ce modèle est appliqué sur deux étude de cas.

### **Cas d'étude utilisant un réseau vapeur**

Le modèle décrit est appliqué sur ce cas d'étude impliquant trois procédé afin d'évaluer la flexibilité d'une configuration d'un réseau de récupération de chaleur et de tester sa capacité à fonctionner dans différentes conditions de fonctionnement. Ce cas a été utilisé à l'origine pour appliquer le principe "plus moins principe" pour identifier les avantages de certaines modifications dans les procédés (débits) pour augmenter les économies d'énergie dans le cadre de l'intégration énergétique multi-sites. Dans la première étape, la structure optimale du réseau de transfert de chaleur est déterminée à l'aide du modèle multi-période de la première étape de la méthodologie, puis dans une seconde étape, la flexibilité de la structure est évaluée à l'aide de différents scénarios de variations des conditions opératoires. Le fonctionnement de la configuration est garanti en ajoutant plusieurs degrés de liberté à la structure pour pouvoir faire face aux perturbations.

- **Architecture aux conditions nominales**

La configuration du réseau d'échangeur de chaleur à l'échelle locale et territoriale est étudiée. D'abord, la configuration optimale du réseau d'échangeurs de chaleur de chaque procédé résultant de l'intégration énergétique à l'échelle locale est identifiée en utilisant la plateforme CERES. Ensuite le modèle multi-période est utilisé pour identifier les solutions d'intégration énergétique multi-site. Quatre réseaux vapeur à différents niveaux de température sont identifiés et la capacité échangée entre ces réseaux et les procédés est déterminée en utilisant une période avec des conditions nominales de fonctionnement. Le modèle identifie le besoin en utilité pour chaque réseau ainsi que leur localisation en minimisant les coûts d'investissement impliqué. Dans ce cas, les utilités sont placées sur le même neoud du procédé A qui est le plus dépendant des utilités ce qui peut contribuer à la diminution des coûts d'investissement. Les procédés localement intégrés, sont interconnectés via les réseaux tertiaires. Cela illustre clairement la complexité de la synergie énergétique établie. L'analyse de flexibilité ne doit pas se limiter à l'analyse des utilités partagées. Par contre, elle doit être étendue pour couvrir toute la structure d'intégration énergétique et déterminer sa capacité à faire face aux perturbations à l'aide du modèle décrit. Les deux réseaux de vapeur à la température la plus basse récupèrent la chaleur du procédé C et fournissent cette chaleur aux procédés A et B. Par conséquent, la capacité du procédé C à fournir cette chaleur tout en fonctionnant dans des conditions variables

est importante pour garantir le succès de la synergie. L'évaluation de la flexibilité est donc effectuée pour les fluctuations aléatoires des débits des trois flux du procédé C. Deux cas sont considérés:

- Le procédé C fournit de la chaleur aux réseaux de synergie mais ne peut pas compter sur la flexibilité des autres processus.
- Toute la flexibilité de l'éco-parc est évaluée.

#### Evaluation de la flexibilité du réseau d'échangeur de chaleur du procédé C

Le procédé C reçoit de la chaleur du réseau vapeur à haute température et fournit de la chaleur pour les réseaux à basse température. C'est pourquoi il est intéressant d'analyser sa capacité à tolérer des fluctuations tout en étant capable de fournir la chaleur aux réseaux. Le problème est résolu pour 80 variations aléatoires du débit des flux chauds du procédé.

Pour un débit nominal du flux froid recevant de la chaleur du réseau, la configuration n'est pas capable de tolérer aucune diminution du débit des flux chauds qui fournissent la chaleur aux réseaux. Cependant, en ajoutant un nouveau degré de liberté et faisant varier la température des réseaux, l'enveloppe de faisabilité est déterminée. Cette dernière regroupe les variations des débits de tous les flux du procédé C pour lesquelles la configuration reste opérable et capable de fournir la chaleur nécessaire aux réseaux est identifiée. Elle est délimitée par une diminution maximale du débit du flux chaud fournisseur de chaleur aux réseaux, par une augmentation maximale du besoin de chauffage du procédé et spécifiquement du flux froid. Les points critiques correspondant aux variations limitant la faisabilité sont détectés afin de les prendre en considération pour l'augmentation de l'enveloppe de faisabilité et la flexibilité de la configuration. En particulier, pour résoudre la limitation provenant de la diminution du débit du flux froid et la diminution du flux chaud simultanée, le bipasse des échangeurs peut être ajouté comme degré de liberté. L'évaluation des effets des différentes variations de débit des trois flux, leur influence sur le fonctionnement du procédé et une identification des points faibles du procédé C à partir des résultats du modèle sont effectuées. Cette évaluation montre que le procédé intégré dans l'éco-parc a une très faible marge de flexibilité s'il ne peut pas moduler ces interactions avec les réseaux. En résumé, l'opérabilité du procédé C est limitée par une augmentation du débit du flux froid et une diminution du débit des flux chauds car son chauffage est déduit du un réseau tertiaire ce qui entraîne des coûts opératoires plus élevés. Il a été démontré que la température des réseaux augmente la flexibilité du procédé, mais ce degré de liberté doit être étudié au niveau du site.

#### Evaluation de la flexibilité de la synergie énergétique au niveau du site.

Dans cette partie, une analyse de l'influence des variations et des fluctuations est réalisée en tenant en compte de la flexibilité des autres procédés et des degrés de liberté des utilités intermédiaires à l'échelle territoriale. L'ensemble de l'éco-parc est pris en compte dans les simulations en comptant sur la variation de la température et des débits massiques des réseaux. Il est clair que les degrés de liberté offerts par l'ensemble du parc et la variation des températures des réseaux et leurs débits correspondants ont élargi l'enveloppe de fonctionnement du procédé C. Le procédé peut désormais tolérer une augmentation supplémentaire du débit du flux froid et une baisse supplémentaire des débits des flux chauds par rapport à la limite maximale obtenue précédemment.

#### Cas d'étude utilisant un réseau liquide

Ce cas d'étude basé sur un projet d'intégration énergétique dans le sud de la Chine vise à démontrer la capacité du modèle à évaluer la flexibilité d'une architecture fixe d'un réseau de récupération de chaleur liquide entre deux procédés et sa capacité à opérer sous différentes conditions de fonctionnement. Dans un premier temps, le modèle de la première étape de la méthodologie est utilisé avec une seule période de fonctionnement considérant des paramètres nominaux des procédés pour déterminer la configuration du réseau tertiaire, puis dans une seconde étape, la flexibilité de la structure est évaluée avec scénarios faisant varier les paramètres opérationnels à l'aide du modèle NLP. Plusieurs degrés de liberté sont ajoutés à la structure afin de faire face aux variations envisagées. A noter que les réseaux d'échangeurs de chaleur à l'échelle locales sont supposés établis et que les flux utilisés sont ceux qui sont connectés avec des utilités.

La structure optimale de récupération de chaleur utilisant un fluide intermédiaire est donc déterminée à partir du modèle multi-période. Ce dernier détermine la quantité de chaleur récupérée d'un procédé à l'autre, les températures du réseau, les débits qui contribuent au transfert de chaleur, la surface de chaque échangeur de chaleur participant à la récupération de la chaleur et les coûts correspondants. Les résultats montrent clairement l'avantage de la symbiose énergétique entre les sites. Le modèle spécifie les flux de chaque procédé qui échange avec le réseau. A noter que le reste du besoin de chauffage et de refroidissement des procédés est satisfait en utilisant des utilités locales.

### **Evaluation de la flexibilité**

Le compromis entre les coûts et les économies d'énergie obtenus sont insuffisants pour des décisions d'investissement. Plusieurs variations dans les caractéristiques des procédés industriels peuvent intervenir et influencent l'optimalité économique et énergétique et privent le système de son efficacité. Dans cette étude de cas, pour une évaluation plus large de l'opérabilité du réseau intermédiaire de récupération de chaleur des variations simultanées (50) du débit des flux des procédés et spécifiquement ceux participant à l'échange avec le réseau intermédiaire sont introduites. Ces derniers suivent une distribution normale. L'écart maximal de la température de sortie des flux par rapport aux valeurs nominales est fixé. La violation de cet écart est considérée comme une infaisabilité du système. En plus, des degrés de liberté sont ajoutés progressivement : températures du réseau intermédiaire, températures des utilités locales. Ils sont des alternatives opérationnelles pour que la configuration puisse tolérer les fluctuations et les incertitudes qui peuvent intervenir. Les résultats obtenus identifient l'enveloppe de faisabilité et déterminent les limites de faisabilité : la diminution et l'augmentation simultanée des débits des flux de chaque procédé. La manipulation des degrés de liberté pour tolérer certaines variations critiques est discutée :

- La configuration fixe n'est pas capable de tolérer des variations opposées (augmentation demande de chaleur et diminution de l'excès de chaleur) malgré la variation de la température du réseau, le réseau a tendance à retirer plus de la chaleur mais une surface supplémentaire sera nécessaire pour chauffer les flux froids à la température de sortie en respectant l'écart maximal défini. Cela peut s'améliorer en ajoutant un degré de liberté : la température de l'utilité chaude ; la différence de température logarithmique moyenne sur les échangeurs de chaleurs connectant les flux froids à l'utilité chaude et la capacité fournie par cette utilité augmente pour compenser l'incapacité du réseau à chauffer le flux froid.

- L'augmentation simultanée nécessite les trois alternatives opérationnelles pour obtenir la température de sortie des flux des procédés ciblée en utilisant la surface d'échangeur fixée par le modèle multi-période. La variation de la température des utilités permet une augmentation du dtlm des échangeurs de chaleur connectés aux utilités. Par conséquent un échange de chaleur plus élevé est établi et la perturbation est ainsi réalisable.
- La limite définie par le système pour une diminution des débits des deux côtés a été améliorée lors d'un bypass est ajouté sur les flux où les variations se produisent. Le système est désormais capable de tolérer une diminution de 18% du débits du flux source de chaleur et une diminution simultanée de 10% du CP du flux froid. En effet, car, pour cette variation, le modèle bi passe partiellement le premier échangeur du flux froid connecté au réseau, entraînant une diminution de la température à la sortie de l'échangeur et par conséquent une diminution de la dtlm et donc moins de chaleur est fourni à ce flux par rapport aux opérations nominales.

## **8. Application de la méthodologie de la thèse à un cas d'étude industriel**

La méthodologie robuste pour la synthèse de réseaux de récupération flexible à l'échelle des éco-parcs proposée dans cette thèse combine :

- Une étape de synthèse multi-période : elle génère une configuration du réseaux d'échange de chaleur multi-sites entre les flux des procédés et les réseaux intermédiaires en prenant en compte les aspects hydrauliques et géographiques.
- Une étape d'évaluation de la flexibilité : elle évalue l'enveloppe de faisabilité de la configuration obtenue en prenant en compte l'échange de chaleur interne à l'échelle locale entre les flux des procédés et l'échange de chaleur externe avec les réseaux tertiaires.

La méthodologie dans sa globalité est testée sur un cas industriel. Ce dernier représente un exemple de symbiose énergétique entre plusieurs procédés. Il consiste à utiliser l'excès de chaleur de plusieurs sites industriels comme source de chaleur pour alimenter un réseau de chauffage urbain ce qui permet la réduction de la consommation des utilités externes. Cette opportunité garantit une utilisation rationnelle de l'énergie et donc une réduction de l'empreinte environnementale. Le réseau d'intégration énergétique indirecte multi-sites, utilisant l'eau comme un fluide intermédiaire, est modélisé comme un flux en boucle fermé qui récupère l'excès de chaleur des procédés et la fournit au réseau de chauffage urbain considéré comme puit en déficit énergétique. Le but est d'obtenir une configuration du réseau de récupération de chaleur flexible, capable d'opérer sous différentes variations de la demande de chauffage et de maintenir un fonctionnement optimal selon les critères économiques définis. En effet, la variation de la demande de chaleur du réseau urbain est liée à la température ambiante et par suite, elle varie donc chaque jour au cours de l'année. Cependant, la taille numérique du problème de synthèse qui inclut toutes les variations est grande et par suite, le problème n'est pas solvable en utilisant les méthodologies courantes. C'est pourquoi, la méthodologie proposée dans la thèse sera appliquée sur ce cas pour démontrer son efficacité en intégrant le maximum de variations dans le but d'obtenir un réseau de transport de chaleur optimal, rentable et efficace.

## **Description de l'éco-parc**

L'éco-parc étudié regroupe trois procédés indépendants qui représentent une opportunité efficace pour l'intégration énergétique. L'intégration énergétique à travers un réseau tertiaire nécessite l'installation de deux échangeurs de chaleur : entre le réseau et la source de chaleur et entre le réseau et le puit de chaleur. Cet échange nécessite une structure d'échangeurs de chaleur et de tuyaux adaptée. Les caractéristiques des flux chauds de chaque procédé sont collectées ainsi que le positionnement géographique et les routages possibles de tuyauterie. Dans ce cas, les flux qui sont connectés aux utilités sont retenus et spécifiquement les flux chauds parce que les procédés sont déjà intégrés à l'échelle locale et une valorisation de l'excès de la chaleur est prévue; les flux froids n'interagiront pas avec le réseau de récupération de chaleur et leur intégration aboutit à augmenter la taille du problème. La demande de chaleur du réseau de chauffage urbain est modélisée par un flux froid à chauffer de  $80^{\circ}\text{C}$  à  $100^{\circ}\text{C}$  et dont le débit dépend de la demande de chauffage. La synthèse du réseau de transport de chaleur inclut une évaluation économique étroitement lié au coûts des tuyaux à installer. Ces derniers relient tous les procédés considérés au point d'export de chaleur de chaleur. La position des procédés est détectée et les routages sont également définis par l'utilisateur.

Le besoin de chauffage du réseau urbain est étroitement lié à la température ambiante. C'est pourquoi les données météorologiques de température sont collectées pour une estimation précise de la variation de ce besoin. En effet, une relation linéaire entre la demande de chaleur et la moyenne de température ambiante est définie. A partir des données récupérées sur cinq ans, 60 variations de la demande de chaleur seront utilisées pour évaluer la flexibilité du réseau. En résumé, la méthodologie de la thèse sera appliquée sur ce cas. D'abord, un ensemble de conditions de fonctionnement initiales des flux ainsi que les données géographiques et les données techniques constituent le fichier d'entrée de données du modèle de conception multi-période. Ces données incluent : les diamètres des tuyaux disponibles et les coûts correspondants, les coefficients de linéarisation utilisés pour le calcul de la perte de charge et la puissance des pompes, les coefficients de linéarisation utilisés pour le calcul des coûts des échangeurs. Le modèle multi-période cherche simultanément dans toutes les périodes intégrées pour établir un réseau optimal du point de vue énergétique et économique. L'objectif est la conception d'un réseau de récupération rentable. Ainsi, la fonction objectif du modèle est de maximiser la rentabilité provenant de la vente de la chaleur par rapport aux coûts d'investissement impliqués.

La configuration obtenue est testée pour un nombre supplémentaire de variations et spécifiquement dans cette étude de cas pour toutes les variations qui ont été rencontrées au cours des cinq années en utilisant le modèle d'optimisation non linéaire afin de déterminer si la configuration fixe obtenue dans la phase de synthèse est capable de maintenir les températures de sortie des flux en utilisant une augmentation minimale de la consommation des utilités malgré les perturbations supplémentaires. La fonction objectif de ce modèle est de minimiser la consommation des utilités. En plus, la configuration ne doit pas utiliser de surfaces supplémentaires pour répondre aux exigences de chauffage ou de refroidissement. Par conséquent, un coût de pénalité associé à la surface supplémentaire des échangeurs de chaleur est ajouté à la fonction objectif. Ce degré de liberté numérique facilite la résolution du problème d'optimisation et la sélection des points irréalisables. La structure est étendue en ajoutant plusieurs degrés de liberté pour assurer un fonctionnement réalisable. Les résultats obtenus

permettent d'identifier les scénarios critiques de demande de chaleur qui ont causé le dysfonctionnement du réseau de transport de chaleur. Ensuite, le modèle de conception multi-période est résolu en utilisant les scénarios initiaux et les scénarios critiques afin d'obtenir une configuration optimale faisable capable de gérer plusieurs variations critiques rencontrées. Plusieurs itérations peuvent être nécessaires pour obtenir la configuration finale flexible.

### **Etude sur une période**

Généralement, les points extrêmes de demande de chaleur sont utilisés dans la première itération pour garantir une conception flexible couvrant toute la gamme de variations. Néanmoins, un réseau capable de gérer des perturbations extrêmes et critiques, ne garantit pas nécessairement un fonctionnement adéquat pour toutes les variations pouvant intervenir. En conséquence, deux demandes de chaleur aléatoires ont été choisies pour deux études mono-périodiques. Les résultats seront analysés afin de déterminer un premier lot de scénarios pour l'étude multi-période.

La première étape de la méthodologie est appliquée en utilisant une seule période de fonctionnement; cette dernière correspond à une demande de chaleur hivernale et printanière respectivement. Le débit du flux froid qui représente le puit de chaleur du réseau urbain est liée à la demande de chaleur considérée. Les résultats obtenus détaillent la chaleur récupérée de chaque procédé, la température du réseau intermédiaire et la surface des échangeurs de chaleur à installer. En même temps, Le modèle choisit des flux spécifiques de chaque procédé pour établir l'échange de chaleur. Le réseau conçu en fonction de la demande hivernale récupère 94% de cette dernière. En parallèle, le réseau conçue pour la demande printanière récupère la totalité de la demande en utilisant deux procédés et par suite en évitant l'installation d'un troisième échangeur de chaleur et des tuyaux nécessaires et en minimisant les coûts d'investissement. A noter que, en comparant les deux résultats, une augmentation de la température supérieure du réseau est constatée ; cela correspond à une augmentation de la dtlm et par suite correspond à la réduction de la surface de l'échangeur de chaleur installé sur le puit et des coûts d'investissement. La deuxième étape de la méthodologie est appliquée : l'opérabilité des deux configurations mono-périodiques est testée à l'aide du modèle non linéaire sur soixante variations de la demande de chaleur en variant le débit du flux froid. Les résultats montrent que la configuration hivernale est incapable de tolérer des demandes de chaleur basse. De même, la configuration printanière est faisable uniquement pour les variations aux alentours de la variation considérée. En effet, l'infaisabilité est détectée quand la température de sortie des flux dépasse l'écart maximale tolérable fixé à 3 ° C ou quand le modèle propose une surface additionnelle des échangeurs de chaleur installés. Une deuxième étude de flexibilité est établie pour les deux configurations en ajoutant des degrés de liberté : bipasse et variation de la température des utilités. L'enveloppe de faisabilité a augmenté mais elle reste toujours limitée. L'utilisation de la méthodologie s'avère indispensable, vu l'incapacité des configurations à faire face aux fluctuations malgré la présence degrés de liberté. Le lot de scénarios pour l'étude multi période n'inclura pas les demandes de chaleur critiques extrêmes. Deux périodes de durée égale sont utilisées correspondant aux deux cas de demande de chaleur étudiés.

### **Etude considérant 2 périodes**

Le modèle multi-période est résolu en utilisant les données techniques et géographiques et uniquement avec les flux qui ont été choisis dans la précédente étude mono-périodique. La contrainte d'un investissement unique pour toutes les périodes oblige le modèle à utiliser la

même surface d'échangeur de chaleur à installer sur les flux spécifiés et le même diamètre de tuyau pour les deux périodes. La discrétisation de l'échelle de température accorde un degré de liberté permettant la variation de la chaleur récupérée dans chaque période. Le modèle choisit l'emplacement des échangeurs de chaleur sur les intervalles de l'échelle de température; éventuellement, l'intervalle le plus élevé pour les flux chauds est utilisé pour obtenir une différence de température plus élevée et une dtlm plus élevée. Dans la première période, le réseau récupère 68,8% de la demande de chaleur; la demande de chaleur supplémentaire est satisfaite par une utilité chaude. De même, les utilités froides sont utilisées pour refroidir les flux chauds à leur température de sortie ciblée. La chaleur récupérée au cours de la première période est inférieure à la chaleur récupérée obtenue lors de l'étude mono-périodique. En effet, le modèle cherche la solution la plus rentable économiquement et ceci en évitant le surdimensionnement des échangeurs et des tuyaux tout en satisfaisant la demande des deux périodes. Dans la deuxième période, la demande totale de chaleur est récupérée.

La deuxième étape de la méthodologie consiste à tester l'opérabilité de la configuration obtenue face à tous les scénarios de fluctuation de la demande de chaleur. D'abord, la configuration est adaptée à la division nodale en caractérisant toutes les connexions et spécifiquement en identifiant l'emplacement de chaque échangeur de chaleur et leurs surfaces. Le modèle est résolu pour 60 variations du débit du flux froid. L'évaluation de la flexibilité a d'abord été effectuée en utilisant un seul degré de liberté: la température supérieure et inférieure du réseau. Les résultats montrent que l'enveloppe de faisabilité a augmenté par rapport à la conception précédente tout en détaillant les variations faisables et non faisables. Le modèle optimise pour chaque variation les températures de réseau. Un seuil minimal de la demande de chaleur est détecté au-dessus duquel toutes les variations sont non tolérables par la configuration. Pour augmenter l'enveloppe, une combinaison de variables manipulable est ajoutée : bipasse sur les échangeurs connectés au réseau. L'enveloppe de faisabilité a augmenté et le réseau devient capable de tolérer des demandes basses de chaleur. Le seuil minimal a diminué. Le modèle ainsi profite des biphases sur les échangeurs connectant les flux au réseau pour minimiser la chaleur récupérée et satisfaire le besoin faible du réseau urbain. La demande supplémentaire en froid est satisfaite en utilisant l'alternative opérationnelle : la variation de la température des utilités froides. En effet, cette dernière permet une augmentation de la dtlm de l'échange entre les flux chauds et les utilités froides locales et par suite un échange plus important.

### **Configuration avec trois périodes**

Les résultats obtenus sont utilisés pour identifier les scénarios critiques à ajouter au lot initial de scénarios de variation et initialiser une deuxième itération de la méthodologie afin de trouver une nouvelle configuration. Par conséquent, une période supplémentaire est ajoutée aux données d'entrées du modèle multi période. Le réseau obtenu satisfait 29%, 59% et 100% de la demande de chaleur de chaque période respectivement. Les interactions entre le réseau et les procédés sont identiques dans les deux premières périodes. Dans la troisième période, le modèle profite de la variation de la température du réseau grâce à la discrétisation de l'échelle de température pour récupérer la demande de chaleur en utilisant la même surface des échangeurs. Dans cette configuration, le procédé 2 ne participe pas. En effet, la fonction objectif économique oblige le système à réduire les coûts d'investissement et par suite le surdimensionnement des échangeurs et des tuyaux. Cette configuration collecte moins de chaleur avec un coût d'investissement plus faible. L'évaluation de la flexibilité de la



configuration obtenue est réalisé en vérifiant la température de sortie des flux et l'équilibre des puissances des connections. L'enveloppe de faisabilité augmente. Encore une fois deux nouveaux points correspondant à la demande de chauffage la plus faible ne sont pas opérables. En effet, l'objectif est de pouvoir réduire la quantité de chaleur échangée entre les flux et le réseau en utilisant la même surface fixe des échangeurs de chaleur; l'augmentation de l'écart maximal entre la limite supérieure et inférieure des températures du réseau est ajoutée comme alternative opérationnelle supplémentaire ; cette dernière permet de diminuer la dtlm et par suite la chaleur récupérée des procédés. La configuration est ainsi opérable sous les 60 variations.

### **Trois périodes avec des demandes extrêmes**

Pour souligner les avantages de la méthodologie, une conception qui intègre la demande de chaleur critique la plus faible dans le lot initial de scénarios du modèle multi-période est étudiée. Les résultats déterminent une nouvelle configuration de réseau de récupération de chaleur dans laquelle les trois procédés participent. Les interactions entre les procédés et le réseau est identique au cours des deux premières périodes; 17.3%, 35.4% sont récupérés à l'aide d'un fluide intermédiaire, la température du réseau change dans la troisième période et les procédés fournissent la demande totale au système de chauffage urbain. Des échangeurs de chaleur et des tuyaux de plus petite taille sont associés à cette récupération de chaleur réduite. L'opérabilité de la configuration est testée à l'aide du modèle non linéaire. Le modèle ne peut utiliser que la variation de la température supérieure et inférieure du réseau intermédiaire afin de trouver une solution réalisable malgré les 60 perturbations intégrées. Les résultats montrent la faisabilité de toutes les variations de la demande de chaleur. Néanmoins, la chaleur moyenne récupérée pour ces variations est plus faible par rapport à celles obtenues pour les configurations précédentes.

### **Comparaison économique**

Une évaluation économique est établie entre le coût d'investissement et le revenu des trois configurations. En utilisant les valeurs obtenues pour les différentes variations et fluctuations de la demande de chaleur, la moyenne de la chaleur récupérée et le coût de la chaleur vendue sont calculés. La configuration qui prend en compte les demandes de chaleur hivernales et printanières présente un gain élevé en raison d'une récupération de chaleur importante. Cependant, cette configuration n'est pas réalisable toute l'année et ne peut pas être utilisée pour de petites demandes de chaleur en été et par conséquent, elle est exclue. La conception obtenue par la méthodologie itérative et la conception obtenue à partir de la méthode heuristique conservatrice qui inclut la demande de chaleur la plus faible sont opérables sous les fluctuations considérées et possèdent des coûts d'investissements proches. Néanmoins, la quantité de chaleur récupérée et par conséquent, le revenu vendu au chauffage urbain de la conception obtenue par la méthodologie itérative sont plus élevées que ceux obtenus par la conception conservatrice. Cette comparaison économique démontre l'utilité de la méthodologie utilisée pour obtenir un réseau de récupération flexible capable de gérer les variations à l'aide de variables manipulées, telles que la variation de la température des utilités et des réseaux et des bypasses.

# Introduction

The increasing energy consumption mainly related to the economic and demographic growth and the alarming climate change due to greenhouse gas emissions drive the industries to implement innovative strategies to achieve high energy efficiency and consequently to comply with the restrictive environmental and quality regulations. Actually, energy efficiency can be significantly enhanced by incorporating heat integration methodologies into process design techniques. Originally, it was developed for heat recovery at the process level by connecting hot and cold streams of a process thus achieving a reduction in the net energy consumption at a single process scale. Progressively it has been extended to establish energy synergy and to design the utility systems to satisfy the heating and cooling requirement of multiple plants regrouped in geographical areas called eco-industrial parks. This type of cooperation between industrial companies for heat recovery reduces the overall costs and further increases energy savings beyond what may be achieved at the process scale.

Nevertheless, deviations of operating conditions such as supply and target temperatures and flow rates from nominal values are an everyday reality, thus the assumption of specific operation modes of the processes in heat integration methodologies is not sufficient to justify investments especially with all the interactions between the interdependent processes that can result. Thus, the operability issues are of vital importance to be considered in design methodologies and the flexibility assessment become an essential prerequisite of the heat transfer configuration. The aspects of flexibility of heat integration between multiple plants in eco-industrial parks cannot be taken into consideration in one stage synthesis procedure because the solution of the problem may quickly become a large problem therefore the main objective is to solve this challenging task by solving smaller optimization problems and therefore ensuring a practical computation time.

The aim of the thesis is to propose a systematic methodology for designing flexible energy synergy networks established between multiple processes geographically close that is able to operate effectively despite the fluctuations and variability in the operating parameters.

The first chapter of the thesis presents the environmental, economic and energetic context that encourages the implementation of heat integration methodologies at different scales to reach high-energy efficiency. Then, it presents the problematic of the integration of variations and fluctuations in the design procedure that consists a barrier for investments. A literature review of various approaches for flexibility evaluation in process design and in heat exchanger networks is also presented. Based on the literature review results, a two-stage methodology for design of a heat transport network is proposed to achieve a flexible design economically profitable. The two stages are presented in the following chapters.

Indeed, the second chapter details the first step of the methodology that determines the heat integration configuration between multiple processes that is able to operate for a finite set of scenarios introduced as a series of variations in operating conditions by adopting the multi period approach. The mathematical formulation that includes energetic, hydraulic and

economical features is detailed. The model is tested on two literature case studies investigating the technical and economic feasibility of the heat recovery opportunities across multiple individual process plants through a steam network and a liquid network that is subjected to different sets of variations of operating conditions.

The third chapter details the second step of the methodology. The corresponding NLP model consists in evaluating the flexibility of a fixed heat integration architecture that can be deduced from the first step, it allows taking into account additional variations and disturbances in the operating conditions that may occur at the local or territorial scale and to evaluate their impact on the design. In addition, the model introduces additional degrees of freedom offered at both scales as structural or operational alternatives that can be manipulated in order to overcome an infeasible operation. The model is tested on two literature case studies of virtual eco-industrial parks: the first is a steam network and the second is a liquid network.

The fourth and final chapter of the thesis consists in applying the two steps of the proposed methodology to a real case study. The aim of this case study is to design a heat recovery transport network that used liquid water to withdraw heat from several processes geographically close and transfer and sell it to nearby district heating systems. This network must be able to operate for multiple variations in the heating demand that might occur. The results are analyzed and highlight the relevance of having a methodology which allows a progressive approach of integrating critical scenarios in order to generate a feasible network with high heat recovery in a relatively more efficient way than any conservative design.

Finally, at the end of this manuscript all the results are synthesized in a conclusion and perspectives are proposed to future work developments.

# Chapter 1: Context and challenges

This chapter presents the context and the scientific background of this work. The challenge of this Ph.D. work consists of a new energy integration methodology proposing high-energy efficient solutions while considering the resilience and flexibility when the processes face multiple perturbations and variations in the operating conditions.

The environmental, energetic and economic contexts that motivate the global efforts in industries to increase their energy efficiency is first presented. A focus on the implementation of energy integration methodologies that can be applied on local scale and on territorial scale; the latter tools and methodologies lead to the design of the heat recovery systems inducing a minimization of energy consumption. The lack of flexibility of integrated process may be a barrier to the development of large-scale energy integration. Therefore, the concept of resilience and flexibility is introduced. A literature review of the work carried out on flexibility evaluation and process design based on this criterion is presented. This allows defining the scientific challenges of this work. Finally, a two steps methodology to be implemented in this work is proposed.

## 1.1 General Context

Since the beginning of the 19th century, there is an increase in global population that is expected to reach 9.8 billion in 2050 according to the United Nations [1]. In fact, the energy supply provided from the availability and accessibility of energy resources notably fossil fuels has been affected by multiple socio-economic fields as medical advances, improvements in public health, increased agricultural productivity, development of transportation and industry etc. and thus have been influenced and lead to the population growth [2]. In addition, the accelerated use of energy has played a vital role in the expansion of the productivity and thus has fueled economic development as shown in figure 1.

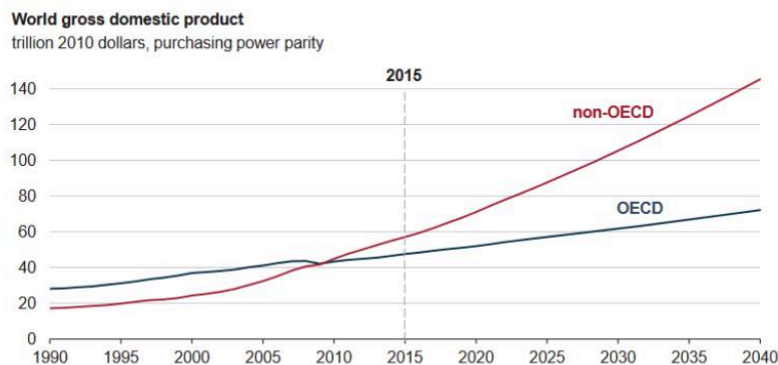

Figure 1: World total gross domestic product 1990-2040 (trillion 2010 dollars) [3]

The last decades are characterized by an important increase of the economic growth (measured by gross domestic product (GDP)). Till 2010 it was dominated by OECD countries (Organization for Economic Cooperation and Development), however with the industrialization and development of infrastructure and technological systems of non OECD countries, the expected rate of increase of GDP of non OECD will exceed the OECD's with 3.8% per year from 2015 to 2040.

This fast rate of economic growth and the quickly growing population implies rising in energy consumption that is forecasted to increase from 575 quadrillion British thermal units (Btu) in 2015 to 736 quadrillion Btu in 2040 as shown in figure 2 [3] and it should be noted that most of the increase will occur specifically in the developing non OECD countries in order to line with the expansion of industrialization and urbanization in these countries.

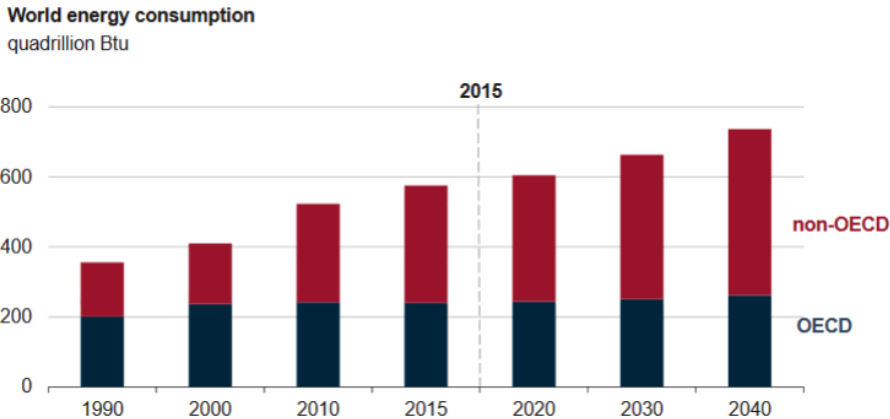

Figure 2: World energy Consumption [3]

However, this energy need/dependence has to face a critical problem that is the threat of resource depletion. In fact, fossil fuels (coal, oil, natural gas) are the main sources of energy and it is expected to continue to rely on to meet the growth in energy demand in the future. As shown in figure 3, fossil fuels will still be accounting for 77% of energy use in 2040 [3] although a faster increasing average of consumption of renewable energy (2.3% per year between 2015 and 2040) compared to fossil fuels.

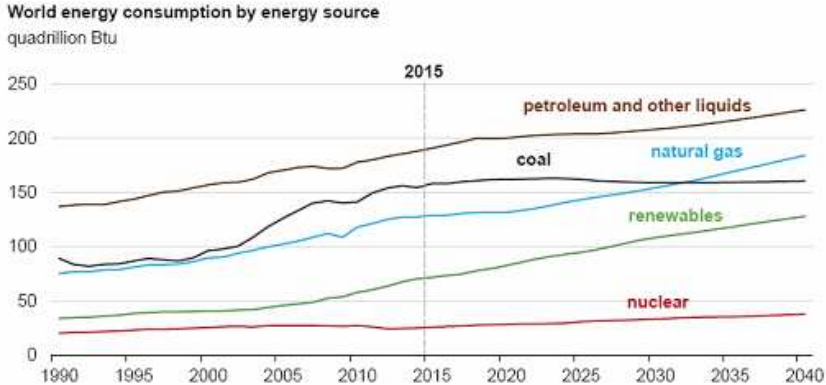

Figure 3: World energy consumption by energy source [3]

Another threat that the world has to face is the climate change due to greenhouse gases. The combustion of fossil fuels is the largest source of carbon dioxide emissions that is a contributor to the greenhouse effect. The disturbance in the carbon cycle due to the high level of atmospheric concentration of CO<sub>2</sub> is believed to be primarily responsible for global warming and climate change. The energy related CO<sub>2</sub> emissions is expected to rise from 33.9 billion metric tons in 2015 to 36.4 billion metric tons in 2030 and to 39.3 billion metric tons in 2040 as shown in figure 4, and that growth is mostly attributed to developing non-OECD nations.

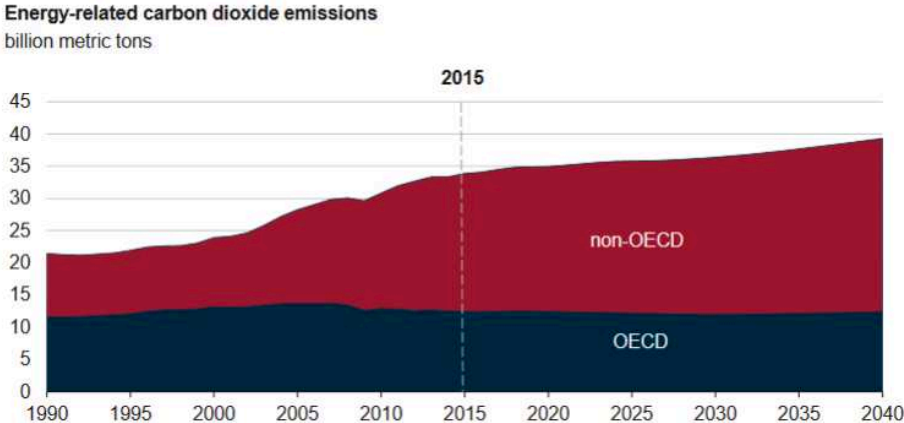

Figure 4: OECD and Non-OECD energy related carbon dioxide emissions, 1990-2040 (billion metric tons) [3]

The resulted irreversible and severe impacts across the world of global warming encourage taking serious actions at corporate, local, national and international levels around the world to limit the harmful emissions. Recently, Paris Agreement at COP 21 (Conference of the Parties) in December 2015 involves 189 countries that agreed to limit the increase in long-term average temperatures to two degrees Celsius (2°C) or go towards the goal of 1.5°C compared to pre-industrial levels by submitting 162 Nationally Determined Contributions (NDCs), targets and actions to reduce greenhouse gas (GHG) emissions.

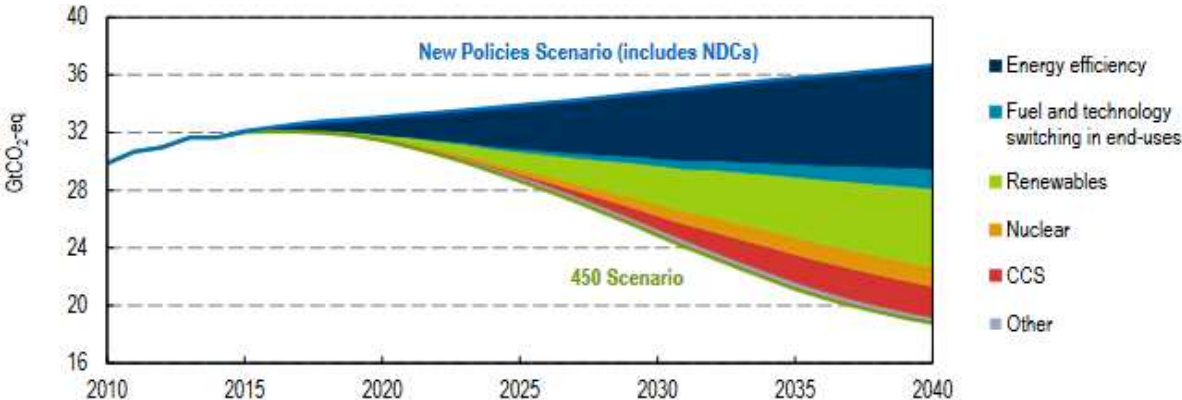

Figure 5: Measures needed to be deployed and its potential for reduction of CO<sub>2</sub> emissions

Figure 5 compares the different roadmaps and transition pathways for the reduction of harmful emissions and shows that energy efficiency makes the largest contribution; 38% of total

emissions reductions through 2040 and surpasses the role of renewable that provides 32% of reductions.

Energy efficiency allows, in addition to GHG emissions reduction, to achieve economic competitiveness and reduce to the risk to energy price volatility.

## 1.2 Energy efficiency

IEA analysis indicates that energy efficiency is foreseen as the vital strategy to be deployed in order to reduce emissions and achieve NDC targets [4] as shown in figure 6 where the avoided emissions in 2015 in IEA member countries from energy efficiency improvements made since 2000 was 1.6 Gt CO<sub>2</sub> and the cumulative avoided emissions since 2000 from these improvements are 13.2 Gt CO<sub>2</sub>.

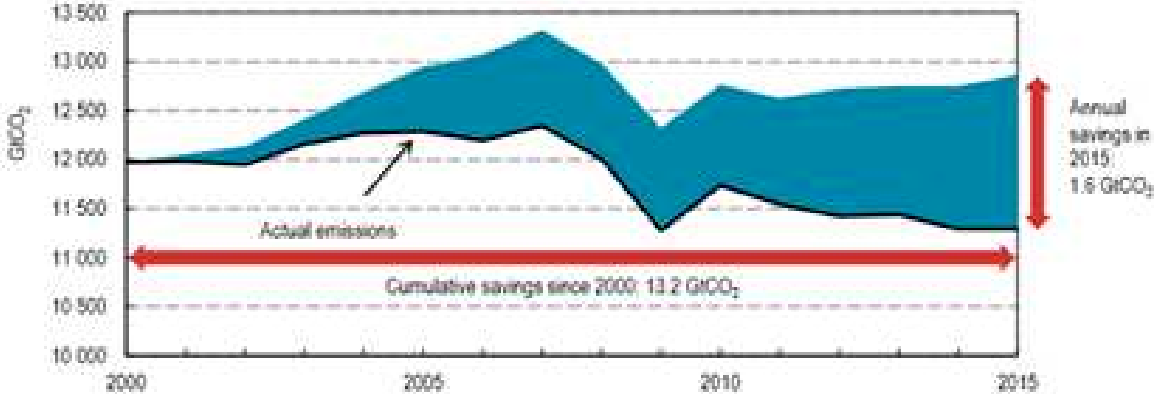

Figure 6: IEA member countries emissions from fossil fuel combustion and end-use emissions savings from energy efficiency improvements [4]

Indeed, energy efficiency refers to the reduction of the input energy required for the operation of any system while obtaining the same output. Thus the rational use of energy helps minimizing the environmental impacts of energy consumption without limiting the economic development.

### 1.2.1 Energy efficiency in industry

The industrial sector accounts for the lion's share of energy consumption and it will continue to increase by 18% from 2015 to 2040, reaching 280 quadrillion Btu by 2040 [3]. Most of the long-term growth occurs in non-OECD countries by an average of 0.8% per year in comparison with an increase of 0.2% per year in OECD countries. As the industrial sector consumes a large proportion of total energy, improving the energy efficiency in industries should be prioritized.

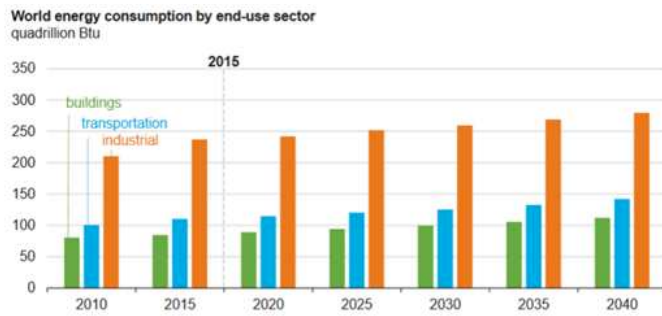

Figure 5: World energy consumption by end-use sector [3]

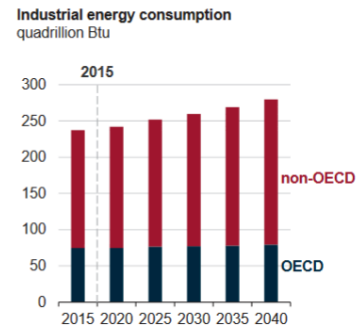

Figure 6: Industrial energy consumption in OECD and non-OECD [3]

To summarize, the continued industrialization, the economic and population growth especially in the non OECD countries is threatened by resource depletion. Moreover, climate change due to greenhouse gas emissions is a global threat to the planet and its ecosystem. . Effective actions in the industrial sector, as being a huge consumer of energy, are consequently essential to comply with environmental regulations. Energy efficiency is therefore promising for industries, helping in the reduction of the environmental impact and energy costs.

### 1.3 Integrated process design

One powerful way to improve energy efficiency and thus decrease harmful emissions and negative environmental impact in industry is through the design of integrated processes. The latter uses various methodologies and approaches employed by designers for process synthesis that aim a better use of the resources available internally and therefore reduce the amount of external resource that is required. In fact, most manufacturing processes can produce or consume resources during the different operations of the process or in other words have sources and sinks of the resource. An integrated process design can be developed by matching these sources and sinks in the optimal manner to have the best transfer operations between the streams maximizing the recovery of the resource. Heat and mass integrations are two applications of these approaches that recover waste heat or matter [5].

At first, these techniques of recovering the surplus or waste of resources were performed on individual processes (local scale) through the design of a recovery network that ensures the transfer of resources between the local streams of the process and then the concept was extended to cover multiple processes regrouped in a geographical area (total site scale) paving the way to design eco-industrial parks.

### 1.4 Eco-industrial parks

Eco-industrial parks concept has gained more and more attention recently. It represents a practical application of industrial symbiosis concept where multiple separate industries are engaged in resources exchange including energy, water and materials which will further reduce the external resources consumption compared to what may be achieved at the process scale. In



fact, the geographical proximity offers opportunities for heat, matter or water synergies which represent a supplementary boost for improving energy efficiency and thus presenting an appealing solution to the environmental issues mentioned above.

A successful industrial symbiosis example is realized at Kalundborg in Denmark. The list of engaged companies include Asnaes a power station that is the largest plant producing electricity in Denmark, Statoil an oil refinery that belongs to the Norwegian state oil company, the town of Kalundborg receiving heat as well as other companies. They cooperate and exchange water, steam, electricity and matter.

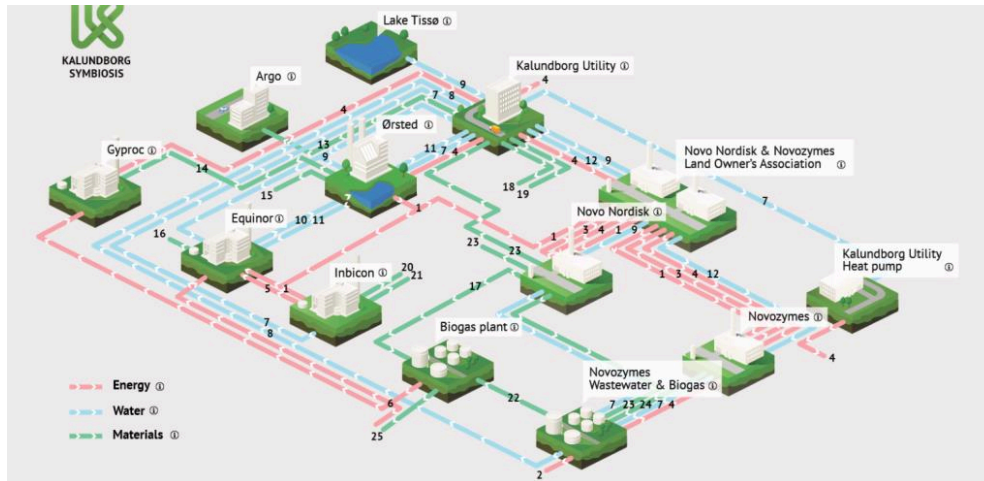

Figure 7: Kalundborg eco industrial park and the interaction between different actors [6]

## 1.5 Heat Integration at process and site scales

As previously mentioned, heat integration is one of the multiple applications of process integration concepts seeking to recover heat between the hot and cold process streams (Figure 8). Various methods and heuristic rules have been developed to help the designer solving the heat integration problem. The two main heat integration techniques: the pinch analysis relying on thermodynamic insights and mathematical programming techniques relying on mathematical models more or less complicated and solved using numerical methods. The difficulty of mathematical programming is to elaborate the mathematical model by establishing a set of equations and their corresponding variables and parameters that represent the operation of the system. This method has the advantage of carrying out an optimization of the system and establishing multiple objectives specially the trade-offs between costs, energy savings and environmental impact reduction compared to the traditional targeting pinch analysis method. The mathematical programming techniques are classified into general categorization: linear and non-linear programming.

- Linear programming (LP) is an optimization technique of a linear objective function subjected to a list of constraints represented by linear equations. When some variables to compute are integers, the optimization is then called Mixed Integer Linear Programming (MILP).

- Nonlinear programming NLP consists in solving a problem of optimization where the objective function and / or some constraints are nonlinear. Here also integers may be used to introduce structural existence of some components leading to MINLP problems.

The next paragraph presents a literature review and the efforts on research for the developments of heat integration methods.

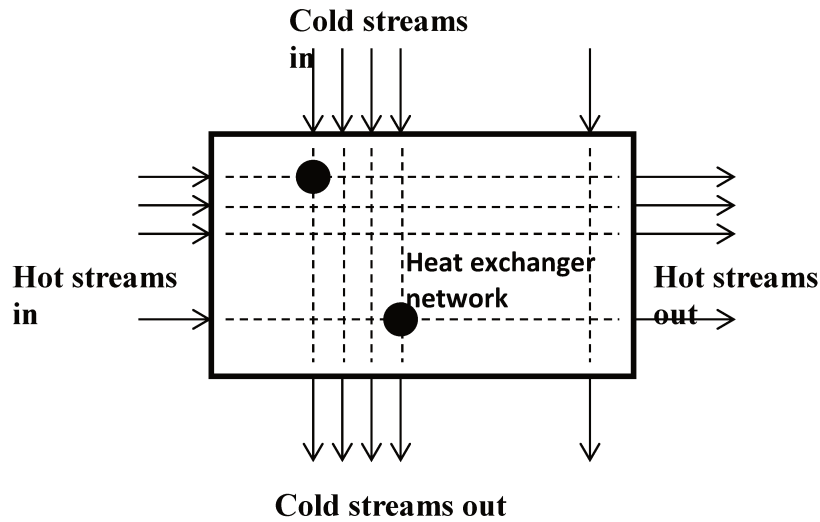

Figure 8: Matching hot and cold process streams

### 1.5.1 Pinch method for heat integration at the process scale

The pinch concept is the first systematic method that sets energy targets to recover heat by matching hot process streams (that must be cooled ) and cold process streams (that must be heated ). It is based on graphical tools: the hot and cold composite curves that represent separately the total heating and the total cooling requirements of a process in a Temperature Enthalpy diagram. The latter is constructed by dividing the temperature axis into intervals using the supply and target temperatures of the streams and by adding the enthalpy contribution of hot and cold process streams separately in each temperature interval; the point of smallest distance between the curves is referred as The Heat recovery pinch. Consequently, for a fixed minimum temperature difference, it allows identifying the maximum heat recovery potential as well as the external heating and cooling utilities requirement as shown in figure 9.

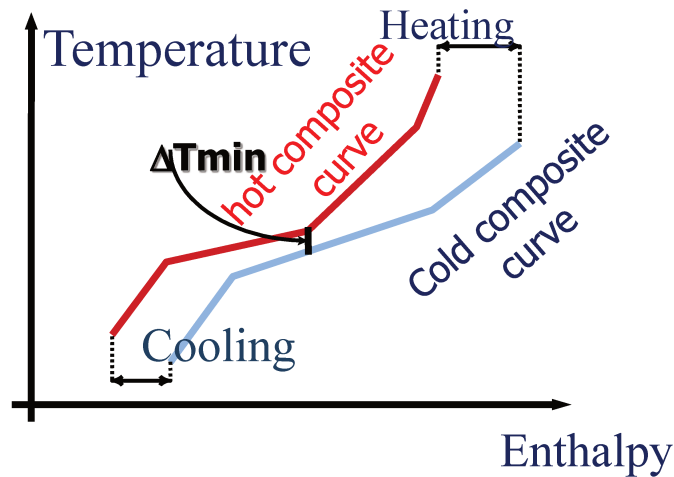

Figure 9: Hot and Cold Composite Curves

The minimum allowed temperature difference  $\Delta T_{min}$  is an economic parameter that indicates a trade-off between investment (heat exchanger costs) and operating costs (energy consumption) [7]. As shown in figure 10, high values of  $\Delta T_{min}$  imply more utility requirement and thus higher operating cost, and low values of  $\Delta T_{min}$  imply larger heat exchanger areas and investment costs.

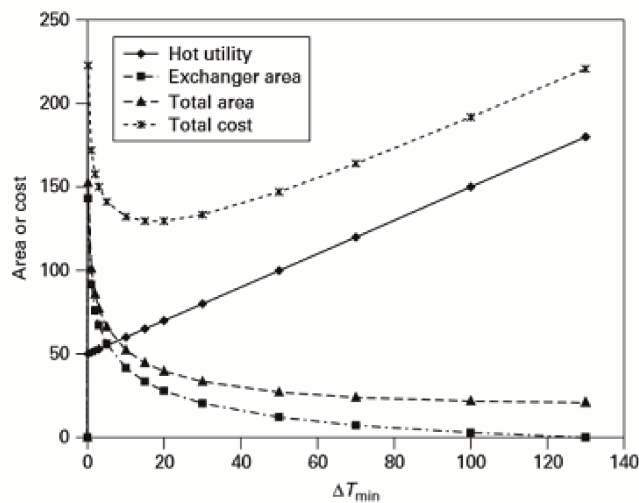

Figure 10: Utility use, heat exchanger area and cost variation with  $\Delta T_{min}$

Another graphical tool, the grand composite curve (GCC) is plotted using heat balance established at each temperature interval between the hot and cold streams involved at the interval; the heat surplus is cascaded as heat residual to lower temperature interval. The GCC is used to identify the optimal placement of utility (temperature level) and its corresponding load. As shown in figure 11, external heating is needed in the region above the pinch that is in heat deficit and external cooling is required in the heat surplus region below the pinch to satisfy the overall cooling demand.

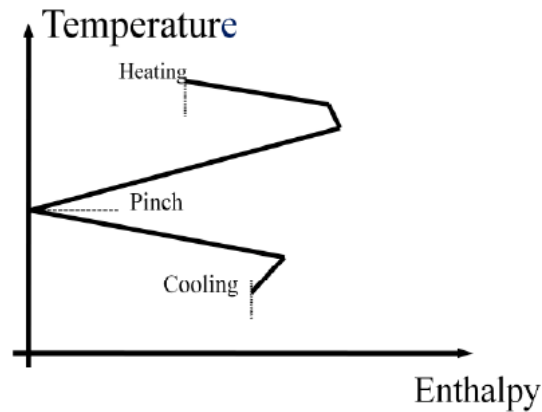

Figure 11: Grand Composite Curve

Similarly to the original heat pinch concept, the technique was manipulated and used for water pinch analysis, material recycle/reuse [8] and in other applications such as oxygen consuming processes (Oxygen Pinch) [9].

## 1.5.2 Mathematical programming for heat exchanger network synthesis

The mathematical programming techniques can be used for the optimal synthesis of heat exchanger network (HEN) by including economic objectives. These techniques are divided into sequential approach that divides the HEN synthesis into sub-problems where the solution of each can be used as input for the next sub-problem as proposed in [10] and in [11] and simultaneous approach as proposed in [12], [13] and [14] for a more rigorous tradeoff between energy, number of units and costs of the heat exchangers and utilities. Furman et al. in [15] detailed the formulations of the solution methods for HEN synthesis.

## 1.5.3 Heat integration at total site scale

### 1.5.3.1 Energy targeting methods

Lately, developments have focused on exploring heat integration between closely located industrial sites forming an eco-industrial park. In fact, heat recovery between multiple processes can offer energetic and economic efficiency improvements. In this perspective, the extension of the heat integration application from the scale of a process to territorial or total site scale was proposed originally by Linhoff and Dhole [16] to provide energy targets for heat recovery between multiple plants related to each other and called "Total site" and therefore to design the utility systems to satisfy the heating and cooling demand of the processes. The Total site analysis (TSA) is based on a graphical tool to target the amounts of excess heat generated from one process that can be passed to other process with a heat deficit through an energy transport system (e.g. steam, hot water or hot oil networks). The site and source profiles are plotted by combining the heat sink/ source region of grand composite curves of each process and by listing the heat capacity contribution of individual process in the corresponding temperature interval

of the site sink/source. It should be noted that the temperature intervals used for the pinch are shifted back to their original values than shifted according to the  $\Delta T_{min}$  between the utility and the process. Therefore the total heat surplus available and the total heat deficit of the processes in a total site can be depicted and the utility usage and generation are directly interpolated at the corresponding temperatures as shown in figure 12. Klemes et al. [17] added additional advances by developing the Site Composite Curves (SCC) to perform Multiple Utility targets (MU) and the Site Utility Grand Composite Curve (SUGCC) to provide targets for the cogeneration in the Total Site.

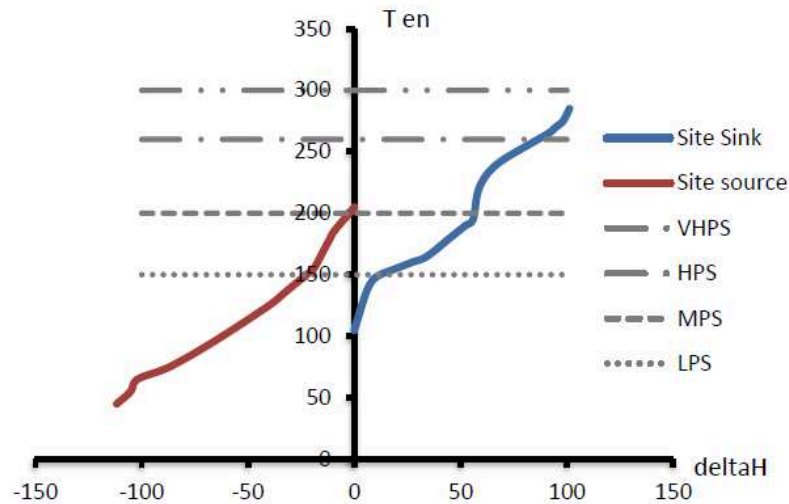

Figure 12: Total Site profiles

Varnabov et al. in [18] extended the traditional methodology for Total site targeting procedure by revising the simplified assumption of a global minimum temperature difference  $\Delta T_{min}$  used in the previous methods that leads to imprecise estimation of the heat recovery targets. Thus, they specified individual  $\Delta T_{min}$  values for each integrated processes of the Total Site and for the heat exchange with each of the site utilities which may provide a better estimation of heat recovery targets and more appropriate evaluation of tradeoff between capital cost and energy gain.

At first, the TSA concept was applied on industrial processes; Hackl et al. in [19] applied the concept for heat integration in a chemical cluster in Sweden and have shown the benefits of energy collaboration between different plants to reduce energy cost and improve energy efficiency; they suggested water as the intermediate fluid to build a more interconnected utility system for individual plants. Also, it was applied in various industrial implementations like in a Japanese large scale steel plant by Matsuda et al. in [20]; they identified a larger amount of energy savings potential. However recently Perry et al. [21] extended its application to include processes from other sectors: residential, business, services and agriculture termed Locally Integrated Energy Sectors (LIES).

In addition, TSA was used in by Bandyopadhyay et al. [22] in order to estimate the cogeneration potential of the site using the site utility grand composite curves.

The industrial issues in the use of TSA that can affect the implementation of the heat integration in a total site like operational, design and economic issues were listed by Chew et al. [23]. They developed a matrix to weight the impact of these issues using a heuristic approach. Recently, in order to prevent the under sizing of central utilities and have more realistic estimation of the energy targets Chew et al. [24] estimated pressure drops in steam distribution system, pressure drop due to pipe friction and to elevation change and across control valve and heat exchangers during the targeting stage in total site heat integration.

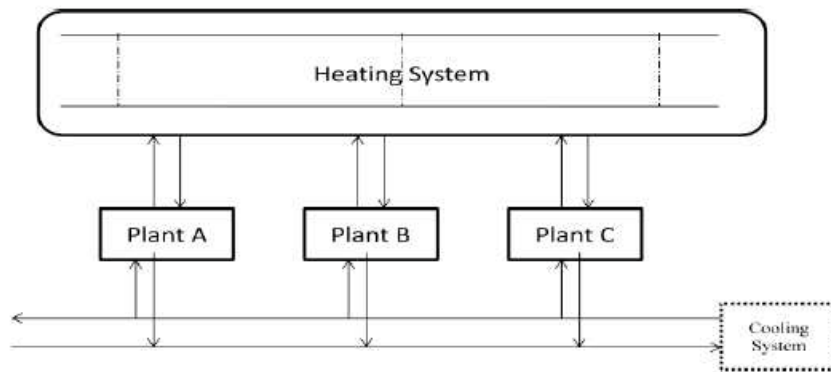

Figure 13: Schematic representation of the common utility system of the TSA concept

Process modifications like potential variations of temperature or flow rate of some certain streams were studied to maximize energy saving of the multiple plants energy integration in [25]. This was established using an extension of the plus minus principle [26] to total site; the latter was first applied for single processes to set guidelines on how changes in heat balance can reduce utility needs, then on a total site where it also provides insights for the identification of options in the different region of the total site profiles that will bring improvement to increase heat recovery between heat source and sink. The expert designer detects the segment and the temperature interval on the Total Site Profile (TSP), spots the contributing streams to focus on and then proposes potential changes to apply and which are prioritized based on a set of heuristics and then assess the practical and economical feasibility of the identified potential modifications in order to establish the aimed changes. Consequently, the chosen modifications can be thus retained and to be applied for future retrofit projects. Also process modifications were used to target decreasing the capital cost of heat transfer units in [27] by using the same principle in order to detect the changes in TSP shapes that would result a larger temperature driving force between the steam utility and process and thus a reduction in heat transfer area and cost of heat exchangers.

### 1.5.3.2 Mathematical programming for heat integration on a total site scale

The energy targeting procedure was developed through mathematical programming approaches in [28] where Rodera et al. identified that the effective heat transfer occurs at the temperature level between the pinch points of the two plants. Then in [29] they presented a systematic procedure using LP model to determine the amount of heat to be transferred within the established temperature intervals, then MILP model to determine the minimum number of

connections between the two plant combinations using the energy targets of heat integration previously established and another MILP model to optimize the geographical path of the tertiary network.

In addition, mathematical programming approach dedicated to the Total Site problem was developed to design the steam utility networks. Mavromatis and Kokossis [30] modified the traditional targeting procedure; using a turbine hardware model they identified the optimal placement of steam levels based on the economical tradeoff between the fuel consumption associated with the supply of the heat demands and the cogenerated power. Also this model can be used in case of multiple operating conditions where it estimates the cogeneration potential of each scenario and establishes the optimum over the entire operation cycle. As the cogeneration potential varies for every scenario, such a task requires a model for shaftwork targeting that is able to account for the variation of the steam turbine efficiency with the load and the size of the turbine, as well as the operating conditions. Later, Shang and Kokossis included a boiler hardware model to describe the boiler performance to the turbine hardware model and used also a total site transshipment model to describe the interaction between the placement of the steam levels and steam loads of site processes [31] to optimize steam levels under different operational scenarios.

Chang et al. in [32] proposed a simultaneous synthesis of heat exchanger network in individual processes and for multi-plant heat integration using intermediate fluid circuits. It is based on the superstructure proposed in [33] and uses intermediate fluids that are considered virtual streams added in each process and its flow rate and the supply and return temperatures are variables to be optimized by the model. In addition, the methodology includes heat exchanger cost, energy cost, piping and pumping costs.

Recently Farhat et al. in [34] proposed a methodology based on the exergy minimization for indirect heat integration between multiple processes while simultaneously including multiple energy conversion systems. The methodology was completed by an economic feasibility evaluation that includes heat exchanger cost and the piping network associated with the heating network.

As shown in the literature review presented in the previous paragraph, the application of heat integration has become increasingly more important as it presents an effective solution for the improvement of energy efficiency in industry especially when it is applied on multiple processes. Graphical approaches based on thermodynamic insights have been used on the process scale (pinch analysis) and on the total site scale (TSA). Mathematical programming approaches were also used in order to include additional features as the tradeoff between the investment and operating costs; on the process scale several mathematical models have been developed to design the optimal structure of heat exchanger networks between the streams of the processes. On the site scale, it was used for steam utility network optimization and setting targets for the heat recovery and in recent developments these targets were adjusted to take into account the heat exchanger installation but it were based on the superstructure of Yee and Grossman [35]. When it comes to heat integration of multiple processes, the complexity



increases dramatically compared to local scale heat integration. Another issue with heat integration is the high dependency between streams and the potential loss of flexibility. Some researchers tried to define the flexibility and to quantify it and others tried to integrate the possible fluctuations during the design phase. The next section presents the state of the art of these works.

## 1.6 The problematic of variability and flexibility assessment

The main purpose of a process is to deliver output products that meet several specifications with maximum economic benefit and performance. However fluctuations and variations in the operating conditions are inherent characteristics of the processes. The inability of the design to manage the disturbances and uncertainties can either lead to dissatisfaction with customer demand or decrease the economic efficiency of the process. Therefore, in practice, any design must be able to meet the specifications despite the variations occurred in the operating parameters and flexibility concept must be introduced in order to ensure an acceptable economic performance in the practical environment of operations of the processes.

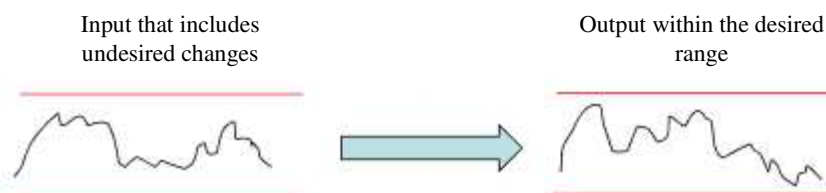

Figure 14: Flexibility Concept

The flexibility refers to the capability to maintain feasible operation over multiple variations in the operating condition as shown in figure 14.

In the next paragraphs, the notion of flexibility is introduced with the different methods of its quantification. Then the various works proposing different process design approaches and ways including the resilience and the flexibility in the design procedure are enumerated. The different methods for the incorporation of this concept in the heat exchanger network synthesis at the process scale are detailed. Finally, the works considering the operating conditions variations at the site level are presented.

### 1.6.1 Process design techniques integrating flexibility and uncertainty

Flexibility analyses of the process and its incorporation in the design step have received increasing attention in Process Systems Engineering. Generally optimal process design is a delicate task. In fact, the designer should not only take into account maximizing economic performance but also he should consider operability issues during the "normal" and "abnormal" operations of the process in order to find the optimal and flexible design that is able to manage the deviations of the parameters while optimizing the overall costs. In the literature, several approaches have been developed for the integration of economics and operability at the synthesis stage.



First, the challenges that arise are the modelling of the disturbances and uncertainties and the evaluation of the performance of the process and the effect of variability on process operation and on design. In other words, the problem of flexibility can be addressed at the design stage in the optimization model that includes flexibility constraints or it can be evaluated for a fixed design that has to face variations of some operating conditions.

The problem of flexibility can be addressed in two forms:

- Halemane and Grossman [36] firstly proposed the concept of flexibility analysis for design of robust and flexible process that is able to cope with the uncertainty and variability of the parameters of operating condition. They presented a rigorous formulation of the problem called the “flexibility test problem” where they included a max–min–max constraint that guarantee the feasibility of the operation on a limited range of uncertain parameter values  $\theta_n$ . Figure 15 illustrates the operational region of two designs, one feasible and the other infeasible.

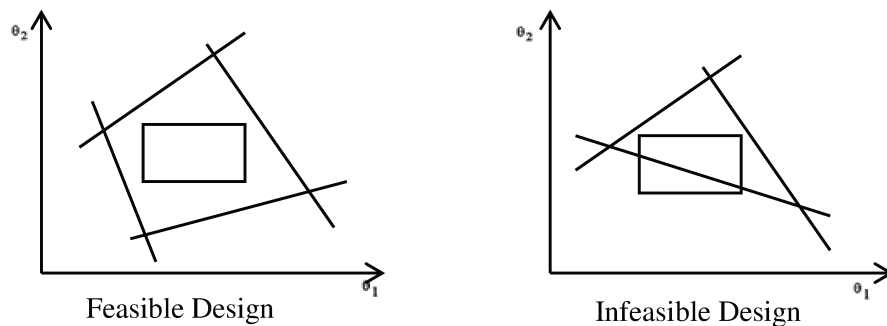

Figure 15: Flexibility test problem

The mathematical formulation max–min–max of the flexibility test problem consists of finding a proper control variable or in other words a proper adjustment (degree of freedom) to satisfy each of the equation of the constraints of the system to compensate the effect of the variation of the uncertain parameter in the whole range of variation for a specific design.

- Swaney and Grossman [37] generalized the problem in order to determine the parameter ranges that the design can tolerate for feasible operation and proposed a scalar to define these ranges. They introduced the “flexibility index problem” that quantifies the maximum deviation of the uncertain parameters that a feasible operation can handle using a search procedure.

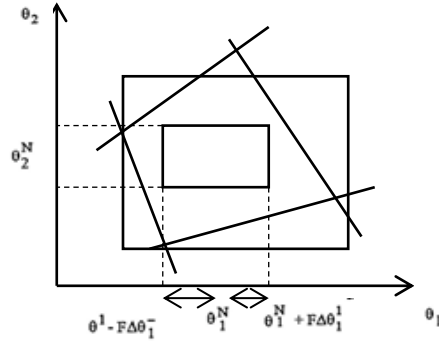

Figure 16: Flexibility Index Problem

The mathematical formulation aims to maximize  $\delta : F = \max \delta$  where  $\delta$  is the index that defines the largest scale of deviation of the expected uncertain parameter  $\theta \in T$  and  $T(\delta) = \{ \theta : \theta^N - \delta\Delta\theta \leq \theta \leq \theta^N + \delta\Delta\theta \}$  that the design can tolerate by having feasible operations (the constraints are verified over the whole range of the parameter). As shown in figure 16, the flexibility index problem determines the largest rectangle that can be included in the region of feasible operations for a given design.

The two problems can be formulated using a two level optimization problem, the first defines the flexibility and the second for the evaluation of the flexibility function.

Later, Grossman and Floudas [38] applied the active constraint strategy to replace the two level formulations by the "Karush-Kuhn-Tucker" KKT conditions and transforms the problem into one single level mixed integer optimization problem. Dimitriadis et al [39] have extended the "flexibility test" and "flexibility index" problems developed for steady-state models to cover the dynamic aspects that includes a temporal variation of uncertain parameters. The main difference is that uncertainty and feasibility depend on time. This aspect of flexibility tests the ability of a system to maintain operable over a finite time.

Another measure of flexibility was proposed by Pistikopoulos and Mazzauchi [40] called "stochastic flexibility, SF". In fact, probabilistic measures of flexibility are established especially when there is statistical information like an approximation of the probability distribution function of uncertain parameters.

Another approach to incorporate uncertainty in optimization model was introduced in the late 1990s: the robust optimization approach; it shared the same foundation with flexibility analysis that aims to find a design solution feasible for the entire range of variation of the uncertain parameter or in other words for any realization of the uncertainty set. The latest developments tend to diminish the differences between the two approaches [41].

Another way to tackle the uncertainty problem is using stochastic optimization strategy that does not determine the decision variables for design in the one simultaneous step but account for recourse and future actions to be taken progressively at different stages as a reaction in response to the realization of the uncertainty. Consequently, designs that are more conservative

are deduced from robust optimization in comparing with the stochastic programming [42]. The stochastic programming for optimization under uncertainty is based on scenarios approach and multiple discrete sets can be used to represent the uncertainty. One of the applications of the stochastic programming in process synthesis is the strategy adapted by Pintaric and Kravanja in [43] where they suggested a sequential two-stage procedure for the optimization and synthesis of chemical processes under uncertainty that ensures the flexibility and operability of the selected solutions using mixed-integer nonlinear programming (MINLP). The operability considered is the ability of the chemical process to handle multiple static perturbations and disturbances like variations in the feed stocks, variations in the economic parameters and variations in the operating conditions. The stochastic optimization in the first stage is performed to obtain optimal process topology, the design variables and the optimal over sizing that ensures flexibility for the whole range of uncertain parameters. However, despite the flexibility of the solutions, the structural deficiencies of the process are corrected in the second stage where supplementary degree of freedom are insured by identifying a combination of additional structural alternatives and manipulated variables and added to the optimal superstructure. It should be noticed that the identification of the manipulated variables is not automated and is based on the experience and knowledge of the designer.

Other extensions have been developed to link the flexibility problem with additional goals such as controllability and design for dynamic system.

- Bahri et al. [44] proposed a systematic integrated approach for the synthesis and design of flexible and controllable chemical processes by estimating the effect of perturbations on the operation of the process. In fact the methodology aims to calculate the amount of the back off that consists of two steps in each iteration of the algorithm called the inner and the outer loop. The outer loops give the best operating conditions for a given set of disturbances, and then in the inner loop, the feasibility of the decision variables selected are tested. At this point, the disturbances that produce most of the constraint violations are determined and subsequently transmitted to the next outer loop. It connects economic aspects with operability, by setting the distance between the optimal steady-state operating point and the plant's dynamic operating point. They extended the formulations of the steady state back-off computation [45] to consider dynamic situations for outer loops and inner loops.
- Similarly, the authors in [46] presented an iterative decomposition algorithm to obtain process designs and control systems, which are economically optimal while being able to cope with process variations. It consists of a successive resolution that alters between the solution of a multi-period design that determines the structure of the process and a set of design variables with an appropriate control structure that is able to cope with a set of "critical parameter" disturbances and uncertainty defined as periods, and a feasibility analysis, which identifies a new set of critical parameters and thus periods for fixed design and control that will be included in the first multi-period sub problem. The decomposition ensures a convergence to an optimal design capable to cope a defined perturbations and variability.

The developed methodologies described herebefore, aiming to link the flexibility problem and the controllability with the optimal design of the dynamic systems can be represented by the following schematic algorithm; Figure 17 presents the iterative approach between a multi-period optimization design and the selection of the control structure and the dynamic flexibility analysis; The second step allows the identification of critical parameters that the initial design of step one cannot cope with. The goal is to find at each iteration new design that is more robust. At the end, the optimal design is obtained when the feasibility is ensured over the possible disturbances and uncertainties that can be encountered.

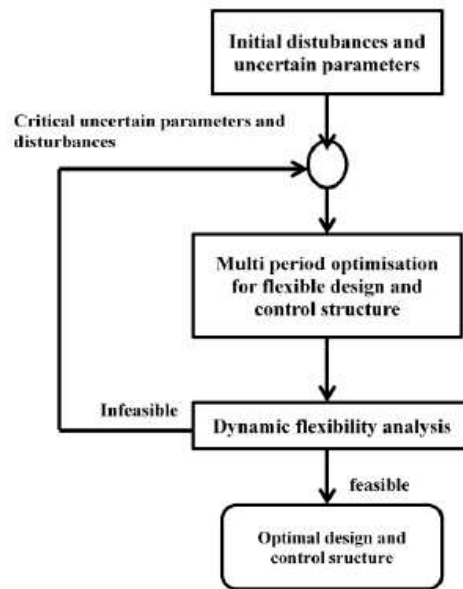

**Figure 17: Algorithm for flexibility and controllability of a process design**

## 1.6.2 Flexible heat exchanger network synthesis

The integration of the flexibility aspects in heat integration applications especially in the design of heat exchanger networks is one of the extensively studied problems. In this paragraph, the procedure adapted by the researchers in order to consider the essential prerequisite, the flexibility assessment, into the design technique to obtain a flexible heat exchanger network able to cope with multiple variations in the operating conditions of the streams of the process are detailed.

First Marselle et al [47] developed the concept of resilience of a HEN. They identified a number of possible "worst case scenarios": maximum heating, maximum cooling and maximum exchange and then combined the series of optimal designs under these conditions. Another layer was added by proposing the multi period approach to HEN synthesis problem [48] where the authors developed the multi period versions of the LP and MILP transshipment models proposed by Papoulias and Grossman that minimize the number of units and utility cost for each period of operation. This was followed by Floudas and Grossmann in [49] with an automatic generation of the detailed network structures using a non linear programming

formulation to derive the network configuration. Finally in [50] they introduced a systematic two-stage procedure able to cope with a variable range of temperature and flow rates. Each step includes an iterative procedure of a synthesis step and a flexibility analysis step. The first step combines the MILP transshipment to generate the set of stream matches and flexibility analysis using extreme points of the bounded range of the uncertain parameters. The second step combines the NLP formulation that generates the network structure with the active set strategy formulations to guarantee the desired HEN flexibility of supplementary non-extreme critical points.

Aaltola in [51] developed a multi period simultaneous MINLP model for synthesizing flexible HEN configurations, by considering a nominal and three periods for changing temperatures and flow rates. The framework proposed provides at first optimal configuration based on the superstructure of Yee and Grossman [35] for certain periods, then it tests the feasibility by measuring the temperature approach violation and finally the MINLP multi period is resolved with the data that includes additional periods representing the worst temperature approach violation that represent the critical conditions that limits the flexibility of the design. Also an NLP improvement model is added at the framework for considering the non isothermal mixing of the streams. It should be noted that in the objective function of both stages (MINLP and NLP) the average heat exchanger area was included. The authors Verheyen and Zhang in [52] added another layer to the work of Aaltola by applying the maximum area approach within a simultaneous MINLP model for designing flexible HEN in multi period operation for more accurate solutions.

Chen and Hung in [53] proposed a three-step approach for designing flexible multi-period HEN, which is based on the stage-wise HEN superstructure representation of Yee et al. [35] The authors decomposed the problem into three main iterative steps: simultaneous HEN synthesis which considers a finite number of operating conditions to give a network configuration with minimal annual cost formulated as a multi-period MINLP, flexibility analysis to check whether the network obtained is feasible throughout the disturbance range (the flexibility index is determined using the active set strategy [38] ), and removal of infeasible networks. The number of iterations is not fixed. In addition a set of extreme parameter points can be included to reduce the feasible space and to accelerate the design process.

### **1.6.3 Variation consideration in the TSA**

Several authors have proposed solutions to deal with some specific variations in the operating conditions. In [54] they identified an alternative numerical tool to target the utility requirement and heat savings; The Total Site Problem Table Algorithm (TS-PTA) is an easier and more precise method compared to the traditional graphical tools and prevent inaccuracies and errors when dealing with the curve shifting; they also proposed a total site utility distribution table to visualize the heat flows between the processes and total site sensitivity table to analyze the variation of utility requirement for multiple scenarios of plant shutdowns or different accidents. An extension to the sensitivity tables and their numerical methodology was proposed in [55] to

consider operational changes especially the shutdown for a single plant or multiple plants on the total site centralized utility system planning. This tool allows to analyze the variations of the heating and cooling requirement for the possible scenarios of shutdowns that can be encountered compared to the base case where all plants were operating under nominal and normal conditions in order to propose a suitable size of utility system and a plan for actions to be taken to avoid disruptions in the operation of the integrated processes.

Another layer was added to total site heat integration (TSHI) to overcome the often variations of energy supply and demand [56] by integrating renewable as heat sources energy that present a great challenge especially when the time horizons of the variability are diverse; they used time slices, a partition of the time zone into a set of time intervals, to model the variation and include heat storage in the heat cascade principle to allow the transfer of heat excess in one or several temperature intervals from an earlier time slice to same or lower temperature intervals of another later time slice.

In [57] they proposed a MILP optimization models to select the optimal operation of utility system of an industrial site and compute the optimal streams to be considered in the steam network. Furthermore, it considers a possible use of different technologies including gas turbines, cogeneration units, organic Rankine cycles, refrigeration systems, heat pumps. The multi period approach is used to take into consideration the variation with time of the operating conditions of each process; particularly a minimum number of sets of periods that can represent the yearly operation are established using a genetic algorithm.

A complete design of a total site was presented by Nemet et al in [33]; they proposed a stochastic multi period MINLP model based on TS Total Site superstructure updated from the original stage wise superstructure proposed by Yee and Grossman [35] to optimize the pressure level of the intermediate utilities for heat recovery and total cost by considering the future utility prices and they included the pipeline layout between the processes and take into consideration heat losses and pressure drops.

In the bibliographical review previously presented, the problem of quantification of the flexibility was described as well as the different approaches proposed by the authors to tackle the problem of flexibility in the process synthesis procedure. In addition, the flexibility criteria were introduced in the HEN synthesis on the process level; several methodologies were developed and detailed in the previous paragraphs. At the site scale, the few works considered scenarios to include fluctuations in the design phase and no structured methodology considering the flexibility is proposed.

## **1.7 Problem Statement and methodology**

The design of heat recovery networks between several processes in an industrial park as solution for heat integration problem can significantly enhance energy efficiency by reducing the utility consumption and thus the operating costs. However, major fluctuations in the environment of a process such as deviations from the nominal values are an everyday reality. These unavoidable

variations associated to the properties of processes (the inlet temperature, the outlet temperature and the heat flow rate variation of the streams) that can be caused by economic factors, weather conditions or maintenance operations, have a considerable impact on the economic and energetic optimality and can deprive the system of its efficiency especially with the complexity of the installed heat integration system at this scale that include major interactions between different industrial actors. Therefore, at this scale and the number of players, without a real assessment of industrial risk, investment decisions will not be made. Consequently, the heat integration solutions at these scales must not only take into account the tradeoff between costs and energy savings but also consider operational problems as a major point of their strategy, particularly with regard to the flexibility and resilience of interconnected processes. However, the developed tools at the total site scale, energy targeting methodologies or the mathematical programming approaches used fixed operating conditions or in some rare cases scenarios to design a configuration of the heat transport network. In this sense, the design of processes based solely on economic criteria and nominal parameters assumptions can lead to uncontrollable installations with unexpected behavior due to disturbances and uncertainties. The flexibility of the design that is an essential prerequisite of the heat transfer configuration has to be integrated at the early phase of the conceptual design to tackle the fluctuations problem.

Two types of variations can occur; deviations of a certain parameter around its nominal value that are caused by environmental conditions or by poor control of this parameter and periodical changes in operating conditions that can be either seasonal changes or intentional changes to the system operating conditions. Consequently, including these aspects of variability at the design phase is fundamental in order to suggest a design of heat transport network that is able to operate effectively in all encountered operating conditions. To address this issue, the multi period approach can be adopted to represent the variations in the operating conditions. This approach allows a representation of the fluctuations by a series of different set of static conditions as input for the model of simultaneous synthesis of the heat transport network between multiple processes in an eco-park in order to determine an optimal working system for all encountered periods. It is clear that higher number of scenarios increases the size of the problem that may become completely unsolvable by the current numerical means. Thus, the aspects of flexibility at the site wide scale of heat integration methodologies cannot be taken into consideration in one stage synthesis procedure because the resolution of the problem may quickly become a large combinatorial problem.

Consequently, inspired from the flexible HEN design works, a two-stage methodology of design of heat transport network is proposed to achieve a flexible design. It allows a compromise between an important calculation time and an infeasible calculation and the generation of a set of solutions with a higher level of flexibility. The proposed methodology is a progressive approach of integrating scenarios considered as critical, which would avoid the representation of all scenarios simultaneously (Figure 18).

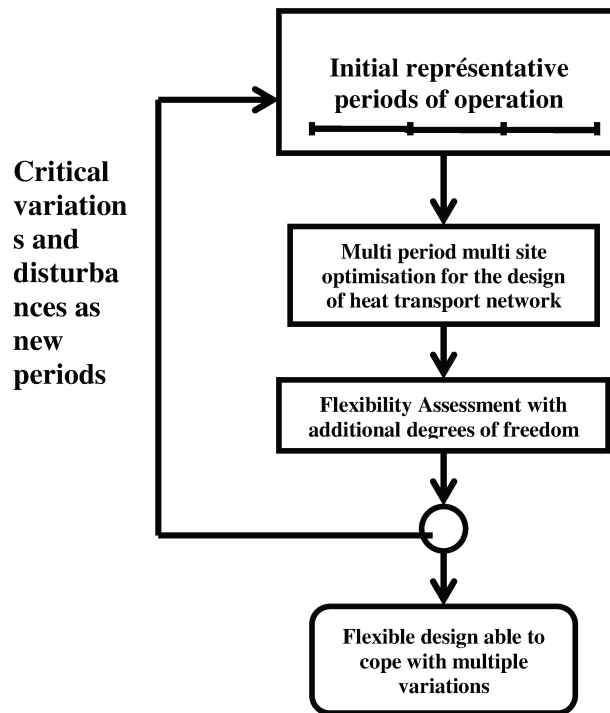

Figure 18: Methodology proposed for flexible heat transport network design

The first step aims to find optimal network solution for a set of initial scenarios that are taken into account using the multi-period approach. The developed model is detailed in chapter 2; the latter is a MILP optimization problem multi-period multi-plant indirect heat integration using intermediate transport fluid (liquid or steam) that optimizes the temperatures of the network and the configuration of the heat exchangers installed between the selected streams and the network to establish the heat exchange and it also investigates the hydraulic aspects which include the piping network to be installed between the plants by taking into account the geographical placement of the processes.

Then in a second step, the synergy network designed using the multi-period approach is proven by modeling its operability against an additional number of randomly generated variations. This step allows the flexibility assessment using an NLP optimization model that tests the ability of the obtained configuration, the utility systems and the equipment, to cope with variable scenarios and the exploration of the effect of variation of individual units on the total site. Moreover, the structure is extended with the addition of several degrees of freedom as structural or operational alternatives to ensure feasible operation. The additional challenge in this step is to be able to manage the two scales, the process level and the eco-park scale, to evaluate the consequences of the fluctuations of the two scales on the entire eco-park.

The iterative methodology proposed is a master piece in the design procedure which will use the information about the flexibility envelope to add critical conditions to a multi period design phase in a sequential way in order to obtain the optimal flexible design able to cope with several type of variations encountered in the operating conditions of the whole eco industrial park.



## 1.8 Conclusion

The general context as well as the state of the art of heat integration methods and flexibility assessment approaches are presented in this chapter. The main objective of the thesis is to propose a systematic methodology for designing flexible energy synergy networks established between multiple processes geographically close, subjected to fluctuations and variability's in the operating parameters in order to have a complete synthesis of energy synergy network that is therefore operable in all encountered risks and conditions in order to have high energy efficiency especially at the site wide scale.

The literature review presented in this chapter is the base used to propose a methodology whose two components will be presented in following chapters. First, the multi-period approach for the synthesis of a site wide heat exchange network that takes into account the geographical and hydraulic aspects is implemented in order to take into account during the design the predictable change in the operating conditions of the system. This step will be detailed in the second chapter of this manuscript. Then a model allowing an evaluation of the flexibility is developed in the face of probable fluctuations and a specification of control criteria by identifying the necessary degrees of freedom to guarantee robustness of the operation of the heat transport network. This step will be presented in the third chapter. The mathematical formulation of each model is detailed, and their applicability is demonstrated using two case studies for each model. The results will be presented and discussed for each case study. Finally in the last chapter of the manuscript, the whole methodology and the iterative procedure proposed is illustrated by a case study of an industrial park.

# **Chapter 2: Multi-period side wide heat integration solution in eco-industrial parks**

## **2.1 Introduction**

In the first chapter a methodology of two steps was presented as solution for designing flexible energy synergy networks of side wide heat integration solutions in eco-industrial parks, the first step will be the subject of this chapter; the objective is to design a heat transport network between multiple processes that is able to operate in several encountered variations in operating conditions by adopting the multi period approach.

A mixed integer linear programming MILP model is detailed in this chapter. The model's outcome is an optimal configuration of the tertiary heat recovery network with specification of its type (steam or liquid), temperature and capacity that can operate in a series of different set of operating parameters. Moreover, the model provides detailed solution on the selection of heat exchangers areas to establish the exchange between process streams and the selected network. Furthermore, the developed model investigates hydraulic aspects in order to determine the pumping power needed and to cover the installation of pipes between the plants by taking into account the geographical placement of the processes. The model optimizes an economical objective function composed of network investment costs and utility operation costs.

The multi-period methodology is tested on two literature case studies of virtual eco-industrial parks. The model investigates the technical and economic feasibility of the installation of a tertiary networks subjected to different sets of variations of operating conditions such as temperatures and flow rates.

## **2.2 Problem Statement and methodology**

As detailed in chapter one, at first, process heat integration strategies have been developed extensively as they bring solutions to industrial energy efficiency problems with methods for heat recovery by connecting hot and cold streams of a process thus achieving a reduction in the net energy consumption at a single process scale. Several methods have been reported to solve the problem of the synthesis of heat exchanger network (HEN) for an optimal selection of the matches for heat exchange between hot and cold streams of the process in order to reduce the overall external heating and cooling utilities.

Lately, further developments have focused on exploring energy collaboration between closely located industrial sites thus forming an eco-industrial park. In fact, heat recovery between multiple processes can offer higher energetic and economic efficiency improvements since it increases dramatically the number of heat exchange possibilities

All the previously mentioned methods in the literature review both thermodynamic and mathematical programming approaches were useful for establishing energy targets for the heat recovery thus a minimum heating and cooling utilities for the total site. However, it must be

extended to take into account the heat exchangers areas and thus the associated capital costs particularly for indirect heat exchange using intermediate recovery loops that requires the installation of two heat exchangers one at the site source and the other at the site sink. In addition, the pipeline required for the heat transport and the connections between the processes and the utility system have to be included in developed methods. Therefore, a more realistic evaluation of the tradeoff between the energetic gain of heat recovery and the investment costs can be achieved.

On the other hand, it is worth stating that the methodologies that use fixed operating conditions to design a configuration of the heat transport network are only functional under nominal parameters of the processes characteristics. Nevertheless, deviations of operating conditions such as supply and target temperatures and flow rates from nominal values are an everyday reality; consequently, including this aspect of variability at the design phase is fundamental in order to suggest a design of heat transport network that is able to operate effectively in all encountered operating conditions. To address this issue and complete the existing methodologies, the multi period approach is adopted to represent the variations of the operating conditions.

Therefore, the aim of this work is to develop a simultaneous model for a more complete synthesis of the heat transport network between multiple processes feasible for each period with minimum total annual cost consisting of utility cost, heat exchanger cost, piping cost and pumping cost. In particular, the following issues are to be addressed and to be considered during the development of the model:

- Different set of variations in the operating conditions are considered using the multi period approach.
- The temperatures of the transport networks are the key variables to be optimized
- A superstructure of the heat exchangers installed between the selected streams and the heating network to establish the exchange.
- Hydraulic aspects that include the pipe network to be installed between the plants by taking into account the geographical placement of the processes. This extension is important because it can represent more realistic tradeoff between the capital cost and the energetic gain since the length of the pipeline has a significant impact on the capital cost.

Mathematical optimization approach based on a mixed integer linear programming (MILP) model is developed because it represents the complex problem in a systematic way by decomposing it into a set of equations and by including specific features in the objective function to be optimized. These equations describe the system's operation, constraints and limits to which the variables are subjected to. Although, the equations are not all linear, the choice of a linear programming formulation guarantees a higher numerical robustness and a convergence of the solution. Therefore nonlinear problem's constraints must be linearized which increases the difficulty in the problem formulation. The equations of the model are

written in the Gnu Mathematic Programming Language (GMPL) language, CPLEX is used as solver for this optimization problem.

## 2.3 Mathematical Formulation

The proposed strategy aims to solve a MILP optimization model for multi-period multi-plant indirect heat integration using intermediate transport networks whose mathematical formulations is presented in this section.

The eco industrial park consists of a number of processes (*groups*) where each individual process ( $m \in \text{groups}$ ) own a set of hot process streams and cold process streams ( $o \in \text{streams}_m$ ) to be cooled or heated from its supply temperature  $T_{in,o}$  to its target temperature  $T_{out,o}$ , the streams are also characterized by a heat capacity flow rate (CP) and a minimum temperature difference  $\Delta T_{min}$  for the heat exchange between the streams within each process. Each period ( $p \in P$ ) has its own set of streams characteristics in order to represent the variability of these parameters using the multi period approach. It is noted that in the chosen approach multi process heat integration implementation is focused on without taking into account the full integration of the plants.

First of all, a global unique temperature scale in decreasing order is built using shifted input and target temperatures of hot (equations 2.1) and cold streams of each process (equations 2.2) to assume that all streams can take part in the internal heat exchange of the process and all streams have the ability to exchange with a certain tertiary network. The N different temperatures obtained are sorted in descending order to get N-1 intervals of the scale.

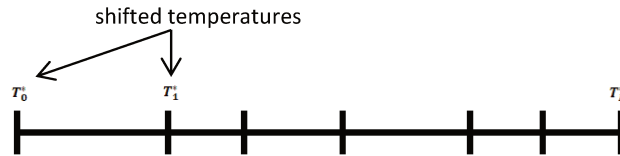

Figure 19: Initial temperature scale

For hot streams

$$\begin{aligned} T_{in}^* &= T_{in} - \frac{\Delta T_{min}}{2} \\ T_{out}^* &= T_{out} - \frac{\Delta T_{min}}{2} \end{aligned} \quad (2.1)$$

For cold streams

$$\begin{aligned} T_{in}^* &= T_{in} + \frac{\Delta T_{min}}{2} \\ T_{out}^* &= T_{out} + \frac{\Delta T_{min}}{2} \end{aligned} \quad (2.2)$$

It should be noted that the network temperature is a variable to be optimized and different constraints, such as energy balance or heat exchanger surface calculation, are nonlinear with regard to temperature. In order to keep the model linear, it is necessary to create a set of

predefined values from which the network temperature can be chosen. To obtain this set of values, sub-divisions is introduced between two consecutives temperature of the initial scale (Figure 19) so that the temperature interval becomes smaller than a step  $\Delta T$  fixed by the user (see Figure 20). With smaller  $\Delta T$ , higher accuracy of the model can be attained, but the calculation time becomes longer.

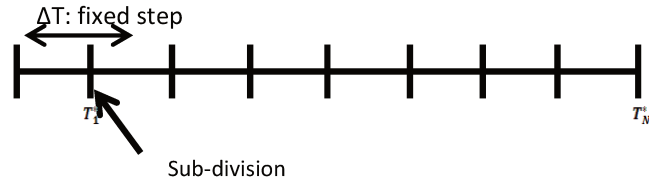

**Figure 20: Final temperature scale**

Heat integration between plants is considered indirect through the installation of at least one network to extract the excess heat from a plant called source and deliver it to the sink plant with heat deficit using intermediate fluids such as steam, hot water or oil. At high temperatures, steam is widely used for the transfer of latent heat at a fixed temperature. At lower temperatures, heat exchange can be done using liquids for the transfer of sensible heat and more energy recovery can be accomplished. In our model, both types of networks (steam and liquid) are considered and the deciding factor between the two options is process characteristics that point towards the more suitable solution.

Each network is characterized by its temperature(s) that is variable to be optimized by the model; the liquid networks have an upper ( $Tu_{net}$ ) and lower temperature ( $Tl_{net}$ ) therefore, the combination of two temperatures from the original temperature range is used to define the possible operating temperatures; whereas for steam networks those values are assumed identical ( $T_{net}$ ) by considering only the latent heat exchange and similarly the definition of the possible operating temperatures are deduced from the temperature set used previously to build the temperature scale.

Yet, for a realistic exchange between the streams and the intermediate networks, a minimum temperature difference  $\Delta T_{net}$  between the operating temperatures of any process' stream and those of the network is required twice, once at the plant which provides heat to the network and the other is at the plant which gains heat from the network. For any possible combination of heat exchange between a specific network's temperature ( $net \in networks$ ) and a specific temperature interval ( $n \in N - 1$ ) of process stream equations (2.3) and (2.4) must be respected when heat is supplied from the network to the stream, when a network withdraws heat from a plant at an interval ( $n$ ) equations (2.5) and (2.6) must be respected.

Liquid network

$$Tu_{net} \geq T_n + \Delta T_{net}$$

$$Tl_{net} \geq T_{n+1} + \Delta T_{net}$$

$$T_n \geq Tu_{net} + \Delta T_{net}$$

$$T_{n+1} \geq Tl_{net} + \Delta T_{net}$$

Steam network

$$T_{net} \geq T_n + \Delta T_{net} \quad (2.3)$$

$$T_{net} \geq T_{n+1} + \Delta T_{net} \quad (2.4)$$

$$T_n \geq T_{net} + \Delta T_{net} \quad (2.5)$$

$$T_{n+1} \geq T_{net} + \Delta T_{net} \quad (2.6)$$

The intermediate fluid can exchange heat with all the cold streams in sink plant or all the hot streams in source plant, thus heat exchanger networks superstructure is needed also to be optimized. In other hand, transferring and recovering heat requires heat exchangers of reasonable size. To be able to calculate the area of the exchangers and to keep the model linear, a pre-calculation of the logarithmic mean temperature difference LMTD is executed for all feasible heat exchange options; the latter includes all heat exchange combinations between possible network installation net and all possible temperature intervals  $nn$  and  $ns$  of each stream (o). Equation (2.7) and (2.8) represents the calculation of LMTD in case of a cold/hot stream exchanging heat between two temperature intervals ( $nn$  and  $ns$ ) with a liquid network (7) and steam network (8).

$$lmtd_{p,net,m,nn,ns,o} \quad (2.7)$$

$$= (Tu_{net} - T_{p,m,nn,o}) - (Tl_{net} - T_{p,m,ns,o}) / \ln((Tu_{net} - T_{p,m,nn,o}) / (Tl_{net} - T_{p,m,ns,o}))$$

$$lmtd_{p,net,m,nn,ns,o} \quad (2.8)$$

$$= (T_{net} - T_{p,m,nn,o}) - (T_{net} - T_{p,m,ns,o}) / \ln((T_{net} - T_{p,m,nn,o}) / (T_{net} - T_{p,m,ns,o}))$$

$$(\forall p \in P, \forall m \in groups, \forall o \in streams_m, \forall net \in Networks, \forall nn, ns \in N - 1)$$

It should be noticed that the intervals  $nn, ns$  are bounded by the specific stream's inlet  $T_{in}$  and outlet temperatures  $T_{out}$

In addition, the model takes into consideration geographical aspects. The pre-planned geographical location of each process as well as the potential pipe routings allows defining a set of nodes  $NODES$  with a specification of the geographical coordinates of each one ( $X_{node}, Y_{node} / node \in NODES$ ). The user defines a set of possible paths ( $path \in PATHS$ ) that connects two nodes and each one can be characterized by its length ( $l_{path}$ ) that is pre calculated using nodes coordinates. The model will choose the best routing for the heat transport network. In addition, in each path an assumption of positive flow direction from node with lower index to the node with higher index of the path. Therefore, the sign of the variable representing heat flowing in a certain path  $qch_{path}$  denotes the flow direction of the flow in the specified path. Figure 21 shows three possible piping paths to link two processes A and B that are presented at node 1 and 2. These parameters will be used in hydraulic modeling of the piping system.

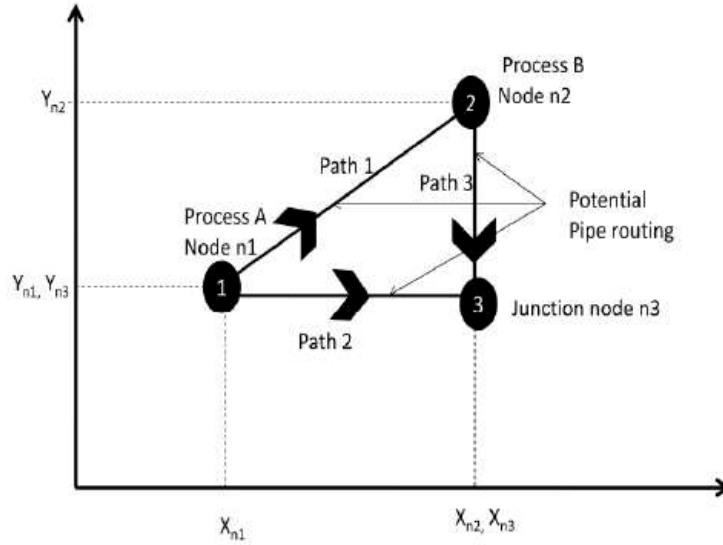

Figure 21: Geographical representation

### 2.3.1 Energy Balance in each temperature interval

As previously mentioned, heat integration within each plant  $m$  for each temperature interval  $n$  is assumed accomplished. Therefore, each interval  $n$  is represented by the sum of all the streams' enthalpies contributing at the specific interval  $q_{p,m,n}$  ( $\forall p \in P, \forall m \in groups, \forall n \in N - 1$  hot streams enthalpies are considered to be positive while those of cold streams are negative) that determine whether the interval has a surplus of heat or is in deficit depending on the sum's sign, thereby the resulting heat cascade and GCC areas can be exploited in order to analyze the possibilities for heat exchange with the network.

At first, to be able to study the different opportunities of installation of heat recovery networks on the temperature scale while satisfying the heating and cooling requirement of all streams of each process, an energy balance at each temperature interval of the scale is written for the components interacting at the defined interval: heat excess or requirement  $q_{p,m,n}$ , heat supplied ( $qp_n$  for liquid intermediate networks or  $qps_{p,m,n}$  for steam networks) or received ( $qnp_{p,m,n}$  for liquid intermediate networks or  $qsp_{p,m,n}$  for steam networks) from the network, the energy that remains is cascaded to lower temperatures, usually called the remainder, and is represented by  $r_{p,m,n}$  (equation 2.10). In each period for every plant, at the highest interval, hot local utility  $qs_{p,m}$  can be added to complement the heat demand (equation 2.9) and it is associated to each process independently to the network, also a cold utility  $qw_{p,m}$  at the lowest intervals can be included to close the energy balance and fulfil the cooling demands (equation 2.11). The cold utilities used to cool down the process can be an ambient source (e.g. air cooler or cooling water) or a refrigeration system when the stream to be cooled is colder than the ambience.

For  $n = 0$

$$qs_{p,m} + r_{p,m,n} = q_{p,m,n} + qp_n - qnp_{p,m,n} + qps_{p,m,n} \quad (2.9)$$

For  $n \in N - 1 / n \neq 0$  and  $n \neq N - 1$  :

$$r_{p,m,n} - r_{p,m,n-1} = q_{p,m,n} + qp_{p,m,n,net} - qnp_{p,m,n,net} - qsp_{p,m,n-1} + qps_{p,m,n} \quad (2.10)$$

For  $n = N - 1$

$$-r_{p,m,n-1} = q_{p,m,n} + qp_{p,m,n,net} - qnp_{p,m,n,net} - qsp_{p,m,n-1} + qps_{p,m,n} + qw_{p,m} \quad (2.11)$$

These equations are valid for  $\forall p \in P$  and  $m \in groups$

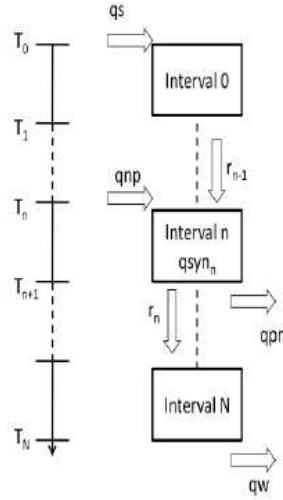

Figure 22: Energy balance at each interval

## 2.3.2 Heat exchange via network

The site wide heat integration performed between different processes is considered to be indirect via intermediate heat recovery networks that can be liquid or steam. In what follows, we present how to model these networks.

### 2.3.2.1 Liquid networks

The tertiary network installed between the plants to ensure the energy transfer does not store energy. Thus, the sum of the heat supplied from all plants to the network is equal to the sum of heat transferred from the network to all plants in each period.

$$\sum_{m \in groups, n \in N-1} qp_{p,m,n,net} = \sum_{m \in groups, n \in N-1} qnp_{p,m,n,net} \quad \forall p \in P, \forall net \in networks \quad (2.12)$$



All potential combination of networks within the defined research domain are examined by the solver, accordingly, the results will consist in a large number of networks with small capacities which is not realistic. To limit the number of networks, binary variables are introduced that will indicate their existence.

$$\sum_{m \in \text{groups}, n \in N-1} qpn_{p,m,n,net} - Qmax * \text{binarynetworks}_{p,net} \leq 0 \quad (2.1)$$

$$\forall p \in P, \forall net \in \text{networks} \quad (3)$$

where  $Qmax$  is a very high value, or the maximum heat transfer rate that a network is not allowed to exceed. We can observe that when  $qpn$  is not null (it means that there exists a network), then  $\text{binarynetworks}$  must be equal to 1.

The sum of all binary variables must be less than a maximum number of allowed networks to be installed fixed by the user  $Nbresmax$ ;

$$\sum_{net \in \text{networks}} \text{binarynetworks}_{p,net} \leq Nbresmax, \forall p \in P \quad (2.14)$$

In addition, the number of networks chosen by the model to be installed is the same in all periods and the can be done using the following equation:

$$\sum_{net \in \text{networks}} \text{binarynetworks}_{p,net} \leq \sum_{net \in \text{networks}} \text{binarynetworks}_{p+1,net}, \forall p \in P - 1 \quad (2.15)$$

With these additional constraints, only interesting installations will be defined while unlikely configurations are eliminated.

### 2.3.2.2 Steam networks

For a shared steam network, unlike the liquid recovery network, a potential centralized steam site utility  $qsteamutility_{p,n}$  is considered and may be used in order to provide the additional heat needed at each interval. The total heat needed to be delivered to the processes represents the capacity of the network of specific temperature  $qnetwork$  (equation 2.16)

$$\sum_{m \in \text{groups}} qsp_{p,m,n} = qnetwork_{p,n}, \forall p \in P, n \in N - 1 \quad (2.16)$$

The following equation (2.17) ensures that the heat delivered from a network is either supplied from the centralized utility or recovered from other processes.

$$q_{network_{p,n}} = q_{steamutility_{p,n}} + \sum_{m \in groups} q_{sp_{p,m,n}}, \forall p \in P, n \in N - 1 \quad (2.17)$$

Binary variable is also introduced to limit the number of steam networks and the capacity at each temperature interval using equation (2.18), (2.19) and (2.20).

$$q_{network_{p,n}} - Q_{max} * binarynetworks_{p,n} \leq 0, \forall p \in P, n \in N - 1 \quad (2.18)$$

$$\sum_{net \in N-1} binarynetworks_{p,n} \leq Nb_{resmax}, \forall p \in P \quad (2.19)$$

$$\sum_{net \in N-1} binarynetworks_{p,n} \leq \sum_{net \in N-1} binarynetworks_{p+1,n}, \forall p \in P - 1 \quad (2.20)$$

### 2.3.3 Economic cost of utilities

At first, the costs involved in heat transport network are divided between operating costs that are cumulated over a time period and capital or investment costs. In other words, investment costs and operating cost are expressed in different time scale. Thus, in order to present all costs on the same scale, an actualisation factor is multiplied to the operating cost.

$$actu = \sum_{y=1}^{integration\ period} (1 + taux)^{-y} \quad (2.21)$$

where *taux* is the interest rate.

The operational cost of utilities used to satisfy the heating demand is one component of the objective function to be minimized and it is calculated using equation 2.22 where *NbOpHours* is the number of operating hours per year and *lp<sub>p</sub>* is the ratio of the duration of the period p to the sum of the duration of all periods

$$costutilities = \sum_{p \in P, m \in groups} q_{s_m} * costutility * actu * NbOpHours * lp_p \quad (2.22)$$

$$+ \sum_{p \in P, m \in groups, n \in N-1} q_{steamutility_{p,n}} * coststeamutility_n * actu * NbOpHours * lp_p$$

The *coststeamutility<sub>n</sub>* can vary according to the temperature of the steam and is calculated using this equation:  $coststeamutility_n = \frac{0.2}{1500} * T_n - 0.01, \forall n \in N - 1$

## 2.3.4 Heat exchangers modelling and cost

### 2.3.4.1 Heat exchangers modelling

Each hot and cold stream (o) of all processes can be part of the heat exchange with the networks; the heat exchanged with each network could take place on the intervals of the temperature scale of each individual stream (o) that respect the thermodynamic criteria of positive temperature difference with the network temperature. The sum of the potential heat exchange in all the streams belonging to the same plant (represented in equation 2.23 and 2.24 using  $qpne$  and  $qnpe$  to characterize the exchange between a specific stream o at specific intervals) with a network net should be equal to the heat exchange between a network and a plant

$\forall p \in P, m \in groups, n \in N - 1, net \in networks$

$$\sum_{nn \in N-1, ns \in N-1, o \in streams_m, i \in I} qpne_{p,m,n,net,ns,nn,o,i} = qpn_{p,m,n,net}, \quad (2.23)$$

$$\sum_{nn \in N-1, ns \in N-1, o \in streams_m, i \in I} qnpe_{p,m,n,net,ns,nn,o,i} = qnp_{p,m,n,net}, \quad (2.24)$$

where ns and nn are the temperature's indices to determine the interval at which the stream exchanges heat as shown in figure 23.

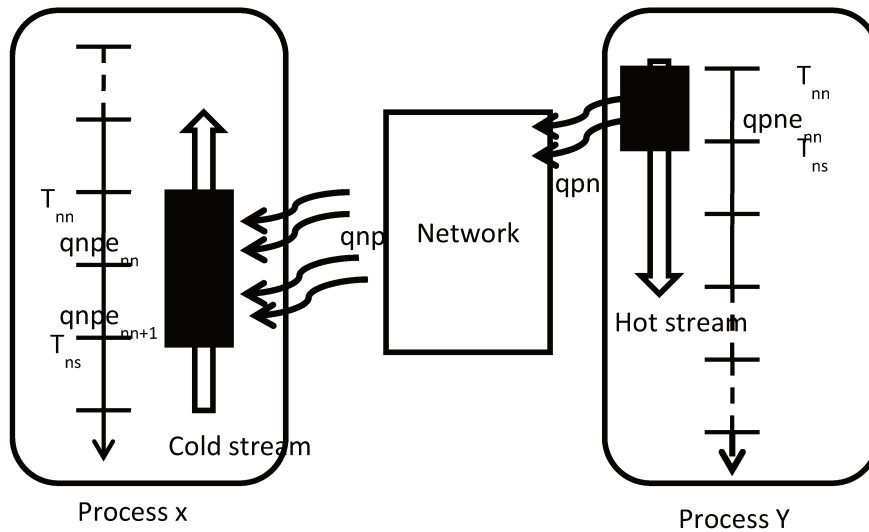

Figure 23: heat exchanger superstructure

It should be noticed that an additional index  $i$  is added to the variable  $qpne$  and  $qnpe$  which will be used in the calculation of the cost of the heat exchanger and explained in section 2.4.2. In another hand, equation 2.25 guarantees that the heat exchanged by a specific hot stream with the networks between two intervals is less than or equal to the heat surplus presented by this specific stream within these intervals. In fact, the contribution of a stream  $o$  that belong to a process  $m$  at each interval  $n$  ( $qo_{p,m,n,o}$ ) is pre calculated and is used in the equation 2.25 and 26. Similarly, the capacity supplied to a cold stream between two intervals is less than or equal to the heat deficit within these intervals (equation 2.26).

$$qpne_{p,m,n,net,ns,nn,o,i} \leq \sum_{d=nn}^{ns} qo_{p,m,d,o},$$

$$\forall p \in P, m \in \text{groups}, n \in N - 1, net \in \text{networks}, nn \in N - 1, ns \in N - 1, o \in \text{hotstreams}_m, i \in I \quad (2.25)$$

$$qnpe_{p,m,n,net,ns,nn,o,i} \leq - \sum_{d=nn}^{ns} qo_{p,m,d,o},$$

$$\forall p \in P, m \in \text{groups}, n \in N - 1, net \in \text{networks}, nn \in N - 1, ns \in N - 1, o \in \text{coldstreams}_m, i \in I \quad (2.26)$$

The following constraints (27, 28) ensure that heat will be supplied only to the streams' intervals above the pinch point; equally heat is withdrawn from streams' intervals below the pinch point of each process.

$$qpne_{p,m,n,net,ns,nn,o,i} = 0 \quad \text{when } ns > \text{pinch} + 1,$$

$$\forall p \in P, m \in \text{groups}, n \in N - 1, net \in \text{networks}, nn \in N - 1, ns \in N - 1, o \in \text{hotstreams}_m, i \in I \quad (2.27)$$

$$qnpe_{p,m,n,net,ns,nn,o,i} = 0 \quad \text{when } nn < \text{pinch},$$

$$\forall p \in P, m \in \text{groups}, n \in N - 1, net \in \text{networks}, nn \in N - 1, ns \in N - 1, o \in \text{coldstreams}_m, i \in I \quad (2.28)$$

where *pinch* represents the temperature interval index of the pinch point

Then the heat exchanger area  $A_{pne}$  that delivers heat to the networks or  $A_{npe}$  that receives heat from the network from a defined stream between two specific intervals is calculated using the pre calculated *lmtd* and  $U$  the overall heat transfer coefficient, fixed by user.

$$A_{pne_{p,m,n,net,ns,nn,o,i}} = \frac{qpne_{p,m,n,net,ns,nn,o,i}}{U * lmtd_{p,m,res,ns,nn}}, \quad (2.29)$$

$$\forall p \in P, m \in \text{groups}, n \in N - 1, net \in \text{networks}, nn \in N - 1, ns \in N - 1, o \in \text{hotstreams}_m, i \in I$$

$$A_{npe_{p,m,n,net,ns,nn,o,i}} = \frac{qnpe_{p,m,n,net,ns,nn,o,i}}{U * lmtd_{p,m,res,ns,nn}}, \quad (2.30)$$

$$\forall p \in P, m \in \text{groups}, n \in N - 1, net \in \text{networks}, nn \in N - 1, ns \in N - 1, o \in \text{coldstreams}_m, i \in I$$

The formulation lead to a large number of possible temperature couples for all streams that can be included, especially if its number is high. However, the additional  $\Delta T_{net}$  required between the streams' and intermediate network to have realistic heat exchangers shifts the temperature of hot streams downwards and cold streams temperature upwards, which will reduce the range of possible heat exchange. Another way to decrease the computational time is by prioritizing combination with higher driving force that eventually need lesser area to accomplish the heat exchange. It is used when only one network is implemented for the heat recovery, thus to attain

a high temperature difference for example between a hot stream and a network, the highest interval for hot streams within the allowed domain is kept mainly. Eventually binary variables can be added to specify the number of heat exchangers that can be installed.

#### 2.3.4.2 Heat exchangers cost function

The investment cost of heat exchangers that is part of the CAPEX (capital expenses) is included in the objective function to minimize. In fact, mainly the cost of heat exchanger depends on its material and the type of the exchanger. The cost of a single heat exchanger with surface area A can be calculated using the following simple non linear equation 2.31

$$Cost_{exchangers} = a + b * A^c \quad (2.31)$$

where a,b,c are parameters that vary according to the material and technology. However to keep the linearity of the model, a piecewise linearized cost function is used and its general form:

$$Cost_{exchangers} = F_i + V_i * A \quad for \ A \in (A_i, A_{i+1}) \quad (2.32)$$

where  $F_i$  and  $V_i$  are parameters; and the index  $i$  represents the surface's interval to which the exchanger belongs to. The parameters F and V can be calculated via the spline interpolation technique over the original non-linear relation. Binary variables are added to identify a unique interval to which each calculated heat exchanger area belongs (equations (2.33-2.38)) where the sum of all binary variables for all intervals  $i$  is less or equal to one.

For hot streams:  $\forall p \in P, m \in groups, n \in N - 1, net \in networks, nn \in N - 1, ns \in N - 1, o \in hotstreams_m, i \in I$

$$A_{pne_{p,m,n,net,ns,nn,o,i}} \leq A_i * binary_{exchanger}_{pn_{p,m,n,net,ns,nn,o,i}} \quad (2.33)$$

$$A_{pne_{p,m,n,net,ns,nn,o,i}} \geq A_{i+1} * binary_{exchanger}_{pn_{p,m,n,net,ns,nn,o,i}} \quad (2.34)$$

$$\sum_i binary_{exchanger}_{pn_{p,m,n,net,ns,nn,o,i}} \leq 1 \quad (2.35)$$

For Cold streams:  $\forall p \in P, m \in groups, n \in N - 1, net \in networks, nn \in N - 1, ns \in N - 1, o \in coldstreams_m, i \in I$

$$A_{npe_{p,m,n,net,ns,nn,o,i}} \leq A_i * binary_{exchanger}_{np_{p,m,n,net,ns,nn,o,i}} \quad (2.36)$$

$$A_{npe_{p,m,n,net,ns,nn,o,i}} \geq A_{i+1} * binary_{exchanger}_{np_{p,m,n,net,ns,nn,o,i}} \quad (2.37)$$

$$\sum_i binary_{exchanger}_{np_{p,m,n,net,ns,nn,o,i}} \leq 1 \quad (2.38)$$

Figure 24 represents the discretized intervals for the surface of the heat exchanger and its corresponding coefficients for the calculation of the cost.

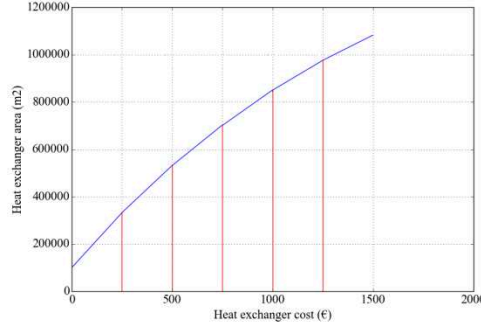

Figure 24: heat exchanger surface cost linearized function

On the other hand, the binary variables are multiplied to the fixed cost in order to prevent adding cost to the objective function and the final heat exchangers cost function written in the model is represented in equation 2.39.

$$\begin{aligned}
 & \text{costexchangers} \\
 &= \left( \frac{1}{P} \right) \\
 & * \left( \sum_{p \in P, m \in \text{groups}, net \in \text{networks}, nn \in N-1, ns \in N-1, o \in \text{streams}_m, i \in I} (A_{pne_{p,m,n,net,ns,o,i}} * V_i \right. \\
 & + \text{binaryexchanger}_{p,p,m,n,c,d,ns,nn,o,i} * F_i) \\
 & + \sum_{p \in P, m \in \text{groups}, net \in \text{networks}, nn \in N-1, ns \in N-1, o \in \text{streams}_m, i \in I} (A_{npe_{p,m,n,net,ns,o,i}} * V_i \\
 & \left. + \text{binaryexchanger}_{p,p,m,n,c,d,ns,nn,o,i} * F_i) \right)
 \end{aligned} \tag{2.39}$$

The equations described in this section correspond to the case with liquid heat recovery network. Yet a similar set of equations is written to model the heat exchange between the hot and cold process streams with the steam networks, to specify the heat exchangers superstructure and to estimate its costs.

## 2.3.5 Hydraulic Modeling

The indirect heat exchange between different plants requires piping networks. The model considers the available paths and the restriction flow on routes defined by the designer, determines the best pipe routing depending on the distances between plants within the eco-park and sizes the pipes needed in order to select an optimal heat recovery network operating over all the considered periods. The hydraulic equations include: heat balance at nodes, pressure equilibrium, calculation of velocity in pipes and its diameter.

### 2.3.5.1 Heat balance at nodes

As mentioned before, the geographical positioning of the plants and the potential pipe routing allows the determination of junctions and nodes where heat flows through the network. The connection between the nodes represents a piping path and is defined by two nodes. Equation

40 insures that at each node the energy balance is respected (no heat storage is considered): the sum of all the flows entering a node  $n$  should be equal to those leaving it; since each plant is modeled as a node heat supplied to a plant or withdrawn from the plant at a node  $n$  will be transferred to other nodes through the paths ( $qch_{path}$ ) connected to that node. In fact  $qch_{path}$  is given a positive sign for paths when the flow is entering the node  $n$  and a negative sign when the flow is leaving the node  $n$  and these conventional directions are predefined as mentioned in paragraph 2.

$$\sum_{paths \in PATHS} qch_{p,path,net} + \sum_{m \in groups, n \in N-1} qpn_{p,m,n,net} - \sum_{m \in groups, n \in N-1} qnp_{p,m,n,net} = 0, \quad (2.40)$$

$\forall p \in P, net \in networks, node \in NODES$

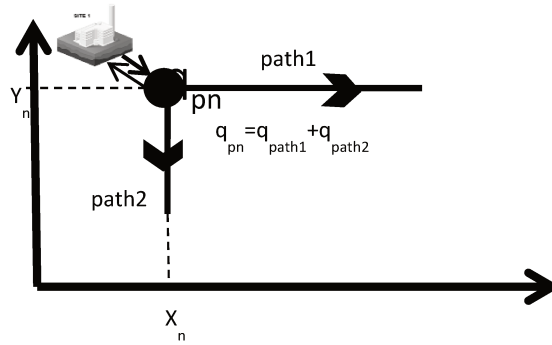

Figure 25: Example of a plant contribution at a node

### 2.3.5.2 Velocity and pipe diameter calculation

The sizing of pipes required for the indirect network installation between multiple plants depends on the mass flow rate of the fluid flowing through the defined paths. A larger diameter indicates a higher investment of pipeline. In addition, higher flow rate requires more power for transportation, resulting in a higher pump investment and power cost. Consequently, the dimensions of pipes of each potential installation are calculated and its costs are minimized in the objective function.

Firstly, the mass flow rate is calculated from the heat capacity in paths using equation:

$qch_{path} = \dot{m} * \Delta h$  where  $\Delta h$  is the enthalpy variation during heat transfer.  $\Delta h = c_p * \Delta T$  where  $c_p$  is the specific heat capacity and  $\Delta T$  is the network temperature difference for liquid networks and  $\Delta h$  is the latent heat for networks using steam. Then, the following equation is used to calculate the velocity and the diameter at each path.

$$\frac{qch_{p,path,net}}{\Delta h} = \rho * \sum_{z \in diam, v \in V} (Vp_{p,net,v,z,path} + Vn_{p,net,v,z,path}) * a_z, \quad (2.41)$$

$\forall p \in P, net \in networks, path \in PATHS$

$\rho$  is the density of the fluid flowing in a pipe characterized by  $a_z$  the cross-sectional area  $a_z = \pi * D_z^2 / 4$ . The model will choose one diameter for each path from a predefined set *diam*. In fact, the pipes to be used and installed have fixed diameter sizes  $D$  defined by the user and each diameter is characterized by its linear meter cost; hence the use of the index  $z$  for the diameter. Besides, a discretization method is established in the calculation of the velocity of the flow in pipes. Indeed, this method is required because of the linearization of the pressure drop equation as a function of the velocity. The proper limit of the velocity of fluid flowing in a path is divided on several consecutive intervals  $v$  characterized by an upper  $V1_v$  and lower bound  $V2_v$  values. Likewise  $qch_{p,path,net}$ , the velocity in a specific path can be positive ( $Vp$ ) or negative ( $Vn$ ), the model choose one velocity variable for each path which will determine the direction of the flow relatively to the one defined by the indexes of the path's nodes. Also, binary variables are used in equation (2.42, 2.43, 2.44, and 2.45) to determine the velocity interval and in equation 2.46 to ensure a selection of a unique couple velocity-diameter for each path for a specific period and network.

$\forall p \in P, net \in networks, v \in V, z \in diam, path \in PATHS$

$$Vp_{p,net,v,z,path} \leq V1_v * binaryvp_{p,net,v,z,path} \quad (2.42)$$

$$Vp_{p,net,v,z,path} \geq V2_v * binaryvp_{p,net,v,z,path} \quad (2.43)$$

$$Vn_{p,net,v,z,path} \geq -V1_v * binaryvn_{p,net,v,z,path} \quad (2.44)$$

$$Vn_{p,net,v,z,path} \geq -V2_v * binaryvn_{p,net,v,z,path} \quad (2.45)$$

The sum of the corresponding binary variables for one path should be equal or less than one and hence the model chooses a specific interval and a single direction in a certain path for each period and network.

$$\sum_{v \in V, z \in diam} binaryvp_{p,net,v,z,path} + \sum_{v \in V, z \in diam} binaryvn_{p,net,v,z,path} \leq 1, \quad (2.46)$$

$\forall p \in P, net \in networks, path \in PATHS$

Two additional constraints are added for the excluded paths fixed by the user in the input parameters. This constraint sets the velocity binary to zero for all excluded paths.

$\forall p \in P, net \in networks, z \in diam, v \in V, path \in PATHS / path$  is excluded from the study

$$binaryvp_{p,net,v,z,path} = 0 \quad (2.47)$$

$$binaryvn_{p,net,v,z,path} = 0 \quad (2.48)$$

### 2.3.5.3 Economic cost of piping

The cost of pipes can be calculated using the equation 2.49 in which all binary variables associated to velocity of all paths are multiplied to path's length  $l$  and the linear cost of the picked diameter.



$$costpipes = \left(\frac{1}{P}\right) * \sum_{p \in P, net \in networks, v \in V, z \in diam, path \in PATHS} l_i \quad (2.49)$$

$$* (binaryvp_{p,net,v,z,path} + binaryvn_{p,net,v,z,path}) * price_z$$

### 2.3.5.4 Pressure drop and pumping power calculation for networks using liquid as heat transfer medium

- **Pressure drop**

To complete the hydraulic modeling, pressure drop calculations are added to the model. Pressure drop due to friction loss in a pipe (head loss) is calculated commonly using the non linear equation in 2.50.

$$H = f * \left(\frac{l * V^2}{D * 2 * g}\right) \quad (2.50)$$

Where: H head loss, f friction factor, l length, D inner diameter of pipe, V velocity, g gravitational acceleration.

Nevertheless, in this MILP model, pressure drop calculation is linearized in terms of velocity using a piecewise linearization approach so that to get a higher accuracy and the general form in replaced by equation 2.51. In fact, the *binaryvp* /*binaryvn* are multiplied to the constant of the linearized function so the pressure drop would set up to 0 when the velocity is null. Also both velocity variables *Vp* and *Vn* are used for each *path* only one of them is non zero.

$$H_{p,net,path} = f * \left(\frac{l}{2 * g}\right) * \sum_{z \text{ in diam}} \frac{1}{D_z} \quad (2.51)$$

$$* \sum_{z \in diam, v \in V} (A_v * Vp_{p,net,v,z,path} + B_v * binaryvp_{p,net,v,z,path} - A_v$$

$$* Vn_{p,net,v,z,i} + B_v * binaryvn_{p,net,v,z,path}), \forall p \in P, net$$

$$\in networks, path \in PATHS$$

In fact, linearization consists in finding the continuous linear function using curve fitting and thus the coefficients  $A_v$  and  $B_v$  for each velocity interval.

In addition, in network piping design, pressure drop equilibrium within loops should be considered. A closed loop is several paths of pipes that begins and ends at the same node. The user defines a set of loops *LOOPS* and their corresponding paths. The pressure drop between two nodes in the loop is the same whatever the paths that connect these nodes. When closing the loop, the Kirchhoff law allows to represent this pressure drop equilibrium and this is written in the model using equation 2.52 where *S* is used for sign convention.

$$\sum_{path \in LOOPS} H_{p,net,path} * S_{loop,path} = 0, \forall p \in P, net \in networks, loop \in LOOPS \quad (2.52)$$

However some potential paths are not included ( their binary is null) in the piping network which will lead to no flow thus a null pressure drop within a loop which will makes the Kirchhoff law not true. For this reason, each pipe is associated with a potential closed valve and this is interpreted by adding very large pressure losses coefficient  $H_s$  into the pressure losses equation which will lead to a virtual very small flow passing in such paths with null binaries.

$$H = (H_s + f) * \left(\frac{l}{D}\right) * \left(\frac{V^2}{2 * g}\right) \quad (2.53)$$

- **Pumping power**

The pumping power needed to perform heat transportation can also be calculated, using the pressure drop in pipes and the volumetric flow rate of liquid, the original form of the equation is presented in equation 2.54.

$$Pumping = f * \left(\frac{l * V^2}{D * 2 * g}\right) * V * A \quad (2.54)$$

In the model the previous equation is replaced by the linearized form represented in equation 2.55 to obtain the pumping power needed for each period

$$\begin{aligned} Pumping_{p,net,path} &= f * \left(\frac{l}{D * 2 * g}\right) * A \\ &* \sum_{z \in diam, v \in V} AA_v * V p_{p,net,v,z,path} + BB_v * binaryvp_{p,net,v,z,path} \\ &- (AA_v * V n_{p,net,v,z,path} - BB_v * binaryvn_{p,net,v,z,path}), \forall p \\ &\in P, net \in networks, path \in PATHS \end{aligned} \quad (2.55)$$

Where  $AA_v$  and  $BB_v$  represent the coefficients of linearization determined using a similar curve fitting approach of the previous paragraph. However, pumping cost is different from that of heat exchangers and pipes because it is part of the operational costs which are cumulated over time and is calculated using equation 2.56.

$$\begin{aligned} costpumping = costelecenergy &\sum_{p \in P, net \in networks, path \in PATHS} actu \\ &* NbOpHours * l_p * pumping_{p,net,path} \end{aligned} \quad (2.56)$$

- **Pressure drop calculation for networks using steam as heat transfer medium**

For the networks using steam the Unwin formula [58] presented in equation 2.57 is used to calculate the pressure losses.

$$dp = 0.6753106 * (\rho * V * A)^2 * l * \left( \frac{1 + \frac{91.4}{D}}{\rho} \right) / D^5 \quad (2.57)$$

$dp$  is the pressure drop in Pa,  $\rho$  is the fluid's density.

Since, the heat recovered or supplied can be affected by the saturation temperature change due to the pressure losses in steam networks the pressure and saturation temperature drop are considered to determine the heat transfer feasibility and the heat exchanger design.

Thereby, at each node, the pressure is calculated using equation

$$dp_{path} = P_{node1} - P_{node2}$$

To calculate the saturation temperature as a function of pressure, the thermodynamic properties of steam are used to create a piecewise linear function  $T_{node} = f(P_{node})$ .

### 2.3.6 Unique investment for heat exchangers and pipes in all periods

Despite periodic variations, an optimal network for heat recovery is chosen and that is feasible in all periods: the heat exchangers areas, the piping routes and their diameters are determined and cannot vary for each period. A set of equations is introduced in the model in order to consider the same exchangers areas to be installed for all periods. The sum of heat exchangers areas installed for a fixed group  $m$  at a specific steam  $o$  have the same values in all periods of operation. These constraints ensure that the topology of the network is the same for all periods, even if its working condition varies.

$$\begin{aligned} \forall p \in P, m \in groups, o \in hotstreams_m \\ \sum_{n, nn, ns \in N-1, net \in networks, i \in I} Apne_{p,m,n,net,ns,nn,o,i} \\ = \sum_{n, nn, ns \in N-1, net \in networks, i \in I} Apne_{p+1,m,n,net,ns,nn,o,i} \end{aligned} \quad (2.58)$$

$$\begin{aligned} \forall p \in P, m \in groups, o \in coldstreams_m \\ \sum_{n, nn, ns \in N-1, net \in networks, i \in I} Anpe_{p,m,n,net,ns,nn,o,i} \\ = \sum_{n, nn, ns \in N-1, net \in networks, i \in I} Anpe_{p+1,m,n,net,ns,nn,o,i} \end{aligned} \quad (2.59)$$

Similarly, the following equations are introduced so that the model chooses the same pipe routing in all periods.

$$\forall p \in P, z \in diam, path \in PATHS \\ \sum_{net \in networks, v \in V} binaryvp_{p,net,v,z,path} = \sum_{net \in networks, v \in V} binaryvp_{p+1,net,v,z,path} \quad (2.60)$$

$$\sum_{net \in networks, v \in V} binaryvn_{p,net,v,z,path} = \sum_{net \in networks, v \in V} binaryvn_{p+1,net,v,z,path} \quad (2.61)$$

### 2.3.7 Objective function

The purpose of this model is to determine a configuration of the heat recovery network operable for all the periods representing the varying operating conditions while minimizing the total cost that includes the heat exchangers to be installed, the networks pipes and the operating costs of the utilities needed to satisfy all process requirements. Total cost includes capital and operating cost expressed on the same time scale.

$$cost = cost_{pumping} + cost_{pipes} + cost_{exchangers} + cost_{utilities} \quad (2.62)$$

## 2.4 Case studies

The developed model described here before is applied to two case studies showing its capability for the design of heat recovery networks with both liquids and steam.

### 2.4.1 Liquid heat recovery network case study

The case study presented in this section involves three industrial processes. The purpose of this case study is, using the described model, to investigate the technical and economical feasibility of the installation of a tertiary heat recovery liquid network that is capable of operating under different operating conditions.

The studied processes are initially described in [59], the geographical positioning of the processes within the site is proposed in figure 26.

	Stream	T <sub>in</sub> (°C)	T <sub>out</sub> (°C)	CP (kW/°C)
Process A	H1	230	55	200
	H2	155	80	733,3
	C1	120	270	-296,8
	C2	70	150	-750
Process B	H1	240	200	800
	H2	230	70	187,5
	H3	150	60	444,4
	C1	50	210	-500
	C2	90	250	-312,5
Process C	H1	250	90	274
	H2	220	80	428,6
	C1	150	260	-390,9

Table 1: Streams' characteristics at nominal condition

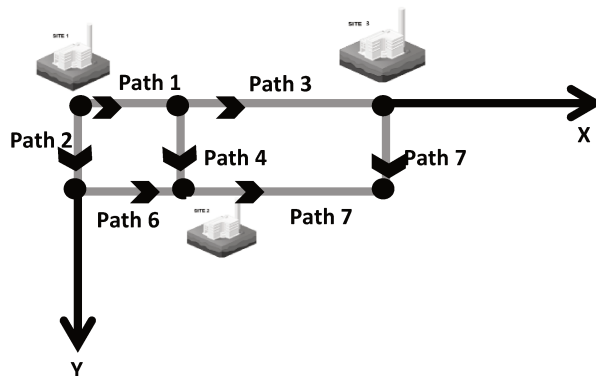

Figure 26: Geographical positioning of the processes

In the first step, the optimization was performed with one single period using the nominal parameters of the process streams (table 1). In addition, the maximum number of allowed networks is set to 1, the maximum and minimum allowed temperature of the network are set

170°C and 130°C respectively and the maximum and minimum network temperature difference are set to 30°C and 3°C. Economically, the operating cost integration period is 100 months and the actualization rate is assumed 0.3% monthly.

	Process A	Process B	Process C
Interaction with network(MW)	2.6	10.5	-13.1
Heat exchanger area installed (HXA)(m <sup>2</sup> )	133.7	373.8	472.9
Local hot utility(MW)	36.3	27.4	15.2

**Table 2: Results for nominal conditions**

It should be noticed that for the calculation of costs of pipes included in the objective function the data in table 3 representing the costs pipes according to their sizes and is used for the calculation of the cost of pipes is used.

Diameter (m)	Linear meter cost (€/m)
0.05	430
0.10	519
0.15	420
0.2	519
0.25	699
0.3	827
0.35	983
0.4	1200

**Table 3: Diameter size of pipes and its costs**

One liquid network is selected to recover heat from process C and supply it to process A and B; the hot water network temperatures are 155°C (supply) to 145°C (return). The area of each heat exchanger is determined and the detailed results are summarized in table 2. Hot utility is installed at each process to complement the heating demand.

In the second step, several variations in the operating conditions of the processes that may usually occur are introduced as periods in order to demonstrate the capability of the model to ensure an optimal design handling multi-period variations.

The variations include:

- An increase in heating demand of process A (increase in mass flow rate of cold stream C2) in second period (cases 1-4).
- Variations in process B (stream C1) are considered: an increase in heating needs (case 5) and a decrease in heat demand (case 6)

For the cases 1 to 4, the heat load variations of stream A-C2 are given in table 4.

Resolving the multi-period MILP, for cases 1 and 2, results in the same network temperatures as in the nominal case and the heat circulated in the network are the same at both periods in both cases. The results are detailed in Table 4 where CP of stream C2 is at nominal condition for the first period and 790 (kW/°C) and 850 (kW/°C) in the second period respectively in cases 1 and 2. Note that the two periods are of equal duration.

	Case 1		Case 2		Case 3		Case 4	
$lp_{p1} = lp_{p2} = 0.5$	P1	P2	P1	P2	P1	P2	P1	P2
Process A: C2 nominal CP=750 (kW/°C)	750	790	750	850	750	1050	750	1200

**Table 4: Description of variations in different cases**

	Case1			Case2		
	Process A	Process B	Process C	Process A	Process B	Process C
Interaction with network(kW)	2.6	10.5	13.1	2.8	10.3	13.1
Heat exchanger area installed(m <sup>2</sup> )	133	370.9	471.8	141.6	365	471.8
Local hot utility(kW) (period1)	36.3	27.4	15.2	36.3	27.4	15.2
Local hot utility(kW) (period2)	36.9	27.4	15.2	39.7	27.4	15.2

**Table 5: Network results for cases 1,2**

The small increase of the mass flow rate of C2 process A (case 1) is compensated by the local hot utility in the corresponding period, however a larger increase of the mass flow rate of the cold stream C2 (case 2) justifies an increase in the surface of the exchanger installed to recover more energy from the process C that is compensated by less heat provided to Process B.

	Case3						Case4					
	Process A		Process B		Process C		Process A		Process B		Process C	
	P1	P2	P1	P2	P1	P2	P1	P2	P1	P2	P1	P2
Q (MW)	5.4	10.2	7.8	9.5	13.1	19.7	6.7	13.4	6.4	7.2	13.1	20.6
A (m <sup>2</sup> )	272.6	272.6	395.8	395.8	858.6	858.6	343.6	343.6	279.1	279.1	858.6	858.6
HU (MW)	36.3	42.9	29.9	30.5	15.2	15.2	36.3	51.5	31.3	30.5	15.2	16.7

**Table 6: Network results for cases 3,4**

The results for a significant increase, in the second period, in mass flow rate of A-C2 (case3: CP = 1050 (kW/°C), Case4: CP=1200(kW/°C)) are presented in table 6. In fact, in these cases, the algorithm determines a larger exchanger for an increased heat recovery and adapts the working temperatures of the network for the first period 155° to 145° whereas for the second period the temperature of the network is 155° to 135°; since it is a liquid network a large temperature difference in a network allows the use of smaller pipes as it also allows higher energy recovery. Any other heat demand is provided by local boilers.

	Case5			Case6		
	Process A	Process B	Process C	Process A	Process B	Process C
Interaction with network(MW)	0	19.1	19.1	2.6	10.5	13.1
Heat exchanger area installed(m <sup>2</sup> )	0	735.4	735.4	133.6	370.8	471.8
Local hot utility(kW)	38.9	30.5	15.2	36.3	27.4	15.2
	38.9	38.5	15.2	39.7	19.9	15.2

**Table 7: Network results for case 5, 6**

Table 7 shows the results when variations in process B (stream C1) are considered where in case 5 there is an increase in heating needs while in case 6 there is a decrease in heat demand. Indeed, with an increase in heating demand of process B, the model will no longer consider heat supply for process A thus avoiding the cost of the installation of pipes. All the heat will be delivered to process B to cope with the heating demand increase in the second period. In case 6, the resulting configuration is identical to the one obtained in the nominal case.

## 2.4.2 Steam Case Study

The case study presented in this section involves two industrial processes presented in [54] . The purpose of this case study is, using the described model, to minimize the utility consumption by investigating the heat recovery opportunities across two individual process plants through a steam network and its utility that is capable of operating under different operating conditions. The nominal parameters of streams' characteristics of the processes are presented in table 8. All heat is supplied using recovery network or site utility networks and local hot utilities for each process are not allowed.

	Stream	T <sub>in</sub> (°C)	T <sub>out</sub> (°C)	CP (kW/°C)	$\Delta T_{min}$
Process 1	A1	200	100	20	20
	A2	150	60	40	20
	A3	50	120	-70	20
	A4	50	220	-15	20
Process 2	B1	200	50	3	10
	B2	240	100	1,5	10
	B3	200	119	23	10
	B4	30	200	-4	10
	B5	50	250	-2	10

**Table 8: Streams' characteristics**

The geographical positioning and all available and potential pipe routings of the processes are shown in figure 27 and table 9. Nodes 1 and 5 correspond to the location of processes 1 and 2 respectively. The other nodes represent connection of two or more pipes and could be the location of the network utility.

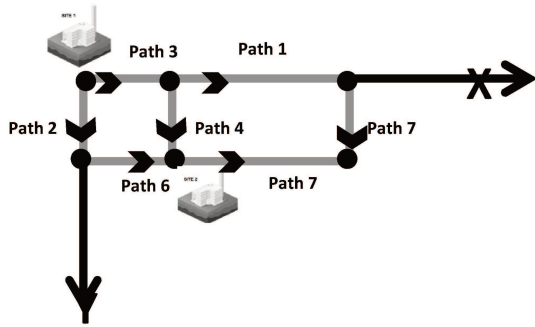

Nodes	Coordinates	X	Y	Process
1		0	0	A
2		500	0	
3		1500	0	
4		0	-500	
5		500	-500	B
6		1500	-500	

Table 9: geographical coordinates

Figure 27 : Geographical positioning of the processes

Three possible scenarios are considered in the case study for the placement of the site central utilities:

- Scenario 1: when all utilities are placed at node 1
- Scenario 2: when all utilities are placed at node 2
- Scenario 3: when all utilities are placed at node 3
- Scenario 4: when all utilities are placed at node 5

In the first step, the optimization was performed with one single period using the nominal parameters of the process streams (table 8). Economically, it is assumed that the operating cost integration period is 150 months and the actualization rate is 0.3% monthly. A maximum number of three steams networks is allowed. The maximum allowable saturation temperature drop in the network is set at 5 ° C. The costs of pipes are calculated according to their sizes using the same date of table 3.

The model is run for the 4 considered scenarios. The same result is obtained for scenario 1 and 3, in terms of network flow capacities, but the piping architecture is evidently not the same. The results for scenario 1 and 3 are shown in table 10 and for scenario 2, 4 in table 11; the tables summarizes the properties of each network and the interaction between the networks and the plants. Figure 28 and 29 represent the GCC of each process where heat received is shown in red while heat withdrawn is shown in blue. The same networks temperatures are found for the 4 scenarios, however the load distribution over the three steam networks varies allowing to optimize the piping needed.

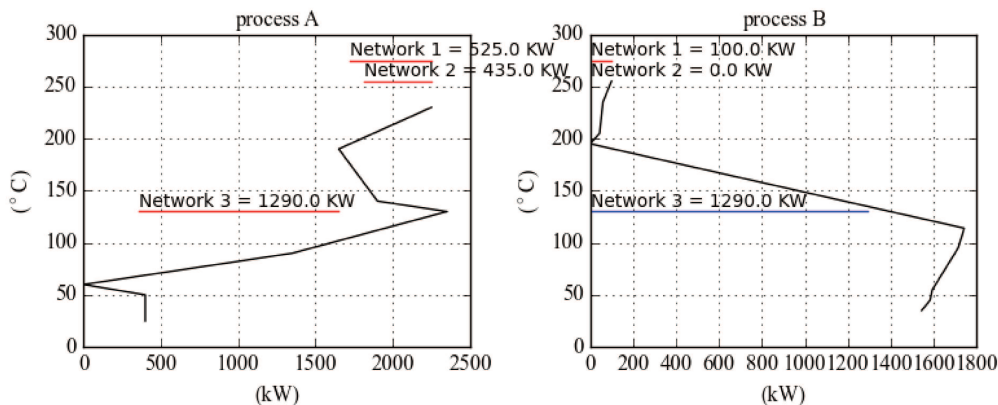

Figure 28 : GCC scenario 1,3



Capacity(kW)	Network 1 275°C	Network 2 255°C	Network 3 130°C
Process1	525	435	1290
Process2	100	0	-1290
Network utility	625	435	0

**Table 10 : Results for nominal conditions scenario1,3**

Capacity(kW)	Network 1 275°C	Network 2 255°C	Network 3 130°C
Process1	0	600	1650
Process2	100	0	-1290
Utility capacity	100	600	360

**Table 11 : Results for nominal conditions scenario2,4**

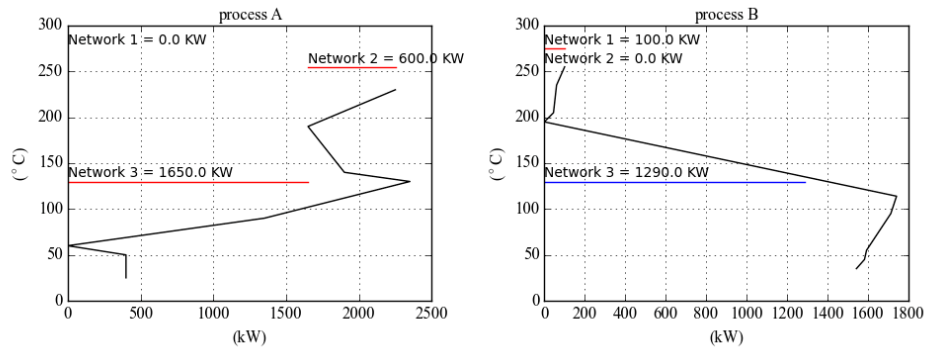

**Figure 29 : GCC Scenario2,4**

The following graph in figure 30 compares the cost of utilities, heat exchangers and piping needed for each scenario.

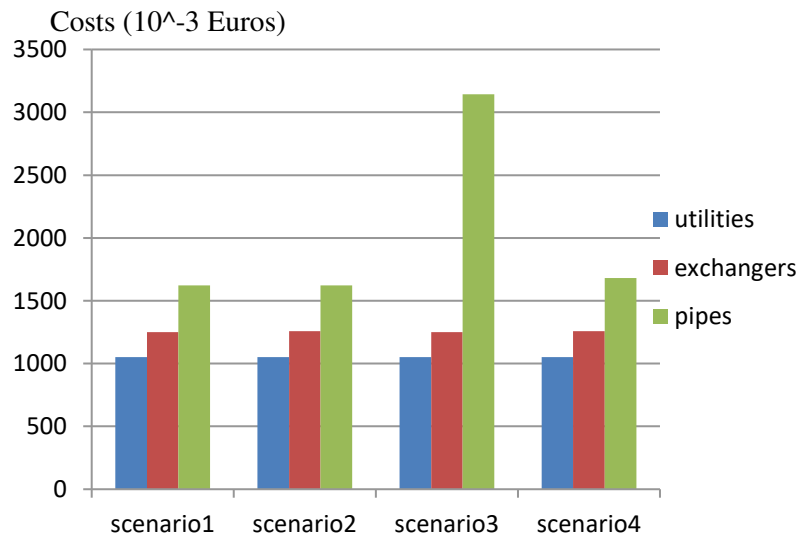

**Figure 30: Comparison of cost for the four scenarios**

With nominal operating parameters, for all four cases, the same need for utilities is identified since the heat recovery is the same and a single cost for heat is used (0.03euros/kWh). In scenario 2 and 4, higher costs of heat exchangers is noticed; in fact higher heat capacity (1650 kW) is delivered to process 1 from network 3 (1290 kW for scenario 1 and 3) that is supplied from process 3 and from a site utility thus the need of an additional heat exchanger and thereby

a higher cost. For scenario 1 a pipe system is needed to deliver heat from central utility (network 1) at node 1 to node 5. Similarly for scenario 2, equivalent routes are found since the location of the site utility is in the middle between the two processes (piping routes: between node (1, 2) and between (2,5)). In addition the same routing is chosen for the heat recovery of network 3 for both scenarios, thus the same cost of piping is noticed for scenario 1 and 2. On the other hand, in case 3 additional pipes are needed since the location of the site utilities is far from both processes.

### Equal periods duration case

In a second step, a decrease of 30% of the heat capacity flow rate of process 2 hot stream B2 is considered. Two periods of same duration (same weight) are used; the variations are included in the second period and nominal parameters are used in the first period.

The results show a different temperature of the second network for each period for scenario 1 and scenario 2 (figure 31), the level of the heat supply to processes for the first period is shown in red and in dashed green for the second period. The results are detailed in table 12 and 13. In fact, the amount of heat received by each process varies with the change of the temperature of the network and the temperature ranges of the streams included in the heat exchanger. On the other hand, an optimal choice of site utilities is proposed for each period especially to compensate the decrease of heat recovery from process B for the third network.

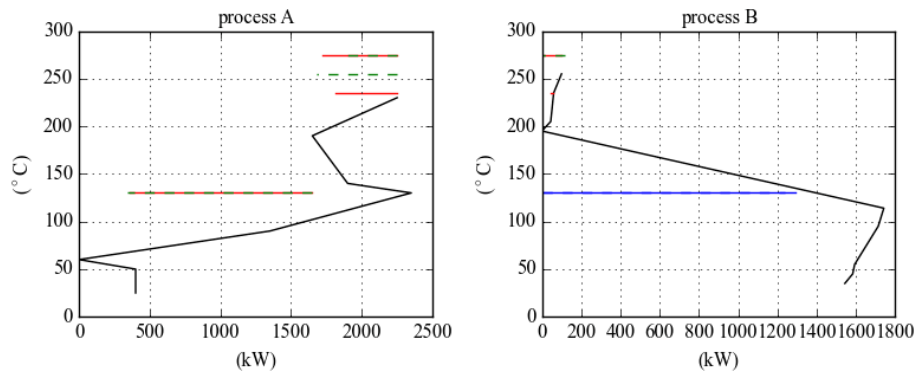

Figure 31 : GCC scenario 1,2,4

	Period 1			Period 2		
Capacity	Net 1	Net 2	Net 3	Net 1	Net 2	Net 3
kW	275°C	235°C	130°C	275°C	255°C	130°C
Pro1	525	435	1290	450	468.24	1331.75
Pro2	88.55	11.45	-1290	120	0	-1236.8
Utility	613.55	446.45	0	570	468.24	94.90

Table 12 : Network's characteristics and interaction with the processes for scenario 1

	Period 1			Period 2		
Capacity	Net 1	Net 2	Net 3	Net 1	Net 2	Net 3
kW	275°C	235°C	130°C	275°C	255°C	130°C
Pro1	564.9	322.73	1362.34	600	163.77	1486.22
Pro2	60.1	39.9	-1290	45	75	-1236.8
Utility	625	362.65	72.34	645	238.7	249.37

Table 13 : Network's characteristics and interaction with the processes for scenario 2,4

For scenario 3 (figure 32, table 14), the load is withdrawn from process B in both periods. This load (1260 kW) is slightly lower than the 1290 kW recovered when nominal parameters are used for the simulation due to the decrease of available heat in process B in the second period. Unlike scenario 1 and scenario 2 no utility is added for network 3 because site utilities will be

far which will result in higher investment costs for piping and heat exchanger installation (figure 33).

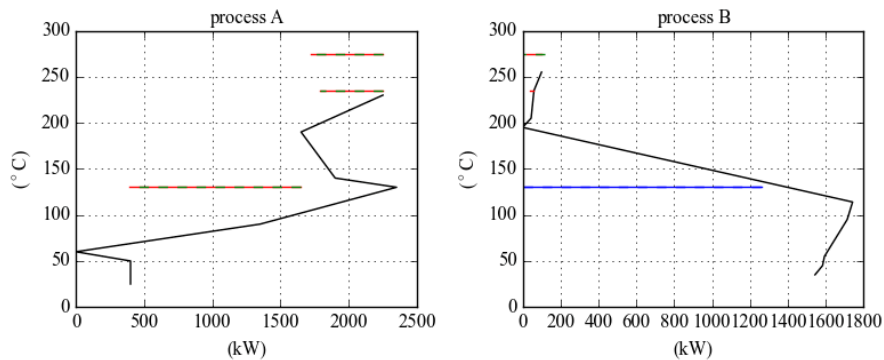

Figure 32 : GCC scenario 3

	Period 1			Period 2		
	Net 1 275°C	Net 2 235°C	Net 3 130°C	Net 1 275°C	Net 2 235°C	Net 3 130°C
Process1	525	465	1260	525	465	1260
Process2	79.12	20.88	-1260	120	0	-1260
Utility capacity	604.12	485.88	0	645	465	0

Table 14 : Network's characteristics and interaction with the processes for scenario 3

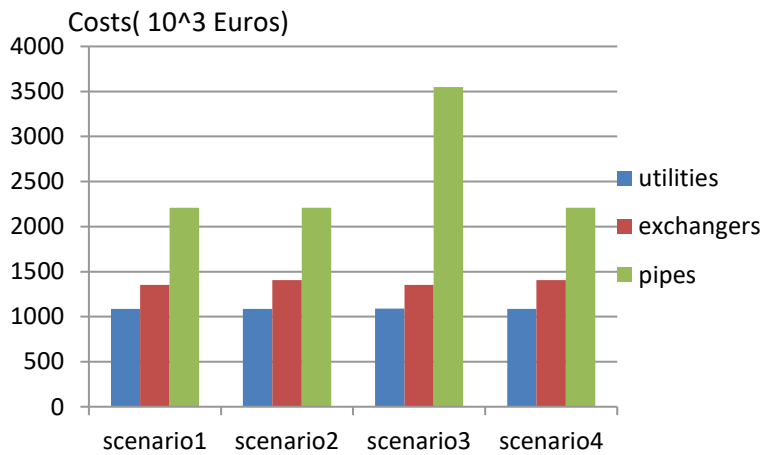

Figure 33: Comparison of cost for the three scenarios

### Unequal periods duration case

In this section, the two periods considered are not of same duration. We consider that the decrease of the heat capacity flow rate of process 2 hot stream B2 occurs only 10% of the time and in the 90% left nominal parameters are involved. For the same four scenarios of placement of central utilities the results are summarized in table 15 and 16 for scenarios 1, 2 and 4 and in table 17 for scenario 3.

Capacity kW	Period 1			Period 2		
	Net 1 275°C	Net 2 235°C	Net 3 130°C	Net 1 275°C	Net 2 255°C	Net 3 130°C
Pro1	525	435	1290	525	384.13	1340.86
Pro2	88.55	11.45	-1290	120	0	-1236.85
Utility capacity	613.55	446.45	0	645	384.13	104.01

**Table 15 : Network's characteristics and interaction with the processes for scenario 1**

Capacity kW	Period 1			Period 2		
	Net 1 275°C	Net 2 235°C	Net 3 130°C	Net 1 275°C	Net 2 255°C	Net 3 130°C
Pro1	564.9	362.18	1322.88	600	163.77	1486.22
Pro2	60.1	39.9	-1290	45	75	-1236.8
Utility capacity	625	402.11	32.88	645	238.7	249.37

**Table 16 :Network's characteristics and interaction with the processes for scenario 2,4**

Small differences are noticed between the two cases (equal and unequal periods), variations in the distributions of the heat on the three networks for the four scenarios. Just like the previous case, the temperature of the second network in the second period has changed in order to cope with the variation of the heat supply decrease. Figure 34 compares the operating costs between nominal, two periods of same duration and for the case where variations occur in a small time fraction. Utilities are added in the second period to compensate the inability of the process 2 to supply the same heat as in the nominal case, thus the increase in the operating cost and especially for the case of equal periods.

	Period 1			Period 2		
	Net 1 275°C	Net 2 235°C	Net 3 130°C	Net 1 275°C	Net 2 235°C	Net 3 130°C
Process1	525	465	1260	525	465	1260
Process2	88.54	11.45	-1260	120	0	-1260
Utility capacity	613.54	476.45	0	645	465	0

**Table 17 : Network's characteristics and interaction with the processes for scenario 3**

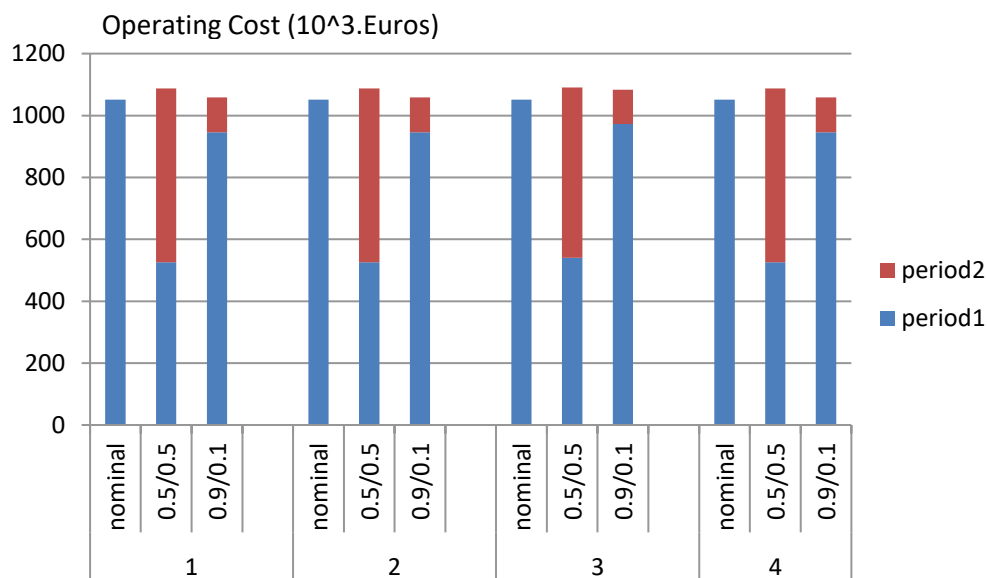

**Figure 34 : Comparison of operating cost in nominal and two cases of duration of the variation**

Duration of periods	nominal				0.5/0.5				0.9/0.1			
Scenarios	1	2	3	4	1	2	3	4	1	2	3	4
Total cost (10 <sup>3</sup> Euros)	3925	3933	5445	3989	4649	4704	5992	4704	4620	4675	5984	4675

**Table 18: Total cost for each case for each scenario**

Table 18 represents total cost in case of variations for each scenario. It should be noticed that even the variation for a small period of time (10%), implies higher cost compared to the nominal case.

## 2.5 Conclusions

The present chapter uses a mathematical optimization approach based on a MILP model for the synthesis of heat exchangers and transport networks between multiple processes. The multi period approach is adopted to consider the unavoidable variations of the operating conditions of the processes in the design procedure. An optimal configuration of the tertiary heat recovery network including details of the network, heat exchanger areas, piping system with best economic and energetic performance that can handle the variability's is obtained. The mathematical formulation that includes energetic, hydraulic and economical features is detailed. The model is tested on two literature case studies investigating the technical and economical feasibility of the heat recovery opportunities across multiple individual process plants through a steam network and a liquid network that is subjected to different sets of variations of operating conditions. The case studies compare configurations obtained with nominal parameters and configurations obtained with specific variations in operating conditions; it shows the effect resulted on the choice of network's temperature, on the interaction between the network and the processes, on the dimensions of heat exchangers and pipes and therefore on the costs involved.

This model represents the first step of the methodology that aim to find the flexible optimal heat transfer network. The main focus was on the demonstration of the capabilities of the model regardless of the overall methodology presented in Chapter 1 using two illustrative case studies from the literature (liquid and steam intermediate networks). In the following chapter the flexibility assessment model of the second step of the methodology is presented.

# **Chapter 3: A methodology for the flexibility assessment of side wide heat integration scenarios**

## **3.1 Introduction**

In the chapter one, a methodology of two steps was presented as a solution for flexibility assessment of side wide heat integration solutions in eco-industrial parks. The first step is the multi period optimization model that has been presented in the precedent chapter. The second step of the methodology presented will be the subject of this chapter. The objective is to assess the capability of a heat transfer network configuration at the total site scale to handle a range of varying operating conditions.

The mathematical formulation of the NLP optimization model is detailed in the following paragraphs. The configuration is considered flexible if the output (e.g. targeted temperature of streams) is within the desired ranges after coping with the input fluctuations. The proposed model considers the trade-off between the costs involved to put the energetic synergy into operation and the flexibility analysis. Also it allows the use of degrees of freedom, to overcome an infeasible operation and to increase the feasible region. The model is tested on two literature case studies of virtual eco-industrial parks: the first is a steam network and the second is a liquid network.

## **3.2 Problem Statement and methodology**

As shown earlier, on the process level, several tools are developed as a solution for the heat integration problem leading to the design of HEN considering economical and flexibility criteria. On the large scale of multiple processes, energy targeting tools were proposed as well as some extensions to consider limited practical issues. Nevertheless, neglecting the operability issues can lead towards non realistic solutions that deprive the design of its economic and energetic performance and can be complex to adjust. Consequently the flexibility of the design become an essential prerequisite of the heat transfer configuration and has to be integrated at the phase of the conceptual design. As mentioned in the first chapter, the aspects of flexibility at the side wide scale of heat integration methodologies between multiple plants in eco-industrial parks cannot be taken into consideration in one stage multi-period synthesis procedure (model presented in the precedent chapter) because the solution of the problem may quickly become a large problem. Hence, inspired by the works done on the HEN scale, the problem is divided into two steps. The first step aims to find optimal network solution for several periods with variable operating conditions then the second step allows the flexibility assessment and the ability of the obtained configuration, the utility systems and the equipment, to cope with variable scenarios and the exploration of the effect of variation of individual units on the total site. Moreover, the structure is extended with the addition of several degrees of freedom as structural or operational alternatives to ensure feasible operation. The information about the flexibility envelope will be analyzed in order to add critical conditions to the multi

period design phase in a sequential way. In this chapter, the main focus is to determine the feasibility envelope borders for the integrated solution obtained by using the model detailed in the next section.

### 3.3 Model formulation

The proposed strategy aims to solve a NLP optimization model to identify the capability of the heat exchange network configuration to handle fluctuations and to effectively operate in anticipation of a multitude variation of operating conditions. In other words, the ability of the system to remain operable against variations in input parameters with acceptable output operating ranges. The schematic representation of the real exchange network in which the processes are integrated locally (internal exchange between the process streams) and can exchange heat with tertiary networks established between the sites and with local hot or cold utilities is shown in figure 35.

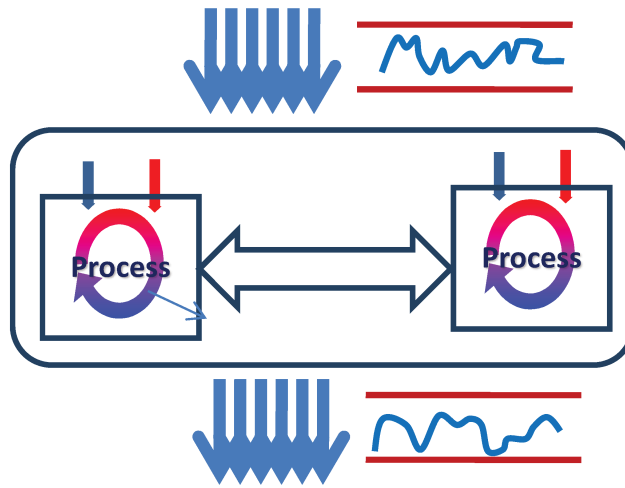

Figure 35: Representation of the heat transfer network

As mentioned before, the first step aims to find heat integration solution for multiple processes in which streams of each process are characterized by heat capacity flow rate ( $mcp$ ), inlet temperature ( $T_{in}$ ), outlet temperature ( $T_{out}$ ), heat transfer coefficient. Indices are  $i$  for hot process stream and  $j$  for cold process stream. The latter identifies indirect energy integration solution between multiple plants and optimizes the temperature and the type of the intermediate fluid and the capacity exchanged. Also it takes into account the investment costs taking into consideration the geographical coordinates of different sites. The heat exchange between the plants is indirect and established using steam or liquid network called a tertiary network. Thus the design obtained can be characterized by a number of heat transportation networks and its temperatures ( $N_{net}, T_{1,net}, T_{2,net}$ ), also the characteristics of individual or shared cold/hot utilities can be identified. Besides, in the generated heat exchange network configuration, it has the information on the location of every heat exchanger thereby each stream will be characterized by a number of nodes ( $Nodes_i, Nodes_j$ ) and branches ( $Nsplit_{i,k}, Nsplit_{j,k}$ ) on each node and type of connection (with a utility, process or network integration). These preset

parameters denote the existence of a heat exchanger on the hot/cold stream exchanging with another stream within the process or with a utility or with a site network respectively. Figure 36 shows the modeled system: the nodal division and the connection of the hot and cold process streams.

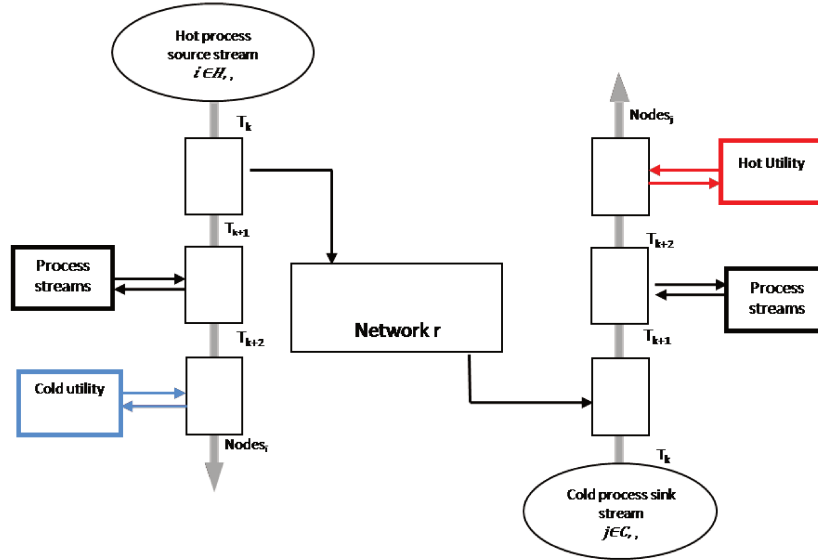

Figure 36: Model superstructure

### 3.3.1 Heat and mass balances

The model is based on a set of equality and inequality constraints stating heat balances and defining constraints on temperatures, heat exchanger's area etc.

The following set of equations represents, between two nodes, the heat balance defining the amount of heat received or rejected; the heat transfer area of each heat exchanger of the generated configuration is a defined parameter. Thus the heat load is also determined using equations (3.2) for hot and (3.4) for cold streams. These equations are required to determine the outlet temperature of each node. The slack positive variable  $a$  denotes the additional area required to guarantee a feasible operation to cope with fluctuations. For each variation, the violation of the heat exchanger area is minimized in the objective function by introducing it as a penalty. The overall heat transfer coefficient is calculated for each heat exchanger from the individual coefficients of the streams of the connection at each node.

Heat balance between  $k$  and  $k+1$  at each branch of hot streams:

$$Q_{i,k,b} = mcp_{i,k,b} * (T_{i,k,b,0} - T_{i,k,b,1}), \quad i \in HS, k \in Nodes_i, b \in Nsplit_{i,k} \quad (3.1)$$

$$Q_{i,k,b} = U_{i,k,b} * (A_{i,k,b} + a_{i,k,b}) * lmtd_{i,k,b}, \quad (3.2)$$

$$i \in HS, k \in Nodes_i, b \in Nsplit_{i,k}$$

For the cold sink stream, a similar set of equations is written:



$$Q_{j,k,b} = mcp_{j,k,b} * (T_{j,k,b,1} - T_{j,k-1,b,0}), \quad (3.3)$$

$$j \in CS, k \in Nodes_j, b \in Nsplit_{j,k}$$

$$Q_{j,k,b} = U_{i,k,b} * (A_{j,k,b} + a_{j,k,b}) * lmtd_{k,b,j}, \quad (3.4)$$

$$j \in CS, k \in Nodes_j, b \in Nsplit_{j,k}$$

The calculation of LMTD can lead to numerical difficulties. Therefore it is calculated using an approximation published by Chen 1987 [60] stated as:

$$lmtd_{i,k,b} = \left[ (T_{i,k,b,0} - T_2) * (T_{i,k,b,1} - T_1) * \frac{(T_{i,k,b,0} - T_2) + (T_{i,k,b,1} - T_1)}{2} \right]^{\frac{1}{3}} \quad (3.5)$$

$$lmtd_{j,k,b} = \left[ (T_2 - T_{j,k,b,1}) * (T_1 - T_{j,k,b,0}) * \frac{(T_2 - T_{j,k,b,1}) + (T_1 - T_{j,k,b,0})}{2} \right]^{\frac{1}{3}} \quad (3.6)$$

$T_2, T_1$  depend on the type of the connection (process stream, local or shared utility). In [61], the authors compare three approximations for the calculation of LMTD: the average LMTD, Paterson approximation [62], Chen [60] approximation. They show the accuracy of the different LMTD approximations and both approximation Chen and Paterson perform well.

The temperature at the first stage needs to be assigned by the inlet temperature of hot and cold streams.

Assignment of inlet temperature:

$$T_{i,1,b,0} = T_{in,i} \quad i \in HS, \quad k \in Nodes_i, b \in Nsplit_{i,k} \quad (3.7)$$

$$T_{j,1,b,0} = T_{in,j} \quad j \in CS, \quad k \in Nodes_j, b \in Nsplit_{j,k} \quad (3.8)$$

The next set of constraints imposes the condition that each stream receives the amount of heating or cooling that is required. These equalities specify that the heat content of each stream equal the sum of heat exchanged with other streams, utility or tertiary network.

Overall energy balance for hot streams:

$$mcp_i(T_{in,i} - T_{sout,i}) = \sum_k^{Nodes_i} \sum_b^{Nsplit_{k,i}} Q_{i,k,b}, \quad (3.9)$$

$$k \in Nodes_i, i \in HS, b \in Nsplit_{k,i}$$

Overall energy balance for cold streams:

$$mcp_j(T_{in,i} - T_{sout,j}) = \sum_k^{Nodes_j} \sum_b^{Nsplit_{k,j}} Q_{j,k,b}, \quad (3.10)$$

$$j \in CS, k \in Nodes_j, b \in Nsplit_{k,j}$$

In equations 3.9 and 3.10 the outlet temperature are defined as constant parameters. This can be relaxed and the targeted temperatures can be range-constrained. Thereby,  $T_{out,i}$ ,  $T_{out,j}$  can be replaced in the overall heat balance constraints with variables ( $T_{s_{out,i}}$ ) and by adding simple bounds, the maximum allowable temperature deviation  $D$  from the targeted outlet is defined. For any variation beyond, the network is considered infeasible. The variable  $Delta$  represents this deviation from the targeted outlet temperature.

$$Delta_{i/j} = abs(T_{out,i/j} - T_{s_{out,i/j}}) \quad (3.11)$$

$$Delta_{i/j} \leq D \quad (3.12)$$

To consider stream splitting, new variable is added: temperature at the end of the node where the mixing/splitting is taking place ( $T_{f_{i,k}}, T_{f_{j,k}}$ ). The sum of all flow rates of each branch is equal to the flow rate of the stream at each node.

They are subjected to new constraints:

$$\sum_{b=1}^{Nsplit_{k,i}} mcp_{i,k,b} = mcp_i, \quad \forall k \in Nodes_i \quad (3.13)$$

$$\sum_{b=1}^{Nsplit_{k,j}} mcp_{j,k,b} = mcp_j, \quad \forall k \in Nodes_j \quad (3.14)$$

The temperature at the node following the mixing is determined by the mixing heat balance equation:

$$\sum_{b=1}^{Nsplit_{k,i}} mcp_{i,k,b} * T_{i,k,b,1} = mcp_i * T_{f_{i,k}}, \quad \forall k \in Nodes_i \quad (3.15)$$

$$\sum_{b=1}^{Nsplit_{k,j}} mcp_{j,k,b} * T_{j,k,b,1} = mcp_j * T_{f_{j,k}}, \quad \forall k \in Nodes_j \quad (3.16)$$

For each stream, the temperature at node 0,  $T_{f_{i,0}}$ , corresponds to the inlet temperature. Also the temperature at the inlet of each exchanger  $T_{i,k,b,0}$ , of each branch  $b$  of stage  $k$  is equal to the temperature at the end of the stage  $k-1$   $T_{f_{i,k-1}}$ . Equation 3.17 and 3.18 are written for hot streams and similar set of equation is written for cold stream.

$$T_{f_{i,0}} = T_{in,i}, \quad i \in HS \quad (3.17)$$

$$T_{i,k,b,0} = T_{f_{i,k-1}}, \quad k \in Nodes_i, i \in HS, b \in Nsplit_{k,i} \quad (3.18)$$

New constraint is added if the hot/cold stream is connected to the heat recovery network the sum of the heat supplied to the sites from the network must be equal to the sum of the heat gained from the sites:

Heat balance of network:

$$\sum_{\substack{k \in \text{Nodes}_i \\ b \in \text{Nsplit}_{k,i}}} Q_{i,k,b} = \sum_{\substack{k \in \text{Nodes}_j \\ b \in \text{Nsplit}_{k,j}}} Q_{j,k,b}, \quad k, b \text{ connected to network} \quad (3.19)$$

### 3.3.2 Introduced degree of freedom

In the case of a well-defined architecture, it is essential to determine the degrees of freedom allowing the system to better tolerate various changes. Several constraints are added to incorporate the different possibilities of degrees of freedom or manipulated inputs: by pass of exchangers, local or territorial utility flow rates, utility temperature. In fact, the temperature and flow rates of utilities will become variables to identify using heat balance constraints and inequality bounds. For some severe variable conditions, a bypass may be needed to keep the feasible operation and target the outlet temperature.

Equations 3.13, 3.14, 3.15 and 3.16 are replaced with:

$$\sum_{b=1}^{Nsplit_{k,i}} mcp_{i,k,b} * T_{i,k,b,1} + (mcp_i - \sum_{b=1}^{Nsplit_{k,i}} mcp_{i,k,b}) * Tf_{i,k-1} = mcp_i * Tf_{i,k}, \quad (3.20)$$

$$\forall k \in \text{Nodes}_i$$

$$\sum_{b=1}^{Nsplit_{k,j}} mcp_{j,k,b} * T_{j,k,b,1} + (mcp_j - \sum_{b=1}^{Nsplit_{k,j}} mcp_{j,k,b}) * Tf_{j,k-1} = mcp_j * Tf_{j,k}, \quad \forall k \in \text{Nodes}_j \quad (3.21)$$

$$\sum_{b=1}^{Nsplit_{k,i}} mcp_{i,k,b} \leq mcp_i, \quad \forall k \in \text{Nodes}_i \quad (3.22)$$

$$\sum_{b=1}^{Nsplit_{k,j}} mcp_{j,k,b} \leq mcp_j, \quad \forall k \in \text{Nodes}_j \quad (3.23)$$

Upper and lower bounds constraints are added to the outlet temperature for the feasibility of the heat exchangers.

### 3.3.3 Objective function

The target is to determine if the design can cope with a set of disturbances and fluctuations and maintain the outlet temperatures using minimal increase in utilities. Hence, the objective

function of the NLP model minimizes the consumption of utilities. The technical feasibility of a configuration has to be guaranteed by the use of the heat exchangers as designed in the synthesis phase. In the mathematical formulation, the use of a numerical degree of freedom leading to an additional area for the heat exchangers,  $a$ , helps easing the resolution. A feasible configuration should not use additional areas to meet the heating or cooling requirement; therefore it has to be minimized also in the objective function. Hence, the penalty cost ( $P$ ) associated to additional heat exchangers area to satisfy the heating and cooling target in case of fluctuations and variations, is also added to the objective function to favor solution with no additional area.

$$\text{Min}(Q_{hu} + Q_{cu} + P * a) \quad (3.24)$$

## 3.4 Case studies

### 3.4.1 Case study using steam network

The purpose of this case study is, using the described model, to assess the flexibility of a fixed configuration of heat recovery network and test its ability to operate under different operating conditions. In the first step the optimal structure of the heat transfer network is determined using the model developed in chapter 2 then in a second step the structure's flexibility is evaluated with different scenarios varying the operational parameters using the described model. The main goal is to ensure the operability of the first stage's solution that can be achieved by adding several degrees of freedom to the structure to be able to cope with the disturbances. In this work, the optimization problem includes non linear constraints thus the model is coded using 'A Mathematical Programming Language' (AMPL) and uses baron, a non linear solver (NLP), to compute the optimal solution.

#### 3.4.1.1 Heat transfer network topology under nominal conditions

This case study involves three industrial processes. These processes were originally used by Chew and al [25] as a case study to apply the "plus minus principle" which identifies the benefits of certain process modifications in order to increase energy savings in the process within the concept of multi-site energy integration.

The stream data for the processes are listed in table 19.

At first, the optimal topology of the heat exchanger network of each process is identified using the algorithm proposed by Barbaro et al [14] implemented in the CERES platform . It should be noted that this synthesis step was performed with fixed input parameters.

Secondly the model developed in chapter 2 is used and the results of the multi-site energy integration are summarized in Table 20 for optimal conditions. Four steam networks at 300°C, 265°C, 180°C, 150°C are established. The amount of heat received by or supplied to the tertiary network by the processes at each network temperature is determined; Process C supplies 7779

kW to the network at 180°C and are recovered by process B and 9366kW to the network at 150° and recovered by process A.

	Stream	Tin (°C)	Tout (°C)	mass flow x Cp (kW/°C)
Process A	H1	230	55	200
	H2	155	80	733,3
	C1	120	270	-296,8
	C2	70	150	-750
Process B	H1	240	200	800
	H2	230	70	187,5
	H3	150	60	444,4
	C1	50	210	-500
	C2	90	250	-312,5
Process C	H1	250	90	274
	H2	220	80	428,6
	C1	150	260	-390,9

**Table 19 : Stream's characteristics**

Those results are obtained using one single period also implemented in the CERES platform based on economic objectives, the model identifies indirect heat integration solution between multiple plants and the results include specification for detailed operating conditions of each synergy network such as type (steam or liquid), operating temperature and capacity. Also the model investigates the economical, geographical and hydraulic aspects and takes into account the investment of pipeline and considers the geographical coordinates of different sites, cost of pumps and heat exchangers added for the connection with the networks.

Network/Process	A	B	C
1 (300°C) Capacity (kW)	17808	28357.6	15234
2(265°C) Capacity (kW)	11849	Not Connected	Not Connected
3(180°C) Capacity (kW)	8363.5	Not Connected	-7779.7
4(150°C) Capacity (kW)	Not Connected	9366	-9366

**Table 20 : Relation between process and tertiary networks**

Therefore, the 150°C steam network is a synergy network without being connected to a shared utility because the process C supplies 9366 kW which are totally recovered by the process. Whereas the 180°C steam network is in majority a synergy network but its duty is complemented by a shared utility. The high temperature networks (265, 300°C) are utility only steam network. Since the process A relies the most on the shared utility, it is localized in its vicinity.

Hence, the processes, that are locally integrated, are interconnected through the tertiary networks. This illustrates clearly the complexity of the energetic synergy of the whole configuration which cannot consist only of analyzing the flexibility of the shared utility. This

synthesis step is therefore extended with a flexibility assessment step to determine the ability of the structure to cope with disturbances by using the model presented in this chapter.

**3.4.1.2 Flexibility assessment**

The industrial park steam networks that are designed in the previous section have been designed based on the nominal operating conditions of the three processes. The two lowest temperature steam networks recover heat from process C and provide this heat to processes A and B. Therefore, the ability of process C to provide this heat while operating in potentially variable conditions is important to guarantee the success of the synergy. The flexibility assessment is therefore performed for random fluctuations of the three streams mass flow rates in process C. Two situations are considered:

- The process C is providing heat to the synergy networks but cannot rely on the other processes flexibility.
- The whole park flexibility is assessed.

**3.4.1.3 Heat exchanger network flexibility assessment of process C**

In this first situation, the process C is assumed submitted to random fluctuations in its three streams mass flow rate. The maximum acceptable deviation in temperature for the streams output is assumed to be 3 K. The reference of deviation in temperature is relative to the outlet temperature of streams of table 19.

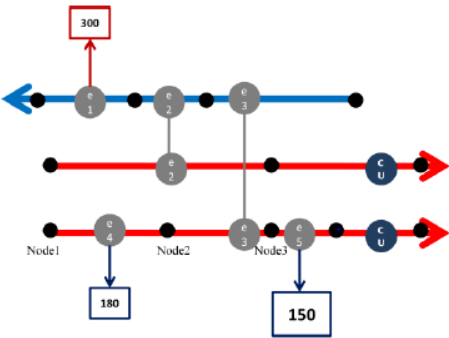

Figure 37: Connections of process C

Exchangers	Surface m <sup>2</sup>	Connection Type
e1	892.6	Net300/P
e2	5198.7	P/P
e3	545.4	P/P
e4	876	P/Net180
e5	1256.6	P/Net150
e6	740.5	P/CU
e7	1349	P/CU

Table 21 : Heat exchangers areas

The process C receives heat from the steam network at a temperature of 300 °C. Similarly, being part of the eco-park, it is the main supplier of heat for the 180 °C and 150 °C networks. In this first step, it is interesting to analyze the ability of this process to tolerate the fluctuations of its operating conditions while being able to supply heat to the network. Process C flows are designated H1 and H2 for hot flows and C1 for cold flow.

Figure 37 shows the different streams connections between the process streams and / or with the utilities/networks. The two hot streams H1 and H2 are connected to the stream C1 allowing preheating it while they are connected to the networks at 180°C and 150°C providing them with their excess heat. C1 is finally heated thanks to the shared utility/network at 300°C and H1 and

H2 are cooled using local cold utility. The connections and the size of the exchangers are detailed in table 21.

The problem is solved for several 80 randomly generated variations of heat capacity flow rates of process C streams (5% H1, 3% H2) using the described model. In this first case, the degrees of freedom allowed are the variation of the cold utility mass flow rate with a maximum limit of 3% while the hot utility capacity purchased from the 300°C steam network may be increased by a maximum limit of 1.7%. It is assumed that the delivered capacity should be respected for the networks at 150°C and 180°C.

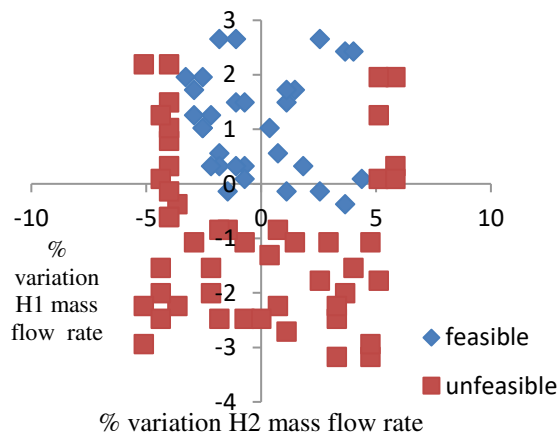

**Figure 38: Simulation results case 1 (C1 capacity flow rate 390 kJ/K)**

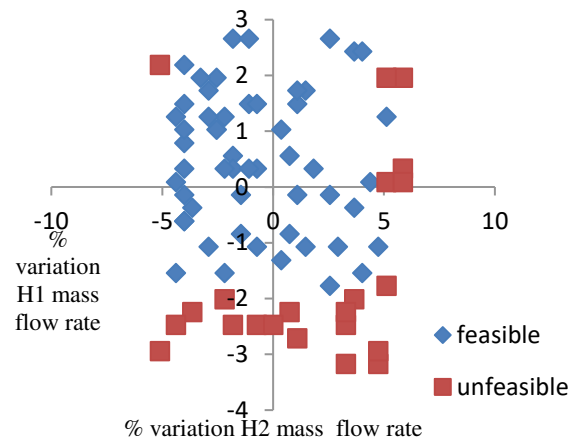

**Figure 39: Simulation Results case 2(C1 capacity flow rate 390 kJ/K)**

The feasibility envelope is limited as seen in figure 38 where red dots refers to unfeasible conditions and the blue dots for the feasible ones. In this case, the heat capacity flow rate of the stream C1 is at the nominal value 390.9 (kW/K), the configuration is unable to handle any decrease of H2 mass flow rate because H2 is the unique supplier of the two networks (at 180°C and 150°C).

In the second case, a relaxation is first assessed by adding a new degree of freedom: the temperature of the 3 networks. In this case, when the temperature of the network became a degree of freedom that can vary to cope with fluctuations, the number of variables of the model increased from 48 to 54 variables, and the number of iterations needed to find the best feasible solution also increases. The total Cpu time used depend on conditions of each simulation and vary from 1s to 15s on an office computer with an I7 intel processor.

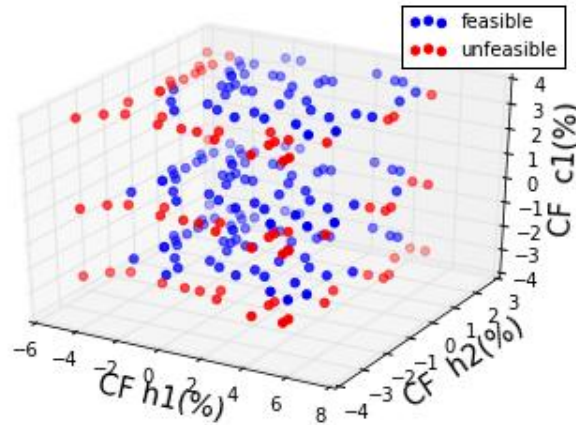

**Figure 40: Feasibility envelope of process C with the generated random variations (CF stands for heat capacity flow rate variation)**

Figure 39 shows the feasibility envelope when H1 and H2 capacity flow rate varies for the nominal capacity flow rate of stream C1. Compared to figure 38, it is clear that the added degree of freedom allows increasing significantly the feasibility envelope.

Also, when adding the network temperatures flexibility, figure 40 shows the feasibility envelope of process C in which the configuration remains operable and capable of supplying the heat necessary for the networks despite the simultaneous variations of the flow rates H1 and H2 and C1. The blue dots represent the feasible conditions while the red dots are infeasible.

The feasibility of the system is limited for a decrease of 2.5% in the flow of H2 because it is the unique supplier for the networks (at 180°C and 150°C). The process will be unable to deliver heat to the network despite all variations in all directions of the other streams. In addition, another feasibility limit is obtained when C1 mass flow rate increases (+2.3%); the additional need for heating will exceed the boundary set for the heat delivered by network at 300°C and it will deprive the process of its feasibility especially with a decrease of the hot H1 mass flow rate that exchanges heat with C1 through the exchanger e2 (the decrease limit is -4%). Moreover the system is not able to compensate the need for additional heating even when the heat capacity flow rates of H1, H2 increase (The increase limit is 2% for stream H2 and 6 % for stream H1). Thus, the process will no longer be able to supply heat to the networks and heat at high temperature purchased from the network will be insufficient, hence the infeasibility. The critical points of variations of the described limits that should be considered to expand the envelope of operation of the process can thus be deduced; it corresponds to points (+6,2,2.3), (-4,0,2.3) and (0,-2.5,0) that represents the percentage of variation of the flow rates of streams H1,H2,C1 respectively.

When the mass flow rate of the cold stream C1 decreases, consequently the demand for heating is acceptable, however the system will remain unfeasible with the decrease of H2 that feed the networks.

To solve this issue a bypass is proposed as a new degree of freedom on both sides of exchanger e3 between stream H2 and C1 (see figure 37). The same random variations are tested with the model described with two degrees of freedom (by pass of exchanger e3 and the cold utility capacity), and the results show (figure 41 and 42) that the process is now able to handle the limit decrease of H2 and to cope with the variations to deliver heat to the networks. The critical



points limiting the envelope are shown in fig 8 and the risky conditions are deduced: a simultaneous decrease in H1 of -5% and H2 of -2.2%.

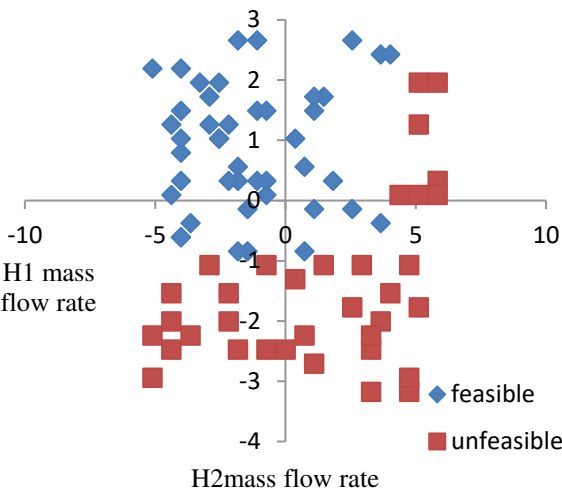

Figure 41: Simulation results without bypass (C1 capacity flow rate 380 kJ/K)

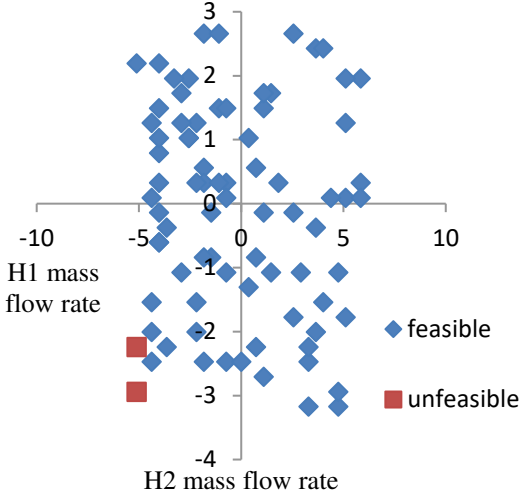

Figure 42: Simulation results with bypass (C1 capacity flow rate 380 kJ/K)

As shown in table 22, the process was not able to deliver the minimum 9300kW for the 180°C network without an additional area (43 m<sup>2</sup>). However when the partial bypass is allowed on between nodes 2 and 3 (exchanger e3 fig.3) the heat capacity flow rate crossing the exchanger decreases from 416(kW/K) to 346(kW/K) thus its heat load is reduced which will allow the next node to deliver sufficient capacity to the network without additional area. It should be noticed that in this case, the number of variables of the model has increased to 53 variables when adding the bypass, also the CPU time and iterations needed to find an optimal solution has increased as well. For the example detailed in table 21, the CPU time needed to solve the model is 70s and the number of iterations reported is 26251 iterations.

	With by pass			Without by pass		
	heat load(kW)	additional area(m <sup>2</sup> )	mcp(kW/K)	heat load	additional area(m <sup>2</sup> )	mcp(kW/K)
Nodes 1/2	7714	0	416	7714	0	416
Nodes 2/3	5644	0	346	5962	0	416
Nodes 3/4	9300	0	416	9300	43	416

Table 22: Variation of heat load on the nodes of the second stream

In this section, an evaluation of the effects of different flow variations of the three streams, their influence on the operation of the process and an identification of the weak points of the process C are carried out. This evaluation shows that the integrated process in the eco-park has a very small margin of flexibility if it cannot modulate these interactions with the networks. In summary, the operability of process C is limited by an increase of mass flow rate of C1 because it is lying on a tertiary network which leads to higher operating cost and a decrease of H1 and H2. A bypass can be added to avoid infeasibilities when the flow rate of C1 decreases. The

network temperatures have been shown to increase the process flexibility but this degree of freedom has to be studied on the site level.

### 3.4.1.4 Park synergy flexibility assessment

The first situation considering only the process C showed a small operable envelope. Subsequently, the analysis of the different fluctuations is carried out but analyzing this time the possibility of relying on the flexibility of other processes and degrees of freedom of the shared utilities to extend its area of flexibility.

In this case, the whole park is considered in the simulations while tolerating the manipulation of the shared utility capacity and the networks steam temperature adaptation and mass flow rate.

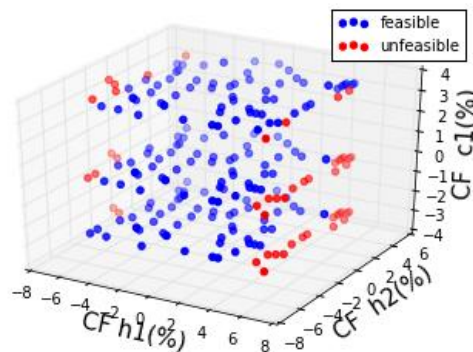

Figure 43: Feasibility of process C within the eco-park(CF stands for heat capacity flow rate variation)

Compared to figure 40, it is clear in figure 43 that the degrees of freedom offered by the whole park and the variation of the network temperatures and their corresponding flow rates expanded the operating envelope of the process C. The process can now tolerate a decrease of 6% in H1 with an increase of 3.6% of flow rate of C1. The decrease of the heat flow rate of H2 of 6% is tolerable when the temperature of the network can be manipulated.

Percentage of variation of flow rates of streams (H1;H2;C1)	Total utility load(kW)	Temperature net 1(°C)	Temperature net 2(°C)	Temperature net 3(°C)	Temperature net 4(°C)
Nominal	73744	300	265	180	150
-5.47%,-3.8%,-2.8%	76306	298	279	186	150
-2.2%;-5.7%;-2.8%	78337	300	265	190	150
-4.74%;-5.5%;-2.8%	77761	298	287	189	150

Table 23: Total utility load and networks temperatures for selected feasible conditions

Table 23 shows for the simultaneous reduction in mass flow rates of C1, H1 and H2 how the shared utility load and the 4 networks temperatures are manipulated to ensure the feasibility. Indeed, the simultaneous decrease in the mass flow rates of H1 and H2, which are preheating C1 while H2 is providing both networks 3 and 4 with heat, lead to globally increase the shared

utility load. The analysis of the networks temperature change is interesting since it shows that the more H<sub>2</sub> mass flow rate is reduced the higher the temperature of network 3 is. Indeed, by doing this, H<sub>2</sub> contributes less to this network which is also connected to the shared utility while keeping its contribution to the network 4 which is a synergy only network. This heat load transfer from one network to another allows the flexibility of the park.

### 3.4.2 Case study using liquid intermediate network

This case study aims to demonstrate the applicability of the described NLP model in order to assess the flexibility of a fixed structure of a liquid heat recovery network between two processes and its ability to operate under different conditions. At first, the model detailed in chapter two is used with one single period that uses nominal parameters of the operating conditions of the processes so that to determine the configuration of the tertiary network, and then in a second step the structure's flexibility is evaluated with different scenarios varying the operational parameters using the NLP model. Several degrees of freedom are added to the structure in order to cope with the considered variations.

#### 3.4.2.1 Data of the case study

An example based on a heat integration project in South China [63] is used to illustrate the model presented in the previous paragraphs of this chapter. Two plants are presented in the eco-park and are denoted as Process 1 (aromatic) the source plant and Process 2 (butadiene) the sink plant as shown in table 24 where the characteristics of the used streams of the processes are detailed. It should be noticed that the HENs within the individual processes are assumed established and the streams presented in table 24 are the ones that are connected to utilities.

	Stream	T <sub>in</sub> (°C)	T <sub>out</sub> (°C)	CP (kW/°C)	U(W.m <sup>-2</sup> .°C <sup>-1</sup> )
aromatic	1	116	45	57.8	642
	2	121	48	50.2	451
	3	142	55	36.5	354
	4	155	58	31.3	311
	5	165	60	30.4	431
butadiene	6	80	135	-65.4	518
	7	61	140	-60.2	331
	8	55	150	-50.6	308
	9	53	165	-51.1	301

Table 24: Streams' data for the processes

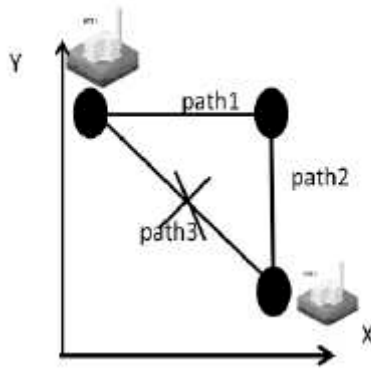

Figure 44: Geographic data

The design model of chapter two is simulated using the nominal parameters of table 24. A simple geographical location of the two processes has been assumed as shown in figure 44. Path 3 is presumed forbidden; an additional node is inserted so the network used paths 1 and 2 for the piping network to establish the exchange between the processes. The heat recovery structure using an intermediate fluid is thus determined from the developed model of chapter 2 that minimizes the economic objective function including the running costs of utilities, investment costs of heat exchangers, pipes and pumps. It allows the identification the optimal solution for the energy integration solution across the two processes. It determines the amount of heat recovered from one process to other, the temperatures of the network, the flow rates that contribute into the heat transfer, the area of each heat exchanger needed at each process connected to the network or to the utilities and the corresponding heat loads. The results clearly indicate the advantage of installing an energy symbiosis between the plants. The available local utilities are steam (hot utility) with a temperature of  $200^{\circ}\text{C}$  at process 2 and cold water (cold utility) with an inlet temperature of  $30^{\circ}\text{C}$ . The liquid network temperatures obtained are  $106^{\circ}\text{C}$  to  $76^{\circ}\text{C}$ . Figure 45 represents the GCC of each process where heat received is shown in red while heat withdrawn is shown in blue.

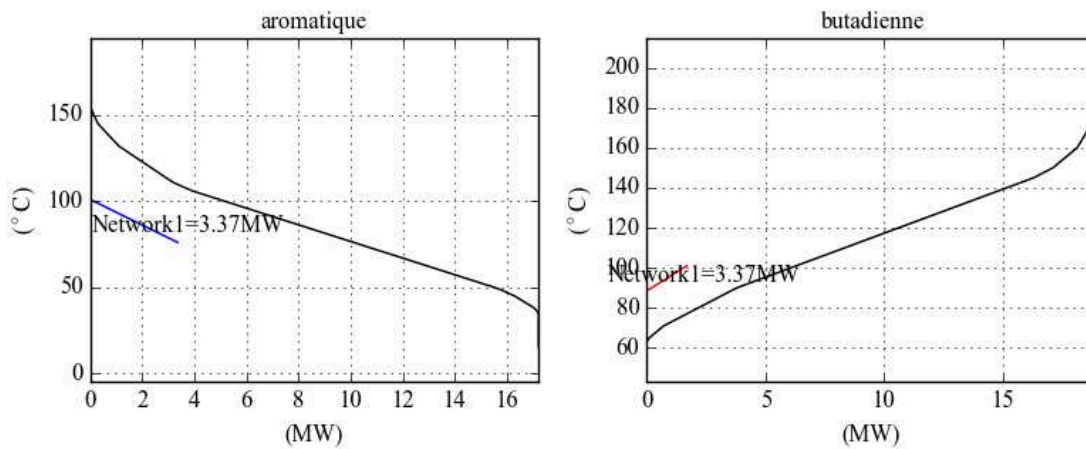

Figure 45: GCC for nominal parameters

The following tables details the structure of the heat transfer and specifically the heat exchangers installed at the streams that participate to the heat recovery. Streams 8 and 9 of process 2 withdraw heat in parallel from the intermediate network while streams 4 and 2 of process 1 supply heat to the network. It should be noticed that the rest of heating and cooling requirement are compensated by the local utilities. Two heat exchangers are installed at each stream one connected to the network and the other to the local utilities as shown in figure 46. The heat exchangers areas and the corresponding heat loads are summarized in tables 25 and 26.

Butadienne	Stream 8	Stream 9
Heat exchanger with network (m <sup>2</sup> )	233	528
Heat exchanger with local hot utility(m <sup>2</sup> )	189	247
Interaction with network(kW)	1278	2087
Interaction with local hot utility(kW)	3529	3648

**Table 25: Structure of the streams of process 2 withdrawn from the network**

Aromatic	Stream 4	Stream 2
Heat exchanger with network(m <sup>2</sup> )	337	234
Heat exchanger with cold utility(m <sup>2</sup> )	97.3	212
Interaction with network(kW)	2104	1261
Interaction with local cold utility(kW)	941	2409

**Table 26: Structure of the streams of process 2 withdrawn from the network**

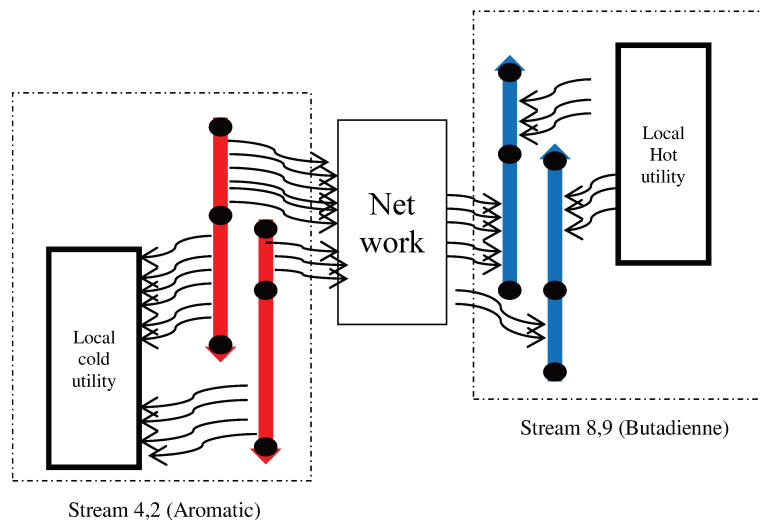

**Figure 46: Schematic representation**

### 3.4.2.2 Flexibility Assessment

As previously mentioned, the trade-off between costs and energy savings obtained in the previous paragraph is not sufficient for investments decisions; normally several changes in the capacity or the characteristic of industrial processes can occur and these fluctuations are unavoidable and can highly affect the economic and energetic optimality and can deprive the system of its efficiency. A flexibility assessment step is necessary in order to evaluate the operability of the designed configuration. The model detailed in the previous paragraphs is used

to establish flexibility assessment of the configuration obtained by the multi period design model. In this case study, several changes will be introduced as a scenario that includes variations in flow rates of the streams that participate to the exchange with the intermediate network. In the previous case study, the flexibility was assessed for variations occurring in only one process of the eco-park. In this case study, for a wider evaluation of the operability of the recovery intermediate network, simultaneous variations of the heat capacity flow rate CP in both of the processes are introduced. The latter follow a normal distribution with a mean value that corresponds to the nominal value (table 24) and standard deviation of 5 (kW/°C). It should be mentioned that to gain more flexibility the outlet temperature is allowed to be varied in a given range. The maximum allowable temperature deviation from the nominal outlet is 3°C. For any variation beyond, the network is considered infeasible. The model is solved for fifty variations of heat capacity flow rate of stream 4 of process 1 and stream 8 of process 2 and the results are shown in the following figures. The feasible scenarios are represented by blue dots and the unfeasible by red dots. In addition, degrees of freedom are added as operational alternatives to allow the fixed design configuration to tolerate fluctuations and remain operable in spite of the uncertainty that can occur.

The first figure (figure 47) shows the results of the feasibility envelope obtained when only one degree of freedom is considered: the upper and lower temperatures of the network. While the second figure (figure 48) the temperature of local utilities of the butadiene can also vary in order to cope with the variations. The third figure (figure 49) three degrees of freedom are introduced; the model determines the temperatures of the network and the temperatures of the local utilities of both of the processes. As remarked, the feasibility envelope with one degree of freedom is limited compared to the one when the temperature of the network and the local utilities can be manipulated and controlled. Also some supplementary scenarios became feasible when an additional degree of freedom related to the local utility of each process.

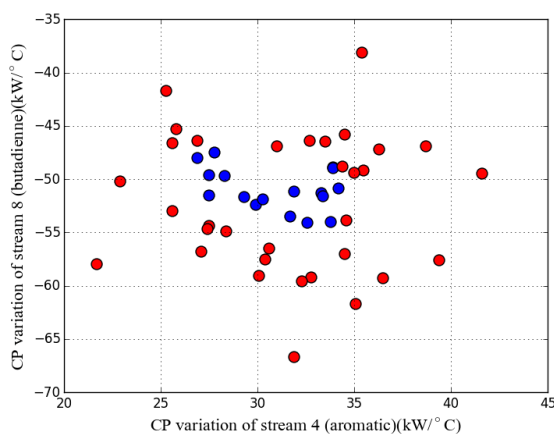

**Figure 47: Simulation results with one degree of freedom (network's temperature)**

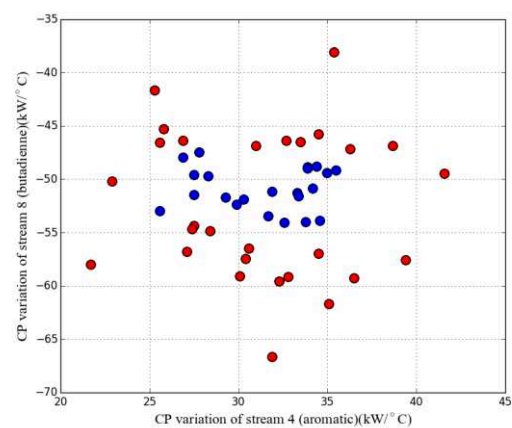

**Figure 48: Simulation results with two degrees of freedom (network's temperature and local cold utility of the source plant)**

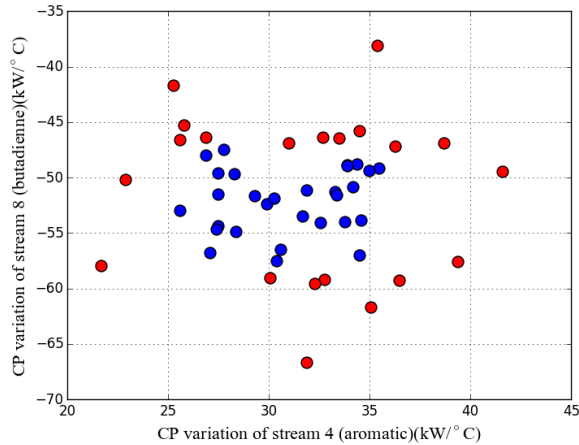

**Figure 49: Simulation results with three degrees of freedom (network's temperature and local temperature of the utilities)**

As shown in figure 47, the simultaneous variations have high impact on the operability of the network and can make the system non operable even if the temperature of the intermediate network is considered as variable that can be controlled. The feasibility envelope is limited for an increase of 5.6% of the heating requirement to be withdrawn from the network or in other words the increase in heat capacity flow rate of the sink stream 8, even with a simultaneous increase of the excess of heat in the source plant of 8.3% that will not sufficient. Also, as remarked in the figures, the network operability is limited with simultaneous decrease of heat capacity flow rate of the two streams (decrease of 6.7% for stream 4 and 17% for stream 8). In the following paragraph, the manipulation of the degrees of freedom involved: the temperatures of the network and the local utilities in order to ensure the feasibility is discussed for some extremes critical specific variations.

- CP stream 4: 27.1(kW/°C), CP stream 8: -56.8(kW/°C)

This critical disturbance corresponds to a decrease of 13.7% in heat availability of the main supplier to the network (source stream 4) and an increase of 12.3% of heat requirement of the sink stream 8. The fixed configuration as established by the design model is not able to cope with these opposite variations. At first, the model determines the upper and lower temperatures of the network: 96°C, 81°C allowing a decrease in dtlm on the heat exchanger connecting stream 4 to the network. In addition, the model will compensate this decrease of heat availability by an increase of the heat withdrawn from the second hot stream participating in the exchange with the network and determines 15 m<sup>2</sup> as additional area needed to be installed at stream 8 to heat it to its target temperature. That's why this variation is considered unfeasible and is represented by a red dot in figure 47. However with additional degree of freedom and the variation of local hot utility temperature, dtlm on the heat exchanger connecting cold streams to the local hot utility increases, thus the heat loads delivered by the utility increase to compensate the inability of the network to heat stream 8 and the disturbance become feasible (figure 49). The temperature of the utility optimized by the model is 206°C, and the recovered heat is 3107 kW.

- CP stream 4: 35.5(kW/°C), CP stream 8: 49.2 (kW/°C)

The increase in heat availability of 13% in the source plant along with a simultaneous decrease of 2.77% of the heat requirement restrict the operability of the recovery network configuration. The network tends to deliver more heat to stream 9 and lesser heat to be withdrawn from stream 2. However with only one control variable (temperatures of the network) the NLP model determines  $7\text{m}^2$  as additional area needed on the hot stream 4 connected to the cold utility in order to reach the targeted outlet temperature. Therefore, the increase of dtlm related to the heat exchangers connected to the cold utilities (process 1: stream 2 and stream 4) when the temperature of the cold utility can be manipulated by the model allows a higher heat exchange and consequently the red dot in figure 47 becomes feasible in figure 48. The heat recovered has though increased to 3457 kW.

- CP stream 4: 34.5 (kW/°C), CP stream 8: 57 (kW/°C)

This critical disturbance that corresponds to an increase of 9.6% of the heat availability of stream 4 and an increase of 12.6% of heat requirement of stream 8 requires the three operational alternatives in order to reach the targeted temperature of the streams of each process with the fixed areas established in the previous study. The variation of the temperature of the utilities allows an increase of the dtlm of the heat exchangers connected to utilities and thus higher heat exchange can be accomplished and the disturbance is thus feasible.

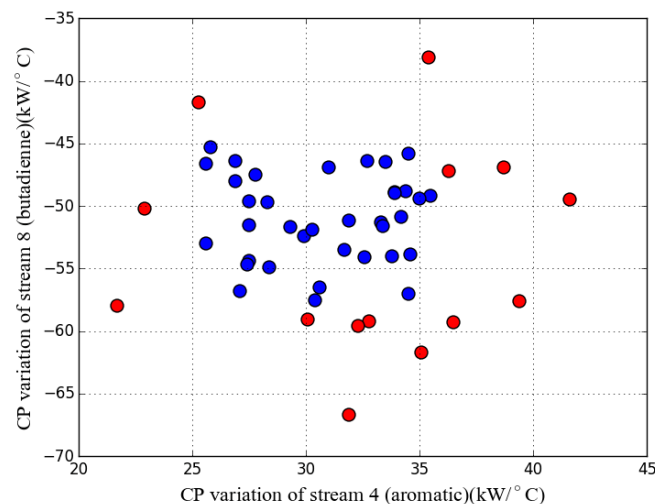

**Figure 50: Results with bi pass**

Figure 50 shows the results of the fifty simulations when a by pass is added on streams 4 and 8 where the variations occur. The limit defined by the system for a decrease in the CP of both sides has been improved. The system is now able to tolerate a decrease of 18% of CP of source stream 4 and a simultaneous decrease 10% of CP of stream 8 because, for example, for this variation, the model partially bi passes the first exchanger of the cold stream 8 connected to the network, resulting in a decrease of the temperature at the outlet of the exchanger and consequently a decrease of dtlm and thus less heat is delivered to this stream compared with nominal operations. The total heat recovered for this scenario of variations is 2850 kW.



### 3.5 Conclusions

Many methodologies and tools have been developed to obtain energy integration solutions at different scales. However, the challenging task is to get a flexible design being able to cope with input variations and maintain the system operable at the expected economic criteria especially when the heat integration is applied to multiple processes with common utility system. In this chapter a NLP model is presented for the flexibility assessment of a fixed design configuration for heat exchange network between multiple processes.

This model takes into account the heat exchanger structure installed at different streams of the processes present in the industrial park. The latter are used for the internal heat recovery between the streams of the single process, for the heat exchange with the local utilities and for the interaction with the intermediate network installed between the several processes of the industrial park. This detailed representation of the design configuration allows an accurate evaluation of the different interactions that may occur at the local or territorial scale in response to disturbances in the operating conditions of the system. In addition, the model include the integration of degrees of freedom offered at both scales as structural or operational alternatives that can be manipulated in order to maintain a large feasible operation envelope despite some critical variations and allows the integrated processes to tolerate some disturbances. The mathematical formulation was presented and two case studies were used to show the model capabilities This model completes the synthesis procedure of heat transfer network by adding operational aspects in a second stage model. In this chapter, the main focus was on the demonstration of the capabilities of the flexibility assessment model regardless of the overall methodology presented in Chapter 1. In the following chapter both models: the multi period design model (chapter 2) and the flexibility assessment model are used as a part of the overall methodology that is applied on a real case study.

# Chapter 4: Industrial Case study

## 4.1 Introduction

As previously mentioned, an important promising approach seeking minimization of resource consumption and environmental loads is the development of an eco-industrial park (EIP). The latter encourage the collaboration between different industrial sites and companies through construction of recovery networks for waste, water, energy. Therefore, the collective economic and environmental benefit can be greater than what it may be achieved at the individual scale. Many approaches and methodologies presented in the literature review have focused on the systematic design of the recovery networks at this scale. However, the main goal of this thesis is to obtain a flexible design able to handle several fluctuations and disturbances that are inevitable in the normal operation of the units. More specifically, the flexibility of the energy synergy networks established at industrial park level is sought. Indeed, investments decisions at this scale, given the number of interactions that occur, require a robust methodology for the synthesis of cost effective flexible site wide recovery networks.

The methodology proposed in chapter one combines:

- a multi period synthesis design step generating a multi scale design topology that covers the heat exchange aspects between the streams and the intermediate network and the hydraulic and geographical aspects; presented in chapter 2.
- a flexibility assessment model that covers the internal heat exchange established between the streams of the individual process and the external heat exchange with the tertiary networks; presented in chapter 3.

This methodology allows a significant reduction of the innumerable scenarios that can intervene and therefore enormous reductions of computational efforts and lead progressively over several iterations to select the flexible design with a specific level of confidence.

The whole methodology is demonstrated on an industrial case study in this chapter. The case presented is one alternative of cooperation between several processes consisting of using excess heat of several industrial sites as a heat source in district heating (DH) systems by taking advantage of the proximity of its geographic location of the sites. The aim of this case study is to design a heat recovery transport network that uses intermediate liquid water able to recover heat from several processes geographically close in order to transfer it and sell it to nearby district heating system. This network must be able to operate for multiple variations in the heating demand that might occur. In fact, the variation of heat demand of DH is related to the ambient temperature and thereby it varies each day of the year. However the size of the design problem that includes all the variation for each day of the year is extremely large and therefore it is unsolvable using the usual methods and methodologies. That is why the methodology described in the first chapter that includes the multi-period approach followed by the flexibility assessment model will be applied on this real case study to demonstrate its efficiency in order to include the maximum number of variations and obtain the optimal flexible cost effective heat transport network.

## **4.1 Description of the studied Eco Park**

The studied industrial park groups several independent processes. The processes present a significant potential heat source and thus an efficient opportunity for heat integration. Therefore, they are looking to invest in a heat recovery network that collect the excess heat from the processes to be sold and used as a heat source for district heating which can allow the partial substitution of external resource consumption for the district heating. This opportunity guarantees a rational use of the energy and thus a reduction of the environmental footprint.

The indirect multi-plant heat integration network that uses an intermediate fluid is modeled as a stream going in loop to extract the excess heat from source plants and delivers it to the sink in heat deficit (the DH). In view of heat exchangers, the indirect heat integration envisages the installation of two exchangers instead of one when direct exchange is implemented; first between the network and the source stream and the other one is installed between the network and the sink stream. The aforementioned heat transfer requires a heat exchanger superstructure of reasonable size, as well as an adapted piping system. However, in practice the heat demand is subjected to considerable fluctuations and flexible design should be capable of coping with the heat demand variations and maintain feasible operation at the optimum expected economic criterion over the time horizon. The problematic of variation of the heat demand is detailed in paragraph 4.3. Thus to obtain the final network configuration, the methodology proposed in chapter one is applied.

### **4.1.1 Data of the processes**

As a first step, the data related to the processes are collected as well as their geographical positioning and the possible pipe routing between them. The information related to the operation of the processes is confidential; the data collected is the characteristics of cold and hot streams of each process: inlet and outlet temperature and heat capacity flow rate. In this case study, the existent processes are already locally integrated and the industrial actors are seeking only the valorization of their excess heat. Therefore, a grey box approach is chosen and the used streams are only those which are connected to the utilities. In addition, only the hot streams are retained while the cold streams which are connected to hot utilities are not considered: in fact, the goal of this case study is to collect the maximum excess heat from the different processes to be delivered and used for district heating; yet the integration of the cold streams will lead to larger problem without added value to the case study since cold streams will not interact with the targeted heat recovery network. Table 27 assembles the characteristics of the used streams. The global heat transfer coefficient of each used stream is estimated using [64] in order to have a precise heat transfer area. The process streams are classified according to the state of the fluid (liquid, vapor or two phases) and to the type of fluid and thereby heat transfer coefficient can be rated. It is presumed that the intermediate network transmits its capacity to a cold stream, characterizing the DH demand, which should be heated from 80°C to 100°C and characterized by a heat capacity flow rates which depend on the variable heat demand as will be detailed in the following paragraph.

Process	Stream	T <sub>in</sub> (°C)	T <sub>out</sub> (°C)	CP (kW/°C)	U (kW/m <sup>2</sup> . °C)
1	1	123	38	248.58	0.5
	2	69	44	221.2	0.5
	3	77	32	67.77	0.5
	4	40	23	25.88	0.4
	5	134	31	37.53	0.4
	6	108	67	55.79	0.4
	7	110	47	57.01	0.4
	8	227	58	29	0.5
	9	93	34	71.64	0.4
	10	118	78	553	0.5
	11	80	50	316.67	1
	12	114	49	269.23	1.3
	13	97	56	48.77	1.3
	14	107	38	42.15	1.3
2	15	132	38	78.72	0.7
	16	206	53	37.31	0.9
	17	90	25	73.23	0.7
	18	72	35	94.6	0.9
	19	107	36	50.70	0.4
	20	92	36	145.18	0.9
	21	99	33	75.76	0.9
	22	33	16	3.53	0.7
	23	135	25	7.91	0.5
	3	24	162	53	489.96
25		53	32	122.74	0.4

Table 27 : Streams' characteristics

### 4.1.2 Geographical data

The design of the heat transport network collecting heat from the processes includes an economic feasibility evaluation that is linked to the cost of pipes and pumps needed to be installed for the operation of the network. The pipes connect all processes considered as heat sources to the heat export point through which the heat is transported to the outside of the eco-park. Therefore, the geographical positioning of each process existing within the industrial eco-park is spotted. Also the potential pipe routings between processes are depicted since the proposed model allows considering the obstacles found in the field and the existing pipe paths by defining the permitted paths and the forbidden ones. The geographical data are summarized in tables 28 and 29 that define the set of used nodes and their corresponding geographical coordinates, the set of potential paths, connection and loops. The design model presented in chapter two will help identifying the best routing for the heat transport network. As mentioned before, the identification of the nodes is based on location of each site (node 1, 2, 3, 5 and 6), and a number of additional nodes allowing to consider change in the direction or a junction

between several pipes (node 2 and 4). Figure 51 is a schematic representation of the layout of the industrial park including the processes.

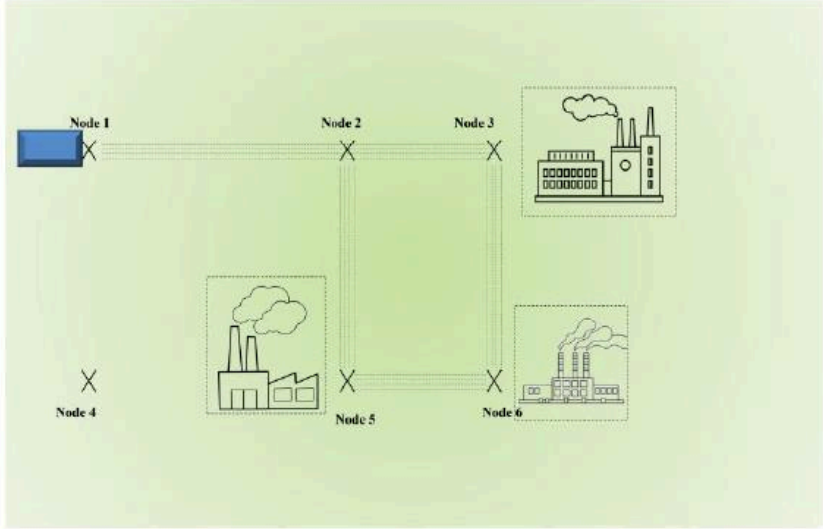

Figure 51 : Industrial park layout

Node's Number	X (m)	Y (m)	Site
1	0	0	Export
2	772,7	0	-
3	1135,6	0	Process 1
4	0	-995,1	-
5	772,7	-995,1	Process 2
6	1135,6	-995,1	Process 3

Table 28: Geographical coordinates

Paths	1	2	3	4	5	6	7
Nodes	1-2	1-4	2-3	2-5	3-6	4-5	5-6
Length (m)	772,7	995,1	362,9	995,1	995,1	772,7	362,9

Table 29 : Path lengths and connections

Table 29 groups all the paths that the model can consider in order to choose the best routing that minimize the total cost. Besides, the model presented in chapter two that provides the configuration of the network, determines the head loss due to friction in each pipe and the pumping power needed for the circulation of the intermediate fluid, for that reason, a preliminary analysis of connections and possible routes allows the definition of several closed loops between the nodes as an additional input of the multi period model, used to consider the pressure drop equilibrium and therefore to obtain precise solution of the hydraulic system. Two loops that join several nodes are identified. The closed loop starts and ends with the same node.

- Loop 1: 1/2/8/4/1
- Loop 2: 2/3/6/5/2

### 4.1.3 Problematic heat demand variation

As mentioned before, the heat requirements of the urban network are strongly affected by the ambient temperature. Consequently, the heat recovery network to be designed must be economically viable and operable for any heat demand. Therefore, as a first step, for an accurate estimation of the variation of the heat demand, weather data and specifically temperature data are collected.

The recuperated data includes an average value or in other words one representative temperature for a typical day of each month in the region of the eco industrial park. Twelve temperatures of the years 2002, 2003, 2012, 2013 and 2014 are detected and plotted in figure 52. Thereby as a second step, an estimation of the heat demand based on the average ambient temperature in the considered region is presented.

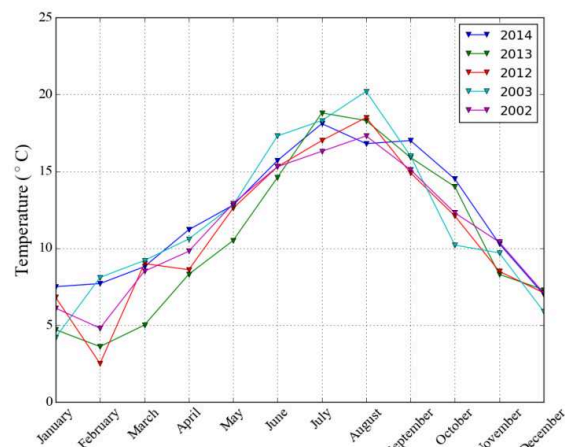

Figure 52 : Average ambient temperature curves for several years in the studied region

#### Relation between the average ambient temperature and the amount of heat required

The peak heat demand of the studied DH is 27 MW and it corresponds to the minimum average ambient temperature depicted. On the other hand for an average ambient temperature greater than or equal to 15 °C, the heat demand of the DH is 2 MW that corresponds to the sanitary hot water. A linear relation (see Figure 53) connecting the average ambient temperature and the heat requirement is assumed. The latter is limited for temperatures below 15°C. For every higher temperature (>15°C) the heat demand is considered fixed and equal to 2MW. Consequently, the heat demand for every temperature of the data collected can be calculated. Figure 54 groups the 60 values of heat demand that has been encountered in the years collected.

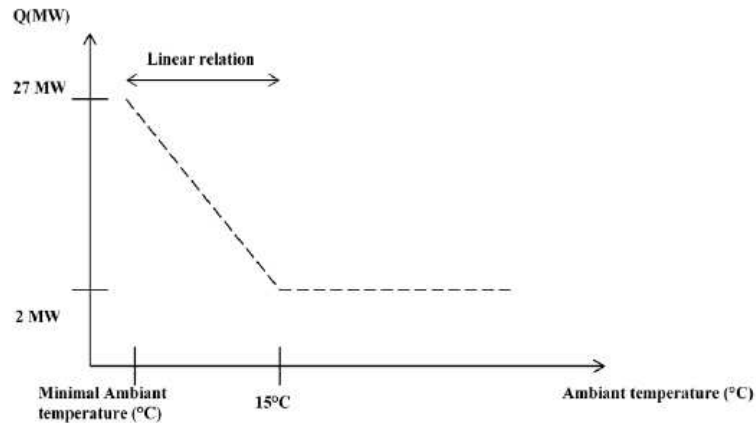

Figure 53 : The relation between the heat demand and the ambient temperature.

The main issue is the selection of the appropriate heat demands to ensure a flexible design that is efficient economically with a reasonable computational time. The integration of all 60 heat demand variations as a series of scenarios of static operating conditions as an input in the multi period approach will highly increase the size of the problem that becomes insolvable. The multi period design model detailed in chapter two is potentially suitable for a limited number of scenario variation. Thus, the proposed methodology aims to solve this challenging task by solving smaller optimization problems and therefore ensuring a practical computation time. The implementation of the methodology is presented in the next paragraph.

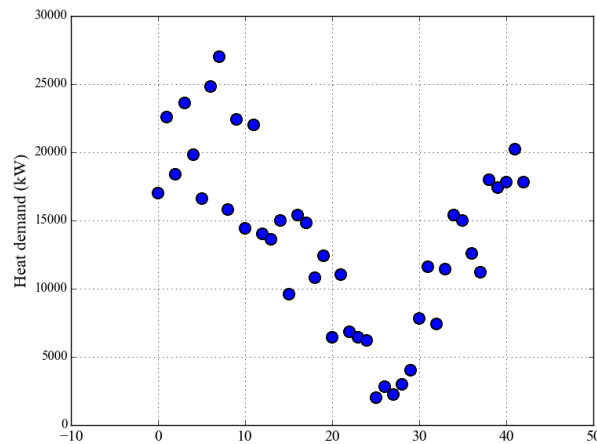

Figure 54 : The corresponding heat demand variation based on the average ambient temperature for the twelve months of the different years.

## 4.2 Methodology and implementation

As mentioned before, the goal is to design a heat transport network that recover excess heat from different processes presented in the industrial park to supply a district heating network. It consists of determining the topology of the heat exchange network including the fixed dimensions of the heat exchangers and their placement on the specified streams. In addition, the design considers size of the pipes and pumps to be installed. The obtained configuration must be operable for multiple fluctuations in the heat demand over the whole year. Besides

ensuring a feasible operation, the network must be economically viable over the considered time horizon.

The proposed methodology avoids the representation of all the scenarios simultaneously in a one single design step. The flexible heat recovery network is designed by the two-stage formulation allowing a progressive approach of integrating scenarios considered as critical. In the first stage, the design variables related to the network topology (the size of heat exchanger units) are determined and in the second step recourse actions are specified in order to cope with the realization of additional variability. The latter adjust structural or operating variables (By pass use, temperature of the network, utility flow rate, utility temperature...). The schematic representation of the methodology is shown in figure 55 and consists of two main steps.

1. Optimal flexible multi period design
2. Flexibility assessment of the design and corrective actions.

The two corresponding mathematical formulation of each step were detailed in chapter two and three respectively and illustrated by virtual case studies.

#### Optimal flexible multi period design

Firstly, a set of initial operating conditions of the streams as well as the geographical data described in the previous data and the technical data (Specification of the available set of diameter size and its corresponding costs, the coefficients of linearization used for the calculation of pressure drop and pumping power, and the discretized intervals for the surface of the heat exchanger and its corresponding coefficients for the cost calculation (chapter 2)) constitute the data input file of the multi-period design model. The latter optimization model will search simultaneously in all the integrated periods to establish an optimal network from the energy and economic point of view. The goal is the design of a cost effective recovery network. Thus the following objective function of the model is to maximize the profitability.

$$cost = \text{revenue of sold heat} - (\text{cost pumping} + \text{cost pipes} + \text{cost exchangers}) \quad 4.1$$

Where:

$$\text{cost of sold heat} = \text{cost of heat} * \text{actu} *$$

$$\sum_{p \text{ in periods, } m \in \text{groups, } n \in N-1, \text{ net in networks}} qp_{p,m,n,net} * NbOpHours * lp_p$$

The cost of heat considered is 0.02 euros per kWh, *cost pumping* + *cost pipes* + *cost exchangers* are detailed in chapter two and it is assumed that the operating cost integration period is 60 months and the actualization rate is 0.3% monthly. This network may have a variable temperature level and heat quantity for each period so that it will succeed more or less to meet the load curve of the heat demands and to avoid as much as possible over-investment. The output of optimization model determines the properties of the network, the amount of heat transferred between the different units and the network and consequently the total heat delivered to district heating for each period, specification of the heat exchangers areas and the pipe installation between several units.



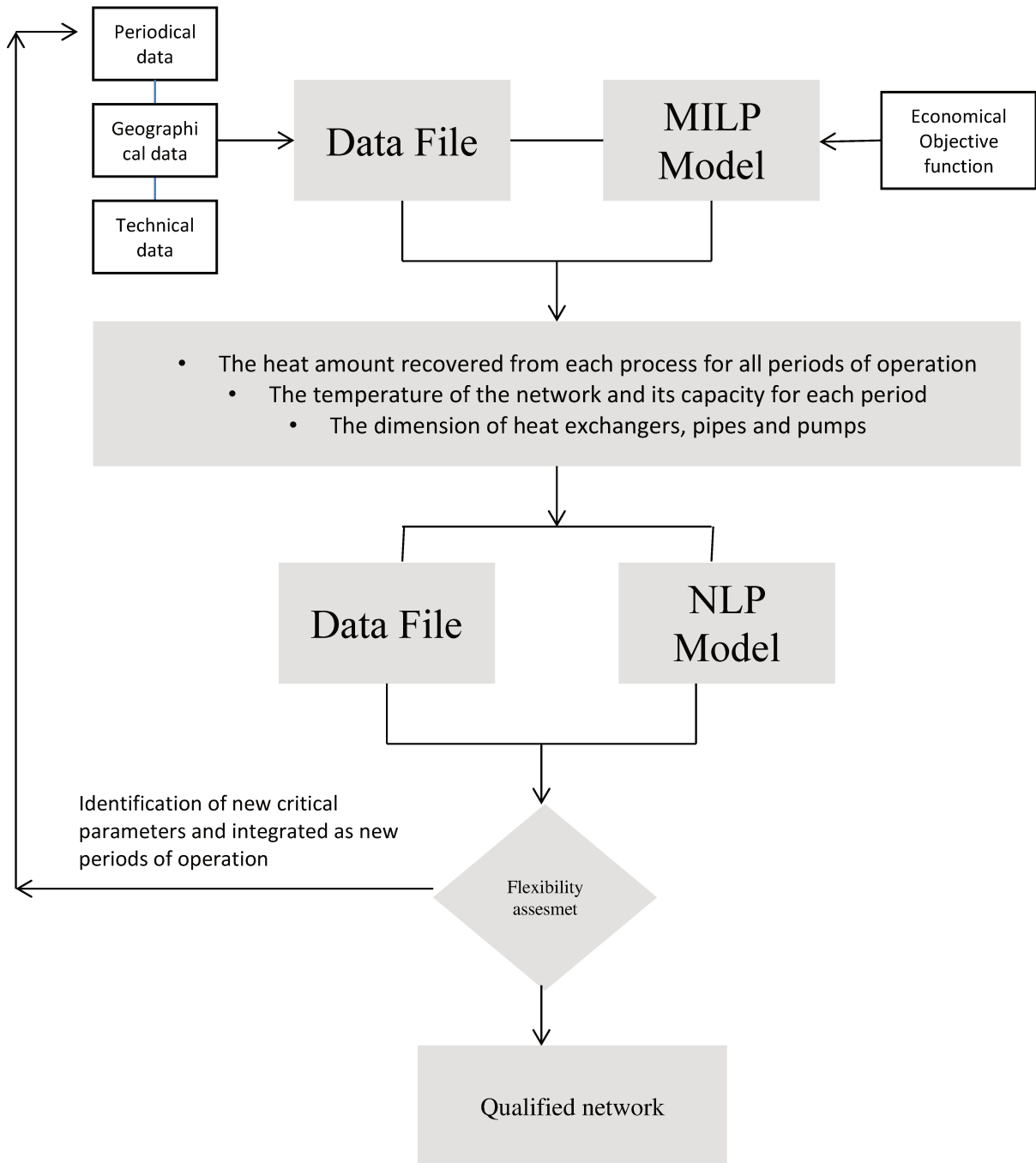

Figure 55: schematic representation of the methodology

Flexibility assessment of the design and corrective actions.

The resulted configuration obtained is tested for additional number of variations and specifically in this case study for all the variations that have been encountered in the five years (figure 54) using the NLP optimization model detailed in chapter three in order to determine if the fixed configuration as obtained in the synthesis phase (with specific dimensions of heat exchangers) is able to maintain the outlet temperatures of the streams using minimal increase in utilities in spite of the additional disturbances. The objective function of this model is minimizing the consumption of utilities. In addition, the feasible configuration should not use additional areas to meet the heating or cooling requirement. Therefore, a penalty cost (P=1000)

associated to additional heat exchangers needed area is added to the objective function. This numerical degree of freedom helps easing the resolution of the optimization problem and picking the unfeasible points.

$$\text{Min}(Q_{hu} + Q_{cu} + P * a)$$

Moreover, the structure can be extended with the addition of several degrees of freedom as structural or operational alternatives to ensure feasible operation.

After obtaining the critical heat demand scenarios that caused infeasibility of the heat recovery operation, the multi period design model is then solved simultaneously using the initial scenarios and the critical ones in order to provide feasible optimal topology and specifically optimal sizes of heat transfer units able to handle several critical variations encountered. To obtain the final qualified configuration, several iterations might be required.

### 4.3 Mono periodical study

As shown in figure 54 and based on collected weather data, the heat demand in the considered region varies between 27000 kW and 2000 kW. Heuristically, extreme points of heat demand are usually the first used combination to guarantee a flexible design covering the entire range of variations. Nevertheless, a network that can cope with extreme and critical disturbances is not necessarily guaranteeing an adequate operation for all the states of variations that can occur. Consequently, in this preliminary phase, at first glance, two random heat demands between these two extreme limits for a precursory mono periodical study were chosen in order to compare the two configurations and the extensions of its corresponding feasibility envelope using the NLP model and the corrective actions. The results will be analyzed in order to have an initial set of scenarios for the multi period study.

The chosen representative scenarios consider a relatively high and a medium heat demand: 23600 kW and 11600 kW corresponding to a winter and spring head demand respectively. At first, two separate design studies were carried out using the model presented in chapter two in order to reduce the size of the problem by choosing the most significant streams participating in heat exchange with the intermediate network that will be used in the input data file of the follow-on multi period study. Then, in the second step, the flexibility analysis is carried out for each design to test its feasibility for all heat demands that have been encountered in the mentioned five years. Finally, the two configuration of heat recovery network are compared allowing a determination of starting non extreme scenarios for following multi period study carried in the next paragraphs.

The model of chapter two is solved for each case using a single period of operation. The data related to the processes used, are summarized in table 27. The sink related to the district heating is represented by a cold stream to be heated from 80°C to 100°C and the capacity flow rate CP is related to the wanted heat demand ( winter heat demand CP=-1180 kW/°C and spring heat demand CP=-580 kW/°C). The results obtained details the heat recovered from each process and to be delivered to heat export point the network's temperature and the area of heat exchangers to be installed are summarized in table 30 for winter heat demand and in table 31

for spring heat demand. The model chooses streams 8, 16, 24 from process 1, 2, 3 respectively to establish the heat exchange for the first design and streams 8 and 24 for the second design. Process 2 does not participate in the exchange with the network in the second design.

Capacity(kW)	Network 1	HX Area
	116.8/100°C	m <sup>2</sup>
Heat demand	22158	1138
Process 1	2895	63
Process 2	2801	93
Process 3	16462	1138

**Table 30 : Winter heat demand design results**

Capacity(kW)	Network 1	HX Area
	125/100°C	m <sup>2</sup>
Heat demand	11600	486
Process 1	2582	54
Process 2	0	0
Process 3	9018	613

**Table 31: Spring heat demand design results**

The first design is able to collect 22158 kW of the processes and respond almost to the totality of the supposedly constant heat demand (94%) using an intermediate liquid network and those temperatures are  $Tu_{net} = 116.8^{\circ}C$  and  $Tl_{net} = 100^{\circ}C$ . On the other hand, the spring demand design obtained, collects all the need from process 1 and 3 without using any stream of process 2 thus avoiding the installation of a third heat exchanger and pipes costs. The intermediate liquid network temperatures are ( $Tu_{net} = 125^{\circ}C, Tl_{net} = 100^{\circ}C$ ). The upper temperature of the tertiary fluid has increased thus an increased  $lmt_d$  which allows a further reduction in the heat exchanger area installed at the sink and consequently additional minimization in the cost of investment.

An evaluation of the operability of the two configurations is checked using the NLP model. Sixty variations of heat demand are tested by varying the CP of the sink stream of the data file related to the NLP model. The results are shown in figure 56 and 57. The blue dots correspond to variations of CP or variations of heat demand that are feasible or in other words it corresponds to fluctuations for which the output as output streams' temperature are within the desired range and without the need of a additional heat exchanger area.

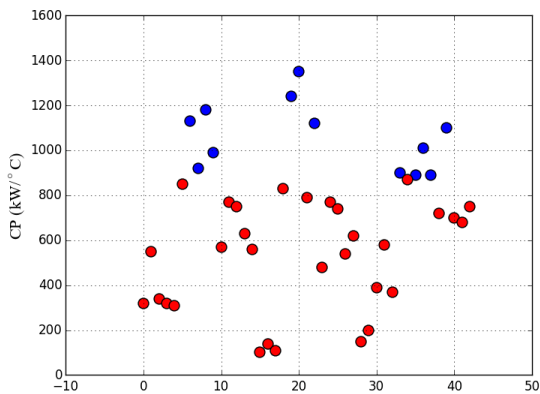

**Figure 56 : Simulation results (winter condition) with one degree of freedom**

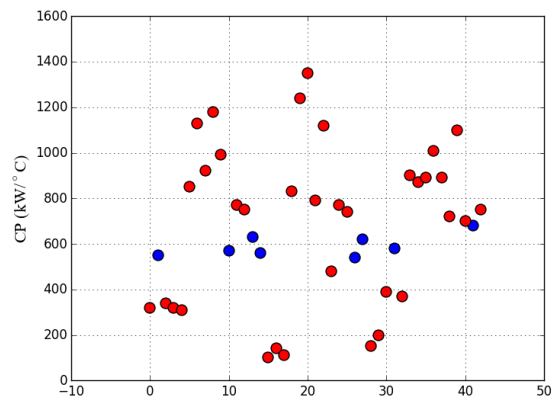

**Figure 57 : Simulation results (spring condition) with one degree of freedom**

The red dots correspond to variations of CP that the configuration is unable to cope with even if the temperature of the network is not fixed: the output temperature of the streams exceeds the limited relaxed limit of 3°C or the model proposes an additional area on any of the heat

exchangers installed. The flexibility study carried out for the first configuration shows that the resulting design is unable to handle fluctuations in heat demand below 18000kW (figure 56) even though the temperature of the network may vary. Similarly for the second case (figure 57), the obtained network is feasible just for variations between 11000 and 14000 kW. Another flexibility evaluation is carried out for the two designs by adding supplementary degrees of freedom: bypass, and variable temperature of utilities. The results are shown in figures 58 and 59. The number of feasible points has increased but is still limited for heat demand below 8000 kW for the first design and for the second for heat demand upper than 12400 kW and lower than 4000 kW.

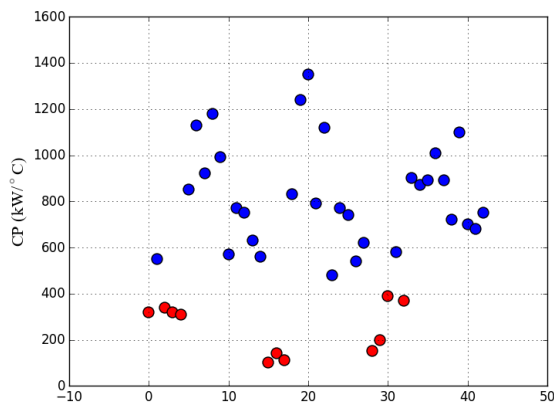

**Figure 58 : : Simulation results (winter conditions) with three degrees of freedom**

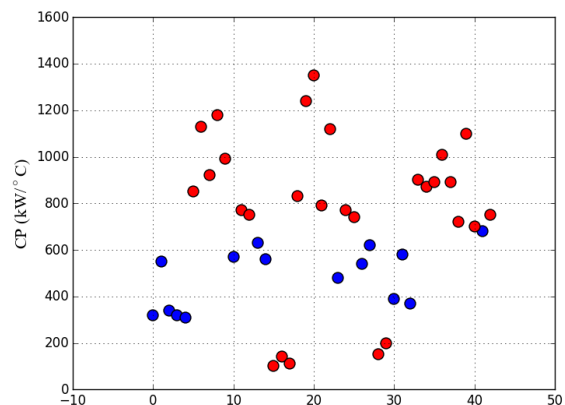

**Figure 59: Simulation results (spring conditions) with three degree of freedom**

The infeasibility and the inability of the configurations designed for a winter case and a spring case to cope with fluctuations in spite of the addition of various degrees of freedom like variable network temperatures, bi passes on the exchangers and the temperatures of the utilities drive on the use of the proposed methodology. However, the initial set of scenarios will not include the extreme critical heat demands (27000 kW and 2000 kW) since the feasibility envelope obtained for the preliminary two designs covers a lot of variations specially when adding the degree of freedom. Two periods of equal duration are used corresponding to both cases of heat demand studied in this paragraph in order to investigate the feasibility envelope of all the fluctuations that may occur.

## 4.4 Two periods design

The study is now initiated with two periods of identical duration, it is assumed that half of the time the demand of heat is 23600 kW and during the second half, it is equal to 11600 kW. The multi period model is solved using the same technical and geographical data as the previous case; the data related to the three processes are simplified and only the streams that have been chosen in the previous mono periodical study are included (streams number 8, 16 and 24). It should be noticed that the global temperature scale (paragraph 2) is built using the mentioned inlet and outlet streams' temperature; in addition, a sub division equal to 10 is introduced in

order to attain a higher accuracy. Nevertheless, this discretization is limited because it enormously increases the calculation time. The model output determines the heat recovered from each process at each period as shown in table 32. The constraint of a unique investment for all the periods forces the model to use the same heat exchanger area to be installed on the specified streams and the same pipe diameter for both periods. The discretization of the temperature scale provided in the multi-period model offers a degree of freedom that allows the variation of the heat recovered between the two periods. The model will choose the placement of the heat exchangers on the intervals of the temperature scale; eventually the highest interval for the hot streams is used to obtain a higher temperature difference and higher lmt<sub>d</sub>. The network collects 16243 kW from the processes to satisfy 68.8% of the heat demand in the first period; it is assumed that the extra heat demand is provided by a hot utility to which the sink stream is connected in parallel. Similarly, the additional cooling requirement of the hot source streams of each process is provided by a local cold utility. The heat recovered in the first period is less than the heat collected when considering a mono periodical winter case since the model will seek the most cost-effective solution economically and therefore avoid the over sizing of the exchangers and pipes and seeks a solution more economically profitable and which can satisfy both periods at the same time. In the second period, the total heat demand is delivered by the processes. The network layout is shown in figure 60. The diameters of pipes installed on each path as well as the velocity of the intermediate fluid and the mass flow rate of the intermediate liquid for each period is also determined by the model and summarized in table 33.

	Period 1 116.8/100°C	Period 2 116.8/100°C	HX Area m <sup>2</sup>
Heat demand	16243	11600	835
Process 1	2896	2896	63
Process 2	2512	1915	75
Process 3	10836	6789	663

Table 32: Results of two periods design

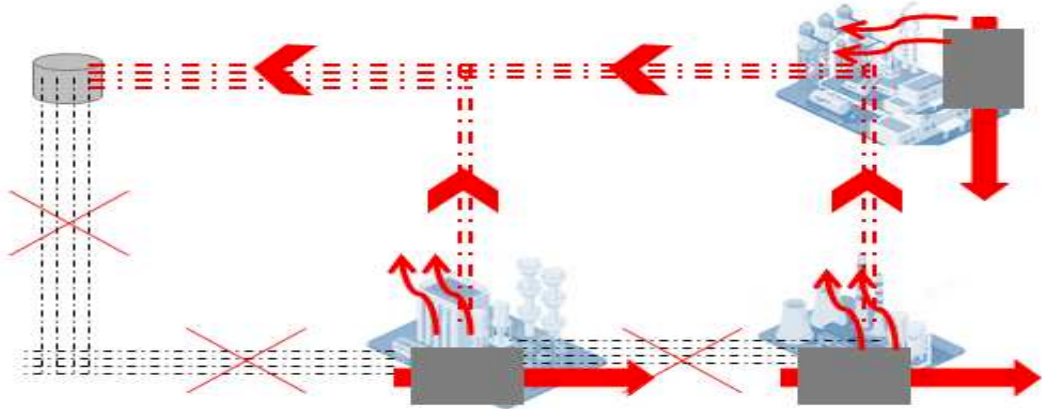

Figure 60 : Network lay-out

Path number	Mass flow rate Period1 (kg/s)	Mass flow rate Period2 (kg/s)	Velocity Period 1 (m/s)	Velocity Period2 (m/s)	Diameter (m)
1	231.3	165.2	2.4	1.54	0.35
3	195.5	137.9	2.03	1.43	0.35
4	35.77	27.27	2.02	1.36	0.15
5	154.3	96.68	2.18	1.71	0.3

**Table 33: Heat export network piping properties**

As shown in figure 60, two heat exchangers are installed at each source stream, the first connected to the network and the second connected to local cold utility. The model chooses the optimal pipe paths to be used depending on the distances and the costs of pipes and pumps involved. It is known that the mass flow rate of intermediate fluid determines the pipeline diameter. A larger diameter indicates a higher investment of pipeline. In addition, higher flow rate requires more power for transportation, resulting in a higher pump investment and power cost. Therefore, a trade-off between energy recovery and distance related and heat exchangers installation cost is required for both periods. The following table determines the cost of heat exchangers, pipes and pumps of this configuration chosen for this design.

Cost(Euros)	Network 1
Pumps	106698
Exchangers	1734493
Pipes	2102562
Total investment	3943755

**Table 34: Investment costs**

The resulted configuration obtained is tested in this step for all the fluctuation scenarios of the heat demand presented in figure 54. At first, the design obtained is characterized by the type of the network, its temperature, the characteristics of local utilities and the information on the location of every heat exchanger therefore, the configuration is adapted to the nodal division with the connections to the network and the utilities and will constitute the input data file of the NLP model. The model is solved for 60 variation of CP in the data file. The flexibility evaluation carried out using a single degree of freedom at first: the network's upper and lower temperature in order to find a feasible solution where the desired output temperature is within the specified relaxed range facing the variable heat demand. However any additional heat exchanger area needed to be installed, the configuration is considered unfeasible. The figure 61 below shows that the feasibility envelope has increased compared to both designs of the previous paragraphs. Figure 61 shows the feasible (blue dots) and the unfeasible variations (red dots). For each feasible variation, the upper and lower network temperatures are calculated by the model (figure 62). It varies between 122°C and 115°C and the lower bound is almost 96°C.

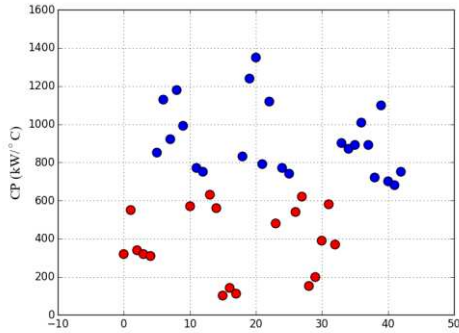

Figure 61 : Simulation results with one degree of freedom

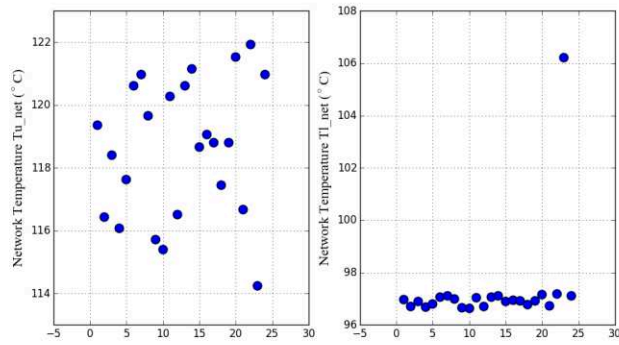

Figure 62 : Variation of the network's temperature

As noticed in the results, the fixed configuration that include well-defined heat exchanger area is not able to cope with fluctuations where CP is less than 600 kW/°C because the implicit bypass of the multi-period model is not included in this first series of simulations. For example, to cope with the variation of CP of the sink stream when its is 680 kW/°C the network chooses  $Tu_{net} = 114^{\circ}C$  and  $Tl_{net} = 106^{\circ}C$  and collects: 2747kW, 2253kW and 10638 kW from process 1, 2 and 3 respectively to supply 15640 kW to the sink stream while respecting the output temperature of the streams, however for the unfeasible point like CP= 390 kW/°C even with the specific network's temperature  $Tu_{net} = 122^{\circ}C$  and  $Tl_{net} = 110^{\circ}C$  allowing a maximum minimization of the heat extracted from the processes ( 2582 kW, 2138.5 kW and 9318 kW), using the same heat exchangers on the sink stream, the output temperature is 116°C and therefore is considered unfeasible.

To correct the structure deficiency, another recourse actions can be taken by adding additional combination of manipulated variables as alternatives to increase the feasibility of the network. At first, by passes over the heat exchangers that are connected to the network are considered. The feasibility envelope has increased since the network is now able to collect lower heat from the processes however, it remains unfeasible for CP less than 390 kW/°C; in fact, additional cooling will be needed and the model require additional area for the heat exchangers that are connected to the cold utilities. Figure 64 details the additional area needed for HX1, HX2 and HX3 that corresponds to the heat exchangers connected to the cold utilities for processes 1, 2 and 3 respectively. Then, an alternative operational degree of freedom considered when running the NLP model: the variation of the cold utility temperature. The lowest unfeasible CP 310 kW/°C that needed additional area in the previous step becomes feasible: the model takes advantage of the variation of the network temperature:  $Tu_{net} 120^{\circ}C$  and  $Tl_{net} = 90^{\circ}C$ , and the by passes to minimize the heat collected 1593 kW, 3827 kW and 4551kW) and the cold utility temperature in order to use the same configuration (the specific heat exchanger area obtained from the multiperiod design) allowing the solution to become feasible. In fact varying the cold utility temperature enable an increase of the lmtcd of the exchange between the source streams and the local cold utilities and thus higher heat exchange can be accomplished.

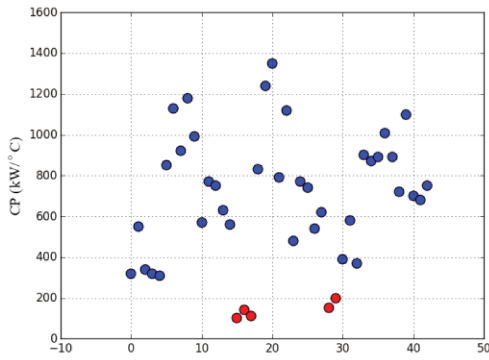

Figure 63 : Simulation results for additional degrees of freedom

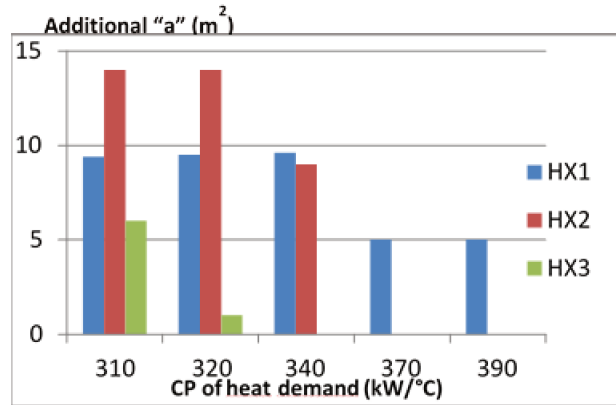

Figure 64 : Additional areas on heat exchangers

Therefore the configuration is able to manage different fluctuations that were unfeasible in the first set of simulations and are in figure 63 replaced by blue dots using variation of the temperature of the network and the addition of the bi pass. Figure 65 shows the variation of the recovered heat from each process for all the possible variations. The average of the total heat exported is 14342 kW, 2519 kW collected from process 1, 2004 kW collected from process 2, 9819 kW collected from process 3. However, as noticed in figure 65, for reduced heat demand the heat recovered from each process is reduced; this is possible since the model uses the partial by pass to allow the achievement of some small heat demand in parallel with reduced heat recovery.

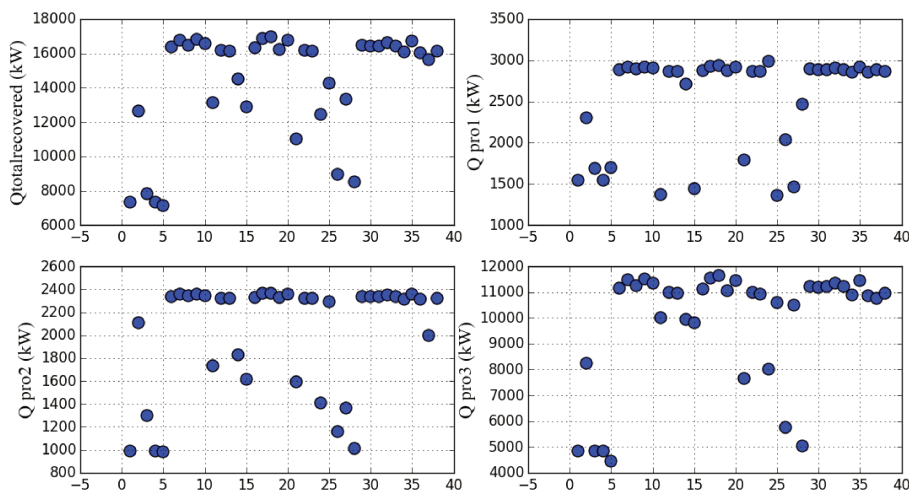

Figure 65 : Total heat delivered to district heating and heat demand withdrawn from each process

## 4.5 Three periods design 23600 11600 4000: Design 2

As described in the methodology, the results obtained from the flexibility analysis are used to identify the critical scenarios that must be appended to the initial set of scenarios and then go back to the multi period synthesis step for iteration to find a new candidate network. Thus, an



additional period that corresponds to a 4000 kW of heat demand is added to the input data file of the multi period model. Also, in this iteration, the three periods are of equal duration and correspond to a heat demand of 23600 kW, 11600 kW and 4000 kW respectively. The multi period model is solved and the results show a new optimal topology of the heat transport network to be installed between process 1, 3 and the export point for district heating and that is operable for each of the three scenarios taken into account at this step.

	Period 1 125.2/100°C	Period 2 125.2/100°C	Period 3 116.8/100°C	HX Area (m <sup>2</sup> )
Heat demand	6866	6866	4000	288
Process 1	1245	1245	533	19
Process 2	0	0	0	0
Process 3	5621	5621	3466	314

**Table 35: Multi period three period design**

Table 9 details the interaction between the processes and the network, network's temperature and the heat exchanger area installed. In the first two periods with relatively high heat demand, the network collects 6866 kW satisfying 29% of the heat demand in the first period and 59% of the heat demand in the second period. The interaction with the network as well as its temperatures  $Tu_{net} = 125.2^{\circ}\text{C}$  and  $Tl_{net} = 100^{\circ}\text{C}$  are identical in the first two periods. In the third period, the variation of the network temperatures  $Tu_{net} = 116.8^{\circ}\text{C}$  and  $Tl_{net} = 100^{\circ}\text{C}$ , that has been possible thanks to the discretization of the temperature scale, allows a total recovery of the heat demanded using the same installed heat exchanger area.

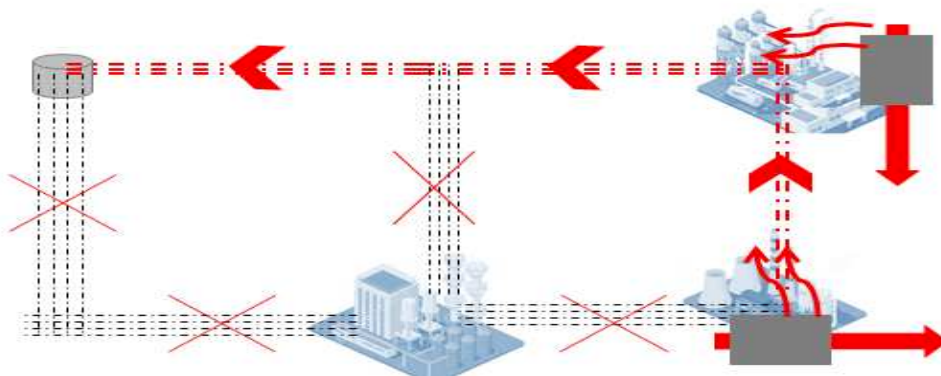

**Figure 66 : Network layout**

Path number	Mass flow rate Period1/2 (kg/s)	Mass flow rate Period3 (kg/s)	Velocity Period 1/2 (m/s)	Velocity Period3 (m/s)	Diameter (m)
1	65.18	56.96	0.2	2.07	1.81
3	65.18	56.96	0.2	2.07	1.81
5	53.36	49.356	0.2	1.69	1.57

**Table 36: Hydraulic results**

As noticed in network layout of figure 66 process 2 located at node 5 does not participate in the heat exchange with the intermediate network. Therefore, the piping network considers only path 1, 3, 5 for the transport of the intermediate fluid. The diameter and the velocity for each period are determined by the model and summarized in table 10. The economical objective function force the model to reduce investments and thus the over sizing of heat exchangers and pipes, this configuration collected much lesser heat than the previous designs and in parallel lower investments costs are involved (table 11): no pipes are installed in path 4, no heat exchanger installed at process 2 and smaller heat exchanger areas are used.

Cost(Euros)	Network 1
Pumps	50315
Exchangers	866936
Pipes	1037756
Total investment	1955008

**Table 37: Investment costs**

The flexibility assessment NLP model is solved for the fixed configuration obtained over the set of the collected heat demand variation within a loop that varies at each simulation the CP of the sink stream in the data input file. This step checks the feasibility of the output temperature constraint and heat balances of the resulted connections established using the fixed area obtained in the design step.

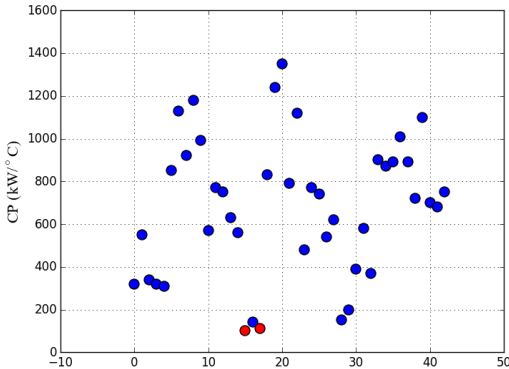

**Figure 67 : Simulation results of the NLP model**

Based on the deviation of the output temperature and on the identification of the slack variable a added to the optimum heat exchanger area the unfeasible scenarios are detected. As shown in figure 67 using the same degree of freedom of the multi period design, the feasibility envelope has increased and includes almost all the integrated fluctuations. Once again two new parameters points that embrace the lowest heating demand 2200 kW and 2000 kW are not operable.

In fact, using the relatively big fixed area of heat exchangers connected to the network the goal is to be able to reduce the amount of heat exchanged on these connection; thus the upper limit of the variable that determines the maximum temperature difference between the upper and lower limits of temperatures of network are increased as an additional operational alternative.

The results are shown in figure 68, all the disturbances are feasible and for the critical heat demands the model chooses  $Tu_{net} = 140^{\circ}\text{C}$  and  $Tl_{net} = 90^{\circ}\text{C}$  thus a decrease in lmtd and consequently in the heat recovered from the processes and delivered to the district heating.

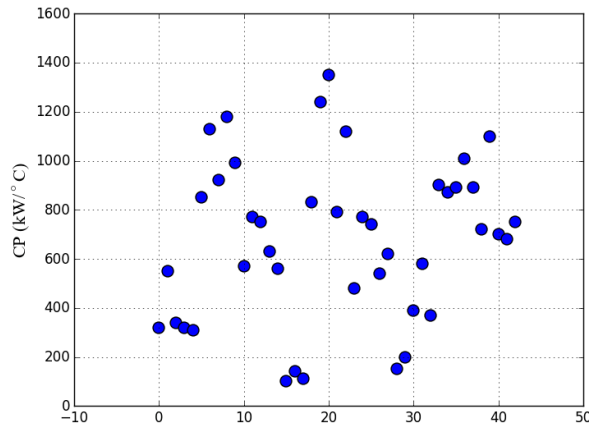

Figure 68: Simulation results using one additional manipulated variable

Note that the discretisation of the unique temperature scale used in the multi period design model limit the choice of the network's temperature obtained and improving the discretisation increases highly the calculation time. Yet, in the NLP formulation proposed, the model take advantage of the degree of freedom to ensure a feasible operation for critical disturbances.

#### 4.6 Three periods 23600 11600 2000 : Design 3

To emphasize the benefit of the methodology, a design that includes the lowest heat demand 2000 kW in the initial set of scenarios of the multi period model is studied. The latter is solved with three periods of equal duration that correspond to a heat demand of 23600 kW, 11600 kW and 2000 kW respectively. The results determine a new topology for heat recovery where the three processes participate in heat exchange similar to figure 60 and that is operable in the three periods. As shown in table 12, the interaction between the processes and the network in the first two periods is identical, 4103 kW are recovered using an intermediate fluid ( $Tu_{net} = 125.2^{\circ}\text{C}$  and  $Tl_{net} = 100^{\circ}\text{C}$ ), the network's temperature changes in the third period and the processes deliver 2000 kW to the district heating system. Smaller size of heat exchangers and pipes are associated to this reduced heat recovery. The details: pipe diameter installed, velocity and flow rate on each path are detailed in table 13.

	Period 1 125.2/100°C	Period 2 125.2/100°C	Period 2 116.8/100°C	HX Area (m <sup>2</sup> )
Heat demand	4103	4103	2000	144
Process 2	1432	1432	613	63
Process 3	1827	1827	905	43
Process 4	844	844	482	44

Table 38: Results of two periods design

Path number	Mass flow rate Period1/2 (kg/s)	Mass flow rate Period3 (kg/s)	Diameter	Velocity Period 1/2 (m/s)	Velocity Period3 (m/s)
1	39.27	19.14	0.15	2.204	1.612
3	21.78	10.48	0.15	1.222	0.882
4	17.48	8.66	0.15	0.981	0.729
5	8.08	4.61	0.15	0.454	0.388

**Table 39: Hydraulic results**

Lower mass flow rate of intermediate fluid implies smaller pipeline diameter resulting a reduced investment cost of pipes and pumps (table 13, 14).

Cost(Euros)	Network 1
Pumps	20255.
Exchangers	638202
Pipes	1074699.
Total investment	1733158

**Table 40 : Investment costs**

The constraint of unique investment for heat exchangers and pipes in the multi period model that aims to minimize the investment cost lead to a minimal heat recovery, attaining 17,3% in the first period and 35.4% of the heat demand. Thus the rest of the heat demand requires an external heat purchase. The operability of the resulted configuration is tested using the NLP model. The model can use only the variation of the upper and lower temperature of the intermediate network in order to find a feasible solution in spite of the 60 disturbances integrated. Figure 69 prove the feasibility of all variations of heat demand as predicted. Nevertheless, the average heat recovered is equal to 4082 kW for all the variation as shown in figure 70.

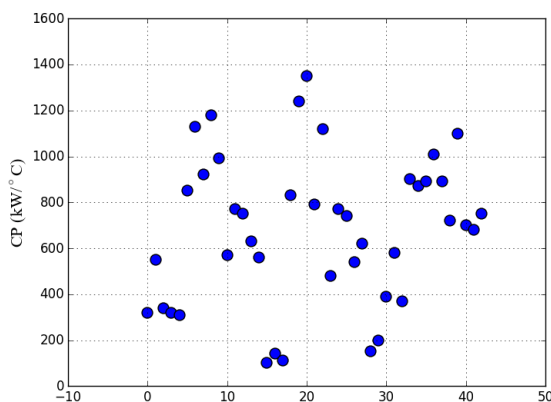

**Figure 69: Simulation results of NLP model using network 's temperatures as a degree of freedom**

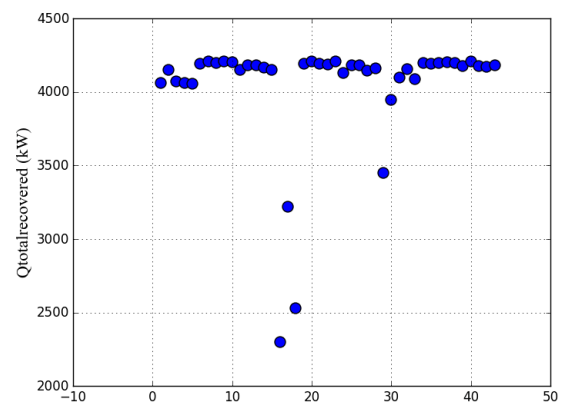

**Figure 70 : Total heat recovered for each variation**

## 4.7 Economical analysis

In this paragraph an economic evaluation is established between the investment cost and the revenue for multiple designs. Using the values obtained for the different variations and fluctuations of heat demand, the average of heat recovered is calculated so the cost of the heat sold; equation 4.1 is replaced by:

$$\text{costofsoldheat} = \text{costofheat} * \text{actu} * Q_{\text{average}} * \text{NbOpHours}$$

The following diagram (figure 71) compares the investment costs, the revenue of recovered heat between the three designs. The first design that considers a winter and spring heat demands presents a high gain due to a large heat recovery ( $Q_{\text{average}} = 14342 \text{ kW}$ ), however this configuration is not feasible throughout the year and is not operable for small heat demands of summer time and therefore, it is excluded. Design 2 and 3 which are operable for the heat demand fluctuations that has been encountered, have close investment costs (1,95 Meuros vs 1,73 Meuros), nevertheless the amount of recovered heat and consequently its revenue which is sold to the district heating is higher for design 2 ( $Q_{\text{average}} = 6802 \text{ kW}$  for design 2 vs  $Q_{\text{average}} = 4082 \text{ kW}$  for design 3). The operability of design 2 necessitates the introduction of manipulated variables such as bi passes or cold utility temperature variation and also necessitates a higher limit for the network temperature. These degrees of freedom may introduce an additional operation complexity and an additional cost that has not been considered. Design 3 allows a flexible operation without the need for the degrees of freedom besides manipulating the network temperatures.

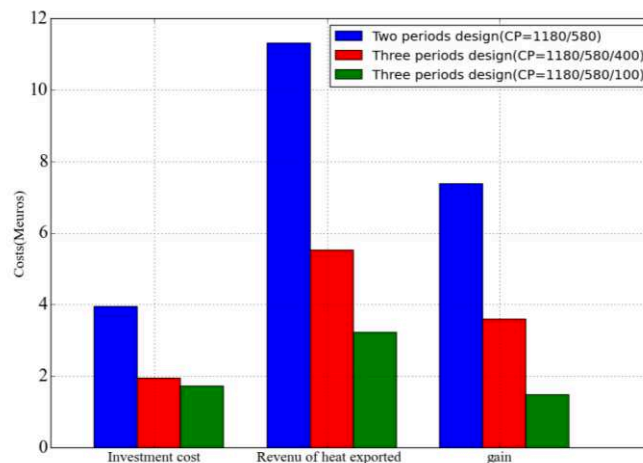

Figure 71 : Comparison between the investments costs and revenue of sold heat for three different designs

An additional analysis is therefore needed to choose between the designs 2 and 3. Such analysis should consider the cost and the complexity of the needed degrees of freedom to insure the flexibility of design 3 compared to highest economical value of this design compared to the design 3.

Thus, this methodology allows the progressive introduction of critical scenarios and accounts corrective actions by taking advantage of the degrees of freedom offered by the NLP model in response to disturbances in order to deduce a configuration economically, energetically and environmentally more advantageous than any conservative design.

## 4.8 Conclusion

In this chapter, a real case study is used to illustrate the use of the methodology proposed in this thesis. The aim of this case study is to design a heat recovery network able to collect heat from three different processes geographically close and deliver it to a district heating system. However, the heat demand of the heating system is not constant and depends on the ambient temperature. Consequently, the heat recovery network to be designed must be economically advantageous and able to cope with variation in heat requirement. The design problem is decomposed into two sequential steps:

- Multi period MILP design model that considers a finite number of operating scenarios and provides detailed design of the recovery network, selection of heat exchangers areas and piping installation.
- NLP flexibility assessment model to test the operational feasibility of the resulting network, it allows the integration of specific degree of freedom to cope with the input fluctuations.

The information provided is used to add critical conditions to the multi period design phase to find a new candidate network. Note that the inclusion of each period for a new critical extreme variation increases the number of variables, that's why the proposed strategy is attractive because it prevents the necessity to include a large number of critical operating points directly in the design formulation. It is a progressive approach of integrating critical scenarios in order to generate a feasible network with high heat recovery in a relatively more efficient way specially using the structural or operational alternatives that helps to overcome the infeasible operations.

# Conclusions

This thesis work presents a novel methodology that takes into account the operability issues as variations and disturbances in the operating parameters in order to find a flexible heat transport network between multiple processes in eco industrial parks while optimizing the overall costs. In fact, usually several changes in the capacity or the characteristic of industrial processes can occur and these fluctuations are unavoidable and can highly affect the economic and energetic optimality and can deprive the system of its efficiency.

Mathematical optimization techniques relying on mathematical linear or non linear models are used to tackle this complex problem. It allows the representation of the system operation in a systematic way by decomposing it into a set of equations that can include multiple features. The proposed strategy avoids the necessity to include a large number of variability directly in one design formulation because it highly increases the number of variables and may quickly make the problem insolvable especially at this scale with multiple integrated processes. Therefore, the presented methodology is composed of two iterative steps:

- Multi period MILP design model that considers a finite number of operating scenarios to obtain specific site wide heat integration configuration.
- NLP flexibility assessment model to test the operational feasibility of the resulting fixed configuration

In fact, the flexibility assessment analysis provides information about critical parameters that will be added to the multi period design phase in a sequential way to find a new candidate configuration. This methodology allows a significant reduction of the innumerable scenarios that can intervene and therefore enormous reductions of computational efforts while solving smaller optimization problems and therefore it leads progressively over several iterations to select the flexible design with a specific level of confidence.

Each step of the methodology is detailed in a chapter of the manuscript.

The first model adopts the multi period approach to include unavoidable variations that are represented as a series of scenarios of static operating conditions of the processes in the design procedure. The model determines an optimal configuration of the tertiary heat recovery network with best economic and energetic performance with specifications on the type, capacity and temperature of the network. Moreover, the model provides detailed solution on the selection of heat exchangers areas and their location on the process streams to establish the exchange between process streams and the selected network. Furthermore, it investigates hydraulic and geographical aspects and determines the needed pumping power and piping system to be installed between the plants. The model optimizes an economical objective function composed of network investment costs and utility operation costs. The case studies compare configurations obtained with nominal parameters and configurations obtained with specific variations in operating conditions; it shows the effect resulted on the choice of network's temperature, on the interaction between the network and the processes, on the dimensions of heat exchangers and pipes and therefore on the costs involved.

The multi period design detailed in chapter two is potentially suitable for limited number of scenario variation thus highlighting the need for an additional flexibility evaluation of these solutions that will help design choices. This is the subject of Chapter 3 which details the second part of the methodology.

A flexibility assessment step is necessary in order to evaluate the operability of the designed configuration obtained by the multi period design model to cope with additional variations that can occur. In fact, the detailed representation of the design configuration with specification on the location of each heat exchanger and characterizing its type of connection (process-process, process-utility, process-intermediate network) allows an accurate evaluation of the different interactions that may intervene. As shown in the case studies, the NLP model test the ability of the fixed configuration that faces multiple variations at local scale to maintain the outlet temperatures using minimal increase in utilities and therefore the feasibility envelope is identified. In addition, the effect of extending the structure with additional degrees of freedom as structural or operational alternatives on the increase of the feasibility envelope was detailed.

The fourth and final chapter of the thesis consists in applying the two steps of the proposed methodology to a real case study. The aim of this case study is to design a heat recovery transport network that used liquid water to withdraw heat from several processes geographically close and transfer and sell it to nearby district heating systems. The case study has shown the capability of the methodology proposed in this thesis which makes it possible to provide the heat recovery design guaranteeing the operability of the configuration despite variations in heating demand. This point is of great importance, especially when the number variations is important and their inclusion in the design formulation leads to a very conservative design and cannot be solved sometimes.

The methodology can benefit of layers that can be added to the models. The flexibility assessment model can be further extended to include the hydraulic limitations on the piping installation and the needed pumping power. Adding other aspects like geographical and hydraulic issues bring new challenges to assess the tradeoff between flexibility and costs of the networks. The multi period model that uses series of set as periods to represents the variation can be extended by adding thermal storage; in fact, heat storage can be added to the energy balance in temperature interval in order to be able to transfer the heat form a period to another one.



## References

- [1] U. Nations, «World Population Prospects,» 2017.
- [2] G. Zabel, « The Interrelationship between Population Growth and Energy Resources,» *Energy Bulletin*, 20 April 2009.
- [3] E. E. I. Administration, «International Energy outlook 2017,» 2017.
- [4] I. E. Agency, «Energy, Climate Change and environnement,» 2016.
- [5] M. M. El-Halwagi, «Pollution prevention through process integration,» *Clean Products and Processes*, vol. 1, pp. 5-19, 1998.
- [6] «<http://www.symbiosis.dk/en>,» [En ligne].
- [7] J. J. Klemes et Z. Kravanja, «Forty years of Heat Integration: Pinch Analysis (PA) and Mathematical Programming (MP),» *Biotechnology and bioprocess engineering / Process systems engineering*, vol. 2, n° 14, pp. 461-474, 2013.
- [8] M. El-Halwagi, F. Gabriel et D. Harell, «Rigorous Graphical Targeting for Resource Conservation via Material recycle /reuse Networks,» *Ind. Eng. Chem. Res*, vol. 42, pp. 4319-4328, 2003.
- [9] T. Zhelev et N. Bhaw, «Combined water–oxygen pinch analysis for better wastewater treatment management,» *Waste Mngement*, vol. 20, n° 18, pp. 665-670, 2000.
- [10] X. Zhu, «Automated design method for heat exchanger network using block decomposition and heuristic rules,» *Computer and Chemical Engineering*, vol. 21, n° 110, pp. 1095-1104, 1997.
- [11] C. Floudas, A. Ciric et I. Grossman, «Automatic synthesis of optimum heat exchanger network configurations,» *AIChE journal*, vol. 32, n° 12, 1986.
- [12] A. Ciric et C. Floudas, «Heat exchanger network synthesis without decomposition,» *Computers and Chemical Engineering*, vol. 15, n° 16, pp. 385-396, 1991.
- [13] T.F. Yee et I. Grossmann, «Simultaneous optimisation models for heat integration,» *Computer and Chemical Engineering*, vol. 14, n° 110, pp. 1165-1184, 1990.
- [14] A. Barbaro et M. J. Bagajewicz, «New rigorous one-step MILP formulation for heat exchanger network synthesis,» *Computers and Chemical Engineering*, vol. 29, n° 19, pp. 1945-1976, 2005.
- [15] K. C. Furman et N. V. Sahinidis, «A Critical Review and Annotated Bibliography for Heat Exchanger,» *Industrial and Engineering Chemistry Research*, vol. 41, n° 110, pp. 2335-2370, 2002.
- [16] V. R. Dhole et B. Linhoff, «Total site targets for fuel, co-generation, emissions and cooling,» *Computers and Chemical Engineering*, vol. 17, n° 11, pp. S101-S109, 1993.
- [17] J. Klemes, V. Dhole, K. Raissi, S. Perry et L. Puigjaner, «Targeting and design methodology for reduction of fuel, power and CO<sub>2</sub> on total sites,» *Applied Thermal Engineering*, vol. 17, n° 18-10, pp. 993-1003, 1997.
- [18] P. S. Varbanov, Z. Fodor et J. J. Klemes, «Total Site targeting with process specific minimum temperature difference ( $\Delta T_{min}$ ),» *Energy*, vol. 44, n° 11, pp. 20-28, 2012.
- [19] R. Hackl, E. Anderson et S. Harvey, «Targeting for energy efficiency and improved energy collaboration between different companies using total site analysis(TSA),» *Energy*, vol. 36, n° 18, pp. 4609-4615, 2011.
- [20] K. Matsuda, S. Tanaka, M. Endou et T. Liyoshi, «Energy saving study on a large steel plant by total site based pinch technology,» *Applied Thermal Engineering*, vol. 43, pp. 14-19, 2012.
- [21] S. Perry, J. Klemes et I. Bulatov, «Integrating waste and renewable energy to reduce the carbon footprint of locally integrated energy sectors,» *Energy*, vol. 33, pp. 1489-1497, 2008.

- [22] S. Bandyopadhyay, J. Varghese et V. Bansal, «Targeting for cogeneration potential through total site integration,» *Applied Thermal Engineering*, vol. 30, n° %11, pp. 6-14, 2010.
- [23] K. H. Chew, J. J. Klemes, S. R. W. Alwi et Z. A. Manan, «Industrial implementation issues of total site heat integration,» *Applied thermal engineering*, vol. 61, pp. 17-25, 2013.
- [24] K. H. Chew, J. J. Klemes, S. R. W. Alwi, Z. A. Manan et A. P. Reverberi, «Total site heat integration considering pressure drop,» *Energies*, vol. 8, pp. 1114-1137, 2015.
- [25] K. H. Chew, J. j. Klemes, S. W. Alwi et Z. A. Manan, «Process modifications to maximise energy savings in total site heat integration,» *Applied thermal En gineering*, vol. 78, pp. 731-739, 2014.
- [26] V. Linnhoff, «PINCH TECHNOLOGY HAS COME OF AGE.,» 1984.
- [27] K. H. Chew, J. J. Klemes, S. R. W. Alwi et Z. A. Manan, «Process modification of Total Site Heat integration profile for capital cost reduction,» *Applied Thermal Engineering*, vol. 89, pp. 1023-1032, 2015.
- [28] H. Rodera et M. Bagajewicz, «Targeting procedures for energy savings by heat integration across plants,» *AIChE Journal*, vol. 45, n° %18, pp. 1721-1742, 1999.
- [29] M. Bagajewicz et H. Rodera, «Multiple plant heat integration in a Total Site,» *AIChE Journal*, vol. 48, n° %110, pp. 2255-2270, 2002.
- [30] S. Mavromatis et A. Kokossis, «Conceptual optimisation of utility networks for operational variations: 1. Targets and level optimisation,» *Chemical Engineering Science*, vol. 53, n° %18, pp. 1585-1608, 1998.
- [31] Z. Shang et A. Kokossis, «A Transshipment model for the optimisation os steam levels of total site utility system for multiperiod operation,» *Computers and Chemical Engineering*, vol. 28, n° %19, pp. 1673-1688, 2004.
- [32] C. Chang, X. Chen, Y. Wang et X. Feng, «Simultaneous optimization of multi-plant heat integration using intermediate fluid circles,» *Energy*, vol. 121, pp. 306-317, 2017.
- [33] A. Nemet, J. J. Klemes et Z. Kravanja, «Designing a Total Site for an entire lifetime under fluctuating utility prices,» *Computers and Chemical Engineering*, vol. 72, pp. 159-182, 2015.
- [34] A. Z. K. e. K. Alaa Farhat, «Heating and cooling networks design algorithm for site wide energy integration,» 2015.
- [35] T. Yee et I. Grossman, «Simultaneous optimization models for heat integration-2. Heat exchanger network synthesis,» *Computers and Chemical Engineering*, vol. 14, n° %110, pp. 1165-1184, 1990.
- [36] K. Halemane et I. Grossmann, «Optimal Process Design under Uncertainty,» *AIChE Journal*, vol. 29, n° %13, pp. 425-433, 1983.
- [37] R. E. Swaney et I. E. Grossmann, «An index for operational flexibility in chemical process design. Part I: Formulation and theory,» *AIChE Journal*, vol. 31, n° %14, pp. 621-630, 1985.
- [38] I. Grossman et C. Floudas, «Active constraint strategy for flexibilty analysis in chemical processes,» *Computer and Chemical Engineering*, vol. 11, n° %16, pp. 675-693, 1987.
- [39] V. D. Dimitriadis et E. N. Pistikopoulos, «Flexibility Analysis of Dynamic Systems,» *Industrial & Engineering Chemistry Research*, vol. 34, n° %112, pp. 4451-4462, 1995.
- [40] E.N.Pistikopoulos et T.A.Mazzuchi, «A novel flexibility analysis approach for processes with stochastic parameters,» *Computers & Chemical Engineering*, vol. 14, n° %19, pp. 991-1000, 1990.
- [41] Q. Zhang, I. E. Grossmann et R. M. Lima, «On the Relation Between Flexibility Analysis and Robust Optimization for Linear Systems,» *AIChE Journal*, vol. 62, n° %19, pp. 3109-3123, 2016.
- [42] I. E. Grossmann, R. M. Apap, B. A. Calfa, P. Garcia-Herreros et Q. Zhang, «Recent advances in mathematical programming techniques for the optimization of process system under uncertainty,» *Computers and Chemical Engineering*, vol. 91, pp. 3-14, 2016.

- [43] Z. N. Pintaric et Z. Kravanja, «A strategy for MINLP synthesis of flexible and operable processes,» *Computers and Chemical Engineering*, vol. 28, pp. 1005-119, 2004.
- [44] P. A. Bahri, J. A. Bandoni et J. A. Romagnoli, «Integrated flexibility and controllability analysis in design of chemical processes,» *AIChE Journal*, vol. 43, n° 14, 2004.
- [45] P. A. Bahri, J. A. Bandoni et J. A. Romagnoli, «Effect of disturbances in optimizing control: Steady State Open-loop Backoff Problem,» *AIChE Journal*, vol. 42, n° 14, pp. 983-994, 1996.
- [46] M. Mohideen, J. Perkins et E. Pistikopoulos, «Optimal synthesis and design of dynamic systems under uncertainty,» *Computers and Chemical Engineering*, vol. 20, pp. S895-S900, 1996.
- [47] D. Marselle, M. Morari et D. F. Rudd, «Design of resilient processing plants-2 Design and control energy management systems,» *Chemical Engineering Science*, vol. 37, n° 12, pp. 259-270, 1982.
- [48] C. A. Floudas et I. E. Grossmann, «Synthesis of flexible heat exchanger networks for multiperiod operation,» *Computers and Chemical Engineering*, vol. 10, n° 12, pp. 153-168, 1982.
- [49] C. A. Floudas et I. E. Grossmann, «Automatic generation of multiperiod heat exchanger network configurations,» *Computers & Chemical Engineering*, vol. 11, n° 12, pp. 123-142, 1987.
- [50] C. A. Floudas et I. E. Grossmann, «Synthesis of flexible heat exchanger networks with uncertain flowrates and temperatures,» *Computers & Chemical Engineering*, vol. 11, n° 14, pp. 319-336, 1987.
- [51] J. Aaltola, «Simultaneous synthesis of flexible heat exchanger network,» *Applied Thermal Engineering*, vol. 22, pp. 907-918, 2002.
- [52] W. Verheyen et N. Zhang, «Design of flexible heat exchanger network for multi period operation,» *Chemical Engineering Science*, vol. 61, pp. 7730-7753, 2006.
- [53] C. L. Chen et P. S. Hung, «Simultaneous synthesis of flexible heat exchange networks,» *Industrial and Chemical Engineering*, vol. 43, n° 118, pp. 5916-5928, 2004.
- [54] P. Y. Liew, S. R. W. Alwi, P. S. Varbanov, Z. A. Manan et J. J. Klemes, «A numerical technique for total site sensitivity analysis,» *Applied Thermal Engineering*, vol. 40, pp. 397-408, 2011.
- [55] P. Y. Liew, S. R. W. Alwi, P. S. Varbanov et J. J. Klemes, «Centralised utility system planning for a total site heat integration network,» *Computers and Chemical Engineering*, vol. 57, pp. 104-111, 2013.
- [56] P. S. Varbanov et J. J. Klemes, «Integration and management of renewables into Total Sites with variable supply and demand,» *Computers and Chemical Engineering*, vol. 35, n° 19, pp. 1815-1826, 2011.
- [57] F. Marechal et B. Kaliventzeff, «Targeting the integration of multi-period utility systems for site scale process integration,» *Applied Thermal Engineering*, vol. 23, n° 114, pp. 1763-1784, 2003.
- [58] M. Nayyar, *Piping Handbook*, MCGRAW-HILL, 2000.
- [59] K. H. Chew, J. J. Klemes, S. W. Alwi et Z. A. Manan, «Process modifications to maximise energy savings in total site heat integration,» *Applied Thermal Engineering*, vol. 78, pp. 731-739, 2014.
- [60] C. J.J.J., «Comments on improvements on a replacement for the logarithmic mean,» 1987.
- [61] W. Verheyen et N. Zhang, «Design of flexible heat exchanger network for multi-period operation,» *Chemical Engineering Science*, vol. 61, n° 123, pp. 7730-7753, 2006.
- [62] W. Paterson, «A replacement for the logarithmic mean, shorter,» *Chemical Engineering Science*, vol. 39, n° 111, pp. 1635-1636, 1984.
- [63] C. Chang, Y. Wang et X. Feng, «Indirect heat integration across plants using hot water circles,» *Chinese Journal of Chemical Engineering*, vol. 23, n° 16, pp. 992-997, 2015.
- [64] A. Chauvel, G. Fournier et C. Raimbault, *Manuel d'évaluation économique des procédés*, TECHNIP, 2001.



## RÉSUMÉ

---

L'intégration énergétique est un moyen puissant pour améliorer l'efficacité énergétique dans l'industrie. La récupération de chaleur a été étendue de l'échelle locale d'un procédé à l'échelle territoriale, comportant plusieurs procédés formant des éco parcs industriels, permettant d'atteindre une haute efficacité énergétique. De nombreuses méthodes et outils ont été développés pour identifier le potentiel de récupération de chaleur et la configuration optimale du réseau de transfert de chaleur comme solution pour l'intégration énergétique aux deux échelles. Les fluctuations des conditions opératoires, telles que les températures d'entrée et de sortie, ainsi que les débits par rapport à leurs valeurs nominales sont inévitables. Par conséquent, les problèmes d'opérabilité sont importants et doivent être considérés dans les méthodologies de conception et l'évaluation de la flexibilité devient un pré requis essentiel dès la conception pour mieux prendre en compte les fluctuations et les perturbations dans les réseaux de synergie énergétique. Le présent travail propose une méthodologie séquentielle de deux étapes basée sur deux modèles d'optimisation mathématique afin d'éviter l'inclusion d'un grand nombre de conditions opératoires directement dans une seule formulation et qui conduit progressivement à une conception flexible avec un certain niveau de confiance en un temps de calcul efficace. Au cours de la première étape, une topologie fixe est générée à l'aide d'un modèle MILP multi-périodes fournissant une solution détaillée du réseau de récupération, la sélection des zones d'échangeurs de chaleur et l'installation de la tuyauterie, tout en prenant en compte un nombre fini de scénarios de variations. Ensuite, un modèle non linéaire d'évaluation de la flexibilité est utilisé pour tester la faisabilité opérationnelle du réseau fixe face à des variations supplémentaires qui se produisent à l'échelle locale et territoriale, tout en envisageant des degrés de liberté opérationnelles pour garantir l'opérabilité. Les informations fournies sont utilisées pour déterminer les points critiques à ajouter à la phase de conception multi-périodes pour rechercher un nouveau réseau candidat. Chaque modèle et la méthodologie sont validés par des cas d'études.

## MOTS CLÉS

---

Intégration énergétique, Eco parc industriel, Evaluation de la flexibilité. Approche multi période  
Optimisation

## ABSTRACT

---

One powerful way to improve energy efficiency in industry is through Heat Integration. The heat recovery application was extended from process level to multiple processes in eco-industrial parks offering important energy efficiency improvements. Many methodologies and tools have been developed to identify the potential heat recovery and the optimal heat transfer network design as heat integration solution at both scales. Nevertheless, deviations of operating conditions such as supply and target temperatures and flow rates from nominal values are unavoidable, thus the operability issues are of vital importance to be considered in design methodologies and the flexibility assessment become an essential prerequisite of the heat transfer configuration in order to better take into account fluctuations and disturbances in the energy synergy networks. The present work propose an iterative two steps methodology based on two mathematical optimization models to prevent the inclusion of a large number of variability directly in one design formulation and leads progressively to a flexible design with a certain level of confidence in an efficient computation time. During the first step, a fixed topology is generated using multi period MILP model providing detailed solution on the recovery network, selection of heat exchangers areas and piping installation while considering a finite number of operating scenarios. Then a flexibility assessment NLP model is used to test the operational feasibility of the resulting fixed network for additional variations that occur at local and territorial scale while considering operational degrees of freedom to ensure feasible operation. The information provided is used to determine the critical points for flexibility to be added to the multi period design phase to find a new candidate network. Each model and the whole methodology are validated with case studies.

## KEYWORDS

---

Heat integration, Eco industrial park, Flexibility Assessment, Multi-period approach, Optimization