



HAL
open science

Systèmes constructifs en fabrication additive de matériaux cimentaires

Romain Duballet

► **To cite this version:**

Romain Duballet. Systèmes constructifs en fabrication additive de matériaux cimentaires. Génie civil. Université Paris-Est, 2019. Français. NNT : 2019PESC1011 . tel-02489996v1

HAL Id: tel-02489996

<https://pastel.hal.science/tel-02489996v1>

Submitted on 24 Feb 2020 (v1), last revised 25 Feb 2020 (v2)

HAL is a multi-disciplinary open access archive for the deposit and dissemination of scientific research documents, whether they are published or not. The documents may come from teaching and research institutions in France or abroad, or from public or private research centers.

L'archive ouverte pluridisciplinaire **HAL**, est destinée au dépôt et à la diffusion de documents scientifiques de niveau recherche, publiés ou non, émanant des établissements d'enseignement et de recherche français ou étrangers, des laboratoires publics ou privés.

Laboratoire Navier
Ecole Nationale des Ponts et Chaussées
CNRS, IFSTTAR

Building systems in robotic extrusion of cementitious materials

Romain Duballet

Supervisors:

Olivier Baverel, Justin Dirrenberger

Rapporteurs:

Antonella Mastroilli, Theo Salet

Examiners:

Jean-Francois Caron, Arnaud
Delaplace, John Orr, Arnaud Perrot

September 2019

Abstract

This work deals with a novel field of investigation for civil engineering and building industry called large scale 3D printing, or additive manufacturing, of cementitious materials. It makes use of robotic devices to progressively bring a fresh concrete or mortar into a desired shape, without using traditional formworks. The main associated ambitions are productivity and sustainability, achieved through automation and geometric complexity.

Many approaches are able to succeed in correctly shaping a cementitious matter in space and ensuring its final characteristics. Among them a recent one can be called robotic extrusion, on which the present work focuses. It consist in pumping and depositing a fresh mortar, or fine concrete, relying on its early age structuration rather than on the shaping abilities of a formwork. If the physical and rheological phenomena at stake begin to be understood, there is no clear knowledge of a specific strategy yet, and many strategies are developed in parallel by the community. The first part of this work presents those, and aims at providing sufficiently distinctive definitions, see chapter 2. Three idealized approaches are proposed, differing in the history of solicitations and structuration for the printed material.

Beyond the rheology oriented approach, this work seeks to broaden the scope of concrete printing and shift the discussion from materials to final building systems. Indeed, not only a construction product often includes more than just concrete, but the printing itself can be generalized to a more complete understanding. This is the ambition of a proposed classification system, presented in chapter 3.

Illustrating the notion of generalized printing, a novel process is proposed in chapters 4 and 5. It makes use of a combination of robotic extrusion and assembly of masonry elements in insulating foam to fabricate space truss structures of improved performances.

Acknowledgements

I would like to thank the whole Navier laboratory to have kindly welcomed me for these three amazing years of conjoint work, particularly my supervisors, Olivier Baverel and Justin Dirrenberger, for their patience, kindness and advice, and also Marie-Françoise Kaspi, Jean-François Caron and Romain Mesnil, thanks to whom all of this was made possible.

I thank also Vivien Esnault and François de Larrard at LafargeHolcim Research and Development for fruitful discussions. Support from LafargeHolcim is gratefully acknowledged.

Many thanks to Antonella Mastrorilli, Theo Salet, Arnaud Delaplace, John Orr and Arnaud Perrot for accepting to be members of this thesis committee.

A special thank to my printing colleagues, Nicolas Ducoulombiers, Paul Carneau and Leo Demont, who have shared precious thoughts, hard work and laughs during this creative period.

To Hocine Delmi, Gilles Moreau and Christophe Bernard, thank you very much for your help and crucial advice, I learned a lot from working with you.

I thank also my colleagues at XtreeE with whom I started this adventure.

And last but not least I would like to thank my parents and my sister for their love and support throughout all these years.

Contents

Abstract	i
Acknowledgements	iii
1 Introduction	1
2 Additive manufacturing of cementitious materials	5
2.1 Definition and state of the art	5
2.2 Robotic extrusion of cementitious materials	8
2.2.1 Slip forming	12
2.2.2 Extruded lace shaping	14
2.2.3 Oriented lace pressing	17
2.3 Printing process and building systems	21
2.3.1 Technological aspects	21
2.3.2 Industrial aspect	25
2.3.3 Normative context	26

3	Classification of building systems in robotic extrusion of cementitious materials	30
3.1	Key assumptions	36
3.2	Classification	38
3.2.1	Main parameters	38
3.2.2	Additional parameters	43
3.3	Cartography	48
3.3.1	Scale variations of parameters e , a , and s	48
3.3.2	Variation of the r parameter	49
3.3.3	Impossible eas combinations	49
3.3.4	Parameter r	52
3.3.5	Linking main parameters to parameter r	54
3.3.6	Conclusion	55
4	Space truss masonry walls in robotic extrusion	57
4.1	Generalized printing process	57
4.1.1	Process description	57
4.2	Unreinforced confined masonry	60
4.3	Grid comparison	62
4.4	Case studies	68
4.4.1	Single house separating wall	68
4.4.2	Single house shear wall and multi-storey loading	70

4.5	Perspectives: curvature	72
4.5.1	Curved structures	72
4.5.2	Roofing	73
5	Space truss prototyping	74
5.1	Insulating blocks	74
5.1.1	Material Choice	74
5.1.2	Hot wire cutting of polystyrene	75
5.1.3	Cutting algorithm	80
5.2	Mortar extrusion	84
5.2.1	Material aspects	84
5.2.2	Printing strategies	85
5.2.3	Prototyping	88
5.3	Discussion	97
6	Conclusion and perspectives	103
6.1	Generalized printing	103
6.2	Perspectives	107
6.2.1	Printing on surface supports	107
6.2.2	Printing on complex supports	108
6.2.3	Precision	110
	Bibliography	110

List of Tables

3.1	Variation of assembly parameter a	40
3.2	Variation of support parameter s	42
4.1	Grid Types	63
4.2	Comparison with other systems	70

List of Figures

1.1	Underground inspection pit (XtreeE, 2017). Photography by Anthony Micallef .	4
2.1	Principle of building systems using contour crafting, published in [40]	6
2.2	Drawings of a powder bed printing process published in [63]	7
2.3	Doubly curved stiffened printed wall published in [31]	11
2.4	Smart dynamic casting process, published in [50]	13
2.5	Column extrusion by slip forming, published in [50]	14
2.6	Concept of a rotating nozzle to avoid twisting of rectangle laces, published in [9]	16
2.7	Cantilevering layers of extruded filament, published in [9]	17
2.8	Oriented lace pressing	18
2.9	An oriented lace pressing two phase system published in [31]. 0. System command; 1. Robot controller; 2. Printing controller; 3. Robotic arm; 4. Printing head; 5. Accelerating agent; 6. Peristaltic pump for accelerator; 7. Peristaltic pump for mortar; 8. Premix mixer; 9. 3D printed object	19
2.10	Layer orientation by the so-called tangential continuity method, published in [31]	20
2.11	Building system for towers and columns with a polar extrusion process, published in [41]	23

2.12	TU Eindhoven Bicycle bridge, published in [10]	27
2.13	Pillar in Aix-en-Provence, XtreeE, 2017	28
3.1	Flat wall (Democrite project, 2015)	31
3.2	Externally reinforced beam (WASP, 2015)	32
3.3	Externally reinforced beam, published in [5]	32
3.4	Mould for a space truss (XtreeE, 2016)	33
3.5	Printed pillar in Aix-en-Provence (XtreeE, 2016)	34
3.6	Variation of external support parameter. (a) No support ; (b) Flat support ; (c) Curved support ; (d) Multiple supports ; (e) Assembled supports	35
3.7	Possible combinations of assembly parameters	41
3.8	Possible combinations of support parameters	42
3.9	Scale variations of parameters e , a , and s	50
3.10	Possible eas combinations	51
3.11	Variation of the r parameter : minimum required complexity	56
4.1	Printing mortar while assembling blocks	58
4.2	Insulating blocks geometry and internal space for the mortar	59
4.3	Light space truss and traditional breeze-blocks mortar structures	60
4.4	Five grid topologies	63
4.5	Pareto fronts comparison, Counter running triangle tessellation	64
4.6	Pareto fronts comparison, Octahedra and tetrahedra tessellation	65
4.7	Pareto fronts comparison, Triangle prisms tessellation	66

4.8	Pareto fronts comparison, Semi-octahedra and tetrahedra tessellation	67
4.9	Ten best individuals weight / overall thickness	68
4.10	Single house separating wall	69
4.11	Shear wall analysis	71
4.12	Multi-storey load bearing wall	71
4.13	Curved wall analysis	72
4.14	Tessellation of a circular mesh	73
5.1	Hot wire cutting of insulating blocks	77
5.2	Cutting paths principle for the insulating blocs. Starting at the top of the roughly cut initial bloc, going below to allow the unused parts to fall down, then shaping the final form of the extruded part and the channels	81
5.3	Studies in recursive lattice, EZCT Architecture and Design Research, Exhibition Archilab, FRAC Centre Orléans 2013	86
5.4	The four printing strategies (a) Slip forming, (b) Extruded shaping, (c) Oriented pressing and (d) Free depositing	89
5.5	Top view of the macroscopic layer for truss printing. (a) Horizontal channels are filled ; (b) Tetrahedra are placed ; (c) Non-horizontal channels are filled	91
5.6	3D view of step (a) : Horizontal channels filling	92
5.7	3D view of step (b) : Semi octahedra placement	93
5.8	3D view of step (c) : Non-horizontal channels filling	94
5.9	Horizontal channels path	95
5.10	Non-horizontal channels paths	96

5.11	Uphill (a) and downhill (b) deposition regimes	98
5.12	EPS blocks forming channels	99
5.13	Printed mortar truss prototype with EPS blocks removed	100
5.14	Truss prototype with cavities for confining frame	101
6.1	Chantier de construction électrique (Electrical construction site), Chromolithography, Villemard, BnF, Paris, 1910	106
6.2	Process of constructing concrete buildings, published in [25]	106
6.3	Contour printed and assembled shell, published in [18]	108
6.4	Trumpf bridge, Arch. Barkow Leibinger, Ing. Schlaich Bergermann, 2018	109
6.5	An "optimal concrete bridge" from Ghent university	109

Chapter 1

Introduction

Construction industry gathers some of the greatest challenges of our century. Planet wide population growth in the near future raises huge needs in affordable housing [22] as well as in infrastructures [56]. Contrary to other industrial fields, construction did not experience a tremendous productivity boom in the past decades [33, 35]. However, global concrete and cement consumption have jumped, mainly due to emerging countries [93, 36]. Today, concrete is the most used synthetic material on earth. Total concrete consumption represent more than twice the total of other building materials, namely wood [76], steel [101], plastic [29], and aluminum [92]. All of this makes construction responsible for 23 percent of global carbon dioxide emissions [36].

One can think of three levers to act on this. First materials, to reduce environmental impact of their making [53, 98], second building elements, to build more performing products with less material consumption [2, 60], and third global ecosystems, e.g. to reduce transport, faulty work and promote recycling and reuse. If mortars and concretes are so broadly chosen as building materials, it is related to their relatively low cost, good durability and great versatility [94]. They are related to efficient building systems, ensuring their relevance for productivity demands [93]. Concrete, which is the mix of aggregates, water and cement, is therefore more of a principle than an essence. Other materials with lower environmental impact and similar application potentialities are developed today, for example geopolymers [61, 75, 68, 67]. Concrete itself has

also seen its carbon footprint greatly decreased while improving mechanical performances over the past century, and we can reasonably expect this tendency to go on [93].

After acting directly on material composition, new building elements can be designed to reduced overall consumption through geometry. There seem to be a global understanding that this will be the major contribution from the digital to the building industry [2, 60]. Automation and robotics will be used to create ultralight structures of complex geometry, impossible to make with traditional manufacturing methods at a reasonable cost. This geometric question concerns the whole building as well as its elements. Mass customization, a notion associated with digital fabrication, is thought to be able to bring precise differentiation and global optimization in structural conception [37, 62, 102]. Yet, productivity and environmental impact are far from being only a problem of shape. The whole construction ecosystem has to be addressed, and with it the political and economical contexts. Resources, transports, methods, life span, recycling and reuse are the key words of today's discussion on the future of construction.

This work addresses a particular topic of automation in construction called 3D concrete printing, or additive manufacturing of cementitious materials, or digital concrete [96]. It proposes new manufacturing techniques, other than casting or projection, making use of programmed robots to progressively bring the material where it needs to be, without traditional moulds. The associated promises are thus waste reduction, speed and versatility [40, 9]. More precisely we focus on extrusion techniques, they are inspired from a rapid prototyping approach called fused deposition modeling [55] that consists in stacking laces of fresh mortar onto each other to form a three dimensional object.

With such a technique, it is possible to "print" the walls of a house inside a gantry structure. This is the main idea proposed today, with promises of productivity, speed and labor cost reduction [40]. This gained popularity in the past few years, businesses and academic projects were born all over the world, research being mostly focused on rheology and mortar formulation. The question of actual usage of such techniques is rarely placed at the center of discussion, whereas it is not clear yet how they will penetrate the market, and more importantly which among the many possible printing processes are more suited to be associated with complete building

systems.

The house printing idea is a direct and metaphoric transposition of the rapid prototyping method to a larger scale. With the current strategies, involving materials with high cement content, printing a single house in the form of straight or slightly curved walls can be seen as an environmental absurdity. To become a real solution to current housing issues, concrete printing has to bring significant innovation. It is not yet clear if productivity increase will be sufficient to do so. However, if new building products, of novel performances, could be made at a reasonable cost with such techniques, they could become a substantial addition to the building industry. The two courses of action are again material composition and geometry. Provided a very "poor" material is printable, massive straight wall houses can become competitive. Otherwise, material consumption can be decreased by printing walls with a complex and light internal structure. In chapter 4 we have proposed a potential solution to make lighter space structures for single house walls.

Apart from housing, the other main fields of application for building systems with robotic extrusion are infrastructures and public works. Some bridges have already been built, see for example figure 2.12. Specific underground structures have also been printed and installed in France, see figure 1.1 below. For those sectors, complex geometrical context and specificity of prefabricated objects can account for 3D printing perhaps more easily than for housing. Surface finish and second work can indeed become less crucial, while productivity gains can be easily obtained.

Aesthetics is also a key aspect of digital fabrication techniques because they can produce complex geometry and patterning at a very reasonable cost. Furniture have already been designed and manufactured with robotic extrusion techniques, as well as architectural elements (see figure 2.13). We can hope for a renewal of ornament in architecture, and not necessarily limited to luxury projects [2, 103].

This work is divided in four chapters, and goes from theoretical to experimental. In chapter 2 we try to circumscribe our topic, namely robotic extrusion for automation in construction, through a state of the art report and some definition attempts. Many strategies are indeed



Figure 1.1: Underground inspection pit (XtreeE, 2017). Photography by Anthony Micallef

possible to print cementitious materials, and can greatly differ in terms of physical phenomena at stake in the material, or technology. This brings us to the subsequent question of actual building systems based on such printing processes. In chapter 3 we propose a classification method, to explore some possible approaches. The goal of this work is to shift the current discussion from the "house printing" approach to a generalized understanding of automated building systems with cementitious extrusion.

Chapters 4 and 5 are dedicated to a specific building system based on robotic mortar extrusion. It is based on the simultaneous assembly of insulating material used as a support for the mortar. In chapter 4 we show how it could be used in a masonry context to significantly reduce material consumption, while chapter 5 focuses on prototyping.

Chapter 2

Additive manufacturing of cementitious materials

2.1 Definition and state of the art

In 1997, Josef Pegna famously stated that the construction industry would be transformed by automation in the sense that “material handling and assemblies” would be “reduced to a large number of identical simple operations” [64]. To him it was a step toward what he called “solid freeform construction”, and was remarkably described as “a new approach to masonry”. Surely the idea had been taken from the field of rapid prototyping, also denoted by 3D printing, whose initial concern was the fast and automated manufacturing of industrial objects. However, we can observe in his paper a conceptual concern about transferring those technologies to a larger scale. He seems to avoid as much as possible the metaphor of the “printer”, and tries to work with explicit definitions of what would become such automated processes in the construction field. Only his “freeform” remains quite unclear, as he does not define completely the freedom it refers to.

During the following decades a new field of study was born, firstly named “contour crafting” by one of its first protagonists, Behrokh Khoshnevis [4, 40, 42, 43], see figure 2.1 and then generalized to what we call today “concrete printing”. It denotes a set of various processes the

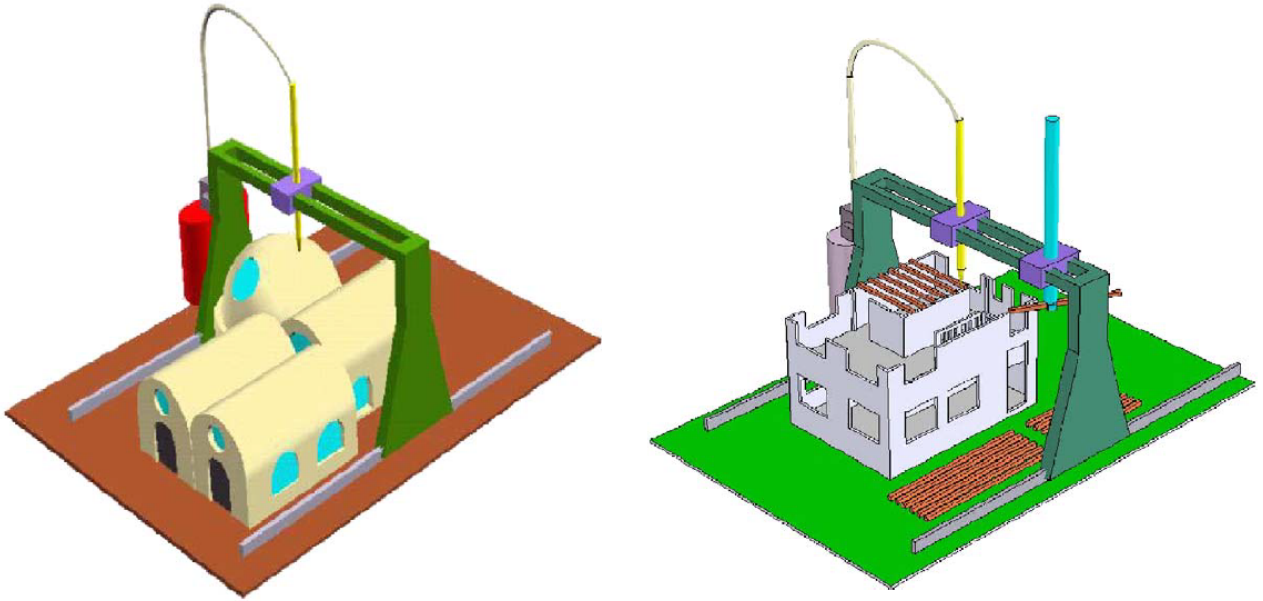


Figure 2.1: Principle of building systems using contour crafting, published in [40]

purpose of which is to progressively bring a cementitious material, often paste or mortar, into a desired position in such a way that a given shape is built. In general, this is called additive manufacturing, opposed to subtractive manufacturing, like the carving of a raw material, or formative manufacturing, like metal bending. It can be noted that cementitious materials like concrete have almost exclusively been associated with additive manufacturing. Indeed, the two main processes today are cast concrete, in a volumetric mould, and projected concrete, on a surface. The difference brought here is mainly automation, but also a novel way of making use of supports, or of no support, for the fresh concrete. Progressiveness of the approach also seems to be a key element, in the sense that newly added material makes use of already deposited material as a support, while it is still in transient state.

Additive manufacturing of cementitious materials, if we circumscribe the definition to exclude the casting in one go, can therefore be split in four main categories: Progressive casting, Projection, Extrusion and Powder-bed printing. Powder-bed printing is the other, after extrusion, new field of investigation. Already mentioned in Pegna's paper, with some traces of experimentation ([64, 63]), see figure 2.2, it has been renewed by E. Dini who founded D-shape¹. Some recent studies on this process can be found in [52]. The present work solely focuses on robotic

¹<https://d-shape.com/>

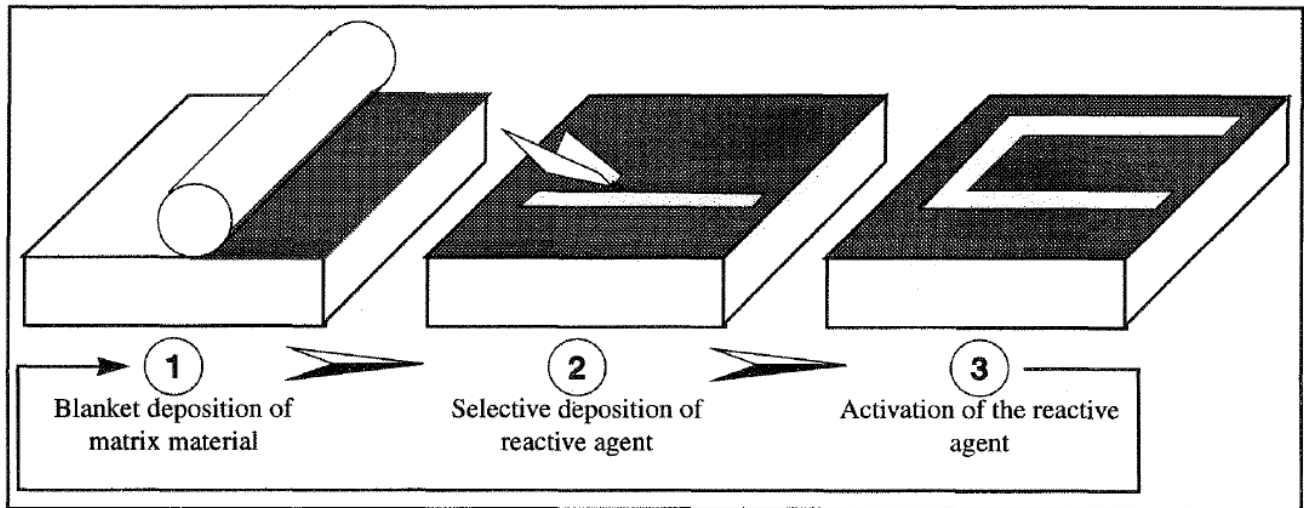


Figure 2.2: Drawings of a powder bed printing process published in [63]

extrusion, therefore we will not mention powder-bed printing in what follows.

The first peer-reviewed works concerning robotic extrusion of concrete after Khoshnevis focused on the associated fabrication processes [48, 49, 31], concrete formulation [46, 47, 27] or robotic control [13]. Starting around 2014, several concrete printing companies (XtreeE², CyBe³, Bruil⁴, Cobod⁵, Total Kustom⁶, ApisCor⁷, WinSun⁸) were born around the world, and the idea started to grow in the media. Many announcements were made, claiming various achievements, mostly about productivity and cost reduction results. Very few of them were associated with any evidence or details. The buzz had however a positive aspect because it certainly helped launching research projects all over the world. Today the field is growing fast, but also seems to get quite limited in its ambitions. If the printing process itself varies, while being mostly mortar extrusion, its interests are often reduced to speed and ease of fabricating nearly traditional constructive elements. Design freedom remains, except for marginal and recent work, mostly understood as the ability to produce arbitrary curved geometries. Our position is that this technology will only be of interest if it can bring novelty in building performances. As far as concrete industry is concerned, one of the main goals today certainly is

²<https://www.xtreee.eu/>

³<https://cybe.eu/>

⁴<https://www.bruil.nl/3dprinten>

⁵<http://cobod.com/>

⁶<http://www.totalkustom.com/>

⁷<https://www.apis-cor.com/>

⁸<http://www.winsun3d.com/En/About/>

the reduction of overall cement consumption [60, 2].

2.2 Robotic extrusion of cementitious materials

As mentioned above, this work focuses only on extrusion. In this section, we try to define as precisely as possible what is meant by this term as a printing process.

Robotic extrusion of cementitious material as a printing process consists in pumping the material to a moving nozzle, the shape and scale of which will dictate the type of considered approach. The nozzle can be any tubular system, the pumped material comes from one side and is extruded at the other side. The key aspect that defines this approach as printing is progressiveness. While the nozzle is moving, the deposited material remains unsupported, at least not as much supported as in a traditional mould. That means it is supposed to exhibit early age mechanical properties, to support its own weight, and/or the weight of additional material brought onto it, without changing shape.

Progressive filling of formworks are excluded from our discussion. Some recent studies on that matter are yet worth mentioning, because they can be viewed as "digital" approaches. It is indeed possible to print a form-work while pouring fresh self compacting concrete inside. Progressiveness here allows for the concrete to gain early age structural buildup and reduce hydrostatic pressure on the mould, that can therefore be lighter than a traditional formwork. Some experiments have been conducted to print columns mould in polymers and house walls moulds in insulating foam [30]. The Mesh-mould approach [34] can also be seen as progressive filling in the sense that the concrete is cast in an open metal grid and fresh state structural properties are needed to prevent its flowing out the grid holes.

In this section we will describe, after some general concerns, three idealized approaches for extrusion based concrete printing. We have called them Slip forming 2.2.1, Extruded Lace Shaping 2.2.2 and Oriented Lace Pressing 2.2.3. Real processes can be in between those strategies, but in order to explain the main principles, physical phenomena and challenges, such simplification is advisable.

Early age structuration

Before having reached a sufficient level of cement particles hydration to become a fragile solid, a threshold called setting, fresh concrete can be seen as a pseudo-solid. Under a critical shear stress value, called yield stress, it behaves as a solid and can be well described by elasto-plasticity [82, 79]. At the contrary, when applied shear stress is higher, fresh concrete and mortars have a visco-plastic behaviour. At early age then, concretes belong to the family of yield stress fluids, the rheological behaviour of which are most often described with Bingham models [80, 82, 79, 8, 32]. This characteristic makes concrete particularly suitable for additive manufacturing. Two parameters are crucial here, yield stress and elastic modulus, both time dependent as they increase with cement hydration. They also strongly depend on the shear history of the material, its pumping, flowing and resting periods [69, 71, 65, 59].

A particular physical phenomenon occurs in fresh cementitious materials at a macroscopic scale, responsible for an increase in yield stress and elastic modulus when the material is at rest, called thixotropy. This is a reversible process, the material losing its structural properties when shear stresses are applied again. With time, the structural build-up increases and reversibility potential diminishes. This phenomenon has been shown [82, 79] to originate from colloidal interaction between cement particles, called flocculation, at a very early age, and from the initial nucleation of hydrates forming stronger local interactions [82, 79]. These interactions are easily broken at early age, and reversibility of the structuration at macroscopic level depends on the sufficiency of chemical reservoir in the mix. Thixotropy plays a very important role in early age structural build up for the printed material [77, 70, 58].

Before deposition, the material has to be pumped. Various strategies can be used to control pumping pressures and applied shear stresses in the flowing material, depending on its initial properties and characteristic sizes of the pump, they are detailed in the present section.

Structural build up challenges in concrete printing have been shown [99, 77] to be linked to yield stress and elastic modulus in the form of two main failure modes. The first one occurs when the yield stress of the bottom part of the fresh concrete structure is reached, typically

due to the weight of subsequently deposited material on top of it. In that case the material cannot keep its shape and flows, bringing down the whole structure it supported. The second mode of failure is buckling. It strongly depends on the printed geometry. A critical height can be defined in some cases [79], depending on slenderness, second quadratic moment of inertia and elastic modulus. This phenomenon has been recently modelled in [99, 87]. The typical 3D printed wall with two straight sides and an internal curved stiffener originates from buckling requirements. Doubly curved stiffener has been used in [31] to reduce thermal conductivity of the wall while keeping punctual contacts between the sides to reduce buckling lengths, see figure 2.3.

Extrusion scale distinction

Depending on the specific process, three approaches are detailed in 2.2.1, 2.2.2 and 2.2.3, a variety of scale parameters are crucial to the printing because they will impact the feasibility and potentiality of the process as well as technological and material requirements.

The nozzle scale is of primary importance. Depending on the material typical granular sizes and global extrusion strategy, the specific shape of the nozzle can have a great impact (polygonal or circular, slender section, change of diameter at the end [69, 71, 59, 65, 39, 66]). In the next section we detail how the three presented approaches have a different dependency on nozzle shape.

The overall dimensions of the object are of course critical, in relation to the nozzle size. In the case of layered extrusion, layer thickness will also be a crucial parameter [31, 77, 70, 58, 79].

Different typical times and speeds are related to these scale parameters. The mortar flow rate and the nozzle speed primarily concern the extrusion. The rising speed of the object will impact the structural build up strategy. In the case of layered printing, the time between layers is a critical parameter to ensure material homogeneity [79, 54, 47, 49, 17, 69, 99, 39, 26].



Figure 2.3: Doubly curved stiffened printed wall published in [31]

2.2.1 Slip forming

Automated cementitious extrusion has been used in construction industry for decades with slip forming. It basically consists in having a traditional concrete formwork, but opened at the top and bottom, therefore tubular, vertically moving, so that a wall is progressively formed. The speed of such a process corresponds to concrete setting, so that the extruded walls can rapidly bear the extrusion structure themselves, typically a few meters per day. This building system has mainly been used for high rise building of regular floor plan. Its main advantage is productivity and it is not compatible as is with the geometric complexity promise of the digital era.

Recent studies have been conducted on the understanding of the physical phenomena at stake in the slip-formed concrete [19]. Notably, a renewal of such systems has been developed under the name of Smart Dynamic Casting [50, 88, 85, 84]. The key idea is to scale down the system from high rise buildings to constructive components, while providing more geometrical freedom to the extrusion nozzle. That way, near vertical elements can be easily fabricated, each nozzle system, with its varying shapes, corresponds to a family of objects, columns, walls etc, see figures 2.4 and 2.5.

In such a system, the nozzle has a nearly vertical displacement and moves at a speed comparable to the structural build up of the concrete. More precisely the nozzle speed equals the object raising speed. At the contrary in layered approaches (see 2.2.2 and 2.2.3) the nozzle speed is far higher and relates to the raising speed depending on inter-layer time and layer thickness.

In the case of slip-forming, the (eventual) pumping is decorrelated from the extrusion in the sense that concrete flow only relies on gravity. This imposes a minimum size for the nozzle so that gravitational forces are not overtaken by friction on the edges, in the absence of lubrication method and depending on the typical granular sizes of the material. Relatively slow nozzle speed allow for real time control of the material and eventual adjustments, reportedly hydration control has been used in [84].

Of the three approaches mentioned here, slip forming is the one where the nozzle technology

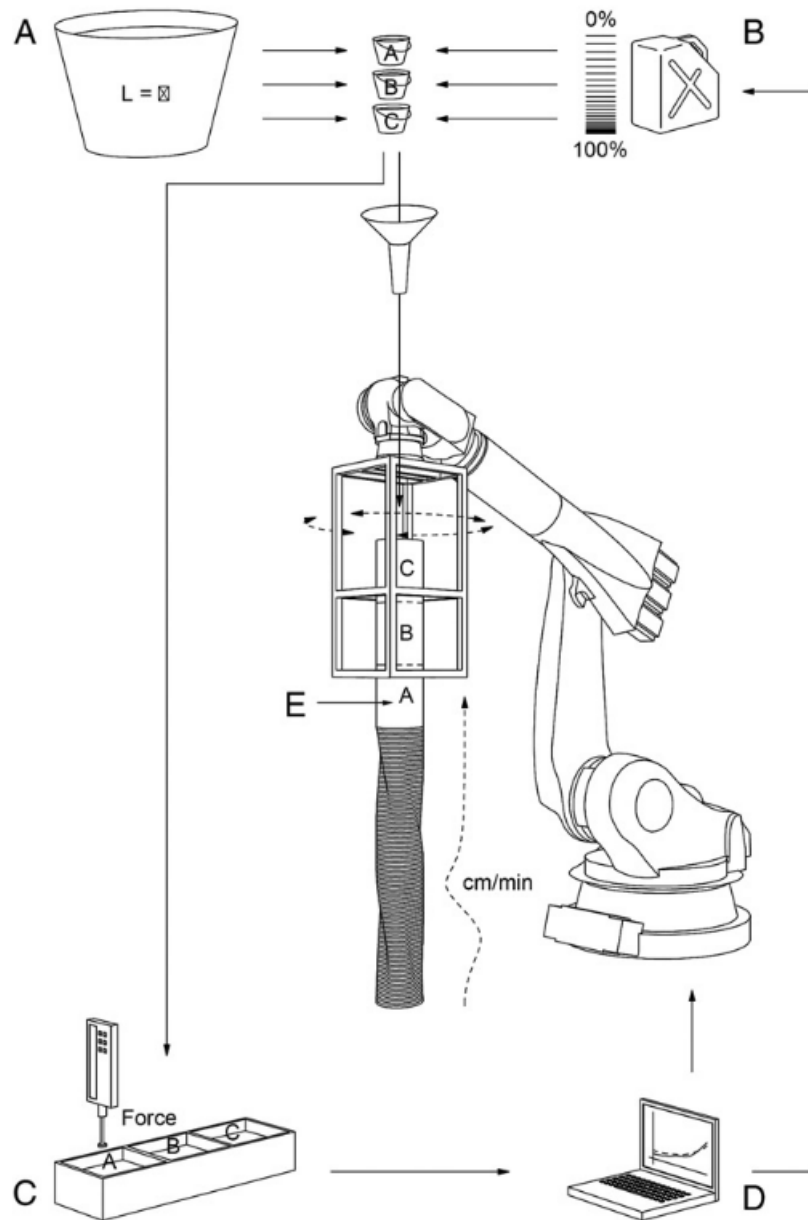


Figure 2.4: Smart dynamic casting process, published in [50]



Figure 2.5: Column extrusion by slip forming, published in [50]

matters most. It has indeed a direct formative impact on the printed object, and can also feature additional devices to ease the extrusion, control the material, or for instance add a surface treatment to the object. In the case of varying shape for the nozzle [85, 88], some customization can be achieved through technological development. On the contrary, the absence of layering (batches series still need to be carefully done to ensure material homogeneity in the case of discontinuous casting), and the low shear stress regime of the material eases some of the challenges that appear in the other approaches detailed below. All in all slip forming seems suited for monolithic building components with varying shapes, but provides less geometrical versatility than layered approaches.

2.2.2 Extruded lace shaping

By this term we refer to the most widely used printing approach today, including contour crafting process [40, 43, 42, 4]. It consists in extruding and stacking laces of mortar onto each

other, as in traditional rapid prototyping in polymer. Like the last mentioned process, oriented lace pressing, see 2.2.3, and contrary to previously mentioned slip forming, it is a layered extrusion approach. The main difference with lace pressing lies in the shear history applied to the material. This rheological nuance will have a great impact on scale, speed, applications and specific challenges of the process.

Extruded lace shaping makes use of a high yield stress mortar, also called no slump mortar, that is almost not strained during pumping, shaped by a square like nozzle, and deposited layer by layer. This strategy makes sure that the deposited lace has already gained mechanical properties during pumping by opting for what is called a plug flow. Such a flow can happen for yield stress fluids with relatively low viscosity. Inside the pipe, on the edges, a high shear zone will form, called lubrication layer, while the center zone, the "plug", to be as large as possible, will be subject to low shear. In that case, it is important not to have additional shear at the nozzle in order not to break material structuration [79, 21].

In such a process, the nozzle is typically shaped in the form of the mortar lace, often a flat rectangle. It has to be oriented with the lace because it is responsible for the shaping, therefore a rotating nozzle is compulsory, see figure 2.6 [40, 9]. This aspect makes this second strategy an intermediate between slip forming, which mostly focuses on nozzle technology, and oriented lace pressing, where material design relieve the nozzle from some of its duties. The lace shaping strategy is also in between two scales, as far as extrusion size and nozzle speed are concerned. The rheological strategy indeed imposes the lace section to be of several centimeters, whereas the last approach allows for finer layers.

With a few centimeter height, each layer can be subject to deformation under its own weight. This must be avoided to correctly print the intended object and control each layer altitude and width. With the stacking of subsequent layers, dead load increases, so do the yield stress and elastic modulus of the already deposited material. Both initial and transitory mechanical properties need to be carefully checked.

One of the challenges of 3D printing is to be able to form objects away from strict verticality, the contrary can be called 2.5D printing. For slip forming it can be done by changing the nozzle

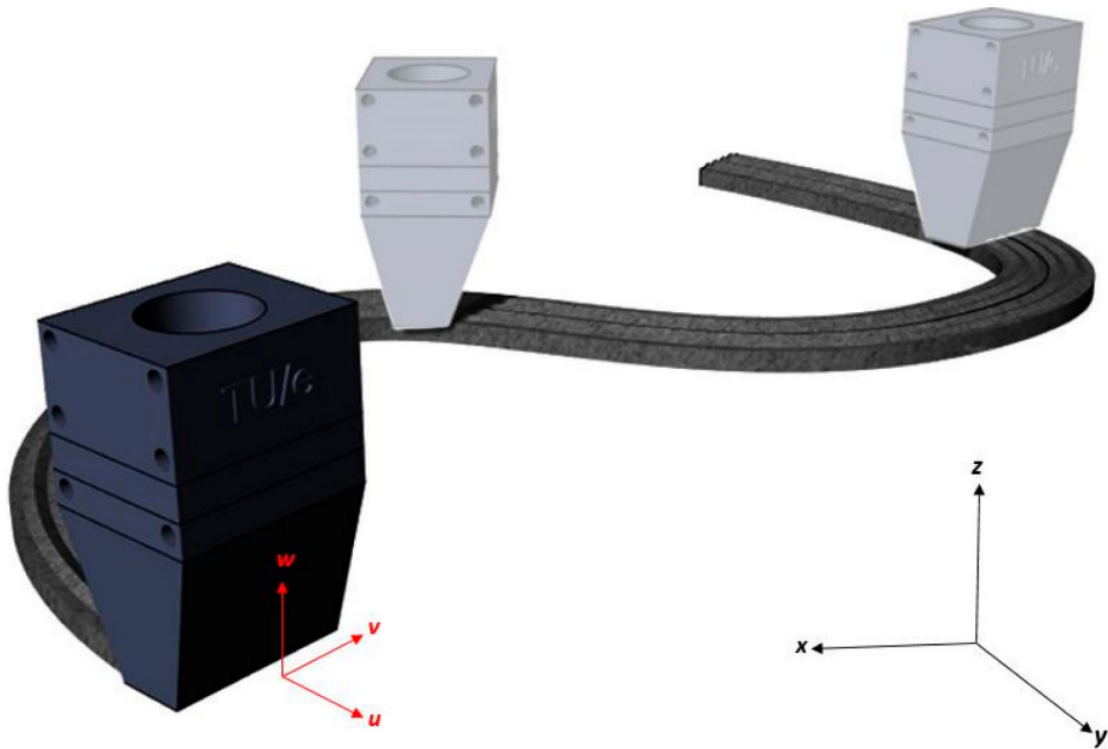


Figure 2.6: Concept of a rotating nozzle to avoid twisting of rectangle laces, published in [9]

shape or orientation, at a technological cost. Layered approaches can build oblique objects with a cantilever construction strategy. Extruded lace shaping and oriented lace pressing are different on that matter (see 2.2.3). For lace shaping, the layers form true corbels, and maintaining an undeformed layer can be quite challenging. This problem has been studied in [9], see also figure 2.7.

In layered approaches, inter layer time is a crucial parameter. It is still an open problem today, and the critical inter layer time to make sure the interface does not form a mechanical weakness is very process dependent. Some studies have proposed physical interpretation based on drying of the layer before it is covered by the next one [100, 90, 54]. In [79] it is also mentioned that interface strength weakens when material thixotropy increases.

Another challenge quite specific to lace shaping approaches is the cracking in fresh state, mentioned in [79] and [9]. Indeed, since the extruded material has a high yield stress at $t = 0$, high curvature zones can have cracks, which will result in bad properties for final material.

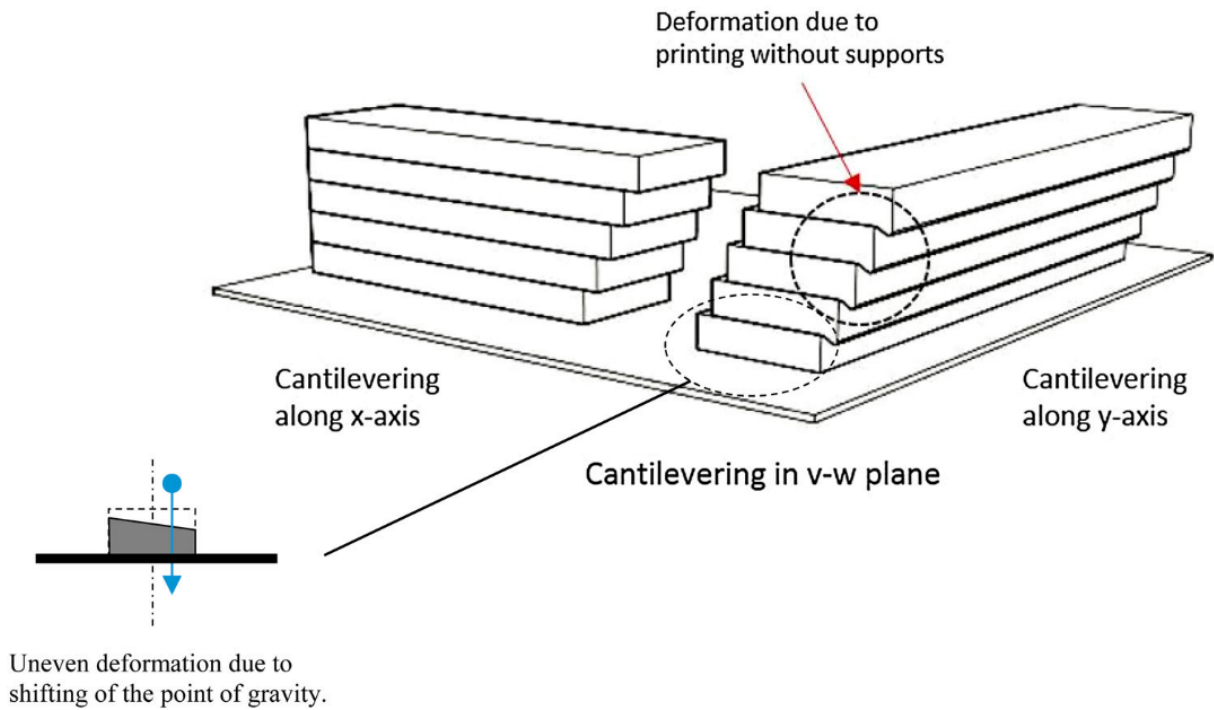


Figure 2.7: Cantilevering layers of extruded filament, published in [9]

2.2.3 Oriented lace pressing

The last approach for mortar robotic extrusion can be called oriented pressing. It corresponds to what has been described in [31]. It is also a layered printing process, but with a critical difference in terms of rheology. Instead of extruding on one go a high yield stress material, a rather fluid concrete is pumped toward the nozzle and rapidly evolves once extruded, see figure 2.8. The extruded material, at deposition time $t = 0$, has a yield stress of some hundreds of Pascals, far lower than in extruded lace shaping approaches that need some thousands. That means in this case the early age properties have to evolve more rapidly than in the previous one. Therefore it can be seen as a two phases approach, the first phase when the material is fluid, and the second phase corresponds to its quick toughening.

Such a phase change can be achieved with a printing system able to modify the material, mechanically or chemically, right before it is extruded, for instance by performing a second mixing of the mortar in the printing head, while adding some admixtures [31], see figure 2.9. Those admixtures can be viscosity modifier agents, accelerators, resins or any chemical providing early age structural properties to the lace. The two main strategies today seem to rely either on



Figure 2.8: Oriented lace pressing

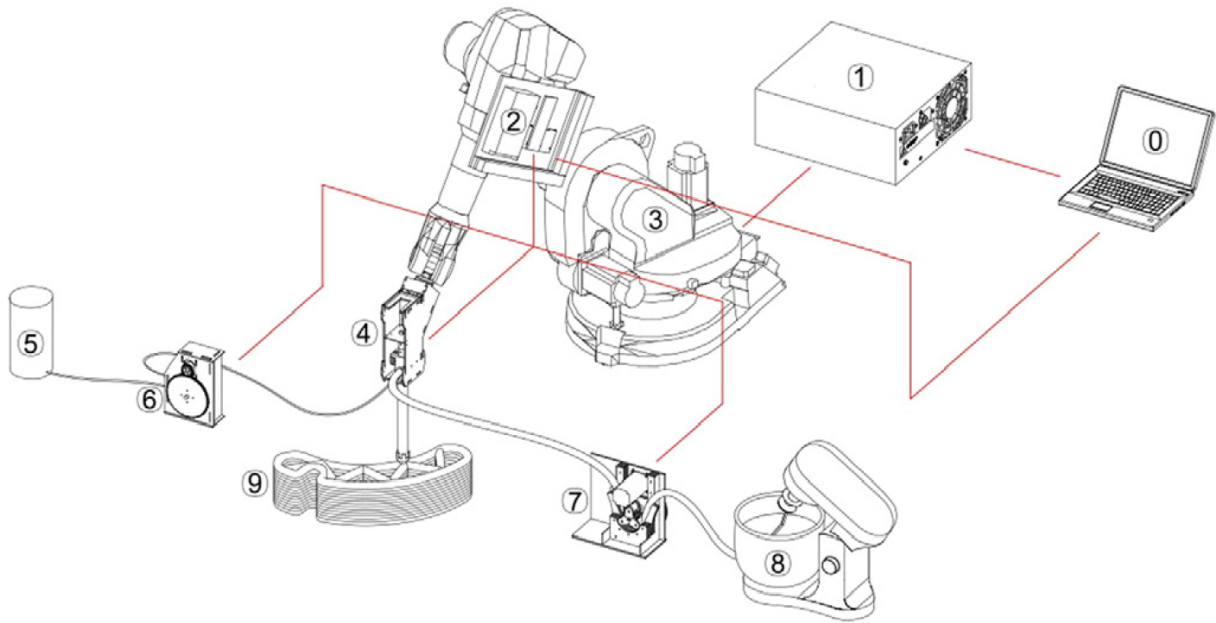


Figure 2.9: An oriented lace pressing two phase system published in [31]. 0. System command; 1. Robot controller; 2. Printing controller; 3. Robotic arm; 4. Printing head; 5. Accelerating agent; 6. Peristaltic pump for accelerator; 7. Peristaltic pump for mortar; 8. Premix mixer; 9. 3D printed object

thixotropy, as previously mentioned, or on ettringite formation [95, 78].

In this strategy, the mortar keeps being sheared until the deposition. Therefore the lace is not directly shaped by the nozzle anymore. Instead of depositing an undeformed section, the plastic material is pressed onto the previous layer, or on a support. This allows for finer layers, typically between some millimeters and some centimeters, depending on the system scale. The nozzle consequently moves at higher speed, typically hundreds of millimeters a second. Also, more versatility is brought to the process because material properties can be finely tuned along the printing. Variation in layer thickness and orientation is possible, opening for more geometrical freedom, see figure 2.10. Limitation in lace curvature due to fresh state cracking is also reduced by the higher plasticity of the extruded material.

Lace pressing, while promising in terms of versatility, can raise some difficulties. Precise understanding of material states in the nozzle while sheared, during and after the pressing are still open problems. At high nozzle speed, and relatively low yield stress, it has been pointed out [79] that inertia forces are not negligible. Therefore the lace exact shape seems to come from a competition between inertia and yield stress, depending on speed, orientation and lace

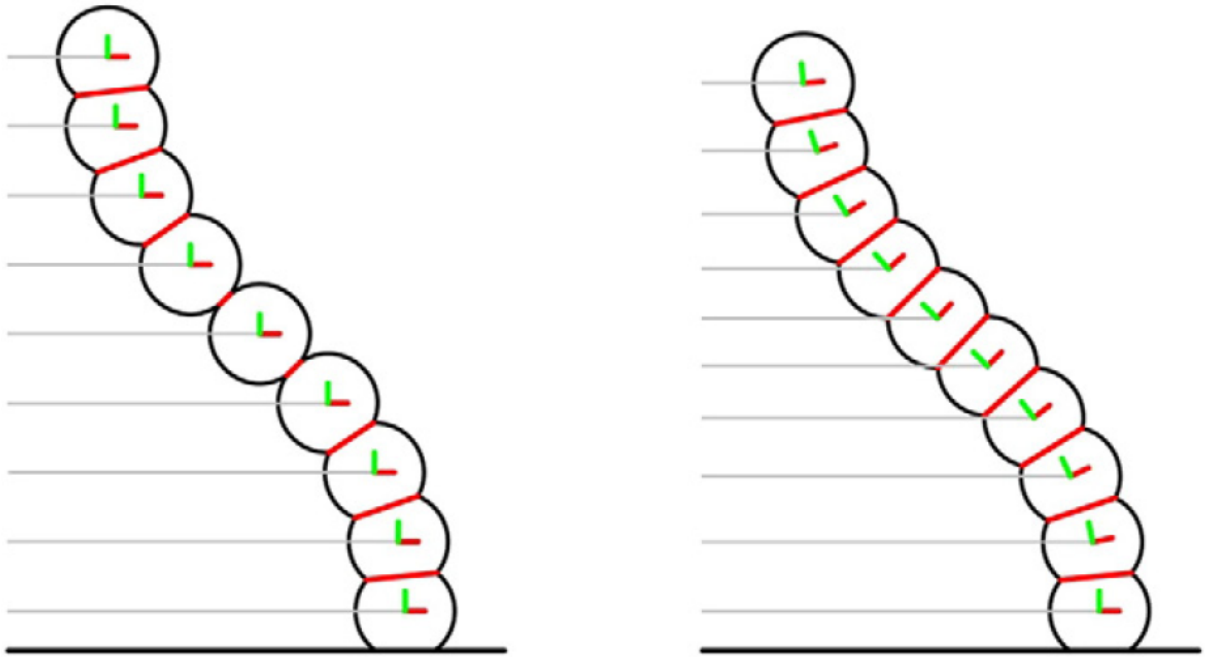


Figure 2.10: Layer orientation by the so-called tangential continuity method, published in [31]

curvature. In addition, lace pressing can bring a supplementary force in the perpendicular direction toward the previous layer. If this force is not negligible, post deposition deformation can happen to the laces. This phenomenon have to be avoided when inter layer time and material evolution prevent the lace to plastically deform without cracking. But as for the two other approaches, if precise modelling of physical phenomena at stake are still to be perfected, experimentation show rather good results in terms of printability and final material properties of printed objects.

For this last scenario, the nozzle geometry does not have a direct impact on the lace, at least not in the same sense than before. Nozzle diameter stays an important parameter to the process, but each size allows for a continuous set of laces. Higher speed and varying layer geometry however demand more advanced features for the robot handling the head. Six axes orientability is required and raises new robotics problems.

2.3 Printing process and building systems

The three idealized strategies mentioned above are printing processes in the sense that they can progressively bring cementitious material into form, and guaranty its final quality. However they are not complete building systems. One of the goal of the present work is to shift the discussion from printing processes to building systems. As stated by Pegna, "the fundamental paradigm underlying additive manufacturing processes is that a structure can be built by incremental addition of elemental material in a manner that can easily be automated. As such, complex operations such as material removal, material processing, material handling and assemblies are reduced to a large number of identical simple operations" [64]. In order to bring novelty, sustainability and efficiency to the building industry, concrete printing has to be seen as a general problem and not only addressed by material science. Among the many disciplines at stake here, robotics and civil engineering are challenged to invent new applications compatible with such printing processes. In this section we briefly present some general aspects of the matter in terms of technology and building industry.

2.3.1 Technological aspects

As mentioned above, technology plays a critical role for our systems. Some approaches bring new functions to existing devices like gantry cranes and robotic arms, some other feature development of specific machines. We have discussed the influence on the material needs in the previous section. We detail here the concrete printing problem from a robotics angle.

Robotic control

In robotics there is a distinction between two distinct devices called manipulator and end effector. The manipulator moves the end effector, that is designed to be the tool, or to interact with the environment. In our case of course it is about a printing head moved by a manipulating device.

If the manipulator can virtually be anything, in the vast majority of cases a gantry crane three axis robot has been used. Either with Cartesian directions xyz , see figure 2.1 or polarized around a center [41], see figure 2.11. This choice present the advantage of simplicity for movement instructions, and of scalability. Indeed one can build a full size gantry crane to bear a printing head and so printing the walls of a full building in one go [40], see figure 2.1.

Some teams including ours have made use of six axis robotics arms that allows for more complex trajectories adding three rotational degrees of freedom to the tool. This necessitates a more refined control software able to generate sound instructions for the robot corresponding to the targeted trajectory. The existence of a unique solution is not guaranteed for any path with any orientation. One other advantage of such a choice is that those are standard machines that have been employed by other industrial fields for a long time, they are robust, very precise and quite cheap. Their accessible area span a few meters for the tallest ones.

The other main idea, already mentioned in [13], is to make use of a cable robot to handle the printing head. This is maybe the best ratio between lightness of implementation and scale, but some difficulties are still to overcome, specifically about precision. The interaction of the cables themselves either with the construction site environment or the printed objects can also be a difficult problem in general. Other ideas exist like sets of little robots hanged up to the printed structure, or swarms of drones progressively bringing matter. They seem less intrinsically linked to extrusion methods.

At the other end of the machine is the end effector, or the printing head. In the case of extrusion its basic function is to deliver the pumped material in the expected way. A discussion on its impact on shape has been initiated in the previous section, depending on the global strategy for printing. In the case of oriented lace pressing it has been said that the head can include a remixing of the material. In general, the function of the printing head is the interaction with the printed material. Its action can be mechanical, like shaping, vibrating or smoothing. It can also modify the material composition, with admixtures (liquid or powder), or inclusions like fibers for reinforcement, polystyrene bead for insulation, electronic devices to be embedded in the object etc. The head can also perform some of the finishing work for the building component.

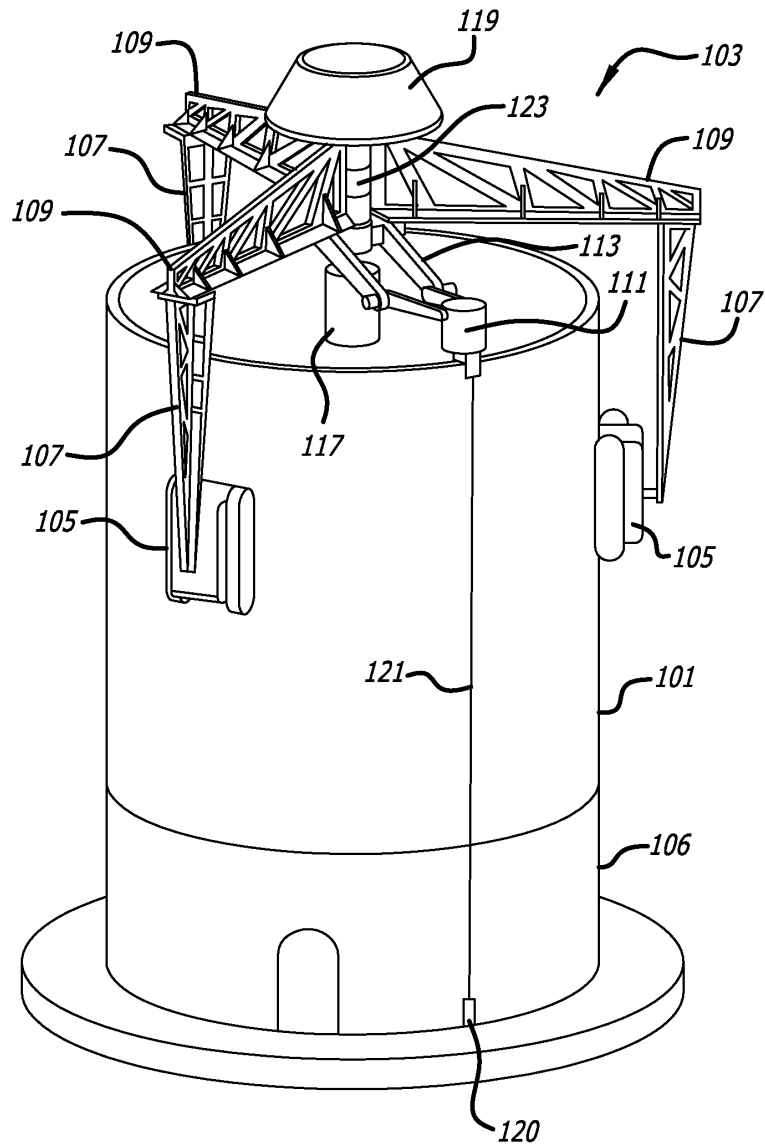
FIG. 1

Figure 2.11: Building system for towers and columns with a polar extrusion process, published in [41]

In some cases the printing head will need additional rotational freedom to adapt the trajectory while maintaining a given orientation with the printed lace. The limit between manipulator and end effector then becomes blurry. Mobile platforms have also been used, for example in [30], to bear a six axis robotic arm. In that case they are included in the manipulating system.

Automation and cobotics

The whole subject of concrete printing is included in the more general problem of automation in construction. The main differences with other industrial fields are scale, if a whole building would be printed, and versatility. Contrary to what has been achieved in terms of productivity rates for mass production of identical products, for example in the automobile sector, construction industry demands fast and automated production of elements each time different. This is the main appeal of 3D printing and it is often called mass customization [62, 1]. In terms of robotics this raises several questions.

If it is possible in principle to have "black box" facilities in other industries, where production is fully automated and no humans required, this scenario seems quite unrealistic for the construction field. With some experience, quality equipment, both in software and hardware, it should be possible to fully automatize a production line of concrete elements. The scales and shapes would have to be quite similar among them though, and this scenario is only compatible with a prefabrication paradigm. More than robots stealing humans job, the transition can be thought as a change in labour conditions, where robots help the workers to some tasks. This is particularly true when in situ printing is considered. The interaction with other elements, people and machines can be very complex on today's construction sites. Robotics is therefore challenged by this field of investigation to better the security routines and sensory devices to be able to interact with unpredictable events in their surroundings. Even with humans around to control them, it seems compulsory that the robots brought on construction site need to show intelligence of some type. Such matters are developed today, e.g. by deep learning [51].

Robotic intelligence, that is the ability to react and maybe modify the current task according to surrounding events, can also be of use for the printing itself. As we explained above, the printed

material can come with a certain degree of randomness. As in the traditional concrete industry, where such fine tuning of properties are less critical, each concrete batch exact characteristics depends on storage condition, weather, mixing methods etc. If basic testing can be performed before printing, like flow cone tests to check the initial yield stress [81], there is a great research need in inline devices able to measure rheological properties of the extruded material. With such devices, and proper programming, the robot should be able to adapt its trajectory, speed and admixture delivery in accordance with the material properties in real time.

2.3.2 Industrial aspect

To finish this chapter, we discuss the topic of building systems with robotic extrusion concrete printing under the angle of construction industry in general. The problem is to include in the pre-existing frameworks for building a new technology. In the previous section we mentioned some purely technological aspects of that problem but the question has to be addressed on a broader scale, and starting with the objectives rather than the means. Two main approaches seem to emerge from the general discourse about concrete printing. First, in situ fabrication of building units, the more direct use of the metaphor of the printer. Secondly, the making of building elements, themselves containing innovation in their design. They can either be prefabricated or printed in place. In the first case, an assembly strategy is to be thought of, eventually automated, to guaranty a sound connection with the rest of the structure.

One of the main potential advantage of concrete printing has been pointed out to be productivity increase and cost reduction. Such discourses often mention the mass customization paradigm as cost effective, and the in situ fabrication as a way of greatly reducing transport cost. If this seems possible indeed, one would have to carefully compare printing approaches to contemporary building techniques, and taking the whole system into account, including sub-trade work. For example, the dependency of a given printing process on environmental conditions like temperature, humidity, air convection are not fully understood. It is possible that no printing will be possible without a covering temporary structure that is to be included in the costs, its making, installation and removal. As for sub-trade work, an in situ printing that

would include for instance windows and doors, would have to ensure architectural quality of the construction, structural continuity, absence of thermal bridges, correct watertightness. Those challenges still lack complete answers today. In situ printing also increases difficulty related to building codes, see next section.

The other way of making use of such techniques for construction is to prefabricate novel building elements. In that case, some issues linked with in situ fabrication disappear but transport and handling steps become more important. Transport can however still be reduced by using what is called a micro factory, under a temporary structure built on construction site. This allows for controlled environmental conditions, just like in a prefab factory, but there is no need for transportation of cumbersome objects. In reality, less precision and more versatility or unforeseen events are to be expected in such a context. Anyway, both for micro factory and traditional prefabrication line, the purpose is to make building elements that are to be handled and assembled with the final building. This step can be critical for their design, and the previously mentioned challenges of structural continuity and watertightness remain. In the case of human handling, or machine assisted handling, of the objects, it is advisable to allow for some imprecision of the assembly step [18]. In principle, the whole handling can also be automated, but development is still needed to achieve that.

2.3.3 Normative context

In addition to technological and market concerns, the main obstacle to concrete printing implementation in the building industry is the conformity to regulations. In Europe, three existing documents can be of use, corresponding to three strategies for evaluating printed objects. A fourth and long term strategy would be the elaboration of a specific norm concerning those systems. The main topics are to ensure the printed parts mechanical properties in diverse scenarios, and that the global structure can exhibit a ductile behaviour when failing.

Eurocode 2, governing reinforced concrete building, seems difficult to utilize for printed structure as there is to our knowledge no way of directly reinforcing them yet. Printing around steel rebars can raise adherence concerns, and the layered approaches make the use of steel fibers



Figure 2.12: TU Eindhoven Bicycle bridge, published in [10]

difficult, for pumping and anisotropy reasons. Eurocode 6, at the contrary, includes a confined masonry approach that allows unreinforced part to be used if they are correctly surrounded by a reinforced concrete frame, ensuring global ductility. This approach will be explored in chapter 4. Today's most advanced industrial projects have made use of Eurocode 0 proof by testing. This is how a pre-stressed bicycle bridge was successfully tested and installed, as described in [10, 83], see figure 2.12. Ductility was achieved here thanks to a cable reinforcement strategy [11], the demand in tensile strength being greatly reduced by the pre-stressing.

Apart of those existing codes, often leading to over-sizing of building elements and therefore to over consumption of material, it is advised that further research is conducted in order to build a new regulation. Printed concrete can assume various roles depending on its association with moulded reinforced material in printed cavities. This material can be traditional reinforced (or pre-stressed) concrete, in the case of relatively straight cavities [10, 83], or ultra high performance fibered concrete (UHPC) for complex geometries [28], see figure 2.13. We can distinguish three typical uses of printed concrete with that criteria.

- Printed concrete as a left-in-place formwork



Figure 2.13: Pillar in Aix-en-Provence, XtreeE, 2017

In that case the main loads can be taken by the cast material, that also accounts for ductility. To reduce section sizes, e.g. for pillars, compressive strength tests must be conducted to be able to include the printed external section of the element in the design. Fire resistance will also be an important element to be examined, as the printed concrete could have an influence on the behaviour of the structure when exposed to high temperature.

- Printed concrete for masonry (Eurocode 6)

Masonry makes use of a material that mainly works in compression. This can be achieved with confined masonry approaches, one example is detailed in chapter 4, where the printed material is carefully placed inside a structural frame, able to bear tensile stresses and exhibiting a ductile behaviour. Traditional masonry however does not necessarily make use of a reinforced frame but rather designs specific shapes that lead to compression only structures. Renewal of such approaches for concrete printing have been studied in [40, 7]. In that case the printed concrete can be justified structurally as a fragile material, which mostly means ensuring its compressive strength and a minimal tensile strength. Assuming

the printing process is quite repeatable, hard and soft choc testing can be enough for the design regulations. In some specific cases, fire testing can also be mandatory.

- Printed concrete with rebars (Eurocode 2)

In that scenario, the printed concrete itself bears the main compressive loads. Rebars can be added in cavities as mentioned above, or, with further development needed, directly into the printed material. Fiber reinforcement of the printed lace, with short or long fibers [10, 12], can provide some ductility. The main difficulty associated with this strategy, if printed structures are to be certified without having to perform 1:1 scale tests each time, is to ensure repeatability. Depending on the printing process, see section 2.2, this can be of various difficulty. The worst case scenario, but possibly the best in terms of performance, would be to have varying properties along the printed object. With oriented lace pressing, varying layers sizes and orientation are possible, but one would have to ensure material properties at each point. This is probably achievable by monitoring the printing to precisely control what is being done. With full test campaigns to gather more data, it is conceivable to build a norm based on the printing itself.

In the next chapter we try to take advantage of those introductory elements to generally address the question of building systems based on robotic extrusion of cementitious materials.

Chapter 3

Classification of building systems in robotic extrusion of cementitious materials

In this chapter we present a method to address the question of concrete printing by robotic extrusion in a general fashion. Several key parameters are highlighted, concerning either the printing itself or its context of use. At stake is a way of comparing diverse procedures to each other, and a cartography of possible approaches. We first introduce a notation system, and investigate the relation between some proposed parameters. Then, a study on robotic complexity is conducted, since it appears to be an important piece of information to choose among several possibilities. The statements and conclusions made here are open to discussion, for we deal with very recent technologies, and because it is not yet clear how the building industry will transform once they become established. The aim is not to put things in separate boxes but to pave the way toward innovative building systems.

On the figures below are depicted three different ways of making use of a similar concrete printing process (similar in their objectives, if not in their actual results), which leads to three very different approaches in terms of building systems. On figure 3.1 is a prototype of a "flat" wall that have been horizontally printed on the floor and then moved to its vertical position.

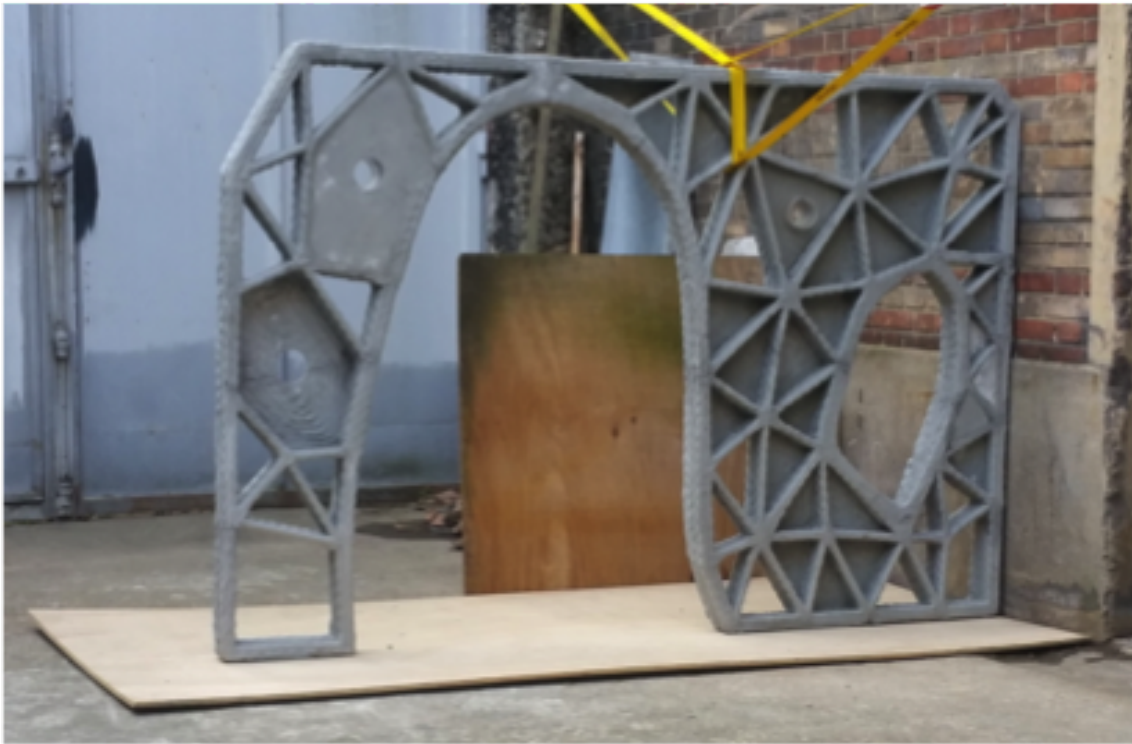


Figure 3.1: Flat wall (Democrite project, 2015)

Such a strategy allows great geometrical freedom for thin 2.5 D structures, as it takes advantage of the smallest dimension of the object and gets rid of the main difficulty of a direct printing : height. However, from a structural design perspective, the loading that corresponds to the handling of the object is likely to be the worse case scenario, and therefore to spoil the attainable lightness of the wall. Figures 3.2 and 3.3 depict an interesting idea proposed by the WASP Project¹ which consists in assembling adequately designed components, mixed with steel bars, to form an ultra-light composite beam, see also [5]. Figure 3.4 and Figure 3.5 show a viable way of printing a concrete mould that is to be filled with UHPFC² [28]. The unused parts between the tubes are removed afterwards keeping only a very light tubular space-truss structure, here a load-bearing pillar. Those three examples of what is called "indirect" printing reveals some possibilities offered by concrete printing.

The aim of present work is to explicitly characterize the set of possible building systems using concrete printing, and the subsequent associated robotic complexity. Many parameters can be

¹<https://www.3dwasp.com/en/>

²<https://www.xtreee.eu/>



Figure 3.2: Externally reinforced beam (WASP, 2015)

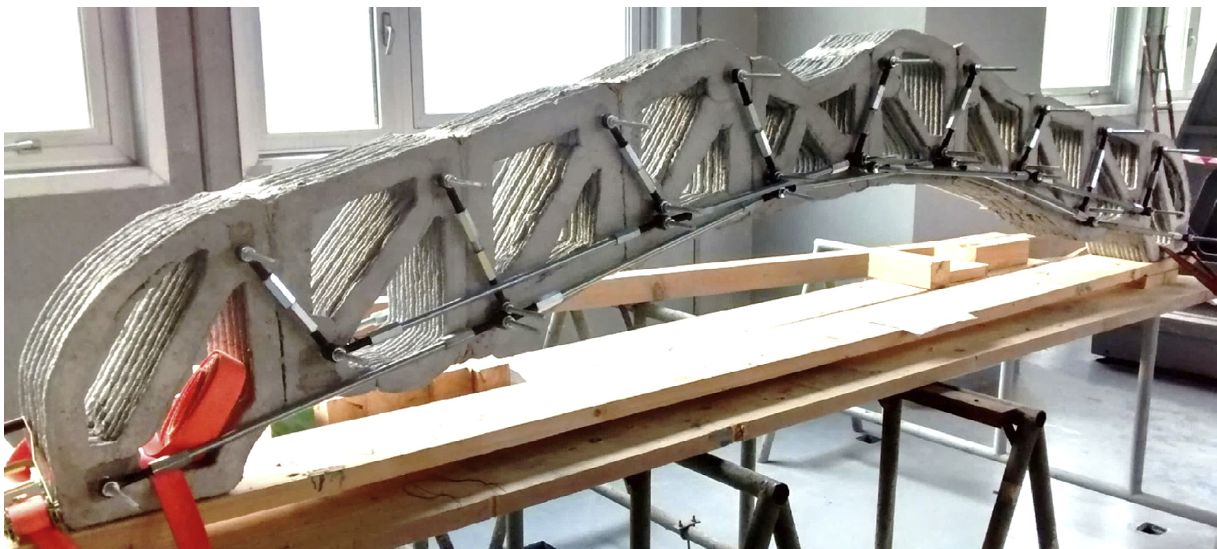


Figure 3.3: Externally reinforced beam, published in [5]



Figure 3.4: Mould for a space truss (XtreeE, 2016)

considered due to the complexity of such processes. One of them, which is from the traditional 3D-printing industry, can be the printing support. It is well known that one can print an additional material, called support material, in order to reach specific geometries. This support is to be removed in a subsequent step. At large scale, however, the pertinence of such an approach needs to be compared with the use of external supports like falseworks. The flat wall example on Figure 3.1 can be seen as the use of a "flat" support, whereas the example on Figures 3.4 and 3.5 makes use of no external support. Removable concrete parts can be considered as printed support.

This can be generalized by listing the families of possible external supports, as depicted in Figure 3.6. With the exact same printing process, i.e. mortar extrusion, controlled with a 6-axis robot, and varying only the type of external support, one can obtain very different systems, and diverse attainable forms. This analysis highlights the need for additional considerations, for instance regarding assembly. Indeed, if direct printing without external support can be done without bringing any external part, or assembling elements, a multiple printing necessarily entails an assembly step. Likewise, a collaborative printing, where external supports are brought



Figure 3.5: Printed pillar in Aix-en-Provence (XtreeE, 2016)

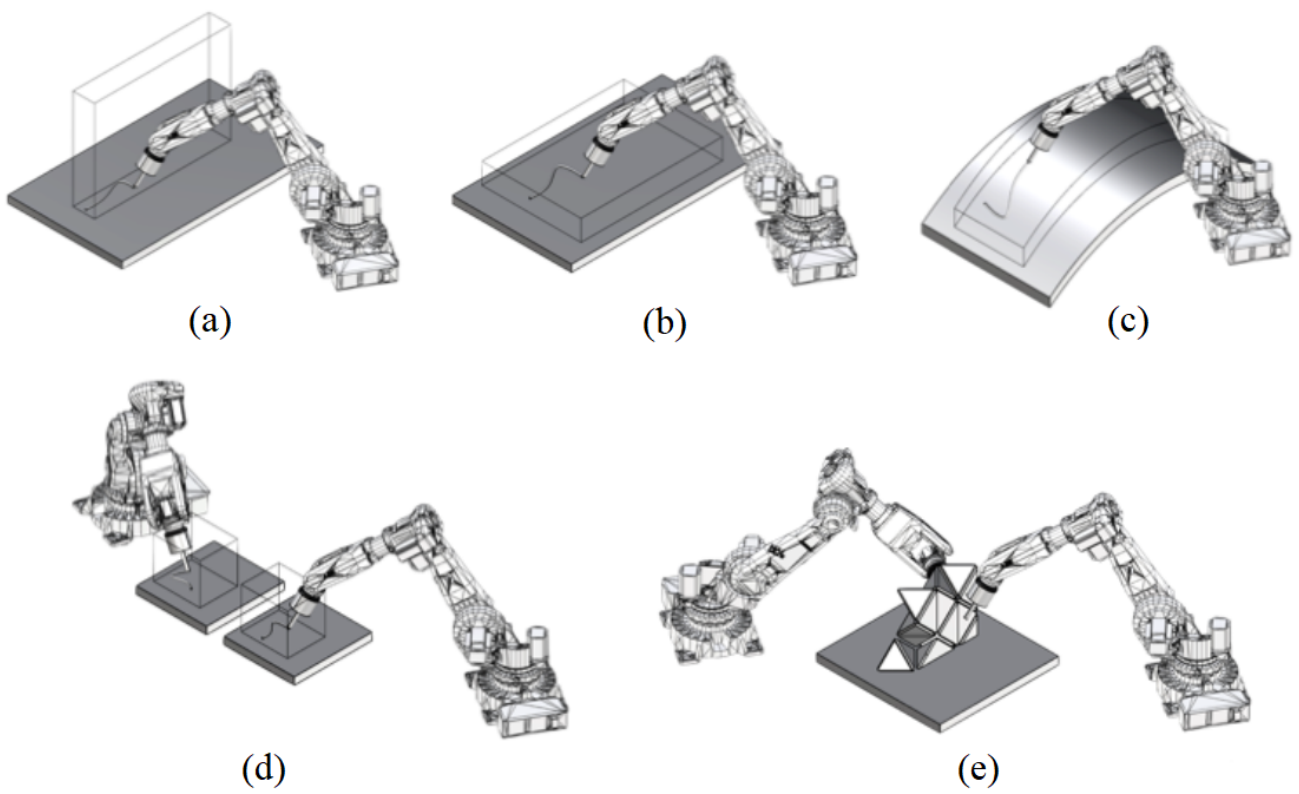


Figure 3.6: Variation of external support parameter. (a) No support ; (b) Flat support ; (c) Curved support ; (d) Multiple supports ; (e) Assembled supports

during the extrusion step can be considered as including an assembly step. Pointing out these differences between building systems is critical to correctly anticipate the associated complexity, technological barriers and to estimate the cost of a project. In addition, a given constructive result can be obtained by cleverly getting around an obstacle - working on the building system as a whole, preferably than developing overly complicated processes which will struggle to achieve industrial implementation.

3.1 Key assumptions

Following the previous intuitive considerations on the qualification of concrete printing building systems, the problem reveals itself as a parametrisation matter. In this chapter, we introduce a notation system, based on the most critical parameters to be considered, and an example of using such notation in order to compare building systems in terms of robotic complexity. Since a parametrisation needs to be as concise and exhaustive as possible, we reduce our problem based on the following hypotheses.

Cementitious paste extrusion. Our analysis is limited to processes engaging cementitious material extrusion, that is to say a system of shaping cementitious paste, mortar or concrete by flowing it out through a moving opening, as described in chapter 2. Such processes include at least a mixing step, a transport step (pumping) and a shaping step. We include in this definition the recent 3D printing of concrete as well as contour-crafting method, but also the older technique of slip-forming. The difference between layered extrusion and slip-forming is treated here as a difference of "extrusion scale" (parameter x_e , see 3.2.1 below). Extrusion scale for slip-forming is usually around 1/10 of the printed object size, whereas this number is lower for layered extrusion processes (e.g. around 1/1000 for the example depicted on Figures 3.4 and 3.5). Since we will be dealing with printed support material, it will not necessarily be extruded and/or cementitious but could also include clay, polymer, or any useful material. However what is considered to be the "main" printed material has to make use of cement. Our analysis is limited to extrusion processes, hence excluding other additive manufacturing techniques like

stereo-lithography or powder bed-based printing. Yet, the proposed system of notation remains open for generalization, and because some of these AM techniques have recently been proposed at large-scale, it would be useful to conduct a similar investigation.

Extrusion speed. One of the critical aspects of concrete 3D-printing is the extrusion speed, more precisely the speed of the nozzle shaping the paste. Since this quantity is directly linked to the printed concrete behaviour, our previous experiences have shown it to be scale-dependent [31]. As a matter of fact, if a large quantity of concrete is being extruded, e.g. by slip-forming, the only way to get it chemically and mechanically sound will be to give enough time for the setting to happen. That is why such techniques traditionally exhibit slow nozzle speeds, typically around a few meters per day. On the contrary, when extruding mortar laces around 1 mm, it is preferable to keep a relatively high-flow pumping system while increasing the nozzle speed, up to several hundreds of millimetres per second. The main reason for it being that such precise printing must be as quick as possible to be implemented in the building industry. Therefore we have chosen not to take the nozzle speed as a parameter in this chapter, but rather to consider an extrusion scale parameter, which is directly related to the nozzle speed under the present assumptions, and more pertinent to characterize building systems in terms of precision. In this context, if one would want to use a relevant speed parameter, it would have to be taken from the whole building system, and not limited to the extrusion step.

Maximum automation : limited human intervention. The technologies of interest in this paper take part in the global movement towards automation. Hence, we suppose that any human intervention in the framework is limited to handling or gathering few, simple, small elements. When robotic speeds are high enough, no human interaction is planned for security reasons.

Robotic system. The shaping step is conducted by a robotic system, going from gantry cranes to more complex robots, such as 6-axis. If the nozzle itself can include robotics, like smoothing or cutting devices, it is considered as a secondary system, while the device moving

the nozzle is called primary. A third robotic system can intervene after printing, for instance to handle large or special printed elements. Only if such actions are taken during printing phase, this system is included in the primary one.

3.2 Classification

3.2.1 Main parameters

A given set of building systems is denoted by enumerating the parameters it is concerned with:

$$x_o^n x_e^m e^i a^j s^k \dots \quad (3.1)$$

Where p^n stands for the n^{th} version of parameter p . The parameters are indeed divided into categories, explained below. The two parameters x_o and x_e are scale parameters, respectively about the printed object and the extrusion, while the parameters e , a , and s respectively concern printing environment, assembly and support. The notation is not length-constrained, for instance the set e^0 includes every building system consisting in on-site printing, while the sub-set $e^0 s^0$ corresponds to all on-site building systems making use of no support for the printing. We detail below the numbered versions of these main parameters. The division made here, as well as the indicative values of parameters, are gathered from the literature and the own experience of the authors, while being subject to change.

Object Scale x_o This is one of the main parameter to take into account, for it will strongly orient the decisions taken about a system. It deals with the size of what is printed. We divide it in four versions.

x_o^0 (dm) - Printed object of size less than a meter, typically a connection or a voussoir

x_o^1 (m) - Constructive element of size around 1-4 m, typically a beam, column or slab.

x_o^2 (dam) - Object around 5-10 meters, typically a living unit or a house.

x_o^3 (dam)- Full tall building.

Extrusion Scale x_e This parameter is a characteristic size of what is extruded. Depending on the process it can be a nozzle diameter, a mortar lace section, or the final thickness of a printed layer. Again it is divided in four scales, taken from literature and our experience to correspond to four diverse material behaviours.

x_e^0 (mm) - e.g. a thickness layer less than 8mm

x_e^1 (cm) - e.g. a thickness layer between 8mm and 5cm

x_e^2 (dm) - e.g. a thickness layer between 5cm and 30cm

x_e^3 (m) - e.g. a thickness layer above 30cm

Environment e We have extracted three possibilities concerning printing environment. The first one e^0 corresponds to a direct printing on-site and without any additional handling of the object. The second one e^1 refers to a printing done in a controlled environment (temperature, hygrometry, ...) thanks to a light/mobile structure deployed on construction site. The last one e^2 is a traditional prefab factory, imposing handling and transport of the printed object.

e^0 On-site(direct printing)

e^1 Mini factory (indirect)

e^2 Prefab factory (indirect)

Assembly a As seen above, a building system using concrete printing can include some assembly step. We define this term as the action of bringing a macroscopic element by an external device, either *during* or *after* printing. This means we do not consider false-work as an assembly step (but as a support, see below). The term "macroscopic element" is opposed to "inclusions" that can be mixed to the extruded mortar, like polystyrene beads or fibres. In that specific case we consider that the secondary robotic device (printing head) is in charge and do not treat it as an assembly step. The assembly step is conducted either by human workers or a third robotic device. There are four types of assembly in our classification, summed up in Table 3.1.


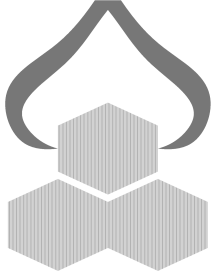
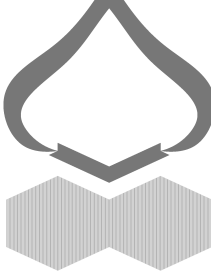
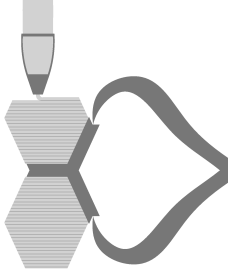
	a^0 No assembly
	a^1 Assembly of printed elements to form a larger one
	a^2 Handling of printed object to put it in its final situation
	a^3 Assembly of external element(s) after printing
	a^4 Assembly of external element(s) during printing

Table 3.1: Variation of assembly parameter a

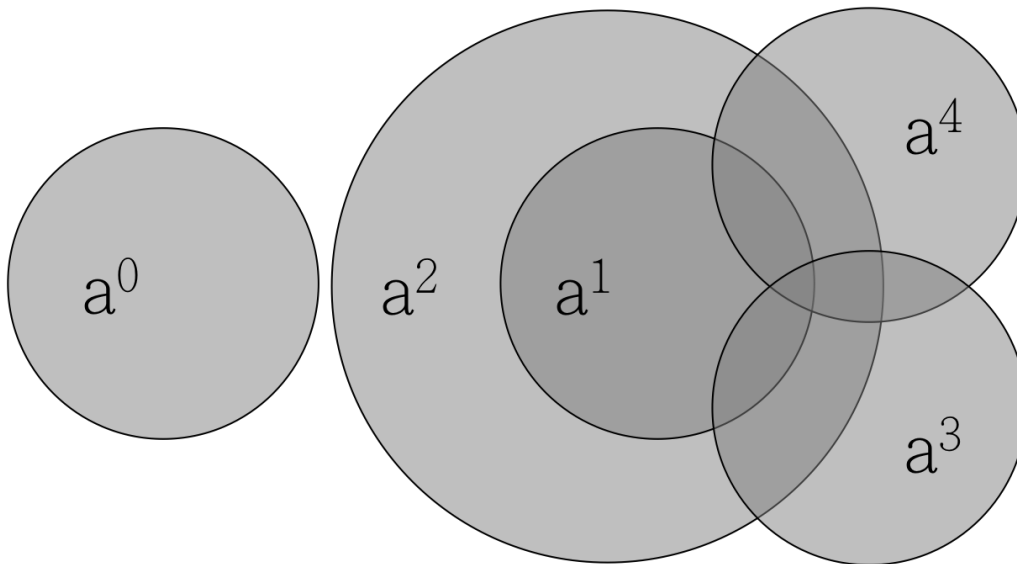


Figure 3.7: Possible combinations of assembly parameters

The majority of the above possibilities are not contradictory with the others, that is why a building system can exhibit several of them, for example the prefab of a multi-functional wall with window, electricity and plumbing could be denoted by $e^2 a^2 a^4$. Only the parameter a^0 , which cancels out the other a^i parameters must remain by itself. Furthermore, an a^1 system necessarily implies an additional handling a^2 . The legit combinations are summed up in the diagram on figure 3.7.

Support s Likewise, we have extracted four categories of supports. By this term we mean every rigid (or semi-rigid) surface on which is deposited the extruded material and that has a beneficial effect on its stability. As we oppose this term to "assembly", a support is supposed to be brought either *before* or *during* printing. A printing is called "without support", and denoted by s^0 when no other surface than ground or foundations serves the printing. The combinations between different versions of the parameter s are simpler than with parameter a for there is only the cancellation of s^0 to take into account (see figure 3.8). Two aspects are addressed here : if the support is printed or brought by an external device, and if it is to remain after the printing or not. See Table 3.2.


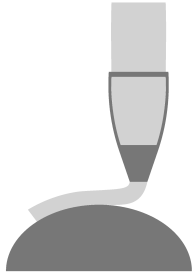
	s^0 No support
	s^1 Printed support, left in place s^2 Printed support, removed afterwards
	s^3 External support, left in place s^4 External support, removed afterwards

Table 3.2: Variation of support parameter s

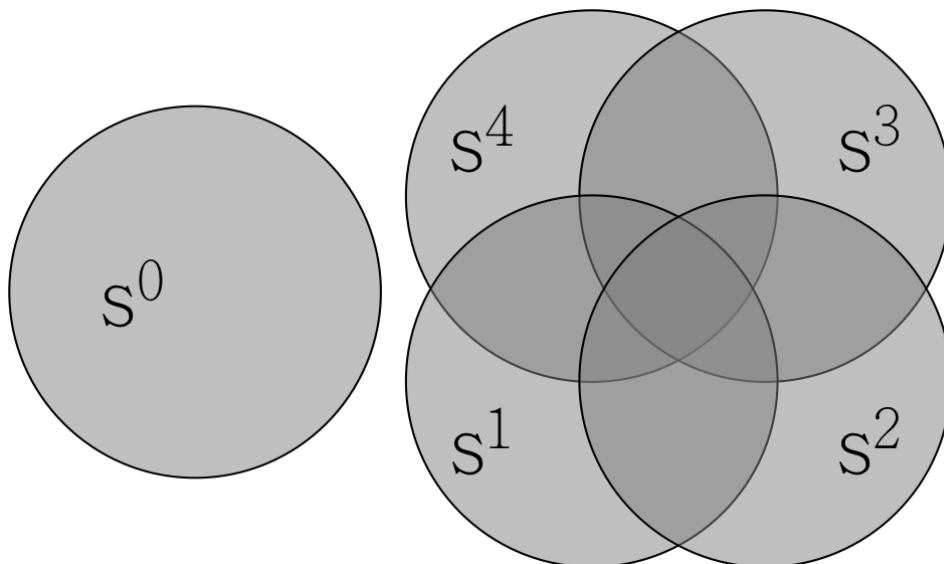


Figure 3.8: Possible combinations of support parameters

Examples The three examples shown on the first 3 figures can be given a combination of these parameters:

- The flat wall on Figure 3.1 corresponds to the combination $x_o^1 x_e^1 e^2 a^2 s^4$.
- The beam on Figure 3.2 can be denoted by $x_o^1 x_e^1 e^2 a^2 a^3 s^4$.
- The pillar and its mould on Figure 3.5 and Figure 3.4 is a $x_o^1 x_e^0 e^2 a^1 a^2 a^3 s^2$ approach.

Robotic complexity r In addition to this five main parameters, it is also useful to point out the robotic complexity engaged in a certain building system, for it will decide of its feasibility, its cost and the amount of research needed before it can be implemented at an industrial scale. Today, most of the research engaged in concrete printing makes use of 3-axis robotics, technological research being preferably oriented upon secondary devices that brings external elements to a directly printed building. Some works have made use of 6-axis robots, and few of them have experimented the potential of this new complexity. The list below is a version of what would or will be explored as new robotic complexity in the near future, we will make use of this parameter r in section 3.3.

r^0 One 3-axis robot

r^1 One 6-axis robot

r^2 One 6-axis robot with an axis at his base (rail)

r^3 Two 6-axis robots (collaborating)

r^4 Two 6-axis robots with an additional axis at their base

r^5 One 6-axis robot on a 3-axis robot

r^6 Two 6-axis robots on two 3-axis robots

3.2.2 Additional parameters

The five previous parameters are very general and will concern any question regarding building systems with robotic extrusion of cementitious materials. Their generality comes from the

fact that they are not directly related to one specific subject that can be critical to the topic: robotics, chemistry, rheology, structure, geometry. Given a certain family of building systems, it might be relevant to take into account an additional parametrisation, coming from one of those disciplines. In this section we first explore the critical aspects in terms of material, and technology.

Material

Material aspects are at first glance more related to the printing process than to the building system as a whole. However, the question to be asked each time is whether to rely on the material performances or to make use of technology to relieve it from some of its duties. Making use of supports can for instance solve a rheological challenge, at a technological cost. Conversely, a material embedded with fiber reinforcements can diminish the overall economical impact, saving time, labour and machine use. However that will depend on the way the fibers are included. Indeed, if the initial mortar already contains fibers, and can be pumped and printed as is, it is of course a great advantage, but as soon as the inclusion of fibers takes place during one of these steps, development is required [11].

The main difficulty of finding relevant parameters for the extruded material as far as building systems are concerned comes from the great variation of requirements along the printing time. All in all, it is difficult to only talk about one material with evolving properties, the very definition of what is to be considered as material can evolve in such a system. Indeed, something can be called a material when considered at a scale where the properties can be defined and exhibit a certain continuity. When sudden variations appear, in relation to geometrical distributions, it becomes more efficient to see it as a structure. If one can consider the pumped and extruded material to be a varying version of the same initial batch, once the layer stacking begins, the printed laces of varying properties form a structure. Finally, at the scale of the whole building, it may be advisable not to take this mesostructure into account but to ensure instead overall material properties of the building element. That is why it seems wise to choose the main material parameter to account for this complexity. The division between successive steps depends

on the printing system, but the following parameter m could be of use :

m^0 Mixed material

m^1 Pumped material

m^2 Deposited material

m^3 Stacked material

m^4 Curing material

m^5 Final material

Each of these materials must answer to a specific set of requirements and can be made different either chemically, with additive, and/or resulting from external physical solicitations modifying their behaviour. The more changes are made this way, the less will be asked to the initial material, and the more technological refinement will be necessary.

- **m^0 Mixed material**

This step has to produce a pumpable cementitious material, either continuously, for full automation perspectives, or in batches. In the last case, the printing system ideally has to erase any discontinuity produced by the successive batch. The batches fabrication must adapt to the printing timing, and material properties regularity must be ensured. This can be controlled with some initial testing, e.g. of some rheological properties. All systems are not equal in terms of needs in regularity for the initial material.

- **m^1 Pumped material** The pumping is a critical step for the material, especially in terms of attainable scales (length, height) and energy consumption [20, 86]. Fluidity is required and can be achieved by pumping low yield stress and low viscosity cementitious material. This requirement can easily go against the needs in early age mechanical resistance for the printing phase. Fluidity can however be achieved by pumping a material with quite high yield stress that can, depending on the pipe diameter and geometry, form a low shear flow called "plug flow", divided in a high sheared external lubrication layer and a quasi zero shear internal zone. Provided that stability of the material is ensured, this strategy can also help the printing phase by enabling early age structuring.

- m^2 **Deposited material** The initial deposition of the material, before it has to withstand the weight of additional layers, requires at least rigidity, resistance and stability. A certain plasticity can also be of use to limit cracking when a small deformation is induced by the printing of the next layers. The physical phenomena at stake at this step has been thoroughly presented in [79]. Again, some difficulties can be addressed by making use of external devices such as trowels or supports, relieving the material from its duties.
- m^3 **Stacked material** Studies on the layer stacking phase has flourished in the past three years [77, 99, 87]. The main subjects to be understood are the printed object stability, and material homogeneity. The stability of what is printed is linked to the resistance of the bottom layer, that can fail to withstand the top layers weight, and the overall buckling of the layered structure. In-homogeneity can appear at layer interface forming what are called cold joints. The phenomena at stake at the interface seem to strongly depend on the material and printing process, as well of course on the inter-layer timing. Recent studies have shown that drying and other stability issues linked to water migration in the layer can cause such problems [100, 90, 54].
- m^4 **Curing material** Once the printing is done, special care needs to be given to the object. The traditional form-work not only shapes the concrete but also protects it during curing phase. Since the printed cementitious material often have low water to cement ratio, they are more subject to shrinkage and superficial drying. This problem is usually addressed by controlling the surroundings temperature, hydrometry and air convection, but this can become difficult for in situ application. The material itself can be embedded with additives to better answer harsh external conditions but this field of study remains quite unexplored today.
- m^5 **Final material** We call final material what forms the final printed object, with designed final mechanical properties, typically measured 28 days after printing. A refined understanding of each layer's behaviour during printing is necessary to ensure final properties, but at this last step the purpose should be to be able to consider the object as a whole, made of one equivalent material of controlled properties. Even if the properties

evolve along the object, in what we call gradient materials, a growing field of study, from a design code point of view, the printed object must be able to be considered outside of its internal behaviour.

Tools

Outside of the main five parameters, it is also possible to offer a variation of parameters concerning the technological tools, in a more specific manner. See for instance a parametrisation of the manipulating system r_m and the end effector (nozzle) r_e

- r_m **Manipulating system**

The manipulating system can be more precisely characterized than with over all robotic complexity parameter thanks to the following aspects.

- Size : overall scale of what can be printed by the system according to its manipulator. The biggest scale are achieved by cable robots or gantry cranes.
- Deployability : mobility aspects of the manipulating system.
 - * Fixed / permanent, e.g. in the case of a prefab factory
 - * Fixed / temporary, e.g. in the case of a temporary on site factory
 - * Mobile in a delineated confined space, e.g. inside a factory where the placement of every object is known.
 - * Mobile in a delineated free space, e.g. on construction site, in specific locations like regular flat slabs
 - * Mobile in a free and unpredictable space, requiring artificial intelligence features [51]. Tiny robots climbing on the printed structures have also been tested in [38].
- Precision : depending on the extrusion strategy, see section 2.2, on assembly and support strategy, on the interaction with human workers.

- Accessibility : trajectory and path potentialities for the manipulating system. This is further discussed in chapter 5 and concerns the possibility of varying orientation, geometric complexity and relating to the surrounding objects.

- r_e **End effector**

The tool handled by the manipulating system can include a variety of functions that will impact the global strategy. A non exhaustive list of them below.

- Extrusion (dosing, pumping, mixing)
- Chemical admixtures (dosing, mixing)
- Measurements (pressures, temperature, flow rates, friction [84], geometric control etc)
- Mechanical actions (mixing, vibrating, smoothing etc)
- Inclusions (fibers, beads, sensors, pigments, etc)
- External elements assembly (rebars [40], blades, chains, cables [11], long fibers, textiles, lifting hooks etc)
- Sub-trade work (cladding, windows, vents, scrapping, cleaning etc)

3.3 Cartography

3.3.1 Scale variations of parameters e , a , and s

The different versions of these parameters are not independent from each other. In this section, we explore the relations between the two scale parameters (the sets $x_o^i x_e^j$), as well as their link with each main parameter (the sets $x_o^i x_e^j e^k$, $x_o^i x_e^j a^k$ and $x_o^i x_e^j s^k$). More precisely we want to switch off the impossible, or trivially bad, combinations. Table 3.9 sums up this information.

The sixteen squares corresponds to each $x_o^i x_e^j$ combinations. Three of them are fully gray-coloured, because they make no sense : for instance $x_o^0 x_e^{2,3}$ means printing an object smaller than the extrusion size, while $x_o^3 x_e^0$ does not seem to be a clever choice for precision.

Inside the sixteen squares are three coloured lines, each part of which corresponds to a combination $x_o^i x_e^j p^k$, where $p = e, a, s$ is a main parameter. Some versions of those are to be removed, as for instance $x_o^3 e^{1,2}$ for it is advisable to use direct printing for a whole tall building. Symmetrically, one would not print directly in place a connection to be assembled, that is why combinations of type $x_o^0 e^0$ are switched off as well.

Concerning assembly parameter a , it vanishes when objects are too big : no handling of printed elements when dealing with a tall building, the combinations of form $x_o^3 a^{1,2}$ are cancelled. As for the family x_o^2 of few meter tall modules, one can imagine prefabricating them, but any handling would certainly mean putting them in place, and not form a bigger element to move again once assembled. In consequence only $x_o^2 a^1$ combinations vanish. Finally as stated above, a connection is to be assembled, so the combinations $x_o^0 a^0$ never happens

3.3.2 Variation of the r parameter

Once the scale variation of the main parameters is set, one can explore their relationship to each other, at each scale. In this section, we explore combinations of type $x_o^n x_e^m e^i a^j s^k$, in order to understand which of them cancel each other, and link them to the robotic complexity parameter r , see section 3.3.5:

$$x_o^n x_e^m e^i a^j s^k \rightarrow r^t \quad (3.2)$$

The combinations of parameter s (i.e. the sets $s^1 s^3$, $s^1 s^4$, $s^2 s^3$, and $s^2 s^4$) are not mentioned in the table for the sake of clarity. For such combinations $s^i s^j$ the complexity r is supposed to be the maximal value of complexities associated with each s^i .

3.3.3 Impossible eas combinations

In Table 3.10 are shown the possible and impossible combinations between the main parameters. The gray squares are inherited from Table 3.9. Then, an incompatibility between parameters

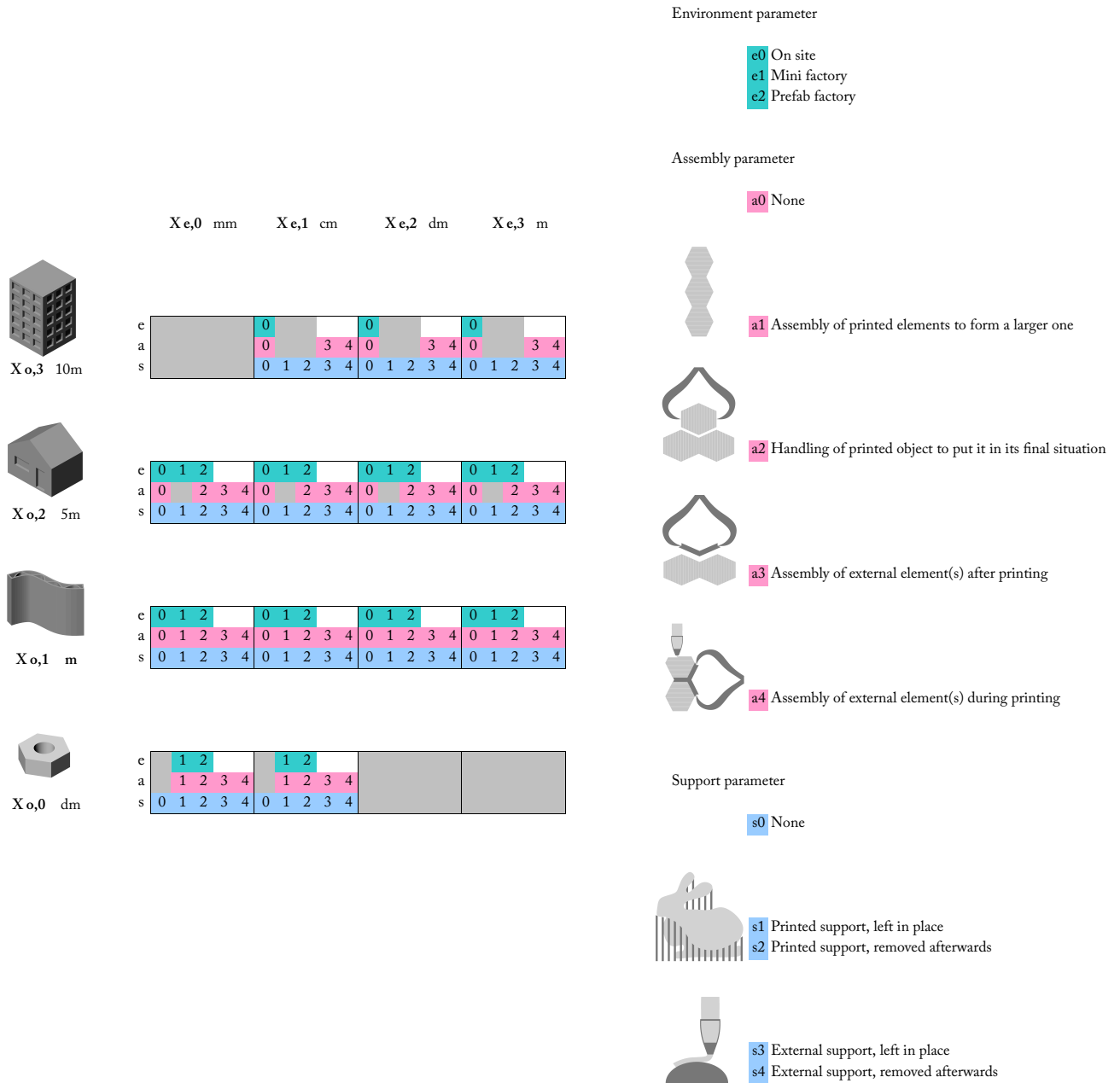


Figure 3.9: Scale variations of parameters e , a , and s

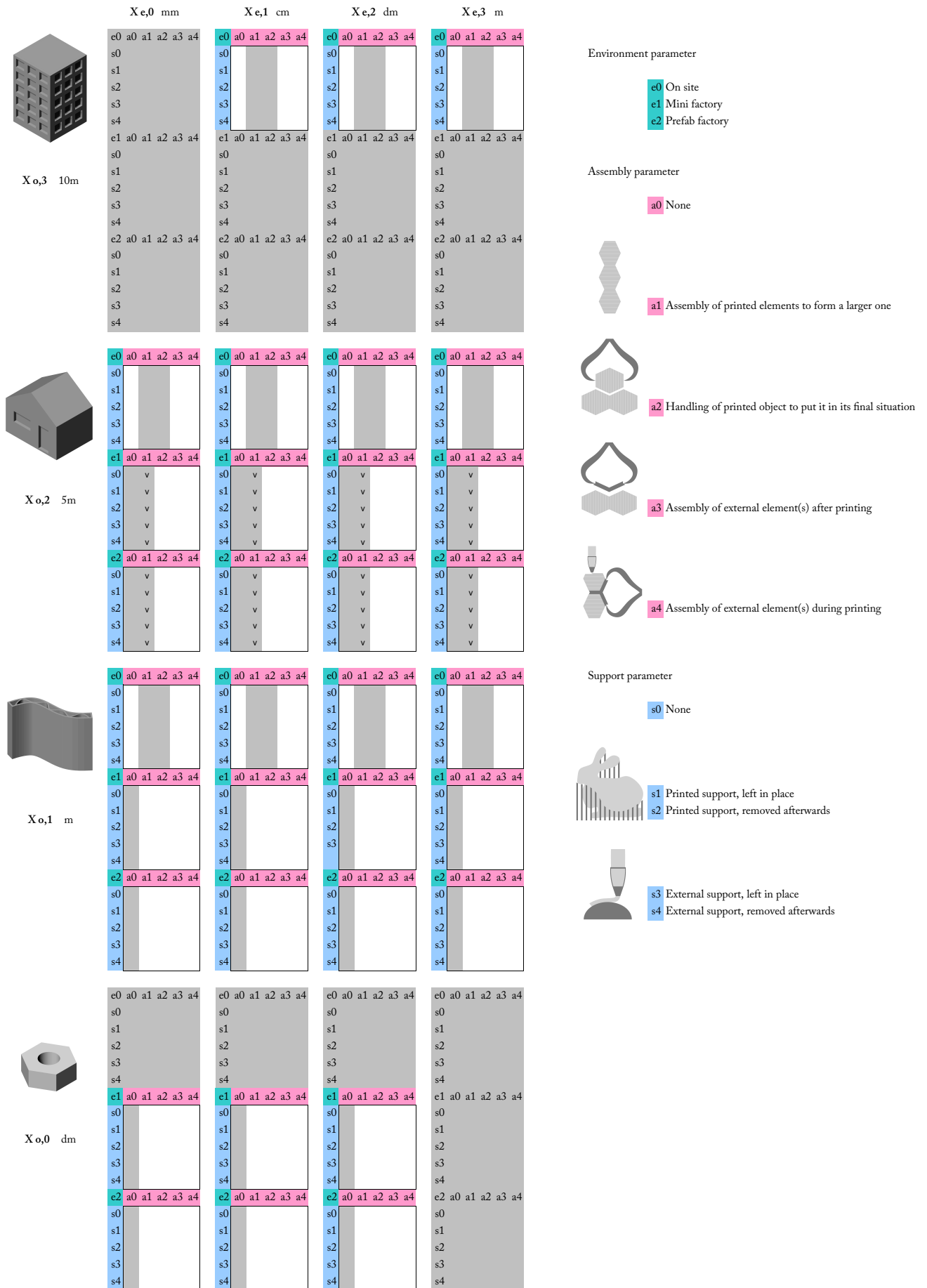


Figure 3.10: Possible eas combinations

e and a can be observed at every scale : a direct, on-site, printing is incompatible with the assembly of previously printed objects, in that case they would be treated as external objects, not concerned by the printing in question. Likewise, any indirect printing needs assembly, so it cannot be combined with a^0 . Therefore we have the following implications :

$$a^{1,2} \Rightarrow (e^i; i > 0) \quad (3.3)$$

$$(e^i; i > 0) \Rightarrow (a^j; j > 0) \quad (3.4)$$

Other impossible combinations, emphasized with down-pointing arrows, are of type $x_0^2 e^{1,2} a^1$ as they correspond to the assembly of very large printed elements to form an even larger structure, which seems absurd. Apart of those trivially wrong combinations, there is no obvious reason to dismiss more. In order to discriminate between building systems one needs to address an additional parameter : robotic complexity.

3.3.4 Parameter r

This parameter is intended to characterize a certain technological complexity associated with building systems. Considering the diversity of existing and future robotics, we cannot be too precise in indicating equipment specificity. Rather, we focus on the following 3 main points for robotic building: geometrical complexity, size, and collaboration. We clarify the different versions of parameter r below.

r^0 One 3-axis robot

This corresponds to the robotics engaged in most concrete printing works today. It goes from little devices printing connections and small building elements to huge 3D printers able to build a whole house structure (mostly gantry cranes [40], and some cable robots [13]). The main advantages of such 3-axis devices is that they are already well developed and one can focus

on secondary robotics devices like printing nozzles. However, they present a lot of limitations in the geometrical complexity of printable forms as well as in the possibility of multi robotics building systems.

r^1 One 6-axis robot

With the use of 6-axis robots, the set of printable forms can be extended, as explained in [31], for the layer can easily vary in their thickness and their orientation. It helps solving the problem of cantilevering printing structures and layer to layer adhesion. Collaboration between robots, and between human and robots is more conceivable with 6-axis robotics, for they have multiple possible paths and orientations, which allows to address collisions problems. The main drawback is that they are limited in size, at least for existing robotic arms.

r^2 One 6-axis robot with an axis at its base (rail)

A way of increasing the printable size of a device is to put a 6-axes robot on a rail, possibly curved, so that it can turn around the element to print. This is an additional complexity for our classification.

r^3 Two 6-axis robots (collaborating)

The next step for building system seems to be collaboration. Robots able to work with each other can bring great innovation to current building techniques, mixing printing and assembly, in a quick and precise fashion. Some attempts have been made in [105]. As far as our classification is concerned, parameter r^i with $i > 2$ means that no human take part to printing : the main advantage to robotic collaboration is speed, and it is incompatible with human workers security.

r^4 Two 6-axis robots with an additional axis at their base

We increase the complexity parameter if the collaboration makes use of moving robots, to print large structures.

r^5 One 6-axis robot on a 3-axis robot

This step represents an additional difficulty for robotics: to be able to maintain precision while moving a robot at large scale and in three dimensions. We include in this version of our parameter cable robotics that promise a lot of control from multiple axes, suspended on 6-8 cables, and lightness of large scale implementation [13].

r^6 Two 6-axis robots on two 3-axis robots

This last version of parameter r corresponds to robotic collaboration with large scale implementation.

3.3.5 Linking main parameters to parameter r

As mentioned above we explore the relations between the process parameters, trying to link them to a minimal robotic complexity. The results appear in Table 3.11. It can be observed that complexity r increases with object scale x_o and decreases with extrusion scale x_e . However, if some versions of parameters a and s yield complexity, it remains possible to perform large scale printing with a sole 3-axis device, denoted by r^0 , using light implementation like cable-structures. At such scale though, the challenge of bringing additional robotic axes rapidly increases complexity.

Concerning parameter s , it is supposed that the help provided by supports increases the number of attainable forms. A printing without support s^0 will be limited by the stacking of fresh concrete layers : slope, holes, and cantilevers are difficult to obtain, and altering the material behaviour can penalize its final properties. Printed support (s^1, s^2) solve this problem by filling some empty parts of the object with material. The simplest way of doing so is to use the same cementitious material and either keep it or cut it out, or one can use an additional material, possibly easier to remove, like raw clay for instance. The printed support strategies focus on printing nozzle development, so the complexity of the primary robotic system is not necessarily at stake. Conversely, the use of external support (s^3, s^4) takes advantage of an pre-existing

geometry to help the printing, that is why a greater need in robot movement variety can be assumed : six axis (r^1) complexity is advisable at small scale, and its further versions (r^2 and r^5) at larger scales.

Concerning assembly parameters a , the version a^4 is strongly related to the complexity of the primary robotic device since it denotes assembly during printing. When extruding a very small mortar lace, the speed is far too high to allow human workers around, therefore the association $x_e^0 a^4$ necessarily implies robotic collaboration (r^3, r^4, r^6). Likewise, when the object scale x_o increases. Furthermore, the particular sets $a^4 s^{3,4}$ denote the use of external supports assembled during printing : the need for precision and robustness here leads to collaboration as well, exception made for the scales $x_o^1 x_e^{2,3}$ where tolerance and speed are more easily handled.

3.3.6 Conclusion

This classification has been published in [24]. It is a first step toward understanding the global question of building systems associated with extrusion based printing processes with cementitious materials. It leads to a more general understanding of what can be called printing. Not only the layered deposition but any automated approach leading to the fabrication of building components, including the use of supports and assembly operation. The map on figures 3.10 and 3.11 show a scope of possibilities quite bigger than the usual focus on the extruded wall house. Much is still left to do to achieve efficient and sustainable automated building systems. In the next chapter, we present a specific approach that can be understood as generalized printing.

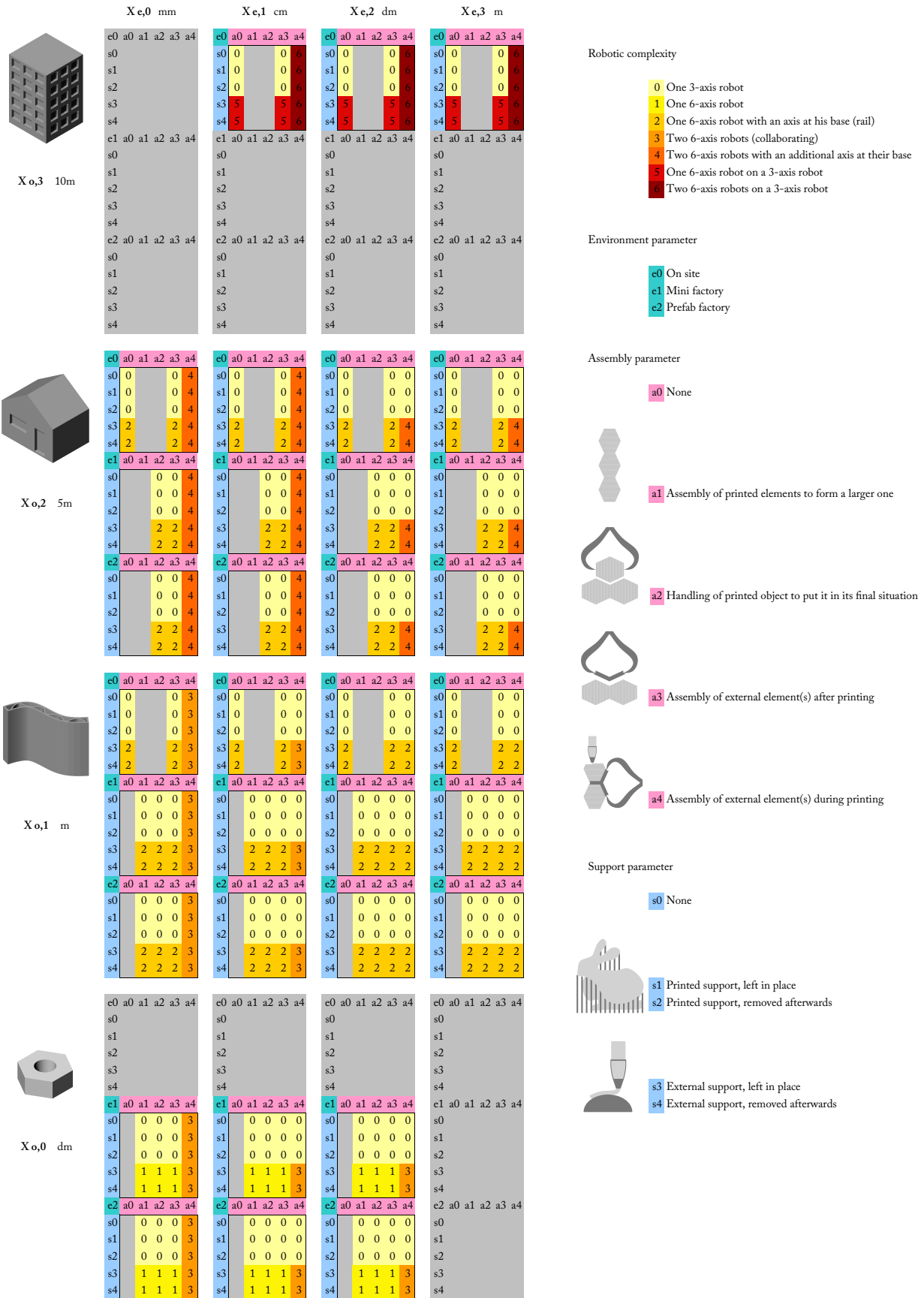


Figure 3.11: Variation of the r parameter : minimum required complexity

Chapter 4

Space truss masonry walls in robotic extrusion

In this chapter, we present a building system making use of cementitious robotic extrusion and assembly of external elements used as supports for the printing. In the classification presented in the previous chapter, this system is included in the $x_o^1 x_e^1 e^2 a^4 s^3$ family.

4.1 Generalized printing process

4.1.1 Process description

Our process involves two simultaneous steps, both to be automated, and therefore needs two robotic arms working together.

Firstly, adequately shaped insulating blocks are made, in our case of polystyrene foam, by robotic hot wire cutting. It is of course possible to use a different process or material for the blocks. A cementitious foam could for instance be of interest, to precisely control the ratio between mechanical resistance and thermal conductivity.

Secondly, the generalized printing takes place. One robot, in our case on a rail track, see figure

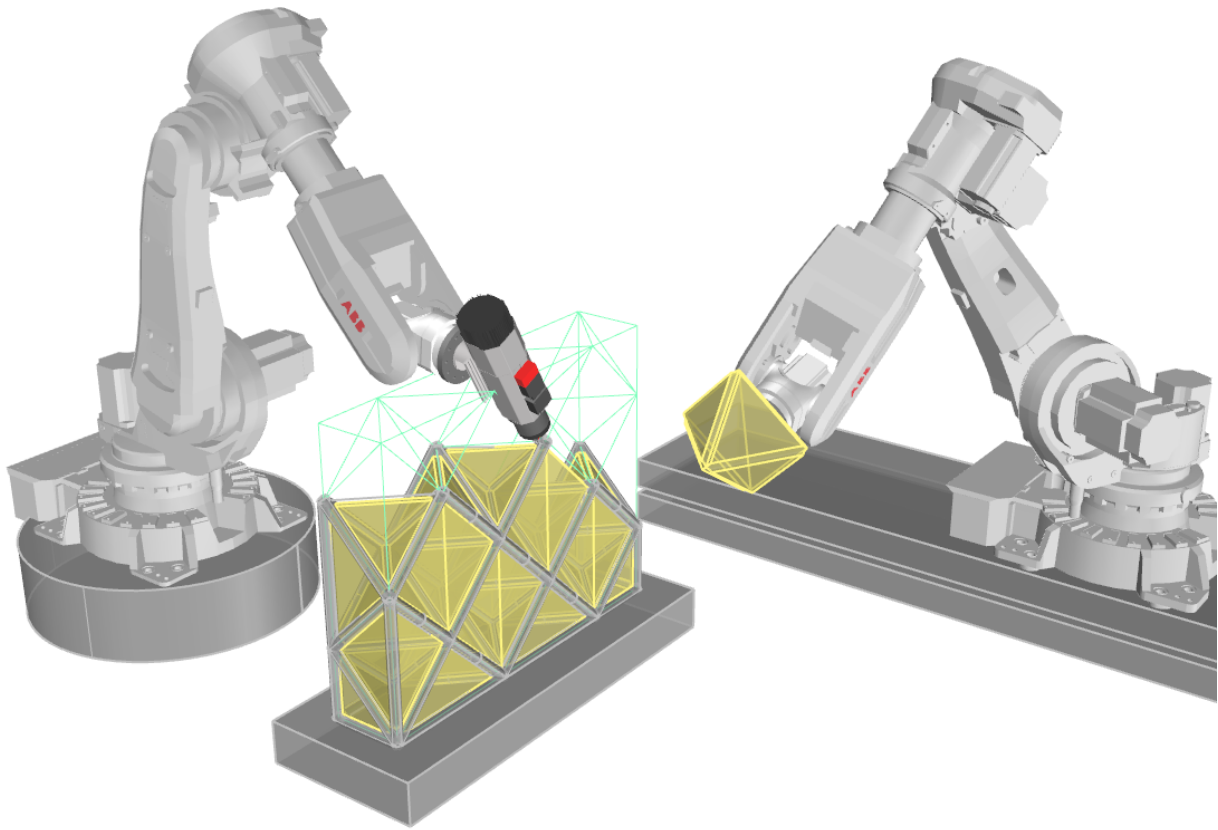


Figure 4.1: Printing mortar while assembling blocks

4.1, brings the blocks to their destination, and the other robot will extrude mortar on them. There is a layer by layer approach, one complete layer of blocks will be printed on, and so forth. The blocks act as a support for the extrusion, that therefore produces geometries unreachable by traditional printing.

Finally, in the context of confined masonry (see section 4.2), form-works for the reinforced concrete frame can be simultaneously printed, by the more classical printing approach.

The geometrical aspect of our principle is based on a space tessellation. The blocks are shaped like polyhedra, on the edges of which the mortar is printed. Since they form a tessellation of the wall volume, their edges form a regular space truss. The final element is a structural and insulating wall. More precisely the edges of each block are carved, in our case by hot-wire cutting, so that they form a canal to receive the mortar, see figure 4.2. This process allows to manufacture a mortar space truss, a very efficient structure that promises great reduction of cement.

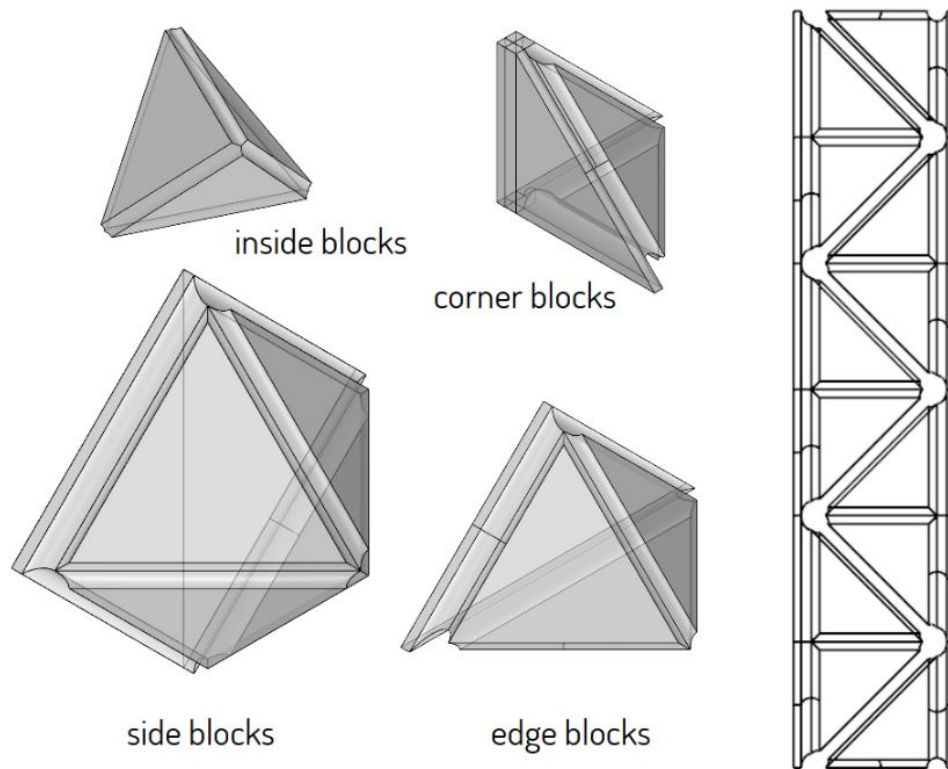


Figure 4.2: Insulating blocks geometry and internal space for the mortar

It is important to note that “printable” mortar is crucial for the operation. Assembling all the insulating elements to pour self-consolidating concrete inside would indeed create several difficulties. If we suppose that such a complex mould can be made, and be perfectly hermetic, it does not ensure that the concrete would fill the entire space. In addition, the foam mould would have to bear the liquid concrete hydrostatic pressure. This is one of the main drawbacks of such strategies. In our case, the mortar gains early age mechanical resistance, as described in [31] and chapter 2, and can progressively work with the foam to withstand its own weight.

Conversely, thanks to the supporting action of the blocks, the rheological need for yield stress associated with the stacking of mortar laces in traditional concrete printing [79] is greatly reduced. Therefore the mortar final mechanical properties are less subject to reduction due to internal defaults, or “cold joints”. Furthermore, the blocks, once assembled, act as a confining element, which is one of the roles of traditional form-work, preventing the fresh mortar from drying and shrinkage. All experimental issues and results are presented in chapter 5.

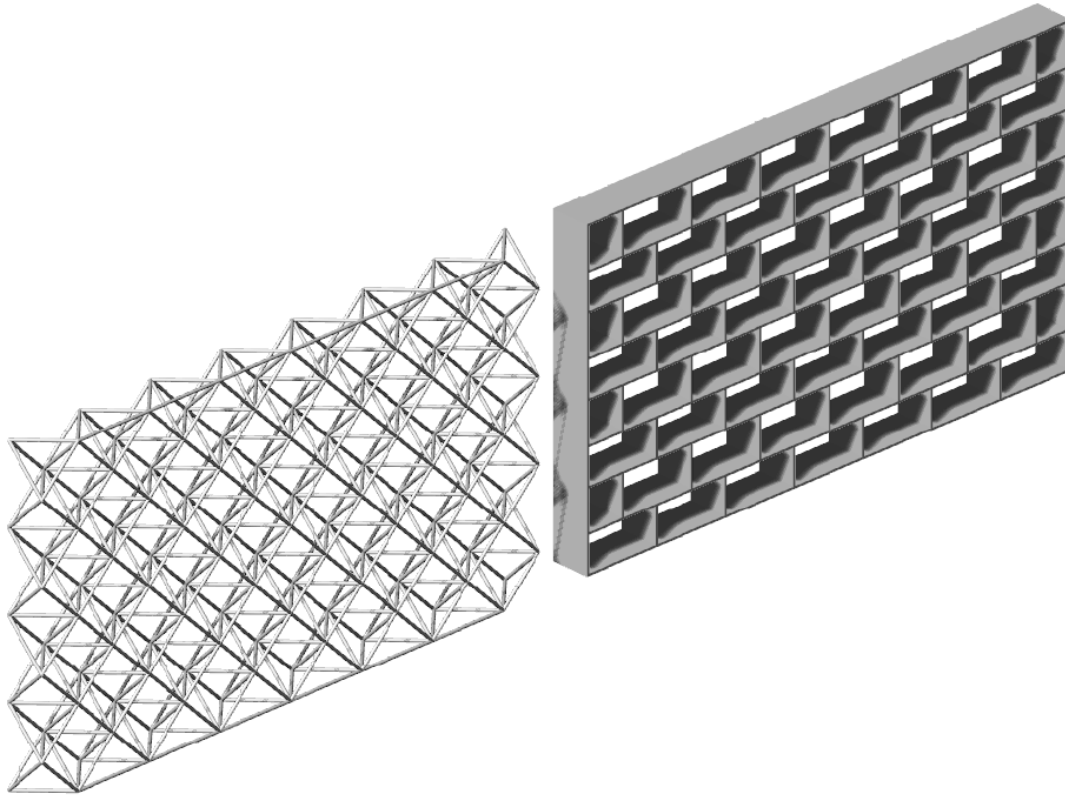


Figure 4.3: Light space truss and traditional breeze-blocks mortar structures

4.2 Unreinforced confined masonry

Because it involves the assembly of blocks, stuck together by mortar, our system can be seen as a generalization of traditional breeze-blocks masonry. We consider here that our mortar is not reinforced, we discuss this possibility later. Without any rebar, the usual breeze-blocks and mortar system has to be restrained in a reinforced concrete frame. In that case, called confined masonry, the frame bears the main part of the imposed loads. The filling's mechanical role is to act as solid continuity, for bracing purpose. It also acts as a separating wall. From a purely structural point of view, this system is quite inefficient. For a single house, and up to several levels building, the need in mechanical resistance of the filling, considering the concrete frame, is indeed very low. Up to a limit it could be said that in the traditional system the mortar alone brings the structural performance. With that in mind it is natural to organize the mortar distribution in a more efficient manner, see figure 4.3. In our system, the mortar forms a space truss, and the wall gets thermal insulation performances in addition.

In the following sections we examine several possible use cases. They are addressed with a parametric multi-objective study. We implement a geometry and examine it according to the following criteria : (a) overall weight, (b) mechanical resistance and (c) thermal conductivity.

We work on Grasshopper¹, a plugin of the 3D modeller Rhinoceros dedicated to parametric modelling. The structural analysis is performed with Karamba 3D², a plugin embedded in Grasshopper dedicated to linear elasticity calculation.

Since our mortar is printable, it has a very low granulometry and exhibits high compressive strength. It is coherent with the making of such light structures (the bar diameters can go down to 40 mm). The structural analysis shows that the maximum tensile stress is the critical value here, it stays true for bigger structures mentioned below. Considering unreinforced mortar, our normative context is confined masonry, governed by Eurocode 6, which does not specify a value for calculated maximum tensile stress. We choose to work with Eurocode 2 value $f_t = 0.3f_{ck}^{2/3}$ while taking additional security factors into account. Our hypothesis for calculus is a C90/105 concrete, and since it is supposed to be non-reinforced mortar, we limit tensile stress to 3 MPa, which is a strongly conservative hypothesis in our case. The fragile behaviour of such a material accounts for those severe hypotheses. They are sufficient for exhibiting the interest of the approach (see table 4.2), yet a weaker material could probably be used. The thermal performances are calculated with a geometrical mean, taking into account a security factor corresponding to member thickness irregularities that can be expected at the nodes when extruding such a structure.

Each use case have a set of parameters and objectives to be evaluated. The multi-objective optimization is conducted with Octopus³, another plugin dedicated to heuristic methods.

¹<https://www.grasshopper3d.com>

²<https://www.karamba3d.com>

³<https://www.food4rhino.com/app/octopus>

4.3 Grid comparison

In order to evaluate the most adequate choice for the space tessellation, we use a parametric model of a truss wall supported on its perimeter. It compares to a single house traditional constrained masonry wall, where the filling mainly acts as separation. Our model isolates the truss from other structural interactions to evaluate its sole capacity. The load cases are weight, horizontal wind pressure, and a third case corresponding to a solid choc (e.g. vandalism) in the middle of the wall. Given the possible lightness of the wall, it is indeed crucial to introduce such a verification, pointless for the traditional breeze-blocks system. This load case is inspired from hand-rails structural checking.

A 2.5 m height and 3 m width are fixed. The varying parameters are depth, bar diameters and tessellation size (opening). This last parameter is bounded by a maximum corresponding to the possibility of getting a 30 cm sphere through the bars. All the possibilities are compared in a three dimensional solution space, corresponding to the three following objectives : surfacic weight, thermal conductivity, and maximum tensile stress.

The parameters are then (1) the type of space truss grid (see next section), (2) the truss thickness and (3) the bars diameters. The compared objectives are (a) additional insulation need (if needed, to reach target U-value of $0.09 W.m^{-2}.K^{-1}$), (b) mechanical efficiency and (c) surfacic weight of the wall.

Different grid topologies are investigated for the concrete space truss in terms of structural efficiency and compatibility with the proposed manufacturing method. These topologies are taken from the edges of a space tessellation of the bounding box of the wall, so that a geometric duality with the polyhedral insulating blocks can be obtained. Considering that fresh mortar will be printed on the blocks, some geometrical configurations are to be avoided. We have retained five potential topologies, that does not present internal vertical members, that would be hard to print. They are listed in table 4.1 and shown on figure 4.4.

On figures 4.5, 4.6, 4.7 and 4.8 are plotted the Pareto fronts of each topology, each point stands for a given set of parameters and all achieve Pareto optimality for the three objectives. Each of

Grid Name	Description	Maximum Node Valence
TriPr	Triangle prisms Semi-Octahedra /	7
SemiOcTe	Tetrahedra	8
OcTe	Octahedra / Tetrahedra	9
CnTri	Counter Running Triangle (Tetrahedra)	10
Hexa	Hexagonal pyramids	12

Table 4.1: Grid Types

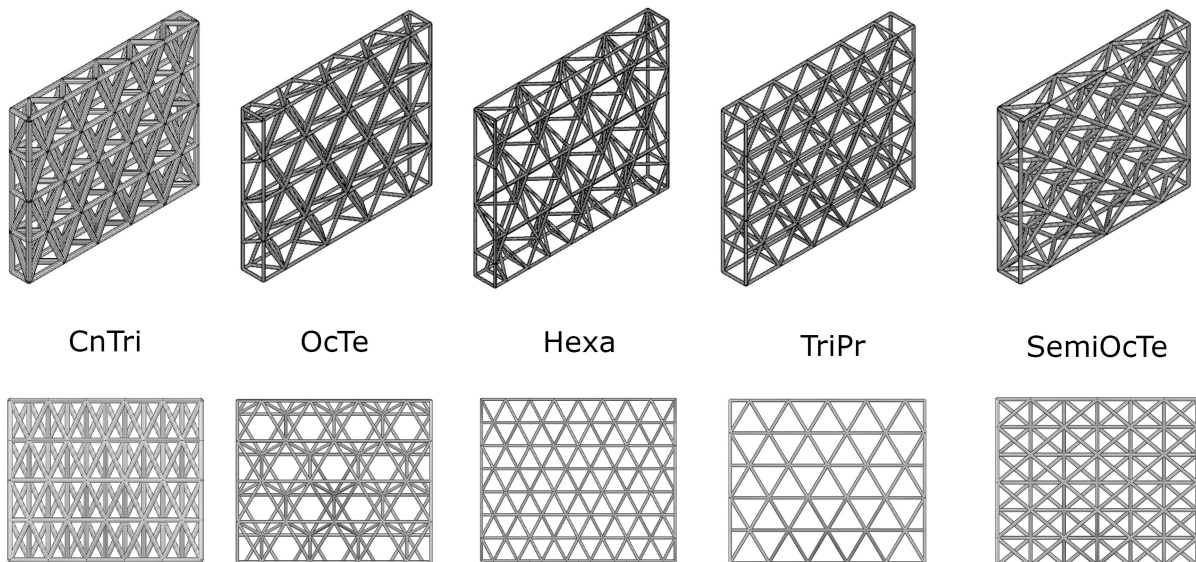


Figure 4.4: Five grid topologies

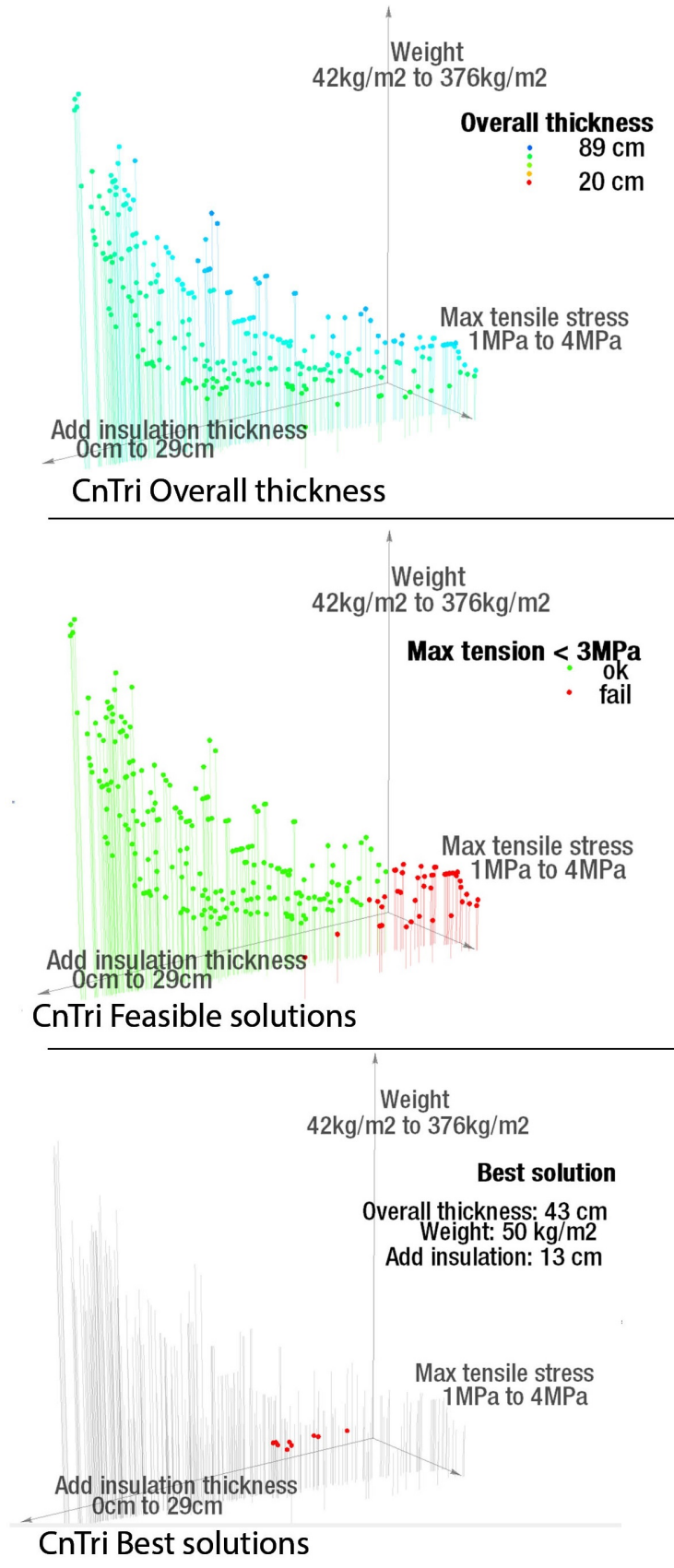


Figure 4.5: Pareto fronts comparison, Counter running triangle tessellation

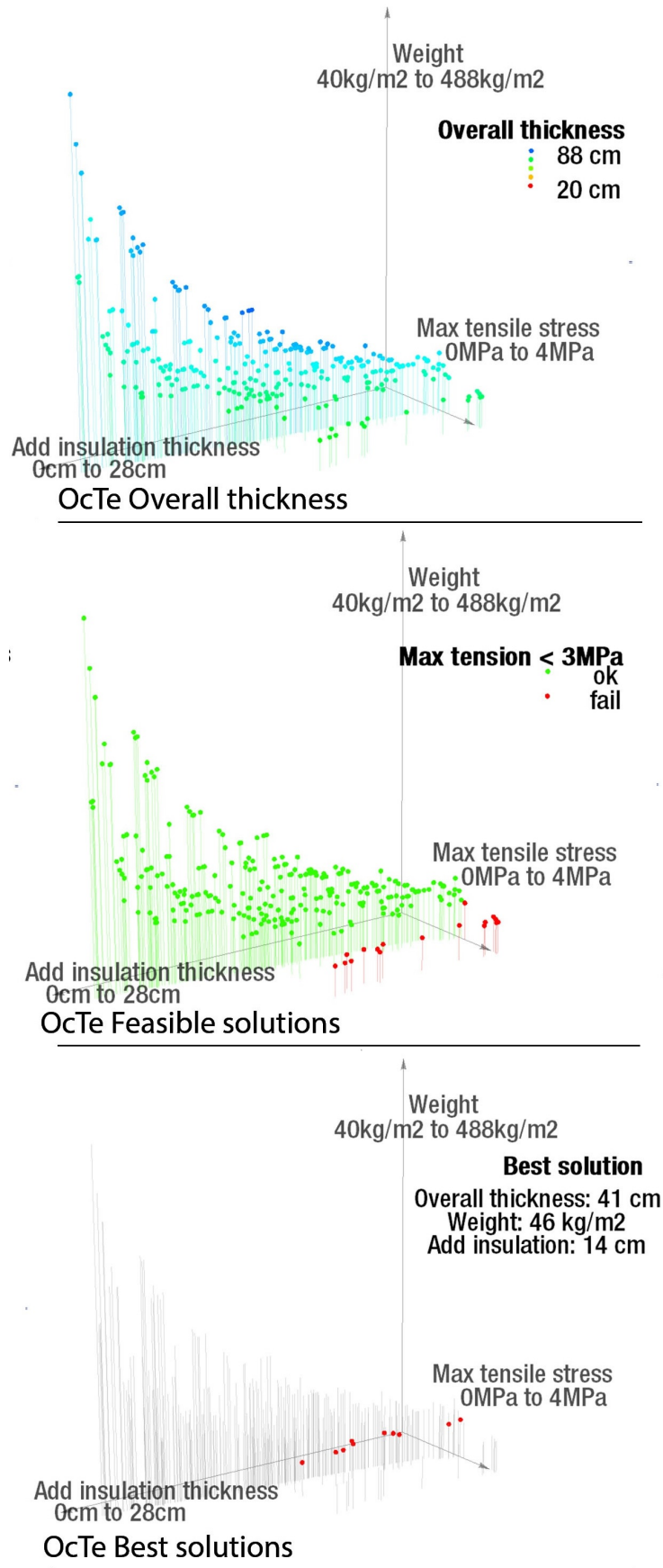


Figure 4.6: Pareto fronts comparison, Octahedra and tetrahedra tessellation

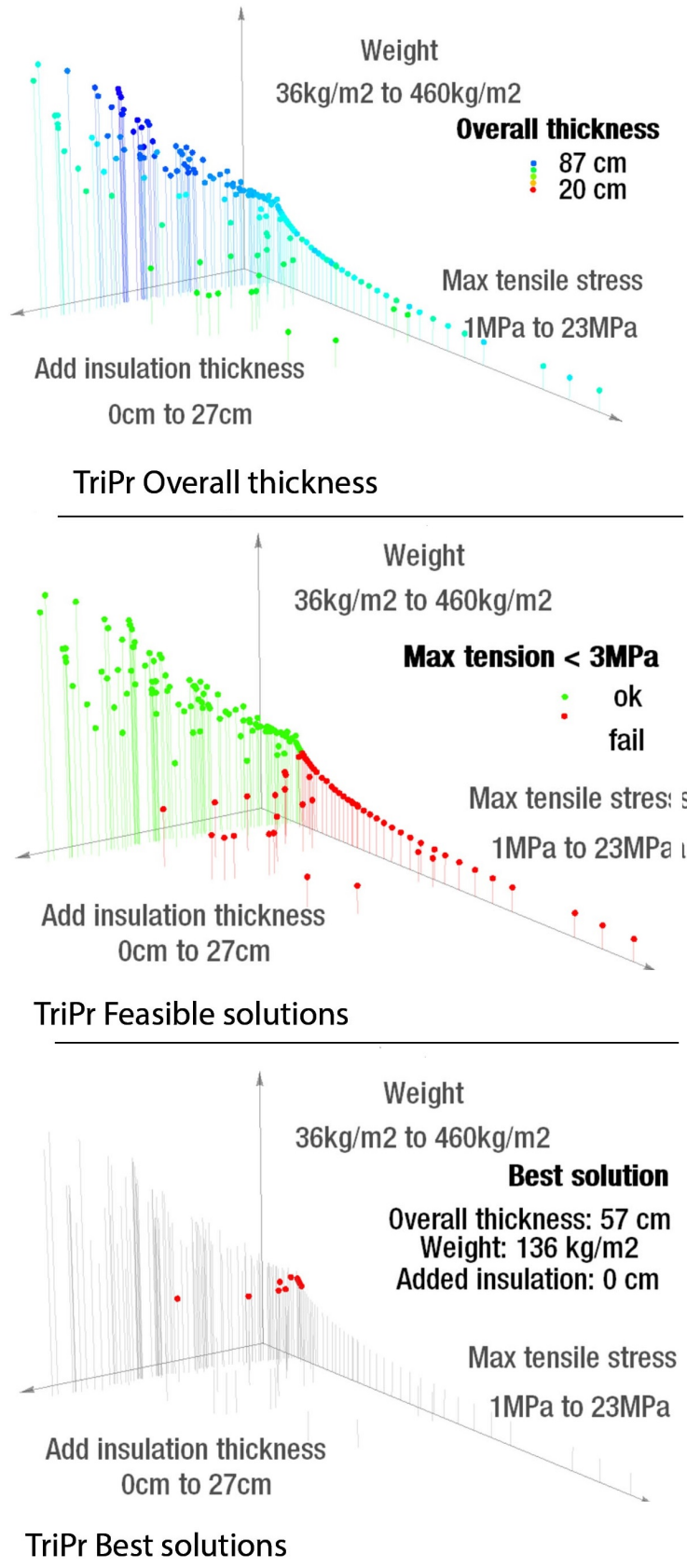


Figure 4.7: Pareto fronts comparison, Triangle prisms tessellation

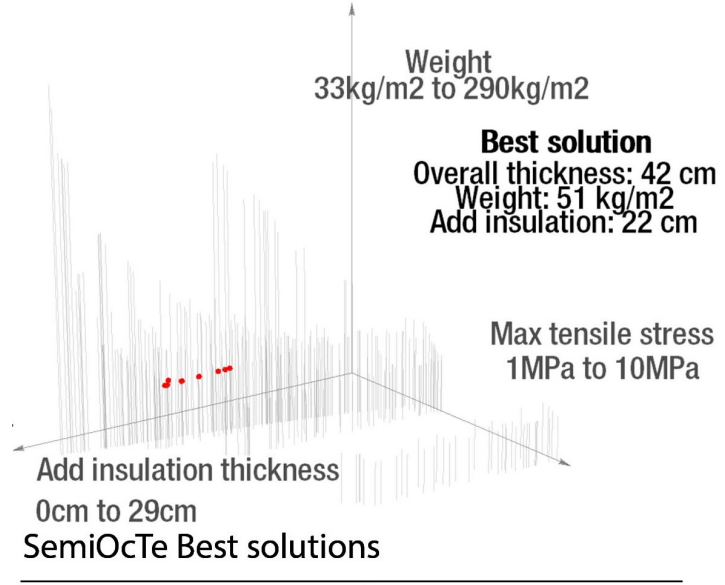
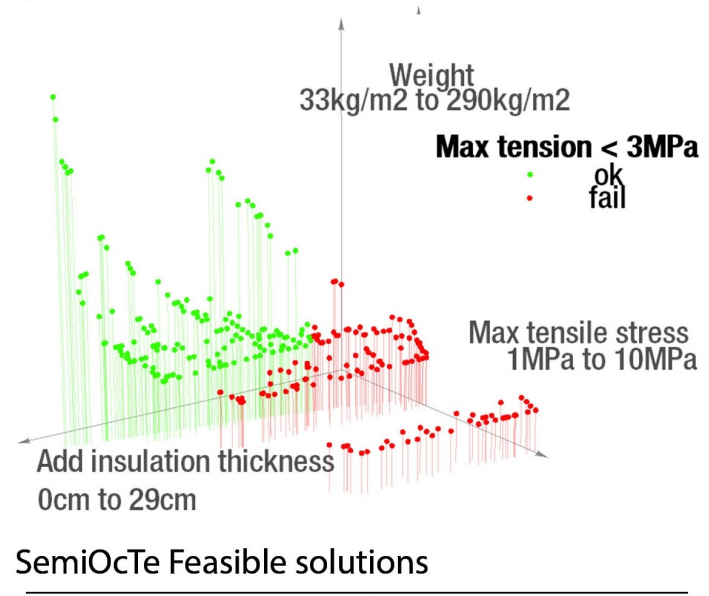
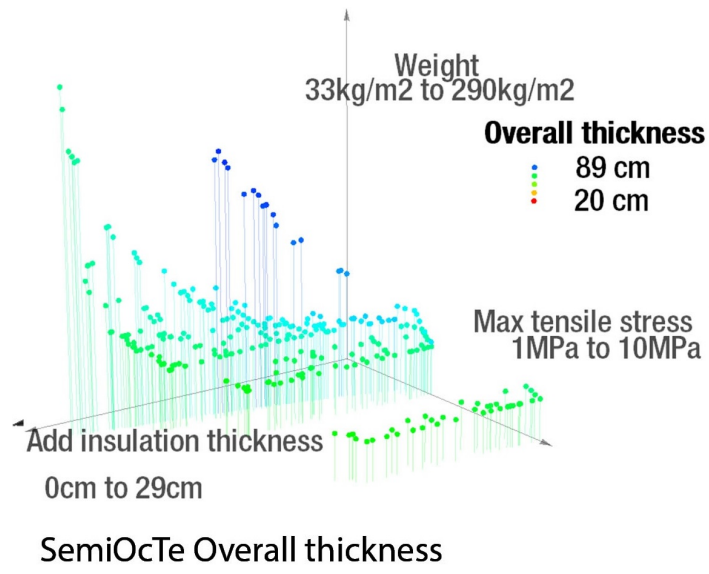


Figure 4.8: Pareto fronts comparison, Semi-octahedra and tetrahedra tessellation

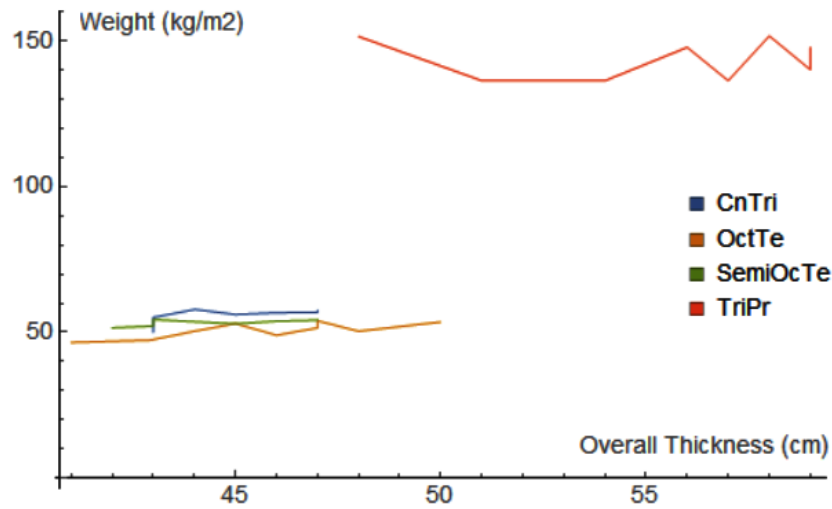


Figure 4.9: Ten best individuals weight / overall thickness

the four line of three graphs corresponds to a specific grid topology. The colors map additional information, respectively the overall thickness of the wall (truss + additional insulation), the solutions below the maximum tensile stress of 3 MPa, and the locations of the lightest of such acceptable individuals. The hexagonal pyramids solution would not allow an acceptable tensile stress for decent weight so the results are not plotted and the topology rejected.

On figure 4.9 are plotted the weight variations with overall thickness for the ten best solutions of each configuration. The goal is to achieve the lightest and the thinnest structure in our context. We observe that the Triangle Prisms topology is the worst configuration. The three other solutions are of similar results for our criteria, therefore the best choice is the Semi Octahedra and Tetrahedra configuration that exhibits the lowest node valence, useful for fabrication purpose.

4.4 Case studies

4.4.1 Single house separating wall

The model used for grid comparison shows that Semi OcTe tessellation allows for good performances for the wall. Indeed it can work under the 3 MPa limit, while getting very strong

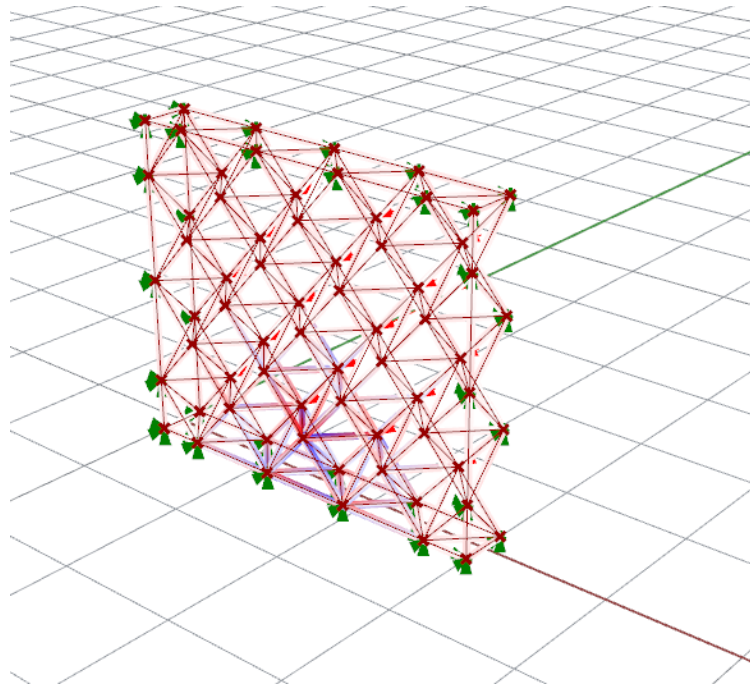


Figure 4.10: Single house separating wall

insulation properties and for an overall thickness of 42 cm. We compare these results to the three following contemporary building systems for structural and insulating walls.

- i A traditional breeze block and mortar system, with 20 cm thick blocks (25x50), and 1 cm mortar joint. With a good insulator, like graphite polystyrene ($\lambda = 0,031$), a 20 cm layer is needed to reach target thermal performance.
- ii A cellular concrete solution, 36 cm thick with 20 cm graphite polystyrene
- iii A pre-wall system consisting in a insulating mould of one 5 cm and one 25 cm insulation layer connected with steel bars, for casting a 12 cm thick concrete wall. Minimum U value is of $0,15 \text{ W}\cdot\text{m}^{-2}\cdot\text{K}^{-1}$

The results in table 4.2 show that for equivalent performances our system greatly reduces overall weight, therefore material consumption.

Wall System	Overall thickness	Weight	U-Value
-	cm	$kg.m^{-2}$	$W.m^{-2}.K^{-1}$
Breeze blocks	40	180	0.1
Cellular concrete	56	150	0.09
Pre-wall	42	220	0.15
Printed truss	42	50	0.09

Table 4.2: Comparison with other systems

4.4.2 Single house shear wall and multi-storey loading

The interaction between filling and frame can be considered for the case of a shear wall. In that case, an in-plane horizontal load case is added to the model and the support conditions are limited to the base plane. The shear load is applied on top of the wall and corresponds to a wind pressure on an hypothetical perpendicular wall of same size. Height is added as varying parameter and maximized, width remains fixed. See figure 5.14.

Analysis shows that the wall can withstand these conditions while keeping the tensile stress of the inside bars under 3 MPa. The frame bears the main part of the forces, that stay in a reasonable range. In that case the tensile stress limit allows a maximum height of 6 meters, and imposes the diameters to go up to 90 mm for an overall thickness of 45 cm. The surfacic weight of such a wall is around $100 kg.m^{-2}$.

A similar approach can be used to check the possibility of bearing additional vertical loads, corresponding to a multi-storey building. The forces are again correctly transferred to the frame, which bears the main part of the compressive forces. See figure 4.12.

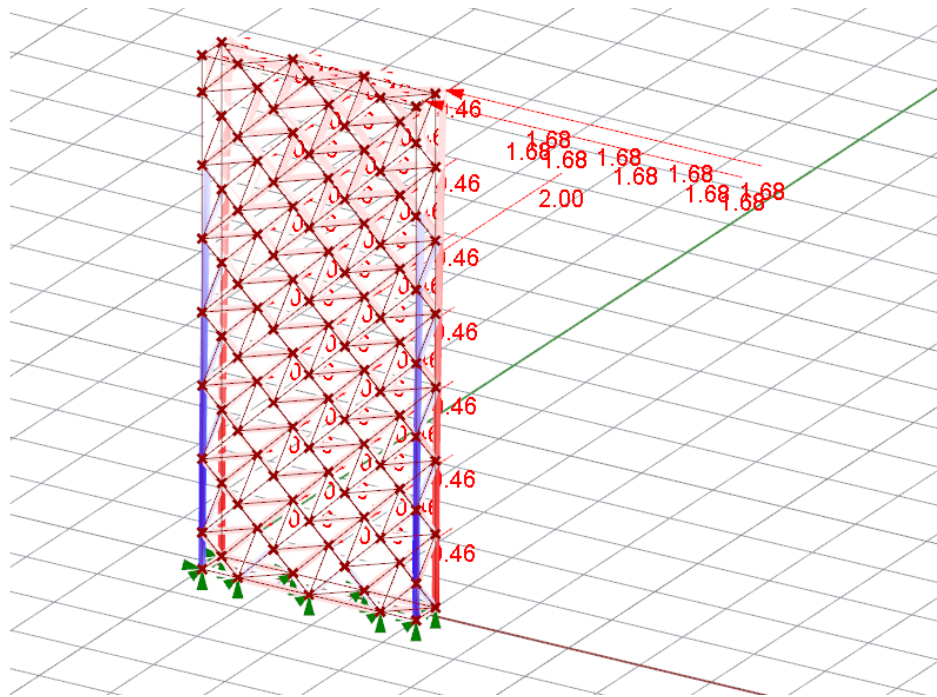


Figure 4.11: Shear wall analysis

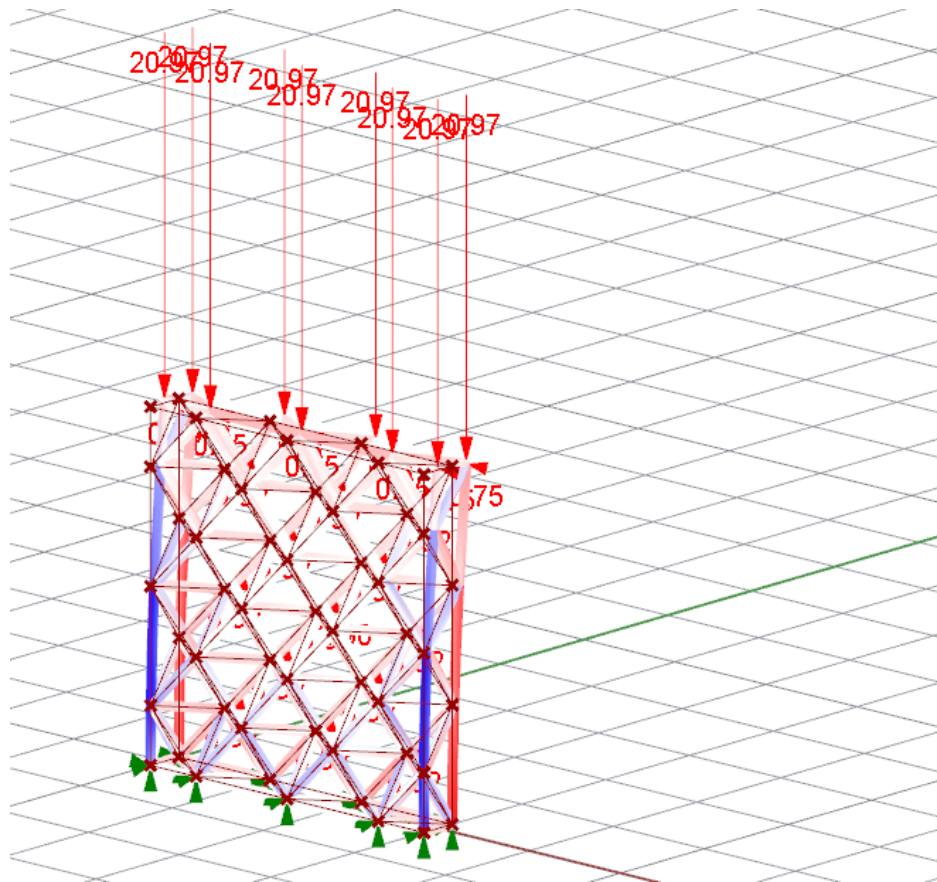


Figure 4.12: Multi-storey load bearing wall

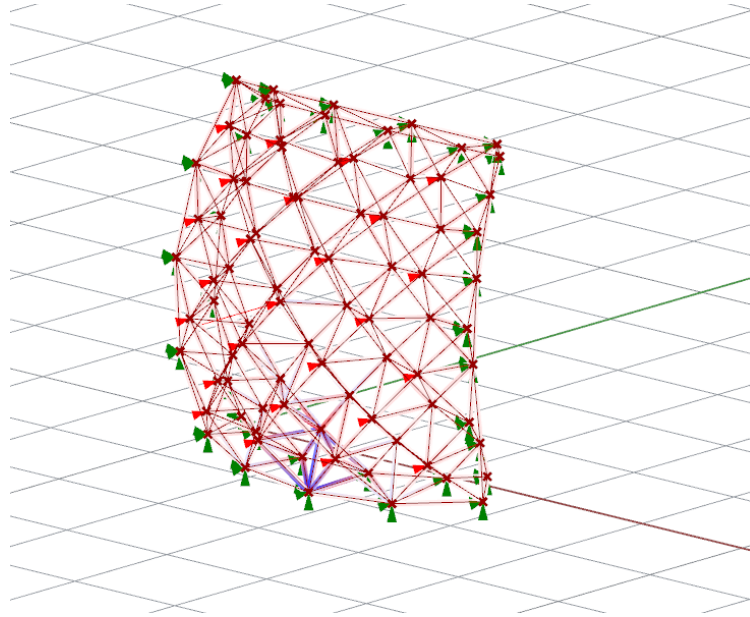


Figure 4.13: Curved wall analysis

4.5 Perspectives: curvature

4.5.1 Curved structures

Additive manufacturing is often mentioned as a mass customization approach, because it is intrinsically unconcerned by any economy of scale. Since there is no mould to cast into, repetitiveness of shape is irrelevant. Each piece can be uniquely shaped, for no additional cost. In that perspective, our approach, while being compared to existing methods with straight walls, can easily deal with curvature. The architectural interest is obvious, but there can also be a structural advantage.

Curved separating wall

As an example we have applied a Moebius transformation to our separating wall, to give him some bump (see figure 4.13). The analysis is performed while taking curvature as an additional parameter. If the wall is convex, in relation to the horizontal loads, then the maximum tensile stress in the bars diminishes with the amount of curvature. This allows to consider curved wall for facade, with the aim of improving their mechanical efficiency.

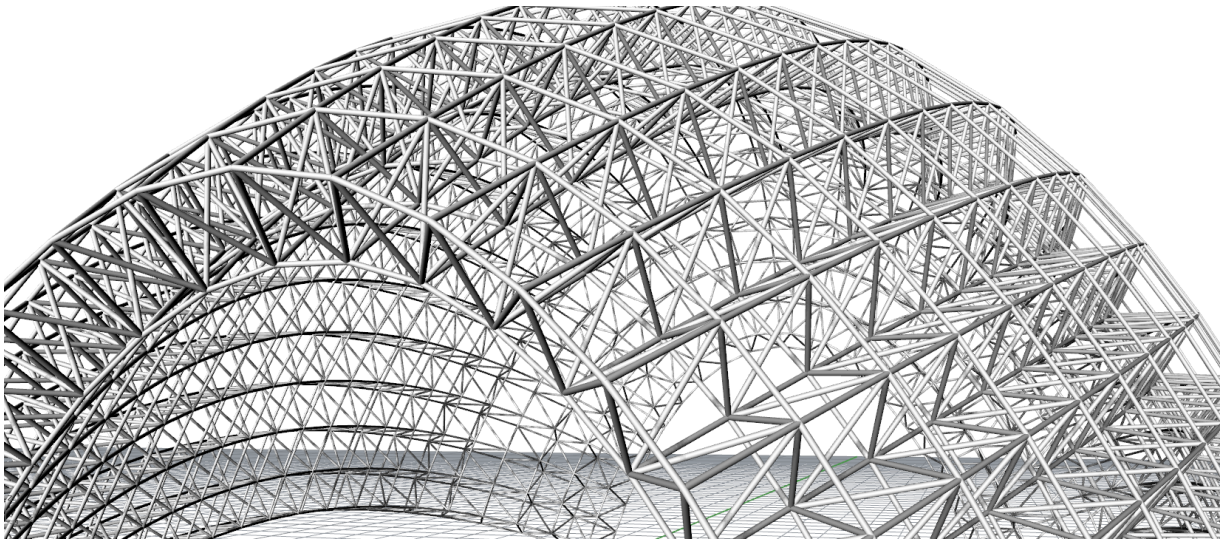


Figure 4.14: Tessellation of a circular mesh

4.5.2 Roofing

This opens perspectives to deal with more complex geometries, e.g. for roof design. Since our tessellation is made of regular polyhedra, the surfacic mesh it corresponds to is made of squares and regular triangles. This is not necessarily the case when curvature is added. However, the same tessellation process can be applied to a general surface mesh, given the fact that it is composed of sufficiently regular quadrangles, and that a regular offset can be done. Such meshes have fortunately been developed in Navier laboratory by R. Mesnil, who has implemented numerical geometry tools to generate conical and circular meshes [57]. They indeed exhibit strong regularity. In particular they are composed only of planar quadrangular facets, all beams intersect on a unique axis, and an offset of the mesh always exists, at a constant node distance. With such a mesh, it is easy to generate our semi-octahedra / tetrahedra tessellation from a complex shell geometry, see figure 4.14. Planarity of the quadrangles is also useful for roof covering.

Chapter 5

Space truss prototyping

In the previous chapter we explained in principle what a hybrid printing system mixing assembly of insulating elements acting as supports could be, and how it could be implemented in a building context. This chapter focuses on experimentation. As a first step, we have conducted a robotic extrusion of mortar, on EPS blocks assembled by hand. Full automation of the assembly process will be a future work.

Manufacturing of insulating blocks in polystyrene constitutes the section 5.1. Mortar extrusion on the blocks to make the trusses was studied and carried out, see section 5.2. Section 5.3 deals with reinforcement and full automation perspectives.

5.1 Insulating blocks

5.1.1 Material Choice

The choice of the material for the insulating blocks depends on the allowed geometrical freedom given by their fabrication, their thermal performance as well as their global environmental impact. Since they need to be prefabricated, the time of their making can be decorrelated from the printing time. The three main way of making them are moulding, cutting and printing (formative, subtractive and additive manufacturing).

Printing would be ideal to reduce waste, provided the energy consumption is not too high. To our knowledge, there is no current insulating material printing process able to produce such precise geometries.

Moulding will only be relevant if the blocks exhibit great geometric repetitiveness, which is the case for a straight wall (only two types of blocks, plus the edges), or if the moulding system is adaptable. Cementitious foam could be used in this context. The main advantages of such a material are its non-toxicity and its customizability. Indeed, substantial variation in both mechanical and thermal properties can be obtained today, including very high insulation. This can be interesting to change the material along the whole building, and also inside the building element itself.

The choice made for present work was to cut expanded polystyrene (EPS) thanks to a robotically controlled hot wire system. If not ideal, this solution presents the advantage of needing little development. It is important to note that the geometry of the blocks naturally produces waste when cut from a plain block. The location of the cuts can be optimized to reduce it, but recycling can also be considered. In the case of EPS, recycling sectors already exist.

5.1.2 Hot wire cutting of polystyrene

Cutting strategies

Depending on the sizes and shape variation of the blocks, different cutting strategies can be chosen. Two items are to be considered: the hot wire and the EPS to be cut. At least one of them has to be mobile. In the case of one hot wire, it is advisable first to produce roughly cut blocks that will next be precisely shaped.

The most automated approach would be to use two robots, one handling the wire and another picking roughly cut blocks to bring them close to the cutting robot. They would have to work together, which raises some difficulties on calibration and precision, if both of them are to move. The picking of EPS blocks also needs some refinement: an automated distribution channel to

bring the rough blocks to the picking robot, a grabbing tool also allowing the disposal of final block and waste.

A more simple approach is to make use of one robot, and one support. The support can also have some mobility, for instance rotational mobility. The wire is either on the support, the robot handling the blocks, with the previously mentioned difficulties, or on the robot itself. We have chosen this last solution, because the robot can operate on two fronts, and cut the rough blocks on one side, precisely cut the final blocks on the other side.

Once the robot has produced the roughly cut blocks, here parallelepipeds of appropriate dimensions, they are manually placed on a customized fixed supporting system, that is described below.

Supporting system

Our strategy for cutting makes use of a fixed support. This choice is relevant as long as one single robot can access the whole surroundings of the block to perform the cut. In our case, the cutting robot is on a 5 meters track, allowing him to translate in one direction. This increases its accessibility. Making use of a moving support, especially rotating to reach specific orientation can also be of help. For our case, the sizes of the blocks (bounded in 40cm^3 cubes) was small enough for our robot (ABB 6620) to reach each cutting paths, provided they are carefully programmed (see 5.1.3). The cutting tool is a wire tight on a 1m by 1m aluminum fork, see figure 5.1.

The support is performed by a claw like strategy, inserting screws in the EPS. The zone were they are inserted will be discarded, therefore it is important to minimize its area. The support has to prevent translation and rotation in all directions. The correctly performed wire cutting supposedly melts the EPS before having any opportunity to mechanically push the block, so the support rigidity needs are quite low. To prevent any unfortunate event, e.g. power outage, to impact the cutting accuracy by moving the block by more than a millimeter, it is though necessary to correctly support it. On figure5.2 we can see the paths performed by the robot. A

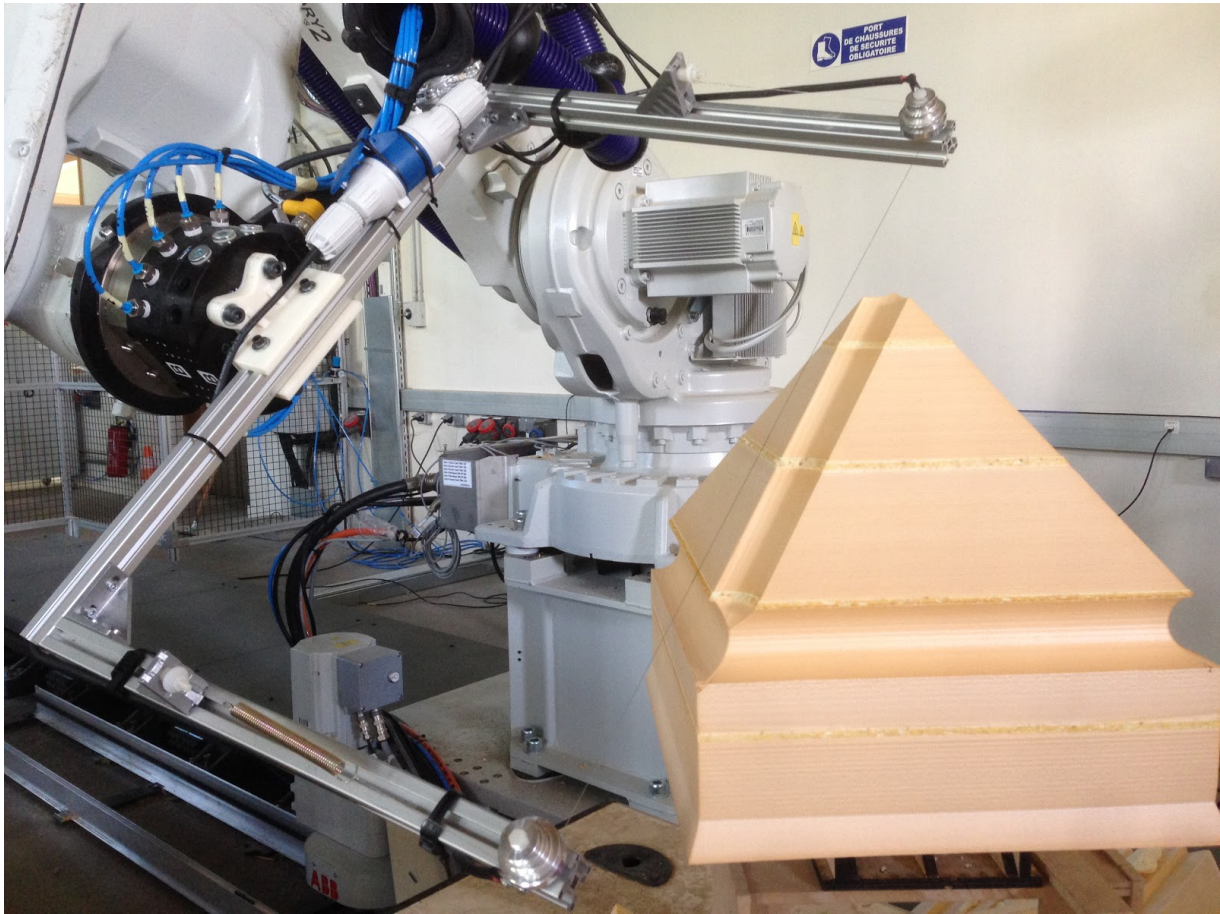


Figure 5.1: Hot wire cutting of insulating blocks

substantial area below the support has to be reachable. That is why we designed the support to minimize its overall volume, and supporting area. The lever arms being quite small, 10 *cm* screws were inserted in specific orientations to block all movement.

Software

The robot is given instruction in its native language, here Rapid for ABB robots. We make use of HAL Robotics ¹, a software able to generate instructions in Rapid from a 3D modelling environment. We work with Grasshopper ², a parametric modelling plug-in for Rhinoceros³. From geometric and kinematic input in Grasshopper, namely series of location, orientation, speed, acceleration supposed to dictate the tool paths, HAL performs an inverse kinematics routine and computes a compatible solution for the robot's axes. In the case of a six-axes robot, for a given path to be followed by the tool, there can be several or no solution for the robot to achieve it [91, 23]. This notion is denoted by the term accessibility.

It is important to note that it is more general than a sole kinematic problem. One tool path is said accessible if there exist a solution for the robot to perform it, and if that solution is compatible with manufacturing environmental conditions. This compatibility can take diverse forms, specifically in a building industry context. Automation of compatibility checking will depend on the nature of external constraints. The less precise the compatibility definition, the more human intervention will be needed for the checking.

Compatibility is mostly about avoiding collisions between the robot, the tool, and external objects in the manufacturing environment. Collision checking can be automated in two senses, as a pre-check, the fidelity of which having to be addressed, and a real time check, quite limited by hardware constraints. The real time checking is often restricted to “hard” collision constraints, to be absolutely avoided. That means collisions with the robot itself, the tool itself and surrounding security zones. Those are embedded in the robot software and they cannot be too complex for latency reasons.

¹<https://hal-robotics.com/>

²<https://www.grasshopper3d.com/>

³<https://www.rhino3d.com/>

Other collisions need to be checked before the robotic procedure is launched, because real time verification will be very limited. They mostly concern mobile objects, like supports, fabricated objects, wire, cables, etc. . . . Some of them are in principle automatable, but to our knowledge no commercial solution exists today. They can strongly depend on the particular task, specifically collisions with the manufactured object.

In the case of subtractive manufacturing like hot wire cutting, the main concern will be to manage the discarded parts so they cannot form an obstacle to the cutting, either when they just have been cut, or by their global accumulation in the robot zone. That means their falling has to be forecast, and waste removal carefully planned. While the cutting of the piece progresses, accessibility increases. Indeed, discarded parts, of less precise dimension, slowly make way to precisely cut parts, of predictable dimensions. In the case of printing however, accessibility diminished with time, while the printed object volume increases. It has to be included in collision checks, especially for security retreat procedures.

Accuracy

All devices need to be calibrated to ensure repeatability and correct positioning in the workspace. The robot itself, within its physical and virtual boundaries, is usually calibrated jointly with the manufacturer. The tool, here the hot wire fork, needs to be calibrated in the workspace to ensure correct precision. This is usually done by declaring enough points to completely define its position in space. For a linear wire, two points at the ends, measured four times each are enough. The robot itself has a very high precision, submillimeter at full speed, but precision loss can happen depending on the tool and the specific task. Interactions with the environment can cause deformations and/or accidental collisions that oblige to re-calibrate the system which is time costly.

For hot wire cutting, accuracy comes also from speed and temperature parameters [3, 15]. The temperature needs to be as low as possible, but directly relates to cutting speed that is to be maximized for productivity reason. All in all the crucial aspect is to prevent any mechanical interaction between the wire and the EPS, that would result in deformation and precision

loss. In this context, the cut pieces are designed using ruled surfaces. They include not only translation surfaces, without rotation of the guiding rules, but also more complex geometries such as cones. In this last case calibration can be crucial because local variation of speed due to complex rotating paths can cause precision loss. Fortunately our polyhedra are only composed of straight faces and regular cylinders, as shown in figures 4.2 and 5.1, therefore the only calibration needed for the system is the distance between the wire trajectory and the resulting geometry, depending on speed and heat. At constant cutting speed, temperature and material, it only needs to be done once. The precision obtained for the present prototyping were around 1 mm which is enough.

5.1.3 Cutting algorithm

The cutting algorithm is suited for any polyhedral tessellation, with or without regularity (e.g. straight or curved wall). It takes a boundary representation of a polyhedron (B-rep) as an input, and computes series of tool-paths, namely lists of oriented planes and their associated settings (speed, type and accuracy of movement, acceleration). This information is then given to HAL that simulates the robotic procedure, evaluate its feasibility, and translate it into RAPID instructions.

Roughly cut EPS parallelepipeds are prepared, based on bounding dimensions for each polyhedron. They are placed on the supporting system to get ready for cutting. To detail the algorithm we take the example of a semi octahedron. On figure 5.2 we can see that in this case the block orientation is based on the extruded part, that will constitute the external insulation of the wall. From bottom to top the roughly cut block is then composed of supporting zone, extruded zone and pyramid zone. In the case of internal tetrahedra there is no extruded zone. On this figure the black line represents the tool-path, described in section 5.1.3 below.

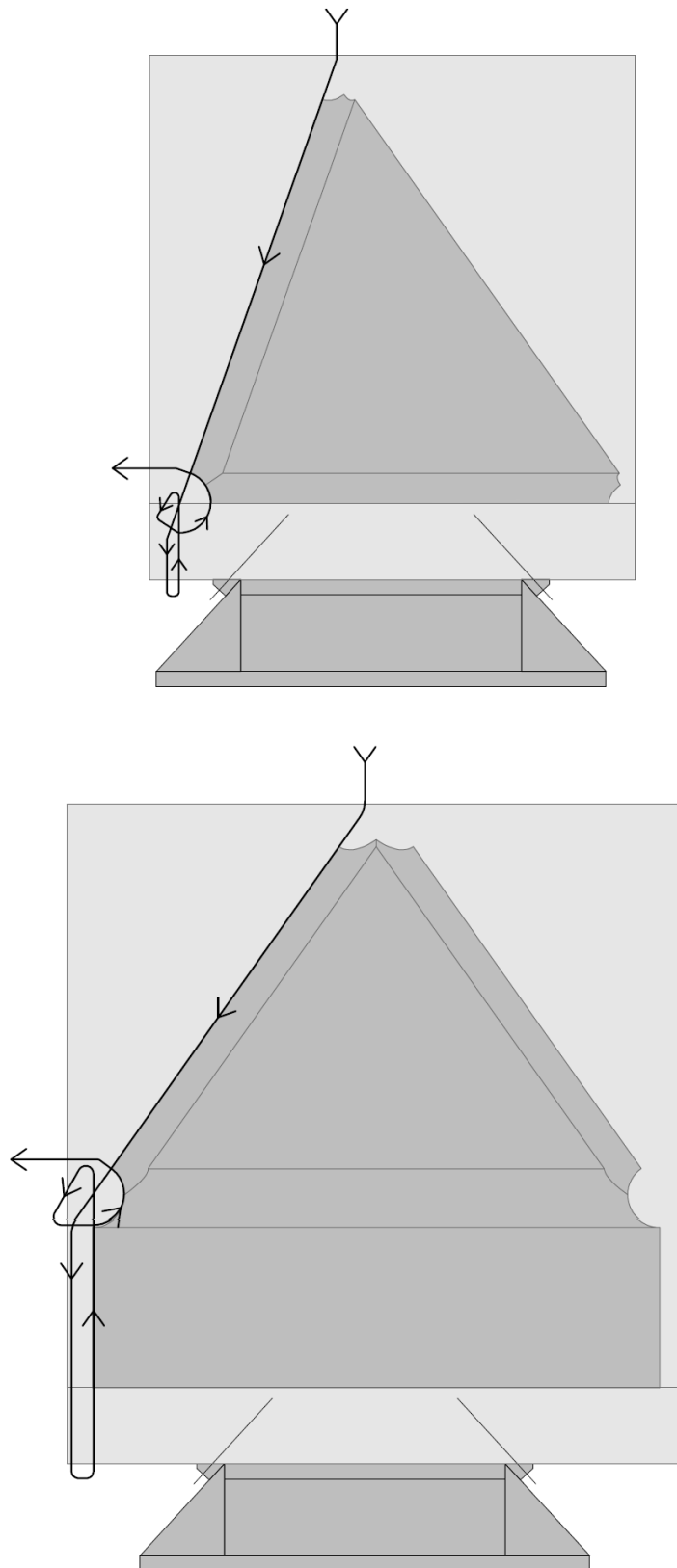


Figure 5.2: Cutting paths principle for the insulating blocs. Starting at the top of the roughly cut initial bloc, going below to allow the unused parts to fall down, then shaping the final form of the extruded part and the channels

Speed

The cutting speed depends on the wire and EPS characteristics. It is calibrated to be as fast as possible, for production purpose. The constraint is that the EPS must not exert any mechanical load on the wire, to prevent its deformation that would result in decreased cutting accuracy. We work with a cutting speed of approximately 10 mm.s^{-1} , while moving speed can be quite fast, provided no human being is around. To optimize the process, the amount of moving speed must be maximized, keeping the cutting speed only when the wire is in the EPS. The key aspect here is that only already cut parts have perfectly predictable geometry, very low tolerance is needed when switching from moving to cutting speed. The tolerance for roughly cut parts depends on the accuracy of the first cut precision and of the block placement on the support. For a 25 cm thick truss, one block is cut in approximately 5 minutes. While managing all the logistics by hand, we were able to produce all the blocks for a 1 m by 2 m prototype in 4 hours, see figure 5.13. Given that this process is automatable, it is reasonably fast.

Cutting paths for octahedra

Here are described the tool-paths for the cutting fork inside the EPS. They are visible on figure 5.2. In light gray are represented the roughly cut blocks, while the future block and support system are in dark gray. The tool-path is the black line.

- Polyhedron extraction

Each face and edge of the input polyhedron is extracted, its main orientation axes and centers detected. Bounding dimensions are calculated, to decide on the roughly cut block size and on polyhedron location and orientation.

- Base face detection

The face that will constitute the base is detected, where the supporting and the eventual extruded zone will be. The block is oriented and located in accordance with the subsequent height information.

- Faces cutting paths

Each face is cut following the profile on figure 5.2, first the pyramid face, then the extruded face, and to finish the channel. For tetrahedra, the same profile is used but without extruded face. The faces are cut in a way and an order compatible with the falling of discarded EPS. Namely, for four faces called A,B,C and D clockwise, the order will be of type A,C,B,D. Moreover, the cutting profile follows the line on figure 5.2. This helps the falling of discarded EPS not to disturb the process, and allows to optimize the tool speed.

- Internal channel paths

The four (three for tetrahedra) channels on the pyramid, that will be internal to the wall, are cut in last. In that case the geometry of the nearly finished block is fully known, allowing for maximum speed in the paths design. Indeed, in the case of fixed support, and for the size of the robot we used, those channels are the trickiest to reach.

- Block removal

The last horizontal cut separates the block from its support, leaving only the bolt zone.

Accessibility

We worked with a fixed support and fixed robot. Allowing one of them to move would increase the accessibility of the cutting paths. Anyway the process works as it is: depending on the overall size of the blocks the support must be placed at an appropriate location. Each cutting path function in the algorithm takes its position as well as the robot location as an input and works its way toward the most accessible strategy. With our approach, the minimum size for the blocks would correspond to a 20 cm thick truss, and the maximum around 40 cm, (insulating layer not included). Therefore it is suited for our application.

5.2 Mortar extrusion

In this section we describe the specificity of this approach concerning mortar extrusion. As explained in chapter 4, this process of making use of the EPS blocks as support for the extruded mortar can be viewed as a generalized printing process. It is indeed a different approach as those mentioned in chapter 2. The pyramid blocks are placed layer by layer, as shown on figure 5.5, 5.6, 5.7 and 5.8. There are two types of layer, one formed by the semi octahedra, and the other by the tetrahedra. Between each block layer there is an extrusion phase. The global process constitutes the printing system. Global material aspects are dealt with in 5.2.1, then a discussion on the printing strategy concerning the extrusion itself in 5.2.2 and in 5.2.3 are presented the results of our prototyping.

5.2.1 Material aspects

As far as material deposition is concerned (parameter m^2 see section 3.2.2), this process is specific in two senses : layer orientation and section shaping. Indeed, the layers can be oriented in the direction of the truss bar (see 5.2.2) which corresponds to the main load they will bear, axial compression and tension. This also gives a new opportunity to fiber reinforcement, see 5.3. The section shaping problem, critical in traditional printing (see chapter 2) is eased by the semi tubular channel of the EPS blocks assembly, see 5.2.2.

The stacking strategy m^3 (see section 3.2.2) here does not properly takes place at the layer interface in one bar but between the macro layers of pyramids glued with mortar. Indeed, in layer interface quality, time between depositions is crucial [100, 90, 54]. The present system (see 5.2.3) exhibits two types of such times. The first is the time between extruded layers, like in traditional printing, which directly depends on the extrusion period length (also called contour length in [79]) and extrusion speed. The second one is the time between the last extruded layer before new blocks are placed and the subsequent layer. This last characteristic time is the most critical for our material because the internal heterogeneities it is concerned with are all located at the truss nodes, where complex stresses will occur. The stacking occurring at the scale of

the block layers lead us to consider this process as a true generalization of mortar printing. Indeed, as it is described in 5.2.2, the mortar gains mechanical resistance as it is deposited, so that it can progressively take on the subsequent layers loads in place of the EPS blocks alone.

One of the main advantage of the mortar/blocks system concerns curing (parameter m^4). Indeed, as mentioned in 3.2.2, the absence of form-work for concrete printing is not only a shaping challenge. Several studies began to address the curing problem for printing, especially when carried out on construction site [100, 90, 54]. In the present case, once the mortar laces are deposited in the semi tubular channels, the next layer of blocks is placed, thus closing the tubes that will protect the mortar and ensure its correct curing.

As for the final material concerns (parameter m^5), the main difference the mortar/blocks system brings along is the new layers orientation inside the material. Provided material homogeneity is ensured in the traditional printing case, respecting the associated time constraint between layers, there is no additional difficulty brought by the blocks. The favourable orientation of the layers in the bars gives a new reinforcement opportunity, see 5.3.

5.2.2 Printing strategies

In this section we detail the available choices to carry out the mortar/blocks generalized printing. We compare them also to other available methods and explain the relevance of the chosen solution. The purpose is to get a sound mortar truss, trapped inside insulating material. The main hypothesis is the progressiveness of the process: one could indeed argue that such structures can be obtained by moulding self-consolidating concrete in the form of a truss. This approach would however raise several difficulties.

First, the mould itself can be costly to manufacture. An example is the pioneering UHPFC space truss by EZCT in Centre Pompidou, see figure 5.3, where a global mould was made of powder bed printed sand and epoxy elements. If we keep the cheaper hot-wire cut EPS blocks and assemble them to form a mould for mortar to be cast inside, the hydro-static pressure induced would ask more of them, and stiffeners would become necessary [40, 30].

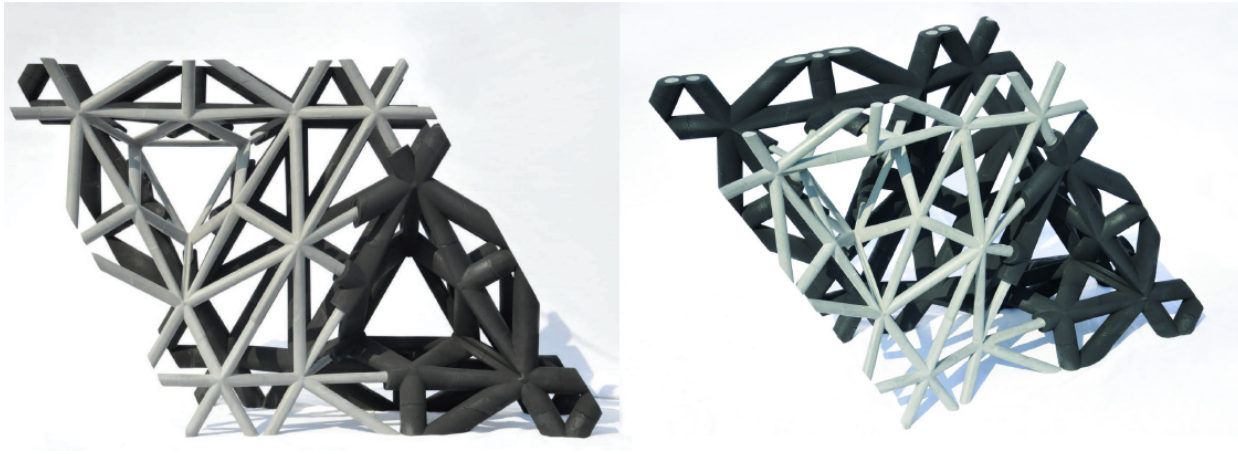


Figure 5.3: Studies in recursive lattice, EZCT Architecture and Design Research, Exhibition Archilab, FRAC Centre Orléans 2013

Secondly, even with an affordable mould, the topological complexity of the truss makes it hard to cast in one go. Even with customized mortar, guarantying each bar is soundly filled is not trivial, especially when dealing with a free-form structure. Moreover, if the truss is to be reinforced, UHPFC could be used, but at a high cost in material design. To prevent fiber segregation and ensure their correct orientation along the structure, high viscosity micro-mortar could be used, but it is likely that the bar diameter would have to increase, and that the casting would be slower than the present solution. At the contrary, the progressiveness of the mortar/blocks printing both allows careful control of each bar, and eases the eventual reinforcement.

Three main strategies can be thought of at this point, that we detail below. Progressive filling of the bars with self-consolidating mortar, oriented pressing on the EPS channels, and free depositing.

Progressive filling

Progressiveness can be achieved by casting self-consolidating mortar in each bar with a robot, maintaining the layer by layer approach, provided the mortar is able to gain early age resistance. The printing tool handled by the robot would have to be able to cast and stop casting mortar, at precise quantities. This raises some industrial concerns since the mortar has to exhibit early age structuration and any stopping would mean having resting fast setting mortar in a

machine. Blocks assembly would also have to provide watertightness. This last aspect makes this strategy less relevant, because more is asked to the blocks that have to realize a perfect assembly by themselves, which raises accuracy, speed and stiffness issues. At the contrary, in the two remaining approaches, the mortar acts as a glue between the blocks, just as traditional breeze blocks systems. That way, precision demand diminishes.

Oriented pressing

As mentioned in 5.2.1, contrary to traditional concrete printing, the extrusion takes place on a EPS channel, that has to be filled. Thus deformation of the layers is allowed, and even advisable to a certain extent. Extruded lace shaping (see 2.2.2) is therefore irrelevant. Oriented lace pressing (see 2.2.3) seems a natural way of respecting the highly complex printing support constituted by the blocks.

However, orienting the printing head perpendicular to each bar raises some concerns. Indeed, having the head orientation change at each node means rapidly rotate of a 90 degrees angle. This diminishes accessibility, as extreme parts of the robot accessible zone for a fixed position of the head, e.g. vertical, eventually rotating in an horizontal plane, will become unreachable when varying orientation.

Moreover, at the extrusion level, nodes constitutes singular zones when the lace pressing is disturbed. At each node, the mortar must be freely deposited, as presented below. Lace pressing at the nodes could theoretically be achieved by carefully shaping the blocks so that a continuous change of curvature occurs in the channel axis. Yet, to significantly soften the slope switch, high curvature radius would be needed for the bevel, thus increasing the amount of material at the nodes. In conclusion, the oriented pressing has to rapidly switch to free deposition at the nodes, and complicates the deposition problem by imposing a rapid rotation of the printing head. That is why we have retained the last option for the experiments.

Free depositing

The support provided by the EPS blocks has a mechanical and shaping role. The mortar is supposed to fill the channels almost completely to reproduce the targeted diameters for the bars. Therefore any layered printing approach would have to allow lace deformation at deposition. Cold joints [100, 90, 54] are less likely to happen in this context as they relate to fresh state mechanical properties of the material. This can be viewed as a fourth printing strategy, completing those mentioned in 2.2, see figure 5.4. It is where the nozzle shape has the least influence on the shape, for it is prescribed by the support. Early age structuration is diminished compared to other strategies, here the limit case being flowing along the channel and not section deformation. Depending on flow rate, nozzle direction and speed, and deposition height, the mortar can behave in various ways. Coiling can happen when deposition height or flow rate are too high [16]. Slope is also an issue, since the deposition regime will differ between uphill and downhill orientation. Prototyping details are given in section 5.2.3.

5.2.3 Prototyping

Extrusion paths

Since a layered printing strategy has been chosen, extrusion paths must be carefully designed. As explained before, stopping mortar flow through the nozzle can be an issue, it is thus better to avoid it if possible. Printing continuity can be achieved by choosing paths that visits each EPS channel exactly once. Our truss being formed of connected bars, it can be viewed as a 3D graph. Continuous paths visiting each bar of a graph once are called eulerian, and they are important for 3D printing. In our case, the nozzle has to follow a non-eulerian graph, it is therefore impossible to have a complete path visiting each channel. Nevertheless, since a layered strategy is adopted, and each channel can be visited more than one time, it is possible to design complementary eulerian paths that will ensure, once combined, the same number of layers for each channel.

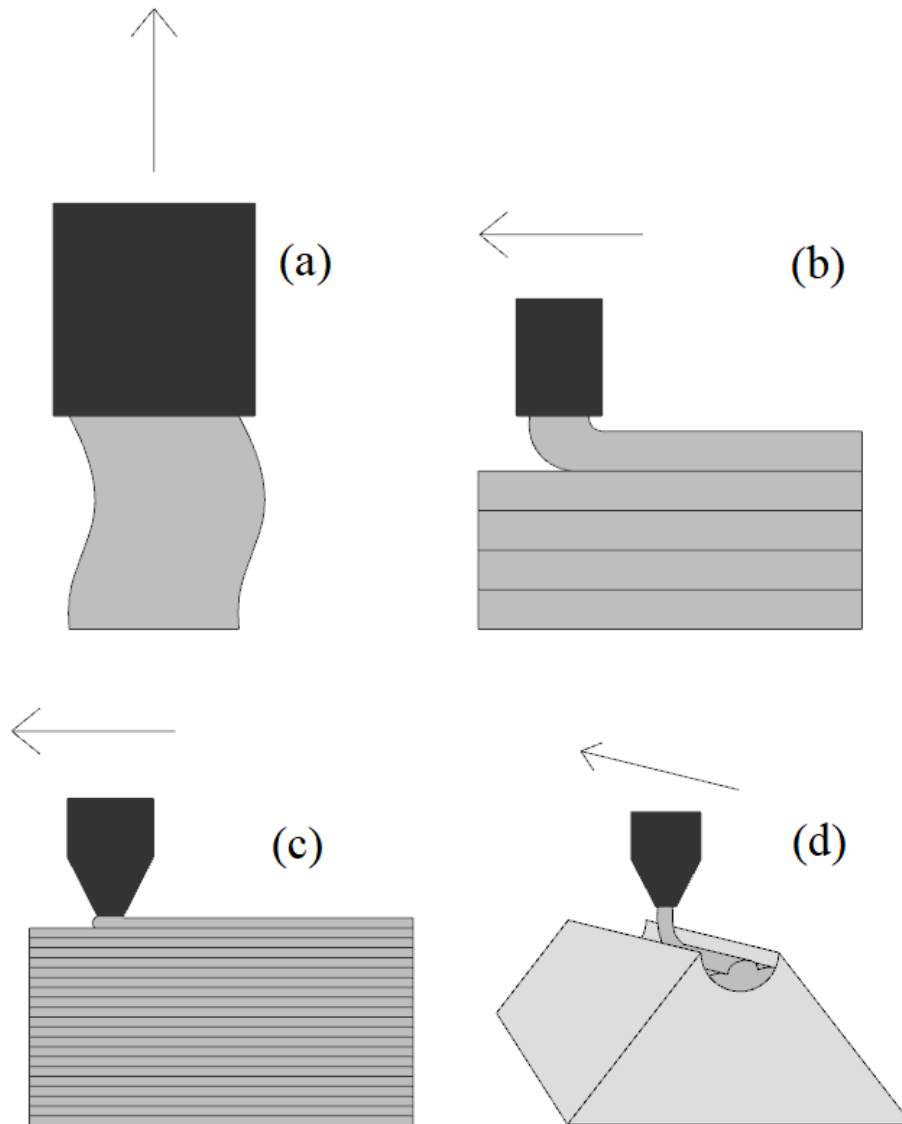


Figure 5.4: The four printing strategies (a) Slip forming, (b) Extruded shaping, (c) Oriented pressing and (d) Free depositing

More precisely, and as shown on figures 5.5, 5.6, 5.7 and 5.8, the making off a wall with the present method can be divided in two main steps. The first step is the placement of semi octahedra blocks on the previous ones, or on the initial support, and the subsequent printing of an horizontal diagonal layer, see figure 5.6. Then the tetrahedral blocks are placed, see figure 5.7, and the remaining non horizontal channels are filled, see figure 5.8. At this point, going back to first step, semi octahedra are placed again and the horizontal upper channels filled etc.

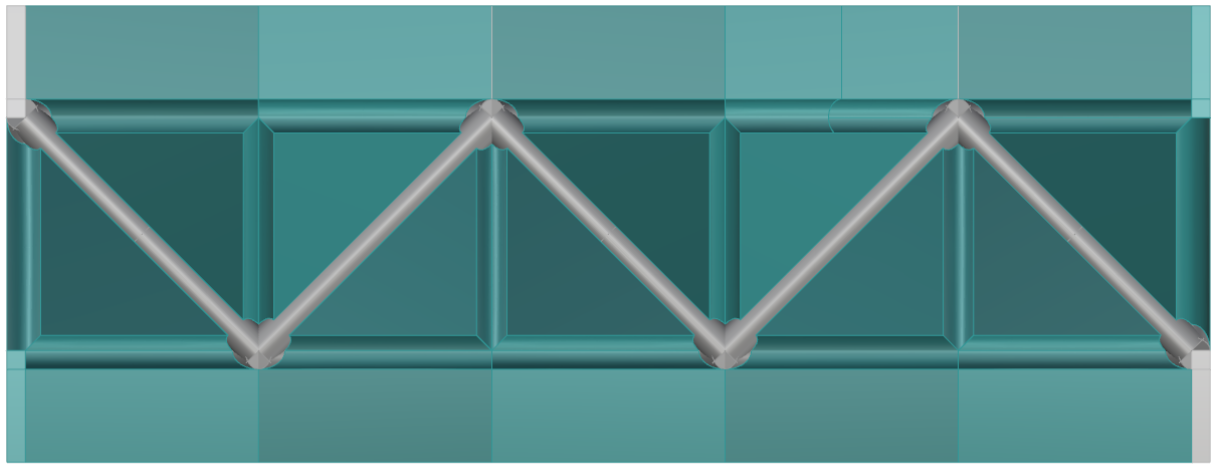
Two printing paths are to be designed. For the horizontal channels it is a simple continuous line, that can be followed back and forth, see figure 5.9. This is an eulerian path. The horizontal channels however form a non eulerian graph, that has the topology of a ladder, see figures 5.8 and 5.10. It can be divided in two eulerian paths, the combination of which will ensure that each channel is visited exactly two times. The repetition of this path is compatible with an even number of layer.

Mortar deposition

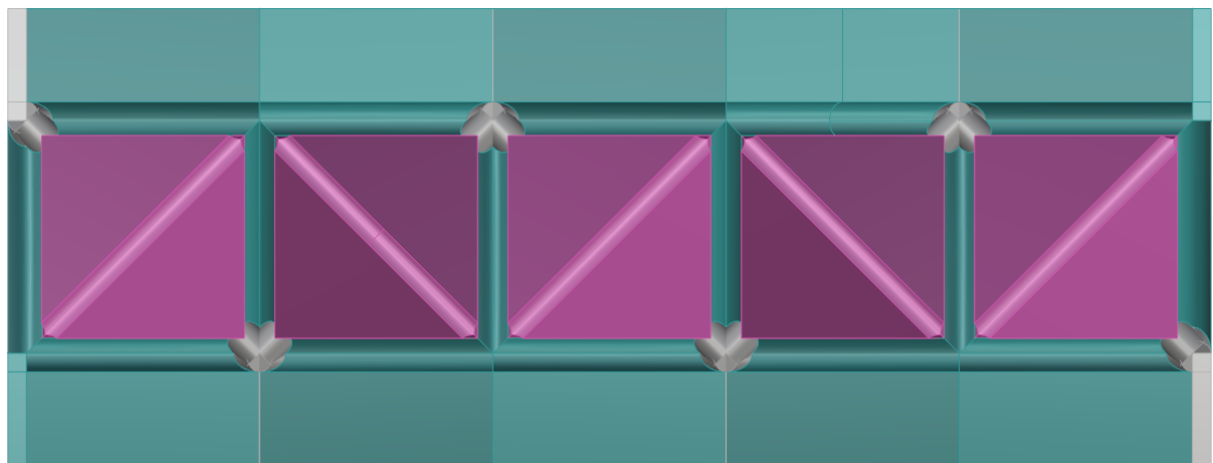
As explained in the previous section, the printing is conducted in a free deposition fashion, where the mortar lace is neither shaped nor pressed by the nozzle. It falls freely, due to gravity and flow rate of the pump, and is expected to form a sound layer on top of the previous laces. This process depends mainly on mortar viscosity, nozzle speed, nozzle height (distance to the support/previous layer), flow rate and slope orientation. In this section we detail how those are calibrated.

Nozzle speed is maximized, for productivity reasons, and the quantity of admixture added in the mortar in the nozzle minimized, to ensure material homogeneity between layers. The critical points for layer homogeneity are not located along the channels but at each nodes, between macro layers previously detailed, see section 5.2.1. Moreover, it is advisable not to change the admixture quantity along the object if possible, to diminish global complexity.

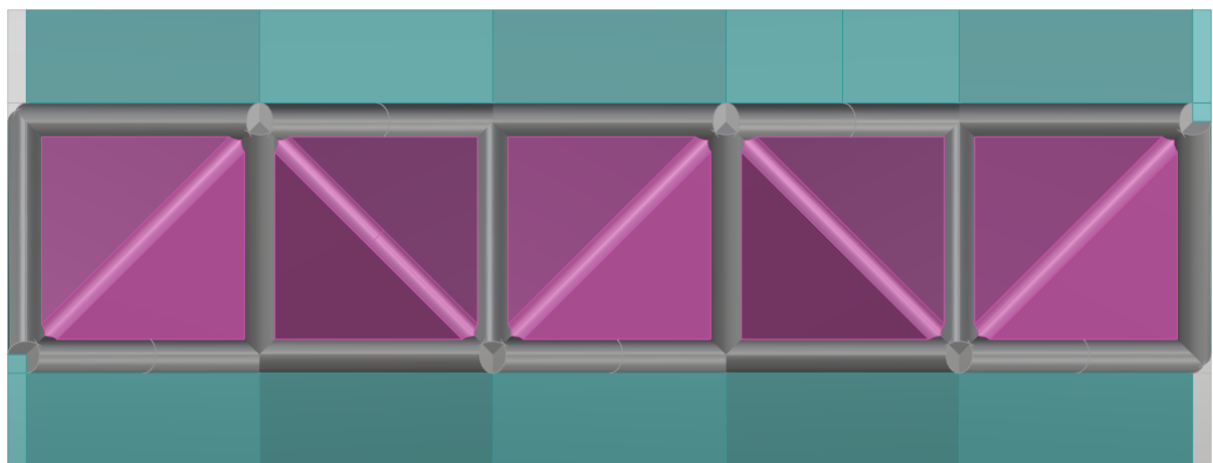
There are three deposition regimes, depending on the channels slopes. Horizontal channels, uphill channels and downhill channels. For the prototyping of a straight wall, the angles were



(a)



(b)



(c)

Figure 5.5: Top view of the macroscopic layer for truss printing. (a) Horizontal channels are filled ; (b) Tetrahedra are placed ; (c) Non-horizontal channels are filled

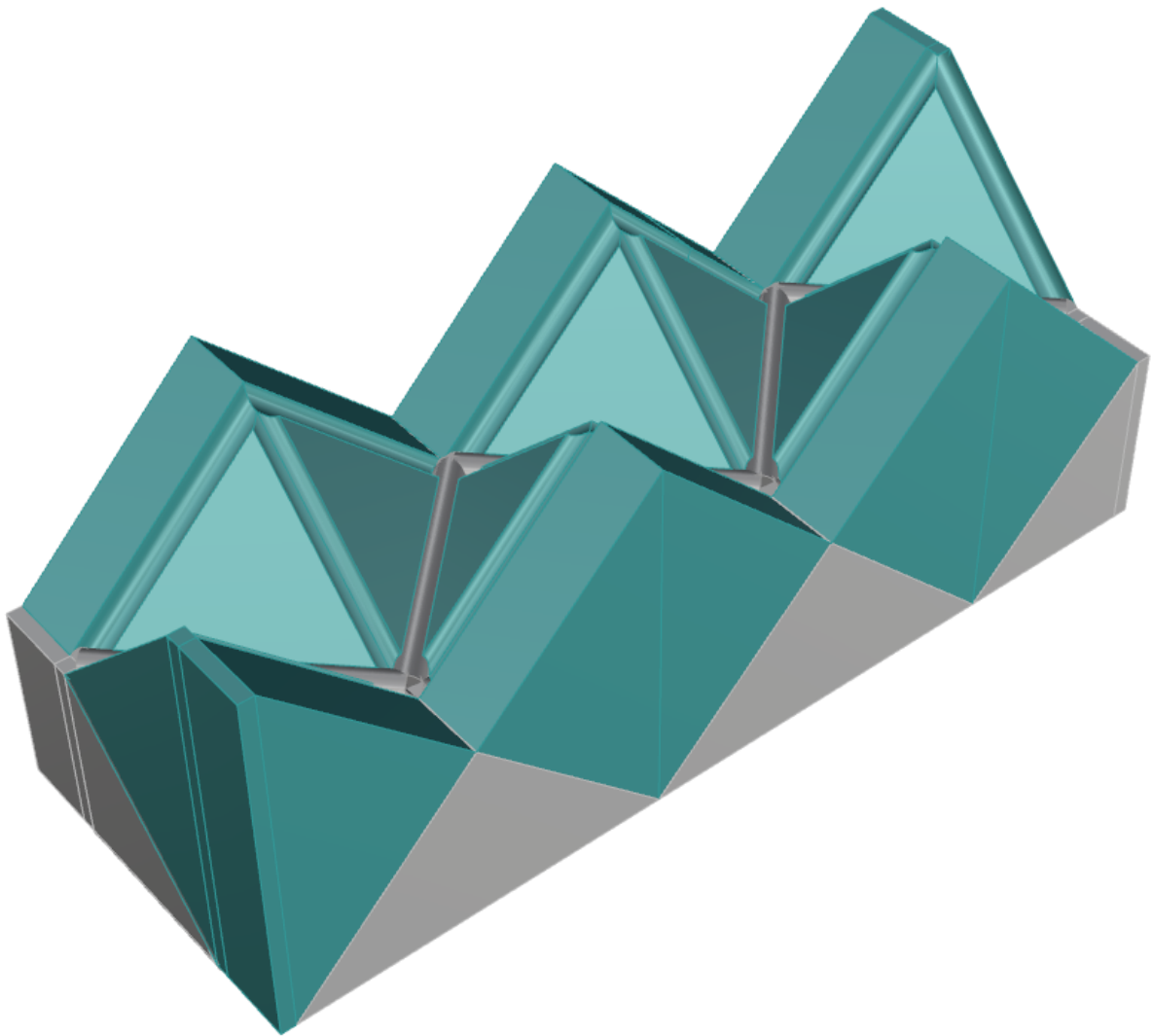


Figure 5.6: 3D view of step (a) : Horizontal channels filling

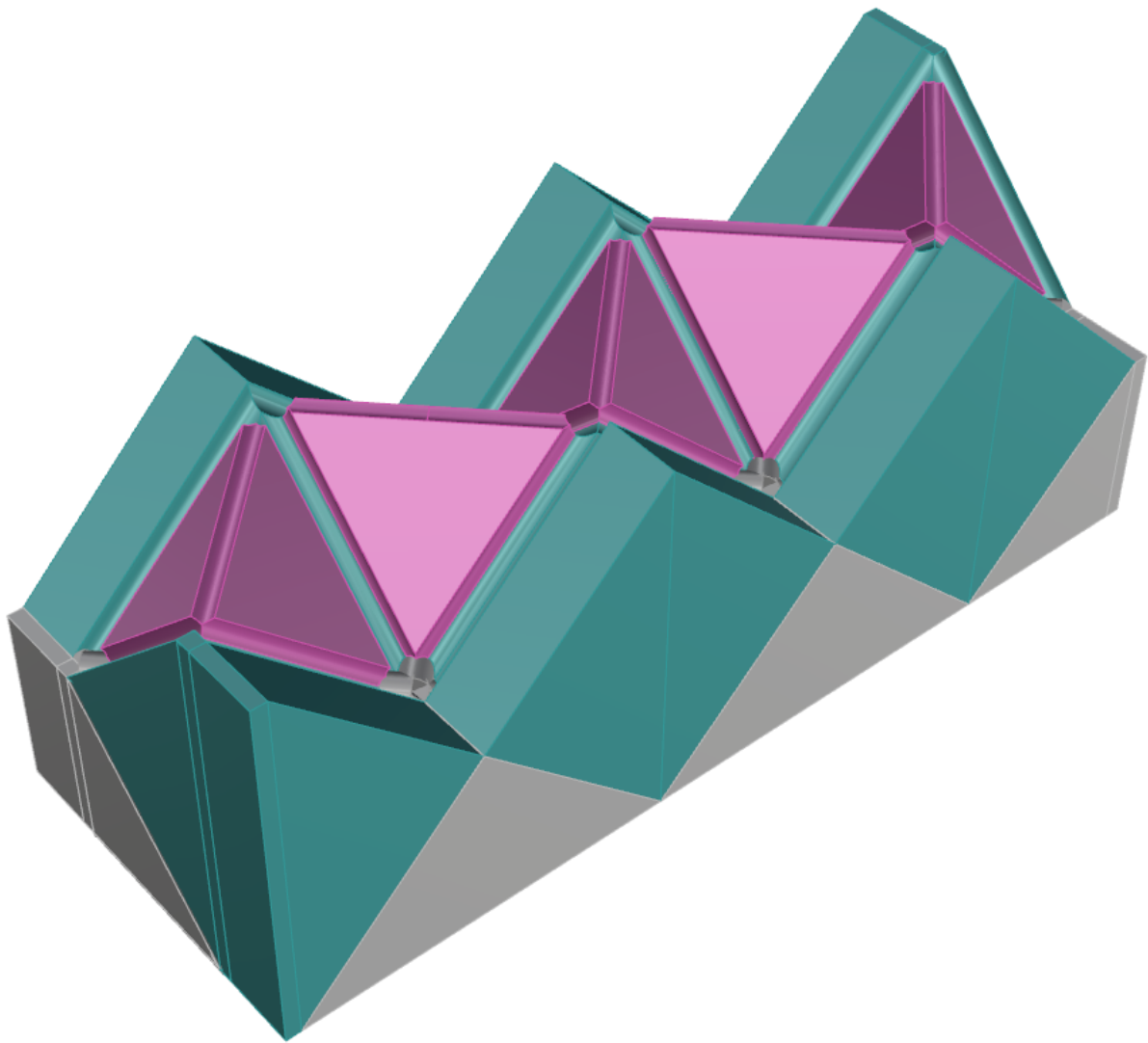


Figure 5.7: 3D view of step (b) : Semi octahedra placement

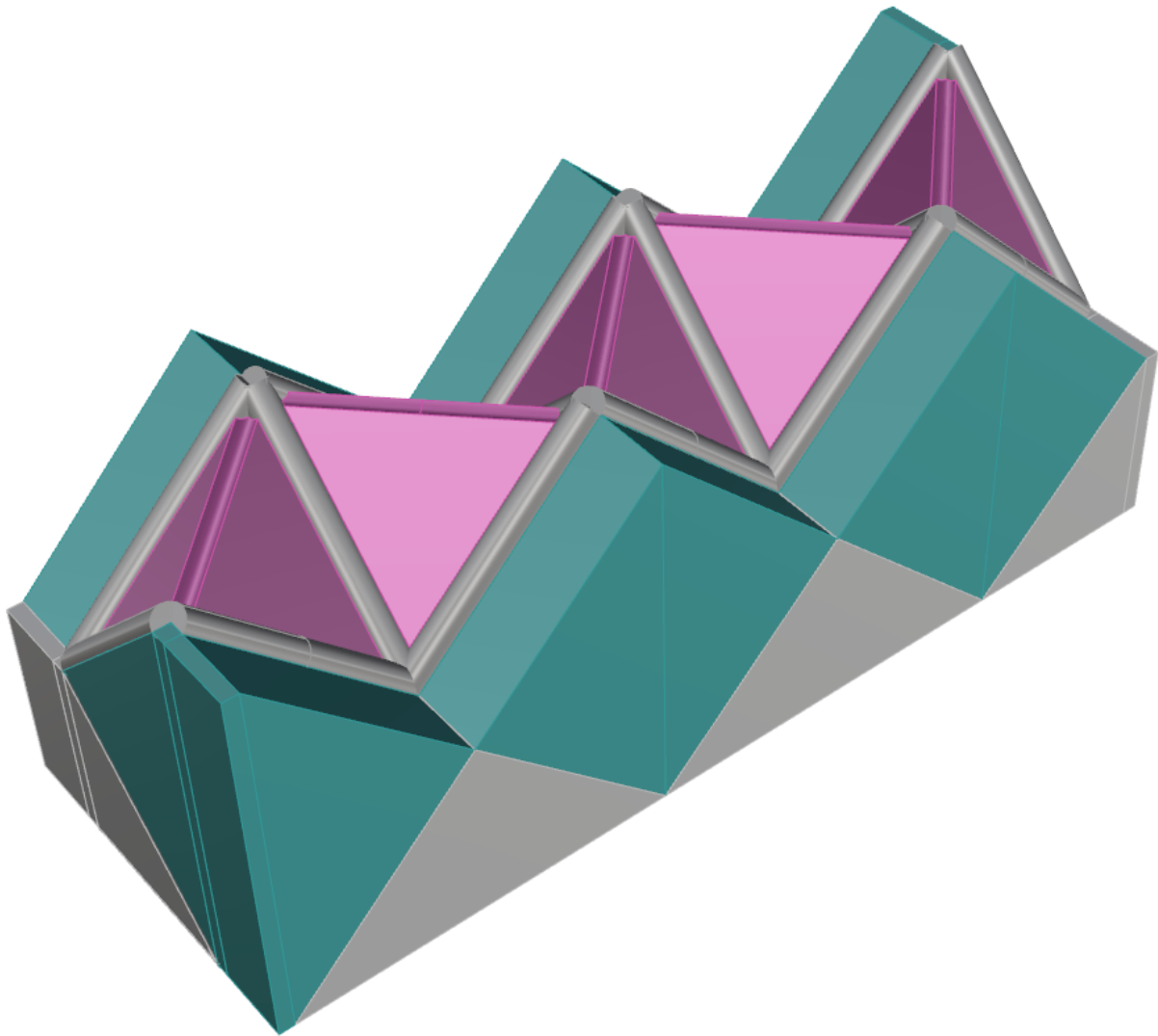


Figure 5.8: 3D view of step (c) : Non-horizontal channels filling

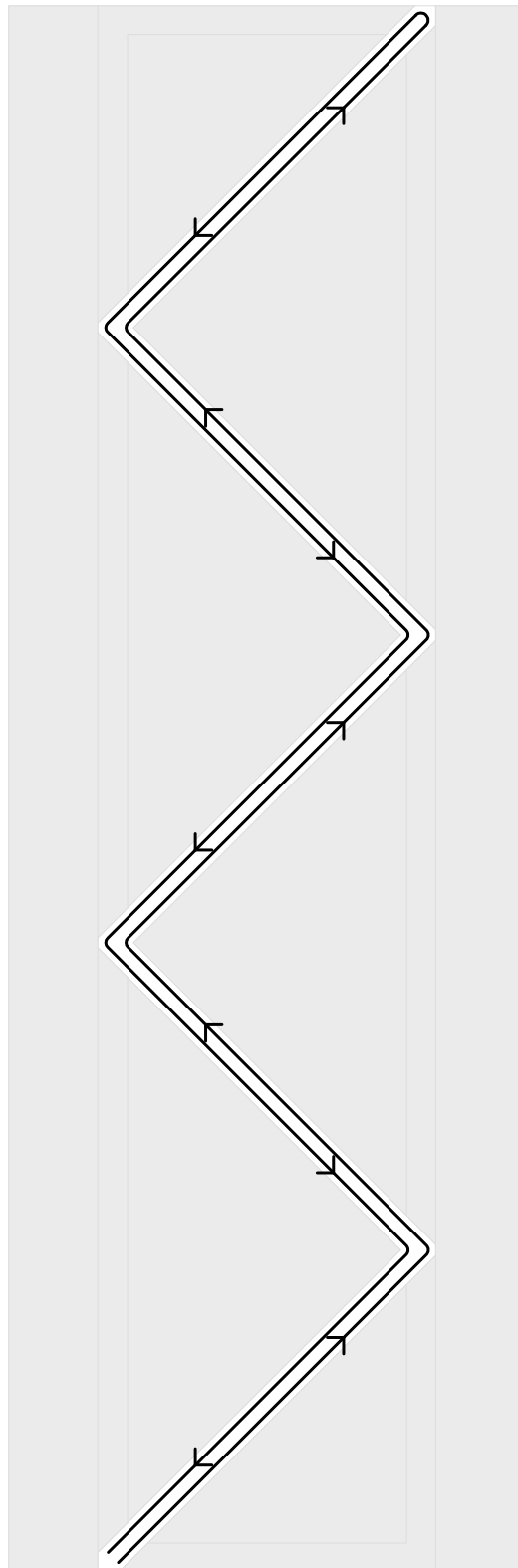


Figure 5.9: Horizontal channels path

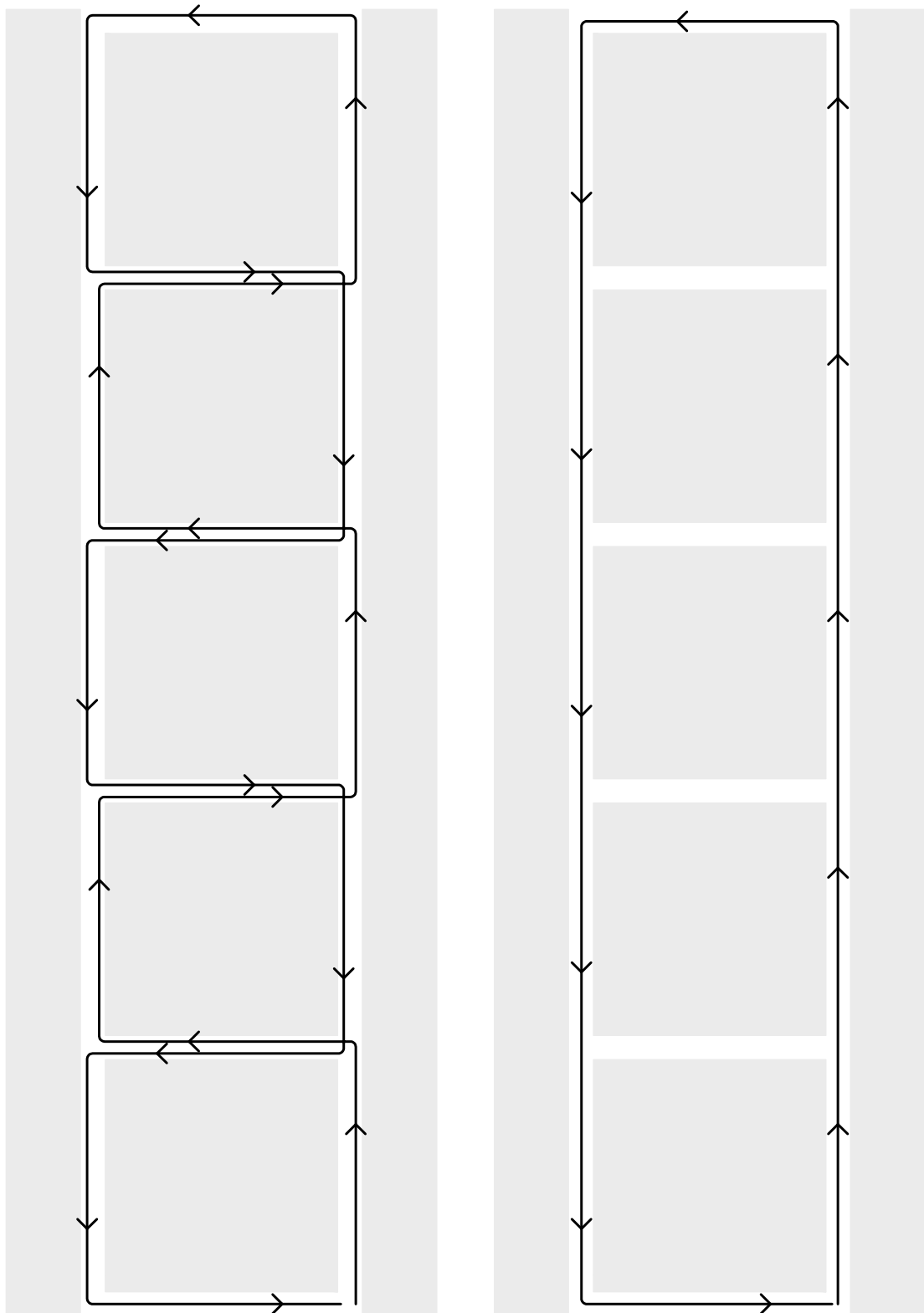


Figure 5.10: Non-horizontal channels paths

constant to simplify the problem. It appeared that the downhill deposition regime was critical, mortar properties (quantity of admixtures) were then chosen from it and applied to the two others, less detrimental. The uphill and downhill regimes are drawn on figure 5.11.

To ensure that the correct quantity of material is deposited each time, to properly fill the channels and obtain the targeted bar diameters for the truss, average nozzle speed has to equal mortar flow rate along each channel. In the uphill case this is quite simple, for the extruded material is constantly supported by the lace being deposited. Therefore the nozzle can follow a straight line at flow rate speed, to prevent adding vertical forces other than self weight. For the downhill case however, the same strategy would make the fresh mortar flow down the channel. That is why a deposition regime corresponding to what is drawn on figure 5.11 has to be achieved. Mortar stays in shape thanks to a sufficient yield stress, and stays "behind" the nozzle thanks to its viscosity. To obtain such a regime the nozzle has to follow a different trajectory, giving more height to the mortar to fall. Speed has to be adjusted in consequence. Depending on viscosity, flow rate and deposition height, the mortar can have an erratic behaviour and exhibit coiling. This phenomenon, to be avoided in our case, has been studied for different materials in [16]. Additional research could be relevant to model this in the present case, because coiling regimes could be directly linked to the mortar viscosity.

On the following images are shown the result of our prototyping. Empty channels are visible on figure 4.2, when the blocks are assembled. A three layer truss with carved EPS blocks is visible on figure 5.13, an a two layer one, with printed cavities to cast reinforced concrete for confined masonry, see chapter 4, on figure 5.14. These prototypes have bars of 40mm diameters and were printed with a nozzle speed of $50mm.s^{-1}$. The printing and assembly together last around 10 min per layer.

5.3 Discussion

In chapter 4 we have explained how this technique is compatible with confined masonry, without reinforcement inside the truss bars. It could however be used in another context for its

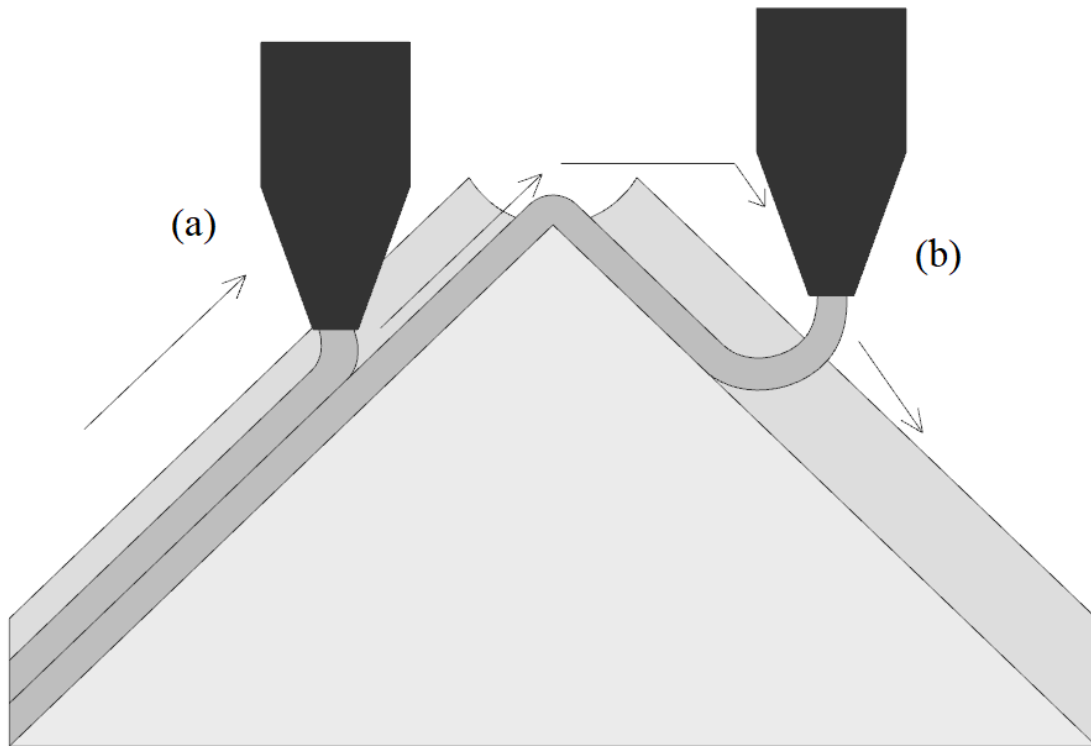


Figure 5.11: Uphill (a) and downhill (b) deposition regimes

structural efficiency, provided tensile strength and ductility are added. We briefly discuss here this possibility.

First of all, it is worth mentioning that this approach does not face the same difficulties as other concrete printing methods regarding the reinforcement issue. Layered printing indeed bring anisotropy to the objects it makes, and if reinforcement is to be added to the lace, it will not be possible to orient it in the perpendicular direction. This problem can perhaps be solved by playing with the extrusion path to somehow weave the laces to each other to recreate a global isotropy. In the truss case, the structure has a natural anisotropic behaviour since the efforts are oriented along the bars. Lace reinforcement is therefore compatible in principle. Depending on the specific strategy though, some problems remain to be solved.

As mentioned before, among the various possibilities to deal with this generalized printing, layered free deposition of plastic mortar is compatible with the addition of rebars. Indeed, one could imagine, in the same way that the EPS blocks are progressively assembled, to put metallic sticks inside each bar, between the deposition of layers. Correct adherence with the mortar would have to be carefully checked, but does not seem impossible considering the relatively



Figure 5.12: EPS blocks forming channels

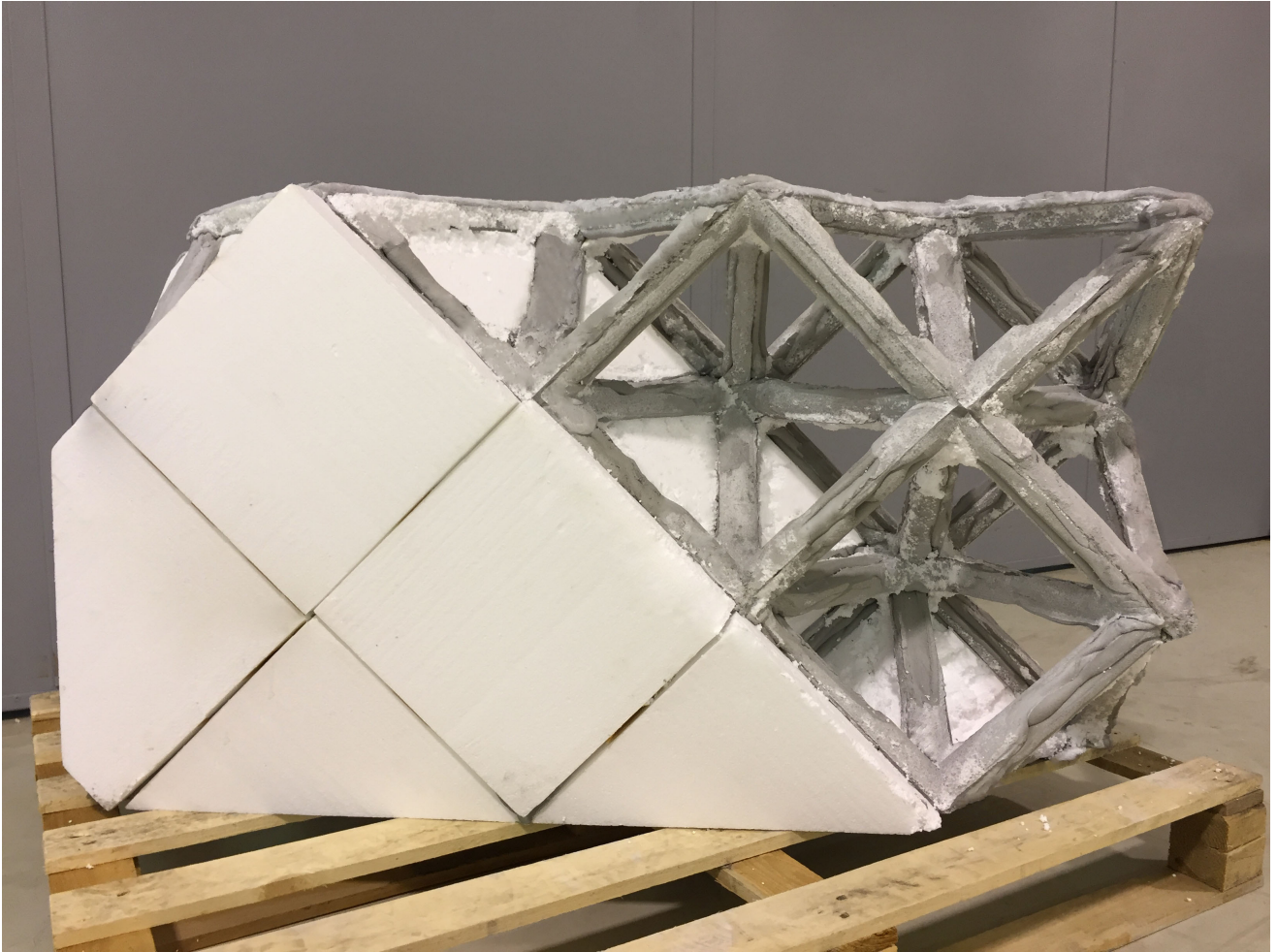


Figure 5.13: Printed mortar truss prototype with EPS blocks removed

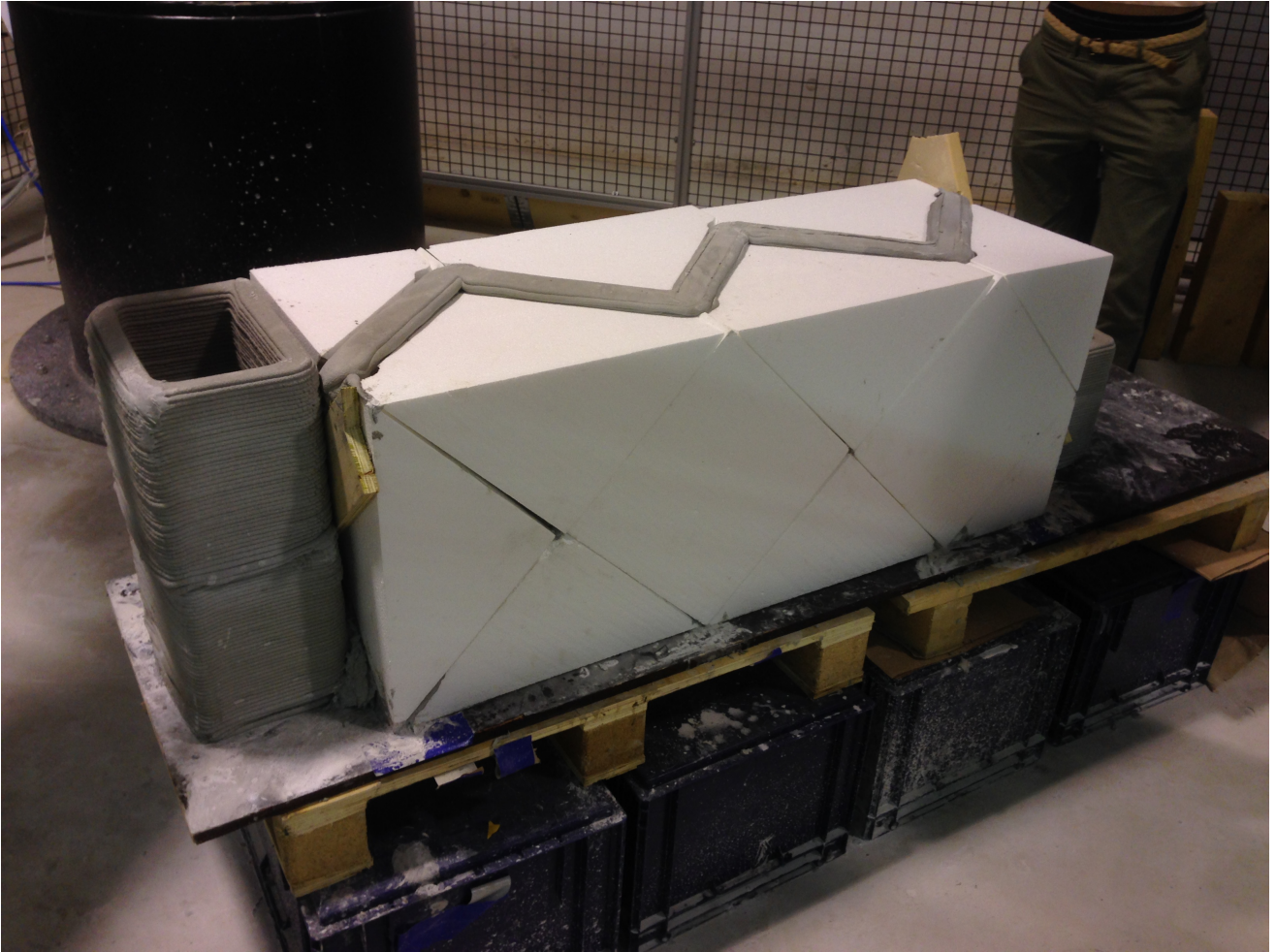


Figure 5.14: Truss prototype with cavities for confining frame

low demand in early age structuration. The rebars could in addition be added while locally vibrating the mortar to ensure correct adhesion. Another concern is that curtailment and lapping of reinforcement and concrete cover to reinforcement should be in accordance with EC2, which seems difficult at such scales. The smallest traditional rebars are too thick for the diameters we work with. Other metallic bars could be used, in fact the prototype on figure 5.13 has been embedded with threaded rods, as a preliminary test. What happens at the nodes remains a difficult obstacle if the rebars are to overlap. An idea to solve this would be to use pre-bent rebars spanning several bars at the same time and providing continuity. The additional cost could however be quite high compared to the printing. Another strategy would be to argue that the structural redundancy of the truss helps providing sufficient ductility even in the case of failure at the nodes, depending on the context of use.

Fiber reinforcement is another approach that seems quite relevant in the case of printing. Some studies have been already conducted [6, 97, 12, 83] and a metallic cable reinforcement has been notably used in TU Eindhoven pre-stressed bridge [83]. A continuous fiber reinforcement strategy is currently studied by our team, and future work will consist in applying it to this truss printing. In the case of reinforced structures the EPS blocks could be removed, if their insulating property is not useful, then recycled.

Chapter 6

Conclusion and perspectives

6.1 Generalized printing

As we mentioned in the beginning the term 3d printing was borrowed from the rapid prototyping world. Even there it is quite vague, for it applies to a specific method of additive manufacturing but is employed in a general way. From rapid prototyping to additive manufacturing in the non building industry there is already a gap to cross concerning material effective properties. Additional treatment method are often compulsory to ensure sufficient qualities of the printed objects, and accurate prediction models are still a challenge [45]. The transposition of such techniques at large scale will bring new difficulties but also has the potentiality of solving some. Repeatability, precision and automation will be understood in a different way for the building industry.

The work presented here is an attempt to better define what can be thought as printing in a construction context. Three angles are successively adopted to do so. Firstly we try to understand the existing methods of printing with robotic extrusion of cementitious materials (chapter 2). Three idealized approaches were proposed, varying in the applied technology and the material build up strategy. There are called slip forming, extruded lace shaping and oriented lace pressing (see section 2.2). Such a rheology oriented division, if it can precisely describe printing processes in the “limited” sense of arranging cementitious matter in space, lacks of

efficiency to deal with full building systems.

At construction scale, some automated or semi automated approaches can be given the name of printing, understood in a more general way. This is the purpose of chapter 3, where a notation system is proposed to address the building systems problem in an integrative fashion. Five main parameters to distinguish strategies between each other are of object scale, extrusion scale, environment, assembly and supports (see section 3.2.1). Already with those is it possible to describe families or building systems closer to a relevant implementation of extrusion in a construction context. Additional parameters to better describe material technological stakes were also proposed, see section 3.2.2. A study to link main parameters combinations to a parameter of robotic complexity was also conducted, see section 3.3.4. A cartography approach, see figures 3.10 and 3.11, helped us visualize a broad scope of possibilities, going beyond the limited 2.5D extrusion of walls.

The third part of this work (chapters 4 and 5) is dedicated to a contribution to what can be called generalized printing, to emphasize the difference with small scale rapid prototyping methods. It consists in a hybrid approach, mixing the assembly of insulating blocks with mortar extrusion to create a space truss geometry, see section 4.1. It can legitimately be compared to confined masonry systems since it can produce structural and insulating walls without the need for reinforcement, see section 4.2. In this context it provides an automated system able to produce building elements with a fourth of the material needed for such objects with existing methods, see section 4.4. In addition, if ductility and significant tensile strength would be ensured in the trusses, e.g. with a continuous fibre reinforcement of the mortar laces, very light complex structures would be feasible in cementitious materials at a reasonable cost.

The prototyping of such structures has been conducted in Navier Laboratory. It has been shown in chapter 5 that a layered printing approach is preferable to a direct filling of the channels in that context, see section 5.2.2. In the case of printing inside the channels of insulating block that act as support, the rheological strategy differs from the three idealized cases of chapter 2. More plasticity and less early age structuration are asked to the extruded material, and this fourth approach has been called free depositing, see sections 5.2.2 and 5.2.3. This hybrid

printing process allows to mimic a masonry assembly system with mortar, which reduces cost and precision issues while allowing for a great variety of attainable shapes and heights. This example helps to understand what can be meant by the term "generalized printing". The key aspects of printing are automation and progressiveness. Both are to be understood with nuance when applying to large scale objects or construction sites.

Automation is often associated to printing by the idea of remote control and black box facility. This ambition goes back in time with early dreams of automated construction site controlled by architects, as depicted in figure 6.1. Interestingly, on this image we can notice quite a mess around the built components, made of waste, both of construction and machine material, some leftovers, maybe prototypes, and some gravel to discard. Given the strong political and economical stakes associated with construction, it is likely that this mess will not disappear in the sense of a perfectly clean production line in a factory. Automation must then be thought in the form of intelligent machines, able to react to unpredictable events, detect surroundings elements and take decisions by their own. They must also be associated with humans for some of the work on specific projects, or at least with other machines. Automation in construction therefore must be thought as a semi automation, not in a diminishing way of thinking but as a challenge, to interface with inhomogeneous actors.

Beyond automation, the term printing conveys the idea of progressiveness. It must not be understood as an in situ application of standardized production lines. This progressiveness, located both in the material kinetics and in the building system itself, is what allows versatility (mass customization), waste reduction and low cost. As a counter example can be mentioned Thomas Edison's 1917 patent for automated construction in concrete, see figure 6.2. His system differs from printing because before the "single moulding operation" he has to "construct a complete double wall house" [25]. Even if he argues for progressiveness in the casting to ensure that "only a short column of the cement will act to create hydraulic pressure upon the mould" [25], but it does not fully apply to the general system. On the contrary, a generalized printing process must exhibit progressiveness at each level of operation.



Figure 6.1: Chantier de construction électrique (Electrical construction site), Chromolithography, Villemard, BnF, Paris, 1910

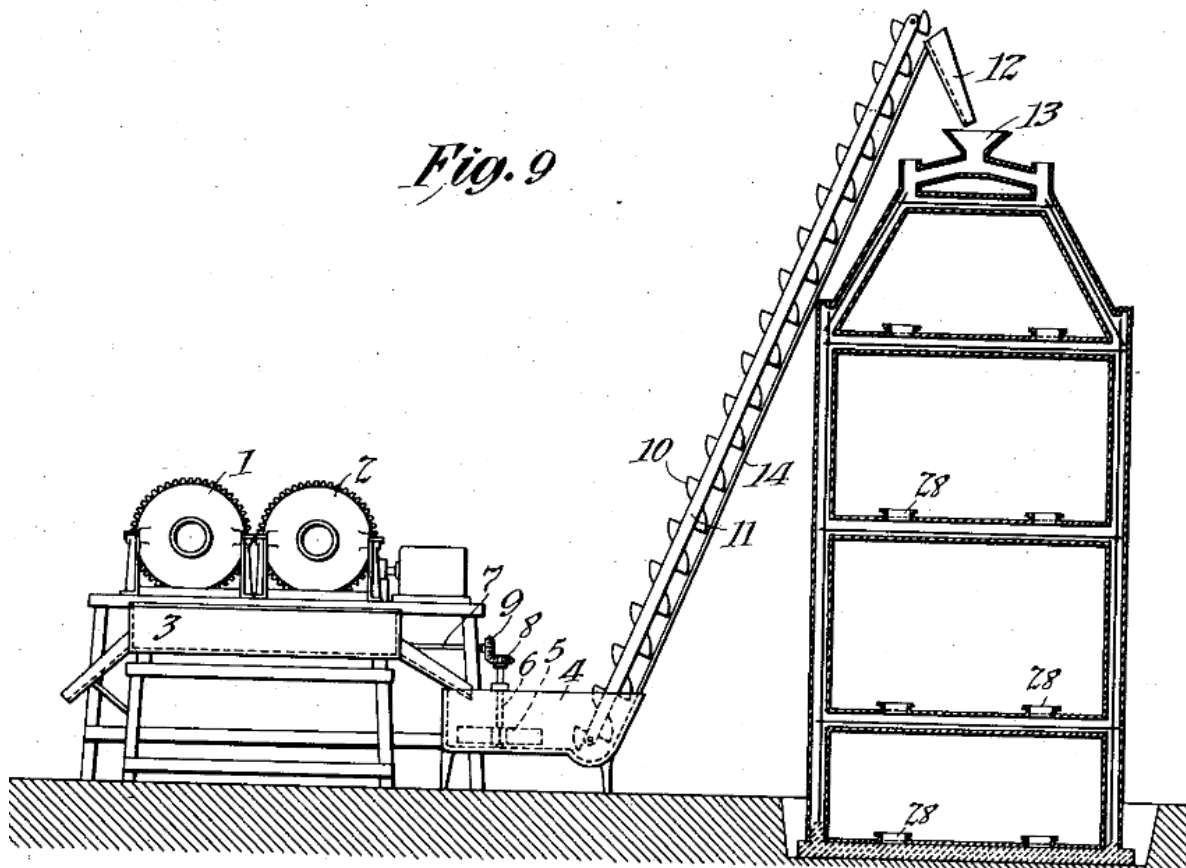


Figure 6.2: Process of constructing concrete buildings, published in [25]

6.2 Perspectives

The main idea in the term of general printing is to include actions other than the sole extrusion. It can basically take the form of assembly and/or support strategies. The end goal being complete building systems able to print finished building products, including all functionalities, and to generate even more complex geometries. We have proposed the space truss system to generate light space structure embedded in insulating foam. In this last section we go through some digital concrete references compatible with extrusion, that seem to announce the second age of concrete printing.

6.2.1 Printing on surface supports

Some experiments have been conducted to link concrete printing with surface support to generate shell, or shell like, geometries. The most direct of those is undoubtedly the assembled printed shell published in [18], see figure 6.3. Here the printing makes use of a CNC milled support to match the desired curvature, and generate a contour. Then the printed areas are filled with self consolidating concrete. The assembly is conducted making use of a soft material for junctions to absorb geometrical irregularities. The challenges reported here are of precision, linked to the height and orientation of the printing head. With a complex surface support it is indeed more difficult to have a reliable trajectory. In our terminology, Oriented Lace Pressing, see section 2.2.3, may be the more suited approach extrusion-wise. 6 axis orientation of the tool can also be seen as a good choice for such a problem. Note that in the case of channel filling of section 5.2.2, the main difference was the convex character of the support, allowing the material to flow.

In [18] is also mentioned the idea of doing a stress line approach with this supported printing technique, as proposed in [89]. This system could be of interest for novel structural typologies like the Trumpf foot bridge¹ visible on figure 6.4, to simplify the manufacturing. With this sole idea of supported shell printing, many extrusion strategies seem to be possible. The support

¹<https://structurae.info/ouvrages/passerelle-trumpf>



Figure 6.3: Contour printed and assembled shell, published in [18]

itself can be of other type as well, an interesting idea has been proposed in [74, 73, 72], based on knitted formwork for shotcrete. A grid shell type of supporting structure can also be thought of [14, 89], or pneumatic formworks [44].

6.2.2 Printing on complex supports

Outside of surface supports to generate shell structures, some experiments have been conducted on more complex support systems. The insulating pyramids proposed in chapters 4 and 5 are an example. To be mentioned in recent works are also granular supports, able to help the fresh mortar to stand away from verticality. A bridge structure has been printed and assembled in that way in Ghent university², see on figure 6.5

Printing on existent buildings will probably become an interesting market to reach. Either to directly repair existing structures or to generate substitution parts, adaptation to constrained geometries will be a challenge and a opportunity for printing. It has been explored in [104] for ornament. Existent geometry is generated by scanning and included in the printing file.

²<https://www.ugent.be/ea/structural-engineering/en/3dbridge.htm>



Figure 6.4: Trumpf bridge, Arch. Barkow Leibinger, Ing. Schlaich Bergermann, 2018



Figure 6.5: An "optimal concrete bridge" from Ghent university

6.2.3 Precision

We finish this discussion with a word about precision. Digital tools in architecture have often been associated with the notion of precision, even of zero tolerance. Behind this idea is the image of perfectly automated production lines in traditional industries, considered a desirable model for construction sites. If it is possible that this comparison becomes relevant in the future, it is probable that such a degree of predictability will not happen on every site of tomorrow. From an experimentation point of view, precision is something to be managed, not always absolutely necessary, and that can be very costly. On the other hand, precision in the form of repeatability can greatly improve performances by diminishing overall size of structural parts.

As an example, switching from an oriented lace pressing approach to a free deposition for printing on the insulating blocks in chapter 6 allows for some imprecision in the block manufacturing and assembly. In the same sense, making use of printing, that is to ask for a progressive structural build up for the material, allows the blocks to be relieved from perfect watertightness requirement.

In the opposite direction, and from a regulation point of view, precision will be compulsory to be able to ensure material properties at each location of a printed structure. This is quite an ambitious goal but it is one of the promise of the digital era. As Pegna was writing at the end of the last century [63, 64], digital manufacturing has the opportunity to divide its objects in a great number of simple elements. If this was to emphasize the compatibility of such an approach with robots and computers, the building industry can seize this as an invitation to renew its current method of structural design. With such precision in understanding the behaviour of structural parts, tremendous size reduction and material optimization maybe within our grasp.

Bibliography

- [1] World Steel Association statistical yearbooks.
- [2] I. Agustí-Juan and G. Habert. Environmental design guidelines for digital fabrication. *Journal of Cleaner Production*, 142:2780–2791, 2017.
- [3] D. G. Ahn, S. H. Lee, and D. Y. Yang. Investigation into thermal characteristics of linear hotwire cutting system for variable lamination manufacturing (VLM) process by using expandable polystyrene foam. *International Journal of Machine Tools and Manufacture*, 42(4):427–439, 2002.
- [4] L. Angeles and L. Angeles. Mega-scale fabrication by contour crafting Behrokh Khoshnevis * Dooil Hwang and Ke-Thia Yao Zhenghao Yeh. 1(3):301–320, 2006.
- [5] D. Asprone, F. Auricchio, C. Menna, and V. Mercuri. 3D printing of reinforced concrete elements: Technology and design approach. *Construction and Building Materials*, 165(January):218–231, 2018.
- [6] D. Asprone, C. Menna, F. P. Bos, T. A. Salet, J. Mata-Falcón, and W. Kaufmann. Rethinking reinforcement for digital fabrication with concrete. *Cement and Concrete Research*, 112(January):111–121, 2018.
- [7] S. Bhooshan, T. Van Mele, and P. Block. Equilibrium-Aware Shape Design for Concrete Printing. *Humanizing Digital Reality*, pages 493–508, 2017.
- [8] P. H. Billberg, N. Roussel, S. Amziane, M. Beitzel, G. Charitou, B. Freund, J. N. Gardner, G. Grampeix, C. A. Graubner, L. Keller, K. H. Khayat, D. A. Lange, A. F. Omran,

- A. Perrot, T. Proske, R. Quattrociochi, and Y. Vanhove. Field validation of models for predicting lateral form pressure exerted by SCC. *Cement and Concrete Composites*, 54(May):70–79, 2014.
- [9] F. Bos, R. Wolfs, Z. Ahmed, and T. Salet. Additive manufacturing of concrete in construction: potentials and challenges of 3D concrete printing. *Virtual and Physical Prototyping*, 2759(October):1–17, 2016.
- [10] F. Bos, R. Wolfs, Z. Ahmed, and T. Salet. *First RILEM International Conference on Concrete and Digital Fabrication – Digital Concrete 2018*, volume 19. Springer International Publishing, 2019.
- [11] F. P. Bos, Z. Y. Ahmed, E. R. Jutinov, and T. A. Salet. Experimental exploration of metal cable as reinforcement in 3D printed concrete. *Materials*, 10(11), 2017.
- [12] F. P. Bos, E. Bosco, and T. A. M. Salet. Ductility of 3D printed concrete reinforced with short straight steel fibers. *Virtual and Physical Prototyping*, 2759:1–15, 2018.
- [13] P. Bosscher, R. L. Williams, L. S. Bryson, and D. Castro-Lacouture. Cable-suspended robotic contour crafting system. *Automation in Construction*, 17(1):45–55, 2007.
- [14] L. Bouhaya, O. Baverel, and J. F. Caron. Optimization of gridshell bar orientation using a simplified genetic approach. *Structural and Multidisciplinary Optimization*, 50(5):839–848, 2014.
- [15] H. Brooks. A review of state-of-the-art large-sized foam cutting rapid prototyping and manufacturing technologies. *Rapid Prototyping Journal*, 16(5):318–327, 2010.
- [16] P. T. Brun, B. Audoly, N. M. Ribe, T. S. Eaves, and J. R. Lister. Liquid ropes: A geometrical model for thin viscous jet instabilities. *Physical Review Letters*, 114(17), 2015.
- [17] R. A. Buswell, R. C. Soar, A. G. F. Gibb, and A. Thorpe. Freeform Construction: Mega-scale Rapid Manufacturing for construction. *Automation in Construction*, 16(2):224–231, 2007.

- [18] C. B. Costanzi, Z. Y. Ahmed, H. R. Schipper, F. P. Bos, U. Knaack, and R. J. M. Wolfs. Automation in Construction 3D Printing Concrete on temporary surfaces : The design and fabrication of a concrete shell structure. *Automation in Construction*, 94(August 2017):395–404, 2018.
- [19] T. Craipeau, T. Lecompte, F. Toussaint, and A. Perrot. *First RILEM International Conference on Concrete and Digital Fabrication – Digital Concrete 2018*, volume 19. Springer International Publishing, 2019.
- [20] G. De Schutter and D. Feys. Pumping of Fresh Concrete: Insights and Challenges. *RILEM Technical Letters*, 1:76, 2016.
- [21] G. De Schutter, K. Lesage, V. Mechtcherine, V. N. Nerella, G. Habert, and I. Agustí-Juan. Vision of 3D printing with concrete — Technical, economic and environmental potentials. *Cement and Concrete Research*, 112(November 2017):25–36, 2018.
- [22] R. Dobbs, J. Manyika, J. W. M. Chui, and S. Lund. McKinsey Global Institute The McKinsey Global Institute The McKinsey Infrastructure Practice. (October), 2014.
- [23] P. Donelan. Singularities of Robot Manipulators. *Singularity Theory*, pages 189–217, 2005.
- [24] R. Duballet, O. Baverel, and J. Dirrenberger. Classification of building systems for concrete 3D printing. *Automation in Construction*, 83(July):247–258, 2017.
- [25] T. Edison. Process of constructing concrete buildings. (US Patent 1219272), 1917.
- [26] P. Feng, X. Meng, J.-F. Chen, and L. Ye. Mechanical properties of structures 3D printed with cementitious powders. *Construction and Building Materials*, 93:486–497, 2015.
- [27] P. Feng, X. Meng, and H. Zhang. Mechanical behavior of FRP sheets reinforced 3D elements printed with cementitious materials. *Composite Structures*, 134:331–342, 2015.
- [28] N. Gaudillière, R. Duballet, C. Bouyssou, A. Mallet, P. Roux, M. Zakeri, J. Dirrenberger, N. Gaudillière, R. Duballet, C. Bouyssou, A. Mallet, and P. Roux. Large-Scale Additive

- Manufacturing of Ultra-High-Performance Concrete of Integrated Formwork for Truss-Shaped Pillars To cite this version : HAL Id : hal-01904661 Science Arts & Métiers (SAM). 2018.
- [29] R. Geyer, J. R. Jambeck, and K. L. Law. Production, use, and fate of all plastics ever made. *Science Advances*, 3(7):19–24, 2017.
- [30] A. Goidea. BATIPRINT3D PROJECT REPORT. 2017.
- [31] C. Gosselin, R. Duballet, P. Roux, N. Gaudillière, J. Dirrenberger, and P. Morel. Large-scale 3D printing of ultra-high performance concrete – a new processing route for architects and builders. *Materials & Design*, 100:102–109, 2016.
- [32] A. Gram. Modelling Bingham Suspensional Flow. (April):68, 2015.
- [33] C. Haas. Identifying Root Causes of Construction Accidents. 9364(January 2000):1970–1998, 2015.
- [34] N. Hack. Mesh Mould : Robotically Fabricated Metal Meshes as Concrete Formwork and Reinforcement MESH MOULD : ROBOTICALLY FABRICATED METAL MESHES AS. (June), 2015.
- [35] A. L. Huang, R. E. Chapman, and D. T. Butry. Metrics and tools for measuring construction productivity: Technical and empirical considerations. *National Institute of Standards and Technology. Special Publication 1101*, page 163, 2009.
- [36] L. Huang, G. Krigsvoll, F. Johansen, Y. Liu, and X. Zhang. Carbon emission of global construction sector. *Renewable and Sustainable Energy Reviews*, 81(June 2016):1906–1916, 2018.
- [37] Q. Information and I. I. Sciences. General Restriction on Quantumness Measure. pages 1–4, 2016.
- [38] A. Jakupovic. Mini Builders Project - Report, IAAC.

- [39] H. Jeong, S.-J. Han, S.-H. Choi, Y. Lee, S. Yi, and K. Kim. Rheological Property Criteria for Buildable 3D Printing Concrete. *Materials*, 12(4):657, 2019.
- [40] B. Khoshnevis. Automated construction by contour crafting - Related robotics and information technologies. *Automation in Construction*, 13(1):5–19, 2004.
- [41] B. Khoshnevis. Automated construction of towers and columns. 1, 2018.
- [42] B. Khoshnevis, X. Yuan, B. Zahiri, J. Zhang, and B. Xia. Construction by contour crafting using sulfur concrete with planetary applications. *Rapid Prototyping Journal*, 22(5):848–856, 2016.
- [43] B. Khoshnevis, X. Yuan, B. Zahiri, J. Zhang, and B. Xia. Construction by contour crafting using sulfur concrete with planetary applications. *Rapid Prototyping Journal*, 22(5):848–856, 2016.
- [44] B. Kromoser and P. Huber. Pneumatic Formwork Systems in Structural Engineering. *Advances in Materials Science and Engineering*, 2016:1–13, 2016.
- [45] J. Kruth, M. Badrossamay, E. Yasa, J. Deckers, L. Thijs, and J. V. Humbeeck. Part and material properties in selective laser melting of metals. 2016.
- [46] T. T. Le, S. A. Austin, S. Lim, R. A. Buswell, A. Gibb, and T. Thorpe. Mix design and fresh properties for high-performance printing concrete. *Materials and Structures*, 45:1221–1232, 2012.
- [47] T. T. Le, S. A. Austin, S. Lim, R. A. Buswell, R. Law, A. G. F. Gibb, and T. Thorpe. Hardened properties of high-performance printing concrete. *Cement and Concrete Research*, 42(3):558–566, 2012.
- [48] S. Lim, R. Buswell, T. Le, R. Wackrow, S. Austin, A. Gibb, and T. Thorpe. Development of a viable concrete printing process. *Proceedings of the 28th International Symposium on Automation and Robotics in Construction (ISARC2011)*, (January):665–670, 2011.

- [49] S. Lim, R. A. Buswell, T. T. Le, S. A. Austin, A. G. F. Gibb, and T. Thorpe. Developments in construction-scale additive manufacturing processes. *Automation in Construction*, 21(1):262–268, 2012.
- [50] E. Lloret, A. R. Shahab, M. Linus, R. J. Flatt, F. Gramazio, M. Kohler, and S. Langenberg. Complex concrete structures: Merging existing casting techniques with digital fabrication. *CAD Computer Aided Design*, 60:40–49, 2015.
- [51] V. Loing, R. Marlet, and M. Aubry. Virtual Training for a Real Application: Accurate Object-Robot Relative Localization Without Calibration. *International Journal of Computer Vision*, 126(9):1045–1060, 2018.
- [52] D. Lowke, E. Dini, A. Perrot, D. Weger, C. Gehlen, and B. Dillenburger. Particle-bed 3D printing in concrete construction – Possibilities and challenges. *Cement and Concrete Research*, 112(May):50–65, 2018.
- [53] R. Maddalena, J. J. Roberts, and A. Hamilton. Can Portland cement be replaced by low-carbon alternative materials? A study on the thermal properties and carbon emissions of innovative cements. *Journal of Cleaner Production*, 186:933–942, 2018.
- [54] T. Marchment and J. Sanjayan. Method of enhancing interlayer bond strength in 3D concrete printing. *RILEM Bookseries*, 19:148–156, 2019.
- [55] S. H. Masood. *Advances in Fused Deposition Modeling*, volume 10. Elsevier, 2014.
- [56] McKinsey & Company. Infrastructure productivity: how to save \$1 trillion a year. *McKinsey Global Institute*, (January):100, 2013.
- [57] R. Mesnil, C. Douthe, O. Baverel, and B. Léger. Generalised cyclidic nets for shape modelling in architecture. *International Journal of Architectural Computing*, 15(2):148–168, 2017.
- [58] V. N. Nerella, M. A. Beigh, S. Fataei, and V. Mechtcherine. Strain-based approach for measuring structural build-up of cement pastes in the context of digital construction. *Cement and Concrete Research*, 115(February):530–544, 2019.

- [59] V. N. Nerella, M. Näther, A. Iqbal, M. Butler, and V. Mechtcherine. Inline quantification of extrudability of cementitious materials for digital construction. *Cement and Concrete Composites*, 95:260–270, 2019.
- [60] O. Ortiz, F. Castells, and G. Sonnemann. Sustainability in the construction industry: A review of recent developments based on LCA. *Construction and Building Materials*, 23(1):28–39, 2009.
- [61] B. Panda, N. Ahamed, N. Mohamed, Y. Wei, D. Tay, and M. J. Tan. *First RILEM International Conference on Concrete and Digital Fabrication – Digital Concrete 2018*, volume 19. Springer International Publishing, 2019.
- [62] I. Paoletti. Mass Customization with Additive Manufacturing: New Perspectives for Multi Performative Building Components in Architecture. *Procedia Engineering*, 180:1150–1159, 2017.
- [63] J. Pegna. Application of Cementitious Bulk Materials to Site Processed Freeform Construction. *6th Solid Freeform Fabrication (SFF) Symposium*, pages 39–45, 1995.
- [64] J. Pegna. Exploratory investigation of solid freeform construction. *Automation in Construction*, 5(5):427–437, 1997.
- [65] A. Perrot, C. Lanos, Y. Melinge, and P. Estellé. Mortar physical properties evolution in extrusion flow. *Rheologica Acta*, 46(8):1065–1073, 2007.
- [66] A. Perrot, Y. Mélinge, D. Rangeard, F. Micaelli, P. Estellé, and C. Lanos. Use of ram extruder as a combined rheo-tribometer to study the behaviour of high yield stress fluids at low strain rate. *Rheologica Acta*, 51(8):743–754, 2012.
- [67] A. Perrot, D. Rangeard, and E. Courteille. 3D printing of earth-based materials: Processing aspects. *Construction and Building Materials*, 172(April):670–676, 2018.
- [68] A. Perrot, D. Rangeard, F. Menasria, and S. Guihéneuf. Strategies for optimizing the mechanical strengths of raw earth-based mortars. *Construction and Building Materials*, 167:496–504, 2018.

- [69] A. Perrot, D. Rangeard, V. Nerella, and V. Mechtcherine. Extrusion of cement-based materials - an overview. *RILEM Technical Letters*, 3(2018):91–97, 2019.
- [70] a. Perrot, D. Rangeard, and a. Pierre. Structural built-up of cement-based materials used for 3D-printing extrusion techniques. *Materials and Structures*, 2015.
- [71] A. Perrot, D. Rangeard, M. Yannick, P. Estell, A. Perrot, D. Rangeard, M. Yannick, P. Estell, and C. L. Ex. Extrusion Criterion for Firm Cement-based Materials To cite this version : Extrusion criterion for firm cement-based materials. 2012.
- [72] M. Popescu, L. Reiter, A. Liew, T. Van Mele, R. J. Flatt, and P. Block. Building in Concrete with an Ultra-lightweight Knitted Stay-in-place Formwork: Prototype of a Concrete Shell Bridge. *Structures*, 14(November 2017):322–332, 2018.
- [73] M. Popescu, M. Rippmann, T. V. Mele, and P. Block. Automated Generation of Knit Patterns for Non-developable Surfaces. (Aboumain 2010), 2017.
- [74] M. Popescu, M. Rippmann, T. van Mele, and B. Philippe. Complex concrete casting: knitting stay-in-place formwork. *Proceedings of the IASS 2016 Tokyo Symposium: Spatial Structures in the 21st Century*, page 1278, 2016.
- [75] T. Potter. Concrete as a Building Material. *Scientific American*, 19(487supp):7774–7776, 2015.
- [76] M. H. Ramage, H. Burrige, M. Busse-Wicher, G. Fereday, T. Reynolds, D. U. Shah, G. Wu, L. Yu, P. Fleming, D. Densley-Tingley, J. Allwood, P. Dupree, P. F. Linden, and O. Scherman. The wood from the trees: The use of timber in construction. *Renewable and Sustainable Energy Reviews*, 68(October 2016):333–359, 2017.
- [77] L. Reiter, T. Wangler, N. Roussel, and R. J. Flatt. The role of early age structural build-up in digital fabrication with concrete. *Cement and Concrete Research*, 112(May):86–95, 2018.

- [78] L. Reiter, T. Wangler, N. Roussel, and R. J. Flatt. The role of early age structural build-up in digital fabrication with concrete. *Cement and Concrete Research*, 112(November 2017):86–95, 2018.
- [79] N. Roussel. Rheological requirements for printable concretes. *Cement and Concrete Research*, 112(January):76–85, 2018.
- [80] N. Roussel and P. Coussot. “Fifty-cent rheometer” for yield stress measurements: From slump to spreading flow. *Journal of Rheology*, 49(3):705–718, 2005.
- [81] N. Roussel and P. Coussot. “Fifty-cent rheometer” for yield stress measurements: From slump to spreading flow. *Journal of Rheology*, 49(3):705–718, 2005.
- [82] N. Roussel, A. Lemaître, R. J. Flatt, and P. Coussot. Steady state flow of cement suspensions: A micromechanical state of the art. *Cement and Concrete Research*, 40(1):77–84, 2010.
- [83] T. A. Salet, Z. Y. Ahmed, F. P. Bos, and H. L. Laagland. Design of a 3D printed concrete bridge by testing*. *Virtual and Physical Prototyping*, 13(3):222–236, 2018.
- [84] M. Schultheiss, T. Wangler, L. Reiter, N. Roussel, and R. J. Flatt. Feedback control of Smart Dynamic Casting through formwork friction measurements. *SCC 2016-8th International Rilem Symposium on Self-Compacting Concrete, Flowing toward Sustainability*, (October):637–644, 2016.
- [85] F. Scotto, F. Gramazio, and M. Kohler. First RILEM International Conference on Concrete and Digital Fabrication – Digital Concrete 2018. 19:299–310, 2019.
- [86] E. Secrieru, S. Fataei, C. Schröfl, and V. Mechtcherine. Study on concrete pumpability combining different laboratory tools and linkage to rheology. *Construction and Building Materials*, 144:451–461, 2017.
- [87] A. S. Suiker. Mechanical performance of wall structures in 3D printing processes: Theory, design tools and experiments. *International Journal of Mechanical Sciences*, 137:145–170, 2018.

- [88] A. Szabo, L. Reiter, and E. Lloret-fritsch. *First RILEM International Conference on Concrete and Digital Fabrication – Digital Concrete 2018*, volume 19. Springer International Publishing, 2019.
- [89] K.-M. M. Tam, J. R. Coleman, N. W. Fine, and C. T. Mueller. Stress line additive manufacturing (SLAM) for 2.5-D shells. *Proceedings of the International Association for Shell and Spatial Structures (IASS) Symposium 2015*, (August), 2015.
- [90] Y. W. D. Tay, G. H. A. Ting, Y. Qian, B. Panda, L. He, and M. J. Tan. Time gap effect on bond strength of 3D-printed concrete. *Virtual and Physical Prototyping*, 14(1):104–113, 2019.
- [91] L.-W. Tsai and A. P. Morgan. Solving the Kinematics of the Most General Six- and Five-Degree-of-Freedom Manipulators by Continuation Methods. *Journal of Mechanisms Transmissions and Automation in Design*, 107(2):189, 2010.
- [92] USGS. Aluminum. *Mineral Commodity Summaries 2018*, 1(703):2007–2008, 2017.
- [93] H. Van Damme. Concrete material science: Past, present, and future innovations. *Cement and Concrete Research*, 112(April):5–24, 2018.
- [94] C. P. Vernet. Ultra-durable concretes: Structure at the micro- and nanoscale. *MRS Bulletin*, 29(5):324–327, 2004.
- [95] T. Wangler and R. J. Flatt. *Correction to: First RILEM International Conference on Concrete and Digital Fabrication – Digital Concrete 2018*. Springer International Publishing, 2018.
- [96] T. P. Wangler. SMART DYNAMIC CASTING SLIPFORMING WITH FLEXIBLE FORMWORK -INLINE. (March), 2017.
- [97] M. J. Wijffels, R. J. Wolfs, A. S. Suiker, and T. A. Salet. Magnetic orientation of steel fibres in self-compacting concrete beams: Effect on failure behaviour. *Cement and Concrete Composites*, 80:342–355, 2017.

- [98] D. Wimpenny, P. M. Engineer, and H. Pacific. Concrete Solutions 09 Low Carbon Concrete – Options for the Next Generation of Infrastructure Concrete Solutions 09 Paper 4a-1. (January 2009):1–10, 2009.
- [99] R. J. Wolfs, F. P. Bos, and T. A. Salet. Correlation between destructive compression tests and non-destructive ultrasonic measurements on early age 3D printed concrete. *Construction and Building Materials*, 181:447–454, 2018.
- [100] R. J. Wolfs, F. P. Bos, and T. A. Salet. Hardened properties of 3D printed concrete: The influence of process parameters on interlayer adhesion. *Cement and Concrete Research*, (February):1–9, 2019.
- [101] World Steel Association. Statistics: Crude Steel Production. *World Steel Association*, 2018.
- [102] P. Wu, J. Wang, and X. Wang. A critical review of the use of 3-D printing in the construction industry. *Automation in Construction*, 68:21–31, 2016.
- [103] J. Xu, L. Ding, and P. E. Love. Digital reproduction of historical building ornamental components: From 3D scanning to 3D printing. *Automation in Construction*, 76:85–96, 2017.
- [104] J. Xu, L. Ding, and P. E. Love. Digital reproduction of historical building ornamental components: From 3D scanning to 3D printing. *Automation in Construction*, 76:85–96, 2017.
- [105] X. Zhang, M. Li, J. H. Lim, Y. Weng, Y. W. D. Tay, H. Pham, and Q. C. Pham. Large-scale 3D printing by a team of mobile robots. *Automation in Construction*, 95(August):98–106, 2018.