



**HAL**  
open science

# L'analyse de la qualité dans un système de fabrication reconfigurable

Abdul Salam Khan

► **To cite this version:**

Abdul Salam Khan. L'analyse de la qualité dans un système de fabrication reconfigurable. Génie des procédés. HESAM Université, 2021. Français. NNT : 2021HESAE054 . tel-03682947

**HAL Id: tel-03682947**

**<https://pastel.hal.science/tel-03682947v1>**

Submitted on 31 May 2022

**HAL** is a multi-disciplinary open access archive for the deposit and dissemination of scientific research documents, whether they are published or not. The documents may come from teaching and research institutions in France or abroad, or from public or private research centers.

L'archive ouverte pluridisciplinaire **HAL**, est destinée au dépôt et à la diffusion de documents scientifiques de niveau recherche, publiés ou non, émanant des établissements d'enseignement et de recherche français ou étrangers, des laboratoires publics ou privés.

**ÉCOLE DOCTORALE SCIENCES DES MÉTIERS DE L'INGÉNIEUR**  
**[LCFC – Campus de Metz]**

**THÈSE**

présentée par : **Abdul Salam KHAN**

soutenue le : **03 Novembre 2021**

pour obtenir le grade de : **Docteur d'HESAM Université**

préparée à : **École Nationale Supérieure d'Arts et Métiers**

Spécialité : **Génie Industriel**

**Quality analysis in a Reconfigurable  
Manufacturing System**

**THÈSE dirigée par :**

**Prof. SIADAT Ali**

**et co-encadrée par :**

**Prof. DANTAN Jean-Yves, Dr. HOMRI Lazhar**

**Jury**

<b>Mme Olga BATAIA</b> , Prof., KEDGE Business School	Présidente
<b>M. Lyes BENYOUCEF</b> , Prof., École Polytechnique, Universitaire de Marseille	Rapporteur
<b>M. Lionel AMODEO</b> , Prof., Université de Technologie de Troyes	Rapporteur
<b>M. Reza TAVAKKOLI- MOGHADDAM</b> , Prof., University of Tehran	Examineur
<b>M. Aamer BAQAI</b> , Prof. and Dean, EME college, NUST, Pakistan	Examineur
<b>M. Jean-Yves DANTAN</b> , Prof., Arts et Métiers Institute of Technology LCFC, HESAM Université, France	Examineur
<b>M. Lazhar HOMRI</b> , Asst. Prof., Arts et Métiers Institute of Technology LCFC, HESAM Université, France	Examineur
<b>M. Ali SIADAT</b> , Prof., Arts et Métiers Institute of Technology LCFC, HESAM Université, France	Examineur

# ACKNOWLEDGEMENT

I am thankful to Almighty ALLAH for giving me the strength and guiding me in completing my doctoral degree. My faith has helped me in overcoming the different challenges I faced during my degree.

I am extremely grateful to my supervisors Prof. Ali SIADAT, Prof. Jean Yves DANTAN and Dr. Lazhar HOMRI for guiding me in each step of my degree. Prof. Ali SIADAT provided me with his mentorship abilities and his expert knowledge in the subject area. Prof. Jean Yves DANTAN helped me in building mathematical and operation research expertise. His worthy guidance helped opening different avenues of understanding manufacturing system problems. The role of Dr. Lazhar HOMRI was both of a supervisor and an elder brother. His knowledge and guidance helped me in improving my research skills. This is his support that made my stay in France worthwhile, and I will cherish the exchanges I had with him.

I would like to extend my gratitude to Prof. Lyes BENYOUCEF and Dr. Mehrdad MOHAMMADI who served as my examiners. Prof. Lyes BENYOUCEF is an expert in my subject area and his published works and multiple meetings helped me immensely in positioning my research. I would also like to thank my defense committee members Prof. Lionel AMODEO, Prof. Reza TAVAKKOLI-MOGHADDAM, Prof. Aamer BAQAI and the president of my defence jury Prof. Olga BATTIAIA for providing me valuable suggestions for future research. I am indebted to Prof. Lyes BENYOUCEF and Prof. Lionel AMODEO for evaluating my thesis and highlighting pertinent aspects for improvement. I value the effort and dedication of the jury and report readers.

I am thankful to my colleagues in the ENSAM lab for their support and friendship. I would like to mention Dr. Wahb ZOUHRI, Dr. Uzair KHALEEQ-UZ-ZAMAN, Dr. Jelena PETRONIJEVIC, to name a few, who were always available at hand to extend their help. I appreciate the helping role of the staff at ENSAM for providing administrative help.

I am thankful to my family for compelling me to become a better version of myself. My parents have always provided me moral support and the courage to stand for what is right. My siblings have always reached out to me for any possible help during my stay abroad. I am thankful to my wife for taking an excellent care of our beautiful kids in my absence.

*I would like to dedicate this thesis to my parents who have been my support pillars through thick and thin. I am thankful to both of you for shaping me into the person I am today. To my father “in you, I find a role model”. I am thankful to my wife for being an exceptional mom in raising the kids in my absentia.*

# FOREWARD

This thesis is supported by the Higher Education Commission (HEC) Pakistan in collaboration with Campus France under the student file number 904180K. The duration of the thesis was from February-2018 to January-2021. The thesis took more time to complete due to the emergence and spread of the novel COVID-19 pandemic. The domain of this research falls in Industrial Engineering with a focus on manufacturing systems. The topic of research is “The analysis of quality in a Reconfigurable Manufacturing Systems” by using operation research techniques.

The Reconfigurable Manufacturing System is an advanced field of research that offers a quick changeability and enhanced level of functionalities. Unlike its predecessors i.e., dedicated lines and flexible manufacturing systems, it can produce a variety of products with a high level of throughput. Thus, it has thus revolutionized industrial and manufacturing practices. Although it has contributed to the industrial and research arena; however, it involves multiple facets of configurations, tools, and modules to perform different operations. This has led to complexity in the design and implementation of the reconfigurable manufacturing systems. Due to this complexity, it becomes difficult to analyse its quality of production as it offers numerous production routes to perform the same operation.

This research is designed to analyse the impact of different defects and machine disruption on the quality of production in a reconfigurable manufacturing system. The different manufacturing defects are considered by investigating the functional requirements and design parameters of a manufacturing system. The goal is to understand how the process planning efforts in a reconfigurable manufacturing system are affected by the variation in quality and defects. To do so, a multi-objective model involving the novel objectives of cost, quality decay index, and modularity efforts is proposed. A hybrid version of two powerful meta-heuristic is proposed to implement the model. To help managers understand and compare the effect of quality variation, the process planning in reconfigurable manufacturing systems is carried out with and without any variation in quality and associated defects. The models and solution approaches are implemented in two industrial case studies.

This research is a first attempt towards investigating the quality aspects of reconfigurable manufacturing systems. Several recommendations and perspectives are proposed for both practitioners and researchers to advance this field of research. These recommendations will offer an enabling environment to closely analyse the different sources of defects and quality variation and how they can influence the profitability, cost, modularity, and responsiveness of a reconfigurable manufacturing system.

# Table of Contents

<b>FOREWARD</b> .....	iv
List of Figures.....	viii
List of Tables.....	x
List of Abbreviations.....	xi
<b>INTRODUCTION</b> .....	1
1.1. Background of Reconfigurable Manufacturing System.....	2
1.2. RMS Characteristics.....	3
1.2.1. Modularity.....	3
1.2.2. Integrability.....	4
1.2.3. Customization.....	4
1.2.4. Convertibility.....	4
1.2.5. Scalability.....	4
1.2.6. Diagnosability.....	5
1.3. Quality aspects in Reconfigurable Manufacturing System.....	6
1.4. Process planning in RMS.....	8
1.5. Manufacturing System Design Decomposition.....	11
1.6. Thesis research statement.....	13
1.7. Research objectives.....	13
1.8. Research scope and limitations.....	14
1.9. Thesis outline.....	15
<b>LITERATURE REVIEW</b> .....	16
2.1. Modularity analysis in RMS.....	17
2.2. The analysis of cost in RMS.....	19
2.3. Quality Performance Assessment in Manufacturing Systems.....	22
2.3.1. Qualitative approaches towards the assessment of quality.....	22
2.3.2. Quantitative approaches towards the assessment of quality.....	23
2.4. The analysis of quality in FMS.....	24
2.5. The analysis of quality in RMS.....	24
2.6. Assignable causes of quality variation.....	26
2.7. Literature summary and gap analysis.....	28
2.8. Research Problem.....	37
<b>CHAPTER 3</b> .....	40
<b>MATHEMATICAL MODEL</b> .....	40
3.1. Models.....	41
3.1.1. Model 1.....	42
3.1.2. Model 2.....	43

3.1.3. Model Notations.....	45
3.2. Assumptions and model hypotheses .....	46
3.3. Quality Decay Index .....	47
3.4. Total Cost.....	49
3.5. Modularity Effort.....	51
CHAPTER 4 .....	54
SOLUTION APPROACHES AND RESULTS.....	54
4.1 Review of Solution approaches.....	55
4.1.1. Exact solution approaches.....	55
4.1.2. Meta-heuristic approaches .....	56
4.2. Complexity of the model.....	60
4.3. Proposed solution approaches.....	60
4.3.1. The $\epsilon$ -constraint solution approach.....	60
4.3.2. Hybrid NSGA-II-MOPSO .....	61
<i>Phase 1 of hybrid meta-heuristic</i> .....	64
<i>Phase 2 and Phase 3 of hybrid meta-heuristic</i> .....	64
<i>Phase 4 of hybrid meta-heuristic</i> .....	65
4.3.5. Stopping criteria.....	66
4.4. Performance metrics .....	66
4.5. Results and analysis .....	67
4.5.1. Model verification.....	67
4.5.2. Model validation- Case study 1 .....	73
4.5.2. Model validation- Case study 2 .....	81
CONCLUSIONS.....	97
AND RECOMMENDATIONS .....	97
5.1. Conclusions.....	98
5.2. Recommendations and Perspectives .....	102
References.....	106
<b>Appendix A</b> .....	117



# List of Figures

Figure 1	Changeable functionality of RMS	3
Figure 2	Description of RMS characteristics (Adapted from [9])	5
Figure 3	Configuration layout with paths and quality of production	9
Figure 4	Process plans for different paths.	9
Figure 5	Key requirements for a stable manufacturing system (Adapted from [6])	13
Figure 6	An illustration of modular reconfiguration	18
Figure 7	Manufacturing system design decomposition tree (MSDD) for assignable causes of quality variation (Adapted from [48])	28
Figure 8	The trend of RMS publications over the years	36
Figure 9	Distribution of RMS literature according to journals and databases	36
Figure 10	Process flow of the considered RMS	38
Figure 11	RMS flow line for Model 1 and Model 2	41
Figure 12	The relationship between the proposed index and the number of failed and conforming operations	42
Figure 13	The relationship between i) number of machines and conforming units and ii) number of machines and the proposed index of quality	43
Figure 14	The relationship between production time and quantity of accepted (conforming) units.	44
Figure 15	The distribution of application of solution approaches to RMS problems into exact and non-exact approaches	56
Figure 16	The distribution of application of meta-heuristics to RMS problems into single heuristics, hybrid heuristics, and multi-heuristic approaches	57

Figure 17	The application frequency of different solution approaches to RMS problems	59
Figure 18	Flowchart of 4-phases of hybrid NSGA-II-MOPSO	63
Figure 19	Non-dominated solutions of small-sized problems using FI (Model 1)	68
Figure 20	Non-dominated solutions of small-sized problems using BI (Model 1)	69
Figure 21	Non-dominated solutions of large-sized problems using FI (Model 1)	69
Figure 22	Non-dominated solutions of large-sized problems using BI (Model 1)	69
Figure 23	CPU time of solution approaches against different problem sizes	70
Figure 24	The effect of mutation rate on convergence and population	71
Figure 25	HV and IGD scores of small and large size problems using FI termination.	71
Figure 26	HV and IGD scores of small and large size problems using BI termination	72
Figure 27	The product and its operational details-Case study 1	73
Figure 28	The precedence order of operations of different features-Case study 1	73
Figure 29	Cost breakdowns of Model 1 and Model 2	78
Figure 30	Comparison of modular features of different models	80
Figure 31	The product and its operational details- Case study 2	81
Figure 32	The precedence order of operations of different features-Case study 2	82
Figure 33	Changing needs from the current production setup to a modified production setup	97
Figure 34	A typical supply chain of the production system (Adapted from [27])	104
Figure A1	Causality between different KCs (adapted from [132])	116
Figure A2	Figure A2. Encoding and decoding schemes	117
Figure A3	Figure A3. Partially Mapped Crossover (PMX)	118

# List of Tables

Table 1	An example of a typical process plan	8
Table 2	Literature summary of the reconfigurable manufacturing system	31-35
Table 3	Linearization of non-linear products	53
Table 4	Example of matrix used for the encoding scheme	65
Table 5	Operations, TADs, modules, operation time, and cost associated with different product features-Case study 1	74
Table 6	TADs, modules, and exploitation cost of different machine configurations-Case study 1	75
Table 7	Module addition, subtraction, and re-adjustment time for different auxiliary modules-Case study 1	75
Table 8	Feasibility and production rate of configurations for different operations-Case study 1	76
Table 9	Configuration change cost between different machine configurations-Case study 1	76
Table 10	The non-dominated solutions of Model 1 and Model 2-Case study 1	77
Table 11	Detailed process plans of optimal objective functions-based solutions-Case study 1	78
Table 12	Operations, TADs, modules, operation time and cost associated with different product features-Case study 2	83
Table 13	TADs, modules, and exploitation cost of different machine configurations-Case study 2	84
Table 14	Module addition, subtraction, and re-adjustment time for different auxiliary modules-Case study 2	85
Table 15	Feasibility and production rate of configurations for different operations-Case study 2	86
Table 16	Feasibility and production rate of configurations for different operations-Case study 2	87
Table 17	Configuration change cost between different machine configurations-Case study 2	88
Table 18	The non-dominated solutions of Model 1 and Model 2-Case study 2	89
Table 19	The detailed process plans of top-non-dominated solutions-Case study 2	91
Table 20	The detailed process plans of top-non-dominated solutions-Case study 2	92
Table 21	Detailed process plans of optimal objective functions-based solutions-Case study 2	93
Table 22	Detailed process plans of optimal objective functions-based solutions-Case study 2	93

# List of Abbreviations

*(Arranged according to the order of appearance)*

RMS	Reconfigurable Manufacturing System
RMT	Reconfigurable Manufacturing Tool
KC	Key Characteristic
MSDD	Manufacturing System Design Decomposition
MS	Manufacturing System
FR	Functional Requirements
DP	Design Parameters
TC	Total Cost
QDI	Quality Decay Index
ME	Modularity Effort
NSGA-II	Non-Dominated Sorting Genetic Algorithm
MOPSO	Multi-Objective Particle Swarm Optimization
AAMA	American Apparel Manufacturers Association
TOPSIS	Technique of Order Preference by Similarity to Ideal Solutions
MIP	Mixed Integer Programming
AMOSAS	Archived Multi-Objective Simulated Annealing
GHG	Greenhouse Gases
FMEA	Failure Mode and Effect Analysis
RCA	Root Cause Analysis
QLF	Quality Loss Function
QFD	Quality Function Deployment
SOVA	Stream of Variation Analysis
SPC	Statistical Process Control
DOE	Design of Experiments
VRM	Variation Resource Management
EOT	Engineer-To-Order
MOT	Make-To-Order
TAD	Tool Approach Direction
SLP	Serial-Line-in-Parallel
PE	Process Elements
DM	Decision Maker
R	Responsiveness
Q	Quality
PC	Production Cost
CC	Configuration Cost
QC	Quality Cost
PT	Production Time
CT	Configuration Time
QT	Quality Time
DA	Decomposition Analysis
M	Modularity
NM	Number of Machines
TMC	Total Machine exploitation Cost
SC	Scrap Cost
TR	Rework Cost
RC	Reconfiguration Cost

# INTRODUCTION

*The modern markets require cost-effective products with an adequate level of durability. The durability aspect of a product is primarily defined by its quality and conformance to design standards. Thus, the analysis of product quality lies at the heart of the manufacturing system design. Further, the analysis of quality-related issues is advantageous for a manufacturing system from a profit and sustainability point of view. To be more sustainable towards the quality protocols; it is imperative to identify the root causes of quality variation and defects in a manufacturing system. This chapter discusses quality aspects in the Reconfigurable Manufacturing System (RMS). RMS is an advanced field of manufacturing that is cost-effective, changeable, and responsive. A brief background of RMS and process planning is provided at first and then the research statement, objectives, and thesis outline are presented. In more detail, this chapter is designed as following. Section 1.1 offers the background of RMS by comparing it with other manufacturing systems. Section 1.2 describes the RMS characteristics and the selection of characteristics for this study. Section 1.3 highlights the role of quality in a reconfigurable manufacturing system. Section 1.4 discusses the process planning in RMS and explains the different trade-offs between the choice of solutions during process planning and how quality can impact such trade-offs. Section 1.5 explains the Manufacturing System Design Decomposition (MSDD) which helps in dividing a complex system into different levels/sub-systems. Section 1.6 briefly discusses the statement of undertaken research problem related to the analysis of cost, time, and modularity. Section 1.7 provides the objectives of this research. Section 1.8 discusses the scope and limitations of this research. Lastly, Section 1.9 outlines and briefly explains the chapter-wise organization of the thesis.*

## 1.1. Background of Reconfigurable Manufacturing System

Modern manufacturing systems are facing different challenges due to the dynamics of customer demands. These challenges can take the form of changing trends of product requirement and functionality, product mix, cost-effectiveness, and responsiveness, etc. The traditional manufacturing systems such as Dedicated Manufacturing Lines (DML) and Flexible Manufacturing Systems (FMS) are unable to cost-effectively address such challenges. For example, DMLs are suitable for mass production while they lack product mix and variety. On the other hand, FMSs can accommodate the product variety; however, they are not appropriately designed for high throughput of production. Further, they offer an overwhelmed amount of flexibility in their system design which is underutilized and thus they can prove to be a costly manufacturing system. To cope with such issues, a novel manufacturing system called Reconfigurable Manufacturing System (RMS) was introduced. RMS is defined as “*a changeable system designed at its outset to respond to changing market by offering functionality and capacity needed when needed*” [1]. The changeability and functionality aspects of RMS can be explained with the help of an example given in Figure 1. An initial configuration called original configuration is available which processes a product by using a set of tools. The modified forms i.e., configurations *A*, *B*, and *C* are obtained by using a different worker/tools/product. Thus, the functionality of the existing configuration can be adapted to the changeability requirements. This makes RMS a novel production taxonomy and enhances its flexibility to accommodate different changes.

RMS can accommodate diverse production requirements by using a novel Reconfigurable Manufacturing Tool (RMT) to produce a variety of products in their required demand. RMT helps the RMS to perform a variety of operations by changing between its respective configurations. To change between these configurations, RMS needs two types of modules i.e., basic, and auxiliary modules. The basic modules are fixed in nature, and they form the foundational basis of the RMS design. On the other hand, the auxiliary modules are changeable, and they support the abrupt changes brought into the system. Besides these modules, an RMS offers the distinguished characteristics of Modularity, Integrability, Customization, Convertibility, Scalability, and Diagnosability [2]. These characteristics play an essential role in the architectural design of RMS and its functionality over the period of its use. The RMS characteristics are discussed in the below sub-section.

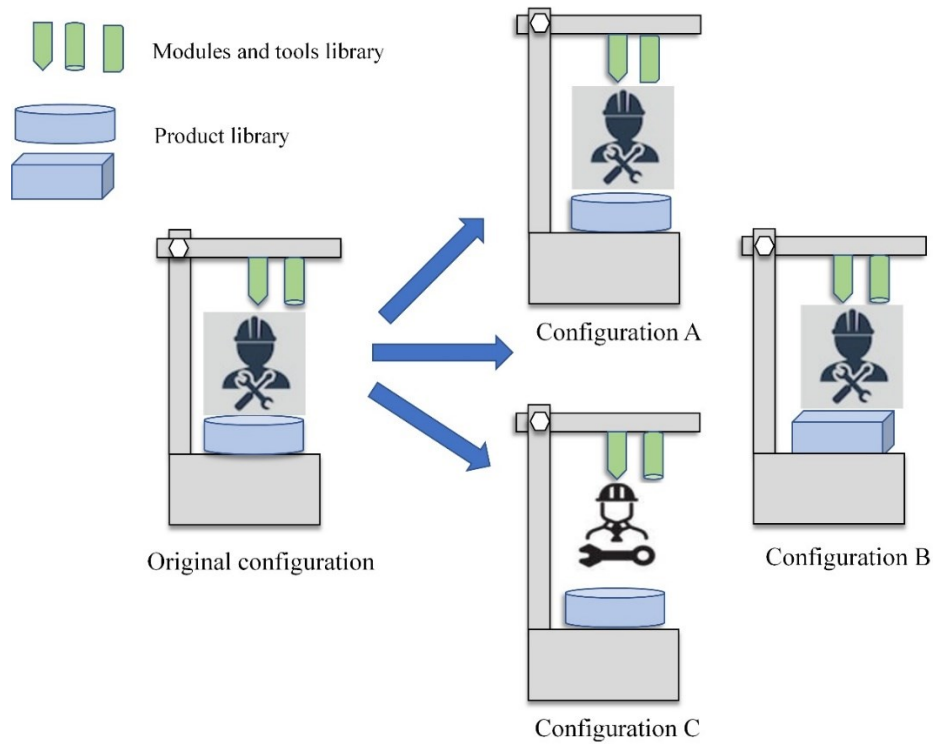

Figure 1. Changeable functionality of RMS

## 1.2. RMS Characteristics

RMS offers different characteristics which distinguish it from other manufacturing systems. These characteristics are Modularity, Integrability, Customization, Convertibility, Scalability, and Diagnosability. The description of each characteristic is provided in the following sub-sections.

### 1.2.1. Modularity

RMS uses different tools which link the operations with feasible machines and their respective modules. An RMS can be adapted to perform various operations by using different combinations of tools, machine configurations, and modules. This characteristic of RMS is called modularity. It enables the RMS to perform a variety of operations by using a single machine which enhances the overall usefulness of the reconfigurable systems.

### 1.2.2. Integrability

This characteristic is used to integrate the product-process mix in RMS, i.e., by considering the cluster of product features and relating them with the process capabilities. In addition, controls and process units are also designed to be integrated into the overall system.

### 1.2.3. Customization

Customization helps in designing a reconfigurable system around a part family instead of a single product. Thus, minimum effort is needed to produce different parts from the same family of products. Compared to a flexible manufacturing system, which offers a generalized level of flexibility, RMS offers customized flexibility in manufacturing which makes it more cost-efficient. In other words, RMS uses the extent of flexibility needed, when needed by using the customization characteristic. RMS is expensive manufacturing, and it needs higher initial investments. Customization enables the RMS to produce a variety of products to justify the higher investments.

### 1.2.4. Convertibility

A manufacturing system needs to be flexible enough to adapt to the different product needs. RMS uses the convertibility characteristic to adapt to such product/operational needs. It is converted from its current state to a modified state to assist in the production requirements of different operations, e.g., a spindle might be added, or multiple other functions can be involved.

### 1.2.5. Scalability

As the level of demand fluctuates, a manufacturing system needs to adjust its production accordingly. In a contrary situation, the level of production will be either more than what is needed which will result in excessive product units/extra cost or it will be less than the required demand, resulting in an opportunity loss. Thus, a scalable manufacturing system will assist in avoiding both extra cost and opportunity loss. The level of production in RMS can be scaled up/down by adding/removing reconfigurable machines, both in series as well as in parallel.



### 1.2.6. Diagnosability

A production system may not always perform at its optimal working condition and can undergo certain problems. These problems can be due to the failure of the machine, tooling error, or other issues. It is imperative to detect the potential sources of machine failures and to identify the causes of bad quality production. The inability to do so can affect the level of acceptable production and loss in profit. RMS uses its diagnosability characteristic to perform system diagnostic by using statistical techniques and signal processing procedures. Figure 2 describes different RMS characteristics.

This research considers the *modularity* characteristic in the design of RMS process planning. An index is defined for modularity which considers the modular efforts wasted during reconfiguration as well as the modular effort wasted due to bad quality production. Certain modular efforts are needed to produce each product unit and the failure of a product unit means that this effort is also wasted. Further, this research also considers *diagnosability* in the sense that the proposed model considers the failure and disruption of the machine as well as the analysis of multiple causes of quality variation and defects. These causes of variation result in failed product units which are covered in the discussion of the Manufacturing System Design Decomposition (MSDD) framework.

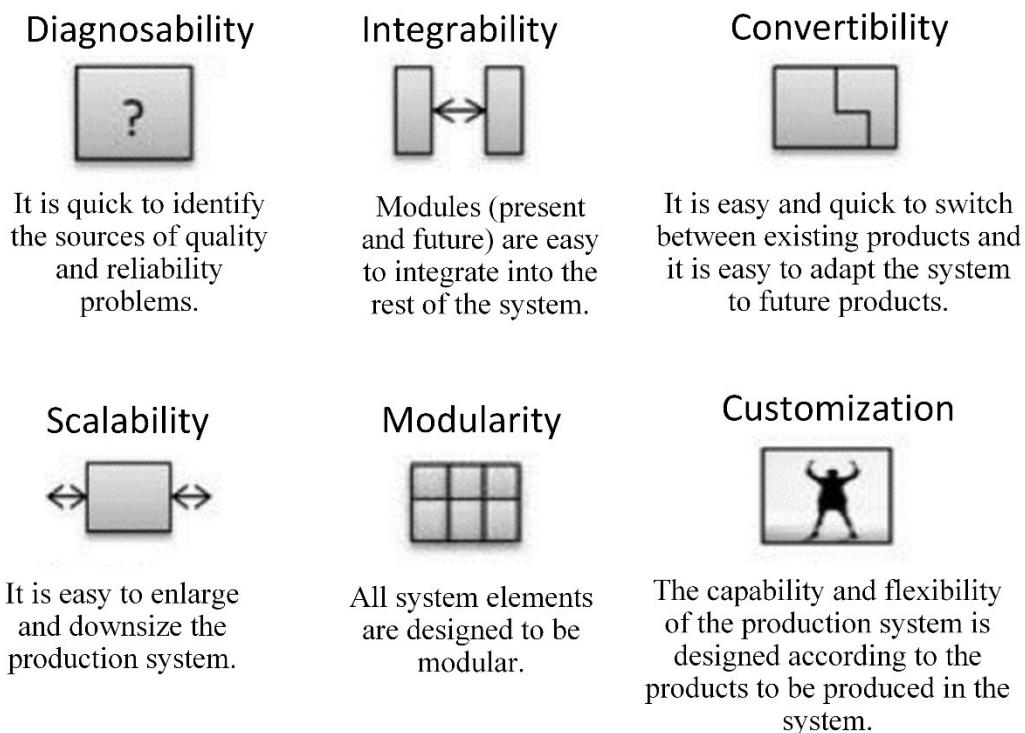

Figure 2. Description of RMS characteristics (Adapted from [10])

### 1.3. Quality aspects in Reconfigurable Manufacturing System

One of the important aspects of any manufacturing system is its ability to adapt and adjust to quality variation and malfunctions. The quality of products and processes is influenced by many factors such as the nature of defects, disruption of machines, etc. In addition, a system becomes complex when there are a higher number of ways to connect machines in its production system. RMS is a complex manufacturing system as it uses gantries and conveyers to connect the reconfigurable machines. Such arrangement multiplies the number of possibilities to link the machines. Thus, it becomes harder to analyse its quality of production.

This ability of RMS to offer many production routes results in two quality-related problems [3]. Firstly, the variation in product dimensional quality increases as the product passes through different configurations. Secondly, if there is a problematic machine, it is hard to trace it merely by inspecting the quality of products. In other words, thanks to the enhanced capabilities of RMS, a product may pass through one of the several designated routes. For example, for 20 RMS production stages, each containing 6 machines, there are as many as  $3.6 \times 10^{15}$  ways to connect the machines [4]. This makes it complicated, even impossible, to analyse the product quality in each route.

In addition, every aspect of a product cannot be analysed by a manufacturing system. Thus, a system only considers certain aspects of a product called Key Characteristics (KC's). KC accounts for most of the quality variation and disruption of a product. In other words, the overall quality of a product can be improved by enhancing the quality of its key characteristics [5]. The dimensions, precision, and tolerances are some of the examples related to KC.

KCs identify the crucial aspects of a manufacturing system that can influence the performance variables such as cost, quality, responsiveness, etc. Due to technological and time constraints, managers find it difficult to analyse and improve each characteristic. Thus, the identification of key characteristics helps managers in devoting their efforts to a set of minimum characteristics which can substantially improve the efficiency of a manufacturing system. For example, from the product point of view, the possible key characteristics can be tolerances, surface finish, and conformance to design parameters. Once the list of key characteristics is formulated, the next task is to identify the assignable causes in a manufacturing system that can influence the behaviour of these characteristics. For example,

machining and process precisions are some of the assignable causes that can influence these KCs. Such assignable causes are responsible for the variation in the quality of Key Characteristics (KC). Variation in this context is defined as “the deviation from standard specifications”. As established earlier, since RMS is a complex manufacturing system, thus the role of KCs and the synthesis of quality variation is even more prominent in analysing its performance.

To analyse the quality performance of RMS, a set of KCs can be defined which are central in impacting the overall efficiency. These KCs can either be identified by consulting the managers or by analysing the established literature on RMS and the quality performance indicators. The identification and the modelling of such KCs highlight the role of quality in assigning configurations to different operations (also called process planning). The identification of KC and their related discussion is covered in Section 1.5 by using the Manufacturing System Design Decomposition (MSDD) framework. To summarise, this research aims to address the following questions:

- What is the impact of quality variation on the performance of RMS process planning? i.e., the evaluation of process plans in terms of the number of conforming and failed operations.
- How a Manufacturing System Design Decomposition (MSDD) framework can be applied to RMS and what are the prominent assignable causes of variation which influence the overall product quality in RMS?
- What is the trade-off between quality, cost, and modularity in the context of RMS? The modularity index is defined in relation to quality, and it considers the proportion of lost effort in producing failed operation units.

The concept of manufacturing system design decomposition and modularity will be discussed in the forthcoming sections. The above questions, if addressed appropriately, will enable managers to assign machine configurations to operations with a minimum impact on the product quality. Furthermore, it will help in the synthesis of modular efforts needed for completing the overall set of operations, also called process planning. The section below discusses process planning in RMS and the impact of different objectives on the process planning decisions.

## 1.4. Process planning in RMS

Process planning is a pertinent issue in RMS, and it assists in the logical flow of a reconfiguration. Musharavati and Hamouda [6] defined process planning as “*the process of facilitating the logical reconfiguration in a manufacturing system designed to be reconfigurable, to achieve cost efficiency*”. The ability to logically reconfigure a manufacturing system is dependent on the reconfigurability and flexibility inherited in a system.

Process planning is not a standalone decision, rather it depends on the knowledge of operation sequence and routing in a manufacturing system. For a multi-part or multi-feature RMS, the sequence of operations in the respective part/feature will follow its route in terms of the use of machine configurations, modules, and tools. This information will be used by the process planning to assign configurations to operations to optimize the efforts of cost, time, etc. A typical process planning decision considers the matrix of machines, configurations, modules, and tools as an input to assign them to the operations of respective features. An example of a process plan is given in Table 1. It can be read column by column such as machine 1 ( $M_1$ ) with 3<sup>rd</sup> configuration ( $C_3$ ) uses the modules ( $A_1, A_7$ ) and tool  $T_3$  for 2<sup>nd</sup> operation ( $O_2$ ) of the first feature ( $F_1$ ).

Table 1. An example of a typical process plan

Machines	$M_1$	$M_2$	$M_1$	$M_3$	$M_2$	$M_1$	$M_1$
Configurations	$C_3$	$C_5$	$C_2$	$C_4$	$C_6$	$C_1$	$C_1$
Modules	$A_1, A_7$	$A_4$	$A_2, A_8$	$A_5$	$A_4, A_3$	$A_6$	$A_8, A_9$
Tools	$T_3$	$T_5$	$T_2$	$T_6$	$T_4$	$T_3, T_1$	$T_1$
Operations	$O_2$	$O_6$	$O_1$	$O_4$	$O_5$	$O_7$	$O_3$
Features	$F_1$	$F_2$	$F_1$	$F_2$	$F_2$	$F_2$	$F_1$

Different process plans will result in different solutions. If cost and time are the ultimate objectives to be optimized, a particular process plan may perform well on the dimension of cost, however, it may take more time to complete. Although subjective in its nature, a manager can still select a sub-optimal feasible solution by selecting a process plan concerning the optimal value of cost or time. This will impact the solution offered by the other objective function. One objective that is always in conflict with production time and cost is the quality of production. For example, a quality product needs precision, process knowledge, defect-free production, and conformance to standards which all come at an additional investment and production time. In the modern era, it is worthless to say that we have produced  $x$  quantity of

products in  $a$  period instead of  $b$  period ( $a < b$ ) if either the shortened time impacts the product quality, or the product quality analysis is not considered at all.

It thus becomes a bigger challenge to analyse the product quality in RMS due to:

- i) The complexity inherited by RMS in offering a high number of production routes makes it difficult to analyse the quality through each route.
- ii) The quality-based solutions can potentially impact the solutions of cost, time, etc. For better understanding, we consider the following example.

As shown in Figure 3, there are six reconfigurable machines available, each containing two configurations, to perform Feature 1 (F1). The state of quality of each configuration can be read by using the rubric given in the figure. The feasible paths to process this feature are  $a$ ,  $b$ ,  $c$ ,  $d$ , and  $e$ , and the corresponding process plans used in each path are provided in Figure 4. The objective is to assess the cost, time, and quality of each path.

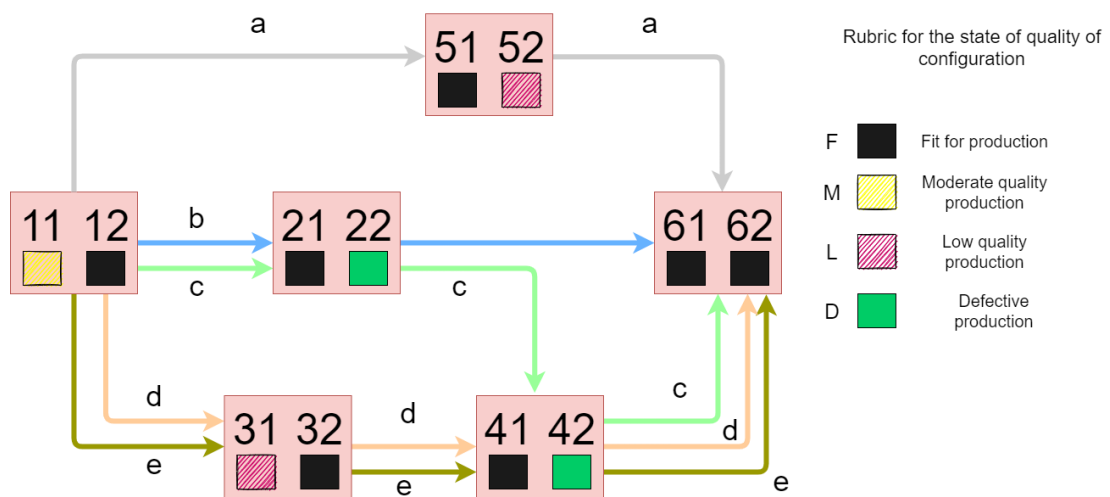

Figure 3. Configuration layout with paths and quality of production

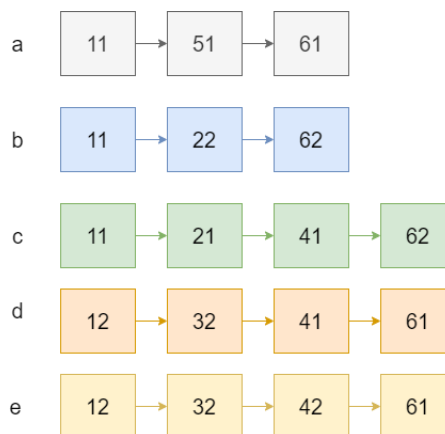

Figure 4. Process plans for different paths.

The solutions offered by *a* and *b* will be better concerning the cost and the time as they use a smaller number of configurations (3 in each case). However, path *b* will be compromised concerning the quality as it contains a defective machine configuration. The defective nature of the machine can be attributed to variation in quality due to maintenance issues, poor tooling, or any other assignable cause of quality variation. If we compare the process plan of paths *c*, *d*, and *e*; all of them use the same number of configurations (4 in each case). In fact, between paths *d* and *e*, there is only one difference of configuration while the remaining types of configurations are the same for both. The results of these paths might indicate that all of them differ in all three objective function values. Path *e* may perform low on the quality dimension as it uses a defective configuration (42) while path *d* will perform well in terms of quality, however, it may offer sub-optimal solutions of cost and time. To analyze or optimize the cost or/and the time of a process plan or a reconfigurable process plan, a simple directed acyclic graph is used to model the operations and the anteriority. To analyze or optimize the product quality of a process plan or a reconfigurable process plan, a non-oriented graph is used to model the operations, the structure of the manufacturing system, and the fixtures (capability process assessment for each tolerance). Therefore, the difference in modeling impacts the complexity of the quality assessment of a process plan or a reconfigurable process plan. A discussion on the directed graph and non-oriented graph and their relationship with quality is provided in [Appendix A](#).

Although the same number of configurations have been used in the latter three paths, the difference in solutions is because each configuration:

- a)* has a different machine exploitation and operation cost.
- b)* needs different time values for adding, subtracting, and re-adjusting the modules according to the operational requirements which results in time differences.
- c)* operates in a different state of quality which can impact the process planning decision.

It is understood that such analysis of the process plan will be helpful for managers in evaluating the impact of different paths on the solution efficiency of various objective functions, especially quality. Once this understanding is developed, future research can aim at analysing the impact of the position of a defective configuration on the quality of production. For example, a question can be asked such as “what is the difference in the quality of production if a defective configuration operates in the start or towards the end of a process plan?” For a

complex system such as RMS, it is advantageous to examine its quality by dividing the system into different levels. This can be accomplished by using a Manufacturing System Design Decomposition (MSDD) framework which is discussed in the below section.

## 1.5. Manufacturing System Design Decomposition

The performance of a complex manufacturing system can be easily analysed by decomposing it into modules and elements. It is thoughtful to do so as manufacturing systems are a complex phenomenon and they involve the interaction between several elements, making it very difficult to analyse the impact of low-level issues and in response, change the architecture of the manufacturing system [7]. The literature contains certain approaches towards the decomposition of a manufacturing system. For example, Spearman and Hopp [8] offered a reductionist perspective that divides a major system into small components to make it easier for analysing the behaviour of each component.

Once the manufacturing system is decomposed, its components can be classified into different levels according to their functionalities. Furthermore, the performance of the components at each level can be analysed and their impact on the top-level components can be investigated. Each manufacturing system is designed to optimize some criteria of objective functions such as cost, time, responsiveness, quality, etc. which rests at the top level of the decomposed structure. Thus, decomposition helps in relating low-level activities and tasks to higher-level objectives and functional requirements. It also helps in analysing and interpreting the relationship among the components of a system design.

The above discussion aims to introduce the Manufacturing System Design Decomposition (MSDD) framework and its application to the reconfigurable manufacturing system. The MSDD decomposes the overall objectives of a manufacturing system into measurable sub-components. The effective control of these sub-components demonstrates how well MS has achieved its designed objectives. The decomposition of objectives of MS is performed by using the Functional Requirements (FR) and the Design Parameters (DP). MS defines certain FRs to help answer “what to achieve?”. Once the “what” question is answered, DPs are used to address “how to achieve the FRs?”. In other words, DP constitutes the physical implementation of the FR. The decomposition of a manufacturing system into functional requirements and design parameters can help managers to understand the operational needs of a manufacturing system.

Confusion is normally found in the manufacturing system regarding the objectives and their means. An objective can be minimizing the manufacturing cost and the means to do so may involve activities such as optimal machining, removing redundant activities, and thoughtful deployment of personnel. The machining, removing redundant activities, and personnel-related tasks are not the ultimate objectives; however, they are the means to support and realize the main objective. The same difference is true between functional requirements and design parameters. The design parameters are the operational details to achieve the goals set by the functional requirements. The application of the MSDD framework to RMS can serve the following purposes:

- Compared to other manufacturing systems, an RMS can be easily decomposed into sub-components and modules thanks to its modular structure. This is under the working principle of MSDD which divides a system into modules and sub-components. It will be interesting to analyse the modular RMS from a system design decomposition perspective.
- The application of MSDD to RMS will identify the different sources of variation and their impacts on the overall performance of the system. In Chapter 3, MSDD will be adapted to identify the different sources of variation that impact the product quality in RMS. The managers will be able to perform diagnostics of such variation to improve the quality of production.
- A manufacturing system can be analysed concerning several criteria. Different sets of criteria can be found in the literature with equal applicability and less consensus. In Figure 5, Cochran et al. [7] defined the list of seven criteria for a stable manufacturing system. These are design, quality, problem solution, output predictability, on-time production, analysis of operational cost, and investment. In the literature review section, it will be established that RMS has been analysed from different aspects; however, the existing literature lacks in analysing the quality of production in RMS. Thus, the application of MSDD will support in analysing the quality of a reconfigurable manufacturing system.



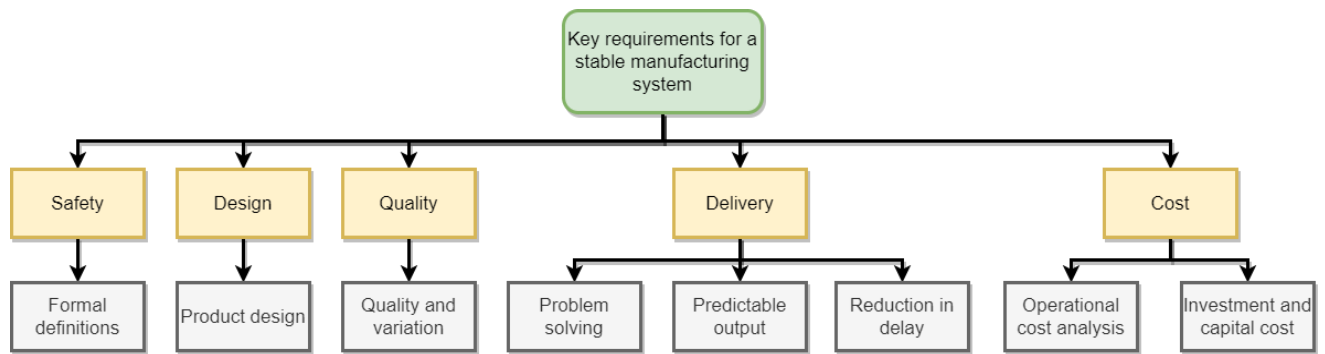

Figure 5. Key requirements for a stable manufacturing system (Adapted from [7])

## 1.6. Thesis research statement

This thesis simultaneously examines the quality, modularity, and cost in a reconfigurable manufacturing system. The impact of variation in quality on the performance of RMS process planning is examined. A novel Quality Decay Index (QDI) is proposed that calculates the number of failed units and conforming units delivered by a process plan. In addition, the analysis is performed by integrating the modularity characteristic of RMS. Modularity enables the RMS to perform a variety of tasks by using its features of basic and auxiliary modules. Shaik et al. [8] proposed to include modularity during the design phase as it influences the overall flexibility and quality. This research considers modularity as an integral aspect of the RMS design and the aim is not only to analyse the impact of quality variation on the performance of RMS but also, how does the modularity of the overall system get affected. An index is defined for modularity which considers the wasted modular effort during reconfiguration and in the presence of quality variation.

## 1.7. Research objectives

This research is carried out to meet the following objectives:

- To study the objective functions of the Total Cost (TC), the Quality Decay Index (QDI), and the Modularity Effort (ME) in RMS process planning. The aim is to analyse how these objective functions are influenced by the quality-related variation. The proposed QDI quantifies the number of conforming and failed units produced by a process plan.

- To highlight and compare the impact of quality variation by using two models. Model 1 performs the analysis by using all three objective functions i.e., TC, QDI, and ME. Model 2 performs the analysis without using the index of quality. In this way, a comparison can be drawn.
- To study the impacts of quality variation on the modularity of RMS i.e., the number of modules used with and without the variation in quality.
- To analyse a complex RMS problem involving cost, time, and modularity by using a hybrid meta-heuristic. It combines the Non-Dominated Sorting Genetic Algorithm (NSGA-II) and Multi-Objective Particle Swarm Optimization (MOPSO) to take advantage of their exploration and exploitation behaviour.
- To implement the model on two case studies which vary in terms of complexity.

## 1.8. Research scope and limitations

The scope and limitations of this research can be described as:

- The MSDD contains certain other functional requirements besides quality. Since the focus of current research is on quality, it does not fulfil the needs of other functional requirements.
- The causes of quality variation can be classified into in-production variation and out-of-production variation. This research only considers the in-production variation caused in quality during the production.
- The presented mathematical model analyses reconfigurable manufacturing system. It is by far one of the complex manufacturing systems and the proposed model can be adapted to simpler manufacturing systems (for example, FMS) by modifying it to a certain extent.
- The Quality decay Index (QDI) is calculated for the worst configuration (pessimistic configuration), therefore, only a simple directed acyclic graph is required.
- The presented model is deterministic; hence, it is not designed to encompass the fuzziness and stochastic behaviour of manufacturing systems. Modern manufacturing systems are more dynamic and uncertain, and they contain stochastic characteristics. Since the model contains certain novelty, it can be considered as the basis and additional aspects of stochasticity can be added to it.

- Lastly, the proposed analysis is designed for a single period and single product; however, it can be extended towards the analysis of multi-product and multi-period RMS design.

## 1.9. Thesis outline

This thesis is organized into 5 chapters. Chapter 2 provides a review related to cost, modularity, and quality performance assessment in the associated literature. The established literature is surveyed regarding the use of qualitative and quantitative approaches for quality assessment. Following this, the existing focus on quality assessment in flexible manufacturing systems and reconfigurable manufacturing systems is presented. Furthermore, the functional requirements and design parameters are discussed to identify the quality characteristics and their associated assignable causes of variation. A detailed summary of the literature is presented for identifying the existing gaps. This chapter concludes by providing the problem statement to analyse the cost, quality, and modularity of a reconfigurable manufacturing system.

Chapter 3 describes the proposed mathematical models. Two models are developed to analyse the process planning performance with and without quality aspects. Three objective functions are thus defined: the total cost, the quality decay index, and the modular effort. The chapter also provides the model assumptions and constraints.

Chapter 4 includes the solution approaches and their application to case studies. It starts by reviewing the applications of meta-heuristics in the RMS design problems. A hybrid version of the Non-Dominated Sorting Genetic Algorithm (NSGA-II) and Multi-Objective Particle Swarm Optimization (MOPSO) is introduced, and its four phases are discussed. Two metrics and two termination criteria are introduced for comparing the performance of different solution approaches. The results are discussed for two different case studies in terms of non-dominated solutions and their detailed process plans. Furthermore, the impact of quality variation is analysed on the modular efforts and cost-efficiency of RMS.

Chapter 5 provides the conclusions of the research work, and it offers implications for practitioners and future researchers. A discussion is presented on the impact created by quality variation on the process planning decisions.

# LITERATURE REVIEW

*This chapter presents the literature review related to the considered problem. The literature is analysed according to different classifications by describing the state-of-the-art and positioning the contributions offered by this research. This chapter is structured as follows. Section 2.1 offers the literature related to modularity and discusses the modularity issues in RMS design. Different contributions and modelling approaches are surveyed to understand the modularity aspects. In Section 2.2, the literature related to the analysis of cost is presented. It helps in understanding the aspects of cost considered in the established literature for assessing the RMS performance. Section 2.3 discusses the literature related to qualitative and quantitative approaches for assessing the quality of production. Following this, quality issues in Flexible Manufacturing System (FMS) and Reconfigurable Manufacturing System (RMS) are discussed in Section 2.4 and Section 2.5, respectively. The assignable causes of quality variation and Manufacturing System Design Decomposition (MSDD) are discussed in Section 2.6. Section 2.7 provides a detailed summary of the literature review where different research gaps are identified. Finally, the chapter is concluded by discussing the research problem in Section 2.8.*

## 2.1. Modularity analysis in RMS

Modularity is an important RMS characteristic, and it can be better understood by drawing an analogy with the workforce assignment. The AAMA, a short form of the American Apparel Manufacturers Association, defined modularity as “*a continued and manageable work unit of 5-17 workers performing a measurable task*” [11]. The workers can be interchanged among the assigned tasks to the possible extent and their incentive is dependent on the quality and efficiency of products. The same mechanism is true for the modules and their interactions. A set of modules are available in RMS which can be interchanged according to the production requirement and to achieve a maximum level of efficiency. As there are two types of modules (i.e., basic, and auxiliary modules), the interchangeability function is performed by using the auxiliary modules. An effective level of modularity can assist in reducing the life cycle cost. Further, it is beneficial to integrate modularity in the early stages of system design for a higher reduction in life cycle cost [12]. A typical configuration layout of RMS is provided in Figure 6. This illustration demonstrates the use of auxiliary modules in different operations. Two reconfigurable machines with two subsequent configurations are arranged in four stages to perform six operations of a product. The first and last production stages perform the first and last operations of the product while each of the second and third production stages performs two operations.

In this section, the literature related to the modelling of the modularity characteristic is provided. Successful execution of RMS lies in the appropriate selection of a set of modules. It means that, from the available modules, a distinct number and types of modules are to be selected which can ensure an optimal performance against the objective functions. Chen et al. [13] proposed a feature-based approach for selecting the optimal number of modules required to produce part family by using reconfigurable machines. A minimum and sufficient set of modules were selected by using an algorithm approach. The functional requirement and design parameters were used to distinguish between geometric features of parts and modules of machines. The geometric features were regarded as the functional requirements whereas the design parameters were defined in terms of modules. The goal was to select appropriate design parameters in the completion of functional requirements.

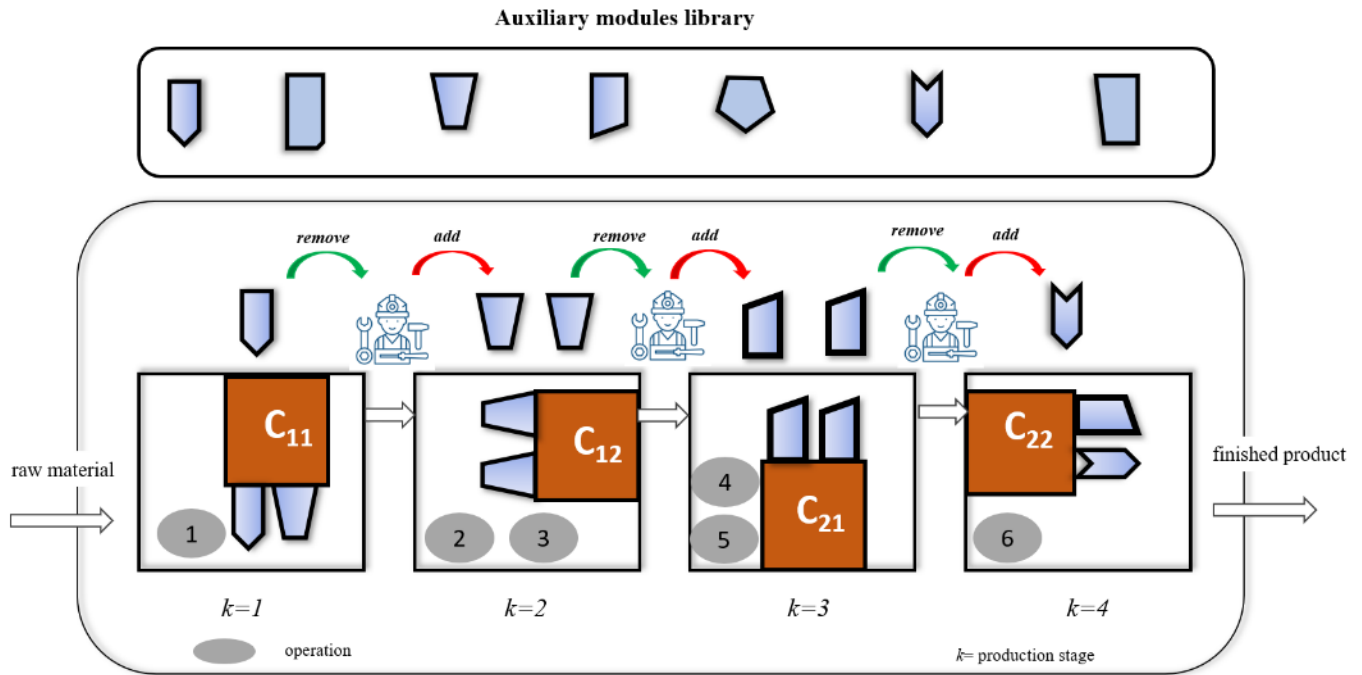

Figure 6. An illustration of modular reconfiguration

Modularity serves as a tool for linking different interfaces of a system. It becomes a challenge to assess the modularity when a system comprises of the higher number of interfaces, such as in the case of RMS. To demonstrate this, Farid [14] calculated two measures of modularity to support the ease in reconfiguration. It was argued that interface complexity influences the modularity of a system. Following this, a quantitative measure of modularity was proposed which was based on the axiomatic design knowledge and design structure matrix. This measure was used for understanding the number of interfaces in a manufacturing system. Haddou benderbal et al. [15] proposed a multi-objective model comprising system modularity and time to assess the performance of process planning in RMS. The objective of modularity analysed the interfaces from various viewpoints such as communality, diversity of operations, and the number of shared and common modules between several machine configurations. The model was applied to a case study by using the Non-Dominated Sorting Genetic Algorithm (NSGA-II) to obtain non-dominated solutions. These solutions were further ranked based on the Technique of Order Preferences by Similarity to Ideal Solutions (TOPSIS). The results showed that the number and types of modules changed across different solutions based on the selection of different machine configurations.

Massimi et al. [16] have recently proposed a sustainable reconfigurable manufacturing system by using the concept of energy consumption. The aim was to select a modular RMS that warranted the minimum value of energy consumption. The model considered two RMS characteristics: modularity and integrability. The energy consumption in modularity considered the energy used in processing, changing configurations, adding, and subtracting auxiliary modules and energy used by basic modules. An exhaustive search heuristic approach has been used for implementing the model. Based on different scenarios, it was reported that the level of energy consumption is strongly dependent on using the type of machine configurations and basic and auxiliary modules.

The core idea of modularity is to divide a complex RMS into a set of elements that can be executed independently and can later be plugged together. Lameche et al. [17] offered the definitions of modularity from design and user perspectives and outlined its different advantages from engineering and system viewpoints. The authors argued that modularity can manage a complex system, improve configuration, minimize the associated risks, and is important in economic decisions. They proposed a design structure method for analysing a modular architecture-based RMS.

Though several contributions have been offered to analyse the modularity; however, its relationship with the quality of production has not been explored. For instance, some issues could be addressed: what is the impact on modularity if there is variation in the quality of production? In other words, how do quality and disruption affect the modular efforts? To do so, this research links quality with modularity, i.e., the effect of quality variation is studied on the modular efforts and changes in configurations during the process planning. This aspect is further explained in Section 3.5 and an index of modularity efforts is proposed.

## 2.2. The analysis of cost in RMS

Cost is an important indicator that is used to assess the performance of a manufacturing system. The analysis of cost has been performed in RMS on several occasions. Single cost function, as well as the amalgamation of different cost functions, have been considered to assess the performance of RMS. The most opted cost functions for designing the RMS are the capital cost and the production cost. This section reviews different cost functions used for modelling the RMS process planning problems. Youssef and Elmaraghy [18] considered the RMS configuration selection problem in two phases. In the first phase, non-dominated

solutions for different demand scenarios were obtained by genetic algorithm and tabu search. The second phase used the same algorithms to derive alternatives from the non-dominated solutions obtained in the first phase for optimizing the transition smoothness. The selection criterion was based on the optimal cost of capital in establishing a configuration. Battaia et al. [19] studied the RMS flowline for batch production by using an optimal cost-based criterion. The main objective was to optimize the equipment cost in meeting demand by fulfilling the constraints. The constraints were related to the design of turrets and modules, the location of parts, and the operations procedure. A MIP (Mixed Integer Programming) model was developed and implemented on an industrial case study. Moghaddam et al. [20] studied the capital expansion cost for scalable configuration design in RMS. A mathematical model was presented to analyse the cases of single production flowline and part family designs.

Deif et al. [21] defined the cost function for RMS which is comprised of two components. The first component was related to the physical capacity cost for scaling the system while the second component was associated with the system reconfiguration. Dou et al. [22] studied an integrated configuration selection and scheduling problem in a reconfigurable flowline. A mixed integer programming model, which included cost and time as objectives, was proposed. The cost function contained the components of reconfiguration and capital cost. The model was deterministically validated and then implemented through NSGA-II. In another study [23], NSGA-II was used for solving the machine selection problem. More specifically, a machine was selected from the set of machines to perform operations with different characteristics. The selection was made based on the minimum cost which comprised of costs related to production, reconfiguration, tool use, and tool change.

Goyal et al. [24] proposed the objectives of cost, reconfigurability, and operational capacity where the objective of the cost was modelled in terms of configuration cost. A Genetic Algorithm (GA) and Shannon entropy approach were used for the identification of non-dominated solutions and their subsequent ranking, respectively. Bensmaine et al. [25] proposed a multi-objective model to design a process plan for multiple units of a single product. The model included the objectives of the total cost and total time. The function of the cost was defined in terms of costs of using machine and tool, changing configuration and tool, and transportation cost.

Zhao et al. [26] proposed a 0-1 programming approach for the cost-effective improvement of reliability of RMS. The objectives were the minimization of reconfiguration



cost and the maximization of system reliability. A coarse-grained GA method was used to solve the model by defining the problem as a single objective function using a novel fitness function. Several test runs and sensitivity analyses were performed to validate the model. Chaube et al. [27] studied a dynamic process planning problem. The proposed approach assessed the compatibility between product requirements and manufacturing functionalities. A feasible process plan was generated if the production was compatible, otherwise, a functionality error was prompted. The goal was to optimize the values of cost and time. Saxena and Jain [28] analysed the costs of investment, reconfiguration, operation, and salvage value for the RMS configuration design problem. The model was applied to different case studies by using the Loerch algorithm. Benderbal et al. [15] performed the analysis of modularity in RMS by using an Archived Multi-Objective Simulated Annealing (AMOS) approach. The objectives of cost, time, and system modularity were analysed. The objective of the cost was based on configurations, modules, and machine exploitation costs. In another study, Dou et al. [29] developed a mixed-integer linear programming model to optimize the cost and the tardiness of RMS. The objective function of cost contained capital cost and reconfiguration cost of a reconfigurable flow line. An exact solution approach was used to validate the model by using benchmark instances.

Touzout et al. [30] studied a sustainable process planning problem by using the objectives of production cost, time, and Greenhouse Gases (GHG). The cost components were related to the cost of changing machine configuration and tool and the processing cost. Different algorithms were applied, and their performances were compared through different solutions. More recently, Khezri et al. [31] designed a multi-objective model for addressing sustainability concerns in RMS. The objective function considered the costs related to the production and disposal of waste and Greenhouse Gases (GHG).

To summarize, the costs related to capital, production, configurations, modules, transportation, installation, and energy consumption have been analysed in the RMS process planning problems. All these cost factors are important in considering various decisions. These decisions are related to optimal resource allocation, selection of a process plan, and changing between respective configurations. To date, the concerned literature lacks in analysing the costs related to variation in quality. RMS is prone to defects due to variation in quality just like any other manufacturing system. For a manufacturing system to perform cost-effectively, it is important to control the costs related to variation against improved quality [32]. In other words, a balance needs to be warranted between cost-quality trade-off by performing a combined

assessment of both. The analysis of variation in quality can help a manufacturing system to identify the sources of variability and ensure a smaller number of defects and lower cost. The costs related to variation in quality can be expressed in the form of repair, warranty claims, scrap, inspection, disruption, under-utilized manufacturing capabilities, etc. [33]. Besides other cost factors, this study analyses the costs related to scrap, re-work, and disruptive performance of the machine in the selection of a process plan. In this way, an integration between cost and quality can be ensured. The next section discusses the literature related to quality performance assessment to identify the potential research gaps.

## 2.3. Quality Performance Assessment in Manufacturing Systems

A manufacturing system can be assessed based on certain performance measurement criteria. The feasible list of acceptable performance measures for any business comprises functionality, cost, time, sustainability, adaptability, productivity, and quality. This section focuses on the performance measure of quality assessment. The ease of measurement of quality in a manufacturing system depends on many factors. These factors comprise of identification of Key Characteristics (KCs) responsible for variation, the importance of KCs in a manufacturing system, and the complexity of a system. The identification and selection of KC are pertinent as it significantly and negatively affects the performance of a product. The literature contains various qualitative and quantitative approaches to analyse the variation in the quality of manufacturing systems. These approaches are discussed in the following sub-sections.

### 2.3.1. Qualitative approaches towards the assessment of quality

Qualitative approaches aim to accumulate the engineering knowledge available in a manufacturing system. This knowledge helps in brainstorming towards the causes of variation and implementing the remedial actions. There are different qualitative approaches in the form of Failure Mode and Effect Analysis (FMEA) and Root Cause Analysis (RCA). These approaches logically link the variation and failures with their respective causes/sources [34, 35]. As a result, a tree of the cause-and-effect diagram is built to highlight the KCs and their impacts on the product's usefulness. Compared to the qualitative approaches, this research offers a quantitative measure for the assessment of quality to help in the selection of a process

plan. As a result of the detailed process plan, points can be identified where more effort is needed. Further, the proposed quality index helps in changing the architecture, manufacturing processes, and resources to achieve better results.

### 2.3.2. Quantitative approaches towards the assessment of quality

The literature contains various indices for variation in quality analysis which have been quantitatively analysed by using different tools. For example, Quality Loss Function (QLF), Quality Function Deployment (QFD), Stream of Variation Analysis (SOVA), and Statistical Process Control (SPC), etc. have been used [36, 37]. The variation in quality can also be analysed by using maximum deviation, root mean square deviation, the fraction of non-conforming items, and/or based on a metric outlining the customer expectations [37]. A noteworthy contribution towards the assessment of quality variation is Taguchi's Quality Loss Function (QLF). It focuses on achieving a specific target value. However, the costs in QLF may not be accurately estimated due to intangible cost factors such as customer dissatisfaction [38]. Another approach to measuring the variation in quality is the traditional Process Capability Index (CPI) given by  $c_p = T/6\sigma$ . It measures the ratio of dispersion to tolerance. Though it helps in comparing and selecting a process plan, it lacks more in-depth knowledge (e.g., the impact of different defects, number of conforming, and failed units).

In the literature, a focus has been given to the identification of causes of variation as opposed to offering indices for measuring its impact on the system's performance. For example, Loose et al. [39] presented a variation source identification methodology to identify the causes of variation. In some cases, raw sensitivity is used to analyse the cause of variation, i.e., by taking the partial derivative of effect variables concerning variables that cause variation. This helps in identifying the variables/characteristics which are critical in the performance of a product. Design of Experiments (DOE), Monte Carlo simulation, Variation Resource Management (VRM), and Pareto analysis are some of the analysis tools which have been used to identify the causes of variation [40]. Further, there are certain contributions to analyse the effects of variation on the performance of the system, prioritizing KCs and analysing the cost of variation [41, 42]. An important approach is the Stream of Variation Analysis (SOVA) for predicting the performance of multi-stage manufacturing systems. The SOVA uses a state-space model for representing a KC [36].

Though different contributions have been offered towards the variation in quality analysis, a focus has been given to the identification of KC. On the contrary, this research assesses the impact of variation in KC on the performance of RMS. The section below presents a more targeted review on the analysis of quality in RMS and Flexible Manufacturing System (FMS). The latter has been selected due to its resemblance with RMS, in terms of flexibility and responsiveness.

## 2.4. The analysis of quality in FMS

The FMS dedicated literature contains qualitative and quantitative approaches for the assessment of quality. For instance, Hsu and Tapiero [43] introduced process quality control and considered various cost components. An important assumption was that all the defective items were scrapped and hence, the re-work of such items was not considered. In another study [44], a fuzzy multi-objective approach was presented to assist in the selection of FMS. The objective of quality was defined in terms of qualitative measures i.e., weak, fair, and good quality. In another study, Li and Huang [45] analysed the probability of good parts in FMS by using a discrete Markov chain approach. It was shown that the quality of FMS is dependent on the quality efficiency during the transition to different products. Souier et al. [46] studied the real-time part routing problem in FMS. They analysed the objectives of workload balancing and reliability. The study did not quantify the number of failed units due to reliability issues or the costs related to the sub-optimal performance of the system. It can be argued that quality in FMS has been defined either in terms of cost or in terms of a qualitative measure (weak, fair, good quality or probability of good parts). From the managerial viewpoint, it is beneficial to know the quantitative impact of variation in quality such as the number of conforming and failed units, which is the aim of current research. This index can be readily applied to the FMS systems as well.

## 2.5. The analysis of quality in RMS

A manufacturing system is designed to accomplish the goals of low-cost, improved quality of production, and responsiveness. The established literature on RMS focuses on achieving the goal of responsiveness through timely production at a low cost. However, it still

needs the support mechanism to accomplish the goal of high-quality production, as, without the emphasis on quality, a responsive and low-cost production will not help in enhancing the customer base and attaining a competitive edge. Besides, compromised quality of production will result in an inefficient use of resources.

RMS is distinguished from other manufacturing systems due to its responsiveness. It enables the RMS to effectively respond to *changes in the market, customer needs, environmental legislations, and coping with manufacturing system failures*.

- The *market changes* may take the form of fluctuation in demand, dynamics of current product evolution, and/or launching an entirely new product.
- The *customer needs* may encapsulate the product mix, customized features in the product, Engineer-To-Order (EOT) and Make-To-Order product (MOT), etc. Thus, a customer may actively participate in the design process which necessitates a manufacturing line-up that can accommodate changes.
- *Environmental legislations* require the manufacturing enterprises to carry out the production in a way that results in a minimum impact on the environment, in terms of emissions. In this regard, sustainable reconfigurable manufacturing systems are gaining popularity and recently, a trend has been observed in which different models have been proposed to analyse RMS from an environmental perspective such as, Greenhouse Gases (GHG) and wastes [30, 31].
- The manufacturing systems are subject to *failures*, and in such events, the emphasis of manufacturing systems should be to analyse the impacts of these failures on the product quality and the performance of the system. Although RMS literature studies the impact of failure on its productivity; however, there is a dearth of literature focusing on studying the impact of failures on product quality.

A manufacturer selects certain manufacturing resources and evaluates their impact on the product KCs. These resources are changed if improvement in the quality is needed, and the analysis is repeated. The process of selection of resources is not cumbersome for a relatively less complex manufacturing system. RMS involves the selection of machines, configurations, modular features, tools, and Tool Approach Directions (TADs), along with the greater number of possible production routes. Thus, it becomes more difficult to analyse the impact of each resource on KC's performance.

To some extent, the notion of quality has been discussed in the RMS literature. A theoretical perspective on different performance measures in RMS namely cost, reliability, utilization, and quality were provided in [47]. The measure of quality was defined as an average of utilization and reliability. The study did not provide a model or solution regarding quality assessment and its associated variation. More recently, Koren et al. [4] compared different manufacturing systems including Serial-Line-in-Parallel (SLP) and RMS. The comparison was carried out based on cost, responsiveness, and quality. It called for a more attentive focus on the assessment of quality in RMS due to its complex structure. There are six (6) key requirements for a stable system such as design, quality, delivery, cost, etc. [48]. The quality requirement needs the production to be completed within defined tolerances which can be achieved by eliminating the assignable causes of variation. Although RMS literature fulfils the requirements of design, cost, etc. it still lacks in analysing the causes of variation to comply with the quality requirement.

This research translates the quality variation into the efficiency of Process Elements (PE) using failure rates. A PE is the characteristic of the manufacturing system which affects the KC. It comprises machining, tooling, production schemes, cutting condition, etc. PE defines the “assignable” causes responsible for variation in the quality of KC. The assignable causes selected in this study are disruption of machines, tolerance-related issues, and tooling errors. To this end, a quantitative index for the assessment of quality in RMS is proposed. This index enables the Decision Maker (DM) in selecting a process plan with minimum variation and defects.

## 2.6. Assignable causes of quality variation

The causes of variation of PE are explained with the help of a Manufacturing System Design Decomposition (MSDD) tree. Figure 7 that is adopted from the work of depicts Cochran et al. [49] depicts the selection of causes of variation. The Functional Requirements (FRs) and Design Parameters (DPs) in the given MSDD are divided into different levels for ease of understanding. At level 1, the objective is to maximize revenue or to minimize the cost which is achieved through customer satisfaction (DP). FRs at the second level are manufacture products to target design specification and deliver products on time. Since the current analysis is based on quality and not time, we focus on the left side of the MSDD tree. The production can be performed within the design specifications by warranting minimal variation in the

processes (DP). At level 3, the FR is the process stabilization that can be achieved by eliminating the assignable causes of variation (DP). Lastly, at the 4<sup>th</sup> level, the goal is to eliminate the assignable causes related to machines, operators, methods/processes, and materials. The former three are related to production processes while the latter is concerned with pre-production (acquiring raw material). Thus, we focus on eliminating the assignable causes of the first three factors. We posit that by controlling these causes, the ultimate objective of a Manufacturing System (MS), i.e., to minimize cost (or to enhance quality) can be achieved.

The causes of variation are related to the Process Elements (PE) of machine, process, and tooling. The variation in quality due to these causes results in defects, as discussed below:

- The cause of the machine-based defects is inadequate maintenance which results in the disruptive performance of the machine. Each machine works perfectly in the start of production, called the control state, and produces optimal quality operation units. However, due to inadequate maintenance, a disruption is observed in its performance. Due to it, the machine goes into an out-of-control state, resulting in variation in quality. Thus, it produces a mix of good quality operation units and failed operation units.
- The cause of process-based defects is a miss-match of tolerances between an operation and a machine. Each operation is specified by the required level of tolerance which needs to be less than or equal to the tolerances offered by a machine. In a contrary situation, a tolerance-related variation occurs that can also result in a failed operation unit.
- The last cause of defects is tooling error which is resulted due to poor finish, wear, and tear, etc. Each operation is specified by a quality characteristic  $k$ . The variation in quality occurs when  $k$  acquires a defect at the level of the tool due to an operator error.

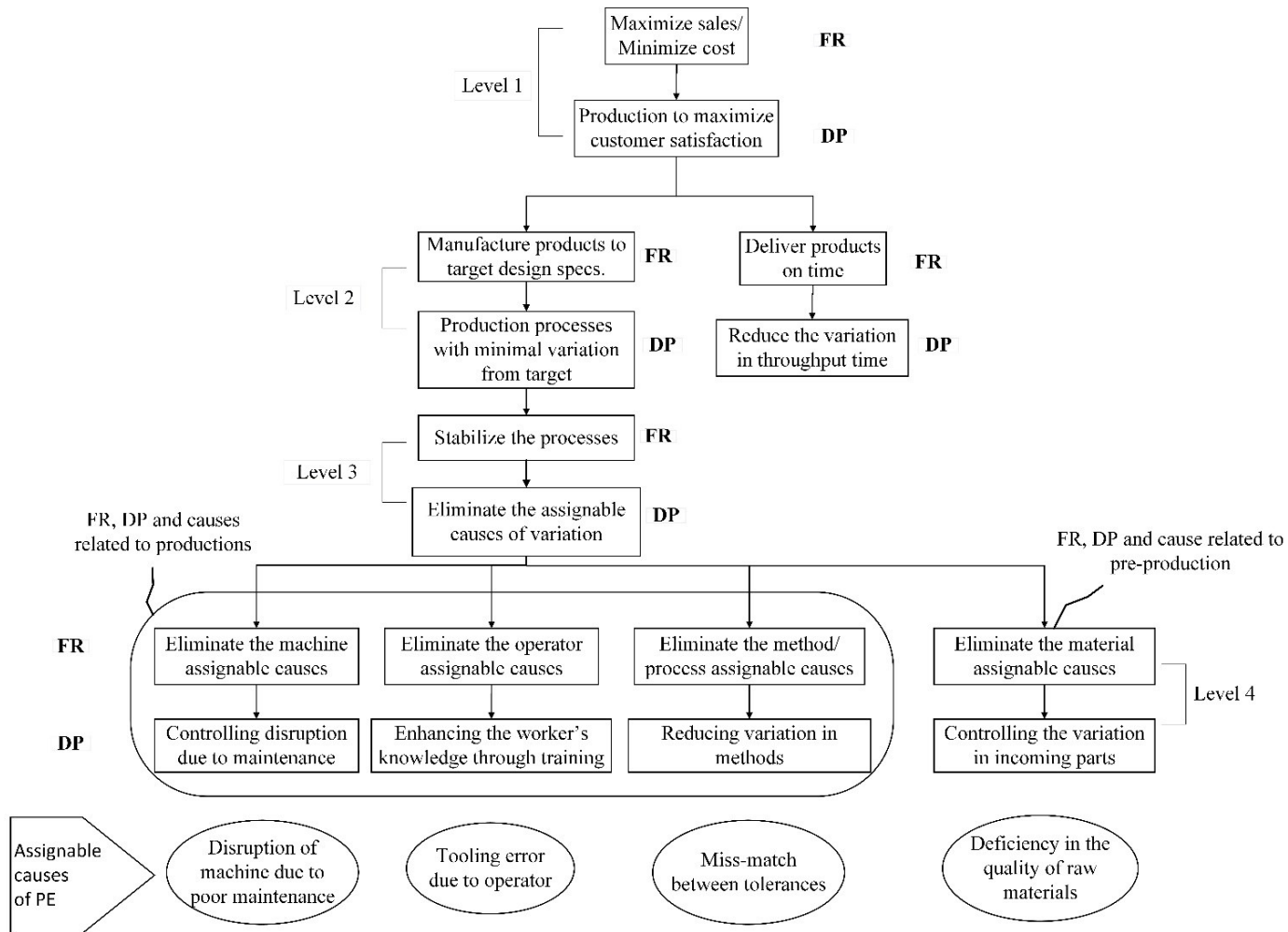

Figure 7 Manufacturing system design decomposition tree (MSDD) for assignable causes of quality variation (adapted from [49])

## 2.7. Literature summary and gap analysis

The above aspects of the RMS literature review have been summarised and provided in Table 2. The literature has been analysed and arranged according to the following considerations:

- **Objective functions:** Some objectives functions were considered, dealing with the problems of cost, time, Responsiveness (R), and Quality (Q). The components of cost include Production Cost (PC), Configuration Cost (CC), and Quality-Cost (QC). Similarly, the components of time are Production Time (PT), Configuration Time (CT), and Quality-Time (QT).



- **Decomposition Analysis (D A):** An analysis of the application of decomposition analysis which breakdowns a complex system into different levels for understanding the quality and variation-related aspects, was performed.
- **Solution approaches:** The literature was surveyed according to the application of different solution approaches. These approaches comprised of exact approaches (linear programming in CPLEX and LINGO etc.,) for deterministic solutions and meta-heuristics for obtaining non-dominated solutions.
- **Modularity (M):** The applications of modularity characteristic of RMS were analysed to understand the system' modelling in the existing works.
- **Focuses of studies:** To highlight the focuses and main contributions of different reviewed works.

It can be observed from Table 2 that the production cost, configuration cost and configuration time have been frequently analysed; however, there is a dearth of research that uses the objectives of quality-cost, quality-time, and quality. Thus, to fill this gap, the proposed model offers the quality-cost objectives in the form of scrap and re-work costs. Similarly, quality-time is analysed in the objective of Modularity Efforts. In addition, a dedicated index for quality assessment is also offered in the proposed model.

The Decomposition Analysis (D A) is a micro-level approach for assessing different parameters which can impact the higher-level objectives such as the quality of production. The existing literature does not discuss such decomposition in the case of RMS (Table. 2). To overcome the issue, this research divides the manufacturing functionalities at different levels to examine the variation in quality.

Several solution approaches have been applied to optimize the performance of RMS. It can be observed from Table. 2 that exact solution approaches, heuristics, and multi-heuristic approaches have been applied when dealing with RMS problems; however, there is a dearth of application of hybrid heuristics. Hybrid heuristics combine two or more heuristics into a single framework to reinforce and take advantage of the powerful aspects of each heuristic. This research combines the powerful heuristics of Multi-Objective Particle Swarm Optimization (MOPSO) and Non-Dominated Sorting Genetic Algorithm (NSGA-II) in a single hybrid meta-heuristic to improve the exploration-exploitation of the search space.

The modularity characteristic has been modelled in the literature with a focus on scheduling, machine capabilities, reconfigurability, and selection of modules. This research

model modularity to understand how it is impacted by the variation in quality, i.e., when there is a variation in the quality and the failed production, what is the impact on the number of machine configurations and the number of changes in a configuration?

Figure 8 presents the growth and trend of RMS literature over the years. It can be observed that this field is continuously growing ever since its inception. Thus, it is worthwhile to inspect its performance under the quality-related variation. As cost and time have frequently been analysed in the relevant literature, the analysis of quality will strengthen the cost, quality, and time pyramid in the RMS literature. Figure 9 presents the distribution of accumulated literature according to different journals and scientific databases. It can be observed that RMS-related literature is published in reputed journals.

Table 2. Literature summary of the reconfigurable manufacturing system

Ref.	Objective functions						Solution approaches					M	Focus		
	Cost		Time		R	Other	Q	D.A	Exact	Heuristic	Multi-Heuristic			Other	Hybrid Heuristic
	PC	CC	QC	PT	CT	QT									
19	✓							MILP/SOLVER						Investment cost analysis	
50		✓			✓			e-constraint			MOPSO/ NSGA-II			Design and scheduling	
51					✓									Reconfiguration	
52		✓			✓			e-constraint						Configuration design and scheduling	
53						✓								Service level	
26		✓									Coarse-grained GA			Reliability analysis	
54		✓					Reliability Equipment cost					Simulation		Facility layout	
55	✓	✓		✓	✓					GA				Configuration selection and sequencing	
56	✓	✓											✓	Scheduling	
57						✓				MOGA			✓	Optimum machine capabilities	
58	✓	✓		✓	✓					GA				Process planning	
59				✓	✓					GA				Maximizing throughput	
60				✓	✓					GA				Analysis of machine selection	
61							Optimal layout					Search heuristic		Layout analysis	
25	✓	✓		✓	✓					NSGA-II				Process planning	
23	✓	✓		✓	✓					NSGA-II				Process planning	
62					✓							IPPS heuristic		Integrated process planning and scheduling	
18						✓	Reconfiguration smoothness				GA, TS			Reconfiguration analysis	
123	✓			✓									PSO and SA	Holonic RMS	

PC= Production Cost, CC= Configuration Cost, QC= Quality Cost, PT= Production Time, CT= Configuration Time, QT= Quality Time, R= Reconfigurability, Q= Quality, D. A= Decomposition Analysis, M= Modularity

Table 2. *Continue*

Ref.	Objective functions						D.A	Solution approaches					M	Focus			
	Cost			Time				R	Other	Q	Exact	Heuristic			Multi-Heuristic	Other	Hybrid Heuristic
	PC	CC	QC	PT	CT	QT											
63				✓												Scheduling	
64											GA					Line balancing	
65								Part family									
66	✓	✓									GA					Scalability	
27	✓	✓		✓	✓						NSGA-II					Process planning	
67				✓				Energy								Environmental analysis	
68							✓								✓	Reconfigurability	
69	✓	✓					✓				NSGA-II					Machine selection	
21	✓						✓				GA					Scalability and scheduling	
											Greedy						
70		✓					✓				GRASP					Transfer lines	
71	✓											GA/PSO				Configuration analysis	
22	✓	✓		✓							NSGA-II					Scheduling	
34					✓						PSO					Reconfiguration	
											WGA,						
96							✓				NSGA-II					Process planning	
73	✓												Taguchi			Scalability	
74								Product similarity								Part family	
24	✓						✓				NSGA-II		AHP/AL			Configuration selection	
75	✓						✓						TOPSIS			Responsiveness	
76	✓	✓									MOPSO		MAT			RMS flow line	
77								Material handling				REM				Layout analysis	

Table 2. *Continue*

S.N	Objective functions						Solution approaches					M	Focus		
	Cost		Time		R	Other	Q	D.A	Exact	Heuristic	Multi-Heuristic			Other	Hybrid Heuristic
	PC	CC	QC	PT	CT	QT									
78		✓											K-means algorithm	Part family	
79		✓								AHP				Configuration selection	
80				✓	✓					NSGA-II				Machine unavailability	
81				✓	✓					NSGA-II				Machine unavailability	
82														Layout analysis	
15	✓	✓		✓	✓					AMOSA			TOPSIS		
83										AMOSA				Layout analysis	
84														Configuration selection	
85														Multi-part RMS	
86		✓		✓						GA				Configuration selection	
87										Bowl				Scalability analysis	
88														Production planning	
89													Genetic algorithm		
90			✓										Petri nets	Configuration selection	
91													Netting clustering	Delayed RMS	
92	✓													Part family	
93	✓	✓		✓	✓								Goal programming	Performance analysis	
94										GA				Environmental analysis	
95	✓												Markov models	Scalability analysis	
														Random failures	

Table 2. *Continue*

S.N	Objective functions						Solution approaches					M	Focus		
	Cost		Time		R	Other	Q	D.A	Exact	Heuristic	Multi-Heuristic			Other	Hybrid Heuristic
	PC	CC	QC	PT	CT	QT									
97						✓			SOMA					Scheduling	
98									PSO					Layout analysis	
99														Scheduling	
100	✓					✓			PSO					Design optimization	
101		✓			✓			e-constraint	MOSA	NSGA-II/MOSA				Energy analysis	
102	✓													Configuration selection	
103									ACO					Configuration selection	
16													System engineering, Boolean, statistics	Energy consumption	
104													Hybrid heuristic	Performance assessment	
105		✓				✓								Configuration selection	
106				✓					SA					Scheduling	
107		✓						MILP implemented in GAMS						Configuration design	
20		✓						MILP implemented in GAMS						Configuration design	
108	✓	✓							SA					Process planning	
109	✓								SA					Process planning	
110	✓											Markov models		Random failures	

Table 2. *Continue*

S.N	Objective functions						Solution approaches					M	Focus		
	Cost		Time		R	Other	Q	D.A	Exact	Heuristic	Multi-Heuristic			Other	Hybrid Heuristic
	PC	CC	QC	PT	CT	QT									
111				✓			Profit maximization			SA		DES		Production planning and resource allocation	
112							Workload balancing					Game theory			
113							Synthesis of modularity					Semi-algorithmic tool	✓	Modular analysis	
30	✓	✓		✓	✓		Greenhouse Gases (GHG)	I-MOILP		AMOSA, NSGA-II				Sustainability	
114	✓	✓		✓	✓		Machine exploitation time			NSGA-II		RSUPP, LSSUPP, ABILS		Sustainability	
115							Minimizing the number of machines			GA				Scalability analysis	
116							Quantitative indices for RMS characteristics					PROMETHEE, AHP	✓	Evaluation of RMS characteristics	
117							Layout optimization			Chaotic GA				Facility layout analysis of RMS	
118							Profit, orders					Stochastic approach		Modeling and analysis of RMS	
119							Minimizing the distance			PSO				Process planning	
120		✓												Optimizing modular products	
121		✓								MILP/LINGO				Selection of modules	
122							✓ Smoothness							Reconfiguration analysis	
This Work	✓	✓	✓	✓	✓			✓	✓	e-constraint	NSGA-II, MOPSO		NSGA-II-MOPSO	✓	Cost, Quality and Modularity

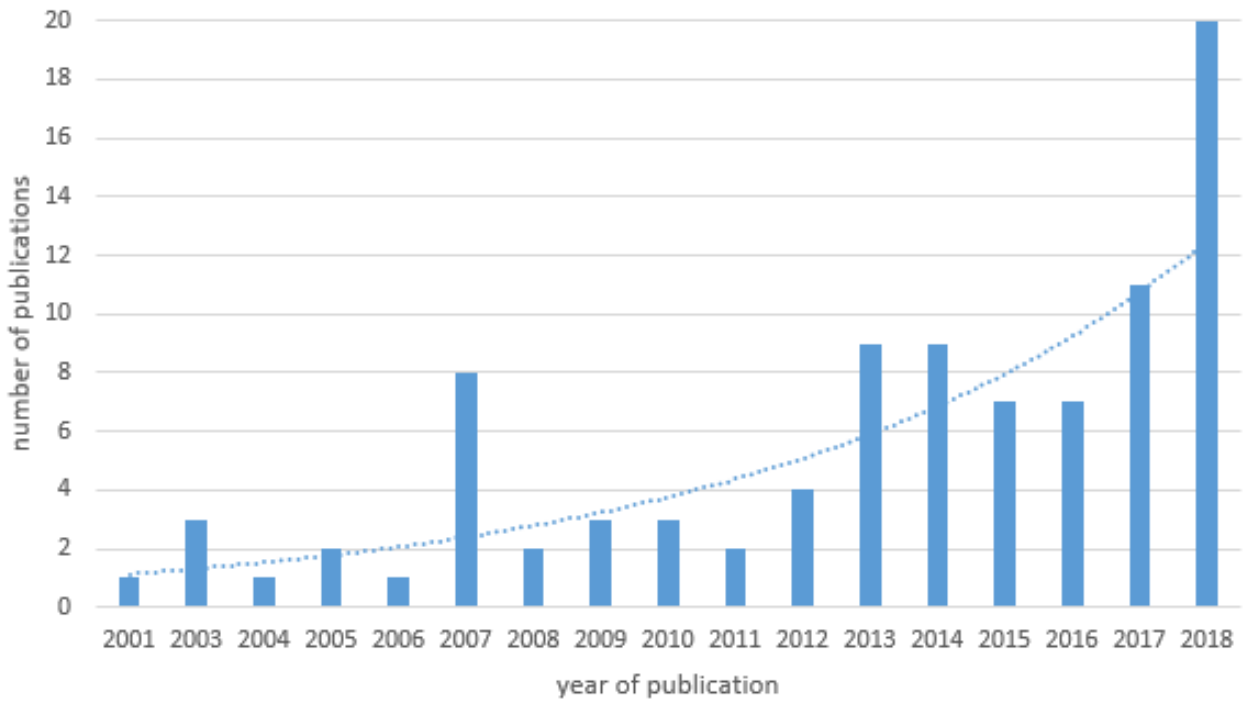

Figure 8. The trend of RMS publications over the years

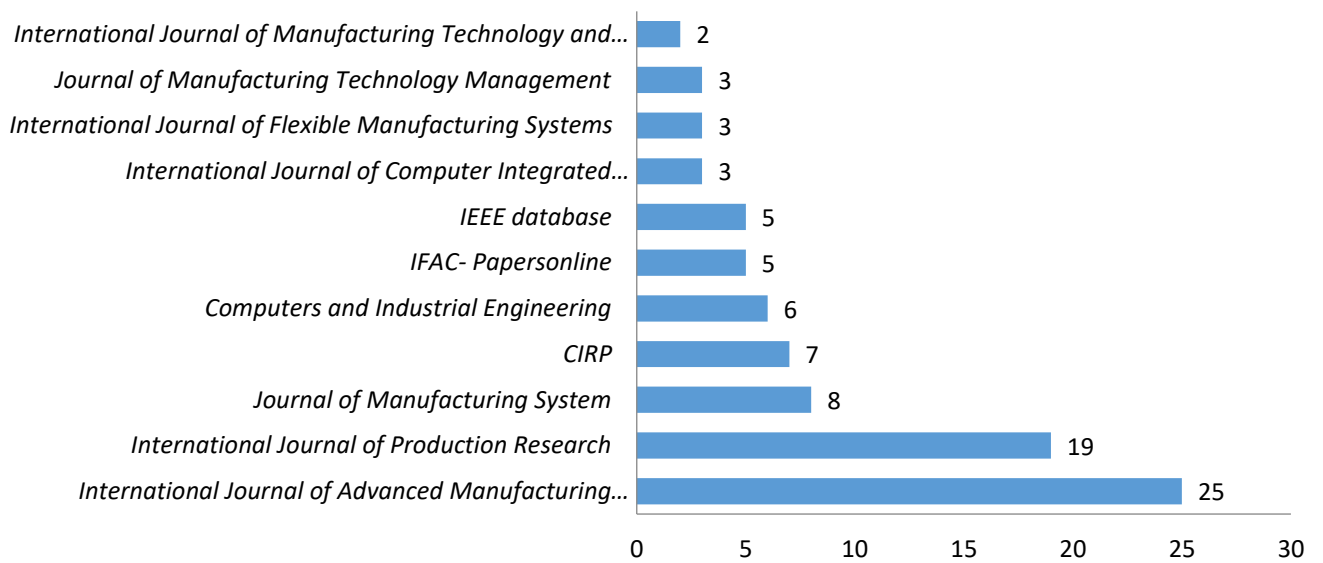

Figure 9. Distribution of RMS literature according to journals and databases



## 2.8. Research Problem

This section describes the research problem of the thesis which involves the analysis of cost, quality, and modularity. An RMS is analysed where different production stages are designed in series. Each production stage contains one machine configuration which can perform one or more operations. A perfect quality-based RMS works well and converts all input operation units into usable output. This means that the number of input units is equal to the number of output units. However, in the presence of variation and defects, the quality of operations is impacted. Thus, part of the operation units is discarded as scrap due to poor quality while remaining units are re-worked to make them conform. As shown in Figure 10, raw material units ( $\eta_{io}$ ) are initially processed on machine configuration  $i$  to perform operation  $o$ . The configuration  $i$  exhibits quality variation which results in failed units of operations. After discarding the failed units as scrap, the remaining units are reworked, and then fed to the subsequent machine configuration and so on. The failed operation units are produced between every two successive configurations, and these are removed, and the remaining are re-worked after each machine configuration. It can be observed from the curve given in Figure 10 that each configuration keeps on decreasing the number of conforming products due to different defects. At the end of the process plan, part of the products entering the RMS is conforming while the remaining is discarded as scrap. The goal is to select a process plan which warrants a higher number of conforming products along with minimum cost and minimum modular effort.

The research **aims** to select a process plan that will ensure a least total cost solution, a minimum variation in quality and failed units, and a minimum modular effort. Since these objectives are conflicting, the analysis will help to attain different non-dominated solutions and practitioners will be able to select a particular process plan according to their preferences. Some of the objectives might reinforce each other, such as, the least total cost solution might indicate minimum scrap and re-work cost which can be taken as an indication that the solution will contain less quantity of failed units and improved quality.

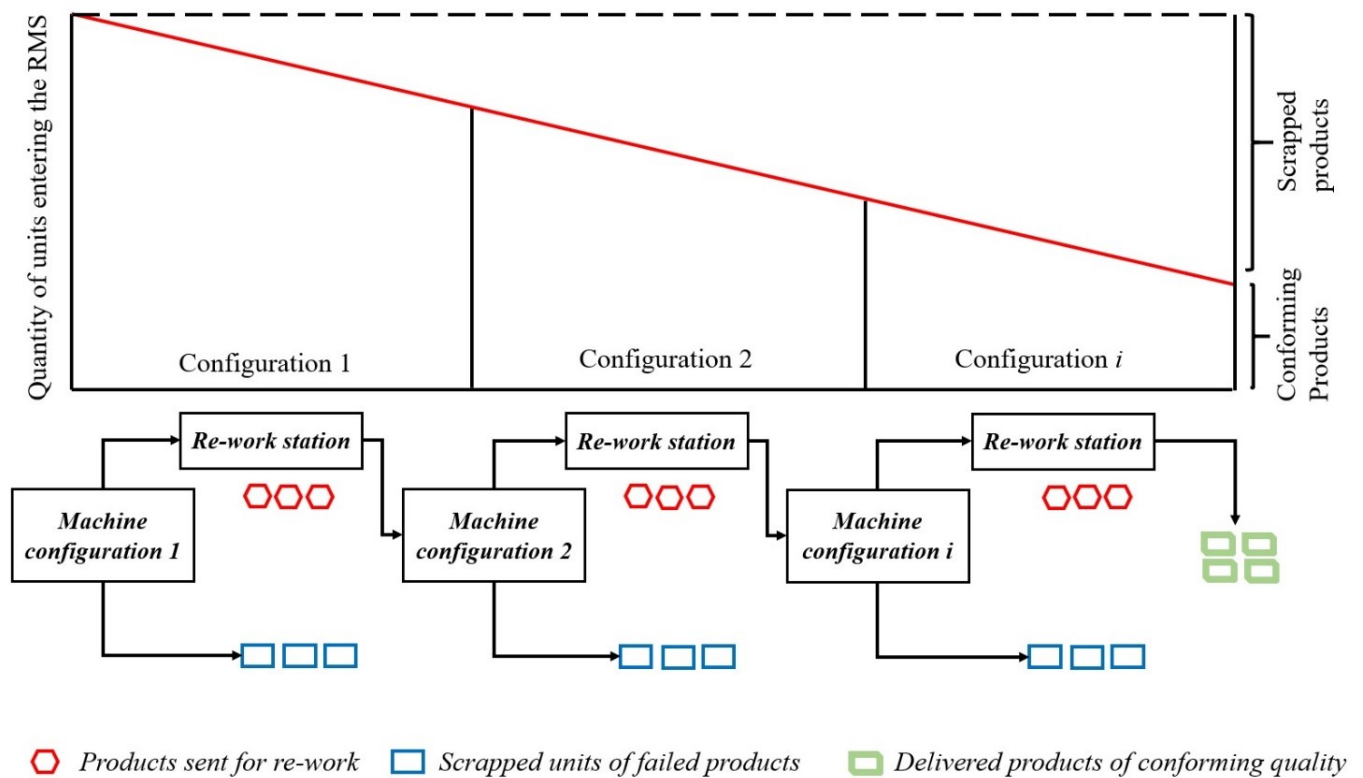

Figure 10 Process flow of the considered RMS

To conclude, this chapter examined various aspects of literature to identify the existing gaps. An in-depth analysis of the existing focus on modularity was presented. It was argued that modularity has been frequently analysed in RMS literature. However, to the best of our knowledge, it has never been examined subject to quality variation and defective performance of a reconfigurable manufacturing system. In the next sub-section, the existing focus on cost analysis was surveyed. A linkage was built between the cost-quality relationship. Like modularity, the cost has never been analysed in the presence of quality variation of a reconfigurable manufacturing system. Costs related to quality such as scrap cost, re-work cost can be modelled to examine the performance of RMS.

The next section presented the focus on quality in quality management literature, RMS, and FMS literature. A gap was identified in the literature regarding the absence of a quantitative measure of quality. A quantitative measure can help practitioners to identify the number of conforming and failed products delivered by a manufacturing system. To summarize, the

proposed model is novel, and it has never been considered and studied in the reconfigurable manufacturing system literature.

# MATHEMATICAL MODEL

*This chapter presents the mathematical model assessing the **Total Cost, the Quality Decay Index, and the Modularity Effort** in RMS process planning. Section 3.1 briefly describes the two models (Model 1 and Model 2) that are considered for analysing and comparing the effect of quality variation. This section concludes with the notations, indices, parameters, and decision variables involved in the mathematical model. Section 3.2 provides the list of assumptions and hypotheses considered in the mathematical formulations. Section 3.3 discusses the definition of the concept of quality decay index where a brief description of the key characteristics and the assignable causes is given. It highlights the advantage offered by the proposed index for practitioners in assessing the impact created by variation in quality on decisions such as conforming units, failed units, etc. Section 3.4 focuses on the cost model where different components such as production cost, machine exploitation cost, reconfiguration cost, scrap cost, and re-work cost are discussed. In addition, the difference between the two models concerning the different components of cost is discussed. Section 3.5 contains the objective function of modularity effort and its relationship with the overall quality of production is analysed.*

### 3.1. Models

The analysis is carried out by using two models. Both models are compared to understand the impact of quality on the process plan selection. Model 1 considers the variation in quality and different defects while model 2 is based on a perfectly working RMS. This can be explained with the help of Figure 11.

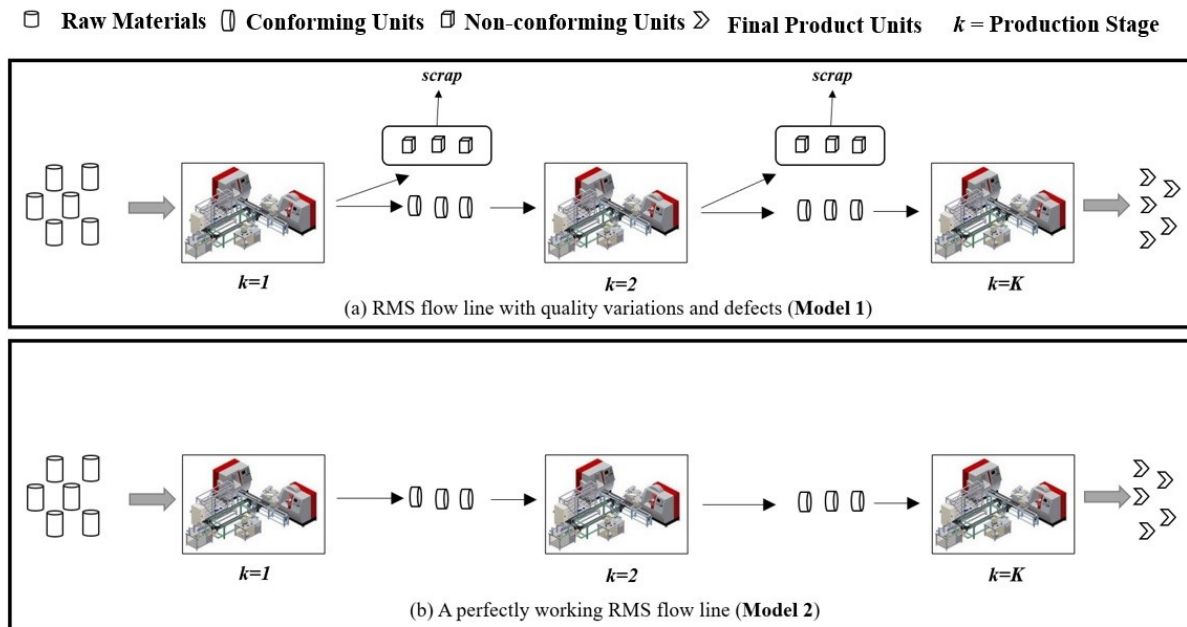

Figure 11. RMS flow line for Model 1 and Model 2

Several production stages ( $k$ ) are designed in serial where raw material enters the 1<sup>st</sup> production stage ( $k=1$ ), and the finished products are delivered through the last production stage. Figure 11 (a) describes the behaviour of Model 1 which is based on variation in quality. Due to such variation, a portion of the operation units are failed, and they are scrapped while the conforming units are fed to the subsequent production stage (also known as configuration). As there are scrapped units between two successive production stages, the delivered quantity of units always decreases after the first production stage. On the other hand, the behaviour of Model 2 is explained in Figure 11 (b) where there is no variation in quality and a perfectly working RMS is examined. Due to it, the same quantity of operation units is processed by each production stage which is equal to the number of delivered units of operations. Though it may

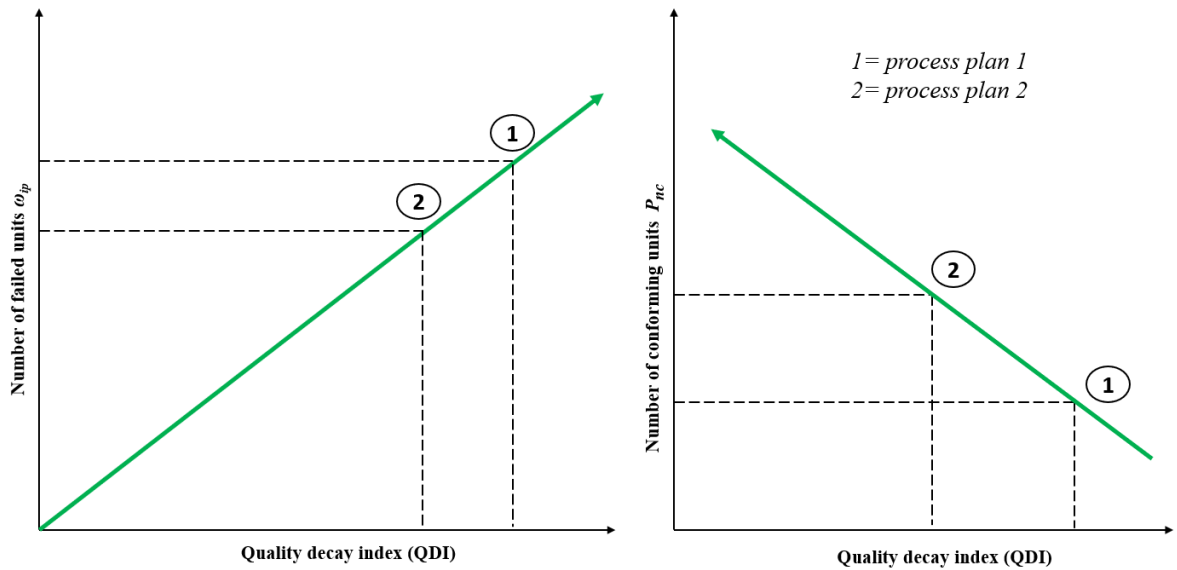

Figure 12. The relationship between the proposed index and the number of failed and conforming operations

seem simple, the variation in quality has far-reaching implications. These implications can be better understood with the help of Figure 12-14. This discussion is provided in the below subsections for Model 1 and Model 2, respectively.

### 3.1.1. Model 1

Model 1 is based on quality defects and variation, and it considers the Quality Decay Index (QDI) in its formulation. This section explains the behaviour of Model 1 by using Figure 12-14. These figures are for illustration purposes only as they are not based on mathematical formulations. Figure 12 is related to Model 1 only as it is based on variation in quality. It relates the proposed index of quality (QDI) with the number of failed and conforming units of operations. Two process plans (1 and 2) are considered, and a linear relationship is assumed between the quality of production and the number of failed units as well as between the quality of production and the number of conforming units. As can be observed, there is a direct relationship between the number of failed units and decay in quality while an in-direct relationship exists between the number of conforming units and decay in quality. In other words, a process plan with a higher number of conforming operation units will have fewer quality issues or a smaller value of the QDI index. On the contrary, a process plan with a higher number of failed operation units will mean that it has more variation in quality and a higher value of the QDI index. If these two process plans are compared, the one with the higher

number of failed units will have a lower number of conforming units. This is because the total number of operation units is equal to the sum of conforming and failed operation units. For example, process plan 1 has a higher number of failed units and it offers a lower number of conforming units. It means that it has a higher decay in quality (QDI) value compared to process plan 2. The goal is not only to select process plan 2 but also to analyse it thoroughly for ways and means to further minimize its quality decay value. Since process plan 1 exhibits more decay in quality, for a fixed capacity of the machine, it will need a higher Number of Machines (NM) to complete the required demand, as shown on the right-side plot of Figure 13.

### 3.1.2. Model 2

A hypothetical comparison between Model 1 and Model 2 is provided in Figure 13. Model 2 will require a smaller number of machines for the required demand of ‘d’ units of conforming products. (Please refer to Figure 11(b) for representation of Model 2). This is because Model 2 is in the state of “perfect quality condition” where there are no disruptions associated with the performance of machines. It means that the machine configurations in Model 2 can convert all input units into usable output units. On the other hand, Model 1 will need a higher number of machines due to variation in quality, and disruptive performance of machines and part of the product units is scrapped due to such variation. Thus, more machines will be needed to complete the production. It is to be noted that each machine configuration has a fixed capacity of production, hence the requirement of extra machines.

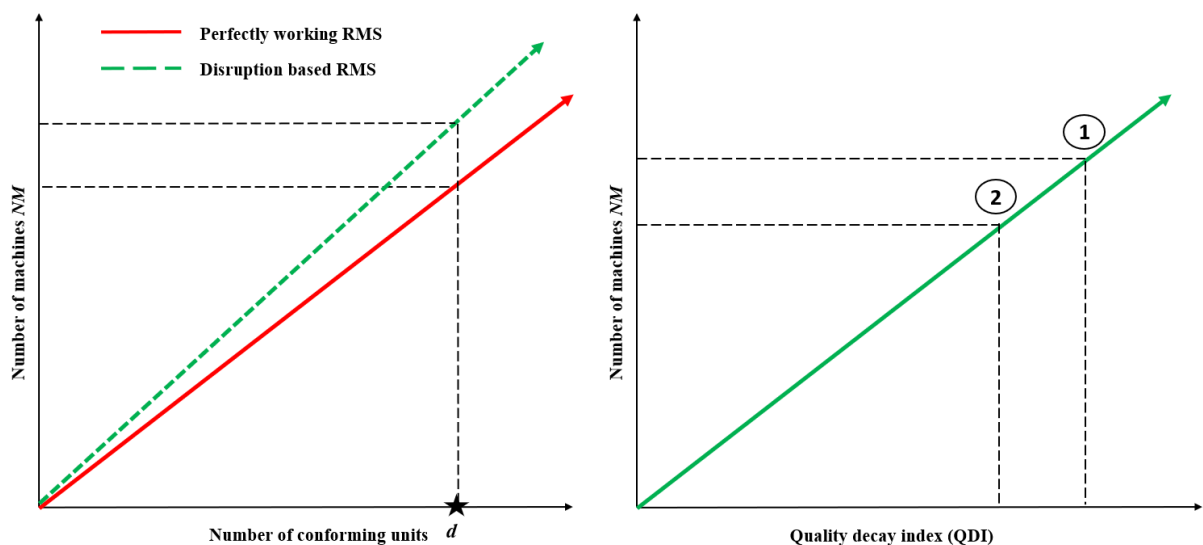

Figure 13. The relationship between i) number of machines and conforming units and ii) number of machines and the proposed index of quality

Figure 14 presents a relationship between the number of accepted units and the total operation time of the RMS flowline. Let us consider that the flowline is designed to produce 'd<sub>1</sub>' number of conforming units. Model 2 will produce d<sub>1</sub> units in t<sub>1</sub> time (point A). On the contrary, in the same period, Model 1 will only produce d<sub>2</sub> units of conforming products while d<sub>1</sub>-d<sub>2</sub> will be scrapped (point B). An extra amount of time (t<sub>2</sub>-t<sub>1</sub>) will be needed if the manager wants to produce d<sub>1</sub> units using Model 1. Thus, variation in quality and defects will either compromise the level of production or the time needed to complete the required demand. In other words, either less quantity of products will be delivered, or extra time will be taken by the production system to meet the level of demand. This, however, is a hypothetical discussion and a model is presented in the below section for scientific observations, starting with the model notations.

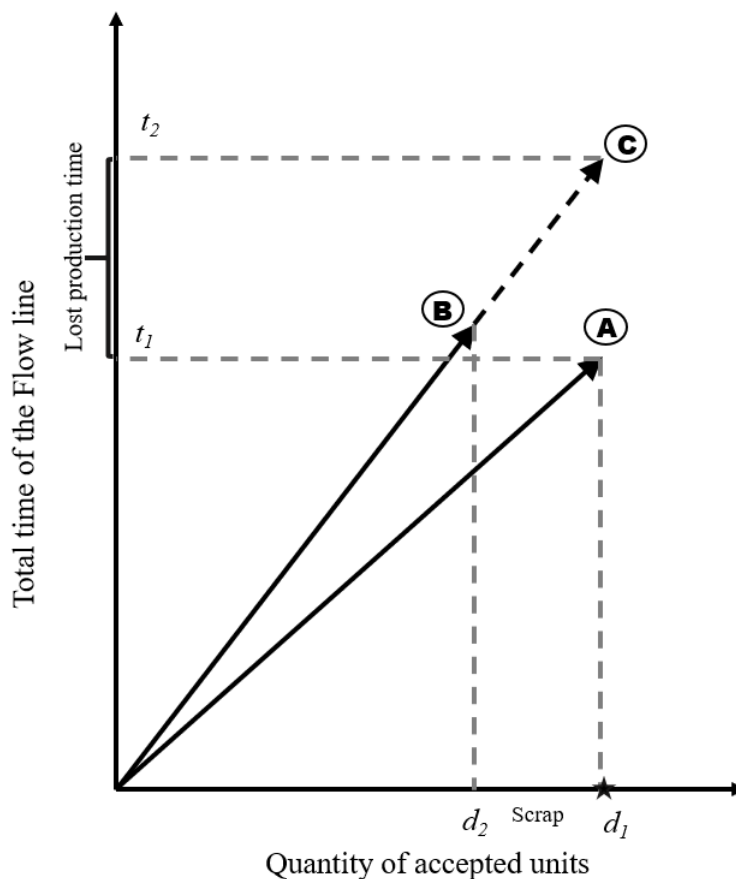

Figure 14. The relationship between production time and quantity of accepted (conforming) units.



### 3.1.3. Model Notations

The parameters, decision variables and objective functions related to the process planning problem are given below:

#### Indexes

$i, i'$	index for machine configuration; $i, i' = \{1, 2 \dots I\}$
$F$	index for product features; $f = \{1, 2 \dots F\}$
$o, o'$	index for operations; $o, o' = \{1, 2 \dots O\}$
$T$	index for tools; $t = \{1, 2 \dots T\}$
$m, m'$	index for modules; $m, m' = \{1, 2 \dots M\}$
$K$	index for quality characteristic; $k = \{1, 2 \dots K\}$

#### Parameters

$fr_{kt}$	The failure rate of quality characteristic $k$ due to tooling error
$t_{oi}$	The failure rate of operation $o$ on machine $i$ due to tolerance error
$xk_{ko}$	1, if quality characteristic $k$ belongs to operation $o$ ; else 0
$\eta_o$	quantity of operations $o$ entering the RMS
$ca_{io}$	production rate of machine $i$ for operation $o$
$ec_i$	exploitation cost of machine $i$
$\lambda_i$	The failure rate of operation due to machine disruption
$f_l$	conforming fraction of operations passed through inspection
$1 - f_l$	non-conforming fraction of operations passed through inspection
$\Psi$	probability of type I error due to inspection
$dx_{oo'}$	1, if operation $o$ and $o'$ are dependent; else 0
$pc_o$	processing cost of operation $o$
$rcp_{ii'}$	reconfiguration cost between machines $i$ and $i'$
$sc_o$	scrap cost of defective operation $o$
$rwc_o$	re-work cost of conforming operation
$rnc_o$	re-work cost of non-conforming operation
$t_f^o$	The processing time of operation $o$ of feature $f$
$ft_t$	total processing time of feature $f$

$at_o^{m,i}$	module addition time of $m$ on machine $i$ for operation $o$
$st_{o,o'}^{m,m',i}$	needed time to change from module $m$ to $m'$ on machine $i$ between ops
$rt_{o,o'}^{m,i}$	needed time to adjust module $m$ on machine $i$ from op $o$ to $o'$
TAD[ $i$ ]	matrix of tool approach directions offered by machines
TAD[ $o$ ]	matrix of tool approach directions needed by operations
$d_o$	required level of operation $o$ ( $d_1 = d_2 = d_o = d$ )

### Decision variables

$XM_{io}$	1, if operation $o$ is assigned to machine $i$ ; else 0
$\eta_{io}$	number of operation units entering machine $i$
$\omega_{io}$	number of failed operation units of $o$ on machine $i$
$\omega$	total number of failed operation units at the end of the process plan
$PN_{io}$	number of conforming units of operation $o$ on machine $i$
$PN$	total number of conforming operations at the end of the process plan
$NM$	number of machine configurations required for production
$xo_{oo'}^i$	1, if operations $o$ and $o'$ are performed on same machine $i$ ; else 0
$y_{o,o'}^{m,i}$	1, if machine $i$ requires module $m$ for operation $o$ ( $o'$ ), else 0
$cy_{o,o'}^{m,m',i}$	1, if between op $o$ and $o'$ , there is a change of module from $m$ to $m'$ , else 0

## 3.2. Assumptions and model hypotheses

The following assumptions have been considered to simplify the model.

- The production rate of different machine triplets is pre-defined, and it has a fixed value per triplet.
- The foundational base of all triplets is the same i.e., all of them have the same basic modules. They differ in terms of auxiliary modules. Thus, any two selected triplets can be interchanged by replacing and re-adjusting the auxiliary modules which require reconfiguration cost.
- The Quality decay Index (QDI) is calculated for the worst configuration (pessimistic configuration), therefore, only a simple directed acyclic graph is required.

- The failure rate due to machine disruption has the same value for all triplets (i.e.,  $\lambda=\lambda_i$ ).
- Inspection is performed after each triplet as each triplet produces failed and non-conforming units. Furthermore, the cost of the inspection is negligible.
- The rejection rate of conforming units (Type I error) has the same value throughout the process plan.
- All the defects are modelled as failure rates (function of time). The operation time has been used to analyse the total number of failed units in the entire process plan.

The following hypotheses have been considered in formulating the mathematical model.

- The total cost solution will be higher when there are more quality variation and defects. In addition, there is a trade-off between cost, quality, and modularity. A process plan based on minimum quality variations can affect the solutions of cost and modularity.
- Less modular efforts will be needed by a process plan when there are fewer or no quality variation and defects. On the other hand, more modular efforts will be needed by a process plan where there are higher quality concerns. Both models will perform differently in terms of modular needs and the number of configurations.
- In the presence of capacitated machines, a higher number of machines (NM) will be used by a process plan where there are more defects.
- The presence of quality variations will result in a different process plan as opposed to a manufacturing system that does not contain any quality variations.

### 3.3. Quality Decay Index

As discussed in the literature review section, managers are more interested in measuring the quality which can enable informing the number of conforming and the failed units of production. It was further established that such quality assessment measure is lacking in the literature related to product quality analysis. The measure of quality proposed for the analysis of RMS can be adapted for analysing the performance of other manufacturing systems.

The proposed quality index considers different assignable causes of variation by using the Manufacturing System Design Decomposition (MSDD) framework. The MSDD and

assignable causes have been discussed in Section 2.6. The considered assignable causes are related to machine, process, and tooling.

To assess the quality of production in RMS, a unique index called Quality Decay Index (QDI) is introduced in (1). It is defined as the ratio of failed operation units to the conforming operation units.

$$QDI = \frac{\omega}{PN} \quad (1)$$

As process plans are subject to variation, the production system will produce a mix of good and bad quality products. The objective of the *QDI* index is to ensure a minimum value of defects and failed products. The different values of the *QDI* index can be interpreted by managers. For instance, a value of  $QDI < 1$  means that the number of failed units is less than the number of conforming units. A value of  $QDI = 1$  means that the number of failed units is equal to the number of conforming units. Finally,  $QDI > 1$  indicates that the number of failed units is higher than the number of conforming units. The total number of failed operations produced by a process plan is calculated using (2). The total number of conforming operations is given in (3). The expressions for the number of failed and conforming operations are given in (4) and (8), respectively.

$$\omega = \sum_{o=1}^O \sum_{i=1}^I \omega_{io} \quad (2)$$

$$PN = \sum_{o=1}^O \sum_{i=1}^I PN_{io} \quad (3)$$

$$\omega_{io} = FO_i + FO_p + FO_t; \quad \forall i = \{1, 2, \dots, I\}; \forall o = \{1, 2, \dots, O\}; \lambda_i = \lambda \quad (4)$$

Equation (4) sums the failed operations respectively due to machine ( $FO_i$ ), tolerance ( $FO_p$ ), and tooling-based defects ( $FO_t$ ). Since the sources of defects are different, one of the assumptions of our model is that these defects are independent of each other. In line with this assumption, the failed operations due to these defects are separately calculated (5-7). Eq. 5 calculates the number of failed operation units due to machine disruption. Eq. 6 calculates the number of failed operation units due to tolerance error. Eq. 7 calculates the number of failed operation units due to tooling errors. Eq. 8 calculates the number of conforming operation units which is the difference in the number of operation units entering a production stage and failed operation units. It is to be noted that Eq. 8 calculates the number of conforming operation units

on a particular machine triplet. The total number of conforming operation units of the entire process plan is provided by eq. (4).

$$FO_m = XM_{io} \times \lambda_i \times \eta_{io} \times t_f^o; \quad \forall i = \{1,2, \dots I\}; \quad \forall o = \{1,2, \dots O\}; \quad \lambda_i = \lambda \quad (5)$$

$$FO_p = XM_{io} \times t_{oi} \times \eta_{io} \times t_f^o; \quad \forall i = \{1,2, \dots I\}; \quad \forall o = \{1,2, \dots O\}; \quad (6)$$

$$FO_t = XM_{io} \times fr_{kt} \times xk_{ko} \times \eta_{io} \times t_f^o; \quad \forall i = \{1,2, \dots I\}; \quad \forall o = \{1,2, \dots O\}; \quad (7)$$

$$PN_{io} = XM_{io} \times (\eta_{io} - \omega_{io}); \quad \forall i = \{1,2, \dots I\}; \quad \forall o = \{1,2, \dots O\} \quad (8)$$

### 3.4. Total Cost

To highlight the effect of defects and the quality decay on the selection of a process plan, we perform the analysis by using two models. In Model 1, the decay in quality is acknowledged and three objective functions, i.e., the Total Cost (TC), the Quality Decay Index (QDI), and the Modularity Effort (ME) are used as evaluation criteria. Model 2 does not consider any decay in quality and a perfectly working RMS is examined by using the objective functions of TC and ME.

The relationship of TC for Model 1 is given in (9). It contains the Production Cost (PC), the Total Machine exploitation Cost (TMC), the Scrap Cost (SC), the re-work cost (TR), and the Reconfiguration Cost (RC).

$$TC = PC + TMC + SC + TR + RC \quad (9)$$

The respective relationships for PC, TMC, SC, TR, and RC are provided in equations 10-14.

$$PC = \sum_{i=1}^I \sum_{o=1}^O XM_{io} \times \eta_{io} \times pc_o \quad (10)$$

$$TMC = \sum_{i=1}^I \sum_{o=1}^O XM_{io} \times ec_i \times NM \quad (11)$$

$$SC = \sum_{i=1}^I \sum_{o=1}^O sc_o \times \omega_{io} \quad (12)$$

$$\begin{aligned}
TR = & \sum_{i=1}^I \sum_{o=1}^O XM_{io} \times f_1 \times (1 - \Psi) \times rwc_o \times (\eta_{io} - \omega_{io}) \\
& + \sum_{i=1}^I \sum_{o=1}^O XM_{io} \times (1 - f_1) \times (1 + \Psi) \times rnc_o \times (\eta_{io} - \omega_{io})
\end{aligned} \tag{13}$$

$$RC = \sum_{o,o'=1}^O \sum_{i,i'=1}^I rcp_{ii'} \times (1 - xo_{oo'}^i); \quad o < o' < O; i < i' < I \tag{14}$$

The PC relationship calculates the total production cost of the process plan by considering the number of units of operation  $o$  entering the machine configuration  $i$ . TMC calculates the cost related to the number of machines in use. SC calculates the total scrap cost of the process plan. All the non-scraped operation units are inspected and reworked to bring them to an optimal quality level. Moreover, some operation units need little re-work (conforming to a higher extent) while others are of bad quality and need an extensive amount of re-work (non-conforming units). Due to this, the re-work cost (TR) expression considers the costs of re-work of conforming and non-conforming operation units. Furthermore, a portion of such operation units are relatively of improved quality, yet they are extensively reworked, due to Type-I inspection error. It means that some of the conforming operation units are allocated to the non-conforming operation units due to misjudgement. Lastly, the RC considers the involved cost if reconfiguration is required between the respective triplets.

Model 2 examines the process planning problem without any decay in quality. Thus, it considers the objective functions of TC and ME (the last term of ME is discarded as it refers to the failed operation units). In the absence of quality-related issues, the TC relationship considers only PC, TMC, and RC (15).

$$TC = PC + TMC + RC \tag{15}$$

For Model 2, the TMC and RC relationships remain the same as given in (11) and (14), respectively. For the calculation of PC, an equal number of operation units are processed by each machine configuration as there are no defects in this case.

### 3.5. Modularity Effort

Unlike the traditional manufacturing systems, RMS can perform various operations by using the same machine. This is done by reconfiguring the existing modules in RMS according to the requirements of an operation. The process of reconfiguration from the existing machine configuration to a new configuration requires modular effort (such as the time needed for changing modules). For instance, a tool/module needs to be added/removed/re-adjusted according to the operational needs of a product. We argue that this time is a non-productive part of the overall processing time and thus it should be minimized. This is because module addition/subtraction/re-adjustment time does not add value to the product and is only part of the operational needs. Since part of the operation units is discarded due to quality variation, the effort of using modules in processing such operation units is wasted. This is because the discarded products are not delivered to customers, and they do not generate any profit. Thus, though modules are used in processing such operations, they are not part of the final demand. To encapsulate such behaviour, we propose an index called **Modularity Effort (ME)** in (16). It combines the non-productive effort (proportion of time) to change (add, subtract, and re-adjust) the auxiliary modules and the proportion of effort wasted due to failed operations. A process plan with a minimum value of ME will be preferred. This minimum value can be ensured by selecting a process plan which uses less addition/subtraction/re-adjustment of modules and/or contains less lost modular effort in producing failed products. In this way, the ME value can be improved by minimizing the number of failed operations produced by a process plan. As can be seen in (16), ME is the addition of four components and all of them are valid in the case of Model 1. These components are module addition effort, module subtraction effort, module re-adjustment effort, and lost modular effort due to failed products. The relationship in (16) considers the non-productive time of modular changes concerning the operation time of a particular operation. Similarly, the non-productive time of modular efforts on failed operation units is considered concerning the operation time of the entire product feature. Since Model 2 considers a perfect RMS, it does not consider the last component of ME which is the lost effort in producing failed operation units.

$$\begin{aligned}
ME = & \sum_{f=1}^F \sum_{m=1}^M \sum_{o,o'=1}^O y_{o,o'}^{m,i} \times \frac{at_o^{m,i}}{t_f^o} + \sum_{f=1}^F \sum_{m,m'=1}^M \sum_{o,o'=1}^O cy_{o,o'}^{m,m',i} \times \frac{st_{o,o'}^{m,m',i}}{t_f^o} \\
& + \sum_{f=1}^F \sum_{m=1}^M \sum_{o,o'=1}^O y_{o,o'}^{m,i} \times \frac{rt_{o,o'}^{m,i}}{t_f^o} + \sum_{f=1}^F \sum_{i=1}^I \sum_{o=1}^O XM_{io} \times \omega_{io} \times \frac{t_f^o}{t_f}
\end{aligned} \tag{16}$$

s. t

$$\eta_{i1} = \eta_0 \tag{17}$$

$$\eta_{(i+1)o'} = \eta_{io} - \omega_{io}; \quad o < o' < O, \forall i = I \tag{18}$$

$$\eta_{io} = \eta_0 \quad \forall o = O, \forall i = I \tag{19}$$

$$NM \geq \frac{d_o}{XM_{io} \times (ca_{io} - \omega_{io})}; \quad \forall i = I, \forall o = O, \quad d_o = d \tag{20}$$

$$NM \geq \frac{d_o}{XM_{io} \times ca_{io}}; \quad \forall i = I, \forall o = O, \quad d_o = d \tag{21}$$

$$\sum_{o=1}^O xk_{ko} = 1; \quad k = \{1,2, \dots K\} \tag{22}$$

$$\sum_{i=1}^I XM_{io} = 1; \quad o = \{1,2, \dots O\} \tag{23}$$

$$dx_{oo'} \times Prec[O_o][O_{o'}] = 1; \quad o < o' < O \tag{24}$$

$$TAD[i] \times TAD[o] = 1; \quad \forall i = I, \forall o = O \tag{25}$$

$$NM \in \mathbb{Z}^+ \tag{26}$$

$$TC, PC, SC, RC, TR, TMC, QDI, \eta_{io}, \omega_{io}, \omega, PN_{io}, PN \geq 0 \tag{27}$$

$$XM_{io}, xo_{oo'}^i \in \{0,1\} \forall o, o' = O, \forall i = I \tag{28}$$

The set of constraints is provided by equations 17-28. Some of these constraints are specific to either Model 1 or Model 2 while the remaining are equally applicable to both models. Eqs. (17) and (18) are respectively dedicated to the number of units entering the first and successive triplets in Model 1. Since there are no defects in the case of Model 2, hence, same numbers of units are fed to each triplet. This is equal to the number of units entering the RMS (19). Eqs. (20) and (21) calculate the Number of Machines (NM) needed to produce the required level of



demand for Model 1 and Model 2, respectively. Its value is obtained as the ratio of demand to production rate. Eq. (22) designates a particular quality characteristic to one operation (Model 1 specific).

The remaining constraints (23-28) apply to both models. Eq. (23) ensures that a particular operation is to be performed by one triplet. Eq. (24) is to respect the precedence order. Eq. (25) requires the Tool Approach Direction (TAD) compatibility between a triplet and an operation. The number of machines can only take integer values (eq. 26). Lastly, the domain constraints of non-negativity and binary variables are provided respectively by eq. (27) and eq. (28).

The presented model is non-linear as it contains the product of an integer and continuous variables (e.g., Eq. 1, 8, 15, 21, and 22). It is converted into a linear model by using the linear approximation technique. The general form of linearization is provided in Table 3. It contains a non-linear product of variables B and C which is linearized by using an auxiliary variable A and a big number Z. As an illustration, the linearization of non-linear product  $XM_{io} \cdot \eta_{io}$  (Eq. 10) is also provided.

Table 3. Linearization of non-linear products.

General form	Eq. 10
$A = B \cdot C$	$XNT = XM_{io} \cdot \eta_{io}$
$A \leq B$	$XNT \leq XM_{io}$
$A \leq Z \cdot C$	$XNT \leq Z \cdot \eta_{io}$
$A \geq B - Z(1 - C)$	$XNT \geq XM_{io} - Z(1 - \eta_{io})$

To conclude, this chapter presented a novel mathematical model. It comprised of the objectives of the Total Cost, the Quality Decay Index, and the Modularity Effort. The total cost was defined in terms of production cost, machine exploitation cost, scrap cost, reconfiguration cost and rework cost. The objective of quality (QDI) was defined as a ratio of the number of failed and conforming products produced by a process plan. The objective of the Modularity Effort was defined as the sum of lost modular effort in reconfiguration and the lost modular effort due to failed production. A set of constraints and assumptions were provided to adapt the proposed model to favourable settings. This model will assist practitioners in understanding the trade-off between cost, quality, and modularity and the importance of integrating quality in RMS process planning.

## SOLUTION APPROACHES AND RESULTS

*This chapter discusses the solution approaches adapted for solving the multi-objective model of the **Total Cost (TC)**, the **Quality Decay Index (QDI)**, and the **Modularity Effort (ME)**. In Section 4.1, a review of the existing solution approaches in RMS literature i.e., the exact solution approaches, the meta-heuristic solution approaches, and the hybrid solution approaches is provided. Section 4.2 discusses the complexity of the proposed model and the justification to apply the non-exact (meta-heuristic and hybrid-heuristic) solution approaches. Section 4.3 describes the proposed solution approaches that comprise an e-constraint solution approach and a hybrid meta-heuristic solution approach. The hybrid meta-heuristic combines the strength of two powerful meta-heuristics i.e., Non-Dominated Sorting Genetic Algorithm (NSGA-II) and Multi-Objective Particle Swarm Optimization (MOPSO). This section further discusses the termination criteria for refining the non-dominated solutions. Section 4.4 discusses two performance metrics for assessing the efficiency of various solution approaches. Section 4.5 discusses the results and the analysis related to the model verification and validation. For the verification, the efficiency of various solution approaches is assessed by using small and large size problems. In model validation, the proposed model and solution approaches are applied to two case studies. Both case studies vary in terms of operational requirements and complexity. The results are discussed, and implications are drawn for practitioners.*

## 4.1 Review of Solution approaches

RMS problems have been analysed in the existing literature by using different solution approaches. These approaches have been adapted to solve the process planning problems [6], scalable production systems [20, 66], and part family analysis problems [78, 91]. The application of the solution approaches can be classified according to the complexity of the problems. For example, exact solution approaches could be applied to simpler and small-size problems. As the problem size increases, exact approaches are exceptionally time-consuming. For such problems, non-exact solution approaches e.g., meta-heuristics are more appropriate to provide a solution in adequate time. The non-exact solution approaches can be classified into meta-heuristic approaches, multi-heuristics approaches, and hybrid approaches. Meta-heuristic refers to a single solution approach; multi-heuristics refer to the application of more than one approach while hybrid approaches combine two or more approaches into a single framework. The following sub-sections review the application of these solution approaches to the RMS optimization problems.

### 4.1.1. Exact solution approaches

Exact solution approaches are generally adapted techniques for small problems where high computation is not required. Such approaches can yield good results in less computation time. Several exact solution approaches have been applied to solve the RMS problems involving sustainable reconfigurable manufacturing system design, configuration design and scheduling, and environmentally hazardous waste. The exact solution approaches used in such cases are  $\epsilon$ -constraint, weighted goal programming, and augmented  $\epsilon$ -constraint method [16, 29, 93]. Exact solution approaches have the drawback of not providing accurate results when the problem complexity increases. For such problems, non-exact solution approaches (meta-heuristics and artificial intelligence techniques) are preferred techniques due to their high computational power. Figure 15 provides the distribution of RMS literature according to the applications of exact/non-exact approaches. It can be observed that most studies (60%) have used non-exact approaches as compared to the exact approaches which have been used in 33% of studies. This is justified due to the complex nature of a reconfigurable manufacturing system which can be analysed adequately by using non-exact techniques.

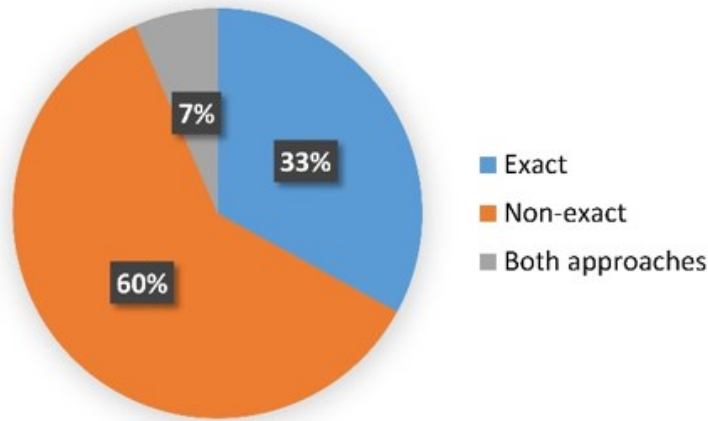

Figure 15. The distribution of application of solution approaches to RMS problems into exact and non-exact approaches

The exact approaches can be adapted to solve single as well as multi-objective-based optimization problems. An optimal solution can be readily attained for single objective-based problems (involving the objective of configuration cost, production time, etc.); however, multi-objective problems cannot be solved to attain a single global solution. In such cases, a set of solutions are attained which are non-dominated to each other. A solution may offer an optimal value against one objective and a sub-optimal value for another objective. In other words, a solution of one objective function cannot be improved without reducing the solution of another objective function [124]. These problems are called Pareto-based optimization problems and the attained solutions are called Pareto Fronts (PFs). The principles used for the selection of PFs are explained below [125].

- i. **Non domination:** A decision vector of  $x \in R^n$  is non-dominated if there is no  $x^\circ \in R^n$  such that  $f(x^\circ)_i \leq f(x)_i$  and  $\exists i \in \{1, 2, \dots, t\}, f(x^\circ)_i < f(x)_i$ .
- ii. **Pareto-Fronts (PFs):** For a multi-objective optimization problem, Pareto front  $\check{P}F$  defined by  $\check{P}F = \{x \in \omega \mid \neg \exists x^\circ \in \omega, f(x^\circ) < f(x)\}$  is a Pareto optimal solution set.

#### 4.1.2. Meta-heuristic approaches

Meta-heuristics are prominent non-exact approaches that have demonstrated their effectiveness in solving process planning problems. They belong to the evolutionary set of approaches. This sub-section provides the distribution of literature according to the applications of heuristics, multi-heuristics, and hybrid approaches. Heuristic refers to a single

evolutionary approach, multi-heuristic refers to the use of more than one approach and hybrid heuristic means that two (or more) heuristics are combined in a single framework.

Figure 16 shows the application frequency of heuristics, hybrid heuristics, and multi-heuristics. Most studies (73% studies) have used single heuristics for solving the process planning problems followed by multi-heuristics which have been used in 20% of studies. A trend can be observed in the application of heuristics, such as, studies that have used a single heuristic are more focused on the in-depth analysis of various aspects of process planning. On the other hand, multi-heuristics and hybrid heuristics-based studies have provided a thorough comparison between different heuristics. More recently, Khezri et al. [31] studied a sustainable process plan generation problem by using exact and evolutionary solution approaches. The evolutionary approaches of Non-Dominated Sorting Genetic Algorithm (NSGA-II) and Strength Pareto Evolutionary Algorithm (SPEA-II) were compared and tested against a set of problems by using the performance metrics of spacing, mean ideal distance, and diversity. Interestingly, few studies (7%) have used hybrid heuristics for addressing the process planning problems. Since hybrid heuristics combine two or more heuristics into a single framework, the goal is to take advantage of the positive aspects of each heuristic. Single heuristics have certain shortcomings, such as NSGA-II may offer solutions based on pre-mature convergence and MOPSO can trap in a local optimum solution [126]. Thus, a hybrid heuristic can help the heuristics to reinforce each other and help in avoiding their shortcomings.

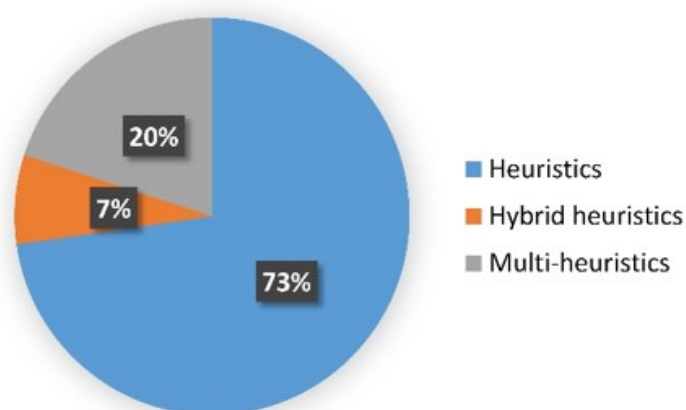

Figure 16. The distribution of application of meta-heuristics to RMS problems into single heuristics, hybrid heuristics, and multi-heuristic approaches

The application frequency of various solution approaches to RMS problems (cost, time, modularity, responsiveness, etc.) is provided in Figure 17. There are fewer applications of exact solution approaches ( $\epsilon$ -constraint, AUGECON, WGO) to the RMS problems. It can be observed that among the non-exact solution approaches, the Non-Dominated Sorting Genetic Algorithm (NSGA-II) and Genetic Algorithm (GA) have the highest number of applications to the RMS problems. There are three possible reasons for the high number of applications of genetic algorithms. Firstly, it uses an elitism selection approach, crowded comparison operator, and solution ranking which enhances its effectiveness [23]. Secondly, the genetic algorithm belongs to the relatively older family of meta-heuristics, and its repetitive applications to RMS problems are based on its history of applications to relevant problems [127]. It means that recent publications have adopted such an approach because there is a pattern of its use in RMS-related articles published in the past. Thirdly, it has proved to be a better solution approach when compared to other approaches. Khan et al. [128] analysed an RMS problem using the solution approaches of Non-Dominated Sorting Genetic Algorithm (NSGA-II) and Multi-Objective Particle Swarm Optimization (MOPSO). The performance of both approaches was assessed by using the metrics of computational time and the number of Pareto solutions. The results indicated that NSGA-II was more efficient approach, especially for large-scale problems. In another study [134], the authors analysed the quality variation-based RMS problem by using a hybrid version of NSGA-II and MOPSO. Compared to genetic algorithms, there are other solution approaches that are efficient and their applications to RMS problems can be increased. For instance, Simulated Annealing (SA) has relatively fewer applications to the relevant problems. SA is a probabilistic approach, and it is computationally efficient, can deal with large size problems, can avoid the trap of local optima, and is easier to implement. There are other recent genetic algorithm-based approaches in the form of Non-Dominated Ranked Genetic Algorithm (NRGA) and NSGA-II; however, the selection of NSGA-II is based on its extensive use in the published RMS studies and the advantages that have been listed earlier.

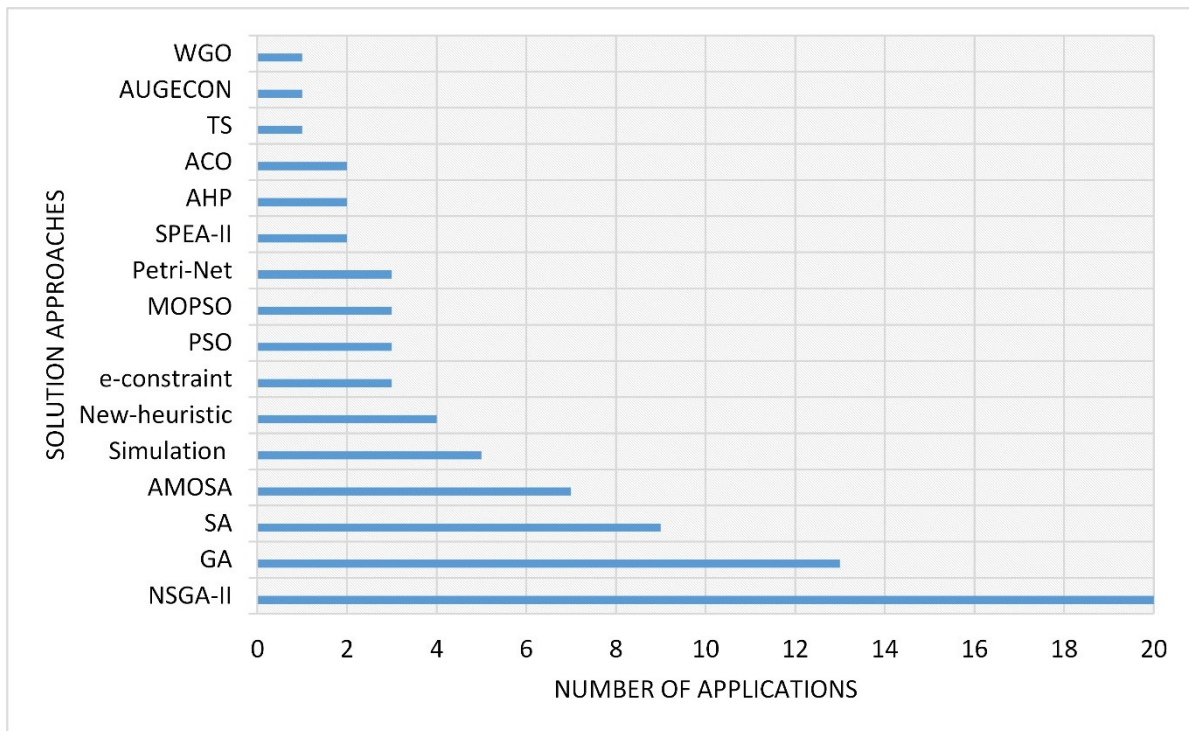

Figure 17. The frequency of different solution approaches to RMS problems.

A recent trend is being observed in the RMS literature where a new heuristic is used that is conducive to the considered problem. The applications of new heuristics can be found in [15, 16, 60, 61, 80, 81, 83]. To some extent, the RMS literature contains the simultaneous use of both exact and non-exact approaches. From Figure 15, 7% of studies have used both approaches simultaneously. Such analysis is advantageous in comparing different approaches to small and large-sized problems. It is important to note that exact solution approaches cannot be directly applied to the non-linear (MINLP) models. In such cases, either such models are first linearized, or their convexity is proved.

As established earlier in the literature summary (Table 2), there is a dearth of application of hybrid heuristics to solve the process planning problems. Since RMS problems are non-polynomial hard, it is opportune to solve such complex problems by using powerful hybrid meta-heuristics. The hybrid meta-heuristic approach combines two (or more) heuristics into a single framework, thereby reinforcing the positive aspects of each heuristic. To this end, this research uses an exact solution approach, two meta-heuristic approaches, and a hybrid meta-heuristic solution approach for solving the considered problem. The presented MINLP model has already been linearized for the application of an exact solution approach.

## 4.2. Complexity of the model

The RMS process planning is a complex problem, and it belongs to the non-Polynomial hard (NP-hard) set of problems. The complexity of RMS is due to the combination of machines, configurations, tools, modules, and Tool Approach Directions (TADs) to operate a feature. The resulting graph is an acyclic graph which can be seen in the case study diagram (Figure. 28). Further, the problem can be converted into a Traveling Salesman Problem (TSP) if the complexity of machines, configurations, and tools to operate is removed. Thus, exact solution approaches are not ideal techniques to solve such problems, especially when the problem is large. To understand the behaviour of different solution approaches, this study considers the application of  $\varepsilon$ -constraint as an exact technique, Non- Dominated Sorting Genetic Algorithm (NSGA-II), Multi-Objective Particle Swarm Optimization (MOPSO), and hybrid NSGA-II-MOPSO as evolutionary techniques. Furthermore, the performances of different approaches are assessed by using two metrics and two termination criteria.

## 4.3. Proposed solution approaches.

This section discusses the exact and hybrid meta-heuristic approaches to solve the RMS problem involving cost, quality, and modularity. The four phases of implementing the hybrid meta-heuristic and the termination criteria are discussed in detail.

### 4.3.1. The $\varepsilon$ -constraint solution approach

This approach converts a multi-objective model into a single/mono-objective model by considering all objectives (except one) as constraints. This approach was applied to Model 1. The objective of TC is given an utmost priority, as it constitutes an integral part of the process planning decision. The remaining objectives of QDI and ME are converted into  $\varepsilon$ -constraints. The additional set of equations and constraints are given as:

$$\min TC \tag{30}$$

$$QDI \leq \varepsilon_1 \tag{31}$$

$$(QDI)^{min} \leq \varepsilon_1 \leq (QDI)^{max} \tag{32}$$

$$ME \leq \varepsilon_2 \tag{33}$$

$$(ME)^{min} \leq \varepsilon_2 \leq (ME)^{max} \tag{34}$$



The pseudocode of adapted  $\varepsilon$ -constraint is given in Algo. 1.  $\Delta QDI$  is the difference of quality decay index values between the current and previous steps. Similarly,  $\Delta ME$  is based on the difference of modularity effort values between steps of an  $\varepsilon$ -constraint method. A distinct number of solutions are generated until the threshold defined by  $\varepsilon$ -constraints is reached.

---

Algo. 1 Pseudocode of adapted  $\varepsilon$ -constraint

---

```

1: Input: data
2: Implement Model 1 in CPLEX for upper and lower bounds of QDI and ME.
3: Use (32) and (34) to adjust  $\varepsilon_1$  and  $\varepsilon_2$  between respective upper and lower bounds.
4: While  $\varepsilon_1 < QDI$  and  $\varepsilon_2 < ME$  do
5:     Use GA to obtain non-dominated solutions of mono-objective TC.
6:     Archive the non-dominated solutions.
7:     Set  $\varepsilon_1 = \varepsilon_1^\circ - \Delta QDI$  and  $\varepsilon_2 = \varepsilon_2^\circ - \Delta ME$  (where  $\varepsilon_1^\circ > \varepsilon_1$  and  $\varepsilon_2^\circ > \varepsilon_2$ ).
8: End While
9: Display the non-dominated solutions.
10: Stop

```

---

#### 4.3.2. Hybrid NSGA-II-MOPSO

This sub-section introduces the hybrid meta-heuristic which combines the strengths of two power full meta-heuristics i.e., Multi-Objective Particle Swarm Optimization (MOPSO) and Non- Dominated Sorting Genetic Algorithm (NSGA-II). These approaches have been separately applied to different RMS problems such as process planning, scalability analysis, etc. For additional information, the application of MOPSO and NSGA-II can be consulted in [50, 76] and [27, 69], respectively. Since each algorithm offers certain advantages in computation, the aim is to reinforce the positive aspects of each approach by combining them. For this purpose, the hybrid approach works in a way that NSGA-II is used for exploration while MOPSO performs the task of exploitation.

The Particle Swarm Optimization (PSO) was proposed by Eberhart and Kennedy [129] as a single objective-based optimization algorithm. PSO is inspired by the behaviour of birds flocking and fish schooling. A bird is represented by a particle for a single solution and the set of birds is represented by a swarm. During the flight, each particle can be defined in terms of its position ( $x_{ij}^t$ ) and velocity ( $v_{ij}^t$ ) which are updated in each iteration of the algorithm. Coello et al. [130] formally introduced MOPSO by incorporating the Pareto dominance and a novel mutation operator. An important aspect of MOPSO implementation is the selection of the global best position. In this regard, the same roulette wheel mechanism has been used in the current study as in [76, 130]. It selects the global best position ( $g_{best}$ ) based on Crowding

Distance (CD). CD computes the closeness of a particular solution to other solutions, and it is based on an average value of the distance from two neighbouring solutions. In other words, CD offers the density of solutions around a particular solution.

The Non- Dominated Sorting Genetic Algorithm (NSGA-II) is a non-domination-based technique that is used for multi-objective analysis. It was proposed by Deb [131] and it represents an evolutionary class of algorithms. The advantages offered by NSGA-II are the improved sorting, the no-apriori requirement of sharing parameter, and the inclusion of an elitism approach. It is based on five operators: initializing, sorting, crossover, mutation, and elitist comparison.

Both algorithms use different search mechanisms. For instance, the genetic algorithm uses elitism and crowding distance sorting to ensure diversity of solutions. On the other hand, MOPSO uses a global best particle to guide the movement of corresponding particles. These particles update their speeds and velocities for searching the solution space. MOPSO has the drawback of getting trapped in local optima. To avoid the local optima, hybrid NSGA-II-MOPSO divides the search space into exploration and exploitation zones. The exploration task is performed by NSGA-II by considering half of the population. This half is improved by the algorithm by using the ranking of non-dominated solutions. The remaining half of the population is used by MOPSO for exploitation. It searches for improved solutions in the neighbour by guiding the lower-ranked solutions towards the global optimal solutions. The flowchart of the hybrid algorithm is provided in Figure 18. The overall procedure of hybrid NSGA-II-MOPSO can be divided into 4 phases, as discussed below.

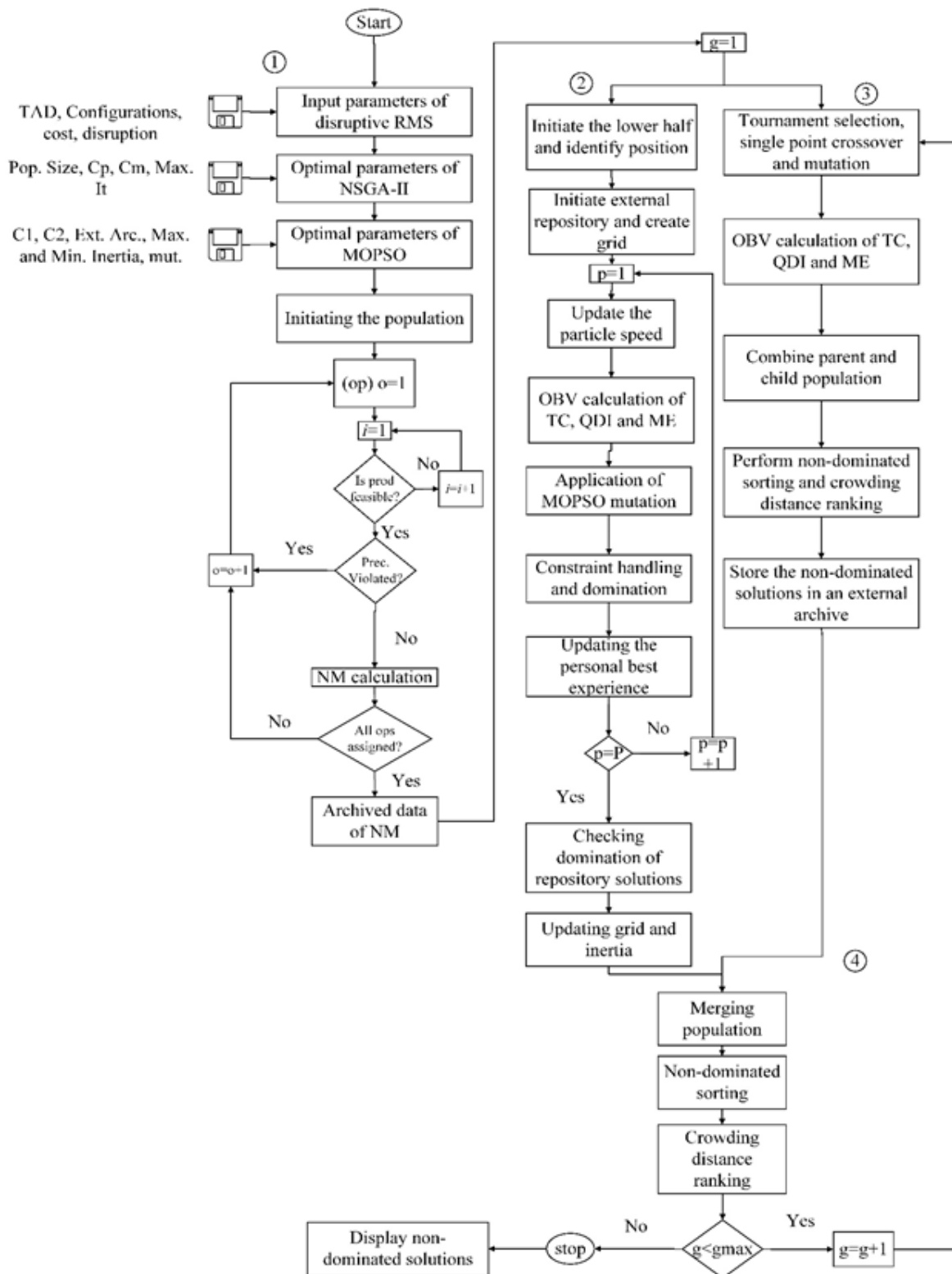

Figure 18. Flowchart of 4-phases of hybrid NSGA-II-MOPSO

### *Phase 1 of hybrid meta-heuristic*

It concerns the input information of RMS and meta-heuristics. This phase evaluates the Number of Machines (NM) of each configuration which is later used by phases 2 and 3. The associated pseudocode is given in Algo. 2. An operation is randomly selected, and all feasible configurations are identified by using the machine-operation matrix. The concerned failed operations and configuration capacities are used to calculate the NM values by using eq. 20 and 21 and all values are archived. These values are used in phases 2 and 3 during the calculation of Objective Function Values (OBV). During this process, respective configurations and their NM are selected to ensure optimal OBV values.

---

#### Algo. 2 Phase 1: Procedure for NM calculation

---

```
1: Initialize the number of operations ( $o$ )
2: For ( $op$ )  $o \in O$  do
3:   employ the machine operation matrix to identify the feasible machine configurations
4:   while  $i \leq I$ 
5:     If (Prod. Feas.) $_{io}=0$ , (Prec.) $_{o, o'}=0$  then
6:        $i=i+1$ 
7:     End If
8:     randomly select ( $op$ )  $o$  based on precedence
9:     input the disruption information of machine  $i$  for ( $op$ )  $o$ 
10:    identify the number of failed units ( $\omega_{io}$ )
11:    evaluation of the number of machine configurations (eq. 20, 21)
12:     $i=i+1$ 
13:  End while
14:  archive the number of machine configurations
15: End For
```

---

### *Phase 2 and Phase 3 of hybrid meta-heuristic*

The application of phases 2 and 3 is performed by using MOPSO and NSGA-II, respectively. NSGA-II serves the purpose of exploration while MOPSO performs the task of exploitation. NSGA-II selects the upper half of the population to create offspring. It uses a single-point crossover and a mutation operator to result in a fresh pair of child chromosomes. Encoding is an important aspect of the application of operators. The encoding matrix of five rows and  $n$  columns (machine, modules, features, operations, and quality characteristic) is used, and an example is provided in Table 4. For instance, machine configuration 1 uses two auxiliary modules ( $A_{11}$  and  $A_{15}$ ) to perform operation 1 ( $O_1$ ) of feature ( $F_1$ ) which has the quality characteristic ( $k_3$ ), and so on. To avoid non-feasible solutions causing the penalty, only continuous values between  $[0,1]$  are assigned to each cell. The encoding and decoding schemes

are described in the Appendix. Following this, the objective functions of TC, QDI, and ME are computed by using the archived information of the Number of Machines (NM). In the next step, the parent and child populations are combined to perform non-dominated sorting and crowding distance based on the non-domination of solutions. The solutions are sorted in an ascending order. Lastly, the non-dominated solutions are stored in external archive. The remaining half of the population is used by MOPSO for exploitation. It acquires the non-dominated solutions which are stored in the repository. The detailed procedure is provided in Algo. 3.

Table 4. Example of matrix used for encoding scheme.

Machine	M <sub>1</sub>	M <sub>3</sub>	M <sub>2</sub>	M <sub>1</sub>	M <sub>3</sub>	M <sub>3</sub>	M <sub>2</sub>	M <sub>1</sub>	M <sub>1</sub>
Module	A <sub>11</sub> , A <sub>15</sub>	A <sub>31</sub>	A <sub>43</sub>	A <sub>16</sub> , A <sub>12</sub>	A <sub>32</sub>	A <sub>34</sub>	A <sub>21</sub>	A <sub>13</sub>	A <sub>13</sub> , A <sub>16</sub>
Feature	F <sub>1</sub>	F <sub>1</sub>	F <sub>2</sub>	F <sub>3</sub>	F <sub>2</sub>	F <sub>1</sub>	F <sub>1</sub>	F <sub>3</sub>	F <sub>2</sub>
Operation	O <sub>1</sub>	O <sub>2</sub>	O <sub>9</sub>	O <sub>14</sub>	O <sub>10</sub>	O <sub>4</sub>	O <sub>3</sub>	O <sub>16</sub>	O <sub>12</sub>
Quality characteristic	k <sub>3</sub>	k <sub>2</sub>	k <sub>5</sub>	k <sub>1</sub>	k <sub>6</sub>	k <sub>4</sub>	k <sub>8</sub>	k <sub>7</sub>	k <sub>9</sub>

---

Algo. 3 Phase 2: Pseudocode of MOPSO

---

- 1: *select the remaining half of the population*
  - 2: *store  $p_{best}$  values*
  - 3: *initiate ext. repository and create the grid*
  - 4: **While**  $g < g_{max}$  **do**
  - 5:     **For**  $p=1-P$  **do**
  - 6:         *select global best from rep. and update speed*
  - 7:         *evaluate the fitness of OBV values*
  - 8:         *use MOPSO mutation and perform domination*
  - 9:         *store  $p_{best}$*
  - 10:     **End For**
  - 11:     *add non-dominated solutions to rep.*
  - 12:     *discard the dominated solutions*
  - 13:     *update grid and change inertia*
  - 14:      $g=g+1$
  - 15: **End While**
- 

#### *Phase 4 of hybrid meta-heuristic*

This phase combines the results of NSGA-II and MOPSO obtained from phases 2 and 3. It takes the population of both algorithms and combines them to be stored in the archive of NSGA-II. The ranking of stored solutions takes place based on the non-domination of solutions. Only a predefined number of non-dominated solutions are stored, and the remaining are discarded. The loop continuous until the optimal solutions are found, or the stopping criteria

are met. Two stopping criteria are discussed in section 5.4. The pseudocode for merging the population of both meta-heuristics is given in Algo. 4.

The input parameters of the hybrid algorithm were fine-tuned by using a set of experiments. Each experiment was defined by configurations\_operations (such as 3\_5 means 3 configurations and 5 operations). A partially mapped crossover and random mutation was used in the execution of NSGA-II. These genetic parameters are described in the Appendix. The optimal parameters were based on the following values: population size= 150, maximum iterations= 500, crossover probability= 0.6, mutation probability= 0.3,  $c_1=c_2=2$ , size of external archive in MOPSO= 150, maximum inertia= 0.7 and minimum inertia=0.3.

---

Algo. 4 Phase 4: Merging the population

---

```

1: For  $g=1$  to  $g_{\max}$ , do
2:   create a set of particles half the pop. ( $npop/2$ )
3:   add non-dominated solutions to the repository
4:   add. pop. NSGA-II with particles of MOPSO
5:   conduct non-dominated sorting
6:   crowding distance calculation
7:   population ranking based on non-domination
8:   divide the population into two groups
9:    $g=g+1$ 
10: End For
11: display the non-dominated solutions

```

---

#### 4.3.5. Stopping criteria

A meta-heuristic keeps on refining the solutions up until the threshold criteria are met. The stopping criteria can be defined based on a limit on the computation time or based on the number of generations/iterations. On the other hand, this research uses two termination criteria based on First Improvement (FI) and Best Improvement (BI). FI returns the solutions when the first improvement in the results is found whereas BI returns the solutions when the best improvement in results is found. The performance of solution approaches is assessed by using each stopping criteria.

#### 4.4. Performance metrics

The results of the  $\epsilon$  – *constraint* method and hybrid algorithm were compared to the results of NSGA-II and MOPSO. This comparison was carried out on small and large problem sizes by using two performance metrics i.e., Inverted Generational Distance (IGD) and Hyper

Volume (HV). Although there are several performance metrics available in the literature, the IGD and HV values provide an opinion on the conflicting/trade-off nature of the pareto-optimal solutions. The IGD calculates the average distance of non-dominated solutions from a true Pareto Front (PF), and it represents the convergence of solutions. The HV calculates the covered space and a maximum value of HV refers to higher diversity of solutions. These metrics are further discussed below.

- i. The IGD works on improving the quality and uniformity of Approximate Pareto solutions (AP). It considers the distance between a Real Pareto Solution (RS) and an Approximate Pareto solution (AP). The equation of IGD is given in (35) where  $d(RS(a), AP)$  = Euclidean distance between RS and AP.

$$IGD(AP, RS) = \sum_{a \in F} d(RS(a), AP) / |RS| \quad (35)$$

- ii. The Hyper Volume (HV) calculates the covered space size between AP and a reference point  $r$ . The equation to calculate HV is provided in (36) where  $r^* = (r_1^*, r_2^* \dots r_s^*)$  is the set of reference points values,  $s$  = number of objective functions and  $V$  = Lebesgue measure.

$$HV(AP) = V(U_{a \in AP} [f_1(a), r_1^*] \times [f_2(a), r_2^*] \times \dots \times [f_s(a), r_s^*]) \quad (36)$$

A solution with minimum IGD and maximum HV values will ensure an excellent convergence and higher diversity of solutions.

## 4.5. Results and analysis

### 4.5.1. Model verification

Model 1 was used for comparing the efficiency of different solution approaches. The solution approaches were performed by MATLAB 2016a on a 2.6 GHZ Core i5 system and 8 GB RAM. The results were obtained for small and large-sized problems by using FI and BI stopping criteria. The problem size was defined by  $i_o$  (where  $i$ =machine configuration and  $o$ =operation). The respective results are provided in Figures 19-22. It can be observed that the  $\varepsilon$ -constraint offers better results for small size problems; however, its solutions are less in number compared to other approaches. As the problem size gets bigger,  $\varepsilon$ -constraint does not provide feasible results (Figures 21 and 22). Hybrid NSGA-II-MOPSO performs well

compared to NSGA-II and MOPSO and it has the highest number of non-dominated solutions. In other words, the solutions offered by the hybrid heuristic are part of the non-dominated solutions. Moreover, as TC, QDI, and ME objectives are to be minimized, a solution closer to the origin (intersection of TC, QDI, and ME) will be preferred. From Figures 19-22, among the meta-heuristics, the solutions offered by the hybrid approach are closer to the origin. Similarly, the solutions of the hybrid approach are uniformly distributed as compared to other approaches. The reason behind this improved performance of hybrid NSGA-II-MOPSO is due to the division of population between NAGA-II and MOPSO, and the merger of storage capacities i.e., the external archive of NSGA-II with the repository of MOPSO. Once the population is divided between NSGA-II and MOPSO, it becomes easier to refine the solutions to obtain a higher number of Pareto (non-dominated) solutions. In addition, the merger of the external archive of NSGA-II with the repository of MOPSO helps in avoiding a premature convergence.

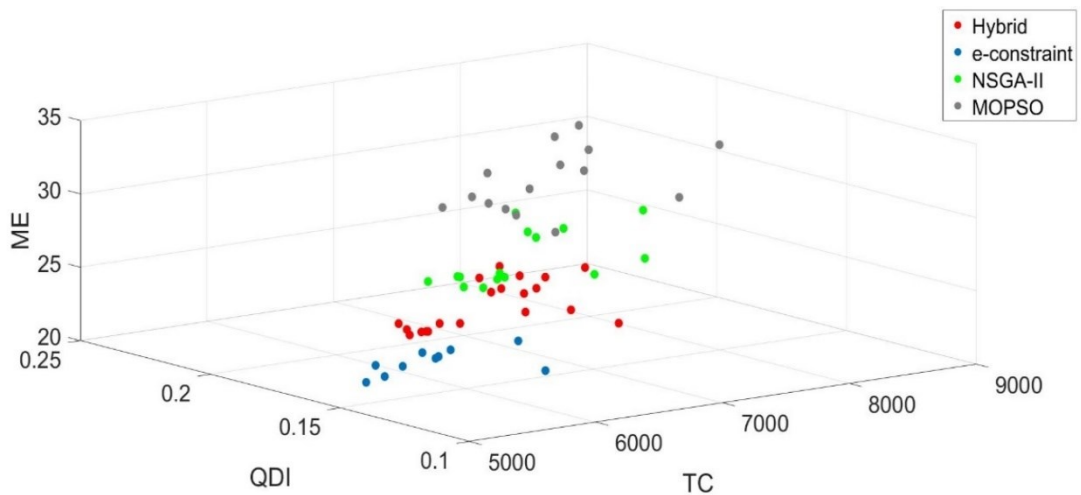

Figure 19. Non-dominated solutions of small-sized problems using FI (Model 1)



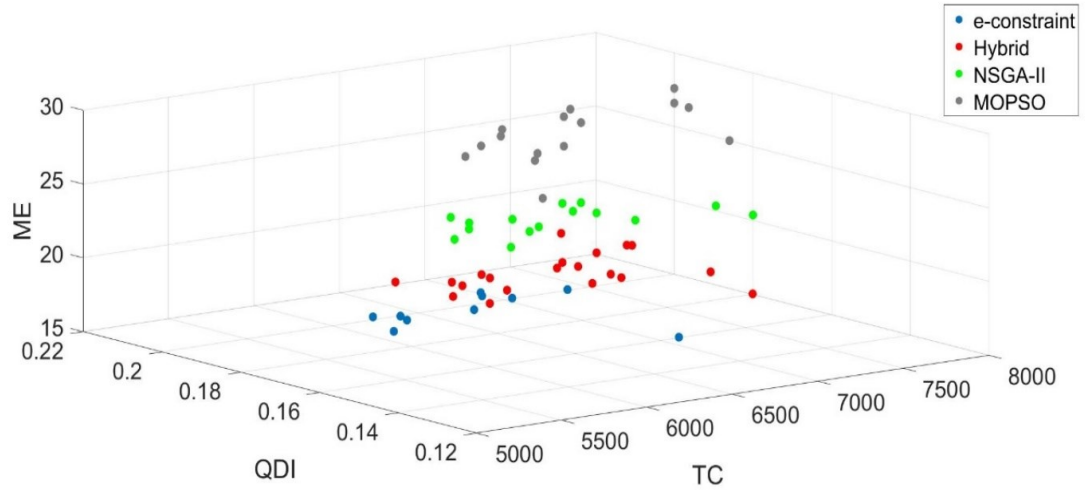

Figure 20. Non-dominated solutions of small-sized problems using BI (Model 1)

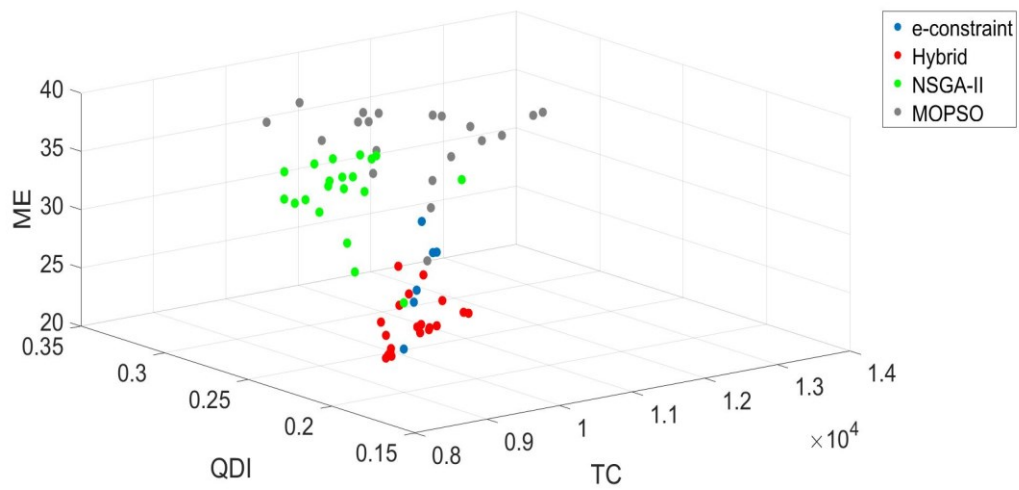

Figure 21. Non-dominated solutions of large-sized problems using FI (Model 1)

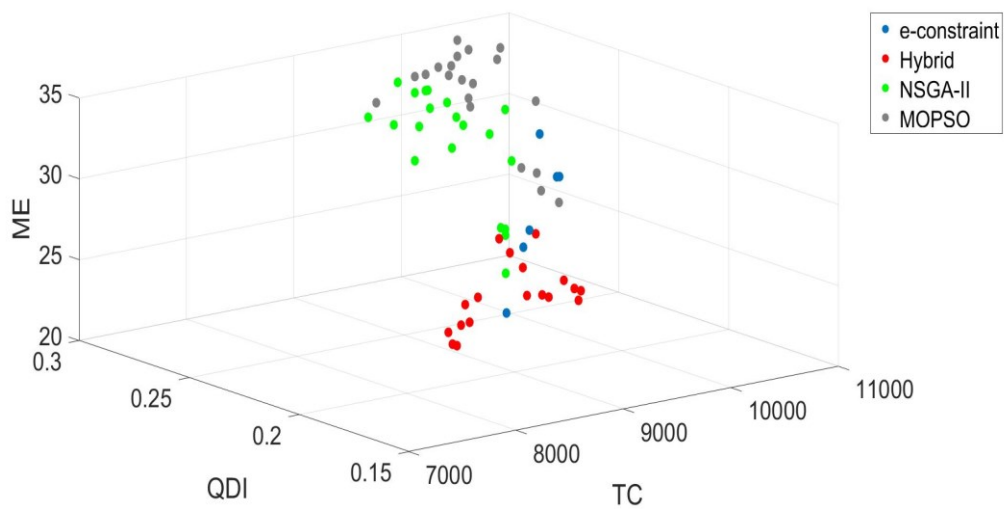

Figure 22. Non-dominated solutions of large-sized problems using BI (Model 1)

Though the  $\varepsilon$  – constraint offers feasible solutions for some problems, it is not viable as it takes a higher computation time. As an illustration, Figure 23 provides the computation time (CPU) of solution approaches against the different size of problems. It can be observed that as the problem size increases, the CPU of  $\varepsilon$  –constraint increases non-linearly. On the other hand, HYB (FI) (hybrid with the first improvement) performs better, and it takes less time in returning the results. Further, the FI of a particular approach works well compared to BI in terms of computation. It is because BI is a more exhaustive stopping criterion that aims to identify the best solution and hence takes more time in offering Pareto optimal solutions.

From Figures 19-22, MOPSO performs non-satisfactory compared to other solution approaches. The reasons behind its non-satisfactory performance are twofold. Firstly, the repository of MOPSO is pre-defined with a fixed limit. If the number of solutions exceeds the limit, the repository discards some of the existing solutions which can affect the quality of returned solutions. Secondly, its non-satisfactory performance can be due to an inappropriate selection of mutation operators. Particle swarm optimization uses mutation to perform exploitation on a portion of the population. The selection of mutation operator is pertinent as it can impact the population and convergence of solutions. As an illustration, different mutation values were selected to understand their impact on the solutions. Figure 24 provides the respective results of percentage convergence of different problem sizes against three mutation values. It can be observed that mutation impacts the convergence of solutions; however, an improved convergence can be ensured by selecting a higher rate of mutation. Further, the mutation affects the population up to a certain number of iterations. As shown, mutation rates of 0.4, 0.5, and 0.6 affect the population up until 45, 80, and 140 iterations, respectively, and stability in solutions is attained afterward. Thus, a higher rate of mutation is advantageous in obtaining higher convergence and a lower rate of mutation is beneficial for minimum impact on the population.

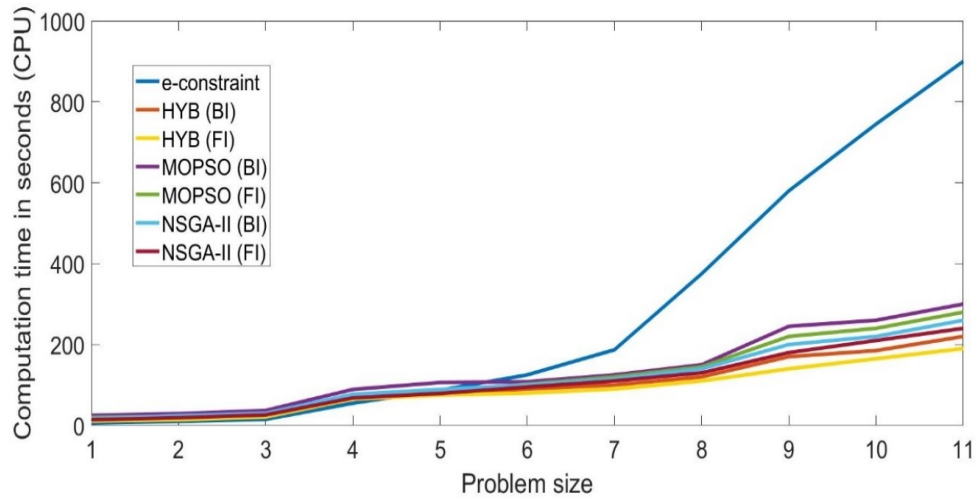

Figure 23. CPU time of solution approaches against different problem sizes

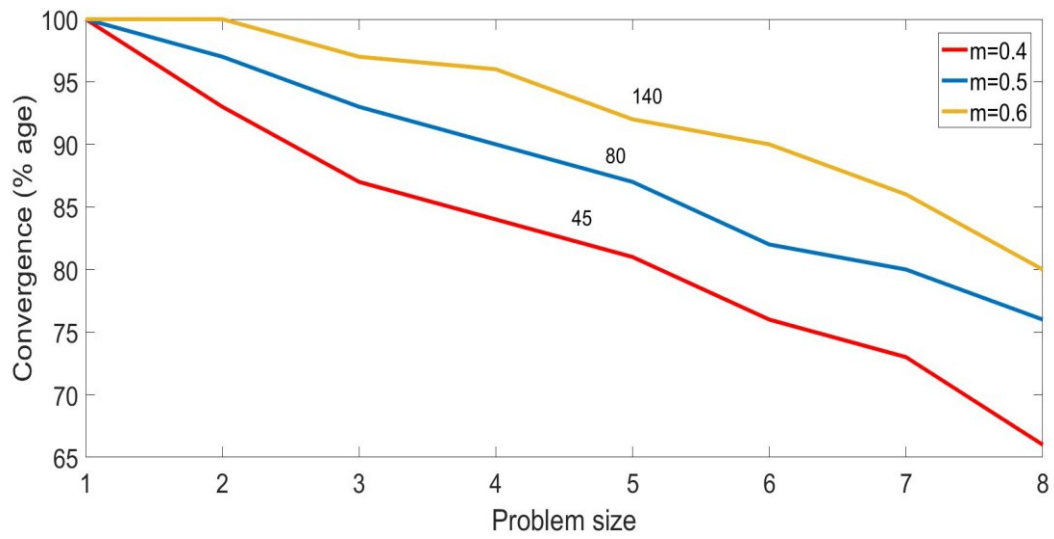

Figure 24. The effect of mutation rate on convergence and population

The results of small and large sets of problems by using the termination criteria of FI and BI are provided in Figure 25 and Figure 26, respectively. It can be observed that hybrid NSGA-II-MOPSO has the standout scores of IGD and HV for both small and large sets of problems. Further, all solution approaches perform well under the BI stopping criteria and MOPSO performs non-satisfactory compared to other approaches. These findings reinforce the earlier presented analysis. It can be concluded that the hybrid approach ensures higher convergence, as well as diversity of solutions and hybrid NSGA-II-MOPSO (BI), is the best solution approach; however, it takes more time in returning solutions.

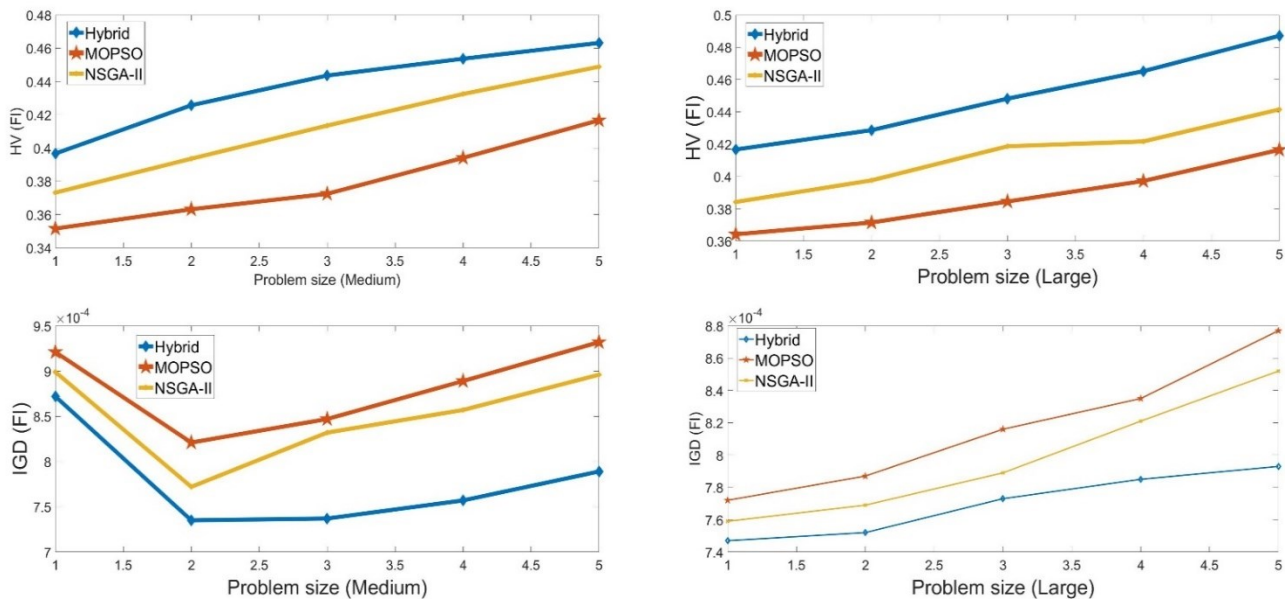

Figure 25. HV and IGD scores of medium and large size problems using FI stopping criteria.

Due to its higher efficiency, the case study analysis is presented by using a hybrid approach with BI criteria.

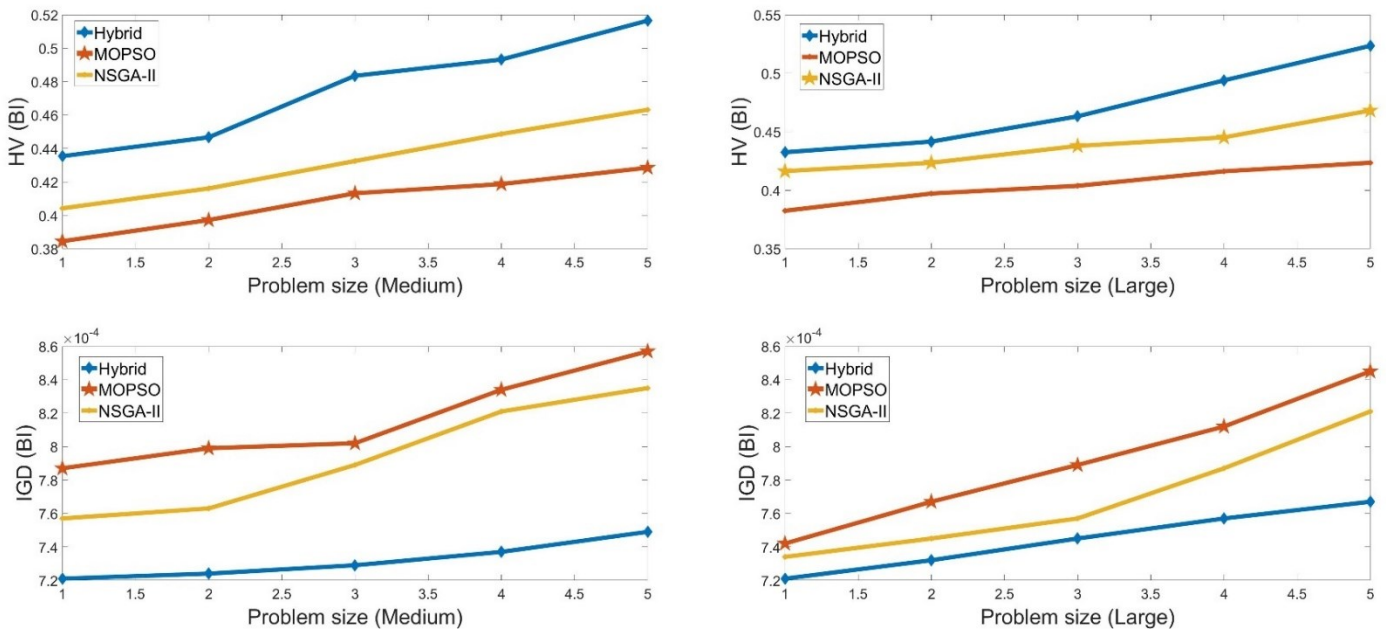

Figure 26. HV and IGD scores of medium and large size problems using BI stopping criteria.

#### 4.5.2. Model validation- Case study 1

The mathematical models can be applied to many industrial parts if the features and operational details of such parts are available. The proposed solution approaches are powerful enough to solve complex real-life problems. For instance, process planning can be carried out for the cylinder head [115], reconfigurable integrated manufacturing systems and reconfigurable assembly systems [3], real industrial parts [57], and products with complex features [15] by using the proposed approaches.

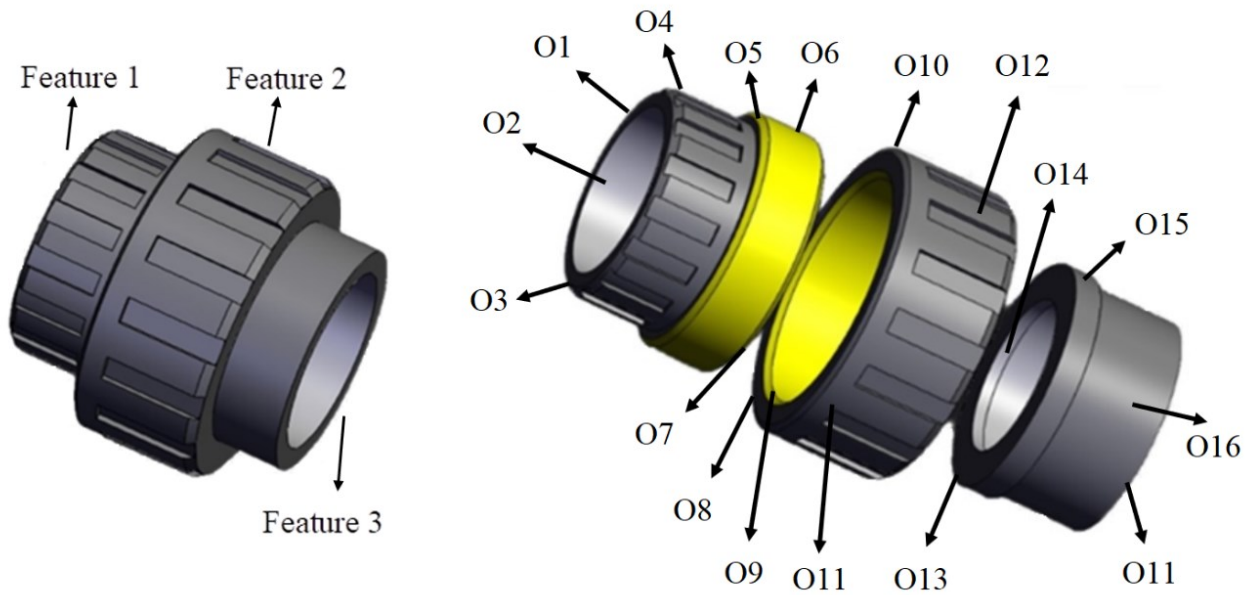

Figure. 27 The product and its operational details-Case study 1

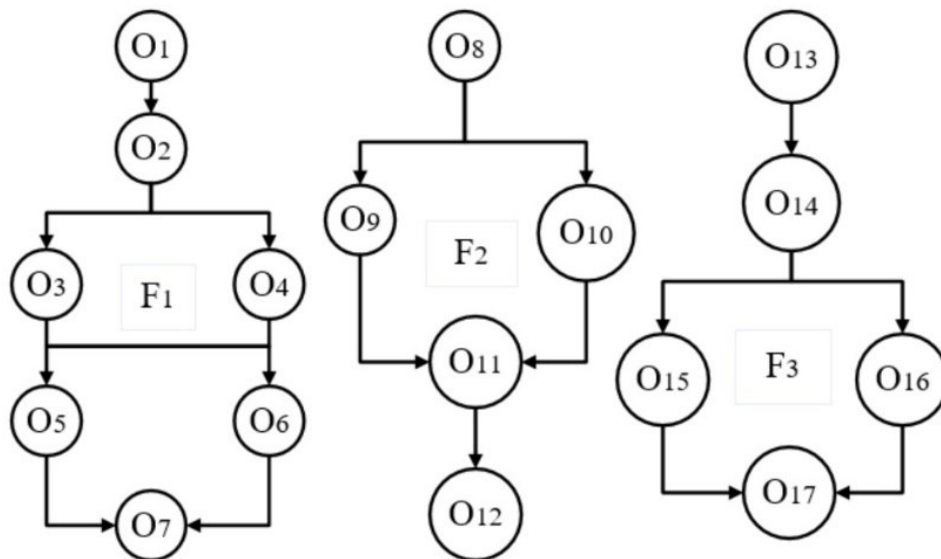

Figure. 28 The precedence order of operations of different features-Case study 1

Without the loss of generality, one case study was used for implementing the models. The detailed part and precedence order of the case study is provided in Figures 27 and 28, respectively. The product needs the completion of 17 operations by using thirteen candidate machine configurations. The data related to TADs, modules, processing time, and cost of operations is given in Table 5. The data of Tool Approach Directions (TADs), modules, and exploitation cost of machine configurations are provided in Table 6. Table 7 provides the addition, subtraction, and re-adjustment time of different modules. The production feasibility

and production rate of machine configurations for different operations are provided in Table 8. A value in the corresponding cell means that a configuration is eligible to perform the associated operation. For example, machine configuration 1 can perform operation 2 with a production rate of 45 units/machine. The matrix of reconfiguration cost between different machine configurations is provided in Table 9. The production is to be carried out for a product demand of 250 units.

Table 5. Operations, TADs, modules, operation time and cost associated with different product features- Case study 1

Feature	Operations	TADs	Modules	$t_f^o$ (mins)	$ft_t$ (mins)	$pc_o$ (USD)
F <sub>1</sub>	O <sub>1</sub>	+x, -z	A <sub>11</sub> , A <sub>13</sub> , A <sub>31</sub> , A <sub>32</sub>	3.5	39.5	07
	O <sub>2</sub>	+y	A <sub>22</sub> , A <sub>34</sub>	05		10
	O <sub>3</sub>	-y, +z	A <sub>11</sub> , A <sub>21</sub> , A <sub>22</sub> , A <sub>24</sub>	07		11
	O <sub>4</sub>	-x, -y, -z	A <sub>12</sub> , A <sub>16</sub>	12		15
	O <sub>5</sub>	+y, -z	A <sub>14</sub> , A <sub>16</sub>	04		06
	O <sub>6</sub>	-y	A <sub>15</sub> , A <sub>23</sub> , A <sub>33</sub>	08		10
	O <sub>7</sub>	-y, +z	A <sub>12</sub> , A <sub>21</sub> , A <sub>31</sub>	04		09
F <sub>2</sub>	O <sub>8</sub>	+x, +z	A <sub>16</sub> , A <sub>25</sub> , A <sub>34</sub>	4.5	35.5	07
	O <sub>9</sub>	-y, -z	A <sub>14</sub> , A <sub>24</sub>	03		09
	O <sub>10</sub>	-y, +z	A <sub>15</sub> , A <sub>22</sub> , A <sub>32</sub>	05		10
	O <sub>11</sub>	-y	A <sub>11</sub> , A <sub>13</sub> , A <sub>25</sub> , A <sub>32</sub> , A <sub>33</sub>	10		12
	O <sub>12</sub>	-y, -z	A <sub>23</sub> , A <sub>33</sub> , A <sub>34</sub>	13		18
F <sub>3</sub>	O <sub>13</sub>	+x	A <sub>16</sub> , A <sub>23</sub> , A <sub>31</sub>	3.5	25.5	07
	O <sub>14</sub>	-y, -z	A <sub>13</sub> , A <sub>24</sub> , A <sub>32</sub>	04		06
	O <sub>15</sub>	-y	A <sub>15</sub> , A <sub>16</sub> , A <sub>21</sub>	05		09
	O <sub>16</sub>	-y, -z	A <sub>12</sub> , A <sub>31</sub> , A <sub>34</sub>	09		12
	O <sub>17</sub>	-x, +z	A <sub>21</sub> , A <sub>33</sub>	04		08

Table 6. TADs, modules, and exploitation cost of different machine configurations-Case study 1

Machine	Configuration	TADs	Modules	$ec_i$ (USD)
M1	1	+x, +y, -y, +z, -z	A <sub>11</sub> , A <sub>14</sub>	350
	2	+x, -x, +y, -y, +z, -z	A <sub>12</sub> , A <sub>14</sub> , A <sub>16</sub>	380
	3	+x, -y, +z, -z	A <sub>11</sub> , A <sub>13</sub> , A <sub>15</sub>	440
	4	+x, -y, +z, -z	A <sub>13</sub> , A <sub>15</sub>	330
	5	+x, -x, +y, -y, +z, -z	A <sub>12</sub> , A <sub>14</sub> , A <sub>15</sub> , A <sub>16</sub>	475
M2	6	+x, -x, -y, +z, -z	A <sub>23</sub> , A <sub>24</sub> , A <sub>25</sub>	420
	7	-x, +y, -y, +z, -z	A <sub>21</sub> , A <sub>22</sub> , A <sub>24</sub> , A <sub>25</sub>	580
	8	+x, -x, +y, -y, +z, -z	A <sub>22</sub> , A <sub>23</sub> , A <sub>25</sub>	450
	9	-x, -y, +z, -z	A <sub>21</sub> , A <sub>24</sub>	350
M3	10	+x, -x, -y, +z, -z	A <sub>32</sub> , A <sub>33</sub>	365
	11	+x, +y, -y, +z, -z	A <sub>31</sub> , A <sub>32</sub> , A <sub>34</sub>	410
	12	+x, -x, +y, -y, +z, -z	A <sub>33</sub> , A <sub>34</sub>	380
	13	+x, -x, -y, +z, -z	A <sub>31</sub> , A <sub>33</sub>	350

Table 7. Module addition, subtraction, and re-adjustment time for different auxiliary modules-Case study 1

Module	Associated time (min)		
	Addition	Subtraction	Re-adjustment
A <sub>11</sub>	2.7	2.3	1.5
A <sub>12</sub>	3.0	2.5	2.0
A <sub>13</sub>	2.5	2.0	1.5
A <sub>14</sub>	5.0	4.5	2.5
A <sub>15</sub>	4.0	3.0	2.0
A <sub>16</sub>	5.0	4.0	3.0
A <sub>21</sub>	4.2	3.5	2.5
A <sub>22</sub>	3.5	2.8	1.8
A <sub>23</sub>	5.0	4.0	2.5
A <sub>24</sub>	3.0	2.0	1.4
A <sub>25</sub>	4.5	2.0	1.1
A <sub>31</sub>	2.8	2.4	2.0
A <sub>32</sub>	4.2	2.5	1.5
A <sub>33</sub>	5.2	3.8	3.0
A <sub>34</sub>	5.5	4.0	2.6



Table 8. Feasibility and production rate of configurations for different operations-Case study 1

Conf.	Operation																
	O <sub>1</sub>	O <sub>2</sub>	O <sub>3</sub>	O <sub>4</sub>	O <sub>5</sub>	O <sub>6</sub>	O <sub>7</sub>	O <sub>8</sub>	O <sub>9</sub>	O <sub>10</sub>	O <sub>11</sub>	O <sub>12</sub>	O <sub>13</sub>	O <sub>14</sub>	O <sub>15</sub>	O <sub>16</sub>	O <sub>17</sub>
1	--	45	--	75	55	70	--	--	50	--	45	--	45	40	--	--	60
2	75	55	--	--	--	60	--	60	--	--	65	45	--	--	55	--	--
3	--	--	60	60	--	--	55	--	60	65	--	55	60	--	60	45	--
4	65	--	80	--	65	--	50	--	70	--	60	--	--	55	--	--	65
5	--	50	67	65	--	70	--	55	--	--	75	--	55	--	70	45	--
6	60	--	--	55	60	55	65	--	75	70	--	48	--	65	--	55	55
7	--	60	60	--	70	--	65	--	60	--	65	--	45	60	--	65	--
8	55	--	70	--	--	75	--	50	--	55	60	--	50	--	45	--	45
9	--	45	--	70	--	65	--	70	55	--	--	53	--	70	75	60	--
10	--	55	50	--	65	--	70	--	60	50	50	--	60	--	--	--	--
11	60	--	55	75	--	60	--	65	--	70	--	45	--	55	--	--	50
12	--	50	--	--	60	--	65	55	--	--	63	--	65	--	65	70	--
13	70	--	75	--	--	50	--	--	77	--	--	--	60	--	60	--	60

Table 9. Configuration change cost between different machine configurations-Case study 1

Conf.	Configurations												
	1	2	3	4	5	6	7	8	9	10	11	12	13
1		185	165	150	190								
2			145	170	140								
3				175	180								
4					130								
5													
6						155	175	140					
7							150	180					
8								160					
9													
10										145	180	165	
11											165	190	
12												155	
13													

The top 17 non-dominated solutions of both models are provided in Table 10. Model 1 gives a minimum cost value of 9904 USD (s#15) compared to Model 2 which has a minimum cost value of 8235 USD (s#15). Similarly, ME has a minimum value of 23.85 (s#7) and 19.03 (s#3) for Model 1 and Model 2, respectively. If we compare the values of TC (Model 1) and TC (Model 2), it can be concluded that all TC values of Model 2 are less than the minimum TC value of Model 1 (9904 USD). On the other hand, the average ME value of all solutions of Model 1 is 33.25 and it is 25.79 for all solutions of Model 2. Thus, on average, 22% less modularity effort is needed in Model 2. It means that if the practitioner selects a random

solution of Model 2, it will have less cost than the minimum TC-based solution of Model 1 and will need less average modular effort in completing the process plan. This highlights the role of quality variations in selecting a minimum cost and minimum modularity efforts-based process plan.

It can be argued that the higher cost and modularity effort values of Model 1 are due to the quality disruptions and failed operations. Due to it, a modular effort has been invested in some operations which are discarded due to poor quality. The quality decay index (QDI) has a minimum value of 0.1511 (s#11) which means that the process plan has almost 15% failed operations compared to conforming operations. Since quality is only analysed through Model 1, we can see that the minimum solutions of TC, QDI, and ME contain 23.71%, 15.11%, and 22.65% failed operation units which correspond to 60, 38 and 57 units of failed products, respectively. There is a trade-off involved in selecting a particular process plan. Some plans can offer less cost with higher quality decay index and modular effort and vice versa. For example, in some cases, as the QDI value increases, the corresponding ME value increases as well. It means that: i) variation in quality necessitates a higher modular effort to complete the required level of conforming operations, and ii) higher QDI value means more failed operations and hence an increase in the lost modularity effort.

Table 10. The non-dominated solutions of Model 1 and Model 2-Case study 1

S. No	Model 1			Model 2	
	TC	QDI	ME	TC	ME
1	11300	0.2196	34.71	8804	24.22
2	10435	0.2235	30.51	8566	25.69
3	10362	0.2465	24.39	8989	<b>19.03</b>
4	11402	0.1799	24.39	8963	19.84
5	10402	0.2019	47.53	8555	25.83
6	10403	0.1843	34.92	8528	26.15
7	10531	0.2265	<b>23.85</b>	8824	19.94
8	10407	0.1776	40.61	8407	36.22
9	10470	0.1841	36.34	8514	31.54
10	11012	0.1705	35.48	8818	24.12
11	10530	<b>0.1511</b>	38.34	8525	26.19
12	11540	0.1797	29.49	8598	24.88
13	10414	0.2035	34.87	8572	25.43
14	11059	0.2229	34.82	8802	24.28
15	<b>9904</b>	0.2371	29.12	<b>8235</b>	36.24
16	10923	0.2234	31.08	8742	24.86
17	10818	0.2031	34.86	8819	24.08
Sum			565.31		438.54
Average value			33.25		25.79

The detailed process plans against different objective functions are provided in Table 11. They can be interpreted column by column. For example, operation 1 ( $O_1$ ) can be performed by the 11<sup>th</sup> configuration for a minimum value of TC (M1), QDI (M1) and TC (M2). Similarly, we can use the 8<sup>th</sup> and 2<sup>nd</sup> configurations for operation 1 ( $O_1$ ) to attain a minimum value of modular effort in Model 1 and Model 2, respectively.

Table 11. Detailed process plans of optimal objective functions-based solutions-Case study 1

S.#		$O_1$	$O_2$	$O_3$	$O_4$	$O_5$	$O_6$	$O_7$	$O_8$	$O_9$	$O_{10}$	$O_{11}$	$O_{12}$	$O_{13}$	$O_{14}$	$O_{15}$	$O_{16}$	$O_{17}$
15	TC (M1)	11	7	5	9	1	9	4	8	4	10	2	6	10	6	9	12	11
11	QDI (M1)	11	1	5	9	10	13	10	2	6	6	12	6	8	11	5	5	11
7	ME (M1)	8	10	7	3	7	2	3	11	13	6	7	3	5	7	5	12	11
15	TC (M2)	11	7	5	9	1	9	4	8	4	10	2	6	10	6	9	12	11
3	ME (M2)	2	1	10	1	10	2	10	11	10	3	10	11	12	9	8	7	11

The cost breakdown of minimum cost solutions of both models is presented in Figure 29. Both models have the same Reconfiguration Cost (RC) as they provide a minimum cost solution against the same process plan (s#15). Similarly, Model 1 includes the values of scrap and re-work costs due to different defects and failed operations. The TMC value of model 1 is higher as it uses a higher number of machine configurations in the presence of variation in quality (eq. 21).

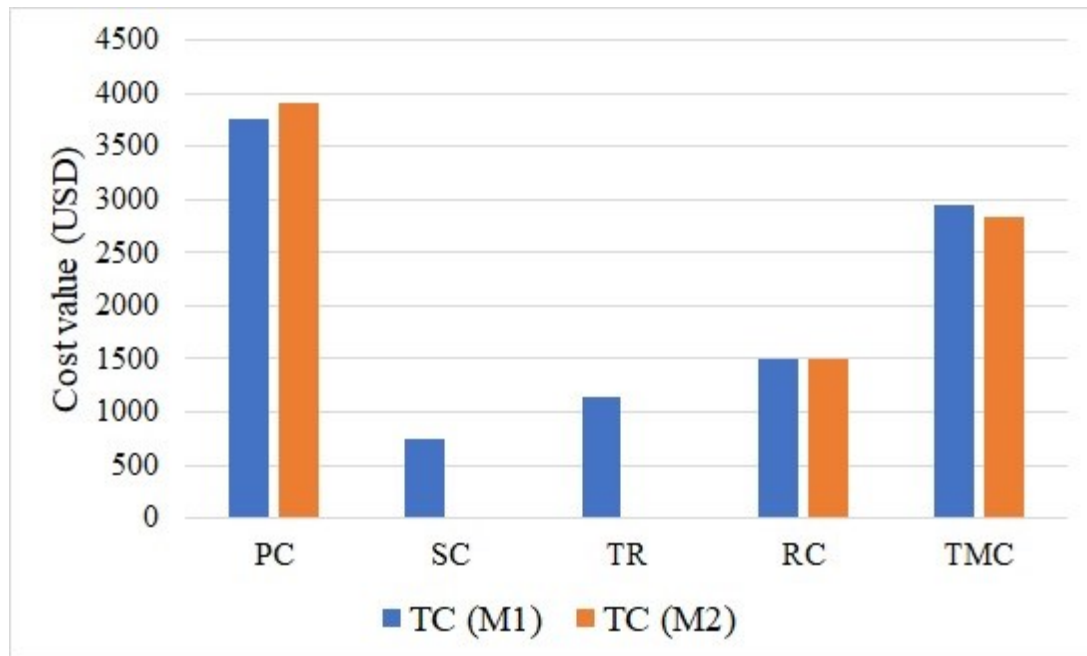

Figure. 29 Cost breakdowns of Model 1 and Model 2

A detailed analysis of modularity is presented in Figure 30. These values are based on different components of ME (Eqs. 15 and 16). The total cost solution of Model 1 uses higher addition, subtraction, and re-adjustment of modules as compared to the total cost solution of Model 2. The same is true for the comparison of modules in the objective function of ME of both models. RMS is known for its cost-efficiency which can be achieved by performing more operations using fewer changes between configurations. This can be ensured if there are no quality-related problems and if a less modular effort is needed. For example, in Figure 30, we can see that the minimum number of configuration changes occurs when a minimum ME solution of Model 2 is used (144 configuration changes). Besides this, the solutions of Model 1 relatively undergo a higher number of configuration changes. If we compare the number of machine configurations used by minimum ME solutions of Model 1 and Model 2, interestingly, both solutions use the same number of configurations (i.e., 36). However, the minimum ME(M1) based process plan has a value of 23.85 which is higher than the minimum ME(M2) based process plan value of 19.03. The reasons behind using the same number of configurations and a higher difference of modularity effort values are two-fold. Firstly, from Table 10, we can see that ME(M2) process plan uses configurations more repetitively as compared to ME(M1) solution (e.g., it uses configuration 10 five times) which results in relatively less need for modular reconfiguration. This is reflected by the different sets of modules (added, subtracted, re-adjusted) used in ME(M1) (361, 253, 90) and ME(M2) (163, 218, 37). Secondly, ME(M1) is based on quality issues and hence it contains an extra proportion of lost modular effort due to failed and scrapped operations. Thus, quality aspects are not only important from cost and number of failed operations viewpoints, but they also impact the modularity of a reconfigurable manufacturing system.

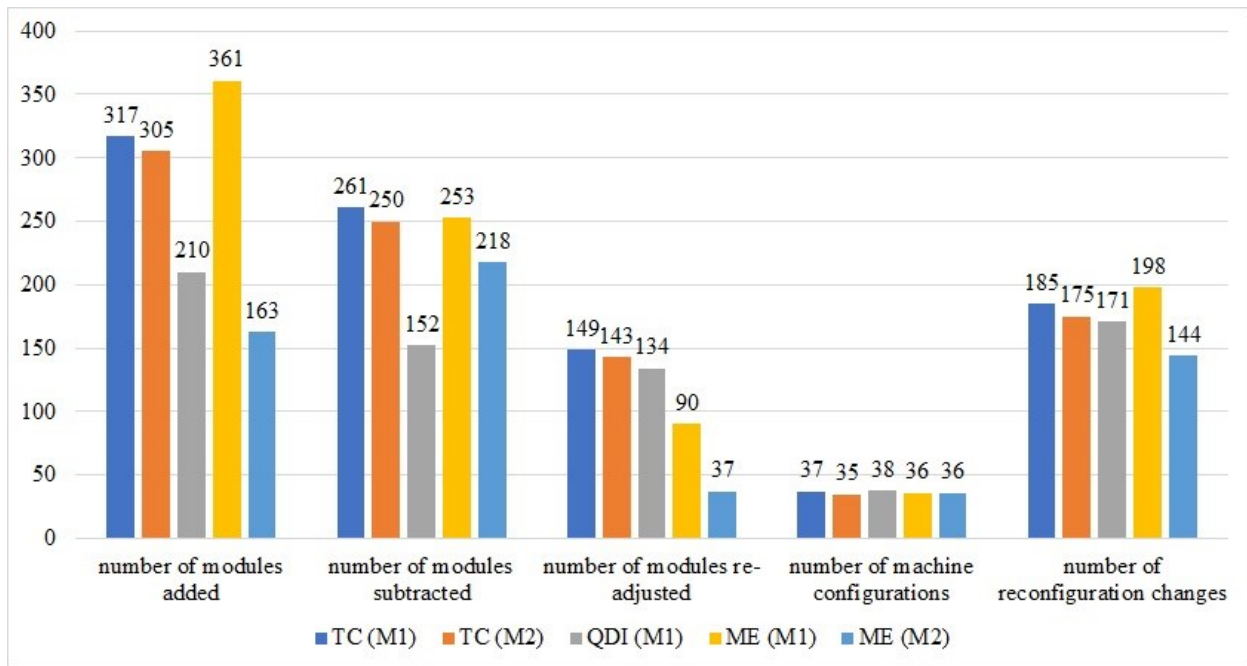

Figure. 30 Comparison of modular features of different models

#### 4.5.2. Model validation- Case study 2

One complex case study was used to generalize the findings. The schematic of the part and its corresponding features are provided in Figure 31. The details of operations within different features and their precedence orders are provided in Figure 32. Table 12 provides the TADs, modules, operation time, time needed to produce a feature, and production costs of different operations. Table 13 contains the configuration, TADs, modules, and machine exploitation cost of different machine configurations. The information of time needed for adding, subtracting, and re-adjusting different modules is given in Table 14. Tables 15 and 16 provide the feasibility and production rate of configurations for different operations. The costs of changing between configurations of the same machine are given in Table 17.

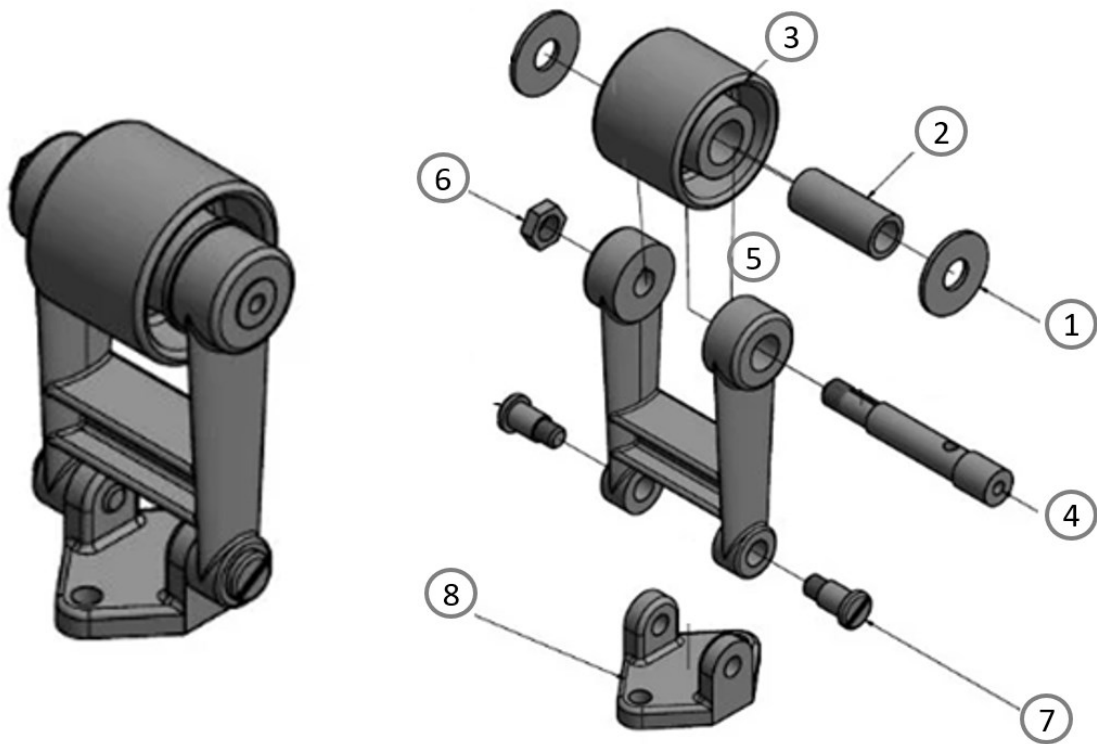

Figure 31. The product and its operational details- Case study 2.

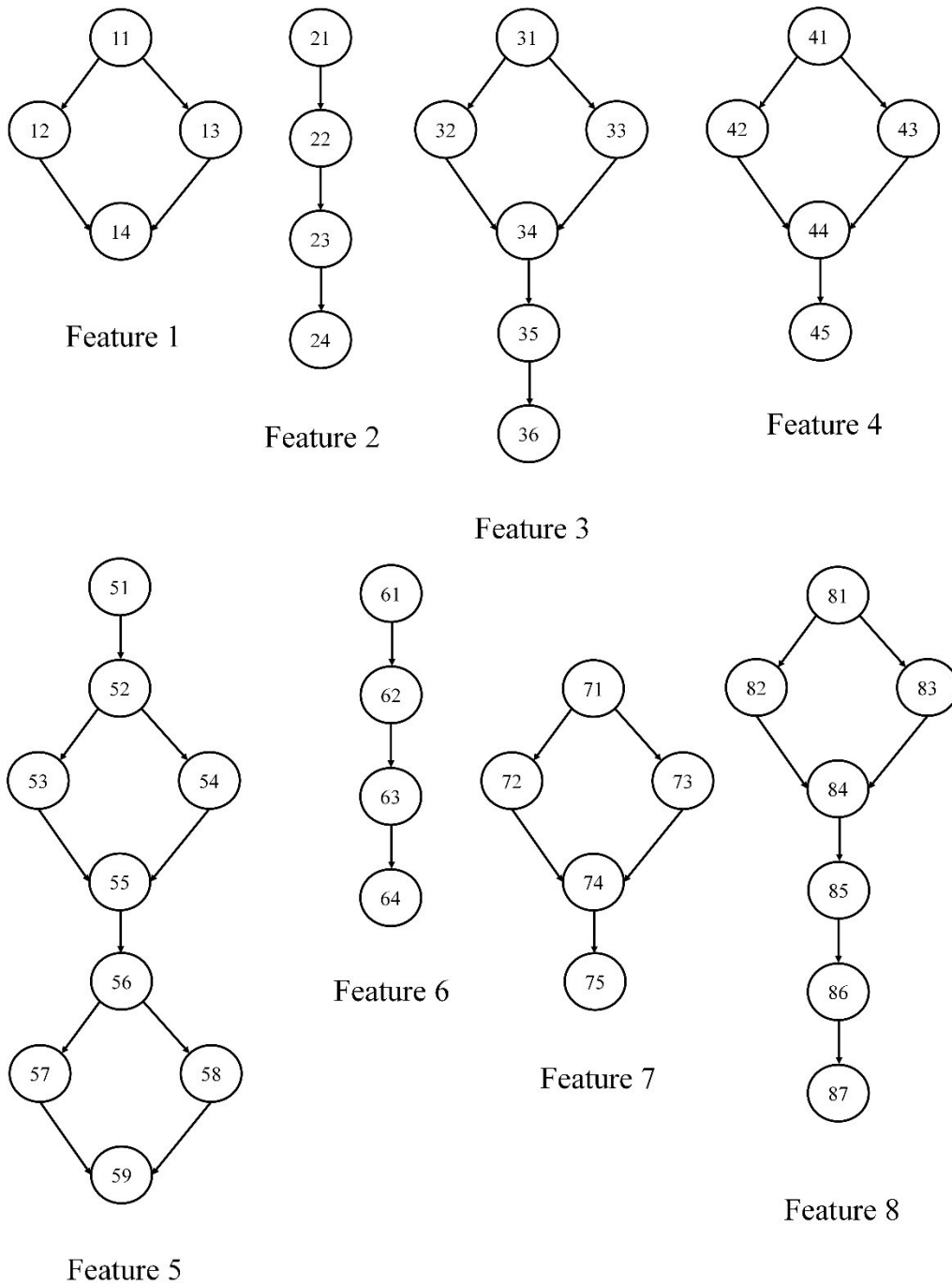

Figure 32. The precedence order of operations of different features-Case study 2

Table 12. Operations, TADs, modules, operation time and cost associated with different product features-Case study 2

Features	Ops.	TADs	$t_f^o$ (mins)	$ft_t$ (mins)	$pc_o$ (USD)	Features	Ops.	TADs	$t_f^o$ (mins)	$ft_t$ (mins)	$pc_o$ (USD)	
F <sub>1</sub>	O <sub>11</sub>	+x, +y	2.0	06	09	F <sub>5</sub>	O <sub>54</sub>	+x, +y, +z	4.3		16	
	O <sub>12</sub>	+x, -y, -z	1.8				O <sub>55</sub>	-x, +y	6.1			20
	O <sub>13</sub>	-x, +y	1.2				O <sub>56</sub>	+x, +y, -z	3.7			15
	O <sub>14</sub>	+y, +z	1.0				O <sub>57</sub>	-z	7.5			18
F <sub>2</sub>	O <sub>21</sub>	-x, +y, -z	6.2	23	13	F <sub>6</sub>	O <sub>58</sub>	-x, -y	5.3	11	14	
	O <sub>22</sub>	-x	8.5				O <sub>59</sub>	+x, -z	5.1			17
	O <sub>23</sub>	+x, +y	4.7				O <sub>61</sub>	+x, -z	3.4			07
	O <sub>24</sub>	-x, +y	3.6				O <sub>62</sub>	+y	2.3			09
F <sub>3</sub>	O <sub>31</sub>	+y, +z	8.4	36	18	F <sub>7</sub>	O <sub>63</sub>	-x, -y, +z	1.1	13	10	
	O <sub>32</sub>	+x, +y, +z	7.2				O <sub>64</sub>	-y, -z	4.2			06
	O <sub>33</sub>	-x, -y	5.6				O <sub>71</sub>	+y, -z	2.2			09
	O <sub>34</sub>	-x, +y, -z	6.3				O <sub>72</sub>	+x, -y	3.1			11
	O <sub>35</sub>	+x, -z	4.9				O <sub>73</sub>	-y, -z	1.8			10
	O <sub>36</sub>	-x, -y, -z	3.6				O <sub>74</sub>	+x, +y, -z	2.6			12
F <sub>4</sub>	O <sub>41</sub>	+y, +z	6.0	30	11	F <sub>8</sub>	O <sub>75</sub>	+x, -z	3.3	40	17	
	O <sub>42</sub>	-x, -y, +z	5.3				O <sub>81</sub>	+x, -y	6.4			15
	O <sub>43</sub>	-x, -y	6.7				O <sub>82</sub>	-z	5.7			18
	O <sub>44</sub>	+x, +y, +z	7.5				O <sub>83</sub>	-x, -z	7.4			14
	O <sub>45</sub>	-x, +y	4.5				O <sub>84</sub>	-x, -y, -z	3.5			13
F <sub>5</sub>	O <sub>51</sub>	+x, -y, +z	7.2	50	15	F <sub>8</sub>	O <sub>85</sub>	+y, -z	4.0	40	14	
	O <sub>52</sub>	+x, +y	6.3				O <sub>86</sub>	+x, +y, +z	5.8			16
	O <sub>53</sub>	-y, -z	4.5				O <sub>87</sub>	-x, +y,	7.2			



Table 13. TADs, modules, and exploitation cost of different machine configurations-Case study 2

Machine	Configurations	TADs	Modules	$ec_i$ (USD)	Machine	Configurations	TADs	Modules	$ec_i$ (USD)
M1	1	+x, -x, +y, -y, +z, -z	A <sub>11</sub> , A <sub>12</sub> , A <sub>15</sub> , A <sub>16</sub>	460	M4	13	+x, -x, +y, -y, +z, -z	A <sub>42</sub> , A <sub>43</sub> , A <sub>45</sub> , A <sub>47</sub> , A <sub>49</sub>	840
	2	+x, -x, +y, -y, +z, -z	A <sub>12</sub> , A <sub>14</sub> , A <sub>15</sub> , A <sub>16</sub>	480		14	+x, -x, +y, -y, +z, -z	A <sub>42</sub> , A <sub>44</sub> , A <sub>47</sub> , A <sub>48</sub>	750
	3	+x, -x, +y, -y, +z, -z	A <sub>11</sub> , A <sub>12</sub> , A <sub>13</sub> , A <sub>14</sub> , A <sub>16</sub>	430		15	+x, -x, +y, -y, +z, -z	A <sub>43</sub> , A <sub>45</sub> , A <sub>46</sub> , A <sub>49</sub>	700
M2	4	+x, -x, +y, -y, +z, -z	A <sub>22</sub> , A <sub>23</sub> , A <sub>25</sub> , A <sub>26</sub>	560	M5	16	+x, -x, +y, -y, +z, -z	A <sub>52</sub> , A <sub>54</sub> , A <sub>56</sub>	650
	5	+x, -x, +y, -y, +z, -z	A <sub>21</sub> , A <sub>22</sub> , A <sub>24</sub> , A <sub>25</sub> , A <sub>27</sub>	510		17	+x, -x, +y, -y, +z, -z	A <sub>51</sub> , A <sub>52</sub> , A <sub>55</sub> , A <sub>56</sub>	680
	6	+x, -x, +y, -y, +z, -z	A <sub>23</sub> , A <sub>24</sub> , A <sub>25</sub> , A <sub>26</sub> , A <sub>28</sub>	615		18	+x, -x, +y, -y, +z, -z	A <sub>53</sub> , A <sub>54</sub> , A <sub>55</sub>	730
	7	+x, -x, +y, -y, +z, -z	A <sub>21</sub> , A <sub>22</sub> , A <sub>24</sub> , A <sub>27</sub> , A <sub>28</sub>	490		19	+x, -x, +y, -y, +z, -z	A <sub>51</sub> , A <sub>52</sub> , A <sub>54</sub> , A <sub>56</sub>	770
M3	8	+x, -x, +y, -y, +z, -z	A <sub>31</sub> , A <sub>33</sub> , A <sub>34</sub> , A <sub>35</sub>	670	M6	20	+x, -x, +y, -y, +z, -z	A <sub>62</sub> , A <sub>63</sub> , A <sub>64</sub> , A <sub>65</sub>	810
	9	+x, -x, +y, -y, +z, -z	A <sub>32</sub> , A <sub>34</sub> , A <sub>35</sub> , A <sub>36</sub>	690		21	+x, -x, +y, -y, +z, -z	A <sub>61</sub> , A <sub>62</sub> , A <sub>63</sub> , A <sub>65</sub>	830
	10	+x, -x, +y, -y, +z, -z	A <sub>31</sub> , A <sub>33</sub> , A <sub>35</sub> , A <sub>36</sub>	720		22	+x, -x, +y, -y, +z, -z	A <sub>62</sub> , A <sub>63</sub> , A <sub>64</sub>	775
M4	11	+x, -x, +y, -y, +z, -z	A <sub>41</sub> , A <sub>43</sub> , A <sub>46</sub> , A <sub>49</sub>	810	M7	23	+x, -x, +y, -y, +z, -z	A <sub>72</sub> , A <sub>73</sub> , A <sub>74</sub>	480
	12	+x, -x, +y, -y, +z, -z	A <sub>41</sub> , A <sub>42</sub> , A <sub>44</sub> , A <sub>46</sub> , A <sub>48</sub>	770		24	+x, -x, +y, -y, +z, -z	A <sub>71</sub> , A <sub>72</sub> , A <sub>73</sub>	430

Table 14. Module addition, subtraction, and re-adjustment time for different auxiliary modules-Case study 2

Modules	Associated time			Modules	Associated time		
	Addition	Subtraction	Re-adjustment		Addition	Subtraction	Re-adjustment
A <sub>11</sub>	4.5	3.8	3.2	A <sub>44</sub>	5.1	4.1	3.2
A <sub>12</sub>	4.1	3.4	2.7	A <sub>45</sub>	6.3	5.2	4.1
A <sub>13</sub>	3.2	2.6	2.0	A <sub>46</sub>	6.0	4.8	3.2
A <sub>14</sub>	5.8	4.4	3.5	A <sub>47</sub>	4.7	3.5	2.7
A <sub>15</sub>	3.2	2.5	2.1	A <sub>48</sub>	4.2	3.1	2.6
A <sub>16</sub>	4.4	3.2	2.5	A <sub>49</sub>	4.8	3.6	2.8
A <sub>21</sub>	3.8	2.8	2.0	A <sub>51</sub>	5.6	4.4	3.2
A <sub>22</sub>	5.5	4.3	3.4	A <sub>52</sub>	6.5	5.3	3.8
A <sub>23</sub>	4.8	4.0	3.1	A <sub>53</sub>	6.2	4.1	3.0
A <sub>24</sub>	5.9	5.2	4.0	A <sub>54</sub>	5.1	3.7	2.7
A <sub>25</sub>	6.2	4.8	3.6	A <sub>55</sub>	4.7	3.6	2.6
A <sub>26</sub>	3.5	2.7	1.8	A <sub>56</sub>	4.2	3.2	2.2
A <sub>27</sub>	3.7	3.1	2.3	A <sub>61</sub>	4.9	3.7	2.4
A <sub>28</sub>	4.7	3.6	2.7	A <sub>62</sub>	5.6	4.2	3.0
A <sub>31</sub>	5.3	4.2	3.2	A <sub>63</sub>	5.3	4.3	3.2
A <sub>32</sub>	5.8	4.8	3.3	A <sub>64</sub>	6.8	5.3	3.7
A <sub>33</sub>	4.5	3.7	2.8	A <sub>65</sub>	6.1	4.7	3.4
A <sub>34</sub>	3.6	2.8	1.9	A <sub>71</sub>	5.2	4.0	2.8
A <sub>35</sub>	3.5	2.5	1.7	A <sub>72</sub>	4.3	3.4	2.6
A <sub>41</sub>	3.8	3.0	2.0	A <sub>73</sub>	4.7	3.6	2.7
A <sub>42</sub>	4.9	4.1	3.2	A <sub>74</sub>	4.9	3.9	2.8
A <sub>43</sub>	5.7	4.4	3.3		5.7	4.3	3.1

Table 15. Feasibility and production rate of configurations for different operations-Case study 2

Confs.	Operations																					
	O <sub>11</sub>	O <sub>12</sub>	O <sub>13</sub>	O <sub>14</sub>	O <sub>21</sub>	O <sub>22</sub>	O <sub>23</sub>	O <sub>24</sub>	O <sub>31</sub>	O <sub>32</sub>	O <sub>33</sub>	O <sub>34</sub>	O <sub>35</sub>	O <sub>36</sub>	O <sub>41</sub>	O <sub>42</sub>	O <sub>43</sub>	O <sub>44</sub>	O <sub>45</sub>	O <sub>51</sub>	O <sub>52</sub>	O <sub>53</sub>
1	--	45	60	--	75	--	50	65	55	--	--	70	55	--	45	55	--	--	--	70	50	--
2	55	--	65	70	--	60	--	45	--	75	50	--	70	50	--	45	--	50	80	--	--	65
3	65	55	--	--	--	50	55	--	60	--	--	--	45	--	65	--	--	--	--	60	55	--
4	--	--	60	55	--	55	70	50	--	50	65	--	--	55	--	75	45	--	--	50	75	--
5	--	65	50	--	70	65	60	--	45	--	--	55	--	60	45	--	50	--	65	--	50	--
6	40	--	55	50	--	75	--	65	55	--	45	--	60	--	--	65	--	60	--	55	--	45
7	75	--	--	45	60	--	50	--	--	65	--	55	70	40	--	--	65	55	--	--	--	70
8	60	--	65	50	--	50	60	--	45	65	--	70	--	55	--	65	--	50	--	65	45	--
9	--	70	60	50	--	65	--	55	--	80	40	--	55	--	55	--	--	75	50	--	55	--
10	50	60	--	--	65	--	55	70	--	--	60	--	50	55	--	--	50	--	60	--	--	70
11	55	--	55	65	--	45	75	--	50	--	60	--	45	--	60	50	--	65	--	55	65	--
12	45	55	--	--	70	50	--	60	--	60	--	50	--	75	--	50	--	45	65	--	--	75
13	--	--	45	60	55	--	--	50	70	--	--	45	55	--	65	--	80	--	40	--	60	--
14	--	65	50	--	75	55	--	60	--	45	70	--	--	--	55	--	50	--	50	--	45	55
15	70	60	--	50	--	60	75	--	55	--	50	65	--	55	--	45	--	--	65	50	--	--
16	65	--	70	--	55	60	--	45	75	--	40	--	60	65	--	55	--	50	--	--	65	--
17	75	55	--	70	50	--	65	--	50	--	60	--	--	--	45	--	55	--	65	55	--	60
18	--	60	--	60	45	--	70	--	65	55	--	50	--	75	--	70	--	--	50	--	60	70
19	--	--	50	60	--	70	--	55	--	65	--	--	50	45	--	--	70	--	--	45	75	--
20	45	--	60	50	--	65	--	70	50	--	70	55	--	65	50	--	75	--	45	--	55	--
21	--	70	60	--	45	65	--	55	--	75	--	--	45	--	55	--	--	70	--	70	--	45
22	65	75	--	55	45	--	60	--	70	50	--	65	55	75	--	--	--	60	--	55	--	60
23	55	--	55	65	--	70	--	60	50	--	--	--	65	--	--	45	--	55	50	--	70	--
24	--	60	45	--	70	50	65	--	--	--	55	75	--	--	65	--	45	50	--	40	60	50

Table 16. Feasibility and production rate of configurations for different operations-Case study 2

Confs.	Operations																					
	O <sub>54</sub>	O <sub>55</sub>	O <sub>56</sub>	O <sub>57</sub>	O <sub>58</sub>	O <sub>59</sub>	O <sub>61</sub>	O <sub>62</sub>	O <sub>63</sub>	O <sub>64</sub>	O <sub>71</sub>	O <sub>72</sub>	O <sub>73</sub>	O <sub>74</sub>	O <sub>75</sub>	O <sub>81</sub>	O <sub>82</sub>	O <sub>83</sub>	O <sub>84</sub>	O <sub>85</sub>	O <sub>86</sub>	O <sub>87</sub>
1	--	65	--	70	--	45	--	--	60	50	75	--	--	55	70	--	--	50	--	55	45	--
2	--	55	45	--	60	50	--	65	55	--	40	--	--	65	55	--	60	45	--	--	50	--
3	50	--	60	50	--	--	65	--	45	--	55	75	60	--	--	--	65	--	45	65	--	55
4	--	--	70	--	--	60	75	45	--	--	60	--	--	75	45	--	--	50	--	60	--	50
5	55	--	--	65	--	55	45	50	--	--	60	--	50	60	55	--	--	55	65	--	60	--
6	--	75	50	--	--	45	50	--	--	65	--	80	45	40	50	60	--	--	60	50	--	75
7	--	45	55	--	80	--	--	60	--	50	--	--	--	55	65	--	45	75	--	--	80	65
8	70	--	--	75	55	--	--	65	--	75	--	50	65	--	80	--	--	65	--	55	--	--
9	--	--	65	50	--	--	60	--	75	--	--	45	55	75	--	65	--	--	50	60	50	--
10	--	--	45	--	--	70	60	--	65	40	75	--	--	65	45	--	--	55	--	--	60	50
11	--	50	--	65	--	55	--	--	75	--	50	45	--	55	50	--	65	--	45	55	--	--
12	65	55	--	--	60	60	--	--	65	50	55	65	50	--	--	45	--	50	--	--	75	55
13	45	60	--	--	50	45	--	--	55	40	--	75	65	45	--	55	--	--	65	55	--	45
14	--	--	65	--	65	--	70	--	45	75	--	50	55	--	--	65	--	45	--	--	65	70
15	50	--	--	45	--	--	55	70	--	65	--	45	60	40	55	--	--	50	--	75	--	--
16	--	--	70	55	75	--	60	--	70	--	65	--	--	60	55	--	75	--	55	--	50	--
17	60	--	55	--	50	65	40	--	60	--	55	75	70	--	--	45	70	--	55	80	--	60
18	--	75	--	55	--	70	--	45	--	60	50	--	--	55	45	--	--	65	45	--	60	70
19	--	55	--	45	60	--	50	--	70	80	--	50	65	--	--	55	45	--	--	55	75	--
20	70	--	65	75	65	--	55	--	45	--	--	50	55	--	--	50	--	75	--	--	60	50
21	45	60	--	--	70	--	65	75	--	55	45	--	--	75	65	80	--	--	65	50	--	45
22	55	65	--	--	65	55	--	45	--	55	70	--	--	60	55	--	65	80	--	--	75	--
23	--	--	75	45	55	--	--	50	--	65	60	40	--	50	40	--	--	55	--	--	55	--
24	--	--	45	--	50	40	--	60	55	--	65	--	--	45	--	65	70	--	50	60	--	75

Table 17. Configuration change cost between different machine configurations-Case study 2

Confs.	Configurations																							
	1	2	3	4	5	6	7	8	9	10	11	12	13	14	15	16	17	18	19	20	21	22	23	24
1		180	190																					
2			210																					
3																								
4					220	180	200																	
5						210	190																	
6							200																	
7																								
8								190	230															
9									215															
10																								
11										240	220	200	190											
12											200	180	230											
13												200	210											
14													250											
15																								
16																200	180	220						
17																	230	260						
18																		190						
19																								
20																				210	230			
21																					190			
22																								
23																								
24																								260

Table 18. The non-dominated solutions of Model 1 and Model 2-Case study 2

S. No	Model 1			Model 2	
	TC	QDI	ME	TC	ME
1	16870	0.2043	51.46	11704	34.89
2	17210	0.2105	49.27	10874	55.64
3	16997	<b>0.1836</b>	75.29	11210	44.36
4	18585	0.1902	55.47	<b>10580</b>	63.37
5	18210	0.1953	58.96	10890	52.34
6	17950	0.1886	63.85	11375	41.55
7	17355	0.2098	61.29	11025	45.83
8	15680	0.2207	66.23	10865	57.83
9	16245	0.2035	68.02	11376	39.35
10	<b>13400</b>	0.2673	63.16	10733	60.23
11	14767	0.2586	57.69	12264	<b>31.43</b>
12	16375	0.2036	65.42	10982	47.53
13	15636	0.2243	50.56	10684	62.78
14	17635	0.1922	<b>48.39</b>	11555	36.75
15	15500	0.2362	56.74	10800	58.56
16	16890	0.1989	70.21	11267	43.73
17	17355	0.2059	52.37	10935	49.22
18	13984	0.2637	59.27	11430	38.13
19	14268	0.2612	67.78	10708	60.42
20	16437	0.2008	60.24	12034	33.63
Sum			1201.67		957.57
Average value			60.0835		47.879

Table 18 contains the top 20 non-dominated solutions of Model 1 and Model 2. In Model 1, process plans s#10, 03, and 14 provide the minimum value of the Total Cost (TC), the Quality Decay Index (QDI), and the Modularity Efforts (ME), respectively. On the other hand, process plans s#04 and 11 provide the minimum values of TC and ME (Model 2), respectively. It can be observed that all TC values of Model 2 are less than the minimum TC value of Model 1 (13400 USD). The average ME value of Model 1 is 60.0835 whereas the average ME value of Model 2 is 47.879. In addition, an increase in the QDI value impacts the cost solutions in most cases. It means that quality and cost need to be analysed together for improving the performance of a process plan. Tables 19 and 20 provide the detailed process plans against all non-dominated solutions. As the previous results, these findings can be interpreted column-wise. For example, as observed in Table 18, process plan 10 provides the minimum Total Cost value (Model 1). Accordingly, Table 19 shows that the four operations of the first feature i.e., O<sub>11</sub>, O<sub>12</sub>, O<sub>13</sub>, and O<sub>14</sub> can be performed by the sixth, tenth, eleventh and fourth configuration, respectively. This can assist the practitioners in selecting a process plan according to the choice of a particular objective function. Tables 21 and 22 provide the detailed process plans against the optimal objective function values. These findings summarize the detailed process plans according to the choice of different objective functions of both models. Starting from the first operation (O<sub>11</sub>) till the last operation (O<sub>87</sub>), managers can assign machine configurations to operations for achieving multiple goals (i.e., cost, quality, modularity). In addition, it can be inferred from Table 21 and Table 22 that the TC solution of Model 1 repeats 14 configurations in its process plan. The sum of repeatedly used configurations is 36. On the other hand, the ME solution of Model 1 repeats 15 configurations in its process plan which amounts to a total number of 40 configurations repeatedly used. Due to the high number of repetitions of machine configurations in its process plan, the ME-based solution needs relatively less modular adjustment and hence a minimum value of modularity effort.

Table 19. The detailed process plans of top-non-dominated solutions-Case study 2.

S#	O11	O12	O13	O14	O21	O22	O23	O24	O31	O32	O33	O34	O35	O36	O41	O42	O43	O44	O45	O51	O52	O53
1	06	10	02	09	10	05	11	10	05	21	06	24	03	08	09	08	20	09	13	04	09	12
2	10	12	05	17	05	16	11	14	11	18	09	07	10	16	17	15	14	02	13	15	14	22
3	11	14	09	02	17	23	22	21	18	07	15	15	16	04	03	02	10	22	02	19	19	06
4	17	15	08	06	01	03	03	02	23	02	20	05	02	05	09	01	04	12	09	04	01	02
5	03	21	13	07	07	05	15	06	01	14	17	05	03	02	14	12	07	08	12	03	04	02
6	02	09	19	15	01	09	10	01	06	19	04	01	23	02	20	23	24	24	23	17	01	10
7	12	03	21	19	16	12	07	02	15	22	02	20	21	20	09	18	24	02	05	22	01	24
8	23	24	02	23	22	02	08	14	22	04	10	13	16	19	01	11	07	23	17	01	05	07
9	12	05	06	20	05	02	03	19	20	08	17	08	09	15	14	06	04	08	20	01	09	10
10	06	10	11	04	18	20	01	23	16	14	24	22	06	10	24	08	17	06	09	08	08	14
11	02	15	09	23	22	23	24	13	05	12	11	07	07	07	11	01	19	02	02	11	14	17
12	07	21	24	11	14	03	18	10	01	12	14	01	19	04	05	01	07	12	05	19	16	18
13	08	18	21	19	24	08	05	02	17	08	09	18	19	05	09	12	10	12	12	21	24	21
14	17	17	19	17	05	15	03	09	23	02	02	08	09	19	21	18	04	16	15	22	03	06
15	20	05	04	11	07	19	18	23	18	09	06	05	03	22	13	15	19	22	15	01	13	02
16	23	10	06	06	01	04	22	21	06	21	24	24	01	04	05	06	24	24	18	04	23	07
17	10	01	01	09	16	06	05	12	06	08	04	12	01	16	03	02	05	07	20	11	13	10
18	02	03	11	23	14	24	01	13	01	04	11	01	22	07	24	11	13	02	02	24	11	14
19	06	01	20	18	18	21	08	04	05	14	15	18	18	22	17	01	20	21	09	08	09	18
20	23	22	05	02	12	12	18	09	22	07	17	15	23	12	24	01	07	11	05	04	04	24



Table 20. The detailed process plans of top-non-dominated solutions-Case study 2.

S#	O <sub>54</sub>	O <sub>55</sub>	O <sub>56</sub>	O <sub>57</sub>	O <sub>58</sub>	O <sub>59</sub>	O <sub>61</sub>	O <sub>62</sub>	O <sub>63</sub>	O <sub>64</sub>	O <sub>71</sub>	O <sub>72</sub>	O <sub>73</sub>	O <sub>74</sub>	O <sub>75</sub>	O <sub>81</sub>	O <sub>82</sub>	O <sub>83</sub>	O <sub>84</sub>	O <sub>85</sub>	O <sub>86</sub>	O <sub>87</sub>
1	12	13	03	05	12	11	05	24	14	22	23	06	13	07	07	12	11	20	17	21	20	07
2	21	19	09	11	02	18	16	07	03	15	04	08	19	10	11	09	17	07	18	04	23	12
3	05	02	10	16	23	24	14	02	12	07	11	11	03	15	18	17	22	10	21	09	05	18
4	08	07	02	19	07	04	10	15	19	01	16	15	08	18	02	20	03	02	09	13	09	03
5	15	11	06	19	13	06	04	21	01	10	18	19	12	22	04	24	07	05	11	19	12	07
6	13	19	14	23	17	10	03	08	01	12	22	08	15	02	22	09	02	18	03	24	16	13
7	17	22	23	05	24	13	20	05	12	15	24	09	20	06	21	12	22	23	17	01	18	21
8	20	06	20	08	19	01	17	02	16	19	04	08	06	09	10	17	24	20	21	04	02	24
9	03	01	16	01	08	05	10	21	24	22	04	03	03	15	06	20	16	08	05	13	20	12
10	03	01	10	15	02	12	06	23	19	14	02	14	13	21	08	19	11	12	06	17	23	06
11	08	12	04	18	13	10	20	08	20	07	17	19	15	16	01	06	11	14	13	19	01	03
12	20	18	06	23	14	22	19	05	09	06	22	23	17	18	04	24	07	22	03	04	09	13
13	22	21	03	03	21	17	15	04	12	14	24	20	20	24	08	13	03	01	03	01	07	21
14	13	02	24	09	23	24	06	18	03	23	05	03	03	01	11	09	22	01	17	08	14	18
15	05	11	02	16	07	05	04	22	09	18	11	13	06	01	16	12	17	05	21	13	18	12
16	17	13	23	19	02	02	10	22	17	10	21	17	14	07	18	19	19	10	06	17	20	04
17	21	18	04	05	14	04	16	07	24	08	21	15	17	05	22	24	07	14	16	21	05	07
18	15	22	02	20	24	12	20	05	14	01	03	06	05	13	06	13	03	18	11	06	12	10
19	05	01	14	23	19	11	17	02	03	07	10	08	09	15	02	09	24	20	09	08	18	14
20	22	07	16	08	07	22	09	24	10	22	01	09	03	23	08	12	19	04	17	13	22	10

Table 21. Detailed process plans of optimal objective functions-based solutions-Case study 2.

S. No		Operations																					
		O <sub>11</sub>	O <sub>12</sub>	O <sub>13</sub>	O <sub>14</sub>	O <sub>21</sub>	O <sub>22</sub>	O <sub>23</sub>	O <sub>24</sub>	O <sub>31</sub>	O <sub>32</sub>	O <sub>33</sub>	O <sub>34</sub>	O <sub>35</sub>	O <sub>36</sub>	O <sub>41</sub>	O <sub>42</sub>	O <sub>43</sub>	O <sub>44</sub>	O <sub>45</sub>	O <sub>51</sub>	O <sub>52</sub>	O <sub>53</sub>
10	<b>TC (M1)</b>	06	10	11	04	18	20	01	23	16	14	24	22	06	10	24	08	17	06	09	08	08	14
03	<b>QDI (M1)</b>	11	14	09	02	17	23	22	21	18	07	15	15	16	04	03	02	10	22	02	19	19	06
14	<b>ME (M1)</b>	17	17	19	17	05	15	03	09	23	02	02	08	09	19	21	18	04	16	15	22	03	06
04	<b>TC (M2)</b>	17	15	08	06	01	03	03	02	23	02	20	05	02	05	09	01	04	12	09	04	01	02
11	<b>ME (M2)</b>	02	15	09	23	22	23	24	13	05	12	11	07	07	07	11	01	19	02	02	11	14	17

Table 22. Detailed process plans of optimal objective functions-based solutions-Case study 2.

S. No		Operations																					
		O <sub>54</sub>	O <sub>55</sub>	O <sub>56</sub>	O <sub>57</sub>	O <sub>58</sub>	O <sub>59</sub>	O <sub>61</sub>	O <sub>62</sub>	O <sub>63</sub>	O <sub>64</sub>	O <sub>71</sub>	O <sub>72</sub>	O <sub>73</sub>	O <sub>74</sub>	O <sub>75</sub>	O <sub>81</sub>	O <sub>82</sub>	O <sub>83</sub>	O <sub>84</sub>	O <sub>85</sub>	O <sub>86</sub>	O <sub>87</sub>
10	<b>TC (M1)</b>	03	01	10	15	02	12	06	23	19	14	02	14	13	21	08	19	11	12	06	17	23	06
03	<b>QDI (M1)</b>	05	02	10	16	23	24	14	02	12	07	11	11	03	15	18	17	22	10	21	09	05	18
14	<b>ME (M1)</b>	13	02	24	09	23	24	06	18	03	23	05	03	03	01	11	09	22	01	17	08	14	18
04	<b>TC (M2)</b>	08	07	02	19	07	04	10	15	19	01	16	15	08	18	02	20	03	02	09	13	09	03
11	<b>ME (M2)</b>	08	12	04	18	13	10	20	08	20	07	17	19	15	16	01	06	11	14	13	19	01	03

This chapter reviewed the different solution approaches used for solving the RMS process planning problems (cost, time optimization, etc.). An emphasis was given to the need of using hybrid solution approaches. RMS is an advanced subject, and its process planning is Non-Polynomial (NP) hard. Thus, hybrid approaches can more effectively solve such complex problems. Hybrid heuristic combines multiple meta-heuristics into a single framework. The combined meta-heuristics reinforce the positive aspects of each other. A hybrid version of the Non-Dominated Sorting Genetic Algorithm (NSGA-II) and Multi-Objective Particle Swarm Optimization (MOPSO) was presented to solve the mathematical model comprising the Total Cost, the Quality Decay Index, and the Modularity Effort. An exact solution approach was also adapted to solve small-sized problems.

The mathematical models and solution approaches were implemented to two case studies. The first case study comprised three features and seventeen operations. The second case study was more complex, and it comprised eight features and forty-four operations. The findings suggested a trade-off among the objectives of the Total Cost, the Quality Decay Index, and the Modularity Index. It means that a process plan performing well on the dimension of quality may offer a compromised result w.r.t cost or modularity. In addition, the Total Cost value of any process plan of Model 2 was less than the minimum Total Cost value of Model 1. This indicates the effect of quality variation on the cost efficiency of a process plan. In addition, the average Modularity Effort value needed by all process plans of Model 2 was less than the average Modularity Effort value of all process plans of Model 1. This reinforces the idea that the quality variation and defects impact the modularity and ease of reconfiguration of a reconfigurable manufacturing system. Among other results, detailed process plans were provided against the choice of different objective functions. Industrial managers/practitioners can select a process plan according to their preferences.

These findings can be generalized to multiple contexts. Practitioners need to know at the outset the number and types of modules they will be used for production. In the presence of variations and defects, the comparative analysis provides the details of extra modules and their dynamics (addition, subtraction, and re-adjustment) due to such defects. These findings will help in calculating the number of modules added, subtracted, and re-adjusted in the presence and absence of defects and quality variations. In addition, productivity can be enhanced (or production time can be minimized) by reducing the number of 'reconfigurations' between different processes. A smaller number of reconfigurations is achieved in the case of the minimum modularity effort solution in the absence of quality variations (Modularity effort

(Model 2)). Thus, more focus should be given to simultaneously control the quality variations and minimizing the modularity efforts to enhance the productivity of a reconfigurable manufacturing system. Lastly, the impact of multiple sources of quality variations was studied on the cost, quality, and modularity performance of a reconfigurable manufacturing system. These findings can be compared with the real-time behaviour of such sources of quality variations and defects. The real-time behaviour of different defects can be analysed by using a Reconfigurable Integrated Manufacturing System (RIMS). RIMS can inspect and detect different sources of defects. Thus, the robustness of presented approaches and the accuracy of RIMS can be validated by comparing their respective findings.

# CONCLUSIONS AND RECOMMENDATIONS

*This chapter provides the concluding remarks and directions for future research. Section 5.1 contains the conclusion of the undertaken research problem involving cost, quality, and modularity. The conclusions are drawn in comparison to published literature on RMS process planning. In addition, both theoretical and practical contributions to the existing literature are presented. Section 5.2 offers a list of recommendations for future research and implications for practitioners. Since RMS is a complex subject, the recommendations will assist in highlighting the role of quality issues and variation on the performance of a manufacturing system. Thus, managers will readily be able to understand how quality impacts the overall process planning and the ways to reduce such variation. An emphasis has been given to design the RMS process planning in the context of the overall supply chain. This will enable an outward-looking approach by integrating different components of a business related to the manufacturing system.*

## 5.1. Conclusions

Reconfigurable manufacturing system has been in research focus for more than two decades. It offers the advantages of high throughput, product variety, and cost-optimal production. Thus, it has surpassed the efficiency of other manufacturing systems due to such advantages. This subject area has received an overwhelmed amount of research contributions in recent times. These contributions have helped in advancing the scope and applicability of reconfigurable manufacturing systems. For example, it has been safeguarded against cost-inefficiency, unnecessary downtime, extra production time, and the excess need for reconfiguration effort. However, an RMS has not been designed keeping in view the quality requirements. Compared to other manufacturing systems, it is more difficult to assess the quality of RMS due to its complex nature. The complexity of reconfigurable manufacturing systems can be attributed to the following reasons:

- RMS is a result of the combination of machines, modules, configurations, Tool Approach Directions (TADs), and tools which makes it a complex manufacturing system. As shown in Figure 33, to change from the existing RMS production setup to a modified production setup, TADs, modules, tools, and configuration might need a change. Thus, it becomes difficult to analyse the impact of different aspects on the quality performance of production in RMS.

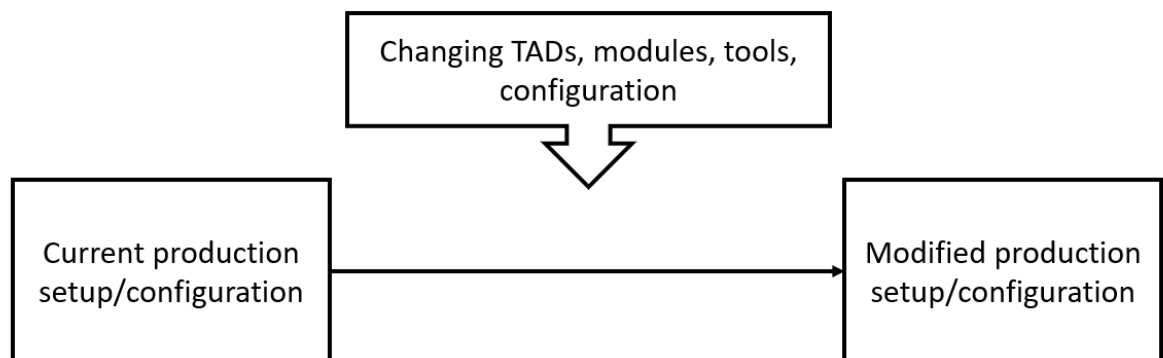

Figure 33. Changing needs from the current production setup to a modified production setup.

- The same operation can be performed by different candidate reconfigurable machines. In other words, a product or an operation can follow different production routes. This makes it difficult to analyse the product quality through each production route. In addition, reconfigurable machines can be designed in serial, parallel, or a combination of series and parallel which further enhances the complexity of RMS design.

The complex nature of RMS makes it difficult to analyse its quality of production compared to other manufacturing systems. An important problem addressed in the field of RMS is process planning which assigns configurations to different operations by optimizing certain objective functions such as cost, time, responsiveness, etc. Though the existing RMS process planning literature focuses on analysing the cost, time, modularity, etc. **there is a dearth of research that considers the quality, variation, and defect-based performance of a reconfigurable manufacturing system.**

**This study analysed the impact of quality variation on the performance of process planning in a reconfigurable manufacturing system.** A multi-objective model containing the Total Cost, the Quality Decay Index, and the Modular Effort was presented. All these objective functions were defined keeping in view the quality and variation of a reconfigurable manufacturing system. For instance, the objective function of Total Cost contained the costs related to quality such as scrap and re-work costs. In addition, the Quality Decay Index was defined in terms of conforming and failed products delivered by a process plan. Lastly, the Modularity Effort was based on the efforts lost during the modular reconfiguration and the efforts lost due to the production of failed operation units.

A hybrid version of NSGA-II-MOPSO was used for implementing the model. The hybridization of both heuristics ensured a positive reinforcement of each algorithm in enhancing the overall performance of the solution approach. To avoid the local optima, hybrid NSGA-II-MOPSO divided the search space into exploration and exploitation zones. The exploration task was performed by NSGA-II by considering half of the population. This half was improved by the algorithm by using the ranking of non-dominated solutions. The remaining half of the population was used by MOPSO for exploitation. It searched for improved solutions in the neighbourhood by guiding the lower-ranked solutions towards the global optimal solutions. A set of experiments revealed the higher efficiency of the hybrid solution approach. The findings suggested controlling quality variations and defects as it impacted different aspects of decision making. **The key findings of this research are reported as:**

- Although RMS is known for its cost-efficiency, it seems that the variation in quality and failed operation units impact the performance of RMS. Thus, it is imperative to safeguard it against different sources of variation to perform cost-optimally.
- A solution selected based on quality variation impacts the selection of solutions based on other objective functions. This means that quality plays an active role in designing a process plan which was otherwise selected based on cost, time modularity, etc. The findings suggest a trade-off between the objectives of cost, quality, and modularity. A process plan based on minimum quality variation affects the solutions of cost and modularity. This offers an opportunity as well as a challenge for the practitioner to balance the trade-off between the choice of different objective functions.
- The presence of quality variation results in a different process plan as opposed to a manufacturing system that does not contain any quality variation. Both models performed quite differently in terms of modular needs and the number of configurations.
- The results of the proposed models 1 and 2 indicate that both models result in different process plans. In addition, the Total Cost values of all solutions in Model 2 were less than the minimum Total Cost value of Model 1. This indicates that quality variation and defects can be very costly if not removed from a manufacturing system. Further, on average, fewer Modularity Effort scores were used by model 2 compared to Model 1. Thus, more modules will be added, subtracted, and re-adjusted if there are quality variation and defects. An oversized manufacturing system with extra resources will be thus needed owing to the issues related to quality. This highlights the role of quality variation in the selection of a process plan based on minimum cost and minimum modular effort.
- Practitioners are interested in enhancing the productivity of RMS by minimizing the ‘reconfiguration’ between different operations. The findings suggest that modular efforts and quality variation need to be simultaneously analysed to enhance the overall productivity and efficiency of a process plan.



- As variation and defects are inevitable in a real manufacturing setup, it is opportune to know the extra modular efforts needed due to such variation. This will enable a practitioner to decide at the outset, the number of extra modules added/subtracted/re-adjusted in the presence of variation. The findings of this paper apply to any real-life RMS system to calculate the extra modular needs in the presence of variation and defects.
- The proposed models and solution approaches are general, and they can be applied to multiple real-life RMS systems. For this, the acyclic graph, and operational details of the considered products will be required.
- The hybrid meta-heuristic approach was efficient compared to the stand-alone application of meta-heuristics. It resulted in uniformly distributed and dominant solutions due to the merger of solution storage capacities of both meta-heuristics. Further, the best improvement criterion works well; however, it takes more time in returning the solutions.
- The impact of multiple sources of variation was mathematically studied on the overall cost, quality, and modularity efficiency of process planning. The robustness of presented approaches and the accuracy of the Reconfigurable Integrated Manufacturing System (RIMS) can be validated by comparing their respective findings. RIMS can be used to obtain the real-time behaviour of RMS under quality variation and defects. This real-time behaviour can be compared with the results proposed by the presented mathematical model. In this way, the mathematical model can provide a theoretical insight on the performance of RMS subject to different quality-related issues.

To summarize, these findings highlight the role of quality variation in the selection of process planning. Though cost and modularity have been analysed in the published literature; however, none of the existing research relates both objective functions to the quality variation and defects in a reconfigurable manufacturing system. To this end, **this research considered novel aspects of quality in the cost and modularity-based RMS process planning design**. The objective function of cost contained novel components of scrap cost, re-work cost, and disruptive performance of machines related to quality issues. Similarly, the modularity objective function

was defined keeping in view the lost effort due to the production of failed operation units. This analysis can be further extended by analysing the costs related to machine downtime, worker error, scheduled and unscheduled maintenance. In addition to the modularity RMS characteristic, future research can embed other RMS characteristics such as scalability, diagnosability, customization, etc. in the presence of variation in quality. For example, the efficiency of scalability in RMS process planning can be analysed by addressing questions such as how difficultly or easily an RMS can be scaled up/down in the presence of variation in quality and defects?

## 5.2. Recommendations and Perspectives

To extend the scope of RMS process planning in future endeavours, some recommendations can act as a guideline to advance the rigor of process planning by undertaking more cutting-edge research requirements. These recommendations and perspectives are given as follows:

- The model was implemented for the case of a single product unit. The analysis can be extended and applied to multiple product process planning. RMS is an expensive manufacturing system, and it requires a heavy initial investment. Thus, it can be advantageous to carry out the process planning for multiple products to justify the investment in a reconfigurable manufacturing system.
- This research was based on apriori information of different aspects of the mathematical model. A deterministic model concerning production capacities, disruption, and failure rates was used. Future research can relax this assumption by considering stochastic parameters in the model. This will offer an opportunity to model the real-time behaviour of changing production capacities, dynamic disruption profiles, and stochastic failure rates. In this regard, fuzzy mathematical models and Markov chains can be used to capture the stochastic aspects.
- A pessimistic approach was adapted for the evaluation of different defects. In this regard, the Quality decay Index (QDI) was calculated for the worst configuration (pessimistic configuration), therefore, only a simple directed acyclic graph was required. Future research can calculate the decay in quality for all possible

configurations. This will require a thorough analysis of the overall causes of quality variation, disruption, and defects.

- The causes of quality variation i.e., machine, process, and tooling-related causes were calculated in isolation (Eqs. 5-7). This assumption can be modified by considering the interaction between different defects at the level of machine, process, and tool. In addition, the scope of process planning can be strengthened by simultaneously analysing different levels i.e., management, production, and machine level of a complex reconfigurable manufacturing system.
- In this work, the Non- Dominated Sorting Genetic Algorithm (NSGA-II), Multi-Objective Particle Swarm Optimization (MOPSO), and their hybrid form i.e., NSGA-II-MOPSO were used. The findings can be compared with other evolutionary approaches such as Whale Optimization Algorithm (WOA) and Strength Pareto Evolutionary Algorithm (SPEA-II). This practice can further highlight the computation power and solution efficiency of the proposed hybrid meta-heuristic.
- The input parameters of Multi-Objective Particle Swarm Optimization (MOPSO) were tuned by using a set of experiments. The tuning is an important phase as it ensures the optimal performance of a meta-heuristic. In future research, a self-adaptation approach for the refinement of input parameters of MOPSO which is a popular research technique may be adapted.
- In the implemented  $\varepsilon$  -constraint approach, the loop is completed when the epsilon values related to either Quality Decay Index (QDI) or Modularity Effort (ME) cannot be reduced anymore. This was done by using an ‘and’ operator between both epsilons. Future research can use an ‘or’ operator so that the epsilon values of both constraints can be saturated. This might result in improved solutions for a different set of problems.
- The presented analysis focused on the causes of variations during production. The pre-production cause of variation i.e., deficiency in the quality of raw materials can be modelled in future research. In this way, process planning can be carried out in

the context of the supply chain by analysing the quality of raw materials and supplier evaluation.

- This research compared the efficiency of different solution approaches by using the performance metrics of Inverted Generational Distance (IGD) and Hyper Volume (HV). Other performance metrics such as Spacing Metric (SM) and Diversity Metric (DM) can be used to further analyse the performance efficiency of various solution approaches.
- A meta-heuristic re-iterates to refine the non-dominated solutions up until the stopping criteria are reached. This research used two stopping criteria i.e., First Improvement (FI) and Best Improvement (BI). These criteria can be compared to the traditional criteria of the maximum number of iterations and computation (CPU) time to ascertain the robustness of the used stopping criteria.
- Sustainability is gaining increased attention in the process planning literature. It analyses the process planning by considering the greenhouse gases (GHG), liquid and solid wastes, etc. As such aspects are also related to the overall quality of manufacturing, there is an active opportunity to propose a model which simultaneously considers the quality and sustainability in RMS process planning.
- The process planning literature lacks in analysing the role of the supply chain. A manufacturing system operates in close collaboration with the supply chain partners. As shown in Figure 34, on the one hand, it deals with the supplier for acquiring raw material while on the other hand, it provides finished products to the distribution points and customers. Thus, it is important to design a manufacturing system in the context of the supply chain. This kind of analysis is well established in the literature of other manufacturing systems. As an illustration, in [133], the authors analysed the impact of machine disruption on the performance of cost and emission in a supply chain network. The results indicated that the selection of different production machines impacted the values of objective functions and the performance of the supply chain. The existing process planning literature focuses on an inward-looking approach where the impact of different configurations, modules, tools, etc. is analysed on the performance efficiency of a reconfigurable manufacturing system. Future research can adopt an outward-looking approach

where the process planning is carried out keeping in view its impact on the efficiency of the overall supply chain. Further, to enhance the scope of sustainable practices in the process planning, recollection, and remanufacturing of end-of-life products can also be considered. Thus, quality and supply chain issues can be linked in the process planning.

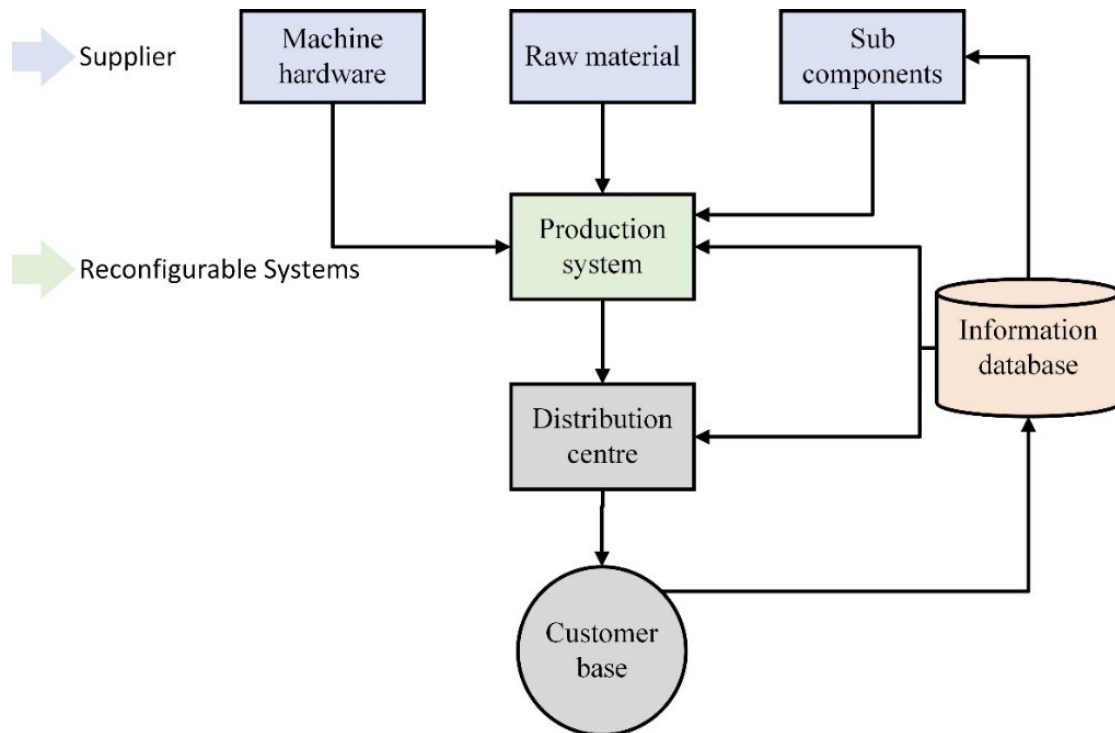

Figure 34. A typical supply chain of the production system (adapted from [27])

- More studies need to model the role of the human operator, as the assignment of a human operator to different machines can impact the quality of process planning. Further, more research focus is needed to enhance the performance of process planning subject to random errors, machine downtime, etc. This can be done by considering the diagnosability characteristic of a reconfigurable manufacturing system.
- The RMS process planning literature shows that genetic algorithms have been frequently applied to process planning problems. Compared to genetic algorithms, there are other solution approaches that are efficient, and their applications to process planning problems can be increased. For instance, Simulated Annealing (SA) has relatively fewer applications in the process planning problems. SA is a probabilistic approach, and it is computationally efficient, can deal with large size

problems, can avoid the trap of local optima, and is easier to implement. Furthermore, an increased application of hybrid heuristics to process planning problems can provide improved solutions.

## References

1. Koren, Y., Heisel, U., Jovane, F., Moriwaki, T., Pritschow, G., Ulsoy, G., & Van Brussel, H. (1999). Reconfigurable manufacturing systems. *CIRP annals*, 48(2), 527-540.
2. Koren, Y. (2006). General RMS characteristics. Comparison with dedicated and flexible systems. In *Reconfigurable manufacturing systems and transformable factories* (pp. 27-45). Springer, Berlin, Heidelberg.
3. Koren, Y., Gu, X., & Guo, W. (2018). Reconfigurable manufacturing systems: Principles, design, and future trends. *Frontiers of Mechanical Engineering*, 13(2), 121-136.
4. Koren, Y., Gu, X., & Guo, W. (2018). Choosing the system configuration for high-volume manufacturing. *International Journal of Production Research*, 56(1-2), 476-490.
5. Whitney, D. E. (2004). Mechanical assemblies: their design, manufacture, and role in product development (Vol. 1). *New York: Oxford university press*.
6. Musharavati, F., & Hamouda, A. S. M. (2012). Enhanced simulated-annealing-based algorithms and their applications to process planning in reconfigurable manufacturing systems. *Advances in Engineering Software*, 45(1), 80-90.
7. Cochran, D. S., Arinez, J. F., Duda, J. W., & Linck, J. (2001). A decomposition approach for manufacturing system design. *Journal of manufacturing systems*, 20(6), 371-389.
8. Spearman, M. L., & Hopp, W. J. (1996). *Factory Physics: Foundations of Manufacturing Management*. Irwin, Chicago, IL, 439.
9. Shaik, A. M., Rao, V. K., & Rao, C. S. (2015). Development of modular manufacturing systems—a review. *The International Journal of Advanced Manufacturing Technology*, 76(5-8), 789-802.
10. Rösiö, C., & Säfsten, K. (2013). Reconfigurable production system design—theoretical and practical challenges. *Journal of Manufacturing Technology Management*.
11. Gilbert, C. (1989). Modular manufacturing sizzle or steak. *Apparel Research Notes, American Apparel Manufacturers Association*, 8(5).
12. Gurusurthy, J. P. (1998). Life-cycle modularity in product design (*Doctoral dissertation, University of Alabama*).

13. Chen, L., Xi, F., & Macwan, A. (2005). Optimal module selection for preliminary design of reconfigurable machine tools. *J. Manuf. Sci. Eng.*, *127*(1), 104-115.
14. Farid, A. M. (2008). Facilitating ease of system reconfiguration through measures of manufacturing modularity. *Proceedings of the Institution of Mechanical Engineers, Part B: Journal of Engineering Manufacture*, *222*(10), 1275-1288.
15. Benderbal, H. H., Dahane, M., & Benyoucef, L. (2018). Modularity assessment in reconfigurable manufacturing system (RMS) design: an Archived Multi-Objective Simulated Annealing-based approach. *The International Journal of Advanced Manufacturing Technology*, *94*(1), 729-749.
16. Massimi, E., Khezri, A., Benderbal, H. H., & Benyoucef, L. (2020). A heuristic-based non-linear mixed integer approach for optimizing modularity and integrability in a sustainable reconfigurable manufacturing environment. *The International Journal of Advanced Manufacturing Technology*, *108*, 1997-2020.
17. Lameche, K., Najid, N. M., Castagna, P., & Kouiss, K. (2017). Modularity in the design of reconfigurable manufacturing systems. *IFAC-PapersOnLine*, *50*(1), 3511-3516.
18. Youssef, A. M., & ElMaraghy, H. A. (2007). Optimal configuration selection for reconfigurable manufacturing systems. *International Journal of Flexible Manufacturing Systems*, *19*(2), 67-106.
19. Battaïa, O., Dolgui, A., & Guschinsky, N. (2020). Optimal cost design of flow lines with reconfigurable machines for batch production. *International Journal of Production Research*, *58*(10), 2937-2952.
20. Moghaddam, S. K., Houshmand, M., Saitou, K., & Fatahi Valilai, O. (2020). Configuration design of scalable reconfigurable manufacturing systems for part family. *International Journal of Production Research*, *58*(10), 2974-2996.
21. Deif, A. M., & ElMaraghy, W. (2007). Investigating optimal capacity scalability scheduling in a reconfigurable manufacturing system. *The International Journal of Advanced Manufacturing Technology*, *32*(5-6), 557-562.
22. Dou, J., Li, J., & Su, C. (2016). Bi-objective optimization of integrating configuration generation and scheduling for reconfigurable flow lines using NSGA-II. *The International Journal of Advanced Manufacturing Technology*, *86*(5), 1945-1962.
23. Bensmaine, A., Dahane, M., & Benyoucef, L. (2013). A non-dominated sorting genetic algorithm-based approach for optimal machines selection in reconfigurable manufacturing environment. *Computers & Industrial Engineering*, *66*(3), 519-524.
24. Goyal, K. K., Jain, P. K., & Jain, M. (2012). Optimal configuration selection for reconfigurable manufacturing system using NSGA II and TOPSIS. *International Journal of Production Research*, *50*(15), 4175-4191.
25. Bensmaine, A., Dahane, M., & Benyoucef, L. (2011, September). Simulation-based NSGA-II approach for multi-unit process plans generation in reconfigurable manufacturing system. In *ETFA2011* (pp. 1-8). IEEE.

26. Zhao, J., Si, S., & Cai, Z. (2019). A multi-objective reliability optimization for reconfigurable systems considering components degradation. *Reliability Engineering & System Safety*, 183, 104-115.
27. Chaube, A., Benyoucef, L., & Tiwari, M. K. (2012). An adapted NSGA-2 algorithm based dynamic process plan generation for a reconfigurable manufacturing system. *Journal of Intelligent Manufacturing*, 23(4), 1141-1155.
28. Saxena, L. K., & Jain, P. K. (2012). A model and optimisation approach for reconfigurable manufacturing system configuration design. *International Journal of Production Research*, 50(12), 3359-3381.
29. Dou, J., Su, C., & Zhao, X. (2020). Mixed integer programming models for concurrent configuration design and scheduling in a reconfigurable manufacturing system. *Concurrent Engineering*, 28(1), 32-46.
30. Touzout, F. A., & Benyoucef, L. (2019). Multi-objective sustainable process plan generation in a reconfigurable manufacturing environment: exact and adapted evolutionary approaches. *International Journal of Production Research*, 57(8), 2531-2547.
31. Khezri, A., Benderbal, H. H., & Benyoucef, L. (2020). Towards a sustainable reconfigurable manufacturing system (SRMS): multi-objective-based approaches for process plan generation problem. *International Journal of Production Research*, 1-26.
32. Taguchi, G., & Rafanelli, A. J. (1994). Taguchi on robust technology development: bringing quality engineering upstream. 161
33. Thornton, A. C. (1999). A mathematical framework for the key characteristic process. *Research in engineering design*, 11(3), 145-157.
34. Stamatis, D. H. (2003). Failure mode and effect analysis: FMEA from theory to execution. *Quality Press*.
35. Mahto, D., & Kumar, A. (2008). Application of root cause analysis in improvement of product quality and productivity. *Journal of Industrial Engineering and Management (JIEM)*, 1(2), 16-53.
36. Zheng, L. Y., Liu, Q., & McMahan, C. A. (2010). Integration of process FMEA with product and process design based on key characteristics. In *Proceedings of the 6th CIRP-sponsored international conference on digital enterprise technology* (pp. 1673-1686). Springer, Berlin, Heidelberg.
37. Srinivasan, V. (1999, September). On interpreting key characteristics. In *Proceeding of the 1999 ASME Design Engineering Technical Conferences, September* (pp. 12-15).
38. Khorramshahgol, R., & Djavanshir, G. R. (2008). The application of analytic hierarchy process to determine proportionality constant of the Taguchi quality loss function. *IEEE Transactions on Engineering Management*, 55(2), 340-348.



39. Loose, J. P., Zhou, S., & Ceglarek, D. (2008). Variation source identification in manufacturing processes based on relational measurements of key product characteristics. *Journal of Manufacturing Science and Engineering*, 130(3).
40. Schmitz, B. (1997). Practicing tolerance. *CAE*, 16(9), 12.
41. Thornton, A. C. (1999). A mathematical framework for the key characteristic process. *Research in engineering design*, 11(3), 145-157.
42. Thornton, A. C. (2000). Quantitative selection of variation reduction plans. *J. Mech. Des.*, 122(2), 185-193.
43. Hsu, L. F., & Tapiero, C. S. (1989). Quality control of an unreliable flexible manufacturing system with scrapping and infinite buffer capacity. *International journal of flexible manufacturing systems*, 1(4), 325-346.
44. Karsak, E. E., & Kuzgunkaya, O. (2002). A fuzzy multiple objective programming approach for the selection of a flexible manufacturing system. *International journal of production economics*, 79(2), 101-111.
45. Li, J., & Huang, N. (2007). Quality evaluation in flexible manufacturing systems: A Markovian approach. *Mathematical Problems in Engineering*, 2007.
46. Souier, M., Dahane, M., & Maliki, F. (2019). An NSGA-II-based multiobjective approach for real-time routing selection in a flexible manufacturing system under uncertainty and reliability constraints. *The International Journal of Advanced Manufacturing Technology*, 100(9), 2813-2829.
47. Mittal, K. K., & Jain, P. K. (2014). An overview of performance measures in reconfigurable manufacturing system. *Procedia engineering*, 69, 1125-1129.
48. Cochran, D., & Rudolf, H. (2003). Investment and resource allocation Methodology to support manufacturing system Design Implementation. *Journal of Manufacturing Systems CIRP*.
49. Cochran, D. S., Jafri, M. U., Chu, A. K., & Bi, Z. (2016). Incorporating design improvement with effective evaluation using the Manufacturing System Design Decomposition (MSDD). *Journal of Industrial Information Integration*, 2, 65-74.
50. Dou, J., Li, J., Xia, D., & Zhao, X. (2020). A multi-objective particle swarm optimisation for integrated configuration design and scheduling in reconfigurable manufacturing system. *International Journal of Production Research*, 1-21.
51. Garbie, I. H. (2014). A methodology for the reconfiguration process in manufacturing systems. *Journal of Manufacturing Technology Management*.
52. Dou, J., Su, C., & Zhao, X. (2020). Mixed integer programming models for concurrent configuration design and scheduling in a reconfigurable manufacturing system. *Concurrent Engineering*, 28(1), 32-46.

53. Hasan, F., Jain, P. K., & Kumar, D. (2013). Service Level as Performance Indicator for Multiple Part Families in a Reconfigurable Manufacturing System. *Journal of Mechanical Engineering and Sciences (JMES)*, 5, 709-719.
54. Zheng, L., Zhu, L., Wang, B., & Bai, L. (2013, December). A simulation analysis of facility layout problems in reconfigurable manufacturing systems. In *2013 International Conference on Computer Sciences and Applications* (pp. 423-427). IEEE.
55. Abbasi, M., & Houshmand, M. (2011). Production planning and performance optimization of reconfigurable manufacturing systems using genetic algorithm. *The International Journal of Advanced Manufacturing Technology*, 54(1-4), 373-392.
56. Li, A., & Xie, N. (2006, June). A robust scheduling for reconfigurable manufacturing system using petri nets and genetic algorithm. In *2006 6th World Congress on Intelligent Control and Automation* (Vol. 2, pp. 7302-7306). IEEE.
57. Asghar, E., uz Zaman, U. K., Baqai, A. A., & Homri, L. (2018). Optimum machine capabilities for reconfigurable manufacturing systems. *The International Journal of Advanced Manufacturing Technology*, 95(9), 4397-4417.
58. Belaiche, L., & Kahloul, L. (2017, December). The optimal process planning for reconfigurable manufacturing systems. In *2017 International Conference on Mathematics and Information Technology (ICMIT)* (pp. 309-316). IEEE.
59. Belaiche, L., Kahloul, L., Benharzallah, S., & Hafidi, Y. (2018). Multi-Objective Optimization-Based Approach for Throughput Maximization in Reconfigurable Manufacturing Systems. In *2018 Fifth International Symposium on Innovation in Information and Communication Technology (ISIICT)* (pp. 1-8). IEEE.
60. Benderbal, H. H., Dahane, M., & Benyoucef, L. (2015, October). A new robustness index formachines selection in Reconfigurable Manufacturing system. In *2015 International Conference on Industrial Engineering and Systems Management (IESM)* (pp. 1019-1026). IEEE.
61. Benderbal, H. H., Dahane, M., & Benyoucef, L. (2018). Exhaustive search based heuristic for solving machine layout problem in reconfigurable manufacturing system design. *IFAC-PapersOnLine*, 51(11), 78-83.
62. Bensmaine, A., Dahane, M., & Benyoucef, L. (2014). A new heuristic for integrated process planning and scheduling in reconfigurable manufacturing systems. *International Journal of Production Research*, 52(12), 3583-3594.
63. Bhargav, A., Sridhar, C. N. V., & Kumar, M. D. (2017). Study of production scheduling problem for reconfigurable manufacturing system (RMS). *Materials Today: Proceedings*, 4(8), 7406-7412.
64. Borisovsky, P. A., Delorme, X., & Dolgui, A. (2013). Genetic algorithm for balancing reconfigurable machining lines. *Computers & Industrial Engineering*, 66(3), 541-547.
65. Xing, B., Nelwamondo, F. V., Gao, W., & Marwala, T. (2009, January). Application of artificial intelligence (AI) methods for designing and analysis of reconfigurable cellular manufacturing

- system (RCMS). In *2009 2nd International Conference on Adaptive Science & Technology (ICAST)* (pp. 402-409). IEEE.
66. Carlo, H. J., Patrick Spicer, J., & Rivera-Silva, A. (2012). Simultaneous consideration of scalable-reconfigurable manufacturing system investment and operating costs. *Journal of manufacturing science and engineering*, 134(1).
  67. Choi, Y. C., & Xirouchakis, P. (2015). A holistic production planning approach in a reconfigurable manufacturing system with energy consumption and environmental effects. *International Journal of Computer Integrated Manufacturing*, 28(4), 379-394.
  68. Mittal, K. K., & Jain, P. K. (2014, December). Impact of reconfiguration effort on reconfigurable manufacturing system. In *5th International and 26th All India Manufacturing Technology, Design and Research Conference (AIMTDR), IIT Guwahati, Assam, India* (pp. 12-14).
  69. Dahane, M., & Benyoucef, L. (2016). An adapted NSGA-II algorithm for a reconfigurable manufacturing system (RMS) design under machines reliability constraints. In *Metaheuristics for production systems* (pp. 109-130). Springer, Cham.
  70. Delorme, X., Malyutin, S., & Dolgui, A. (2016). A multi-objective approach for design of reconfigurable transfer lines. *IFAC-PapersOnLine*, 49(12), 509-514.
  71. Dou, J., Dai, X., & Meng, Z. (2010). Optimisation for multi-part flow-line configuration of reconfigurable manufacturing system using GA. *International Journal of Production Research*, 48(14), 4071-4100.
  72. Yamada, Y. (2006, May). Dynamic reconfiguration of reconfigurable manufacturing systems using particle swarm optimization. In *Proceedings 2006 IEEE International Conference on Robotics and Automation, 2006. ICRA 2006.* (pp. 1444-1449). IEEE.
  73. Elmasry, S. S., Youssef, A. M., & Shalaby, M. A. (2014). Investigating best capacity scaling policies for different reconfigurable manufacturing system scenarios. *Procedia CIRP*, 17, 410-415.
  74. Galan, R., Racero, J., Eguia, I., & Garcia, J. M. (2007). A systematic approach for product families formation in Reconfigurable Manufacturing Systems. *Robotics and Computer-Integrated Manufacturing*, 23(5), 489-502.
  75. Goyal, K. K., Jain, P. K., & Jain, M. (2013). A novel methodology to measure the responsiveness of RMTs in reconfigurable manufacturing system. *Journal of Manufacturing Systems*, 32(4), 724-730.
  76. Goyal, K. K., & Jain, P. K. (2016). Design of reconfigurable flow lines using MOPSO and maximum deviation theory. *The International Journal of Advanced Manufacturing Technology*, 84(5-8), 1587-1600.
  77. Guan, X., Dai, X., Qiu, B., & Li, J. (2012). A revised electromagnetism-like mechanism for layout design of reconfigurable manufacturing system. *Computers & Industrial Engineering*, 63(1), 98-108.

78. Gupta, A., Jain, P. K., & Kumar, D. (2014). Part family formation for reconfigurable manufacturing system using K-means algorithm. *International Journal of Internet Manufacturing and Services* 25, 3(3), 244-262.
79. Gupta, A., Jain, P. K., & Kumar, D. (2015). Configuration selection of reconfigurable manufacturing system based on performance. *International Journal of Industrial and Systems Engineering*, 20(2), 209-230.
80. Haddou-Benderbal, H., Dahane, M., & Benyoucef, L. (2016). Hybrid heuristic to minimize machine's unavailability impact on reconfigurable manufacturing system using reconfigurable process plan. *IFAC-PapersOnLine*, 49(12), 1626-1631.
81. Haddou Benderbal, H., Dahane, M., & Benyoucef, L. (2017). Flexibility-based multi-objective approach for machines selection in reconfigurable manufacturing system (RMS) design under unavailability constraints. *International Journal of Production Research*, 55(20), 6033-6051.
82. Haddou-Benderbal, H., Dahane, M., & Benyoucef, L. (2017). Layout evolution effort for product family in Reconfigurable Manufacturing System design. *IFAC-PapersOnLine*, 50(1), 10166-10171.
83. Benderbal, H. H., & Benyoucef, L. (2019). Machine layout design problem under product family evolution in reconfigurable manufacturing environment: a two-phase-based AMOSA approach. *The International Journal of Advanced Manufacturing Technology*, 104(1), 375-389.
84. Hasan, F., Jain, P. K., & Kumar, D. (2014). Optimum configuration selection in Reconfigurable Manufacturing System involving multiple part families. *Opsearch*, 51(2), 297-311.
85. Hasan, F., Jain, P. K., & Kumar, D. (2014). Service level as performance index for reconfigurable manufacturing system involving multiple part families. *Procedia Engineering*, 69, 814-821.
86. Hasan, F., & Jain, P. K. (2015). Genetic Modelling for selecting optimal machine configurations in reconfigurable manufacturing system. In *Applied Mechanics and Materials* (Vol. 789, pp. 1229-1239). Trans Tech Publications Ltd.
87. Hasan, F., Jain, P. K., & Kumar, D. (2016). Scalability of reconfigurable manufacturing systems based on bowl phenomenon: an implication of modular machines. *International Journal of Industrial and Systems Engineering*, 22(1), 73-95.
88. Hees, A., Bayerl, C., Van Vuuren, B., Schutte, C. S., Braunreuther, S., & Reinhart, G. (2017). A production planning method to optimally exploit the potential of reconfigurable manufacturing systems. *Procedia CIRP*, 62, 181-186.
89. Houimli, M., Kahloul, L., & Khalgui, M. (2017, December). Multi-objective optimization and formal specification of reconfigurable manufacturing system using adaptive NSGA-II. In *2017 First International Conference on Embedded & Distributed Systems (EDiS)* (pp. 1-6). IEEE.
90. Huang, S., Wang, G., & Yan, Y. (2019). Delayed reconfigurable manufacturing system. *International Journal of Production Research*, 57(8), 2372-2391.

91. Huang, S., & Yan, Y. (2019). Part family grouping method for reconfigurable manufacturing system considering process time and capacity demand. *Flexible Services and Manufacturing Journal*, 31(2), 424-445.
92. Garbie, I. H. (2008). A quantitative performance measurement regarding reconfigurable manufacturing systems. In *IIE Annual Conference. Proceedings* (p. 734). Institute of Industrial and Systems Engineers (IISE).
93. Khezri, A., Benderbal, H. H., & Benyoucef, L. (2019, September). A sustainable reconfigurable manufacturing system designing with focus on environmental hazardous wastes. In *2019 24th IEEE International Conference on Emerging Technologies and Factory Automation (ETFA)* (pp. 317-324). IEEE.
94. Koren, Y., Wang, W., & Gu, X. (2017). Value creation through design for scalability of reconfigurable manufacturing systems. *International Journal of Production Research*, 55(5), 1227-1242.
95. Nourelfath, M., Ait-Kadi, D., & Soro, I. (2002, October). Optimal design of reconfigurable manufacturing systems. In *IEEE international conference on systems, man and cybernetics* (Vol. 3, pp. 6-pp). IEEE.
96. Asghar, E., Baqai, A. A., & Zaman, U. K. U. (2015). Performance of NSGA-II and WGA in macro level process planning considering reconfigurable manufacturing system. In *Proceedings of 25th International Conference on Flexible Automation and Intelligent Manufacturing* (Vol. 2, pp. 320-327).
97. Kumar, A., Pattanaik, L. N., & Agrawal, R. (2019). Multi-objective Scheduling Model for Reconfigurable Assembly Systems. In *Innovations in Soft Computing and Information Technology* (pp. 209-217). Springer, Singapore.
98. Yamada, Y., Ookoudo, K., & Komura, Y. (2003, October). Layout optimization of manufacturing cells and allocation optimization of transport robots in reconfigurable manufacturing systems using particle swarm optimization. In *Proceedings 2003 IEEE/RSJ International Conference on Intelligent Robots and Systems (IROS 2003) (Cat. No. 03CH37453)* (Vol. 2, pp. 2049-2054). IEEE.
99. Liles, D. H., & Huff, B. L. (1990). A computer-based production scheduling architecture suitable for driving a reconfigurable manufacturing system. *Computers & Industrial Engineering*, 19(1-4), 1-5.
100. Liu, W., & Liang, M. (2008). Multi-objective design optimization of reconfigurable machine tools: a modified fuzzy-Chebyshev programming approach. *International Journal of Production Research*, 46(6), 1587-1618.
101. Liu, M., An, L., Zhang, J., Chu, F., & Chu, C. (2019). Energy-oriented bi-objective optimisation for a multi-module reconfigurable manufacturing system. *International Journal of Production Research*, 57(19), 5974-5995.

102. Xiong, H., Chen, M., Lin, Y., Lv, C., Li, A., & Xu, L. (2010). Research and optimization of reconfigurable manufacturing system configuration based on system reliability. *Kybernetes*.
103. Maniraj, M., Pakkirisamy, V., & Jeyapaul, R. (2017). An ant colony optimization–based approach for a single-product flow-line reconfigurable manufacturing systems. *Proceedings of the Institution of Mechanical Engineers, Part B: Journal of Engineering Manufacture*, 231(7), 1229-1236.
104. Mittal, K. K., & Jain, P. K. (2014). An overview of performance measures in reconfigurable manufacturing system. *Procedia engineering*, 69, 1125-1129.
105. Mittal, K. K., Kumar, D., & Jain, P. K. (2018). A systematic approach for optimum configuration selection in reconfigurable manufacturing system. *Journal of The Institution of Engineers (India): Series C*, 99(6), 629-635.
106. Azab, A., & Naderi, B. (2015). Modelling the problem of production scheduling for reconfigurable manufacturing systems. *Procedia CIRP*, 33, 76-80.
107. Moghaddam, S. K., Houshmand, M., & Fatahi Valilai, O. (2018). Configuration design in scalable reconfigurable manufacturing systems (RMS); a case of single-product flow line (SPFL). *International Journal of Production Research*, 56(11), 3932-3954.
108. Musharavati, F., & Hamouda, A. M. S. (2012). Simulated annealing with auxiliary knowledge for process planning optimization in reconfigurable manufacturing. *Robotics and Computer-Integrated Manufacturing*, 28(2), 113-131.
109. Musharavati, F., & Hamouda, A. S. M. (2012). Enhanced simulated-annealing-based algorithms and their applications to process planning in reconfigurable manufacturing systems. *Advances in Engineering Software*, 45(1), 80-90.
110. Nourelfath, M., Ait-kadi, D., & Soro, W. I. (2003). Availability modelling and optimization of reconfigurable manufacturing systems. *Journal of quality in maintenance engineering*.
111. Petroodi, S. E. H., Eynaud, A. B. D., Klement, N., & Tavakkoli-Moghaddam, R. (2019). Simulation-based optimization approach with scenario-based product sequence in a reconfigurable manufacturing system (RMS): A case study. *IFAC-PapersOnLine*, 52(13), 2638-2643.
112. Renna, P. (2017). Decision-making method of reconfigurable manufacturing systems' reconfiguration by a Gale-Shapley model. *Journal of manufacturing systems*, 45, 149-158.
113. Saliba, M. A., Azzopardi, S., Pace, C., & Zammit, D. (2019). A heuristic approach to module synthesis in the design of reconfigurable manufacturing systems. *The International Journal of Advanced Manufacturing Technology*, 102(9), 4337-4359.
114. Touzout, F. A., & Benyoucef, L. (2019). Multi-objective multi-unit process plan generation in a reconfigurable manufacturing environment: a comparative study of three hybrid metaheuristics. *International Journal of Production Research*, 57(24), 7520-7535.
115. Wang, W., & Koren, Y. (2012). Scalability planning for reconfigurable manufacturing systems. *Journal of manufacturing systems*, 31(2), 83-91.

116. Wang, G. X., Huang, S. H., Yan, Y., & Du, J. J. (2017). Reconfiguration schemes evaluation based on preference ranking of key characteristics of reconfigurable manufacturing systems. *The International Journal of Advanced Manufacturing Technology*, 89(5), 2231-2249.
117. Wei, X., Yuan, S., & Ye, Y. (2019). Optimizing facility layout planning for reconfigurable manufacturing system based on chaos genetic algorithm. *Production & Manufacturing Research*, 7(1), 109-124.
118. Xiaobo, Z., Jiancai, W., & Zhenbi, L. (2000). A stochastic model of a reconfigurable manufacturing system Part 1: A framework. *International Journal of Production Research*, 38(10), 2273-2285.
119. Yamada, Y., & Lei, J. (2006, October). Reconfiguration process design of a reconfigurable manufacturing system using particle swarm optimization. In *The Proceedings of the Multiconference on "Computational Engineering in Systems Applications"* (Vol. 1, pp. 1012-1019). IEEE.
120. Yigit, A. S., Ulsoy, A. G., & Allahverdi, A. (2002). Optimizing modular product design for reconfigurable manufacturing. *Journal of Intelligent Manufacturing*, 13(4), 309-316.
121. Yigit, A. S., & Allahverdi, A. (2003). Optimal selection of module instances for modular products in reconfigurable manufacturing systems. *International Journal of Production Research*, 41(17), 4063-4074.
122. Youssef, A. M., & ElMaraghy, H. A. (2006). Assessment of manufacturing systems reconfiguration smoothness. *The International Journal of Advanced Manufacturing Technology*, 30(1-2), 174-193.
123. Zhao, F., Hong, Y., Yu, D., Yang, Y., Zhang, Q., & Yi, H. (2007). A hybrid algorithm based on particle swarm optimization and simulated annealing to holon task allocation for holonic manufacturing system. *The International Journal of Advanced Manufacturing Technology*, 32(9-10), 1021-1032.
124. Jaszkiwicz, A., & Lust, T. (2017). Proper balance between search towards and along Pareto front: biobjective TSP case study. *Annals of Operations Research*, 254(1), 111-130.
125. Dou, J., Su, C., & Zhao, X. (2020). Mixed integer programming models for concurrent configuration design and scheduling in a reconfigurable manufacturing system. *Concurrent Engineering*, 28(1), 32-46.
126. Sundaram, A. (2020). Combined heat and power economic emission dispatch using hybrid NSGA II-MOPSO algorithm incorporating an effective constraint handling mechanism. *IEEE Access*, 8, 13748-13768.
127. Renzi, C., Leali, F., Cavazzuti, M., & Andrisano, A. O. (2014). A review on artificial intelligence applications to the optimal design of dedicated and reconfigurable manufacturing systems. *The International Journal of Advanced Manufacturing Technology*, 72(1-4), 403-418.

128. Khan, A. S., Homri, L., Dantan, J. Y., & Siadat, A. (2020). Cost and Quality assessment of a Disruptive Reconfigurable Manufacturing System based on MOPSO metaheuristic. *IFAC-PapersOnLine*, 53(2), 10431-10436.
129. Eberhart, R., & Kennedy, J. (1995, October). A new optimizer using particle swarm theory. In *MHS'95. Proceedings of the Sixth International Symposium on Micro Machine and Human Science* (pp. 39-43). Ieee.
130. Coello, C. A. C., Pulido, G. T., & Lechuga, M. S. (2004). Handling multiple objectives with particle swarm optimization. *IEEE Transactions on evolutionary computation*, 8(3), 256-279.
131. Deb, K. (2011). Multi-objective optimisation using evolutionary algorithms: an introduction. In *Multi-objective evolutionary optimisation for product design and manufacturing* (pp. 3-34). Springer, London.
132. Dantan, J. Y., Hassan, A., Etienne, A., Siadat, A., & Martin, P. (2008). Information modelling for variation management during the product and manufacturing process design. *International Journal on Interactive Design and Manufacturing (IJIDeM)*, 2(2), 107-118.
133. Khan, A. S., Pruncu, C. I., Khan, R., Naeem, K., Ghaffar, A., Ashraf, P., & Room, S. (2020). A Trade-Off Analysis of Economic and Environmental Aspects of a Disruption Based Closed-Loop Supply Chain Network. *Sustainability*, 12(17), 7056.
134. Khan, A. S., Homri, L., Dantan, J. Y., & Siadat, A. (2021). Modularity-based quality assessment of a disruptive reconfigurable manufacturing system-A hybrid meta-heuristic approach. *The International Journal of Advanced Manufacturing Technology*, 1-24.



# Appendix A

## *The role of the directed and non-oriented graphs in modeling quality:*

As discussed earlier, the difference in modeling impacts the complexity of the quality assessment of a process plan or a reconfigurable process plan. The quality of the manufacturing system can be understood by analyzing the cause and effect (also known as causality) between different components of a manufacturing system. The quality of a particular product aspect can be affected by more than one variable. For instance, as shown in Figure A1, there are multiple product/part Key Characteristics (KCs) and multiple process Key Characteristics (KCs). It can be observed that  $y_1$  can be affected (or its quality varies) by variation in either the change in cause variable(s)  $x_1$  or/and  $x_2$ . In such a case, it becomes difficult to establish the causal mechanism between different variables due to confounding and exogenous effect of variables. Thus, a causal mechanism can only be established by carefully designing a controlled environment where only limited/defined independent variables can cause variation in the variables of interest [132]. In the presented analysis, the quality variable i.e., Quality decay Index (QDI) is calculated for the worst configuration (pessimistic configuration), therefore, only a simple directed acyclic graph is required.

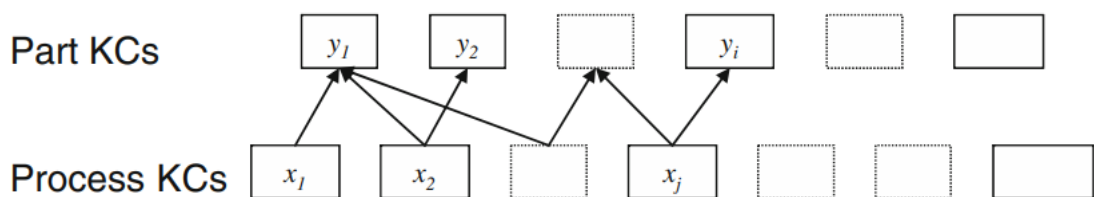

Figure A1. Causality between different KCs (adapted from [132])

*The encoding and decoding schemes:*

An encoding scheme is used for coding the input information prior to the execution of the algorithm. The input and output information in this research is at the level of machine, module, feature, operation, and its quality characteristic. Thus, a 5-by-n matrix is constructed for the purpose of encoding the problem where rows=5 and columns=n (n is the number of operations to be assigned). In addition, a unique quality characteristic is assigned to an operation. The description of encoding process is provided in Figure A2. We assume that the gene value of 0.31 and quality characteristic value of 0.34 corresponds to operation 1. From Table 8, there are six candidate configurations to perform operation 1 (feature 1). Thus, the gene value of 0.31 is multiplied by 6 and the resulting value is rounded off to 2. This helps in deciding the position of configuration (M4) that will perform operation 1. Accordingly, all remaining information is decoded for all operations of a feature, as shown at the bottom of Figure A2.

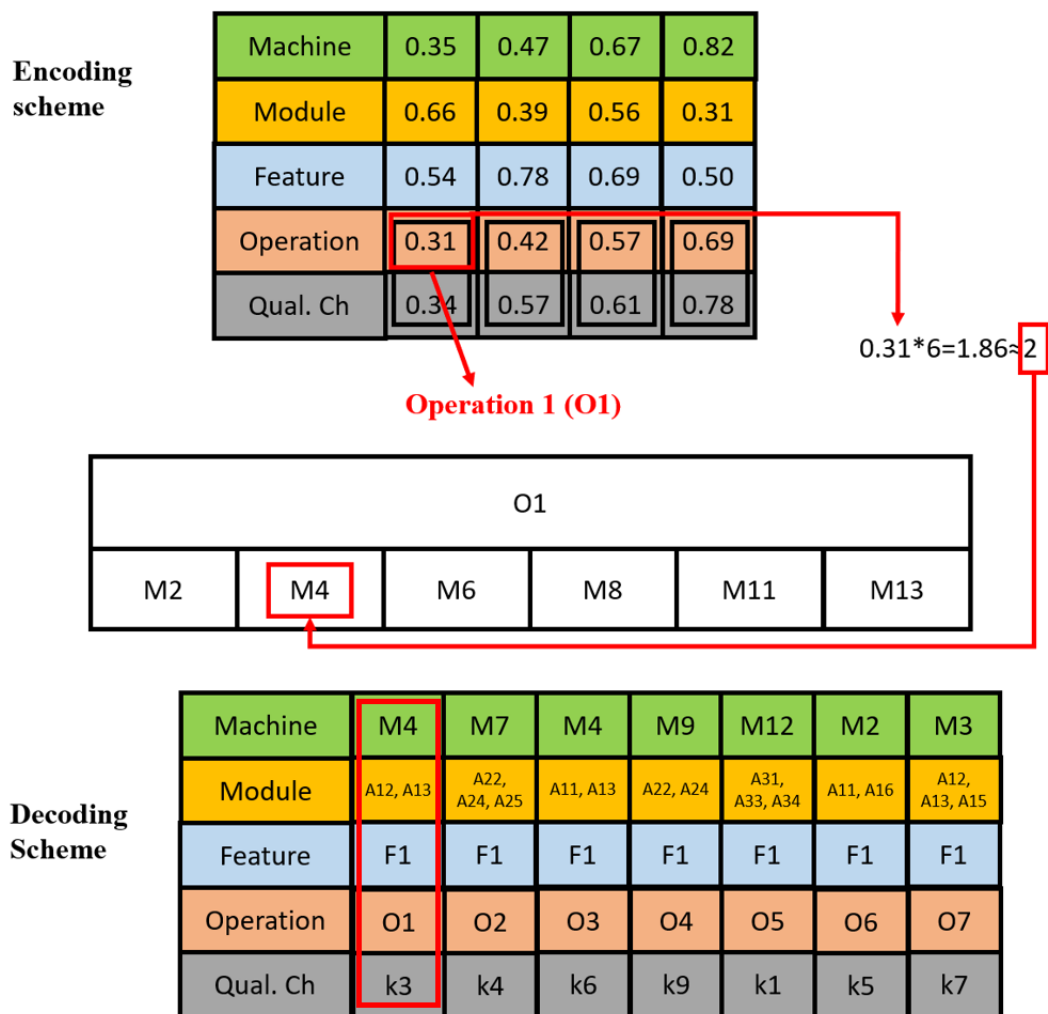

Figure A2. Encoding and decoding schemes

*The description of genetic operators:*

This research used a Partially Mapped Crossover (PMX) and a random mutation operator for generating the offspring. The PMX selects two random parent strings and applies two cut points in each string. The sub-strings within the cut bound are exchanged and the mapping relationship is identified, as shown in Figure A3. The step-by-step execution of PMX is described in Algo. A1. Step 6 decides the position of a configuration based on its presence in offspring 1. The random mutation operator selects a random continuous number between 0 and 1 and multiples it with the gene values of the elements of a chromosome. Thus, a random seed/offspring is produced.

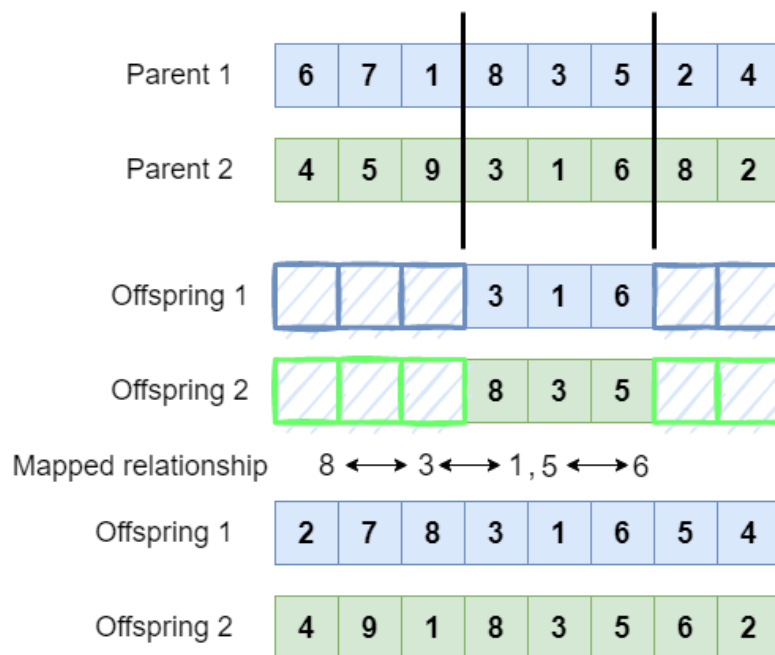

Figure A3. Partially Mapped Crossover (PMX)

<b>Algo. A1</b>	<b>Steps of Partially Mapped Crossover (PMX)</b>
<b>Step 1</b>	Randomly select two parent strings
<b>Step 2</b>	Randomly select two cut points in each string
<b>Step 3</b>	Exchange/Swap the sub-strings within the bound of cut points
<b>Step 4</b>	Identify the mapping relationship
<b>Step 5</b>	Copy the elements in the remaining places of the string
<b>Step 6</b>	If a configuration is already present in offspring 1 while copying from string 2, its position is decided, and replacement is made based on the mapped relationship

# French Summary

Les systèmes de fabrication modernes sont confrontés à différents défis en raison de la dynamique des demandes des clients. Ces défis peuvent prendre la forme de tendances changeantes en matière d'exigences et de fonctionnalités de produits, de combinaison de produits, de rentabilité et de réactivité, etc. Les systèmes de fabrication traditionnels tels que les lignes de fabrication dédiées (DML) et les systèmes de fabrication flexibles (FMS) ne sont pas en mesure de relever de tels défis de manière rentable. Par exemple, les DML conviennent à la production de masse alors qu'elles manquent de mélange de produits et de variété. D'autre part, les FMS peuvent s'adapter à la variété de produits ; cependant, ils ne sont pas conçus de manière appropriée pour un débit de production élevé. En outre, ils offrent une flexibilité débordante dans la conception de leur système qui est sous-utilisée et ils peuvent donc s'avérer être un système de fabrication coûteux. Pour faire face à ces problèmes, un nouveau système de fabrication appelé Reconfigurable Manufacturing System (RMS) a été introduit.

RMS est défini comme 'un système modifiable conçu dès le départ pour répondre à l'évolution du marché en offrant les fonctionnalités et la capacité nécessaires en cas de besoin' [1]. RMS peut répondre à diverses exigences de production en utilisant un nouvel outil de fabrication reconfigurable (RMT) pour produire une variété de produits à la demande requise. RMT aide le RMS à effectuer diverses opérations en changeant entre ses configurations respectives. Pour passer d'une configuration à l'autre, RMS a besoin de deux types de modules, à dire des modules de base et des modules auxiliaires. Les modules de base sont de nature fixe et constituent la base fondamentale de la conception du RMS. D'autre part, les modules auxiliaires sont modifiables et prennent en charge les changements brusques apportés au système. Outre ces modules, un RMS offre les caractéristiques distinguées de modularité, intégrabilité, personnalisation, convertibilité, évolutivité et diagnostiquabilité [2]. Ces caractéristiques jouent un rôle essentiel dans la conception architecturale de RMS et sa fonctionnalité sur la période de son utilisation.

Cette recherche prend en compte la caractéristique de modularité dans la conception de la planification des processus RMS. Un indice est défini pour la modularité qui prend en compte les efforts modulaires gaspillés lors de la reconfiguration ainsi que l'effort modulaire gaspillé en raison d'une production de mauvaise qualité. Certains efforts modulaires sont nécessaires pour produire chaque unité de produit et la défaillance d'une unité de produit signifie que cet effort est également gaspillé. En outre, cette recherche prend également en compte la diagnostiquabilité dans le sens où le modèle proposé prend en compte la défaillance et la perturbation de la machine ainsi que l'analyse de multiples causes de variation de qualité et de défauts. Ces causes de variation entraînent des unités de produit défaillantes qui sont abordées dans la discussion sur le cadre de décomposition de conception du système de fabrication (MSDD).

## 1.1. Aspects de qualité dans un système de fabrication reconfigurable

L'un des aspects importants de tout système de fabrication est sa capacité à s'adapter et à s'adapter aux variations de qualité et aux dysfonctionnements. La qualité des produits et des processus est influencée par de nombreux facteurs tels que la nature des défauts, la perturbation des machines, etc. En outre, un système devient complexe lorsqu'il existe un plus grand nombre de façons de connecter des machines dans son système de production. RMS est un système de fabrication complexe car il utilise des portiques et des convoyeurs pour connecter les machines reconfigurables. Une telle disposition multiplie le nombre de possibilités de liaison des machines. Ainsi, il devient plus difficile d'analyser sa qualité de production.

Cette capacité de RMS à offrir de nombreuses voies de production entraîne deux problèmes liés à la qualité [3]. Tout d'abord, la variation de la qualité dimensionnelle du produit augmente à mesure que le produit passe par différentes configurations. Deuxièmement, s'il y a une machine problématique, il est difficile de la retracer simplement en inspectant la qualité des produits. En d'autres termes, grâce aux capacités améliorées de RMS, un produit peut passer par l'une des nombreuses routes désignées. Par exemple, pour 20 étapes de production RMS, chacune contenant 6 machines, il existe jusqu'à  $3,6 \times 10^{15}$  façons de connecter les machines [4]. Il est donc compliqué, voire impossible, d'analyser la qualité du produit dans chaque itinéraire.

De plus, chaque aspect d'un produit ne peut pas être analysé par un système de fabrication. Ainsi, un système ne prend en compte que certains aspects d'un produit appelés caractéristiques clés (KC). KC explique la majeure partie de la variation de qualité et de la perturbation d'un produit. En d'autres termes, la qualité globale d'un produit peut être améliorée en améliorant la qualité de ses caractéristiques clés [5]. Les dimensions, la précision et les tolérances sont quelques-uns des exemples liés à KC.

Les KCs identifient les aspects cruciaux d'un système de fabrication qui peuvent influencer les variables de performance telles que le coût, la qualité, la réactivité, etc. En raison de contraintes technologiques et de temps, les gestionnaires ont du mal à analyser et à améliorer chaque caractéristique. Ainsi, l'identification des caractéristiques clés aide les gestionnaires à consacrer leurs efforts à un ensemble de caractéristiques minimales qui peuvent améliorer considérablement l'efficacité d'un système de fabrication. Par exemple, du point de vue du produit, les caractéristiques clés possibles peuvent être les tolérances, l'état de surface et la conformité aux paramètres de conception. Une fois la liste des caractéristiques clés formulée, la tâche suivante consiste à identifier les causes assignables dans un système de fabrication qui peuvent influencer le comportement de ces caractéristiques. Par exemple, l'usinage et la

précision des processus sont quelques-unes des causes assignables qui peuvent influencer ces KC. Ces causes assignables sont responsables de la variation de la qualité des caractéristiques clés (KC). La variation dans ce contexte est définie comme 'l'écart par rapport aux spécifications standard'. Comme établi précédemment, étant donné que RMS est un système de fabrication complexe, le rôle des PRINCIPAUX et la synthèse de la variation de la qualité sont donc encore plus importants dans l'analyse de ses performances.

Pour analyser les performances de qualité de RMS, il est possible de définir un ensemble de KCs qui sont essentiels pour avoir un impact sur l'efficacité globale. Ces KC peuvent être identifiés soit en consultant les gestionnaires, soit en analysant la littérature établie sur les RMS et les indicateurs de performance de la qualité. L'identification et la modélisation de ces KC mettent en évidence le rôle de la qualité dans l'attribution de configurations à différentes opérations (également appelée planification des processus). Pour résumer, cette recherche vise à répondre aux questions suivantes :

- Quel est l'impact de la variation de la qualité sur la performance de la planification des processus RMS ? l'évaluation des plans de processus en fonction du nombre d'opérations conformes et échouées.
- Comment un cadre de décomposition de conception de système de fabrication (MSDD) peut-il être appliqué à RMS et quelles sont les principales causes assignables de variation qui influencent la qualité globale du produit dans RMS ?
- Quel est le compromis entre la qualité, le coût et la modularité dans le contexte de RMS ? L'indice de modularité est défini par rapport à la qualité et tient compte de la proportion d'efforts perdus dans la production d'unités de fonctionnement défectueuses.

Le concept de décomposition et de modularité de la conception des systèmes de fabrication sera discuté dans les sections à venir. Les questions ci-dessus, si elles sont traitées de manière appropriée, permettront aux responsables d'affecter des configurations de machine à des opérations ayant un impact minimal sur la qualité du produit. En outre, il aidera à la synthèse des efforts modulaires nécessaires à l'achèvement de l'ensemble des opérations, également appelé planification des processus. La section ci-dessous traite de la planification des processus dans RMS et de l'impact des différents objectifs sur les décisions de planification des processus.

## 1.2. Planification des processus dans RMS

La planification des processus est une question pertinente dans RMS, et elle aide au flux logique d'une reconfiguration. Musharavati et Hamouda [6] ont défini la planification des processus comme « le processus de facilitation de la reconfiguration logique dans un système de fabrication conçu pour être reconfigurable, pour atteindre la rentabilité ». La possibilité de reconfigurer logiquement un système de fabrication dépend de la reconfigurabilité et de la flexibilité héritée d'un système.

La planification des processus n'est pas une décision autonome, elle dépend plutôt de la connaissance de la séquence d'opération et du routage dans un système de fabrication. Pour un RMS multi-pièces ou multi-fonctionnalités, la séquence des opérations dans la pièce/fonctionnalité respective suivra son itinéraire en termes d'utilisation des configurations de machine, des modules et des outils. Ces informations seront utilisées par la planification des processus pour attribuer des configurations aux opérations afin d'optimiser les efforts de coût, de temps, etc. Une décision typique de planification de processus considère la matrice de machines, de configurations, de modules et d'outils comme une entrée pour les affecter aux opérations des fonctionnalités respectives.

Différents plans de processus se tradseront par des solutions différentes. Si le coût et le temps sont les objectifs ultimes à optimiser, un plan de processus particulier peut bien fonctionner sur la dimension du coût, cependant, cela peut prendre plus de temps à compléter. Bien que de nature subjective, un gestionnaire peut toujours choisir une solution réalisable sous-optimale en sélectionnant un plan de processus concernant la valeur optimale du coût ou du temps. Cela aura un impact sur la solution offerte par l'autre fonction objective. Un objectif qui est toujours en conflit avec le temps et le coût de production est la qualité de la production. Par exemple, un produit de qualité a besoin de précision, de connaissance des processus, d'une production sans défaut et de la conformité aux normes qui nécessitent toutes un investissement et un temps de production supplémentaires. À l'ère moderne, il est inutile de dire que nous avons produit x quantité de produits dans une période au lieu de b période ( $a < b$ ) si soit le temps raccourci a un impact sur la qualité du produit, soit l'analyse de la qualité du produit n'est pas prise en compte du tout.

Il devient donc plus difficile d'analyser la qualité du produit dans RMS en raison de :

i) La complexité héritée par RMS en offrant un grand nombre de voies de production rend difficile l'analyse de la qualité à travers chaque voie.



ii) Les solutions basées sur la qualité peuvent potentiellement avoir un impact sur les solutions de coût, de temps, etc. Pour une meilleure compréhension, nous considérons l'exemple suivant.

Comme le montre la figure 1, six machines reconfigurables sont disponibles, chacune contenant deux configurations, pour exécuter la fonctionnalité 1 (F1). L'état de qualité de chaque configuration peut être lu à l'aide de la rubrique donnée dans la figure. Les chemins possibles pour traiter cette fonction sont a, b, c, d et e, et les plans de processus correspondants utilisés dans chaque chemin sont fournis à la figure 2. L'objectif est d'évaluer le coût, le temps et la qualité de chaque parcours.

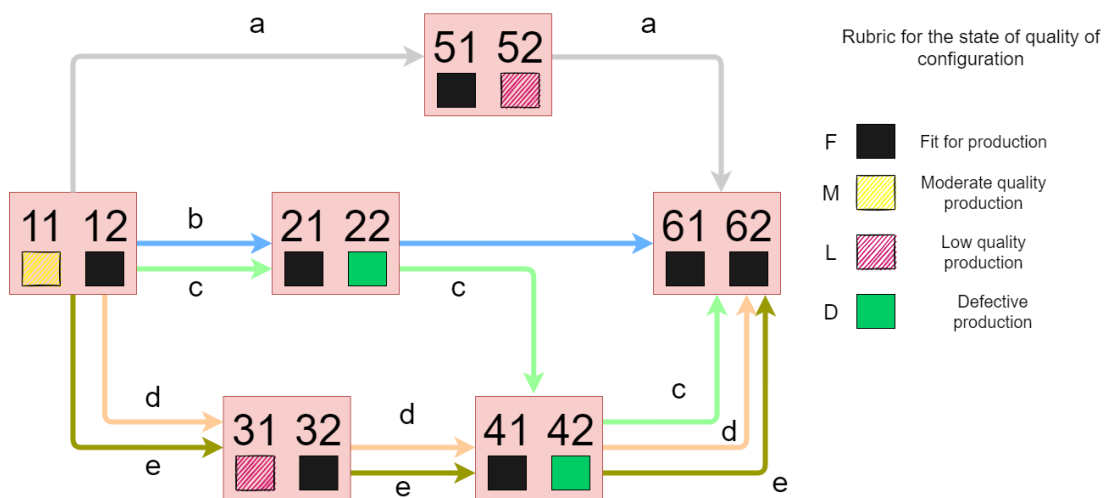

figure 1. Disposition de la configuration avec chemins et qualité de la production

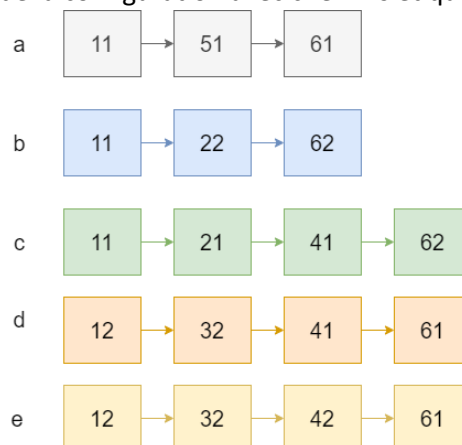

figure 2. Plans de processus pour différents chemins

Les solutions proposées par a et b seront meilleures en ce qui concerne le coût et le temps car elles utilisent un plus petit nombre de configurations (3 dans chaque cas). Cependant, le chemin

b sera compromis en ce qui concerne la qualité car il contient une configuration de machine défectueuse. La nature défectueuse de la machine peut être attribuée à une variation de qualité due à des problèmes de maintenance, à un mauvais outillage ou à toute autre cause assignable de variation de qualité. Si nous comparons le plan de processus des chemins c, d et e ; tous utilisent le même nombre de configurations (4 dans chaque cas). En fait, entre les chemins d et e, il n'y a qu'une seule différence de configuration alors que les autres types de configurations sont les mêmes pour les deux. Les résultats de ces chemins peuvent indiquer qu'ils diffèrent tous dans les trois valeurs de fonction objective. Le chemin e peut fonctionner de manière faible sur la dimension de qualité car il utilise une configuration défectueuse (42) tandis que le chemin d fonctionnera bien en termes de qualité, mais il peut offrir des solutions sous-optimales de coût et de temps. Pour analyser ou optimiser le coût et/ou le temps d'un process plan ou d'un process plan reconfigurable, un simple graphe acyclique dirigé est utilisé pour modéliser les opérations et l'antériorité. Pour analyser ou optimiser la qualité du produit d'un plan de processus ou d'un plan de processus reconfigurable, un graphique non orienté est utilisé pour modéliser les opérations, la structure du système de fabrication et les fixations (évaluation de la capacité du processus pour chaque tolérance). Par conséquent, la différence de modélisation a un impact sur la complexité de l'évaluation de la qualité d'un plan de processus ou d'un plan de processus reconfigurable.

Bien que le même nombre de configurations ait été utilisé dans les trois derniers chemins, la différence de solutions réside dans le fait que chaque configuration :

- a) A un coût d'exploitation et d'exploitation de la machine différent.
- b) A besoin de valeurs de temps différentes pour ajouter, soustraire et réajuster les modules en fonction des exigences opérationnelles, ce qui entraîne des décalages horaires.
- c) Fonctionne dans un état de qualité différent, ce qui peut avoir une incidence sur la décision de planification du processus.

Il est entendu qu'une telle analyse du plan de processus sera utile aux gestionnaires pour évaluer l'impact des différents chemins sur l'efficacité de la solution de diverses fonctions objectives, en particulier la qualité. Une fois cette compréhension développée, les recherches futures pour pourrait viser à analyser l'impact de la position d'une configuration défectueuse sur la qualité de la production. Par exemple, une question peut être posée telle que « quelle est la différence dans la qualité de la production si une configuration défectueuse fonctionne au début ou vers la fin d'un plan de processus ? » Pour un système complexe tel que RMS, il est avantageux d'examiner sa qualité en divisant le système en différents niveaux. Cela peut être accompli en utilisant un cadre de décomposition de conception de système de fabrication (MSDD) qui est discuté dans la section ci-dessous.

### 1.3. Décomposition de la conception du système de fabrication

Les performances d'un système de fabrication complexe peuvent être facilement analysées en le décomposant en modules et en éléments. Il est judicieux de le faire car les systèmes de fabrication sont un phénomène complexe et ils impliquent l'interaction entre plusieurs éléments, ce qui rend très difficile l'analyse de l'impact des problèmes de bas niveau et, en réponse, la modification de l'architecture du système de fabrication [7]. La littérature contient certaines approches de la décomposition d'un système de fabrication. Par exemple, Spearman et Hopp [8] ont proposé une perspective réductionniste qui divise un système majeur en petits composants pour faciliter l'analyse du comportement de chaque composant.

Une fois le système de fabrication décomposé, ses composants peuvent être classés en différents niveaux en fonction de leurs fonctionnalités. En outre, les performances des composants à chaque niveau peuvent être analysées et leur impact sur les composants de niveau supérieur peut être étudié. Chaque système de fabrication est conçu pour optimiser certains critères de fonctions objectives telles que le coût, le temps, la réactivité, la qualité, etc. qui reposent au niveau supérieur de la structure décomposée. Ainsi, la décomposition aide à relier les activités et les tâches de bas niveau aux objectifs et aux exigences fonctionnelles de niveau supérieur. Il aide également à analyser et à interpréter la relation entre les composants d'une conception de système.

La discussion ci-dessus vise à présenter le cadre de décomposition de conception du système de fabrication (MSDD) et son application au système de fabrication reconfigurable. La MSDD décompose les objectifs globaux d'un système de fabrication en sous-composantes mesurables. Le contrôle efficace de ces sous-composantes démontre dans quelle mesure la MS a atteint les objectifs qu'elle avait fixés. La décomposition des objectifs de la MS s'effectue à l'aide des exigences fonctionnelles (FR) et des paramètres de conception (DP). Les États membres définissent certains FR pour aider à répondre à la question « que faire ? ». Une fois que la question « quoi » est répondue, les DP sont utilisés pour aborder « comment atteindre les FR ? ». En d'autres termes, le DP constitue la mise en œuvre physique du FR. La décomposition d'un système de fabrication en exigences fonctionnelles et en paramètres de conception peut aider les gestionnaires à comprendre les besoins opérationnels d'un système de fabrication.

La confusion se trouve normalement dans le système de fabrication en ce qui concerne les objectifs et leurs moyens. Un objectif peut être de minimiser les coûts de fabrication et les moyens de le faire peuvent impliquer des activités telles que l'usinage optimal, la suppression des activités redondantes et le déploiement réfléchi du personnel. L'usinage, l'élimination des activités redondantes et les tâches liées au personnel ne sont pas les objectifs ultimes ; cependant, ils sont le

moyen de soutenir et de réaliser l'objectif principal. La même différence est vraie entre les exigences fonctionnelles et les paramètres de conception. Les paramètres de conception sont les détails opérationnels pour atteindre les objectifs fixés par les exigences fonctionnelles. L'application du cadre des MSDD aux RMS peut servir aux fins suivantes :

- Par rapport à d'autres systèmes de fabrication, un RMS peut être facilement décomposé en sous-composants et modules grâce à sa structure modulaire. Ceci est sous le principe de fonctionnement de MSDD qui divise un système en modules et sous-composants. Il sera intéressant d'analyser le RMS modulaire du point de vue de la décomposition de la conception du système.
- L'application de la MSDD aux RMS permettra d'identifier les différentes sources de variation et leurs impacts sur la performance globale du système.
- Un système de fabrication peut être analysé en ce qui concerne plusieurs critères. Différents ensembles de critères peuvent être trouvés dans la littérature avec une applicabilité égale et moins de consensus. RMS a été analysée sous différents aspects ; cependant, la littérature existante manque d'analyse de la qualité de la production dans les RMS. Ainsi, l'application de la MSDD aidera à analyser la qualité d'un système de fabrication reconfigurable.

#### 1.4. Énoncé de recherche de thèse

Cette thèse examine simultanément la qualité, la modularité et le coût d'un système de fabrication reconfigurable. L'impact de la variation de la qualité sur le rendement de la planification des processus RMS est examiné. Un nouvel indice de décroissance de la qualité (QDI) est proposé pour calculer le nombre d'unités défectueuses et d'unités conformes fournies par un plan de processus. En outre, l'analyse est réalisée en intégrant la caractéristique de modularité du RMS. La modularité permet au RMS d'effectuer une variété de tâches en utilisant ses fonctionnalités de modules de base et auxiliaires. Shaik et coll. [8] ont proposé d'inclure la modularité pendant la phase de conception, car elle influence la flexibilité et la qualité globales. Cette recherche considère la modularité comme un aspect intégral de la conception du RMS et l'objectif n'est pas seulement d'analyser l'impact de la variation de qualité sur les performances du RMS, mais aussi comment la modularité du système global est affectée. Un indice est défini pour la modularité qui prend en compte l'effort modulaire gaspillé lors de la reconfiguration et en présence de variation de qualité.

## 1.5. Objectifs de la recherche

Cette recherche est réalisée pour répondre aux objectifs suivants :

- Étudier les fonctions objectives du coût total (TC), de l'indice de décroissance de la qualité (QDI) et de l'effort de modularité (ME) dans la planification des processus RMS. L'objectif est d'analyser comment ces fonctions objectives sont influencées par la variation liée à la qualité. L'QDI proposée quantifie le nombre d'unités conformes et défectives produites par un plan de processus.
- Mettre en évidence et comparer l'impact de la variation de qualité en utilisant deux modèles. Le modèle 1 effectue l'analyse en utilisant les trois fonctions objectives, c'est-à-dire TC, QDI et ME. Le modèle 2 effectue l'analyse sans utiliser l'indice de qualité. De cette façon, une comparaison peut être établie.
- Étudier les impacts de la variation de qualité sur la modularité de RMS, c'est-à-dire le nombre de modules utilisés avec et sans la variation de qualité.
- Analyser un problème RMS complexe impliquant le coût, le temps et la modularité à l'aide d'une méta-heuristique hybride. Il combine l'algorithme génétique de tri non dominé (NSGA-II) et l'optimisation multi-objectifs de l'essaim de particules (MOPSO) pour tirer parti de leur comportement d'exploration et d'exploitation.
- Mettre en œuvre le modèle sur deux études de cas qui varient en termes de complexité.

## 1.6. Portée et limites de la recherche

La portée et les limites de cette recherche peuvent être décrites comme :

- La MSDD contient certaines autres exigences fonctionnelles en plus de la qualité. Étant donné que la recherche actuelle est axée sur la qualité, elle ne répond pas aux besoins d'autres exigences fonctionnelles.
- Les causes de la variation de la qualité peuvent être classées en variation en production et variation hors production. Cette recherche ne prend en compte que la variation de qualité en production causée pendant la production.
- Le modèle mathématique présenté analyse le système de fabrication reconfigurable. C'est de loin l'un des systèmes de fabrication complexes et le modèle proposé peut être adapté à des systèmes de fabrication plus simples (par exemple, FMS) en le modifiant dans une certaine mesure.

- L'indice de désintégration de la qualité (QDI) est calculé pour la pire configuration (configuration pessimiste), par conséquent, seul un simple graphique acyclique dirigé est nécessaire.
- Le modèle présenté est déterministe ; par conséquent, il n'est pas conçu pour englober le flou et le comportement stochastique des systèmes de fabrication. Les systèmes de fabrication modernes sont plus dynamiques et incertains, et ils contiennent des caractéristiques stochastiques. Étant donné que le modèle contient une certaine nouveauté, il peut être considéré comme la base et des aspects supplémentaires de la stochasticité peuvent y être ajoutés.
- Enfin, l'analyse proposée est conçue pour une seule période et un seul produit ; cependant, il peut être étendu à l'analyse de la conception de RMS multi-produits et multi-périodes.

## 2.1. Analyse de modularité dans RMS

La modularité sert d'outil pour relier différentes interfaces d'un système. Il devient difficile d'évaluer la modularité lorsqu'un système comprend le plus grand nombre d'interfaces, comme dans le cas de RMS. Pour le démontrer, Farid [9] a calculé deux mesures de modularité pour soutenir la facilité de reconfiguration. Il a été avancé que la complexité de l'interface influe sur la modularité d'un système. Par la suite, une mesure quantitative de la modularité a été proposée, basée sur les connaissances axiomatiques en matière de conception et la matrice de structure de conception. Cette mesure a été utilisée pour comprendre le nombre d'interfaces dans un système de fabrication. Haddou benderbal et al. [10] ont proposé un modèle multi-objectifs comprenant la modularité du système et le temps pour évaluer la performance de la planification des processus dans RMS. L'objectif de modularité a analysé les interfaces sous différents angles tels que la communauté, la diversité des opérations et le nombre de modules partagés et communs entre plusieurs configurations de machines. Le modèle a été appliqué à une étude de cas en utilisant l'algorithme génétique de tri non dominé (NSGA-II) pour obtenir des solutions non dominées. Ces solutions ont ensuite été classées en fonction de la technique des préférences de commande par similitude avec les solutions idéales (TOPSIS). Les résultats ont montré que le nombre et les types de modules changeaient entre différentes solutions en fonction de la sélection de différentes configurations de machines.

Massimi et al. [11] ont récemment proposé un système de fabrication durable reconfigurable en utilisant le concept de consommation d'énergie. L'objectif était de sélectionner un RMS modulaire qui garantissait la valeur minimale de consommation d'énergie. Le modèle a pris en compte deux caractéristiques RMS : la modularité et l'intégrabilité. La consommation d'énergie en modularité considérait l'énergie utilisée dans le traitement, la modification des configurations, l'ajout et la

soustraction de modules auxiliaires et l'énergie utilisée par les modules de base. Une approche heuristique de recherche exhaustive a été utilisée pour mettre en œuvre le modèle. Sur la base de différents scénarios, il a été rapporté que le niveau de consommation d'énergie dépend fortement de l'utilisation du type de configurations de machines et de modules de base et auxiliaires.

Bien que plusieurs contributions aient été proposées pour analyser la modularité ; cependant, sa relation avec la qualité de la production n'a pas été explorée. Par exemple, certaines questions pourraient être abordées : quel est l'impact sur la modularité s'il y a des variations dans la qualité de la production ? En d'autres termes, comment la qualité et la perturbation affectent-elles les efforts modulaires ? Pour ce faire, cette recherche lie la qualité à la modularité, c'est-à-dire que l'effet de la variation de la qualité est étudié sur les efforts modulaires et les changements de configuration au cours de la planification du processus.

## 2.2. L'analyse des coûts dans RMS

Le coût est un indicateur important utilisé pour évaluer la performance d'un système de fabrication. L'analyse des coûts a été effectuée à plusieurs reprises dans le RMS. La fonction de coût unique, ainsi que la fusion de différentes fonctions de coût, ont été prises en compte pour évaluer le rendement de RMS. Les fonctions de coût les plus choisies pour la conception du RMS sont le coût en capital et le coût de production. Cette section passe en revue les différentes fonctions de coût utilisées pour modéliser les problèmes de planification des processus RMS. Youssef et Elmaraghy [12] ont examiné le problème de sélection de la configuration RMS en deux phases. Au cours de la première phase, des solutions non dominées pour différents scénarios de demande ont été obtenues par algorithme génétique et recherche tabu. La deuxième phase a utilisé les mêmes algorithmes pour dériver des alternatives à partir des solutions non dominées obtenues dans la première phase pour optimiser la fluidité de la transition. Le critère de sélection était basé sur le coût optimal du capital dans l'établissement d'une configuration. Battaia et al. [13] ont étudié la ligne d'écoulement RMS pour la production par lots en utilisant un critère optimal basé sur les coûts. L'objectif principal était d'optimiser le coût de l'équipement pour répondre à la demande en respectant les contraintes. Les contraintes étaient liées à la conception des tourelles et des modules, à l'emplacement des pièces et à la procédure d'exploitation. Un modèle MIP (Mixed Integer Programming) a été développé et mis en œuvre sur une étude de cas industrielle. Moghaddam et al. [14] ont étudié le coût d'expansion du capital pour la conception de configuration évolutive dans RMS. Un modèle mathématique a été présenté pour analyser les cas de conceptions de lignes de flux de production unique et de familles de pièces.

Deif et coll. [15] ont défini la fonction de coût pour RMS, qui comprend deux composantes. Le premier composant était lié au coût de la capacité physique pour la mise à l'échelle du système, tandis que le second composant était associé à la reconfiguration du système. Dou et al. [16] ont étudié un problème de sélection et de planification de la configuration intégrée dans une flowline reconfigurable. Un modèle de programmation d'entiers mixtes, qui incluait le coût et le temps comme objectifs, a été proposé. La fonction de coût contenait les composantes de la reconfiguration et du coût en capital. Le modèle a été validé de manière déterministe, puis mis en œuvre par le biais de la NSGA-II. Dans une autre étude [17], NSGA-II a été utilisé pour résoudre le problème de sélection de la machine. Plus précisément, une machine a été sélectionnée parmi l'ensemble des machines pour effectuer des opérations avec des caractéristiques différentes. La sélection a été faite en fonction du coût minimum qui comprenait les coûts liés à la production, à la reconfiguration, à l'utilisation des outils et au changement d'outil.

Pour résumer, les coûts liés au capital, à la production, aux configurations, aux modules, au transport, à l'installation et à la consommation d'énergie ont été analysés dans les problèmes de planification des processus RMS. Tous ces facteurs de coût sont importants dans l'examen de diverses décisions. Ces décisions sont liées à l'allocation optimale des ressources, à la sélection d'un plan de processus et à la modification des configurations respectives. À ce jour, la littérature concernée manque d'analyse des coûts liés à la variation de la qualité. RMS est sujet aux défauts dus à la variation de qualité, comme tout autre système de fabrication. Pour qu'un système de fabrication fonctionne de manière rentable, il est important de contrôler les coûts liés à la variation par rapport à l'amélioration de la qualité [18]. En d'autres termes, un équilibre doit être justifié entre le compromis coût-qualité en effectuant une évaluation combinée des deux. L'analyse de la variation de la qualité peut aider un système de fabrication à identifier les sources de variabilité et à assurer un plus petit nombre de défauts et un coût inférieur. Les coûts liés à la variation de la qualité peuvent être exprimés sous forme de réparation, de réclamations de garantie, de rebut, d'inspection, de perturbation, de capacités de fabrication sous-utilisées, etc. [19]. Outre d'autres facteurs de coût, cette étude analyse les coûts liés à la mise au rebut, au remanage et aux performances perturbatrices de la machine dans le choix d'un plan de processus. De cette façon, une intégration entre le coût et la qualité peut être assurée.

### 2.3. L'analyse de la qualité dans RMS

Un système de fabrication est conçu pour atteindre les objectifs de faible coût, d'amélioration de la qualité de la production et de réactivité. La littérature établie sur les RMS met l'accent sur l'atteinte de l'objectif de réactivité grâce à une production en temps opportun à faible coût. Cependant, il a



encore besoin du mécanisme de soutien pour atteindre l'objectif d'une production de haute qualité, car, sans l'accent mis sur la qualité, une production réactive et à faible coût n'aidera pas à améliorer la clientèle et à obtenir un avantage concurrentiel. En outre, une qualité de production compromise entraînera une utilisation inefficace des ressources.

Un fabricant sélectionne certaines ressources de fabrication et évalue leur impact sur le produit KCs. Ces ressources sont modifiées si une amélioration de la qualité est nécessaire et que l'analyse est répétée. Le processus de sélection des ressources n'est pas fastidieux pour un système de fabrication relativement moins complexe. RMS implique la sélection de machines, de configurations, de fonctionnalités modulaires, d'outils et de directions d'approche d'outils (TADs), ainsi que le plus grand nombre d'itinéraires de production possibles. Ainsi, il devient plus difficile d'analyser l'impact de chaque ressource sur les performances de KC.

Dans une certaine mesure, la notion de qualité a été discutée dans la littérature RMS. Une perspective théorique sur les différentes mesures du rendement dans les RMS, à savoir le coût, la fiabilité, l'utilisation et la qualité, a été fournie dans [20]. La mesure de la qualité a été définie comme une moyenne d'utilisation et de fiabilité. L'étude n'a pas fourni de modèle ou de solution concernant l'évaluation de la qualité et sa variation associée. Plus récemment, Koren et al. [4] ont comparé différents systèmes de fabrication, y compris Serial-Line-in-Parallel (SLP) et RMS. La comparaison a été effectuée en fonction du coût, de la réactivité et de la qualité. Il a appelé à mettre davantage l'accent sur l'évaluation de la qualité dans les RMS en raison de sa structure complexe. Il y a six (6) exigences clés pour un système stable telles que la conception, la qualité, la livraison, le coût, etc. [21]. L'exigence de qualité nécessite que la production soit achevée dans des tolérances définies qui peuvent être obtenues en éliminant les causes assignables de variation. Bien que la littérature RMS réponde aux exigences de conception, de coût, etc., elle manque encore d'analyse des causes de variation pour se conformer à l'exigence de qualité.

Cette recherche traduit la variation de la qualité en efficacité des éléments de processus (PE) en utilisant des taux de défaillance. Un PE est la caractéristique du système de fabrication qui affecte le KC. Il comprend l'usinage, l'outillage, les schémas de production, l'état de coupe, etc. PE définit les causes « assignables » responsables de la variation de la qualité du KC. Les causes assignables sélectionnées dans cette étude sont la perturbation des machines, les problèmes liés à la tolérance et les erreurs d'outillage. À cette fin, un indice quantitatif pour l'évaluation de la qualité dans les RMS est proposé. Cet indice permet au décideur (DM) de sélectionner un plan de processus avec un minimum de variation et de défauts.

## 2.4. Problème de recherche

Cette section décrit le problème de recherche de la thèse qui implique l'analyse du coût, de la qualité et de la modularité. Un RMS est analysé lorsque différentes étapes de production sont conçues en série. Chaque étape de production contient une configuration de machine qui peut effectuer une ou plusieurs opérations. Un RMS parfait basé sur la qualité fonctionne bien et convertit toutes les unités d'opération d'entrée en sortie utilisable. Cela signifie que le nombre d'unités d'entrée est égal au nombre d'unités de sortie. Cependant, en présence de variations et de défauts, la qualité des opérations est impactée. Ainsi, une partie des unités d'exploitation est jetée comme ferraille en raison de la mauvaise qualité tandis que les unités restantes sont retravaillées pour les rendre conformes. Comme le montre la figure 3, les unités de matières premières ( $\eta_{io}$ ) sont initialement traitées sur la configuration de la machine  $i$  pour effectuer l'opération  $o$ . La configuration  $i$  présente une variation de qualité qui entraîne l'échec des unités d'opérations. Après avoir jeté les unités défectueuses en tant que rebuts, les unités restantes sont retravaillées, puis transmises à la configuration de la machine suivante, etc. Les unités d'opération défailtantes sont produites entre deux configurations successives, et celles-ci sont supprimées, et le reste est retravaillé après chaque configuration de machine. On peut observer à partir de la courbe donnée à la figure 3 que chaque configuration continue de diminuer le nombre de produits conformes en raison de différents défauts. À la fin de la gamme de processus, une partie des produits entrant dans l'RMS est conforme tandis que le reste est jeté comme rebut. L'objectif est de sélectionner un plan de processus qui garantit un plus grand nombre de produits conformes ainsi qu'un coût minimal et un minimum d'effort modulaire.

La recherche vise à sélectionner un plan de processus qui garantira une solution au coût total le plus bas, une variation minimale de la qualité et des unités défailtantes, et un effort modulaire minimal. Étant donné que ces objectifs sont contradictoires, l'analyse aidera à atteindre différentes solutions non dominées et les praticiens seront en mesure de sélectionner un plan de processus particulier en fonction de leurs préférences. Certains des objectifs pourraient se renforcer mutuellement, par exemple, la solution au coût total le plus bas pourrait indiquer un coût minimal de rebut et de remise en état, ce qui peut être considéré comme une indication que la solution contiendra moins d'unités défailtantes et une meilleure qualité.

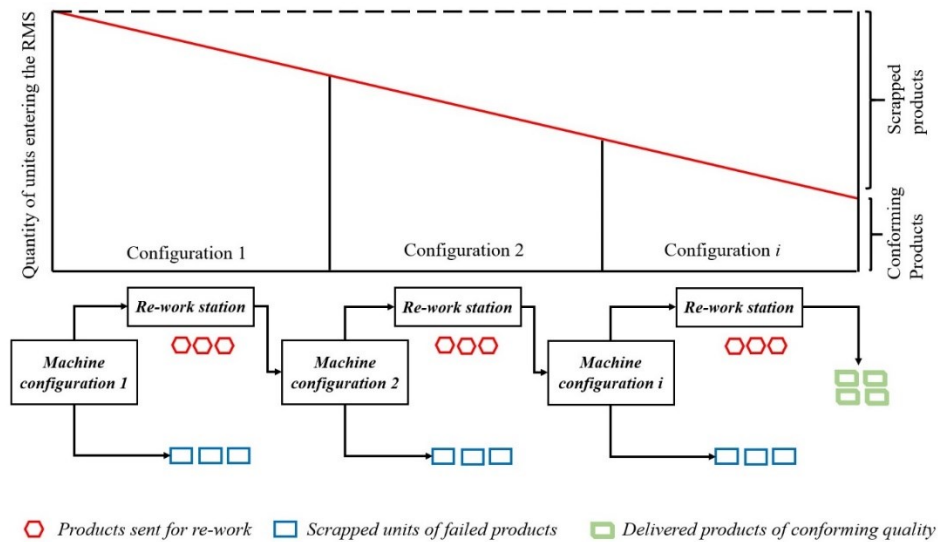

figure 3 Flux de processus de l'RMS considéré

### 3.1. Conclusions

- Bien que RMS soit connu pour sa rentabilité, il semble que la variation de la qualité et les unités d'exploitation défailtantes aient un impact sur les performances de RMS. Ainsi, il est impératif de le protéger contre différentes sources de variation pour fonctionner de manière optimale en fonction des coûts.
- Une solution sélectionnée en fonction de la variation de la qualité a un impact sur la sélection de solutions basées sur d'autres fonctions objectives. Cela signifie que la qualité joue un rôle actif dans la conception d'un plan de processus qui a été choisi en fonction du coût, de la modularité du temps, etc. Les résultats suggèrent un compromis entre les objectifs de coût, de qualité et de modularité. Un plan de processus basé sur une variation de qualité minimale affecte les solutions de coût et de modularité. Cela offre une opportunité ainsi qu'un défi pour le praticien d'équilibrer le compromis entre le choix de différentes fonctions objectives.
- La présence d'une variation de qualité entraîne des plans de processus différents par rapport à un système de fabrication qui ne contient aucune variation de qualité. Les deux modèles ont obtenu des performances très différentes en termes de besoins modulaires et de nombre de configurations.
- Les résultats des modèles proposés 1 et 2 indiquent que les deux modèles donnent lieu à des plans de processus différents. De plus, les valeurs du coût total de toutes les solutions du modèle 2 étaient inférieures à la valeur minimale du coût total du modèle 1. Cela indique que la variation de qualité et les défauts peuvent être très coûteux s'ils ne sont pas supprimés d'un système de

fabrication. De plus, en moyenne, moins de scores d'effort de modularité ont été utilisés par le modèle 2 par rapport au modèle 1. Ainsi, d'autres modules seront ajoutés, soustraits et réajustés s'il y a des variations de qualité et des défauts. Un système de fabrication surdimensionné avec des ressources supplémentaires sera donc nécessaire en raison des problèmes liés à la qualité. Cela met en évidence le rôle de la variation de la qualité dans la sélection d'un plan de processus basé sur un coût minimum et un effort modulaire minimal.

- Les praticiens sont intéressés à améliorer la productivité de RMS en minimisant la « reconfiguration » entre les différentes opérations. Les résultats suggèrent que les efforts modulaires et la variation de la qualité doivent être analysés simultanément pour améliorer la productivité et l'efficacité globales d'un plan de processus.
- Comme la variation et les défauts sont inévitables dans une configuration de fabrication réelle, il est opportun de connaître les efforts modulaires supplémentaires nécessaires en raison de cette variation. Cela permettra à un praticien de décider dès le départ, du nombre de modules supplémentaires ajoutés/soustraits/réajustés en présence de variation. Les résultats de cet article s'appliquent à tout système RMS réel pour calculer les besoins modulaires supplémentaires en présence de variations et de défauts.
- Les modèles et les approches de solution proposés sont généraux et peuvent être appliqués à plusieurs systèmes RMS réels. Pour cela, le graphique acyclique et les détails opérationnels des produits considérés seront nécessaires.
- L'approche méta-heuristique hybride était efficace par rapport à l'application autonome de la méta-heuristique. Il en a résulté des solutions uniformément distribuées et dominantes en raison de la fusion des capacités de stockage de solutions des deux méta-heuristiques. De plus, le critère de la meilleure amélioration fonctionne bien ; cependant, il faut plus de temps pour renvoyer les solutions.
- L'impact de multiples sources de variation a été étudié mathématiquement sur le coût global, la qualité et l'efficacité de la modularité de la planification des processus. La robustesse des approches présentées et la précision du système de fabrication intégré reconfigurable (RIMS) peuvent être validées en comparant leurs résultats respectifs. RIMS peut être utilisé pour obtenir le comportement en temps réel de RMS sous variation de qualité et défauts. Ce comportement en temps réel peut être comparé aux résultats proposés par le modèle mathématique présenté. De cette façon, le modèle mathématique peut fournir un aperçu théorique de la performance de RMS sous réserve de différents problèmes liés à la qualité.

Pour résumer, ces résultats soulignent le rôle de la variation de la qualité dans le choix de la planification des processus. Bien que le coût et la modularité aient été analysés dans la littérature

publiée ; toutefois, aucune des recherches existantes ne relie à la fois les fonctions objectives à la variation de la qualité et les défauts d'un système de fabrication reconfigurable. À cette fin, cette recherche a pris en compte de nouveaux aspects de la qualité dans la conception de la planification des processus RMS basée sur les coûts et la modularité. La fonction objective du coût contenait de nouveaux composants du coût de la ferraille, du coût de reprise et de la performance perturbatrice des machines liées aux problèmes de qualité. De même, la fonction d'objectif de modularité a été définie en tenant compte de l'effort perdu en raison de la production d'unités d'exploitation défectueuses. Cette analyse peut être étendue en analysant les coûts liés aux temps d'arrêt des machines, aux erreurs des travailleurs, à la maintenance planifiée et non planifiée. En plus de la caractéristique de modularité RMS, les recherches futures peuvent intégrer d'autres caractéristiques RMS telles que l'évolutivité, le diagnostic, la personnalisation, etc. en présence de variations de qualité. Par exemple, l'efficacité de l'évolutivité dans la planification des processus RMS peut être analysée en répondant à des questions telles que la difficulté ou la facilité avec laquelle un RMS peut être mis à l'échelle vers le haut / vers le bas en présence de variations de qualité et de défauts ?

### 3.2. Recommandations et perspectives

Afin d'étendre la portée de la planification des processus RMS dans les entreprises futures, certaines recommandations peuvent servir de ligne directrice pour faire progresser la rigueur de la planification des processus en entreprenant des exigences de recherche plus avancées. Ces recommandations et perspectives sont données comme suit :

- Le modèle a été mis en œuvre pour le cas d'une seule unité de produit. L'analyse peut être étendue et appliquée à la planification de plusieurs processus de produits. RMS est un système de fabrication coûteux et nécessite un investissement initial lourd. Ainsi, il peut être avantageux d'effectuer la planification du processus pour plusieurs produits afin de justifier l'investissement dans un système de fabrication reconfigurable.
- Cette recherche était basée sur des informations a priori de différents aspects du modèle mathématique. Un modèle déterministe concernant les capacités de production, les perturbations et les taux de défaillance a été utilisé. Les recherches futures peuvent assouplir cette hypothèse en tenant compte des paramètres stochastiques dans le modèle. Cela offrira l'occasion de modéliser le comportement en temps réel de l'évolution des capacités de production, des profils de perturbation dynamique et des taux de défaillance stochastiques. À cet égard, des modèles mathématiques flous et des chaînes de Markov peuvent être utilisés pour capturer les aspects stochastiques.

- Une approche pessimiste a été adaptée pour l'évaluation des différents défauts. À cet égard, l'indice de désintégration de la qualité (QDI) a été calculé pour la pire configuration (configuration pessimiste), par conséquent, seul un simple graphique acyclique dirigé était nécessaire. Les recherches futures permettent de calculer la dégradation de la qualité pour toutes les configurations possibles. Cela nécessitera une analyse approfondie des causes globales de la variation de la qualité, des perturbations et des défauts.

- Les causes de la variation de la qualité, c'est-à-dire les causes liées à la machine, au processus et à l'outillage, ont été calculées isolément. Cette hypothèse peut être modifiée en considérant l'interaction entre différents défauts au niveau de la machine, du processus et de l'outil. En outre, la portée de la planification des processus peut être renforcée en analysant simultanément différents niveaux, c'est-à-dire la gestion, la production et le niveau de la machine d'un système de fabrication reconfigurable complexe.

- Dans ce travail, l'algorithme génétique de tri non dominé (NSGA-II), l'optimisation de l'essaim de particules multi-objectifs (MOPSO) et leur forme hybride, c'est-à-dire NSGA-II-MOPSO, ont été utilisés. Les résultats peuvent être comparés à d'autres approches évolutives telles que l'algorithme d'optimisation des baleines (WOA) et l'algorithme évolutif de Pareto de force (SPEA-II). Cette pratique peut également mettre en évidence la puissance de calcul et l'efficacité de la solution de la méta-heuristique hybride proposée.

- Les paramètres d'entrée de l'optimisation de l'essaim de particules multi-objectifs (MOPSO) ont été réglés à l'aide d'un ensemble d'expériences. Le réglage est une phase importante car il assure les performances optimales d'une méta-heuristique. Dans les recherches futures, une approche d'auto-adaptation pour le raffinement des paramètres d'entrée de MOPSO qui est une technique de recherche populaire peut être adaptée.

Dans l'approche  $\epsilon$ -contrainte implémentée, la boucle est terminée lorsque les valeurs epsilon liées à l'indice de désintégration de la qualité (QDI) ou à l'effort de modularité (ME) ne peuvent plus être réduites. Cela a été fait en utilisant un opérateur 'et' entre les deux epsilons. Les recherches futures peuvent utiliser un opérateur « ou » afin que les valeurs epsilon des deux contraintes puissent être saturées. Cela pourrait se traduire par des solutions améliorées pour un ensemble différent de problèmes.

- L'analyse présentée s'est concentrée sur les causes des variations au cours de la production. La cause de la variation avant la production, c'est-à-dire la déficience dans la qualité des matières premières, peut être modélisée dans les recherches futures. De cette façon, la planification des processus peut

être effectuée dans le contexte de la chaîne d’approvisionnement en analysant la qualité des matières premières et l’évaluation des fournisseurs.

- Davantage d’études doivent modéliser le rôle de l’opérateur humain, car l’affectation d’un opérateur humain à différentes machines peut avoir un impact sur la qualité de la planification des processus. En outre, il est nécessaire de se concentrer davantage sur la recherche pour améliorer les performances de la planification des processus sous réserve d’erreurs aléatoires, de temps d’arrêt des machines, etc. Cela peut être fait en tenant compte de la caractéristique de diagnostic d’un système de fabrication reconfigurable.

## References

135. Koren, Y., Heisel, U., Jovane, F., Moriwaki, T., Pritschow, G., Ulsoy, G., & Van Brussel, H. (1999). Reconfigurable manufacturing systems. *CIRP annals*, 48(2), 527-540.
136. Koren, Y. (2006). General RMS characteristics. Comparison with dedicated and flexible systems. In *Reconfigurable manufacturing systems and transformable factories* (pp. 27-45). Springer, Berlin, Heidelberg.
137. Koren, Y., Gu, X., & Guo, W. (2018). Reconfigurable manufacturing systems: Principles, design, and future trends. *Frontiers of Mechanical Engineering*, 13(2), 121-136.
138. Koren, Y., Gu, X., & Guo, W. (2018). Choosing the system configuration for high-volume manufacturing. *International Journal of Production Research*, 56(1-2), 476-490.
139. Whitney, D. E. (2004). Mechanical assemblies: their design, manufacture, and role in product development (Vol. 1). *New York: Oxford university press*.
140. Musharavati, F., & Hamouda, A. S. M. (2012). Enhanced simulated-annealing-based algorithms and their applications to process planning in reconfigurable manufacturing systems. *Advances in Engineering Software*, 45(1), 80-90.
141. Cochran, D. S., Arinez, J. F., Duda, J. W., & Linck, J. (2001). A decomposition approach for manufacturing system design. *Journal of manufacturing systems*, 20(6), 371-389.
142. Spearman, M. L., & Hopp, W. J. (1996). *Factory Physics: Foundations of Manufacturing Management*. Irwin, Chicago, IL, 439.
143. Farid, A. M. (2008). Facilitating ease of system reconfiguration through measures of manufacturing modularity. *Proceedings of the Institution of Mechanical Engineers, Part B: Journal of Engineering Manufacture*, 222(10), 1275-1288.
144. Benderbal, H. H., Dahane, M., & Benyoucef, L. (2018). Modularity assessment in reconfigurable manufacturing system (RMS) design: an Archived Multi-Objective Simulated Annealing-based approach. *The International Journal of Advanced Manufacturing Technology*, 94(1), 729-749.
145. Massimi, E., Khezri, A., Benderbal, H. H., & Benyoucef, L. (2020). A heuristic-based non-linear mixed integer approach for optimizing modularity and integrability in a sustainable reconfigurable manufacturing environment. *The International Journal of Advanced Manufacturing Technology*, 108, 1997-2020.

146. Youssef, A. M., & ElMaraghy, H. A. (2007). Optimal configuration selection for reconfigurable manufacturing systems. *International Journal of Flexible Manufacturing Systems*, 19(2), 67-106.
147. Battaïa, O., Dolgui, A., & Guschinsky, N. (2020). Optimal cost design of flow lines with reconfigurable machines for batch production. *International Journal of Production Research*, 58(10), 2937-2952.
148. Moghaddam, S. K., Houshmand, M., Saitou, K., & Fatahi Valilai, O. (2020). Configuration design of scalable reconfigurable manufacturing systems for part family. *International Journal of Production Research*, 58(10), 2974-2996.
149. Deif, A. M., & ElMaraghy, W. (2007). Investigating optimal capacity scalability scheduling in a reconfigurable manufacturing system. *The International Journal of Advanced Manufacturing Technology*, 32(5-6), 557-562.
150. Dou, J., Li, J., & Su, C. (2016). Bi-objective optimization of integrating configuration generation and scheduling for reconfigurable flow lines using NSGA-II. *The International Journal of Advanced Manufacturing Technology*, 86(5), 1945-1962.
151. Bensmaine, A., Dahane, M., & Benyoucef, L. (2013). A non-dominated sorting genetic algorithm-based approach for optimal machines selection in reconfigurable manufacturing environment. *Computers & Industrial Engineering*, 66(3), 519-524.
152. Taguchi, G., & Rafanelli, A. J. (1994). Taguchi on robust technology development: bringing quality engineering upstream. 161
153. Thornton, A. C. (1999). A mathematical framework for the key characteristic process. *Research in engineering design*, 11(3), 145-157.
154. Mittal, K. K., & Jain, P. K. (2014). An overview of performance measures in reconfigurable manufacturing system. *Procedia engineering*, 69, 1125-1129.
155. Cochran, D., & Rudolf, H. (2003). Investment and resource allocation Methodology to support manufacturing system Design Implementation. *Journal of Manufacturing Systems CIRP*.



### **L'analyse de la qualité dans un système de fabrication reconfigurable**

Cette recherche visait à analyser la qualité de la planification des processus dans un système de fabrication reconfigurable (RMS). RMS est un système de fabrication complexe qui rend difficile l'analyse de la qualité des produits. S'appuyant sur la décomposition de la conception du système de fabrication, un modèle multi-objectifs a été proposé qui comprenait les fonctions objectives du coût total, de l'indice de dégradation de la qualité et de l'effort de modularité. Chaque fonction objective a été modélisée en tenant compte de la qualité du produit. Le modèle a été implémenté en utilisant une version hybride de deux méta-heuristiques puissantes et de deux critères de terminaison. De plus, deux études de cas industriels ont été utilisées pour analyser la performance du modèle. Les résultats ont mis en évidence le compromis entre les trois fonctions objectives et l'importance d'analyser simultanément la qualité et la modularité pour une performance optimale d'un système de fabrication. Cette recherche a également examiné l'ensemble des connaissances dans la planification des processus de RMS en utilisant plusieurs aspects théoriques et de mise en œuvre.

**Mots-clés:** Système de fabrication reconfigurable, planification des processus, qualité, modularité, optimisation, méta-heuristique hybride.

### **Quality analysis in a reconfigurable manufacturing system**

This research aimed to analyse the quality of process planning in a reconfigurable manufacturing system (RMS). RMS is a complex manufacturing system that makes it difficult to analyse product quality. Drawing upon manufacturing system design decomposition, a multi-objective model was proposed that comprised the objective functions of the total cost, the quality decay index, and the modularity effort. Each objective function was modelled keeping in view the product quality. The model was implemented by using a hybrid version of two powerful meta-heuristics and two termination criteria. In addition, two industrial case studies were used to analyse the performance of the model. The findings highlighted the trade-off among the three objective functions and the importance of simultaneously analysing the quality and the modularity for optimal performance of a manufacturing system. This research also reviewed the body of knowledge in the process planning of RMS by using several theoretical and implementation aspects.

**Keywords:** Reconfigurable manufacturing system, process planning, quality, modularity, optimization, hybrid meta-heuristics.