



**HAL**  
open science

# Surrogate model and optimization for dynamic tolerance allocation and assembly strategies

Amirhossein Khezri

► **To cite this version:**

Amirhossein Khezri. Surrogate model and optimization for dynamic tolerance allocation and assembly strategies. Risques. HESAM Université, 2023. English. NNT : 2023HESAE032 . tel-04174015

**HAL Id: tel-04174015**

**<https://pastel.hal.science/tel-04174015v1>**

Submitted on 31 Jul 2023

**HAL** is a multi-disciplinary open access archive for the deposit and dissemination of scientific research documents, whether they are published or not. The documents may come from teaching and research institutions in France or abroad, or from public or private research centers.

L'archive ouverte pluridisciplinaire **HAL**, est destinée au dépôt et à la diffusion de documents scientifiques de niveau recherche, publiés ou non, émanant des établissements d'enseignement et de recherche français ou étrangers, des laboratoires publics ou privés.

**ÉCOLE DOCTORALE SCIENCES DES MÉTIERS DE L'INGÉNIEUR**  
**[Laboratoire de Conception, Fabrication et Commande – Campus de Metz]**

# THÈSE

présentée par : **Amirhossein KHEZRI**

soutenue le : **02 June 2023**

pour obtenir le grade de : **Docteur d'HESAM Université**

préparée à : **École Nationale Supérieure d'Arts et Métiers**

Spécialité : **Génie mécanique**

## **Surrogate model and optimization for dynamic tolerance allocation and assembly strategies**

THÈSE dirigée par :

**Prof. Jean-Yves DANTAN**

et co-encadrée par :

**MCf. Lazhar HOMRI et MCf. Alain ETIENNE**

### **Jury**

**M. Nabil ANWER**, Professeur, Paris Saclay University

**Mme. Kristina WARMEFJORD**, Professeure, Chalmers University of Technology

**Mme. Olga BATTIAA**, Professeure, Kedge Business School

**M. Benjamin SCHLEICH**, Professeur, Technical University of Darmstadt

**M. Jean-Yves DANTAN**, Professeur, Arts et Métiers

**M. Alain ETIENNE**, Maître de conférences, Arts et Métiers

**M. Lazhar HOMRI**, Maître de conférences, Arts et Métiers

Président

Rapporteuse

Rapporteuse

Rapporteur

Examineur

Examineur

Examineur

**T  
H  
È  
S  
E**



## Acknowledgments

As a tradition, I would like to take this opportunity to express my deepest gratitude to the individuals who have been instrumental in the successful completion of my PhD journey. This achievement would not have been possible without the support, encouragement, and guidance of numerous individuals who have been influential in my success.

First and foremost, throughout this journey, I had the privilege of working alongside brilliant mentors and collaborators who have shaped my research and contributed to my growth as a researcher. I extend my heartfelt gratitude to Prof. Jean-Yves Dantan, Dr. Alain Etienne, and Dr. Lazhar Homri for their invaluable guidance, encouragement, and collaborative spirit. Moreover, I would like to express my thanks to Prof. Gisela Lanza for hosting me in WBK Institute of Production Science.

Also, I would like to extend my sincere appreciation to the esteemed jury members Prof. Nabil Anwer, Prof. Kristina Wärmefjord, Prof. Olga Battaia, Prof. Benjamin Schleich who evaluated my work. Their expertise, valuable feedback, and rigorous evaluation have played a crucial role in shaping the quality and impact of my research.

Moreover, I am grateful to the supervisory doctoral committee, Prof. Nabil Anwer and Prof. Denis Teissandier, for the time that they invested in evaluating the progress of my research work and who provided me with encouraging comments and suggestions.

Last but not least, my heartfelt appreciation to my family, friends, colleagues (in LCFC and WBK) and loved ones for their unwavering support, understanding, and encouragement. Your belief in me has been a constant source of inspiration, and I am grateful for your presence in my life.

با سپاس از همگی،

Je vous remercie à toutes et tous,

Thank you all,

Amir

*To my parents,*

*Marzieh and Saeed,*

*And my sister,*

*Sarvenaz,*

*Without their true love none of my success would be possible*

*تقدیم به مامان، بابا و سروناز*



## List of Abbreviations and Acronyms

<b>AI</b>	Artificial Intelligence
<b>ANN</b>	Artificial Neural Network
<b>BM</b>	Binning Method
<b>DCT</b>	Discrete Cosine Transform
<b>DE</b>	Differential Evolution
<b>DED</b>	Direct Energy Deposition
<b>DOF</b>	Degree of Freedom
<b>DP-SDT</b>	Deviation Propagation and Small Displacement Torsor
<b>ECM</b>	Electro Chemical Machining
<b>EDM</b>	Electric Discharge Machining
<b>EMS</b>	Estimated Mean Shift
<b>FDM</b>	Fused Deposition Modeling
<b>FORM</b>	First-Order Reliability Method
<b>GA</b>	Genetic Algorithm
<b>GD&amp;T</b>	Geometric Dimensioning & Tolerancing
<b>GOQC</b>	Global Optimum Quality Criterion
<b>GPS</b>	Geometrical Product Specification
<b>IA</b>	Individual Assembly
<b>KC</b>	Key Characteristic
<b>KDE</b>	Kernel Density Estimation
<b>KTE</b>	Kinematic Transmission Error
<b>LDA</b>	Linear Discrimination Analysis
<b>LHS</b>	Latin Hyperbolic Sampling
<b>ML</b>	Machine Learning
<b>MLP</b>	Multi-Layer Perception
<b>MMD</b>	Metric Modal Decomposition

<b>MRSS</b>	Modified Root Square Sum
<b>MS</b>	Mixed Strategy
<b>MSSP</b>	Motorola Six Sigma Program
<b>NB</b>	Naive Bayes
<b>NMC</b>	Number of Monte-Carlo
<b>PACV</b>	Proportioned Assembly Clearance Volume
<b>PCA</b>	Principal Component Analysis
<b>PLB</b>	Practical Limit
<b>PNM</b>	Paired Number Maximization
<b>QCIM</b>	Quality Criterion Inertia Minimization
<b>QCMM</b>	Quality Criterion Mean Maximization
<b>RA</b>	Random Assembly
<b>RP</b>	Reciprocal Power
<b>RSS</b>	Root Square Sum
<b>SA</b>	Selective Assembly
<b>SADE</b>	Self-Adaptive Differential Evolution
<b>SDT</b>	Small displacement Torsor
<b>SLA</b>	Stereolithography
<b>SLS</b>	Selective Laser Sintering
<b>ST</b>	Sensitivity Order
<b>SVC</b>	Support Vector Classifier
<b>TTRS</b>	Topologically and Technologically Related Surfaces
<b>VDI</b>	Verein Deutscher Ingenieure (Association of German Engineers)
<b>WC</b>	Worst-Case
<b>WP</b>	Work Package



## List of contents

### French

Introduction et vue d'ensemble .....	1
a. Définition du problème .....	1
b. Portée de la thèse et questions scientifiques .....	2
c. Contexte du projet AdeQuaT .....	2
d. Méthodologie de recherche.....	2
e. Approches et outils.....	3
f. Plan de la thèse.....	4
g. Liste des publications .....	5
Chapter I: Une étude approfondie des questions de tolérancement et des stratégies de production ...	7
I.1. Abstract.....	7
I.2. Conclusions .....	7
Chapter II: Définition d'un modèle de substitution pour l'analyse statistique de la tolérance .....	9
II.1. Abstract .....	9
II.2. Conclusions.....	9
Chapter III: Intégration et optimisation des stratégies de production dans l'attribution des tolérances .....	11
III.1. Abstract.....	11
III.2. Conclusions.....	11
Chapter IV: Sélection de la stratégie d'assemblage la plus adaptée .....	13
IV.1. Abstract.....	13
IV.2. Conclusions .....	13
Chapter V: Conclusions et perspectives .....	15
V.1. Conclusions.....	15
V.2. Limites critiques .....	18
V.3. Perspectives.....	19

## English

Introduction and overview .....	23
a. Problem definition.....	23
b. Scope of the thesis and scientific issues .....	24
c. AdeQuaT project context.....	26
d. Research Methodology .....	28
d.1. Overrunning clutch.....	28
d.2. Electric motor .....	29
d.3. Gears.....	30
e. Approaches and tools .....	31
f. Thesis outline .....	32
g. List of publications.....	34
Chapter I: A comprehensive study on tolerancing issues and production strategies.....	37
I.1. Tolerancing issues.....	39
I.1.1. Tolerance analysis .....	39
I.1.2. Behavior models .....	41
I.1.3. Tolerance analysis techniques .....	42
I.1.4. Cost-tolerance optimization.....	47
I.2. Production strategies in tolerance allocation optimization .....	49
I.2.1. Resource allocation.....	49
I.2.2. Reworking.....	50
I.2.3. Assembly strategies.....	51
I.3. Conclusion.....	52
Chapter II: Defining a surrogate model for statistical tolerance analysis .....	57
II.1. Development of a novel statistical tolerance analysis model .....	59
II.1.1. Statistical tolerance analysis model description .....	59
II.1.2. Statistical tolerance analysis model formulation .....	60
II.2. Statistical tolerance analysis applications .....	62
II.2.1. Simulation-assisted approach: application on the overrunning clutch.....	62
II.2.2. Physical behavior surrogate-assisted approach: application on the electric motor .....	65

II.3. Statistical AI-assisted approach development: application on the gears.....	69
II.3.1. Gear numerical simulation.....	69
II.3.2. Initial sampling and experimental design.....	73
II.3.3. Imbalanced data refining and surrogate modeling .....	75
II.3.4. Surrogate model.....	76
II.4. Conclusion .....	77
Chapter III: Integrating and optimizing production strategies in tolerance allocation .....	79
III.1. Activity-based cost-tolerance realization .....	81
III.2. Proposed cost-tolerance model adaptation and applications.....	84
III.2.1. Simulation-assisted tolerance optimization of the overrunning clutch .....	84
III.2.2. Physical behavior surrogate-assisted tolerance optimization of electric motor mechanism tolerancing .....	87
III.2.3. Statistical surrogate-assisted tolerance optimization for micro gear designs .....	93
III.3. Conclusion.....	96
Chapter IV: Selecting the fittest assembly strategy .....	99
IV.1. Introduction .....	101
IV.2. Random assembly.....	102
IV.3. Selective assembly (SA) .....	104
IV.3.1. KC identification.....	104
IV.3.2. Binning methods.....	105
IV.3.3. Bins combination criteria .....	107
IV.3.4. Mixed Strategy (MS) solutions .....	109
IV.4. Individual assembly (IA): Global Optimum Quality Criterion (GOQC).....	111
IV.5. Proposed assemblies applications .....	113
IV.5.1. Electric motor assembly strategies analyses.....	113
IV.5.2. Gears assembly strategies analyses .....	120
IV.6. Conclusions .....	128
Chapter V: Conclusions and perspectives .....	131
V.1. Conclusions.....	133
V.2. Critical limitations .....	136

V.3. Perspectives.....	137
References .....	141
Appendices.....	152
Appendix I: Numerical simulation of geometric deviations on gears .....	152
Appendix II: Sobol sensitivity analysis.....	153
Appendix III: Finding data depository.....	154
Appendix IV: Trained neural network architecture .....	155
Appendix V: Complementary cost-tolerance optimization results .....	156

## List of figures

<b>Figure 1.</b> The ubiquitous role of tolerances in a product life cycle (Hong & Chang, 2002) .....	23
<b>Figure 2.</b> AdeQuaT project work packages.....	26
<b>Figure 3.</b> Overrunning clutch mechanism .....	29
<b>Figure 4.</b> Electric motor mechanism .....	29
<b>Figure 5.</b> A pair of spur and crown wheel in a dental drill (Sirona, 2023) .....	30
<b>Figure 6.</b> Geometric errors on gears (Bruyere et al., 2007) .....	31
<b>Figure 7.</b> Thesis outlines overview.....	33
<b>Figure 8.</b> Nominal surfaces, substitute surfaces, and skin surfaces in a 2D projection .....	39
<b>Figure 9.</b> Comparison of available cost-tolerance models. ....	48
<b>Figure 10.</b> Tolerance analysis issues literature .....	53
<b>Figure 11.</b> Simulation-assisted approach flowchart .....	63
<b>Figure 12.</b> Overrunning clutch simulation evaluations .....	64
<b>Figure 13.</b> Electric motor 3D and 2D representation (Goka <i>et al.</i> , 2019b).....	66
<b>Figure 14.</b> Technical representations of the electric motor components in 2D and 3D (Goka <i>et al.</i> , 2019b) .....	67
<b>Figure 15.</b> Surrogate percentage error references to the simulation .....	68
<b>Figure 16.</b> Tolerance analysis techniques runtime comparison for different cases.....	69
<b>Figure 17.</b> Use case.....	70
<b>Figure 18.</b> Simulated gears' meshing and evaluated KTE value over 200 Monte-Carlo runs .....	71
<b>Figure 19.</b> Simulation evaluation (percent error and runtime analysis) .....	72
<b>Figure 20.</b> Employed design of experiment methods for a small experience batch.....	73
<b>Figure 21.</b> Target value occurrence frequency associated with a variety run number of simulations	74
<b>Figure 22.</b> Dataset training illustration .....	75
<b>Figure 23.</b> Comparison of imbalanced and balanced trained surrogate models .....	76
<b>Figure 24.</b> Surrogate model inputs and outputs.....	77
<b>Figure 25.</b> Statistical surrogate model process .....	78
<b>Figure 26.</b> Manufacturing activities.....	81
<b>Figure 27.</b> Genetic algorithm chromosome, crossover, and mutation presentations .....	85

<b>Figure 28.</b> Optimization results related to the overrunning clutch.....	86
<b>Figure 29.</b> Precise assembly ( $ty = 0.3$ ) cost and conformity analyses .....	87
<b>Figure 30.</b> Adapted optimization approach.....	89
<b>Figure 31.</b> Genetic algorithm chromosome, crossover, and mutation presentations.....	89
<b>Figure 32.</b> Optimal cost and components conformity rates associated with each scenario.....	90
<b>Figure 33.</b> Genetic algorithm optimization results.....	91
<b>Figure 34.</b> SaDE algorithm tuning parameters evaluation.....	94
<b>Figure 35.</b> Surrogate-assisted optimization results .....	96
<b>Figure 36.</b> Adaptive assembly approach .....	102
<b>Figure 37.</b> Random assembly simulation using Monte-Carlo .....	103
<b>Figure 38.</b> Sobol sensitivity analysis.....	105
<b>Figure 39.</b> Binning methodology techniques.....	106
<b>Figure 40.</b> Exemplary assembly of two components .....	107
<b>Figure 41.</b> Individual assembly of the electric motor.....	112
<b>Figure 42.</b> Evaluated response for all the possible combinations of the houses, bodies, and shafts .....	114
<b>Figure 43.</b> Electric motor KC identification using Sobol indices .....	115
<b>Figure 44.</b> Overall combination evaluation for electric motor assembly.....	116
<b>Figure 45.</b> Random internal assembly among optimal combinations.....	117
<b>Figure 46.</b> Electric motor assembly strategies comparison.....	119
<b>Figure 47.</b> Gears KC identification using Sobol indices.....	122
<b>Figure 48.</b> Overall combination evaluation for gear pairing .....	125
<b>Figure 49.</b> Random internal pairing among optimal combinations .....	126
<b>Figure 50.</b> Gears' pairing strategies comparison.....	127
<b>Figure 51.</b> Thesis's established framework and contributions .....	134
<b>Figure 52.</b> uncertainty in the tolerancing field .....	138
<b>Figure 53.</b> Complementary information related to Figure 28.....	157
<b>Figure 54.</b> Complementary information related to Figure 33.....	157

## List of tables

<b>Table 1.</b> Adapted tolerance analysis and tolerance allocation approaches .....	32
<b>Table 2.</b> Current geometrical models (adopted from Dumas <i>et al.</i> (2015)).....	40
<b>Table 3.</b> Comparison of the behavior models between the displacement accumulation approach and the tolerance accumulation approach (adopted from Dumas <i>et al.</i> (2015)).....	42
<b>Table 4.</b> Comparison of tolerance analysis methods between the displacement accumulation approach and the tolerance accumulation approach (adopted from Dumas <i>et al.</i> (2015)).....	44
<b>Table 5.</b> Cost-tolerance optimization and concurrent problems literature .....	55
<b>Table 6.</b> Simulation time and accuracy comparison for a population of 40,000.....	74
<b>Table 7.</b> Manufacturing data for the overrunning clutch.....	85
<b>Table 8.</b> Nominal designs values on dimensions .....	88
<b>Table 9.</b> Manufacturing data for the electric motor .....	88
<b>Table 10.</b> Optimally allocated tolerances and resources .....	90
<b>Table 11.</b> Simulation and surrogate models obtained cost assembly, and functionality rates relate to each scenario.....	92
<b>Table 12.</b> Optimization test sets .....	94
<b>Table 13.</b> Optimal IA assemblies.....	115
<b>Table 14.</b> SA binning methods and combination criterion assessment.....	118
<b>Table 15.</b> Evaluated KTE for all the possible combinations of the spur gears and crown wheels	120
<b>Table 16.</b> Optimal IA pairs.....	121
<b>Table 17.</b> Binning methods comparison for the gear pairing.....	122
<b>Table 18.</b> SA binning methods and combination criterion assessment.....	124
<b>Table 19.</b> A brief review of the applications and implementations.....	136
<b>Table 20.</b> Simulated gears dataset representation .....	155

## Résumé étendu en Français





# Introduction et vue d'ensemble

## a. Définition du problème

Le monde industriel d'aujourd'hui est confronté à une demande croissante de produits sûrs et à haute fiabilité que ce soit le secteur d'application : automobile, médecine et aéronautique. Les industries complexes requièrent un processus de développement bien conçu, avec une compréhension globale des diverses données et incertitudes qui surviennent dans la pratique. À tous les stades du développement d'un produit et tout au long de son cycle de vie, l'incertitude est omniprésente et engendre des risques. Le risque peut avoir une incidence sur les performances du produit, l'organisation du processus de fabrication, l'acceptation du marché ou l'ensemble de l'entreprise. Pour atténuer ces risques et réduire leurs effets, de nombreuses activités de conception sont réalisées pour étudier en profondeur les concepts d'incertitude, de risque et de tolérance (Morse et al., 2018).

En outre, le besoin de composants plus précis a un impact sur le développement du tolérancement. La tolérance est un élément essentiel qui fait le lien entre la conception et la fabrication, et l'omniprésence des tolérances concerne toutes les étapes du cycle de vie d'un produit (voir la figure 1). Étant donné que le rôle des tolérances dans le cycle de vie varie d'une étape à l'autre, en fonction des objectifs de conception, il est crucial pour les concepteurs de définir et de quantifier une tolérance qui traduisent les exigences de conception. Ainsi, la gestion des tolérances doit répondre aux contraintes de fonctionnalité et/ou d'assemblabilité ainsi qu'aux capacités limitées des processus de fabrication (Hong & Chang, 2002).

Sur ces bases, l'introduction de nouvelles technologies a élargi le champ d'application du tolérancement. La performance finale des produits complexes dépend en fin de compte de leur fabrication et de leur assemblage en fonction des circonstances internes et externes du moment. Les fonctionnalités clés des produits complexes peuvent souvent être assurées par l'utilisation de composants de haute précision. Les fabricants sont donc confrontés à des exigences de haute qualité, à une pression sur les coûts et à un nombre croissant de variantes de produits. Pour évaluer les effets des tolérances et comprendre leurs contributions sur le comportement du système, il est nécessaire d'identifier les relations entre les tolérances et les caractéristiques fonctionnelles par un ensemble d'expériences et/ou de simulations numériques. Les microcomposants ou les composants présentant

des micros caractéristiques, dont les tolérances sont inférieures à 5  $\mu\text{m}$ , sont particulièrement difficiles à étudier. L'étude de composants complexes tels que les engrenages est donc également basée sur des expériences ou des simulations numériques.

### **b. Portée de la thèse et questions scientifiques**

Comme expliqué dans la précédente introduction, la thèse vise à développer un outil d'optimisation pour trouver une allocation des tolérances appropriée, où les concepts de tolérancement adaptatif et de stratégies de production adaptatives sont intégrés. L'importance de produits fiables et bien conçus a été imposée par le partenaire industriel pour gérer les écarts qui peuvent survenir au cours de la production. Il est donc devenu impératif d'identifier la nature et les sources d'écarts puis d'en quantifier l'impact. De manière plus synthétique, cette thèse explore la présence de l'incertitude (écarts géométriques principalement) dans le domaine de la conception.

Les concepts de la thèse peuvent être définis en plusieurs questions clés et décomposées en sous-problématiques scientifiques :

**Quelle est la méthodologie à suivre pour créer un produit fiable par la mise en œuvre du tolérancement adaptatif et l'atténuation des écarts ?**

**Quelle est la manière la plus efficace d'ajuster les tolérances dans le domaine de l'allocation adaptative de la tolérance, compte tenu des différentes stratégies de production disponibles ?**

**Quel est l'effet de l'intégration des approches d'assemblage adaptatives sur l'amélioration de la qualité d'assemblage au sein de la production ?**

### **c. Contexte du projet AdeQuaT**

Le projet ANR AdeQuaT a pour objectif d'étudier le comportement des micro-engrenages. Ce projet est mené par deux universités européennes : l'École Nationale Supérieure d'Arts et Métiers (France) et le Karlsruher Institut für Technologie (Allemagne). Le projet AdeQuaT est divisé en sous-projets appelés Work Packages (WP). Cette division vise à examiner séparément quatre types de problèmes qui sont illustrés dans la figure 2.

#### **d. Méthodologie de recherche**

Cette recherche vise à développer une méthodologie d'optimisation basée sur des méta-modèles prenant en compte des variantes d'allocation des tolérances de produits et de stratégies de production. De plus, cette démarche considère et intègre des stratégies adaptatives de tolérancement et de production, la dimension économique est également prise en compte par la définition d'un modèle de coût modulaire. Dans le cadre de ces travaux de recherche, une nouvelle approche systémique d'allocation des tolérances et d'application de stratégies d'assemblage est développée, évaluant à la fois les performances techniques et économiques du produit. Cette approche rassemble les exigences de conception technique, les indicateurs de performance, les écarts de fabrication probabilistes et les incertitudes d'inspection dans un modèle commun, où les effets du tolérancement adaptatif et des stratégies de production sur la conception, la fabrication et les performances fonctionnelles du produit sont quantitativement évalués.

Afin de déterminer les effets des tolérances et de comprendre leurs contributions sur le comportement du système, il est nécessaire d'identifier les relations entre celles-ci et les caractéristiques fonctionnelles par un ensemble d'expériences ou de simulations numériques. Par conséquent, pour développer une approche applicable, celle-ci est divisée en deux étapes : l'analyse des tolérances et l'allocation des tolérances. L'approche développée est alors appliquée à différents cas d'études afin d'être vérifiée et testée sur des mécanismes à la complexité croissante et représentatives du besoin industriel.

#### **e. Approches et outils**

Le développement de la méthode d'optimisation basée sur un méta-modèle repose sur l'utilisation de différentes méthodes analytiques. Ces méthodes sont étudiées en fonction de la complexité du mécanisme d'assemblage étudié et de la disponibilité des ressources qu'elles soient informatiques ou des données empiriques ou obtenus par le biais d'expériences. L'approche varie d'un cas d'étude à l'autre. Pour être plus explicite, la sensibilité de l'exigence fonctionnelle d'embrayage d'un mécanisme de roue libre est étudiée en développant une simulation de Monte Carlo. La fonctionnalité du moteur électrique est réalisée par une simulation de Monte-Carlo proposée dans la littérature. Ensuite, un modèle physique de substitution est construit sur le modèle de simulation. L'augmentation de la complexité du dernier cas traité, à savoir le micro engrenage a nécessité l'établissement d'un

modèle de substitution statistique à l'aide de techniques d'apprentissage automatique et de prédiction. Les approches et les outils sont détaillés dans le tableau 1.

Une fois les techniques d'analyse de tolérances établies, un modèle modulaire de coût (direct et indirect) des tolérances est développé. Ce modèle réunit l'allocation des coûts et l'analyse des tolérances dans un modèle d'optimisation. Le modèle coût-tolérance est un modèle systémique qui prend en compte les activités de fabrication et de contrôle telles que le traitement, la retouche, l'inspection, etc. Ces activités sont associées à la conformité des composants mécaniques et de l'assemblage final. Le modèle est adapté et son application est analysée pour chaque cas d'étude. L'étape suivante est axée sur l'utilisation des techniques d'analyse des tolérances dans la sélection des stratégies d'assemblage. L'approche identifie la stratégie d'assemblage la plus pratique en fonction de la réponse à l'exigence d'assemblage.

### **f. Plan de la thèse**

Le reste de cette thèse est organisé comme le synthétise la figure 7, qui donne un aperçu des questions à traiter dans le cadre de ces travaux.

**Chapitre I : Etude complète du tolérancement et des stratégies de production** Ce chapitre fournit une analyse approfondie des travaux récents en matière de tolérancement et de stratégies de production mécanique, avec un accent particulier sur l'analyse des tolérances et leur allocation. L'analyse comprend une étude de la façon dont les différentes stratégies de production, y compris l'allocation des ressources, la reprise et la sélection des stratégies d'assemblage, peuvent être intégrées dans le problème de l'allocation des tolérances. En outre, la thèse met en évidence les obstacles à traiter lors du développement de l'analyse statistique des tolérances, qui est cruciale pour la mise en œuvre réussie de l'allocation des tolérances.

**Chapitre II : Définition d'un méta-modèle pour l'analyse statistique des tolérances.** Ce chapitre est centré sur l'étude des techniques actuelles d'analyse des tolérances et sur la nécessité d'une interprétation complète des produits complexes. Ces travaux se penchent sur les avantages des outils de simulation et des techniques d'apprentissage automatique dans l'évaluation des fonctionnalités mécaniques complexes, en particulier dans le contexte de l'analyse des tolérances. La thèse se concentre spécifiquement sur l'analyse de l'utilisation de l'apprentissage automatique dans l'étude des

mécanismes assemblés complexes avec différents types d'erreurs géométriques, telles que : les erreurs d'orientation, de positionnement et dimensionnels. L'étude propose d'employer l'intelligence artificielle (IA) pour l'analyse des tolérances géométriques, ce qui garantit une approximation très précise de la prédiction de la précision des assemblages.

**Chapitre III : Intégration et optimisation des stratégies de production dans l'allocation des tolérances.** Ce chapitre étudie l'allocation des tolérances et l'intégration des stratégies de production pour optimiser le processus de production. Pour traiter cette question, un modèle de coûts, spécifique mais modulaire, est proposé qui intègre les stratégies de production lors du processus d'allocation des tolérances. Le modèle peut ainsi identifier les spécifications du produit les plus critiques pour lesquelles des tolérances serrées sont nécessaires, ce qui permet aux fabricants de trouver un équilibre entre le coût final du produit et les spécifications géométriques. Le modèle est structuré suivant une approche modulaire : chaque module ou activité est associé à son impact sur l'assemblage ou le composant, qui peut être évalué à l'aide d'une simulation ou d'une méta-modélisation, ce qui permet d'estimer l'efficacité de l'activité et du processus de production complet.

**Chapitre IV : Sélection de la stratégie d'assemblage la plus adaptée.** Ce chapitre présente une stratégie d'assemblage adaptative qui évalue plusieurs stratégies d'assemblage pour un produit assemblé spécifique, évalue la réponse en termes de qualité et identifie la stratégie la plus adaptée. L'assemblage adaptatif peut profiter aux produits de haute précision car il permet de modifier rapidement le processus d'assemblage afin d'optimiser les exigences spécifiques de chaque composant. L'approche proposée est largement applicable et souligne l'importance de cette étude des stratégies d'assemblage.

**Chapitre V : Conclusions et perspectives.** Ce chapitre conclut la présente thèse en fournissant une synthèse des travaux effectués, leurs limitations et en soulignant plusieurs perspectives qu'il serait intéressant d'explorer pour la poursuite de ces travaux.

### **g. Liste des publications**

Suite au travail réalisé dans le cadre de cette thèse, plusieurs articles ont été soumis et publiés dans des conférences et des revues

(This page left intentionally blank)

# Chapter I: Une étude approfondie des questions de tolérancement et des stratégies de production

## I.1. Abstract

L'objectif de ce chapitre est de présenter l'état de l'art dans le domaine du tolérancement et des stratégies de production dans le domaine du tolérancement. Il rapporte les études antérieures dans le domaine de l'analyse et de l'allocation des tolérances ; ensuite, il examine l'intégration des stratégies de production telles que l'allocation des ressources, le retraitement et la sélection des assemblages dans le problème de l'allocation des tolérances. Cette étude nous permet de mettre en évidence les échelles actuellement rencontrées dans le développement de l'analyse statistique des tolérances et l'intégration des stratégies de production dans le problème de l'allocation des tolérances.

## I.2. Conclusions

La comparaison détaillée des techniques d'analyse des tolérances et des modèles d'attribution des coûts et des tolérances montre les différences significatives entre les deux systèmes. Les techniques d'analyse de la tolérance sont nécessaires pour vérifier la bonne fonctionnalité de la conception technique, en tenant compte des tolérances des composants. Les problèmes liés à l'analyse de la tolérance sont décrits dans la figure 10.

L'application de diverses techniques dépend de la complexité de la conception, de l'expérience du concepteur et des données empiriques. À cet égard, des techniques statistiques telles que la simulation numérique et les approches probabilistes sont développées pour présenter une vue d'ensemble stochastique de la fonctionnalité de la conception.

Contrairement à la technique d'analyse des tolérances, l'attribution des tolérances est effectuée pour répartir les tolérances sur les caractéristiques clés (KC) des composants en incorporant des méthodes d'optimisation. La plupart des méthodes sont axées sur l'attribution de valeurs de tolérance optimales tout en minimisant la valeur du coût. Les concepteurs préfèrent des tolérances serrées pour



## *Une étude approfondie des questions de tolérancement et des stratégies de production*

---

assurer la qualité de la conception ; cependant, les fabricants préfèrent des tolérances lâches pour réduire les coûts de fabrication. La plupart des modèles d'allocation coût-tolérance proposés dans la littérature sont basés sur des modèles paramétriques qui nécessitent des études empiriques pour adapter le modèle à la conception. Néanmoins, le modèle adapté ne s'applique pas à d'autres conceptions. Un modèle de coût basé sur l'activité est une alternative à la modélisation paramétrique dans ce travail. Le modèle associe la valeur moyenne du coût par activité, telle que le traitement, l'inspection, le retraitement, l'assemblage, la mise au rebut, etc. à leur contribution à la conformité des composants. Par conséquent, le modèle facilite l'intégration d'une variété d'activités telles que l'allocation des ressources, le retraitement et l'assemblage dans le problème de l'allocation des tolérances. La littérature dans ce domaine est présentée dans le tableau 5.

Sur ces bases, la nécessité d'une technique d'analyse statistique des tolérances et d'une optimisation des coûts et des tolérances est à l'origine de l'orientation de ce travail. Ce travail développe une méthode statistique pour prédire la conformité des composants et introduit des stratégies d'allocation des ressources, de reprise et d'assemblage dans le modèle d'allocation des coûts et des tolérances afin d'améliorer le système.

# Chapter II: Définition d'un modèle de substitution pour l'analyse statistique de la tolérance

## II.1. Abstract

L'étude des techniques contemporaines d'analyse des tolérances et la nécessité pour les industries modernes de disposer d'une interprétation complète des produits complexes peuvent être considérées dans la littérature. La croissance des outils de simulation et des techniques d'apprentissage automatique en tant que deux outils informatiques cruciaux pour l'évaluation des fonctionnalités mécaniques complexes est étudiée. Par conséquent, les avantages de la simulation et de l'apprentissage automatique contribuent à la prédiction du comportement des mécanismes complexes dans des délais et avec une précision efficace. Dans cette section, l'application des outils de simulation et d'apprentissage automatique dans l'analyse de la tolérance est utilisée.

## II.2. Conclusions

Ce chapitre analyse l'application de la simulation numérique et des approches probabilistes à différentes études de cas. Une conception technique simple telle qu'un embrayage à roue libre peut être modélisée en 1D. Étant donné que les KC de la conception sont limités et indépendants, un outil de simulation tel que Monte-Carlo s'adapte à la conception et évalue efficacement le temps de réponse fonctionnel. Le passage d'une conception technique 1D à un moteur électrique 3D, qui comporte davantage d'erreurs géométriques, y compris des erreurs de rotation et de translation, démontre l'importance d'une approche peu coûteuse pour l'étude de la conception. Par conséquent, un modèle de substitution basé sur la physique est proposé pour améliorer le calcul tout en maintenant la précision de la prédiction. Plus précisément, cette thèse est consacrée à l'examen de mécanismes d'assemblage complexes qui incluent plusieurs types d'erreurs géométriques telles que rotationnelles, translationnelles et dimensionnelles. En fait, la complexité d'un assemblage peut être réalisée par la variété des erreurs et les dépendances existantes entre les erreurs.

Par conséquent, l'analyse du comportement fonctionnel d'un assemblage mécanique complexe associé à l'impact des erreurs dans la conception est coûteuse et prend du temps, ce qui implique le développement d'une approche nouvelle et efficace. La nécessité d'une approche innovante constitue la condition préalable de ce chapitre à l'application de techniques d'apprentissage automatique. À cet égard, l'examen des micro-engrenages présentant de nombreuses erreurs géométriques et dépendances a orienté la recherche vers l'utilisation de l'intelligence artificielle (IA) dans l'analyse des tolérances.

La figure 25 illustre les grandes lignes de cette section. Le processus commence par un modèle de substitution physique/de simulation et un modèle de plan d'expériences approprié qui couvre de manière homogène la zone de recherche de tolérance. Ensuite, les expériences obtenues doivent être formées et affinées dans le cadre des expériences empiriques. Enfin, une approche prédictive peut être adaptée pour former le modèle de substitution. L'application de l'IA promet une approximation très précise de la prédiction de la précision de l'assemblage. Ensuite, les approches d'analyse de la tolérance sont intégrées dans l'optimisation de l'allocation de la tolérance afin de rechercher la tolérance optimale tout en satisfaisant les exigences fonctionnelles de la conception. Le chapitre suivant propose un modèle nouveau et modulaire pour l'intégration de la technique d'analyse de la tolérance dans l'optimisation coût-tolérance.

# Chapter III: Intégration et optimisation des stratégies de production dans l'attribution des tolérances

## III.1. Abstract

L'attribution des tolérances est le processus consistant à déterminer le niveau acceptable d'écart par rapport à une valeur nominale pour chaque dimension ou caractéristique d'un produit. Les stratégies de production (par exemple, l'affectation pratique des ressources, la reprise et l'assemblage) peuvent être intégrées et optimisées en tenant compte des tolérances de chaque dimension et caractéristique lors de la conception du processus de production. Cela peut contribuer à minimiser les coûts associés et à améliorer l'efficacité en garantissant que le processus de production peut assembler des composants qui répondent à la fonctionnalité requise. Il est donc nécessaire de disposer d'un outil complet permettant de fournir une solution optimale qui réponde aux exigences de la conception ainsi qu'au processus de production.

## III.2. Conclusions

L'optimisation coût-tolérance est une méthode utilisée pour équilibrer le coût de fabrication d'un produit avec la tolérance admissible des dimensions ou des performances du produit. Dans la littérature, les méthodes d'optimisation des coûts se limitent aux modèles paramétriques qui associent l'impact de la tolérance à la variation du coût de fabrication. Ces modèles s'appuient fortement sur des données cliniques et ne sont pas facilement adaptables à différents types de produits. Cela signifie qu'ils ne peuvent pas être facilement modifiés pour répondre aux besoins spécifiques d'une variété de produits. En raison des limites des modèles paramétriques existants, qui ne tiennent compte que de l'impact de la tolérance sur les variations du coût de fabrication, un modèle spécialisé et modulaire est nécessaire. Un tel modèle doit pouvoir être ajusté pour répondre facilement aux exigences spécifiques de diverses conceptions d'assemblage.

Par conséquent, ce chapitre présente un modèle modulaire original d'optimisation des coûts et des tolérances. Contrairement aux modèles paramétriques, il permet aux concepteurs d'intégrer des stratégies de production telles que l'allocation des ressources, le retraitement et l'assemblage, dans le modèle d'allocation des tolérances alors que la valeur du coût associée à chaque module est fixe. Ce modèle vise à réduire les coûts de fabrication en identifiant et en ciblant les spécifications les plus critiques du produit pour lesquelles des tolérances serrées sont nécessaires. Il peut aider à identifier les spécifications du processus de production où le coût est élevé et la tolérance faible, ce qui permet aux fabricants d'améliorer ces spécifications et de réduire les coûts en optimisant l'équilibre entre le coût et la tolérance.

Étant donné que ce modèle est structuré comme un modèle modulaire, chaque module ou activité est associé à l'impact de l'activité sur l'assemblage ou les composants. Les impacts peuvent être évalués à l'aide d'une simulation ou d'un modèle de substitution afin d'estimer l'efficacité de l'activité. D'une part, l'optimisation de la tolérance des coûts assistée par simulation ou par un modèle de substitution est un moyen précieux pour les fabricants, car elle leur permet de trouver un équilibre entre les coûts et la qualité, ce qui se traduit par un processus de production plus efficace et plus rentable, tout en produisant des produits de haute qualité. D'autre part, cette approche est fortement dépendante du modèle de substitution, qui nécessite des techniques et des compétences approfondies pour obtenir une vue d'ensemble de la qualité de l'assemblage.

# Chapter IV: Sélection de la stratégie d'assemblage la plus adaptée

## IV.1. Abstract

La précision et la fonctionnalité d'un assemblage dépendent fortement des dimensions de ses composants, ce qui constitue la principale cause des problèmes de qualité. Généralement, la tolérance globale d'un assemblage est calculée en additionnant les tolérances de chaque composant. Cela peut rendre la fabrication des composants avec un haut niveau de précision très coûteuse et parfois impossible. Il existe d'autres méthodes, telles que l'assemblage sélectif ou l'assemblage individuel, qui permettent d'obtenir des assemblages de haute précision en utilisant des composants moins précis. Le choix de la stratégie d'assemblage la plus adaptée implique l'évaluation de différentes options et la détermination de celle qui convient le mieux à une situation particulière. Des facteurs importants tels que la complexité du produit, le volume, le coût, la qualité, etc. peuvent être pris en compte lors de la sélection d'une stratégie d'assemblage. Après avoir pris en compte ces facteurs, il est essentiel d'évaluer les différentes stratégies d'assemblage, en les comparant pour déterminer celle qui convient le mieux à l'assemblage en question.

## IV.2. Conclusions

L'assemblage est un processus qui permet de créer des produits qui fonctionnent de manière précise et fiable, et qui respectent les tolérances et les spécifications strictes exigées par diverses applications, notamment dans les secteurs de l'aérospatiale, de la médecine et de l'électronique. L'assemblage peut permettre d'accroître l'efficacité des processus de production et d'améliorer les performances des produits. Toutefois, le processus d'assemblage peut varier en fonction des exigences spécifiques de chaque assemblage. L'importance de l'assemblage devient évidente dans les assemblages complexes qui nécessitent un plan d'assemblage bien défini. Par conséquent, ce chapitre contribue à la définition primaire d'un assemblage adaptatif inventif qui reçoit le modèle d'analyse de tolérance de l'assemblage et propose la stratégie la plus adaptée en évaluant plusieurs stratégies d'assemblage. L'assemblage adaptatif peut être particulièrement bénéfique pour les produits de haute précision car il permet aux fabricants d'ajuster rapidement le processus d'assemblage afin d'optimiser

## *Sélection de la stratégie d'assemblage la plus adaptée*

---

les exigences spécifiques de chaque produit. En ajustant le processus, les fabricants peuvent améliorer la précision et la cohérence de leur assemblage, ce qui est essentiel pour les produits de haute précision.

C'est pourquoi ce chapitre propose une approche adaptative de l'assemblage. Cette approche évalue plusieurs stratégies d'assemblage pour un assemblage répondant à des exigences spécifiques, évalue la réponse en termes de qualité et renvoie la stratégie la plus adaptée qui satisfait le plus le client et le fabricant. Les résultats illustrent l'applicabilité de l'approche à un large éventail d'applications. Les analyses de différents assemblages démontrent l'importance de l'étude de la stratégie d'assemblage lorsque l'assemblage d'un assemblage peut varier d'un autre.

# Chapter V: Conclusions et perspectives

Avec l'introduction de nouvelles technologies, le besoin de produits plus compliqués s'est accru, ce qui a une incidence sur le champ d'application du tolérancement. La complexité et la fonctionnalité cruciale des produits ne sont souvent assurées que par l'utilisation de composants de haute précision tels que les micro-engrenages. Par conséquent, cette thèse s'est concentrée sur le développement d'une simulation modulaire ou d'une optimisation coût-tolérance assistée par un substitut qui intègre plusieurs stratégies de production. Les avantages et les lacunes du modèle proposé, y compris les travaux futurs visant à améliorer le modèle, sont présentés dans cette section.

## V.1. Conclusions

La performance d'un système mécanique produit est déterminée par sa conception, sa fabrication et son assemblage dans le contexte de conditions internes (par exemple, matériau de traitement, précision de traitement, précision de conception, etc.) et externes (par exemple, exigence du client, matière première, etc.). Le comportement d'assemblages tels que les micro-engrenages est souvent réalisé grâce à l'utilisation de composants de haute précision. En conséquence, les fabricants sont confrontés à des exigences de haute qualité, à une pression sur les coûts et à un nombre croissant de variantes défectueuses. Par conséquent, dans cette thèse, plusieurs assemblages sont considérés, les comportements fonctionnels sont analysés par diverses méthodes analytiques, et des modèles de substitution ont été proposés et développés. Les modèles de substitution sont destinés à estimer les effets de la tolérance et leurs contributions au comportement fonctionnel d'un assemblage.

Cette thèse contribue donc à l'analyse de systèmes assemblés complexes soumis à diverses erreurs. La complexité d'un assemblage provient des différents types d'erreurs et des relations entre elles, ce qui rend l'analyse de son comportement fonctionnel difficile et longue. Pour relever ce défi, l'utilisation de techniques d'apprentissage automatique pour développer une approche plus efficace est analysée à travers l'utilisation de l'IA dans l'analyse de tolérance pour examiner des systèmes complexes avec de nombreuses erreurs géométriques et dépendances, afin de prédire avec précision la précision de l'assemblage. Le concept de cette approche nécessite des compétences techniques et



des ressources informatiques puissantes. Néanmoins, le résultat démontre une amélioration significative en termes de rentabilité et de gain de temps.

Une fois le modèle de substitution établi, des stratégies de production telles que l'allocation des ressources, le retraitement et les stratégies d'assemblage sont proposées pour améliorer la qualité de l'assemblage ainsi que les coûts de production. Ensuite, les relations entre les tolérances, les stratégies de production et les coûts de fabrication doivent être identifiées. Un nouveau cadre consistant en un modèle coût-activité est ensuite proposé afin d'évaluer le coût de fabrication minimal tout en garantissant le niveau de qualité. L'identification des spécifications du processus de production qui ont un coût élevé et une faible tolérance permet aux fabricants d'apporter des améliorations dans ces domaines et de réduire les coûts en trouvant un équilibre optimal entre le coût et la tolérance et en adaptant ainsi la conception. La structure modulaire du modèle associe chaque module ou étape du processus de production à son impact sur l'assemblage ou les composants, ce qui permet une approche systématique et organisée de l'analyse et de l'optimisation du processus de fabrication. De plus, le modèle associe les tolérances allouées et les stratégies de production aux taux de conformité des composants en utilisant des modèles de substitution et il évalue le coût de fabrication correspondant. Sur ces bases, les contributions de la thèse qui répondent à l'objectif sont conclues comme suit et illustrées dans la Figure 51.

Plusieurs questions scientifiques ont été abordées dans le cadre de ce travail :

**Question 1 : Quelle est la méthodologie pour créer un produit fiable par la mise en œuvre du tolérancement adaptatif et l'atténuation des incertitudes ?**

Contribution 1 : Dans le chapitre II, ce travail examine le processus d'établissement de modèles de substitution spécialisés pour divers assemblages, ce qui implique la création de modèles simulant le comportement et la performance des assemblages. Ces modèles peuvent être analysés à l'aide d'une série de techniques analytiques afin d'évaluer le comportement de l'assemblage et la réponse à la qualité. Le résultat de l'analyse peut être représenté sous la forme de taux de conformité, qui sont une mesure du degré de conformité de l'assemblage aux spécifications souhaitées. Les taux de conformité peuvent ensuite être incorporés dans un modèle d'outil de décision, qui peut être utilisé pour prendre des décisions éclairées concernant les stratégies et les techniques d'assemblage.

L'utilisation de modèles de substitution spécialisés et de techniques analytiques de cette manière permet une approche plus complète et fondée sur des données pour évaluer le comportement de l'assemblage et sa réponse en termes de qualité.

### **Question 2 : Quelle est la manière la plus efficace d'ajuster la tolérance dans le domaine de l'allocation adaptative de la tolérance, compte tenu de l'application de stratégies de production multiples ?**

Contribution 2 : Dans le chapitre III, des stratégies de production (c'est-à-dire l'allocation des ressources, le retraitement et la sélection des assemblages) sont proposées pour améliorer les coûts de fabrication des composants et des assemblages ainsi que la qualité. Le modèle d'optimisation coût-tolérance reçoit les stratégies de production et les retours d'inspection associés. Ensuite, il attribue des tolérances rentables aux composants. Chaque stratégie est proposée pour améliorer l'assemblage à certaines étapes qui sont résumées ci-dessous :

- Allocation des ressources : cette décision peut être prise avant la fabrication des composants de l'étape. L'optimisation reçoit les écarts de processus des ressources disponibles et localise les tolérances et les ressources optimales tout en minimisant les coûts de fabrication et en garantissant les exigences fonctionnelles.

- Retravail : cette activité peut contribuer à améliorer la qualité d'un composant rejeté en le ramenant sur la chaîne de traitement et en effectuant un retravail sur le composant. Toutefois, la retouche s'applique au composant rejeté si les caractéristiques non conformes se situent dans le domaine de retouche prédéfini par le concepteur. Cette stratégie permet de réduire le coût des rebuts et d'améliorer la conformité des composants.

- Sélection de l'assemblage : cette stratégie évalue la qualité de plusieurs approches d'assemblage telles que l'assemblage aléatoire, l'assemblage sélectif et l'assemblage individuel. Ensuite, elle sélectionne la stratégie qui offre la meilleure réponse en termes de qualité.

### **Question 3 : Quel est l'effet de l'incorporation d'approches d'assemblage adaptatives sur l'amélioration de la qualité de l'assemblage dans la production ?**

Contribution 3 : L'approche adaptative de l'assemblage est proposée au chapitre IV. Il s'agit d'une méthode permettant d'évaluer la qualité des résultats produits par différentes stratégies d'assemblage. Ces stratégies d'assemblage peuvent inclure l'assemblage aléatoire, l'assemblage sélectif et l'assemblage individuel. L'objectif de l'approche d'assemblage adaptatif est de déterminer la meilleure stratégie pour un assemblage spécifique, sur la base de la qualité du résultat produit par chaque stratégie. En évaluant la réponse de qualité liée à chaque stratégie d'assemblage, l'approche d'assemblage adaptatif permet d'identifier la stratégie la plus adaptée à une situation d'assemblage particulière.

Sur la base de ces considérations, plusieurs études de cas sont proposées pour répondre aux questions scientifiques. L'objectif des études de cas proposées dans ce contexte est d'aborder et de répondre aux questions scientifiques qui ont été soulevées. Les résultats des études de cas sont présentés dans le tableau 19 pour faciliter l'analyse et l'interprétation.

### V.2. Limites critiques

Le développement du substitut, des modèles de tolérance des coûts et des stratégies de production dans cette thèse est effectué sur la base de plusieurs hypothèses, afin de réduire les complexités et d'être plus pertinent pour les études de cas proposées (linéaires, non linéaires, géométrie complexe). Les limitations sont énumérées :

(1) Les processus d'enlèvement de matière (ou soustractifs) sont l'une des principales hypothèses techniques dans le développement du modèle mathématique de l'analyse de tolérance et de la mise en œuvre de la stratégie de reprise. Un produit non conforme est considéré comme pouvant être retravaillé si les caractéristiques associées ont suffisamment de matière pour être enlevées et atteindre la conception prédéfinie. Étant donné que l'utilisation de procédés additifs tels que la modélisation par dépôt de fusion (FDM), la stéréolithographie (SLA), le frittage sélectif par laser (SLS) et le dépôt direct d'énergie (DED), etc. accroît la complexité du développement mathématique du modèle d'analyse de la tolérance, seuls les procédés d'enlèvement de matière sont pris en compte.

(2) Dans de nombreuses applications réelles, les données d'entrée sont sujettes à l'incertitude. Les méthodes d'optimisation traditionnelles visent à trouver la solution optimale pour un ensemble

spécifique de données d'entrée, mais peuvent échouer lorsque les données d'entrée réelles diffèrent des données supposées. Par conséquent, dans cette thèse, pour des raisons de simplicité et d'application, les données d'entrée relatives aux coûts sont supposées fixes.

(3) La présence d'incertitude est un sous-produit du développement des modèles de substitution, et son existence est reconnue et prise en compte tout au long du processus de développement du modèle. La présence d'incertitude peut provenir de nombreuses sources, telles que des erreurs de mesure, des paramètres de modèle imprécis ou des données incomplètes. C'est un aspect inhérent à de nombreux systèmes et processus du monde réel, et il est souvent important de quantifier et de comprendre l'incertitude afin de prendre des décisions éclairées et de tirer des conclusions précises.

(4) Les stratégies d'assemblage proposées le sont dans certaines limites, en raison de calculs fastidieux et profonds. Par conséquent, si un emplacement lié à un type de composant est épuisé, les autres emplacements liés à un autre type de composant stockeront le composant redondant pour la production suivante.

### **V.3. Perspectives**

Les limites de cette étude jouent un rôle crucial dans l'orientation des travaux futurs. Elles identifient les facteurs qui ont limité la recherche et indiquent les domaines dans lesquels des recherches supplémentaires ou des améliorations sont nécessaires. La liste suivante présente les travaux futurs de cette étude :

(1) Les nouveaux produits et technologies s'orientent davantage vers les processus et la fabrication additifs, qui devraient apporter des avancées et des améliorations significatives dans des domaines tels que les matériaux, la vitesse, la précision et l'évolutivité. Par conséquent, une question technique intéressante qui peut être prise comme perspective est la mise en œuvre des processus additifs et les impacts associés de l'évaluation statistique.

(2) Dans le domaine du tolérancement, l'incertitude peut avoir un impact significatif sur la précision des prédictions et l'efficacité du processus de fabrication, ce qui en fait un domaine d'étude et de recherche important. Cette incertitude se traduit par une région d'incertitude qui englobe le domaine du tolérancement, comme le montre la figure 52. Cette figure met en évidence l'importance

de la prise en compte et de la réduction de l'incertitude, qui peut être considérée comme un domaine critique d'investigation scientifique dans le domaine du tolérancement dans les recherches futures. La démonstration de l'impact de l'incertitude sur le développement du modèle souligne l'importance de prendre en compte et de traiter ce facteur dans les études futures.

(3) Les techniques d'optimisation robuste prennent en compte les incertitudes des données d'entrée et visent à trouver une solution qui fonctionne bien dans une variété de scénarios possibles. Pour ce faire, le problème d'optimisation est formulé comme un problème minimax, où l'objectif est de minimiser le scénario le plus défavorable. Plusieurs méthodes peuvent être utilisées pour l'optimisation robuste, en fonction de la nature du paramètre incertain et des contraintes du problème d'optimisation. Voici quelques exemples de méthodes d'optimisation robuste : Programmation linéaire robuste (RLP), Programmation quadratique robuste (RQP), Programmation semi-définie robuste (RSDP), etc.

(4) Dans cette thèse, le modèle de substitution est utilisé pour estimer la conformité d'assemblage des mécanismes dans différentes conditions de fonctionnement et pour identifier les paramètres de conception les plus sensibles aux variations. L'utilisation d'un modèle de substitution basé sur la physique dans l'analyse de la tolérance incorpore la physique du système, ainsi que les variations de fabrication et d'environnement qui affectent ses performances. Ce modèle de substitution peut ensuite être utilisé pour effectuer des simulations et des optimisations, ce qui permet aux ingénieurs d'identifier rapidement les configurations de conception les plus prometteuses.

(5) Pour les travaux futurs de l'assemblage, une amélioration de l'approche sélective peut consister à améliorer les combinaisons dans lesquelles les composants non appariés peuvent être combinés avec d'autres bacs de manière à ce que les réponses en termes de qualité ne chutent pas. En outre, le GOQC étant issu de l'algorithme de Kuhn-Munkres, il a été prouvé que la complexité du problème augmente rapidement avec sa dimensionnalité. Par conséquent, l'approche peut être adaptée pour résoudre des problèmes d'affectation à haute dimension en utilisant des approches heuristiques ou méta-heuristiques appropriées.

English Version

(This page left intentionally blank)

# Introduction and overview

## a. Problem definition

Today's industrial world is facing rising demand for highly reliable and safe products having a wide range of applications in industries, such as automobiles, medical, and aircraft. Complex industries require a well-designed engineering plan which has a comprehensive understanding of the various certainties and uncertainties that occur in practice. At all stages of product development and throughout the product life cycle, uncertainty is ubiquitous and incurs risk. The risk can impact product performance(s), process scheduling, market acceptance, or the whole business. To mitigate these risks and to reduce their effects, many engineering design activities are performed to look into thoroughly the concepts of uncertainty, risk, and tolerances (Morse *et al.*, 2018).

Moreover, the need for more precise components has impacted the development of tolerancing. Tolerance is an essential part of design and manufacturing, and the ubiquitousness of tolerances entails the various stages of a product's life cycle (see **Figure 1**). Since the role of tolerances in a life cycle varies from stage to stage, depending on their design objectives, it is a crucial task for designers to define and quantify a tolerance that meets the design objectives. Thus, the tolerancing decision should meet the functionality and/or assemblability constraints as well as meeting the limited capabilities of the required manufacturing processes (Hong & Chang, 2002).

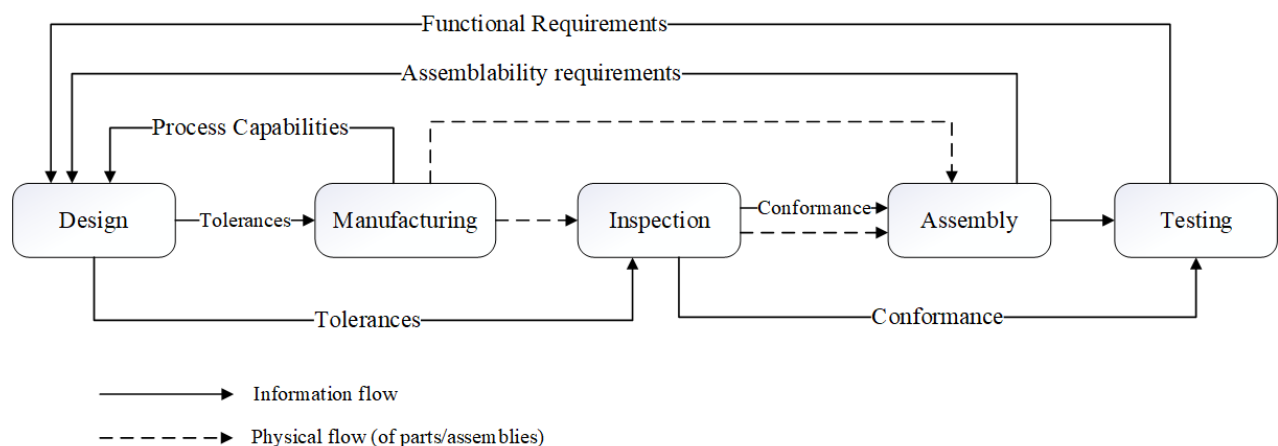

**Figure 1.** The ubiquitous role of tolerances in a product life cycle (Hong & Chang, 2002)



On these bases, the introduction of new technologies has broadened the scope of tolerancing. The performance of complex products ultimately hinges on their manufacturing and assembly to current internal and external circumstances. Key functions of complex products can often be carried out by high-precision component use. Thus, producers are confronted with high-quality requirements, cost pressure, and a rising number of product variants. To evaluate the effects of tolerance and to understand the contributions of tolerances on the system behavior, it is necessary to identify the relationships between tolerances and functional characteristics by a set of experiments or numerical simulations. Especially, micro components or components with micro features, which have tolerances of less than 5  $\mu\text{m}$ , are challenging. The study of complex components such as gears is based on experimentations or numerical simulations.

### **b. Scope of the thesis and scientific issues**

As explained in the introduction of the report, the thesis aims at developing an optimization tool to find suitable tolerances, where the concepts of adaptive tolerancing and adaptive production strategies are integrated. The importance of reliable and well-designed products has been imposed by the manufacturer to manage uncertainties that shall occur during production. Therefore, it has become imperative to identify the sources of uncertainty and quantify the impact of multiple types of uncertainties. More relevantly, this thesis explores the presence of uncertainty in the design domain which exposes design deviations.

The concepts of the thesis can be defined in several key and sub-scientific questions:

*What is the methodology for creating a reliable product through the implementation of adaptive tolerancing and mitigating uncertainties?*

*What is the most efficient way of adjusting tolerance in the realm of adaptive tolerance allocation, considering the application of multiple production strategies?*

*What is the effect of incorporating adaptive assembly approaches on the enhancement of assembly quality within production?*

#### **A. Aims**

- What is the importance of developing tools that optimize adaptive tolerance allocation?

- What actions can be taken to maintain assembly quality when deploying a range of production strategies that aim to minimize production costs?
- How can integrate production strategies and associated impacts into tolerance allocation comprehensively?

**Question A** refers to the aim of the thesis which is to minimize the deviations including their impacts and model probabilistically the deviations considering the quality of the product and related production cost. Moreover, to design and manufacture highly reliable complex mechanisms, it is important to illustrate the effect of geometrical deviations in a cost and time-efficient way.

### **B. Restrictions**

- What are the constraints and bounds of the technical design?
- How can involve geometrical deviations of a complex mechanism in the cost-tolerance allocation problem?

Furthermore, **Question B** represents design and manufacturing limitations that needed to be integrated into the model. The limitations can be defined as manufacturing line capability, process capability, stack-up constraints on the components of an assembly mechanism, etc.

### **C. Techniques**

- What analytical techniques are required to yield the optimal solution?
- Which methods can be deployed to optimize the tolerance allocation model in a time and cost-efficient way?

**Question C** is focused on analytical techniques such as optimization algorithms, simulation tools, and machine learning techniques to identify the most suitable solution, where the objective and constraints are met. Within the thesis, a new holistic approach is developed to bring engineering design requirements, performance indicators, probabilistic manufacturing deviations, and inspection uncertainties into a common model.

### **D. Empirical contribution**

- How can improve optimization tool accuracy and assembly quality by considering empirical data?

- How can production activities impact the optimization approach?

**Question D** explores the fact that product realization is supported by digital threads such as simulation tools, machine learning techniques, etc. Without the use of costly and time-consuming physical mock-ups, this work develops an effective surrogate model for geometric quality able to forecast the behaviors and performances of the product and manufacturing process, as well as making decisions about the product and manufacturing process.

The main technical and scientific points of the thesis are brought in scientific questions. The requirements are then indicated. Therefore, in the next section, the AdeQuaT project and this work's contributions are highlighted.

### c. AdeQuaT project context

AdeQuaT project is organized to study the behavior of micro gears. This project is carried out between two European universities, **École Nationale Supérieure d'Arts et Métiers (France)** and **Karlsruher Institut für Technologie (Germany)**. The AdeQuaT project is divided into sub-projects named Work Packages (WP). This division aims at considering separately four kinds of problems which are demonstrated in **Figure 2** and explained as follows:

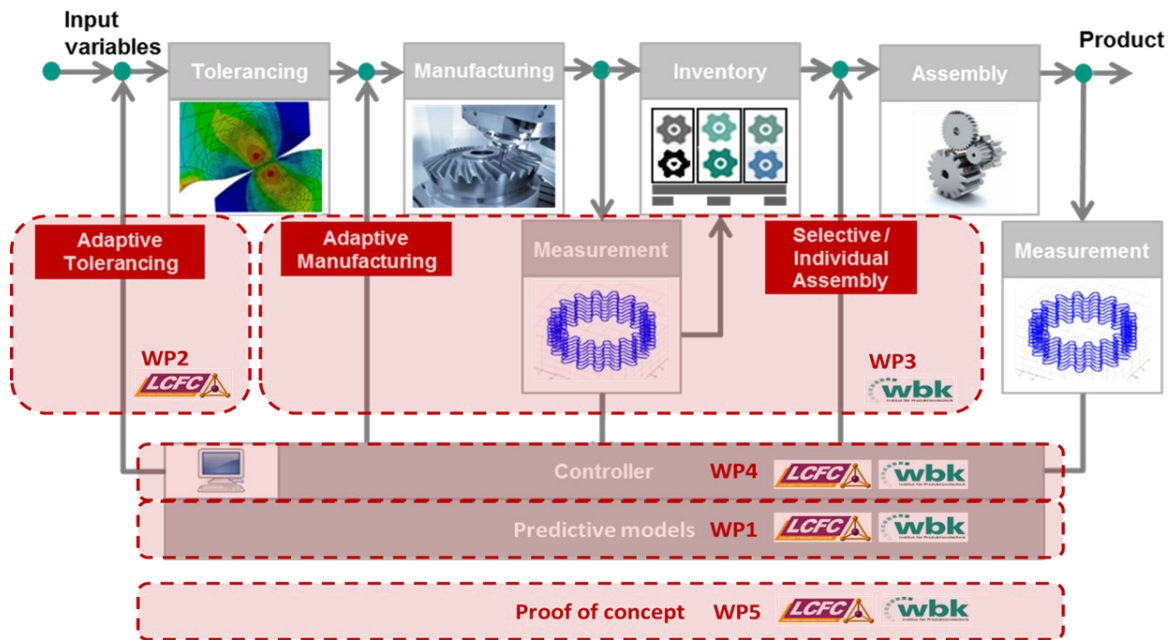

Figure 2. AdeQuaT project work packages

- **WP1: Predictive models**

The aim of WP1 is to derive a functional meta-model of the product to correlate manufacturing deviations to the degree of functional fulfillment under uncertainty.

- **WP2: Adaptive Product Tolerancing**

The aim of WP2 is to develop strategies for an optimal tolerance allocation, assuring an economic production of functional products. This work package is covering two sub-problems: the development of a mathematical model for tolerance optimization based on a meta-model and the development of adaptive tolerance allocation strategies.

- **WP3: Adaptive Manufacturing & Selective Assembly**

The aim of WP3 is to develop strategies to enhance precision product manufacturing through adaptive production strategies based on the functional meta-model proposed, individually evaluating component pairs with complex manufacturing deviation interactions. The model then serves as a matching criterion for selective and individual assembly strategies to meet required functionalities exceeding the technological limits as well as an optimization assessment basis for adaptive manufacturing strategies.

- **WP4: Quality control strategy**

The aim of WP4 is to combine the developed strategies within a common cyber-physical production controller and assess the effects on functional deviations and economic production under uncertainty consideration. Optimization methods will be applied in order to determine the fittest strategy (combination) to manufacture the product.

- **WP5: Proof of concept**

The aim of WP5 is to apply the developed models and methods from WP1 to WP4 for an industrial gear pair and its production. An exemplary demonstration is applied to micro gears for dental instruments. Through optimization, the most suitable strategy is determined in aspects of introduced technical and economic aspects, succeeding in the challenge to meet high-quality requirements. Throughout, undesired effects of imperfect gear pairs like the kinematic error are reduced or even prevented.

This work focuses on contributing to WP2 and WP4 by proposing a modular cost optimization model. The model aims to minimize manufacturing costs by enabling adaptive tolerance allocation and evaluating production strategies. The application of the model is demonstrated in WP5.

### **d. Research Methodology**

This research aims at developing a methodology for surrogate-assisted optimization under uncertainties of product tolerances and production strategies. Moreover, adaptive tolerancing and production strategies are planned, and the market competition of producing economic quality precision products is considered. Within the research, a new holistic approach of tolerance allocation and application on assembly strategies are developed, assessing both technical and economic assessments of the product. The approach brings the engineering design requirements, performance indicators, probabilistic manufacturing deviations, and inspection uncertainties together in a common model, where the effects of adaptive tolerancing and production strategies on design, manufacturing, and product function performances are evaluated quantitatively.

Additionally, in order to determine the effects of tolerance and to understand the contributions of tolerances on the system behavior, it is necessary to identify the relationships between tolerances and functional characteristics by a set of experiments or numerical simulations. Therefore, to develop an applicable approach, it shall be divided into two segments: tolerance analysis and tolerance allocation. The application of developed approach will be applied to different case studies to be verified through simple to more complex mechanisms as follow:

#### **d.1. Overrunning clutch**

Overrunning clutch as a commonly used case study was initially proposed by Fortini (1967). In this mechanism, the contact angle ( $Y$ ) is the functional requirement, and its value must be controlled within the range of  $7 \pm 1$  deg. The function depends on the components' geometrical deviations, i.e., hub ( $X_1$ ), roller ( $X_2$ ), and cage ( $X_3$ ). The tolerance analysis uses an explicit relationship (Dantan *et al.*, 2012) of the form:  $Y = f(X_1, X_2, X_3)$  where  $Y$  is the functional requirement of the assembly  $X_1, X_2, X_3$ . **Figure 3** depicts the assembly mechanism.

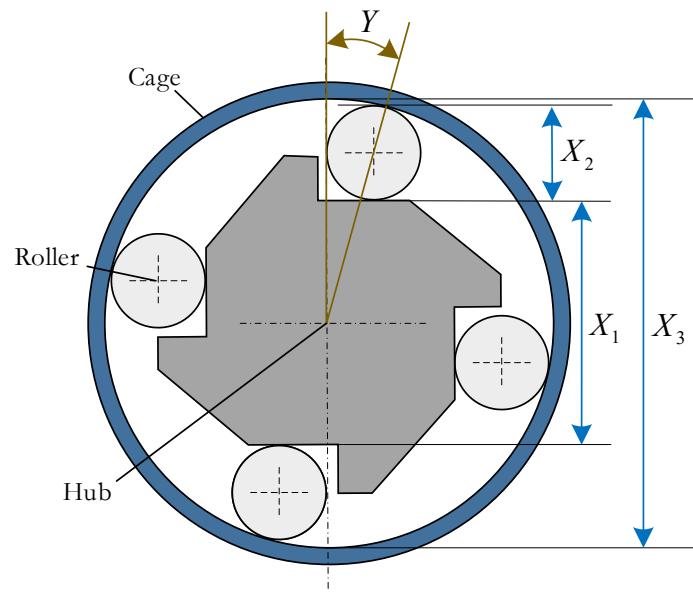

Figure 3. Overrunning clutch mechanism

#### d.2. Electric motor

An electric motor is an over-constrained mechanical assembly. The product is composed of: a body, a shaft, and a housing (as illustrated in **Figure 4**). Anselmetti (2006) examined the electrical motor and established a tolerancing process that served by determining the specifications of influential components without form defects.

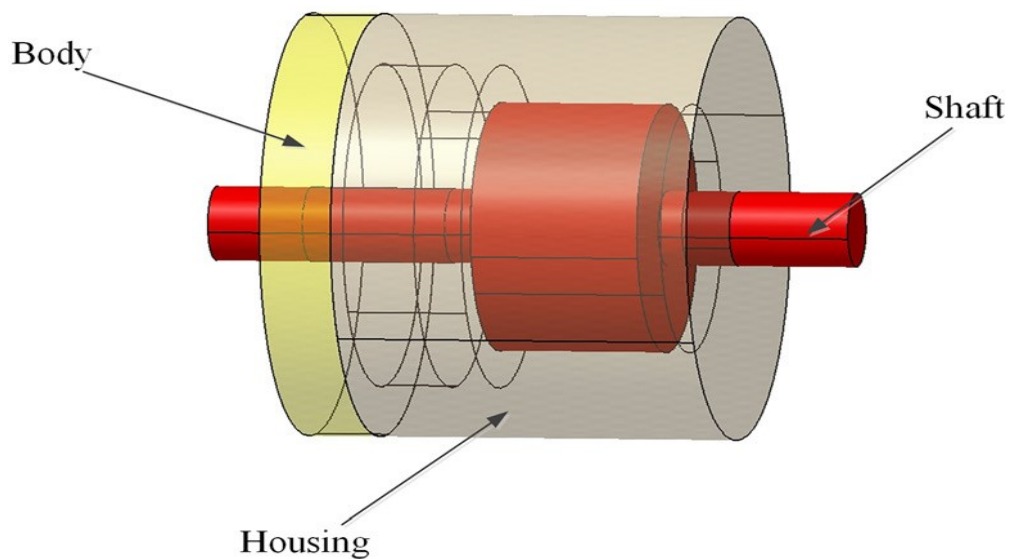
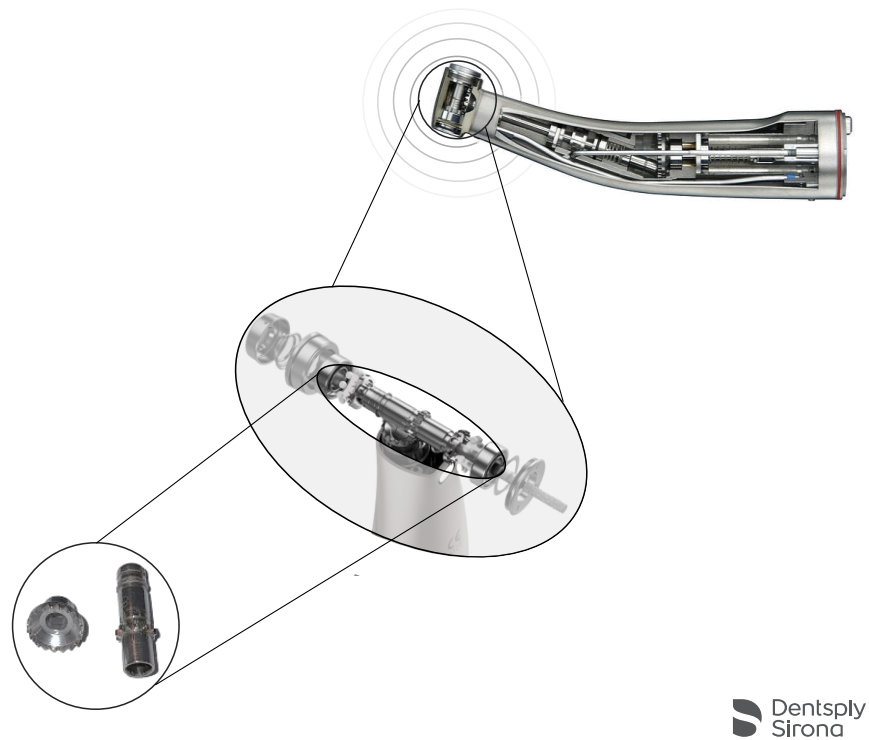

Figure 4. Electric motor mechanism

Moreover, Goka *et al.* (2019b) proposed an implicit method that introduces form defects to contact surfaces of the system and developed a Monte-Carlo-based approach to analyze the system behavior by assessing the assembly and functionality probabilities.

### d.3. Gears

In power transmission systems, gears are used in a variety of industries. An important use of gears in micro-scale can be found in dental instruments (illustrated in **Figure 5**).



**Figure 5.** A pair of spur and crown wheel in a dental drill (Sirona, 2023)

Some of the advantages include durability, a constant transmission ratio, decreased size, excellent efficiency, and appropriateness for a wide range of powers. However, gears have a variety of disadvantages, such as the vibration of the gear meshing system, which causes unwanted noises. The Kinematic Transmission Error (KTE), which is caused by misalignment of the gear, tooth profile inaccuracies, and tooth deflections, is the main source of such noises (VDI2608:2001, 2001). The geometric errors are demonstrated in **Figure 6**. The Kinematic Transmission Error (KTE), which is caused by misalignment of the gear, tooth profile inaccuracies, and tooth deflections, is the main source of such noises.

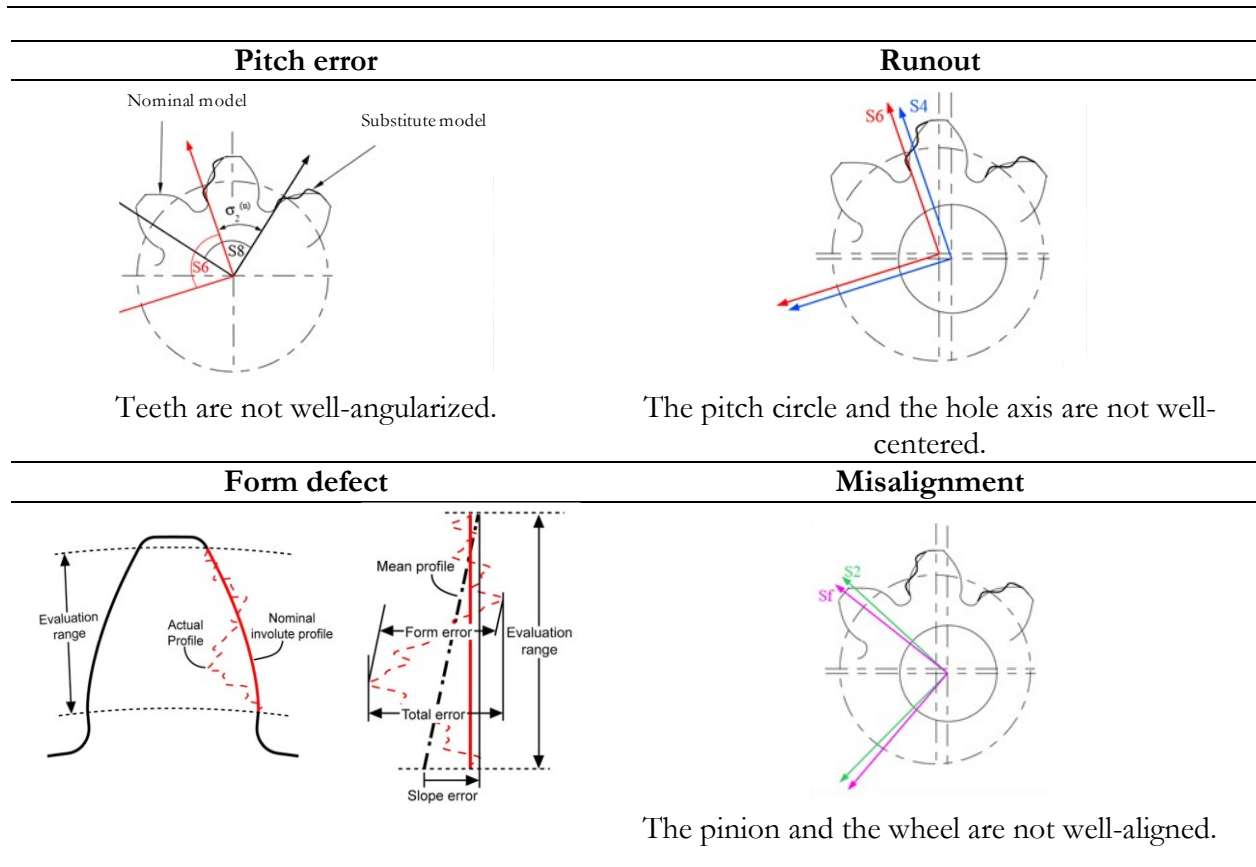

**Figure 6.** Geometric errors on gears (Bruyere et al., 2007)

Therefore, the KTE value compromises the quality level of assembled gears associated with features' deviations which can be evaluated using simulation analytical methods(VDI2608:2001, 2001).

### e. Approaches and tools

The development of the surrogate-assisted optimization method leans on the use of different analytical methods. These methods are investigated regarding the complexity of the assembly mechanism and resource availability such as calculation server availability, project time budget, empirical data, experiments, etc. The approach varies from one case study to the other. To be more explicit, overrunning clutch functional requirement sensitivity is investigated by developing a Monte Carlo simulation. The functionality of the electric motor mechanism is realized by a Monte-Carlo simulation which was proposed in the literature. Afterward, a physical surrogate model is substituted for the simulation model. The upsurge in the complexity of the pair of gears required a statistical surrogate model to be established using machine learning and prediction techniques. The approaches and tools are detailed in **Table 1**.





allocation problem. Additionally, the thesis highlights the obstacles that arise in developing statistical tolerance analysis, which is crucial to the successful implementation of tolerance allocation.

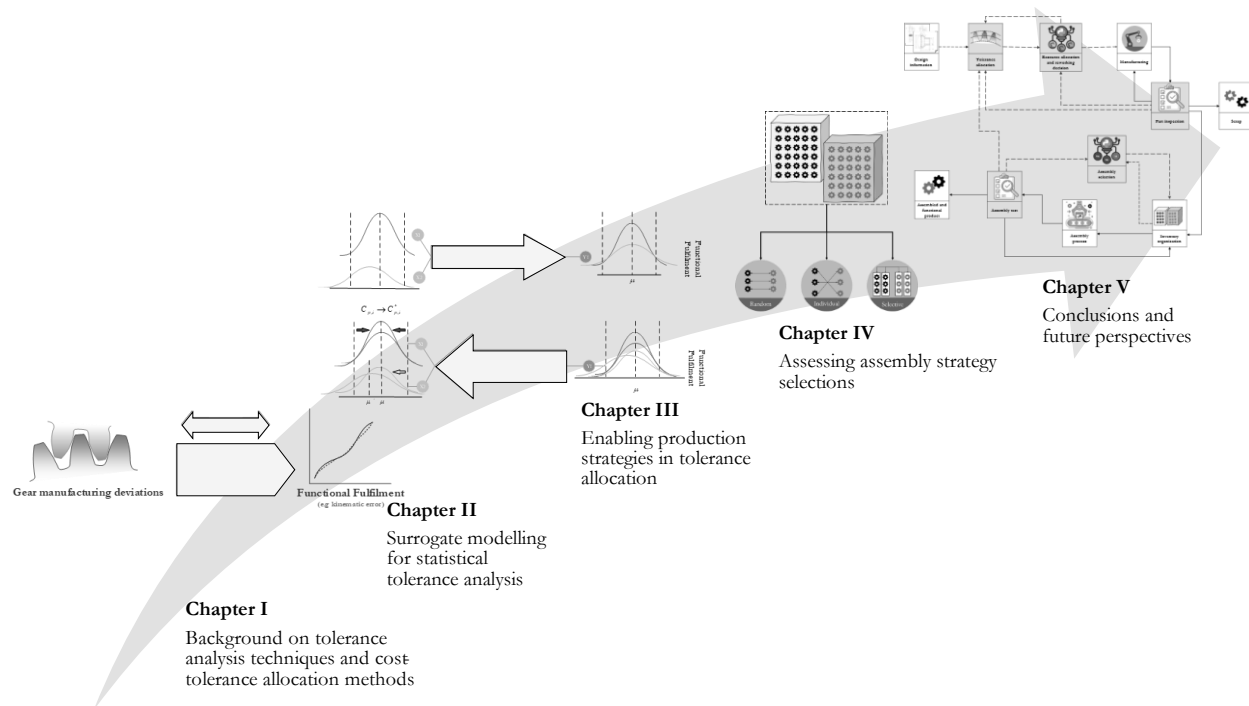

**Figure 7.** Thesis outlines overview

**Chapter II: Defining a surrogate model for statistical tolerance analysis** This chapter centers on the examination of contemporary tolerance analysis techniques and the necessity for a comprehensive interpretation of complex products in modern industries. The research delves into the advantages of simulation tools and Machine Learning (ML) techniques in evaluating complex mechanical functionality, especially in the context of tolerance analysis. The thesis specifically focuses on analyzing the use of ML in the study of complex assembly mechanisms with various types of geometric errors, such as rotational, translational, and dimensional errors. The investigation proposes employing Artificial Intelligence (AI) for tolerance analysis, which guarantees a highly accurate approximation of assembly precision prediction.

**Chapter III: Integrating and optimizing production strategies in tolerance allocation** This chapter studies tolerance allocation and integrating production strategies to optimize the production process. To address this issue, a specialized and modular model is proposed that integrates production strategies into the tolerance allocation model, with the cost value. The model can identify

the most critical specifications of the product where tight tolerances are required, allowing manufacturers to optimize the balance between cost and tolerance. The model is structured as a modular model, with each module or activity being associated with the impact of the activity on the assembly or components can be evaluated using simulation or surrogate modeling, which estimates the efficiency of the activity.

**Chapter IV: Selecting the fittest assembly strategy** This chapter introduces an adaptive assembly strategy that evaluates multiple assembly strategies for a specific assembly, appraises the quality response, and identifies the most suitable strategy. The adaptive assembly has the potential to benefit high-precision products as it allows for swift modification of the assembly process to optimize for each product's specific requirements. The proposed approach has broad applicability and underscores the importance of investigating assembly strategies.

**Chapter V: Conclusions and perspectives** This chapter serves to conclude the present thesis by providing concluding remarks, and critical limitations and outlining various open directions for further research.

### **g. List of publications**

As a result of the work invested in preparing this thesis, a number of papers have been submitted and published in conferences and journals.

#### **Journal papers**

- **Khezri, A.**, Homri, L., Etienne, A., & Dantan, J.-Y. (2023a). Hybrid Cost-Tolerance Allocation and Production Strategy Selection for Complex Mechanisms: Simulation and Surrogate Built-In Optimization Models. *Journal of Computing and Information Science in Engineering*, 1-20. <https://doi.org/10.1115/1.4056687>
- **Khezri, A.**, Schiller, V., Goka, E., Homri, L., Etienne, A., Stamer, F., Dantan, J.-Y., Gisela Lanza, G. (2023b). Evolutionary Cost-Tolerance Optimization for Complex Assembly Mechanisms Via Simulation and Surrogate Modeling Approaches: Application on Micro Gears. *International Journal of Advanced Manufacturing Technology* 126, 4101–4117. <https://doi.org/10.1007/s00170-023-11360-x>
- **Khezri, A.**, Schiller, V., Homri, L., Etienne, A., Dantan, J.-Y., Gisela Lanza, G. (2023c). Development and analysis of a holistic function-driven adaptive assembly strategy applied to micro gears. *Journal of Manufacturing Systems*, 69, 48-63. <https://doi.org/10.1016/j.jmsy.2023.06.003>

### Conference papers

- **Khezri, A.**, Homri, L., Etienne, A., & Dantan, J. Y. (2022a). An integrated resource allocation and tolerance allocation optimization: A statistical-based dimensional tolerancing. *Procedia CIRP*, 114, 88-93. <https://doi.org/10.1016/j.procir.2022.10.012>
- **Khezri, A.**, Homri, L., Etienne, A., Dantan, J. Y., & Lanza, G. (2022b). A Framework for Integration of Resource Allocation and Reworking Concept into Design Optimisation Problem. *IFAC-PapersOnLine*, 55(10), 1037-1042. <https://doi.org/10.1016/j.ifacol.2022.09.524>
- Dantan, J. Y., Etienne, A., Mohammadi, M., **Khezri, A.**, Homri, L., Tavakkoli-Moghaddam, R., & Siadat, A. (2022). Modular cost model for Tolerance allocation, Process selection and Inspection planning. *Procedia CIRP*, 114, 1-6. <https://doi.org/10.1016/j.procir.2022.10.001>

### Dataset findings

- **Khezri, A.**, Dantan, J. Y., Etienne, A., & Homri, L. (2023), Gear Statistical tolerance analysis results, <https://doi.org/10.57745/3EELGX>
- **Khezri, A.**, Dantan, J. Y., Etienne, A., Homri, L., & Schiller, V. (2023), Analysis of Adaptive Assembly for the pairing of Spur Gear and Crown Wheel, <https://doi.org/10.57745/E3DW9W>

(This page left intentionally blank)

# Chapter I: A comprehensive study on tolerancing issues and production strategies

---

The objective of this chapter is to present the state-of-the-art in tolerancing domain and production strategies within the tolerancing field. It reports previous studies in the field of tolerance analysis and tolerance allocation; afterward, it examines the integration of production strategies such as resource allocation, reworking, and assembly selection in the tolerance allocation problem. This study allows us to highlight the ladders currently encounter in developing statistical tolerance analysis and integrating production strategies into the tolerance allocation problem.

---

## **Table of Contents**

I.1. Tolerancing issues.....	39
I.1.1. Tolerance analysis.....	39
I.1.2. Behavior models.....	41
I.1.3. Tolerance analysis techniques.....	42
I.1.4. Cost-tolerance optimization .....	47
I.2. Production strategies in tolerance allocation optimization.....	49
I.2.1. Resource allocation .....	49
I.2.2. Reworking .....	50
I.2.3. Assembly strategies .....	51
I.3. Conclusion .....	52

## I.1. Tolerancing issues

Industrial production is always subject to non-conforming batches which can increase the production costs of mechanisms and be the source of customer dissatisfaction in terms of functional fulfillment. In order to reduce the rate of non-conformity and produce high-quality products, several studies have been conducted for decades on tolerancing. Two main tasks are thus categorized:

- Tolerance analysis aims at verifying the assemblability and functionality of a design after tolerances have been specified on each component of a mechanical assembly (Dumas *et al.*, 2015; Qureshi *et al.*, 2012; Ziegler & Wartzack, 2015).
- Tolerance allocation involves the assignment and the distribution of the values of adequate tolerances (Drake, 1999; Etienne *et al.*, 2009; Ji *et al.*, 2000).

These two categories are described in detail in this section.

### I.1.1. Tolerance analysis

Modeling the geometrical deviations and gaps is the first requirement in order to model behavior and analyze the quality level of the mechanism designed. The geometry of the mechanism components can be modeled (for instance a 2D mechanism as in **Figure 8**) in various ways:

- 1) The nominal surface: the ideal designed surface which represents the desired specifications.
- 2) The substitute surface: the perfect surface associated with the skin model.
- 3) The skin surface: the “real” manufactured surface.

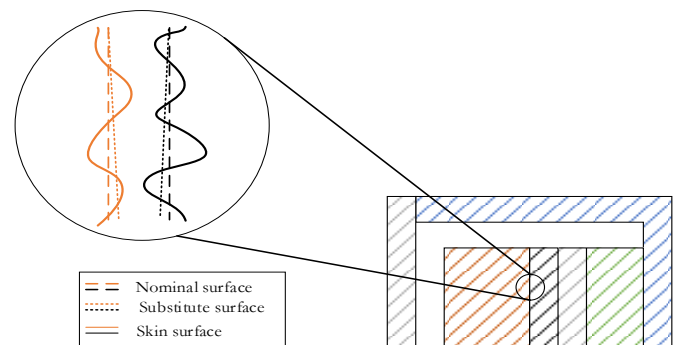

**Figure 8.** Nominal surfaces, substitute surfaces, and skin surfaces in a 2D projection

Regarded to the surface of the mechanism studied, various geometrical models are proposed.

#### (a) *Geometrical modeling without form defect*

Several representations are mentioned in the literature to mathematically explore geometrical modeling. The models include tolerance representation, based on variational geometry (Hillyard &



Braid, 1978; Light & Gossard, 1982; Lin *et al.*, 1981), variational class (Requicha, 1983, 1984), virtual boundary (Jayaraman & Srinivasan, 1989; Srinivasan & Jayaraman, 1989), feasibility space (Chen *et al.*, 2014; Turner, 1993), vectorial approach (Wirtz, 1993), virtual joints (Laperrière & Lafond, 1999), degree of freedom (DOF) (Kramer, 1992), Tolerance-Map (T-Map) (Davidson *et al.*, 2002), topologically and technologically related surfaces (TTRS) (Desrochers & Clément, 1994), infinitesimal matrix (Portman & Weill, 1996), matrix (Cardew-Hall *et al.*, 1993; Whitney *et al.*, 1994), small displacement torsor (SDT) (Clement & Riviere, 1993), and proportioned assembly clearance volume (PACV) and polytopes (Delos & Teissandier, 2014; Homri *et al.*, 2015; Teissandier *et al.*, 1999).

*(b) Geometrical modeling with form defect*

Lecompte *et al.* (2010) considered surface form defects and developed a Discrete Cosine Transform (DCT) method to define form errors. Franciosa *et al.* (2011) presented a morphing mesh-based approach to model shape errors in order to perform variation analysis of compliant assemblies. Grandjean *et al.* (2013) studied the impact of form defects on the functional surface of a mechanical joint. They proposed a procedure to analyze and quantify the assembly of components where form and position defects and deformable contact surfaces are considered. Anwer *et al.* (2013) investigated the fundamentals of Skin Model at a conceptual, geometric, and computational level. Schleich *et al.* (2014) studied the operationalizing of the Skin Model concept in discrete geometry for use in geometric variations management developing a discrete geometry framework for Dimensional and Geometrical Product Specification (GPS) and Verification. Li *et al.* (2016) developed a comprehensive tolerance analysis and optimization framework using deviation propagation and small displacement torsor (DP-SDT) theory. Homri *et al.* (2017) developed a Metric Modal Decomposition (MMD) to model the form defects of cylinders considering the deviations occurring in the nodes of a surface mesh.

**Table 2.** Current geometrical models (adopted from Dumas *et al.* (2015))

Without form defects	With form defects
Variational geometry, variational class, virtual boundary feasibility space, vectorial approach, virtual joints, DOF, Tolerance-Map (T-Map), TTRS, infinitesimal matrix, SDT and PACV.	DCT, morphing mesh-based approach, skin model-based, deviation propagation, DP-SDT and MMD.

---

After studying the geometry of a mechanism and investigating the geometrical deviation models, the behavior of the surfaces in contact is calculated.

### **I.1.2. Behavior models**

The next step to design a mechanism is to build a behavior model which allows the designer to define how the features of a mechanism interact. More precisely, the relations concerning dimensional chains are required, in order to demonstrate and link features in contact. Therefore, two distinct categories for behavior modeling are briefly reviewed below.

#### *(a) Displacement accumulation*

Displacement accumulation is aimed to model the influences of the deviations on the geometrical behavior of the mechanism. Several studies have been dedicated to modeling the deviations. Lê *et al.* (2014) extended a methodology to analyze the mechanical joint behavior. This methodology is consisting of numerical processing and theoretical developments. It takes into account the experimental measurements of joint displacements and surface measurements to predict the behavior of a planar mechanical joint. Du *et al.* (2017) developed a modified Jacobian-torsor model using small displacement torsors (SDTs) for typical features and the statistical solution. Homri *et al.* (2017) implemented a tolerance analysis approach considering components' form defects Based on a Metric Modal Decomposition (MMD) method which aims to generate the form defects of cylinders. Wang *et al.* (2020) established a novel variation propagation method based on the theory of stream of variation (SoV) for multi-stage machining processes considering general shape workpieces. The small displacement torsor (SDT) and Jacobian matrix are combined to form the tolerance analysis model developed.

#### *(b) Tolerance accumulation*

Tolerance accumulation uses relations between all domains to characterize the geometrical behavior. It aims at simulating the composition of tolerances i.e. linear or 3D accumulations. Several techniques in literature can be found. Grandjean *et al.* (2013) performed stochastic simulations to generate and analyze several functional surfaces by modifying the ratio between the position defects and form defects of surfaces. Chen *et al.* (2015) extended a modified method of the unified Jacobian-Torsor model and performed a modified Monte Carlo method considering constraints between the components of the torsor. Zeng *et al.* (2017) developed a tolerance analysis approach based on the

Unified Jacobian-Torsor model for complex assemblies. Localization tolerancing with contact influence (CLIC) is used to analyze the deviations at each joint.

**Table 3.** Comparison of the behavior models between the displacement accumulation approach and the tolerance accumulation approach (adopted from Dumas *et al.* (2015))

Displacement accumulation		Tolerance accumulation
Without form defects	With form defects	
<b>Deviation constraints</b> Probability distributions Random variables whose distributions and parameter values are known.		<b>Deviation volume</b> $V_d(X, G)$ Deviation space (T-Maps, deviation domains) represents the admissible variations of a feature within its tolerance zone.
$X \sim N(\mu_X, \sigma_X)$	$X \sim N(\mu_X, \sigma_X), F \sim N(\mu_F, \sigma_F)$	
<b>Interface constraints</b> Characterize the non-interference or association between substitute surfaces, which are nominally in contact, by limiting gaps between them.		<b>Clearance volume</b> $V_c(X, G)$ Hypervolume of admissible variations (i.e. without interference) of a frame with respect to another one. Frequency distributions are also used in the T-Maps approach.
$C_i(X, G') \leq 0$ and $C_i(X, G^*) = 0$	$C_i(X, G', F) \leq 0$ and $C_i(X, G^*, F) = 0$	
<b>Functional condition</b> Limits the orientation and the location between surfaces in relative displacement, which are in functional relation.		<b>Functional volume</b> $V_f(X, G)$ Specific volume characterizing the admissible variation space of an assembly so as to satisfy the functional requirement.
$C_f(X, G) \geq 0$	$C_f(X, G, F) \geq 0$	
<b>Compatibility equations</b> Geometrical behavior of the mechanism expressed by the composition relations of displacements in various topological loops.		<b>Relation between volumes</b> $V_{d1}(X, G) \oplus V_{d2}(X, G) \ominus V_{c1}(X, G)$ Minkowski sums or intersections are performed according to the different dimensional chains of the mechanism on hypervolumes to obtain accumulated volumes.
$C_c(X, G) = 0$		
Note: $F, G, G^*$ , and $G'$ illustrate the set of defects, set of gaps, set of clearance parameters of the fixed and sliding contacts, and set of clearance parameters of floating contacts, respectively.		

To conclude the behavior models, **Table 3** compares the two existing models. In the next step, the assemblability and functionality of the mechanism will be analyzed.

### I.1.3. Tolerance analysis techniques

Tolerance analysis techniques are required to define a mathematical formulation involving all the characteristics of the behavior model, which are means to provide a reliable computation of the quality level. Different techniques exist and are presented.

---

(a) *Worst-Case*

The Worst-Case (also called deterministic) technique assigns the worst possible combination of each deviation among all the admissible assembly deviations combination of workpieces. Jaballi *et al.* (2011) extended a modified technologically and topologically related surfaces (TTRS) model which can automatically generate all the Geometric Dimensioning and Tolerancing (GD&T) in the manufacturing stage and is concurrently suitable for tolerance analysis and allocation. Mansuy *et al.* (2011) proposed a novel method to demonstrate the relationship between satisfying a functional condition in the worst case and the geometric tolerances on the various surfaces based on the domain concept. Zeng *et al.* (2017) developed a solution to solve parallel chains. The use of the worst-case method often leads to tighter tolerances and high production costs since the occurrence that allows for the calculation of worst cases is small (Hong & Chang, 2002). Otherwise, statistical analysis methods are proposed.

(b) *Statistical tolerance analysis*

Statistical tolerance analysis is used to compute the probability that given individual tolerances can meet functional and assembly requirements. Its purpose is to determine the quality of a product through the probability of failure or scrap rate. Several statistical-based techniques have been carried out. (Beaucaire *et al.*, 2013) formulated a statistical analysis approach using system reliability methods. First Order Reliability Method (FORM) system is implemented to deal with complex assembly components. Qureshi *et al.* (2012) considered quantifiers that provide a univocal expression of the condition corresponding to a geometrical product requirement. The method brings Monte-Carlo simulation into optimization methods. Dumas *et al.* (2015) extend the previous study by applying a probabilistic method to an over-constrained mechanism without considering form defects. Homri *et al.* (2017) continued by proposing a new form of defect method that has been integrated into the same tolerance analysis method. Goka *et al.* (2019a) and Goka *et al.* (2019b) extended this work by developing new form defects models and Kernel Density Estimation (KDE) and considering different contact types. Moreover, Cui *et al.* (2021) proposed a data-driven tolerance specification method applying machine learning methods to generate tolerance specifications derived from the information that affects geometric tolerances selection. A comparison of tolerance analysis methods is synthesized in **Table 4**.

**Table 4.** Comparison of tolerance analysis methods between the displacement accumulation approach and the tolerance accumulation approach (adopted from Dumas *et al.* (2015))

Displacement accumulation	Tolerance accumulation
<b>Assembly requirement:</b> The assembly of a mechanism with gaps must be ensured. The various features, in the presence of deviations, must be assembled without interfering with each other.	
<p>“there exists an admissible gaps configuration of the mechanism such that the assembly requirement (interface constraints) and the compatibility equations are respected”.</p> <p><b>Without form defects:</b> <math>\exists G \in R^m: C_c(X, G) = 0 \cap C_i(X, G') \leq 0 \cap C_i(X, G^*) = 0</math></p> <p><b>With form defects:</b> <math>\exists G \in R^m: C_c(X, G) = 0 \cap C_i(X, G', F) \leq 0 \cap C_i(X, G^*, F) = 0</math></p>	<p>In this case, the assembly requirement is satisfied when the intersection of all accumulated clearance domains is not empty.</p> $\sum V_d(X, G) \subset \sum V_c(X, G)$
<b>Functional requirement:</b> Once the assembly requirement is verified, the influence of the geometrical deviations can be evaluated on a functional characteristic, which is basically a maximum or a minimum clearance on a feature that has an impact on the performance of the mechanism.	
<p>“for all admissible gap configurations of the mechanism, the geometrical behavior and the functional requirement are respected”.</p> <p><b>Without form defects:</b> <math>\forall G \in \{G \in R^m: C_c(X, G) = 0 \cap C_i(X, G') \leq 0 \cap C_i(X, G^*) = 0\}, C_f(X, G) \geq 0</math></p> <p><b>With form defects:</b> <math>\forall G \in \{G \in R^m: C_c(X, G) = 0 \cap C_i(X, G', F) \leq 0 \cap C_i(X, G^*, F) = 0\}, C_f(X, G, F) \geq 0</math></p>	<p>The functional requirement is satisfied when the accumulated deviation and clearance domain remains within the functional domain.</p> $\sum V_d(X, G) \oplus V_c(X, G) \subset \sum V_f(X, G)$
<b>Mathematical tools:</b> For both requirements, an optimization algorithm is required, taking into account all defined constraints. Cylinder joints result in quadratic interface constraints, making the optimization problem more difficult to solve. A solution is to linearize these constraints. Moreover, an optimization tool is used to define different types of contact: sliding and fixed.	<b>Mathematical tools:</b> In order to be able to apply Minkowski sums or intersections to compute accumulated hypervolumes, domains have to be linear. A cylinder-type joint in a mechanism leads to the definition of a non-linear clearance domain, so it has to be linearized in several facets.

(c) Mathematical modeling

The first step in modeling an assembly product that contains several dimensional components is to chain the dimensions by several geometrical chains. A dimension chain is a set of independent parallel dimensions which link each other to create a geometrically closed circuit. Dimensions can specify the mutual position of components on a single unit component or several components in an assembly unit. A dimension chain of a product can be expressed as follow:

$$Y = a_1X_1 + a_2X_2 + \dots + a_nX_n \quad (1)$$

Where  $Y$  is a closed (resulting) component which a chain ends with.  $X_i$  are partial components (input dimensions) and  $a_i$  are constant values. Dimension  $X_i$  specifies by two main characters,  $d_i$  and

$x_i$  as nominal dimension and dimensioned deviation of component  $i$ , respectively. Therefore, dimension  $X_i$  can be written as follow:

$$X_i = d_i + x_i \quad (2)$$

With respect to the explanation provided, the relationship between the response and components can be presented. Furthermore, designing constraints and objectives can be applied and modeled regarded to the resulting dimension chain. Next following subsections provide the constraints and objectives related to the tolerance allocation problem.

- Worst-Case method (WC)

This method is the simplest one and is used by designers where it has assumed that all the component dimensions meet their worst limit simultaneously. It can assure that all assemblies will satisfy the process precision limits but as the number of components increases in the assembly, it imposes higher production costs. The applicability of this method is assured when 100 % acceptance is required, a very small volume of the production is considered, and the number of component dimensions in assembly is very small. The method is expressed as:

$$\sum_{i \in N} \left| \frac{\partial Y}{\partial X_i} * t_i \right| \leq G_{ASM} \quad (3)$$

where  $t_i$  represents allocated tolerance to component  $i$  and  $G_{ASM}$  indicates the admissible gap in the assembly.

- Root Square Sum method (RSS)

Root Square Sum or the simple statistical model is an optimistic method that assumes that the process distribution is normal with its mean centered at the nominal value. The method formulation is given as:

$$\sqrt{\sum_{i \in N} \left( \frac{\partial Y}{\partial X_i} * t_i \right)^2} \leq G_{ASM} \quad (4)$$

The RSS method obtains a looser component tolerance, and it may occur a lower process cost. The method can ensure well-obtained tolerances when (a) finite rejection of the product is

permitted, (b) a high volume of the production is considered, and (c) the number of component dimensions in assembly is appropriately large.

- Spott's modified method

Spotts (1978) introduced this method which is the average of the tolerances obtained using the worst-case and RSS-based tolerance stack-ups. Since the worst-case method is known as a highly pessimistic method and RSS is based on an optimistic assumption, Spott's modified method seems to be more realistic than the other two which are based on practical observations. It can be formulated as:

$$\frac{1}{2} \left( \sum_{i \in N} \left| \frac{\partial Y}{\partial X_i} * t_i \right| + \sqrt{\sum_{i \in N} \left( \frac{\partial Y}{\partial X_i} * t_i \right)^2} \right) \leq G_{ASM} \quad (5)$$

- Estimated Mean Shift method (EMS)

Greenwood and Chase (1987) proposed a method to express assembly stack-up conditions based on a degree of uncertainty corresponding to individual dimensions ( $\theta_i$ ) or so called Mean shift factor to quantify the expected mean shift as a fraction of the tolerance precision ranges. The method is expressed as:

$$\sum_{i \in N} \theta_i * \left| \frac{\partial Y}{\partial X_i} * t_i \right| + \sqrt{\sum_{i \in N} \left( (1 - \theta_i) * \frac{\partial Y}{\partial X_i} * t_i \right)^2} \leq G_{ASM} \quad (6)$$

The obtaining results will always lie between the Worst case and the RSS as the extreme case.

- Modified Root Square Sum (MRSS)

Modified root square sum is a more general form of RSS that takes into account the deviations caused by real industry assembly cases. The assumption of the normal distribution is due to the reasonable approximation of this distribution regarded to the true distribution which may be flatter or skewed (Greenwood & Chase, 1987). The MRSS can be expressed as:

$$C_f Z \sqrt{\sum_{i \in N} \left( \frac{\partial Y}{\partial X_i} * \frac{t_i}{Z_i} \right)^2} \leq G_{ASM} \quad (7)$$

Where  $C_f$  is a correction factor added for any non-ideal conditions and is equal to 1.5,  $Z$  denotes the number of standard deviations desired for the specified assembly tolerance, and  $Z_i$  is the expected standard deviation for each assembly component tolerance.

- **Motorola Six Sigma Program (MSSP)**

Motorola's Six Sigma is to achieve  $\pm 6\sigma$  high-quality level for all assembly components where it assures 0.002 defects per million (Placek, 1989). The concept behind this technique is to assume a mean shift on each component dimension that is equal to 1.5 standard deviations. The shift that occurred will be most likely to cause interference or a failure to meet the requirement. Equation (18) represents the formulation:

$$Z \sqrt{\sum_{i \in N} \left( \frac{\partial Y}{\partial X_i} \right)^2 * \left( \frac{t_i}{3C_{pi}(1 - \theta_i)} \right)} \leq G_{ASM} \quad (8)$$

Examining various techniques highlights their intricacy and significance, but the application of each technique is closely tied to the assembly mechanism and specific requirements. As a result, these techniques serve as building blocks for developing future approaches to tolerance analysis.

#### **I.1.4. Cost-tolerance optimization**

The allocation of design and manufacturing tolerances has a significant effect on both manufacturing cost and quality. To guarantee that the product reaches the specified level of performance, designers strive for exact tolerances, but manufacturers prefer relaxed tolerances to reduce manufacturing costs. Indeed, tolerances are allocated to ensure the respect of geometrical product requirements and to achieve optimal manufacturing cost. Three tolerance synthesis techniques are used: rules-based synthesis, knowledge-based synthesis, and optimization synthesis (Etienne *et al.*, 2008). The optimization approach is commonly based on a parametric model of the tolerance cost (Andolfatto *et al.*, 2014; Chase *et al.*, 1990; Chou & Chang, 2001; Dantan *et al.*, 2008; Etienne *et al.*, 2009; Walter *et al.*, 2015). The parametric model structures vary from linear to non-linear (Chase *et al.*, 1990). For instance, several types of manufacturing cost models can find respectively, reciprocal power function (RP) (Sutherland & Roth, 1975), Cubic Polynomial (Cubic-P) (Dong *et al.*,



1994b), also, Hybrid models which are adopted from conventional cost models (Dong *et al.*, 1994b). In **Figure 9**, the common cost-tolerance models are illustrated and compared.

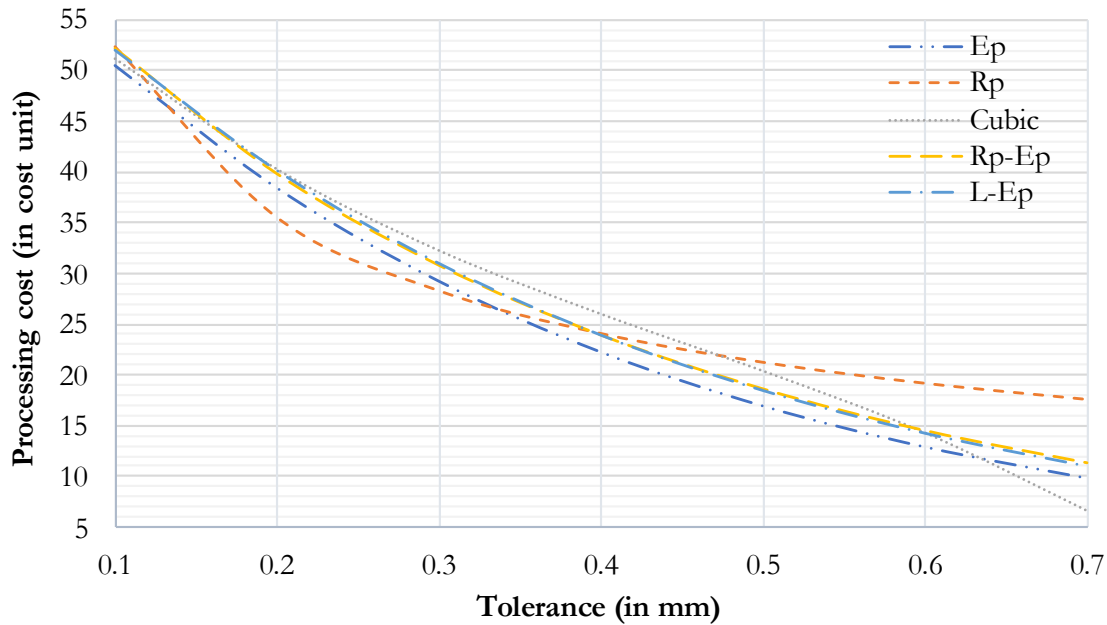

**Figure 9.** Comparison of available cost-tolerance models.

The cost model development relies on an extensive individual study of existing manufacturing resources and tolerance variation sensitive analysis to yield an appropriate cost-tolerance model (Hallmann *et al.*, 2020a, 2021; Saravanan *et al.*, 2020; Wu *et al.*, 2021). Tsutsumi *et al.* (2020) integrated product design, process planning, and production planning optimization in multi-product assembly assessing the investment efficiency and reducing the overall production cost. Armillotta (2020b) provided a comprehensive review of the parametric cost-tolerance functions and investigated the models' inconsistencies due to parameter variabilities. Wang *et al.* (2021) established a novel variation management framework for key control characteristics in multistage machining processes considering quality-cost equilibrium. In more recent research, Han *et al.* (2022) incorporated the Monte Carlo method into the cost-tolerance model. The method tackles the impact of deviations on the economy of quality design and the reliability of optimization results.

Contrary to the parametric cost-tolerance models, several activity-based cost models have been proposed. Etienne *et al.* (2009) proposed an activity-based cost model which rationally provides an accurate indicator of the relevance of tolerances values fixed by designers. This model associates the impacts of tolerance allocation on all activities included in the product lifecycle (manufacturing,

inspection, scrap, etc). Dantan *et al.* (2022) introduced inspection planning into the tolerance allocation. It integrates several factors such as frequencies of the monitoring and inspection activities, conformed product rate, non-detection of non-conformity rate, and non-detection of conformed rate.

The literature on tolerance analysis techniques and tolerance allocation methods has led to a recognition of the necessity for a modular cost-tolerance model that can effectively incorporate tolerance analysis. Additionally, we explore the incorporation of production strategies into the tolerancing domain.

## **I.2. Production strategies in tolerance allocation optimization**

This section gathers the literature on the introduction of the production strategies such as resource allocation, reworking, and assembly strategies into tolerancing.

### **I.2.1. Resource allocation**

The integration of resource capability and the introduction of machine selection into tolerance allocation can be found in (Bjørke, 1978). He studied the interdependency between machine selection and tolerance allocation and suggested a simultaneous continuous linear cost-optimization model. In extension, Irani *et al.* (2007) developed a graph-based optimization model representation of tolerance chains to find optimal processing sequences. Zhang and Wang (1993) studied an interrelated dimension chain considering manufacturing processes while allocating optimal tolerances. The integration of interrelated dimensions and manufacturing resources can also be found in (Singh *et al.*, 2005). Moreover, Zhang and Wang (1998) in complementary research, proposed a robust approach to appropriately allocate assembly and machining tolerances while maximizing a product's robustness.

The impact of resource variation has also been studied in the context of quality loss. Feng and Kusiak (1997) addressed quality loss in tolerance allocation and resource allocation where the resource variation was applied on a multi-dimensional tolerance chain. Afterward, Vasseur *et al.* (1997) expanded the concept of quality loss into manufacturing cost and presented a method for the selection of resources to manufacture various components of an assembly product.

The cost model development relies on an extensive individual study of existing manufacturing resources and tolerance variation sensitive analysis to yield an appropriate cost-tolerance model (Armilotta, 2020a; Hallmann *et al.*, 2020a; Lin & Chang, 2002; Ramesh *et al.*, 2009; Saravanan *et al.*,

2020). Moreover, Wu *et al.* (2021) introduced machine tool static geometric accuracy into tolerance modeling. The small displacement torsor is applied to map the relationship between the geometric error of machine tools and tolerance design. Afterward, the Monte-Carlo simulation method is established to determine the response model of the torsor parameters and the tolerance variation bandwidths. The study of resource allocation implies the impact of the process deviation on the conformity of the final product and the processing cost. As a common conclusion, the more precise the machine being used, the more costly will be the process. Therefore, an alternative to this solution can be found in applying a reworking process which can enhance the conformity of the product with the available machine resources.

### **I.2.2. Reworking**

The impact of reworking on the economy was studied in (Ferrer & Ayres, 2000) which was introduced as a process to repair or substitute components that are worn out or obsolete. The observations reported a significant reduction in the level of inter-industry transactions, as well as an improvement in the manufacturing cost. The traces of reworking in the context of tolerancing can be seen in Lee *et al.* (2000) where authors proposed a cost-effective means for tolerance allocation. The authors compounded the probabilities of scrap and rework to obtain the expected loss cost. Additionally, Shin and Cho (2007) addressed the reworking concept by providing a tool to balance the quality and manufacturing costs. Moskowitz (2010) developed a cost model to determine appropriate tolerance allocations where a nonconforming product can be scrapped or reworked. This model is based on a partial information case, where design parameter distributions are not identified. Moreover, the authors studied both parametric and non-parametric rework models. Mustajib and Irianto (2011) modeled an optimization model for quality improvement in multi-stage processes. The model integrated alternatives process selection to determine the unit of production and associated manufacturing costs. Mustajib (2012) proposed a concurrent tolerance-cost optimization model considering process capability and costs of non-conformance. The non-conformity is the failure to meet the designed requirement due to process variation. Costs of non-conformance include rework and scrap costs. Sofiana *et al.* (2019) considered the impact of rework on the quality of product, and the impact of a profit-sharing policy, which may stimulate the commitment of suppliers to quality improvement. Liu *et al.* (2021) proposed a novel double tolerance scheme for determining tolerance

sets on a production line with processing and rework stations, as well as instantaneous inspection and scrap operations. The production line comprises a rework station that handles non-conformed products, and a queuing system is applied.

### **I.2.3. Assembly strategies**

Specifying tolerances is a vital key to understand how the specifications and their variability impact the design requirement and manufacturing performance. However, the specification of design tolerances also affects the number of assembled components and the desired functionality. Therefore, assembly strategies such as Selective Assembly (SA) and Individual Assembly (IA) may represent expedient alternatives as compared to Random Assembly (RA) of interchangeable components.

Random assembly involves assembling a product using components that are chosen at random. This approach has been the subject of several studies in the manufacturing literature, with researchers exploring its potential benefits and challenges. One key benefit of random assembly is cost savings. By using a random sampling method to select components, manufacturers can take advantage of economies of scale and reduce their costs (Mease *et al.*, 2004). This is because random assembly allows manufacturers to use a larger pool of components than SA and IA methods, which can help to reduce the costs associated with sourcing and stocking specialized components. However, the random assembly also has some challenges. One challenge is quality control. Because the components used in random assembly are chosen at random, it can be difficult to ensure that all final products meet the required quality standards. This is particularly true in industries such as automotive, where the quality of individual components can have a significant impact on the overall performance of the product (Ceglarek & Shi, 1995). Therefore, SA and IA methods are proposed to improve the overall performance.

The selective assembly has been used in manufacturing for years and has been focused on several key aspects (Caputo & Di Salvo, 2019; Clottey & Benton Jr, 2020; Shin *et al.*, 2009; Wang *et al.*, 2018). Selective assembly is a technique to preserve functional requirements between two mating components which may be obtained from relatively low-precision components. In SA the mating components are manufactured with wide tolerances, therefore, it is required to 100% inspect all the manufactured components, then they are partitioned into dimensional bins. Afterward, the

components are then randomly selected from within bins for assembly with minimum clearance. As far as SA is concerned, the existing studies can be categorized into two main streams: (1) pairing methodologies and (2) binning strategies.

The pairing methodologies are more objected to propose an efficient bin combination method that satisfies the performance requirement (Desmond & Setty, 1961; Goethals & Cho, 2012; Jeevanantham & Kannan, 2013; Kannan *et al.*, 2009; Kern, 2003; Lanza *et al.*, 2015; Mansoor, 1961; Memon *et al.*, 2012; Rezaei Aderiani *et al.*, 2019; Victor Raj *et al.*, 2011a). This stream also studies criteria to properly combine bins according to components' variability degree, such as selecting binning strategies and tolerances allocation between components to be mated. A variety of assembly criteria such as matching ratio maximization (Coullard *et al.*, 1998; Victor Raj *et al.*, 2011a, b), surplus components minimization (Asha *et al.*, 2008; Kannan & Jayabalan, 2001; Kannan *et al.*, 2003; Matsuura & Shinozaki, 2011; Victor Raj *et al.*, 2011a), the assembly variation minimization (Asha *et al.*, 2008; Kannan *et al.*, 2003; Kannan *et al.*, 2005), and assembly cost minimization (Babu & Asha, 2014; Caputo & Di Salvo, 2019) can be found in the literature.

The second stream in SA studies discusses the binning strategies that are focused on the optimization of the components' binning strategies in order to minimize variations and surplus components. In the literature, the classical partitioning methods are classified as (a) equal width (variance) partitioning (Matsuura & Shinozaki, 2011; Pugh, 1992) and (b) equal area (probability) partitioning (Chan & Linn, 1998; Fang & Zhang, 1995) aimed at minimizing assembly variation or scrap. Moreover, recent binning strategies are focused on concerning the difference in mating component size distribution. In this case optimized partitioning helps to minimize surplus components and quality loss (Kannan & Jayabalan, 2001; Malaichamy *et al.*, 2016; Matsuura & Shinozaki, 2010; Mease *et al.*, 2004; Rezaei Aderiani *et al.*, 2018).

### **I.3. Conclusion**

The comprehensive comparison of tolerance analysis techniques and cost-tolerance allocation models shows the significant differences between the two schemes. Tolerance analysis techniques are needed to verify the proper functionality of the engineering design, taking into account the tolerances of the components. The tolerance analysis issues are concluded in **Figure 10**.

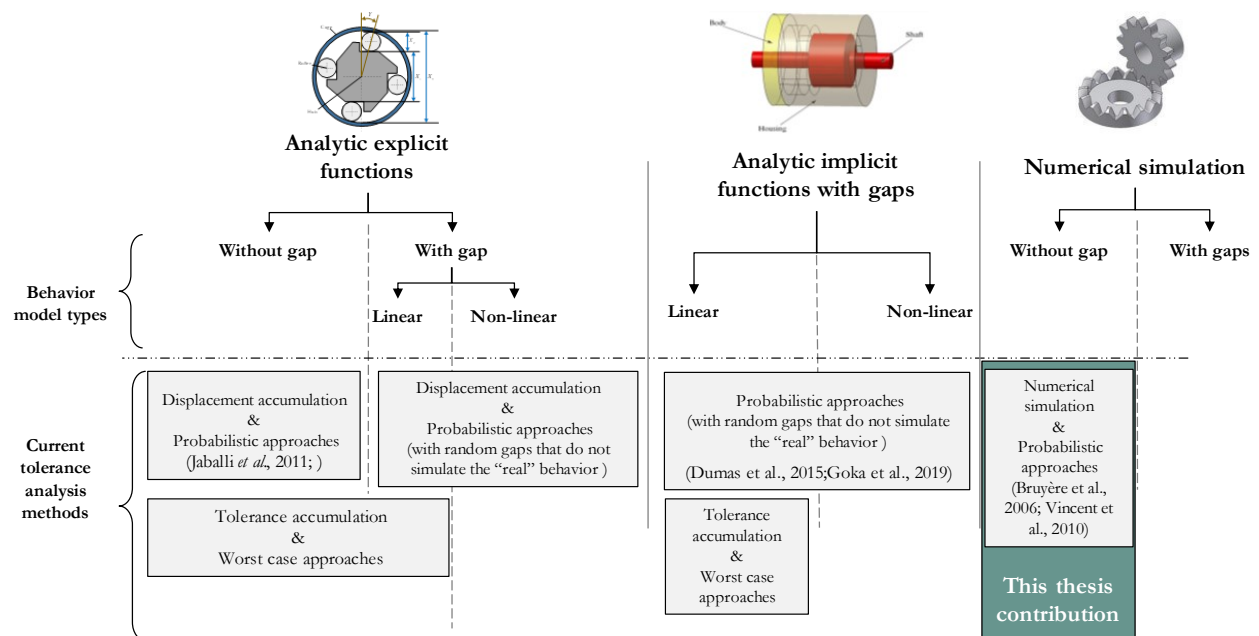

**Figure 10.** Tolerance analysis issues literature

The application of various techniques relies on the design complexity, the designer's experience, and the empirical data. In this regard, statistical techniques such as numerical simulation and probabilistic approaches are developed to present a stochastic overview of the design functionality.

Contrary to the tolerance analysis technique, tolerance allocation is carried out to distribute tolerance on the components' key characteristics (KCs) by incorporating optimization methods. Most of the methods are focused on allocating optimal tolerance values while minimizing the cost value. The designers prefer tight tolerances to assure the quality of the design; however, the manufacturers prefer loose tolerances to decrease the manufacturing cost. Most of the cost-tolerance allocation models proposed in the literature are based on parametric models which require empirical studies to adapt the model to the design. Nevertheless, the adapted model does not apply to other designs. An activity-based cost model is an alternative to parametric modeling in this work. The model associates the average cost value per activity such as processing, inspection, reworking, assembly, scrapping, etc to their contribution to the conformity of the components. Therefore, the model facilitates the integration of a variety of activities such as resource allocation, reworking, and assembly into the tolerance allocation problem. The literature in this domain is depicted in **Table 5**.

On these bases, the necessity of a statistical tolerance analysis technique and cost-tolerance optimization coin the direction of this work. This work develops a statistical method to predict the conformity of the components; and introduces resource allocation, reworking, and assembly strategies into the cost-tolerance allocation model to improve the system.

Table 5. Cost-tolerance optimization and concurrent problems literature

Authors	Cost-tolerance model		Production strategies				Tolerance analysis technique		
	Modular	Hybrid	Resource allocation	Reworking	Assembly			Deterministic	Probabilistic
					Random	Selective	Individual		
Andolfatto <i>et al.</i> (2014); Armillotta (2022); Babu and Asha (2014); Chase <i>et al.</i> (1990); Chou and Chang (2001); Dong <i>et al.</i> (1994a); Hallmann <i>et al.</i> (2020b); Han <i>et al.</i> (2022); Roth <i>et al.</i> (2021); Saravanan <i>et al.</i> (2020); Sutherland and Roth (1975); Tsutsumi <i>et al.</i> (2020); Wang <i>et al.</i> (2021); Wu <i>et al.</i> (2021)		✓			✓			✓	
Bjørke (1978); Hallmann <i>et al.</i> (2021); Mustajib and Irianto (2011)		✓	✓		✓			✓	
Lee and Johnson (1993)		✓			✓				✓
Irani <i>et al.</i> (2007); Ramesh <i>et al.</i> (2009); Singh <i>et al.</i> (2005); Zhang and Wang (1993, 1998)		✓	✓		✓				
Lee <i>et al.</i> (2000); Moskowitz (2010); Shin and Cho (2007) Sofiana <i>et al.</i> (2019)		✓		✓	✓			✓	
Asha <i>et al.</i> (2008)		✓				✓		✓	
Dantan <i>et al.</i> (2022); Etienne <i>et al.</i> (2009)	✓				✓			✓	
Clottey and Benton Jr (2020); Jeevanantham and						✓		✓	



*A comprehensive study on tolerancing issues and production strategies*

Authors	Cost-tolerance model		Production strategies				Tolerance analysis technique		
	Modular	Hybrid	Resource allocation	Reworking	Assembly			Deterministic	Probabilistic
					Random	Selective	Individual		
Kannan (2013); Shin <i>et al.</i> (2009); Wang <i>et al.</i> (2018)									
Mustajib (2012)		✓	✓	✓	✓			✓	
Lanza <i>et al.</i> (2015); Rezaei Aderiani <i>et al.</i> (2018); Rezaei Aderiani <i>et al.</i> (2019)						✓			✓
Caputo and Di Salvo (2019)		✓						✓	
Sun <i>et al.</i> (2020); Yi <i>et al.</i> (2021)							✓		✓
Liu <i>et al.</i> (2021)		✓		✓	✓				✓
Wu <i>et al.</i> (2021)		✓	✓		✓				✓
<b>This thesis including Khezri <i>et al.</i> (2022a, 2023a); Khezri <i>et al.</i> (2022b); Khezri <i>et al.</i> (2023b); Khezri <i>et al.</i> (2023c)</b>	✓		✓	✓	✓	✓	✓		✓

## Chapter II: Defining a surrogate model for statistical tolerance analysis

---

The study of contemporary tolerance analysis techniques and the necessity of modern industries for having a comprehensive interpretation of complex products can be deemed in the literature. The growth of simulation tools and Machine Learning (ML) techniques as two crucial computer-aided tools evaluating complex mechanical functionality is investigated. Therefore, the advantages of simulation and ML assist in the prediction of complex mechanisms' behavior in efficient time and accuracy. In this section, the application of simulation\ML tools in tolerance analysis is employed.

---

## **Table of Contents**

II.1. Development of a novel statistical tolerance analysis model.....	59
II.1.1. Statistical tolerance analysis model description.....	59
II.1.2. Statistical tolerance analysis model formulation.....	60
II.2. Statistical tolerance analysis applications .....	62
II.2.1. Simulation-assisted approach: application on the overrunning clutch .....	62
II.2.2. Physical behavior surrogate-assisted approach: application on the electric motor.....	65
II.3. Statistical surrogate-assisted approach development: application on the gears .....	69
II.3.1. Gear numerical simulation .....	69
II.3.2. Initial sampling and experimental design .....	73
II.3.3. Imbalanced data refining and surrogate modeling.....	75
II.3.4. Surrogate model.....	76
II.4. Conclusion.....	77

## II.1. Development of a novel statistical tolerance analysis model

Statistical tolerance analysis is a technique that uses statistical methods and modeling to understand the distribution of variations and deviations in a mechanism, and then allocate tolerances in a way that balances performance and cost. This section details the techniques and supports a mathematical model which predicts the conformity rate of the manufactured components considering resource deviations and reworking impact.

### II.1.1. Statistical tolerance analysis model description

The earliest studies on Monte Carlo simulation reported in the literature appear in the early 1970s (Corlew & Oakland, 1976; Distler, 1977). The Monte Carlo simulation approach is capable to incorporate complexities in process distribution and complexities in assembly response function. It is based on the stochastic sampling of the individual component dimensions to produce a virtual assembly. Since the dimensions yielded from various manufacturing processes are obtained with a definite pattern, this approach can be valuable to approximate the variation in the assembly response. This random sampling approach is straightforward which makes it applicable to both the linear and nonlinear assembly response functions, as well as the normal and non-normal process distributions (Singh *et al.*, 2009). The important issues in the application of Monte-Carlo can be listed as follows:

- (1) The choice of probability density function representing the distribution of independent dimensions (He, 1991; Law & Kelton, 2000; Varghese *et al.*, 1996);
- (2) Length of simulation run (Gao *et al.*, 1995; Lee & Johnson, 1993; Lin *et al.*, 1997; Zhou *et al.*, 2001);
- (3) Simulation runtime.

The importance of the number of the simulation and the simulation time is investigated through different case studies proposed in this research. The overrunning clutch is categorized as a simple engineering mechanism with a non-linear behavior assembly response and one KC on each component. A Monte-Carlo simulation approach is employed to investigate the statistical behavior of the assembly. Afterward, the statistical behavior of the electric motor is examined through a Monte-Carlo simulation and a physics-based surrogate model. This mechanism comprises multiple characteristics per component with a non-linear assembly response between the characteristics. Therefore, the example is classified as a complicated engineering assembly. In the following, the analyses on statistical tolerance analysis approaches are detailed.

### II.1.2. Statistical tolerance analysis model formulation

The tolerance of a component can be defined as the permissible variation in measurements deriving from the nominal values. It can be expressed as follow:

Parameters:	
$N$	Set of components of the assembly
$NMC$	Number of Monte-Carlo simulation
$N_d$	Number of design constraints on characteristics
$N_r$	Number of rework constraints
$N_f$	Number of functional constraints
$N_c^i$	Number of characteristics on component $i$
$C_d$	Set of design constraints
$C_r$	Set of rework constraints
$C_f$	Set of functional constraints
$LSL_i$	Lower specification limit for component $i$
$USL_i$	Upper specification limit for component $i$
$\mu_i$	The nominal value of dimension for component $i$
$\sigma_i$	Process deviation for component $i$
$\alpha$	Inspection Type I failure rate
$\beta$	Inspection Type II failure rate
Decision variables:	
$rw$	1 if reworking decision is taken, otherwise, 0
$\gamma_i$	Component $i$ conformity rate
$\gamma_i^{RW}$	Component $i$ reworking rate
$\gamma_i'$	Component $i$ conformity rate after reworking
$\lambda$	Assembly conformity rate

$$t_i^j = USL_i^j - \mu_i^j \text{ and/or } t_i^j = \mu_i^j - LSL_i^j, \forall i \in N, \forall j \in N_c^i \quad (1)$$

where USL and LSL express upper and lower specification limits and  $\mu$  denotes nominal value. This work supports a statistical-based approach integrating resource allocation and reworking decisions into the tolerance allocation problem. Within this approach, the consequences of the decisions are associated with probability rates. Therefore, to go further, the model follows several assumptions:

- (1) The model is developed for material removal processes. There are two types of material removal processes: traditional and non-traditional. Traditional machining processes are those that have been in use since early times and continue to be employed now such as lapping, turning, drilling, etc. They are utilized in practically every type of general product manufacture. Alternatively, non-traditional machining methods are those that are not widely used and are only employed for very high-quality technical work. Non-traditional material removal technologies include Electro Chemical Machining (ECM), Electric Discharge Machining (EDM), etc (Groover, 2020).
- (2) The reworking process concerns only the assembly components and can be applied once on the same allocated resource. Afterward, the component is controlled whether it lies in the design specifications and be conformed or not and be rejected.

Using the assumptions aforementioned, they lead us to develop an estimation model predicting the conformity rate of the manufactured components considering resource deviations and reworking impact. The conformity rate can be separated into two states of the manufacturing system: the state without reworking ability, and the one with reworking ability. On these bases, the conformity rate can be estimated depending on three decision variables: allocated tolerance ( $t_i$ ), process variation associated with the assigned resource ( $\sigma_i$ ), and reworking decision ( $rw$ ).

- The conformity of a component ( $\gamma$ ) is the likelihood a component meets the design constraints ( $C_d$ ) corresponded to the geometrical deviation ( $Dev$ ). Eq. (4) investigates the conformity rate of the engineering design with the allocated tolerances lies in the admissible rework domain. This domain represents the capability of the resource to perform the reworking, as well as the designers' preference on how it should be performed. In Eq. (5), the conformity rate of the components is evaluated after reworking and is considered as a production strategy in the manufacturing system. Therefore, this equation sums up the conformity of the component accepted in the first place and the conformity of the rejected component which was reworked and conformed.

$$\gamma_i = \underset{t \in \mathbb{R}, \sigma \in \Sigma}{Prob} \left( \bigcap_{i=1}^{N_d} C_d^{(i)} (Dev_i) \in [Deviation\ domain] \right) , \forall i \in N \quad (2)$$

$$Dev_i = Rand(0, \sigma_i) , \forall i \in N \quad (3)$$

$$\gamma_i^{RW} = Prob_{t \in \mathbb{R}} \left( \bigcap_{i=1}^{N_r} C_r^{(i)} (Dev_i) \in [Admissible\ rework\ domain] \right) , \forall i \in N \quad (4)$$

$$\gamma_i' = \underbrace{\gamma_i}_{\text{Conformed without reworking}} + \underbrace{rw \times \gamma_i^{RW} \times \gamma_i}_{\text{Reworked and conformed}} , \forall i \in N \quad (5)$$

- The assembly conformity rate illustrates the probability that geometrical deviations on the assembly components respect functional constraints ( $C_f$ ) set.

$$\lambda = Prob_{t \in \mathbb{R}^+} \left( \bigcap_{i=1}^{N_f} C_f^{(i)} (Dev_i) \in [Functional\ domain] \right) \quad (6)$$

However, these equations lack precision when it comes to estimate the assembly conformity rate of a complex mechanism with more than a few unbiased functional requirements. Therefore, these equations can be altered by developing a simulation or a surrogate-assisted technique to calculate this rate.

## II.2. Statistical tolerance analysis applications

The application of the proposed model is realized in this section. A Monte-Carlo-assisted tolerance analysis technique is developed to investigate the components and assembly conformities. Moreover, the electric motor behavior is analyzed by a surrogate model. The surrogate model is constructed using data drawn from a high-fidelity simulated model and mimics approximately the behavior of the simulation model as fast as possible (Queipo *et al.*, 2005). The system's behavior response ( $f$ ) is supported by set of constraints ( $\Phi$ ) who analyses system according to associated allocated tolerances ( $t$ ) and resources ( $\sigma$ ). The estimation of the system's behavior response ( $\hat{f}$ ) can be approximated by assessing the simplified system's behavior constraints. Therefore, the response ( $\hat{f}$ ) can be approximated based on the new set of constraints. Since the electric motor has more characteristics, the simulation is time-consuming. Therefore, the surrogate model is proposed to evaluate the behavior time efficiently.

### II.2.1. Simulation-assisted approach: application on the overrunning clutch

In this section, a Monte-Carlo simulation approach is introduced to realize overrunning clutch functionality functions of input tolerance intervals and manufacturing process deviations. **Figure 11** depicts the simulation approach. The simulation tool receives the inputs and generates a random set

of geometrical deviations. Afterward, at each iteration of the simulation, the feasibility of the deviations and assembly response is evaluated. More in detail, in the assembly mechanism, the contact angle ( $Y$ ) is the functional requirement and its value must be controlled within the range  $7 \pm 1 \text{ deg}$ .

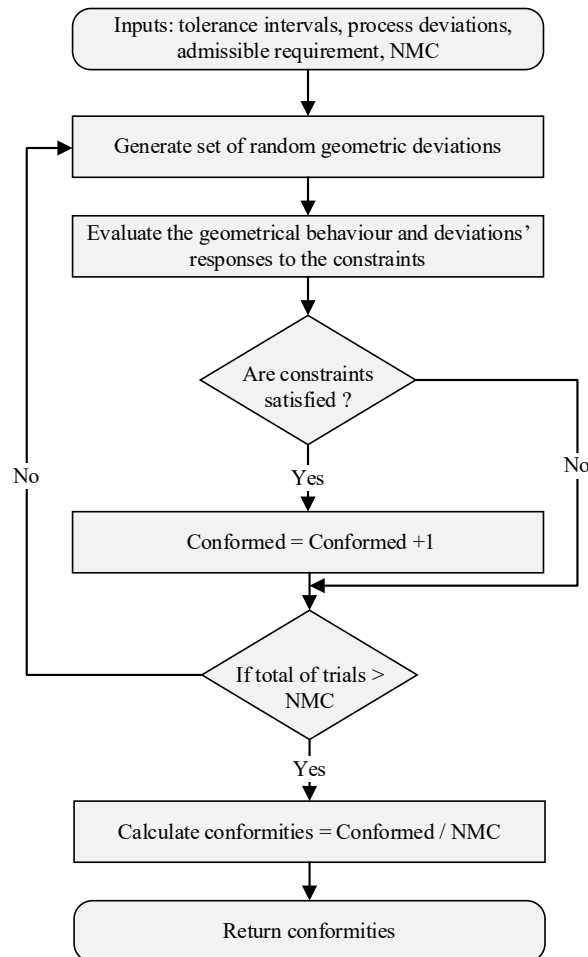

**Figure 11.** Simulation-assisted approach flowchart

The function design depends on components' geometrical deviations, i.e., hub ( $X_1$ ), roller ( $X_2$ ), and cage ( $X_3$ ) and it is expressed as follows:

$$Y = f(X_1, X_2, X_3) = \arccos\left(\frac{X_1 + X_2}{X_3 - X_2}\right) \quad (7)$$

The nominal value of the components ( $X_i, i = 1, 2, 3$ ) are  $55.3 \text{ mm}$ ,  $22.86 \text{ mm}$ , and  $101.6 \text{ mm}$ , respectively. In this study, a Root Square Sum (RSS) (eq. 4) is used which is well-known as an optimistic method to evaluate functional requirement deviation.



For the sake of simplicity, the derivatives of  $Y$  with respect to  $X_i$  ( $i = 1, 2, 3$ ) are calculated and given:  $\left. \frac{\partial Y}{\partial X_1} \right|_{\mu_{Hub}} = 0.1049$ ,  $\left. \frac{\partial Y}{\partial X_2} \right|_{\mu_{Roller}} = 0.2084$ ,  $\left. \frac{\partial Y}{\partial X_3} \right|_{\mu_{Cage}} = 0.1038$ . Furthermore,  $\sigma_i$  ( $i = 1, 2, 3$ ) represents manufacturing process deviation on each component. An imprecise ( $\sigma = 0.300 \text{ mm}$ ) and a precise machine ( $\sigma = 0.100 \text{ mm}$ ) tools are taken for a better illustration of the resources' impacts.

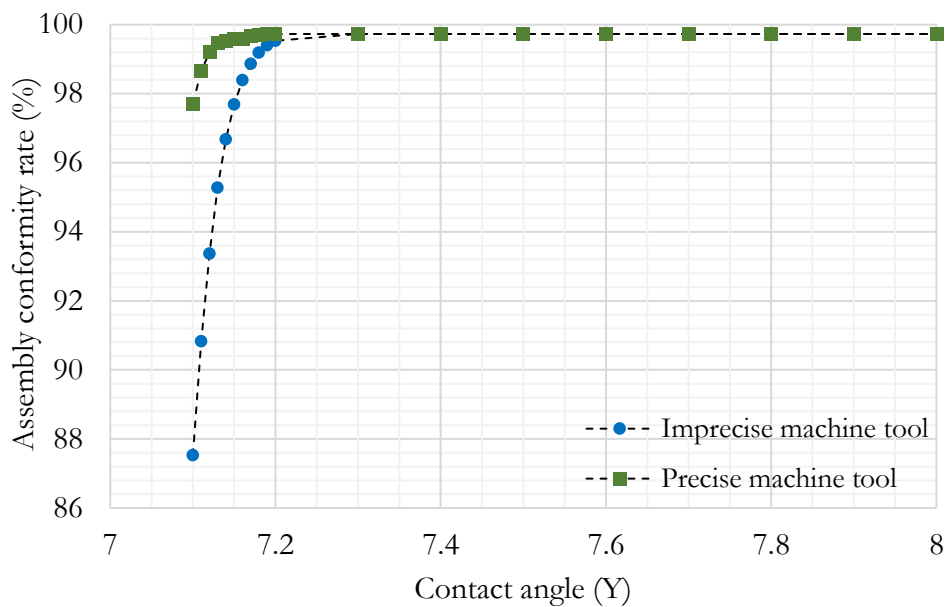

(a). Assembly conformity rate per functional requirement

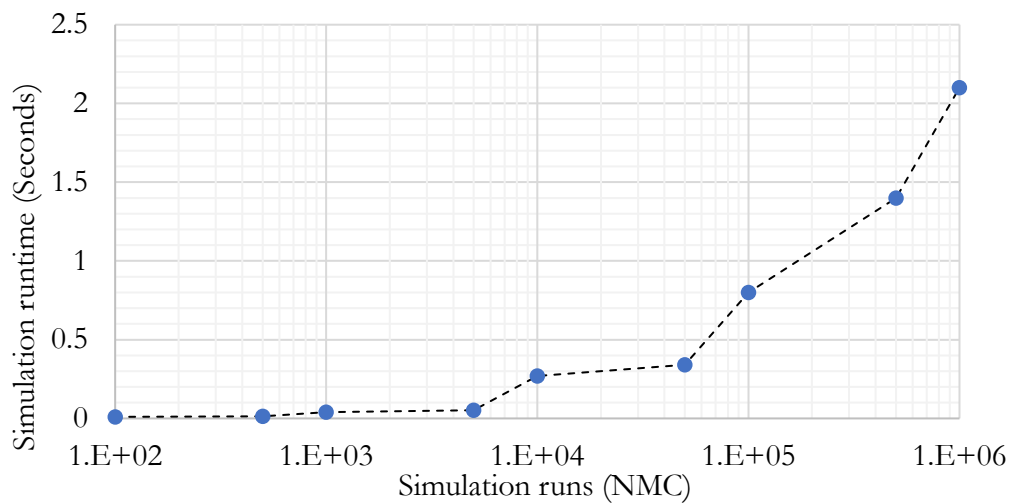

(b). Simulation runtime evaluation

Figure 12. Overrunning clutch simulation evaluations

The application of the Monte-Carlo is illustrated in **Figure 12(a)** for a variety of contact angles ( $Y$ ) as the functional requirement. At each iteration, the contact angle is introduced to the control unit which checks whether the evaluation response satisfies the constraints or not. Moreover, the flexibility of stochastic sampling allows designers to introduce manufacturing process deviation into the simulation. It means that the designers can simulate the evaluation response while different manufacturing resources are allocated.

Because simulation precision is critical to obtaining an accurate result, the number of Monte-Carlo (NMC) in this simulation is set at  $10^6$ . At each iteration of the simulation,  $10^6$  random geometric deviations are generated within the tolerance interval introduced. The simulation runtime evaluation is demonstrated in **Figure 12(b)** for a variety of NMCs. In conclusion, the overrunning clutch is represented as a simple assembly mechanism where the functionality can be calculated using the eq. (2). The simplicity of the design enables the designer to evaluate system functionality in an efficient time. However, escalating the mechanism complexity affects the simulation runtime which is examined in the next case studies.

### **II.2.2. Physical behavior surrogate-assisted approach: application on the electric motor**

In section II.2.1, a Monte-Carlo simulation is established, an analytical tool to realize assembly response functions of the manufacturing process and tolerance intervals. This model makes sure that the tolerances and resources are allocated adequately, and whether assembly response and design responses are conformed or not. Still, simulation implementation is based on the generation of several deviations in design characteristics, analyzing the behavior within the system of equations, and reporting back the conformity. On the one hand, an abundant number of generations of deviations provides a more accurate analysis of system behavior. On the other hand, reliant on the assembly complexity and number of generations, the simulation time escalates.

An alternative solution to improve performance is to substitute simulation for a surrogate model. The tolerance analysis technique in this mechanism evaluates the gap between surfaces. The mechanism works functionally once no interference between two surfaces occurs. Anselmetti (2006) investigated the electrical motor and established a tolerancing process that served by determining the specifications of influential components without form defects. Afterward, Goka *et al.* (2019b)

introduced form defects to contact surfaces of the system and developed a Monte-Carlo-based simulation approach to analyze the system behavior by assessing the assembly and functionality probabilities. The authors developed a simulation model in order to evaluate the mechanism's assemblability and functionality ratio.

In this section, a simplified surrogate model is proposed for contact analysis when form defects are not considered on the surfaces. This approach takes into account the rigid surfaces. Since rigid surfaces are assumed, several sample intersections can be taken on the assembly where the surfaces are in contact, then replacing the 3D model (**Figure 13(a)**) into a 2D model (**Figure 13(b)**).

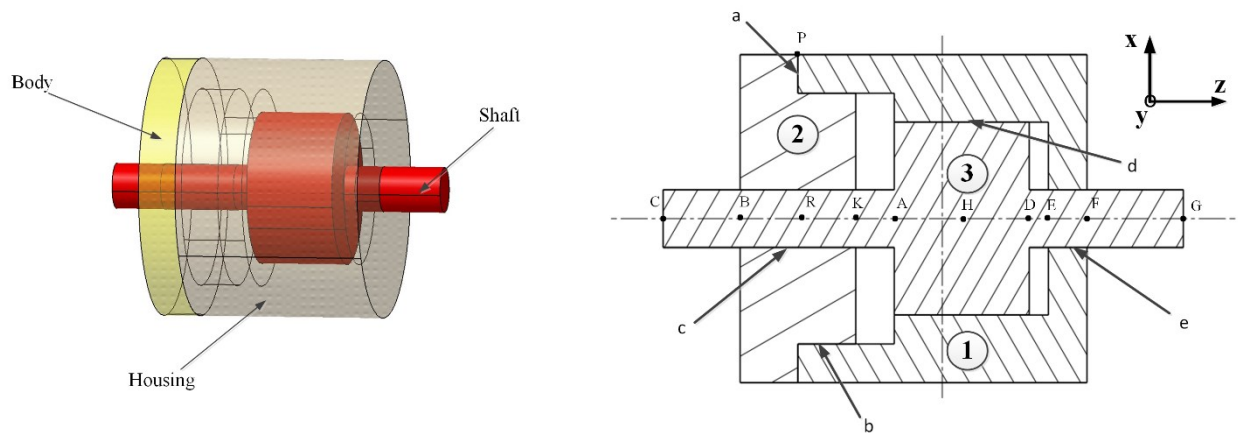

(a). Electric motor 3D model

(b). Electric motor 2D model

**Figure 13.** Electric motor 3D and 2D representation (Goka *et al.*, 2019b)

In this case study, seven critical features (F) are introduced in the assembly that controls the geometric deviations of the components. The house includes three main characteristics (see **Figure 14(a)**): features F11(which defines dimension and concentricity deviations), F12 (which specifies dimension and position deviations), and F13 (which identifies dimension and perpendicularity deviations). The body comes with two main characteristics and features: F21 (which specifies dimension and position deviations) and F22 (which includes dimension and perpendicularity) illustrating the specification limits (**Figure 14(b)**). The shaft consists of three main characteristics where features F31 and F32 (which specify the dimension and straighten deviations) plus F33 which defines dimension and concentricity deviations. Once the features are defined, the discretization method proposed by Dumas *et al.* (2015) is investigated to mesh the 3D surfaces with 2Ds.

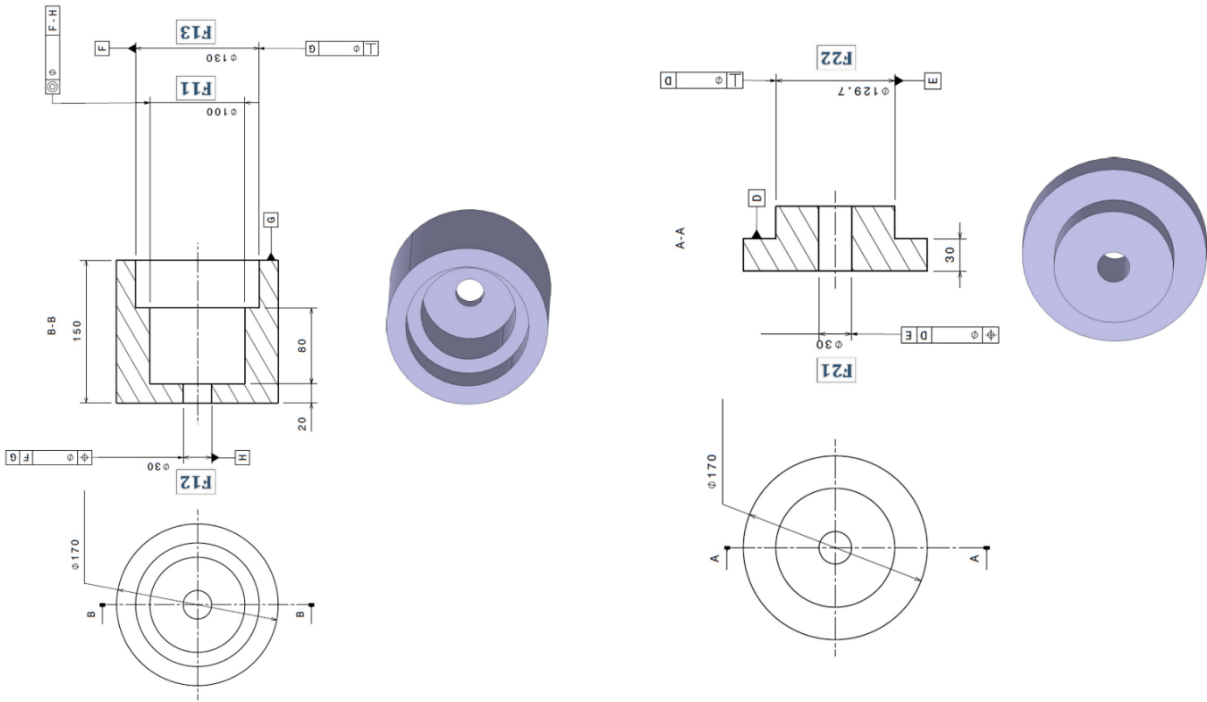

(a). House 2D and 3D technical representations

(b). Body 2D and 3D technical representations

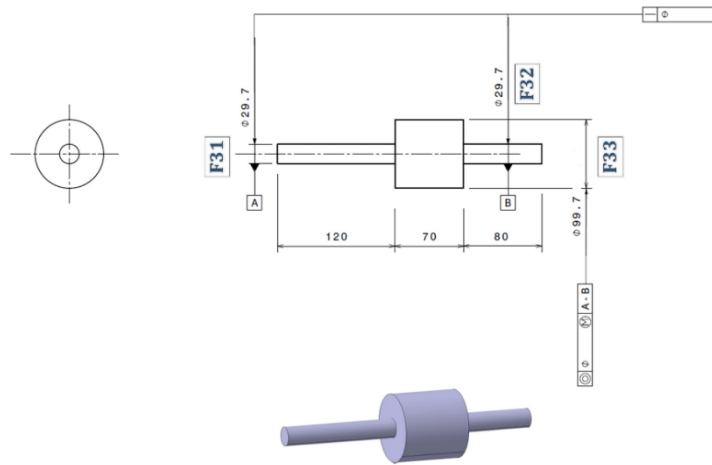

(c). Shaft 2D and 3D technical representations

Figure 14. Technical representations of the electric motor components in 2D and 3D (Goka *et al.*, 2019b)

In the 3D representation, 16 key geometrical deviations (e.g., dimension, position, perpendicularity, etc.) are specified. However, the 2D simplified model takes into account the key features which include the key deviations. Monte-Carlo simulation is embedded in the model to assure that at each iteration random linearization representations of the surfaces are demonstrated. This step helps to improve the accuracy of the simplified model. Since the approach doesn't take into the account whole contact surface, it increases the uncertainty to assess requirement evaluation.

The proposed approach is compared to the simulation model. **Figure 16** demonstrates this comparison. The increase in NMC increases the number of calculations in both approaches. However, the surrogate model evaluates the mechanism functionality in less time compared to the simulation model. Moreover, **Figure 15** shows the surrogate percentage error references to the simulation model. The increase in NMC lessens the error in the surrogate model. On one hand, the increase in NMC escalates the evaluation runtime; On the other hand, it improves functional behavior evaluation accuracy. Eventually, the new model is less complicated to evaluate the gap between two surfaces. Since the aim is to predict the functionality ratio, the Monte-Carlo simulation is employed to predict the ratio.

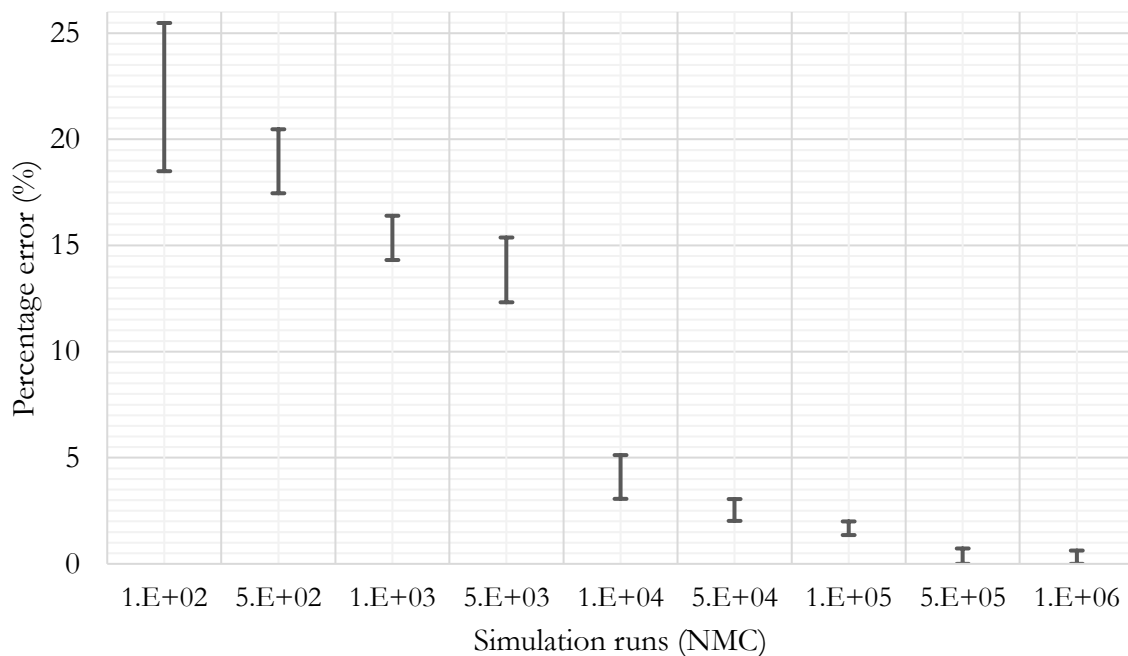

**Figure 15.** Surrogate percentage error references to the simulation

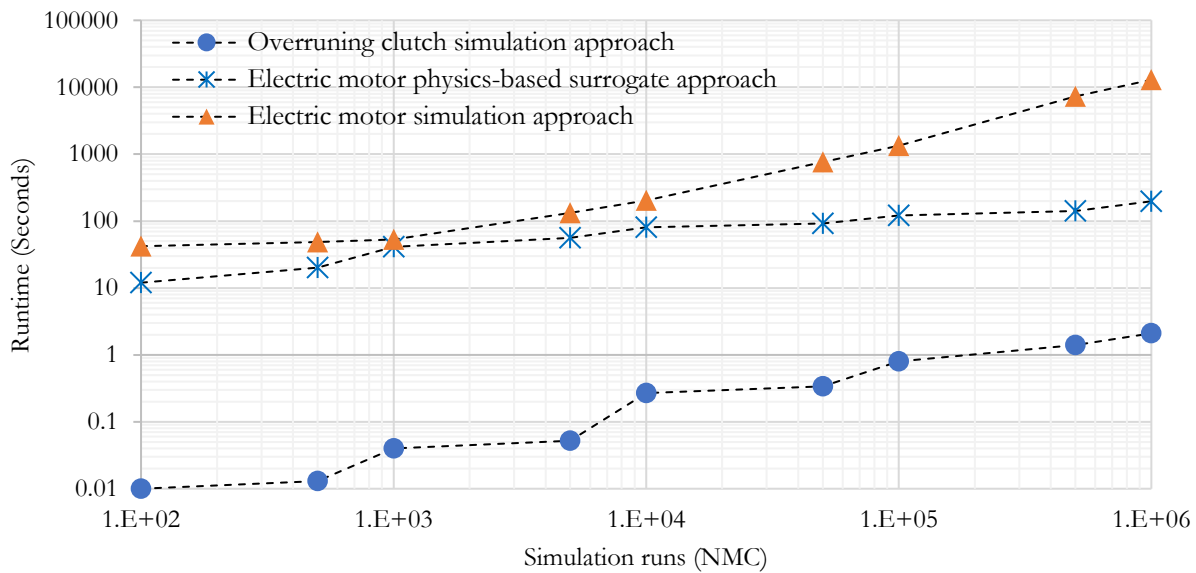

**Figure 16.** Tolerance analysis techniques runtime comparison for different cases

The change in the mechanism complexity requires a practical approach to improve the tolerance analysis technique. The complexity of a mechanism can be deemed from the number of KCs and the dependencies between the characteristics. Consequently, the change in the number of characteristics and dependencies impacts the tolerance analysis runtime and accuracy. **Figure 16** depicts the escalation in tolerance analysis techniques runtime as the engineering assembly faces more complexity in design. Therefore, in the next section, a novel surrogate-assisted tolerance analysis technique for a pair of gears is developed.

### II.3. Statistical AI-assisted approach development: application on the gears

The need for a more precise engineering mechanism brings more complexity to the design plan. The important factors in analyzing the complexity of a design can be the number of KCs, the dependencies between the characteristics, the linearity or non-linearity of the response system, etc. In this regard, gear designing is classified as a complex engineering mechanism with multiple KCs with solid dependencies. Therefore, the necessity of a statistical surrogate model which can predict the conformity of the assembly in an efficient time leads this section's direction.

#### II.3.1. Gear numerical simulation

In power transmission systems, gears are used in a variety of industries. Some of the advantages include durability, a constant transmission ratio, decreased size, excellent efficiency, and

appropriateness for a wide range of powers. However, gears have a variety of disadvantages, such as the vibration of the gear meshing system, which causes unwanted noises. The Kinematic Transmission Error (KTE), which is caused by misalignment of the gear, tooth profile inaccuracies, and tooth deflections, is the main source of such noises. Therefore, KTE value compromises the quality level of assembled gears associated with features' deviations. Gear tolerance analysis focuses on the analysis of the impact of manufacturing imprecisions (assembly misalignment, runout, eccentricity, pitch error, form defects) on the KTE, which is the difference between the existent position of the output gear and the predicted position if the gears were perfectly conjugate. Many mathematical theories have been developed in order to calculate the kinematic transmission error:

- KTE can be regarded as a minimized objective function (Gurumani & Shanmugam, 2011; Li *et al.*, 2017; Wu *et al.*, 2022),
- KTE can be modeled by a periodic function with a period  $2\pi/N$  (N: the number of teeth of the gear drive). Polynomial KTE functions were investigated (Lee, 2009; Litvin *et al.*, 1995).

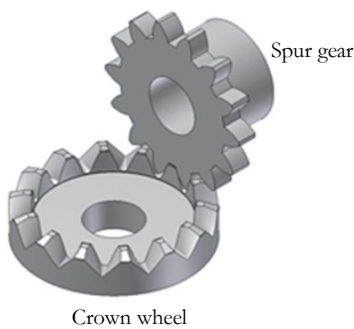

Parameter	Spur gear	Crown wheel
Module $m$	0.280 $mm$	0.280 $mm$
Number of teeth $z$	13	19
Profile shift factor $\alpha$	0.4	-

**Figure 17.** Use case

The case study is a pair of gears (**Figure 17**). The studied functional characteristic is the Kinematic Transmission Error (KTE), more specifically the maximum range of KTE:  $F_i$ . In the presented framework, we implement polynomial KTE functions to predict the tooth-to-tooth KTE and the global KTE. The estimation of the system's behavior response ( $\hat{f}$ ) (Eq. (8)) can be approximated by assessing the polynomial functions (Lee, 2009).

$$KTE = \hat{f}(Dev_{Misalignment}, Dev_{Runout}, Dev_{Pitch\ error}, Dev_{f\alpha}) \quad (8)$$

The model is a function of a set of geometrical deviations ( $Dev$ ), translational and rotational localization errors on the gears' geometry, which evaluates the global KTE associated with the geometrical deviations. Subsequently, a Monte-Carlo-based simulation is developed to evaluate the

gears and assembly conformity. The simulation is alike as demonstrated in **Figure 11**. The simulation is designed to receive a set of tolerances ( $T_{\text{Misalignment}}, T_{\text{Runout}}, T_{\text{Pitch error}}, f_{fa}$ ), process shifts ( $K_{\text{Misalignment}}, K_{\text{Runout}}, K_{\text{Pitch error}}, K_{fa}$ ), admissible KTE value, and the number of iterations (NMC). The process shift ( $K$ ) value indicates a change in a production process that results in a different outcome or product characteristic compared to the original process. The shift can have an impact on the quality and consistency of the end product, as well as on its conformance to tolerance limits. Therefore, the value compromises the geometric deviation and tolerances and returns the process shift due to process inaccuracy. It can be formulated as below:

$$K_i = \frac{T_i}{3 * Dev_i}, \forall i \in \{\text{Misalignment}, \text{Runout}, \text{Pitch error}, fa\} \quad (9)$$

For instance, when  $K = 1$ , the process deviates by  $\pm(3 * Dev)$  from the nominal value, which defines the tolerance limit for the feature. Pseudo-random number generators are used to generate a sample of geometrical deviations ( $Dev_{\text{Misalignment}}, Dev_{\text{Runout}}, Dev_{\text{Pitch error}}, Dev_{fa}$ ) considering the process shifts and tolerance boundaries. Subsequently, the KTE value and deviation responses are evaluated. Each instance of the simulation generates a new set of random geometrical deviations and responses are evaluated and stored. Finally, the number of conformed instances is calculated, and associated conformity rates are evaluated.

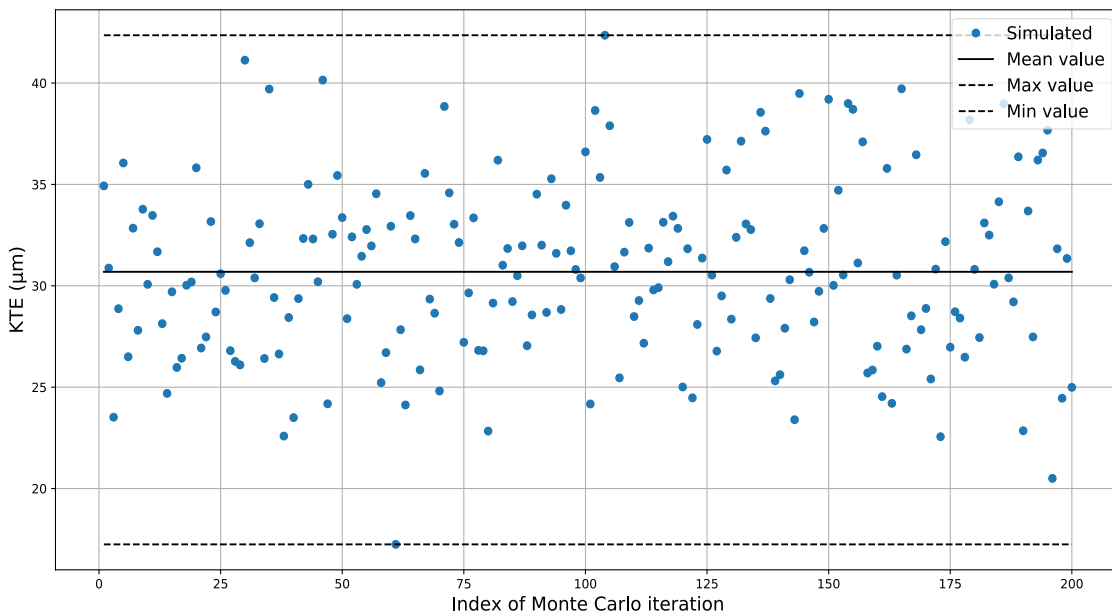

**Figure 18.** Simulated gears' meshing and evaluated KTE value over 200 Monte-Carlo runs



The number of simulations is a crucial parameter in this case study, therefore, a comprehensive analysis of the number of simulations is performed. Since further analysis depends on criteria such as the precision of the simulation and limited calculation resources, therefore,  $NMC = 10^6$  is opted. For instance, **Figure 18** demonstrates a simulation run with  $NMC = 200$  out of  $NMC = 10^6$  to provide a better understanding of the KTE fluctuation due to different geometrical deviations at each iteration.

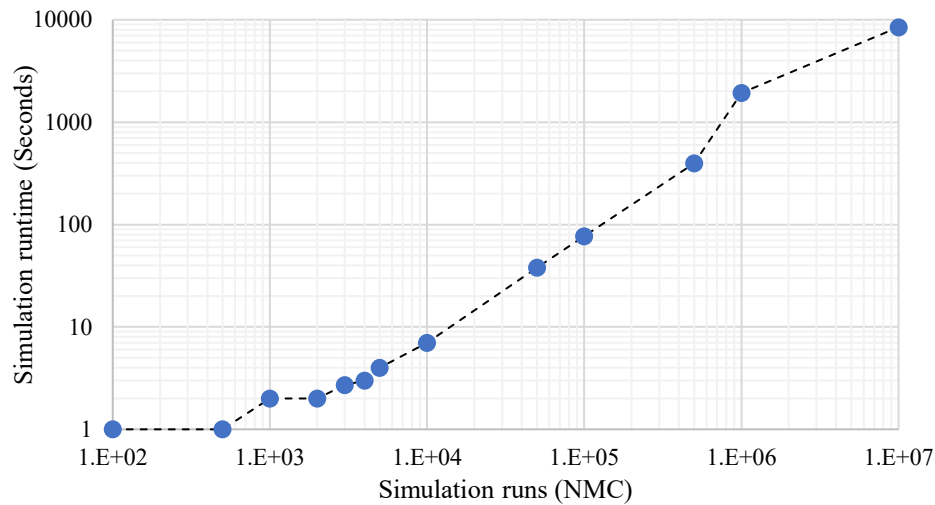

(a). Simulation runtime evaluation

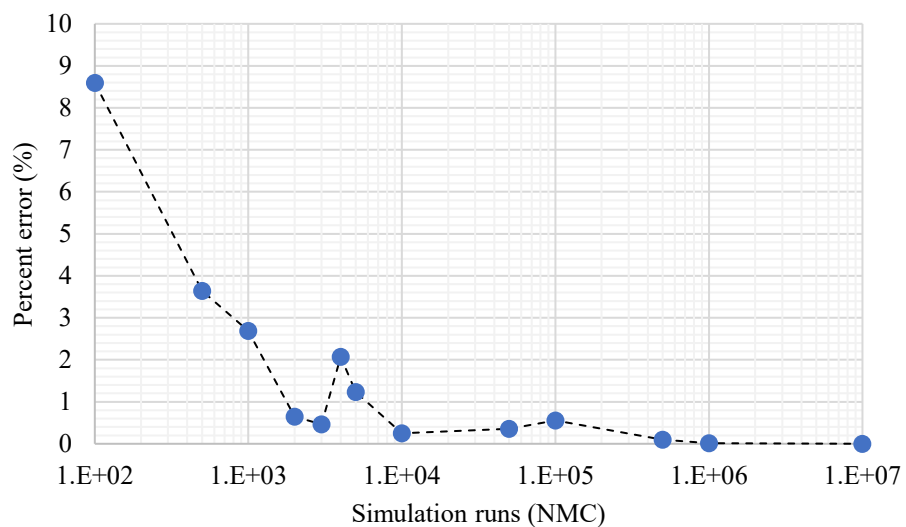

(b). Simulation percent error evaluation in reference to  $NMC = 10^7$

**Figure 19.** Simulation evaluation (percent error and runtime analysis)

Finally, the simulation is developed and tuned. The simulation tool estimates the conformity rates associated with the tolerance intervals. It provides an accurate prediction tool; however, it

requires an expensive calculation time (see **Figure 19**). Therefore, a surrogate model is proposed in the next section to improve the computing time efficiency while maintaining the simulation accuracy.

### II.3.2. Initial sampling and experimental design

In the previous section, the simulation characterized the gear meshing behavior and evaluates the KTE value then estimates the number of defective gears per million associated with the input tolerance variables. Afterward, in this section, an experiment space is designed using several techniques to define adequate experiments in the domain of tolerance variables. The experiments are designed using the Scikit-optimize Python package (Head *et al.*, 2020). Random, Latin Hypercube Sampling (LHS), Hammersley, and Halton are implemented. The experimental space for 1000 experiments is illustrated in **Figure 20**. Following the results of the practice on the small experiment, the Hammersley technique provided well-distributed and homogenous experimental tolerance inputs.

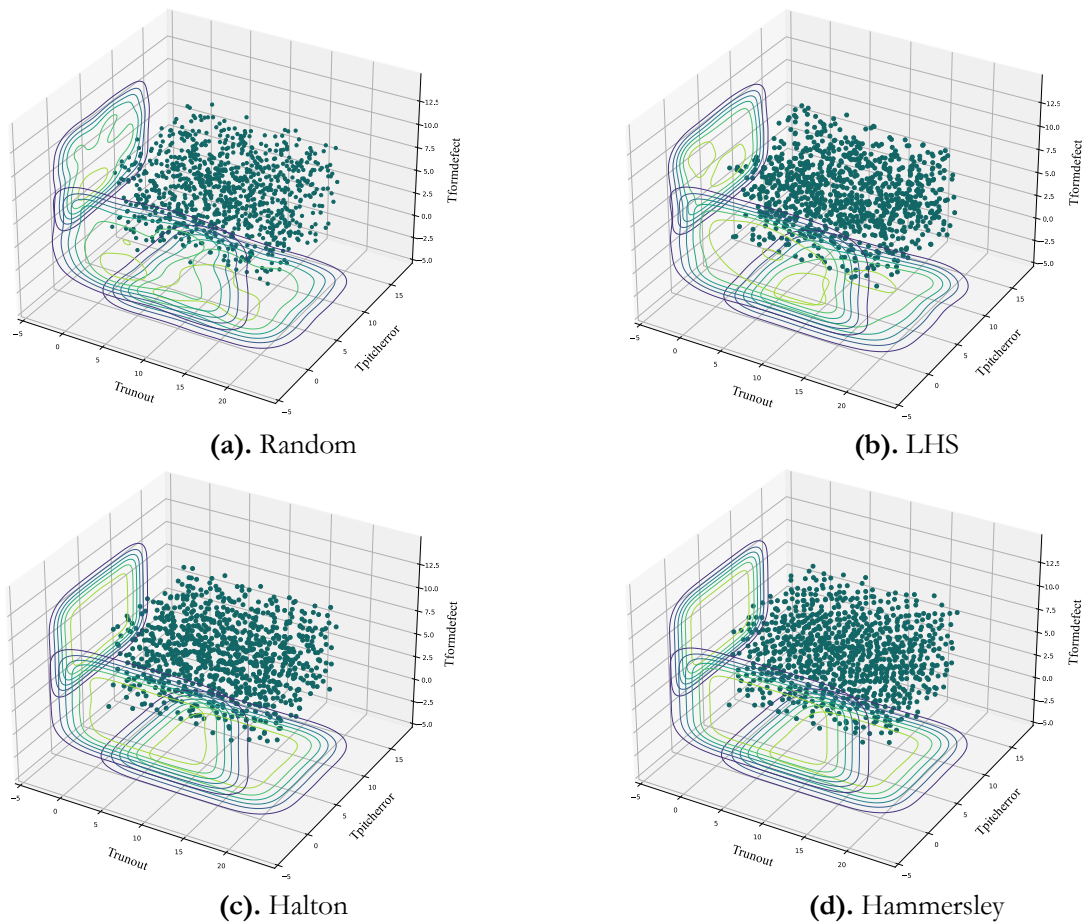
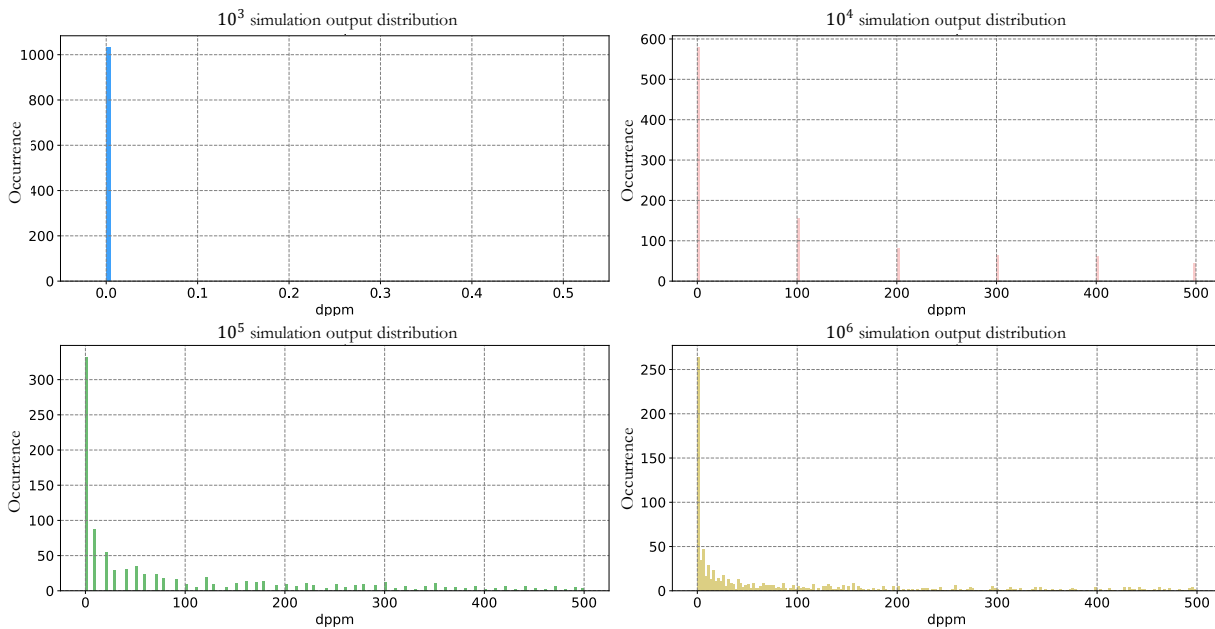

**Figure 20.** Employed design of experiment methods for a small experience batch

In this thesis, an internal computational resource with the following specification is utilized for a larger design of the experiment: 48 cores, 192 GB RAM, Intel Xeon Gold 5220R (2,2GHz). Following internal policies and resource availability, the largest empirical design of experiment size could yield is 40,000 points (tolerance variables). **Table 6** represents the calculation time and the detected defectives for a variety of simulation runs for a population of 40,000 (tolerance variables).

**Table 6.** Simulation time and accuracy comparison for a population of 40,000

	$10^3$ simulation	$10^4$ simulation	$10^5$ simulation	$10^6$ simulation
Number of detected defectives (out of 500)	1	6	51	359
Simulation time (hrs)	0.3	2.2	21.8	221.6

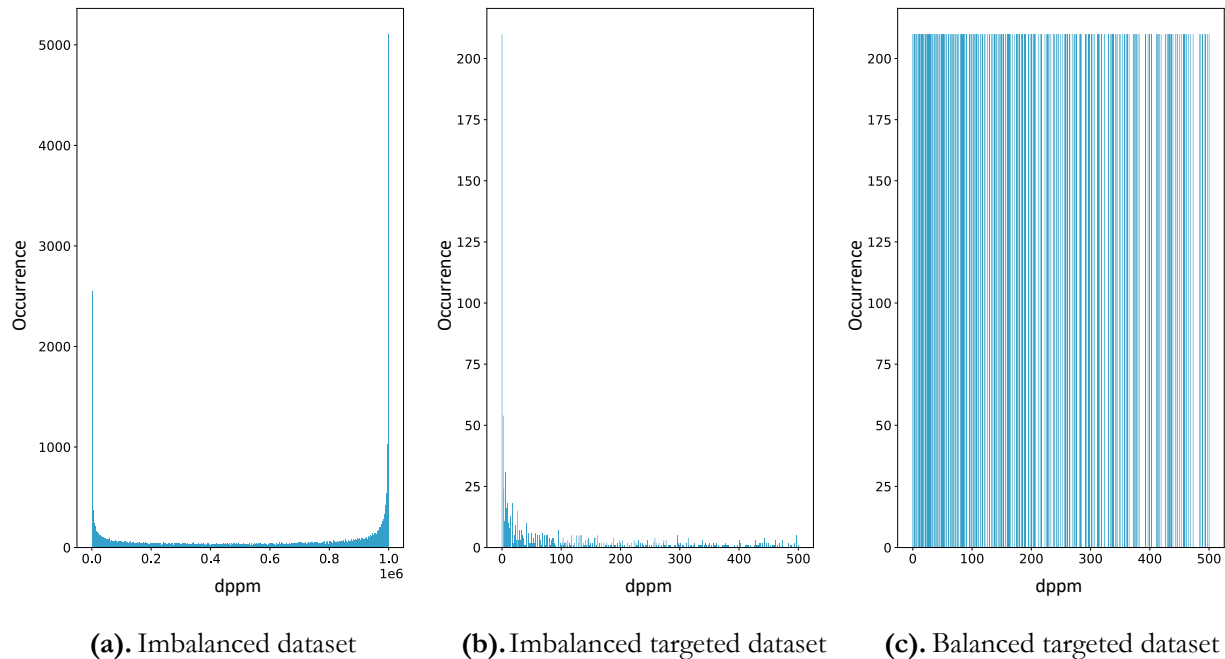

**Figure 21.** Target value occurrence frequency associated with a variety run number of simulations

Moreover, **Figure 21** demonstrates the number of defective parts per million (dppm) occurrence frequency for different simulations. Since, the simulation model predicts dppm as discrete output variables, therefore, the target sets are counted as classes. As is shown, the configuration of  $10^6$  million simulation runs and 40,000 experiments provided an adequate amount of target sets that cover the target range homogeneously. A skewed dataset is an eminent issue that emerged once analyzing the results which be handled in the next section.

### II.3.3. Imbalanced data refining and surrogate modeling

The designed experiments (i.e. tolerance variables) in the previous section provided well-distributed tolerance points in the tolerance domains; however, once the points are employed in the simulation the target (dppm) would fluctuate within no defective (0 dppm) and all defective ( $10^6$  dppm) range (**Figure 22(a)**). The empirical data has shown that the target fluctuated in the range of 0 to 500 dppm. Therefore, the data needed to be refined, and the off-grid points had to be excluded. At this point, the appropriate target range and associated input tolerances are collected. The initial study of the refined and collected target values demonstrates the tendency of the process toward having no defectives (**Figure 22(b)**). This tendency causes a vital influence in the surrogate model training step and triggers an inaccurate model (this is discussed in section II.2.4). Generally, sampling approaches are proposed to lessen the impact of imbalanced data. They are broadly divided into two categories — under-sampling and over-sampling. Under-sampling techniques are known to provide a compact balanced training set, on the other hand, over-sampling methods duplicate the rare classes at a specific rate (Fernández *et al.*, 2018). Since some targets (classes) were experienced once during the experiment, the over-sampling method is employed. In **Figure 22(c)**, the over-sampled balanced data set is shown.

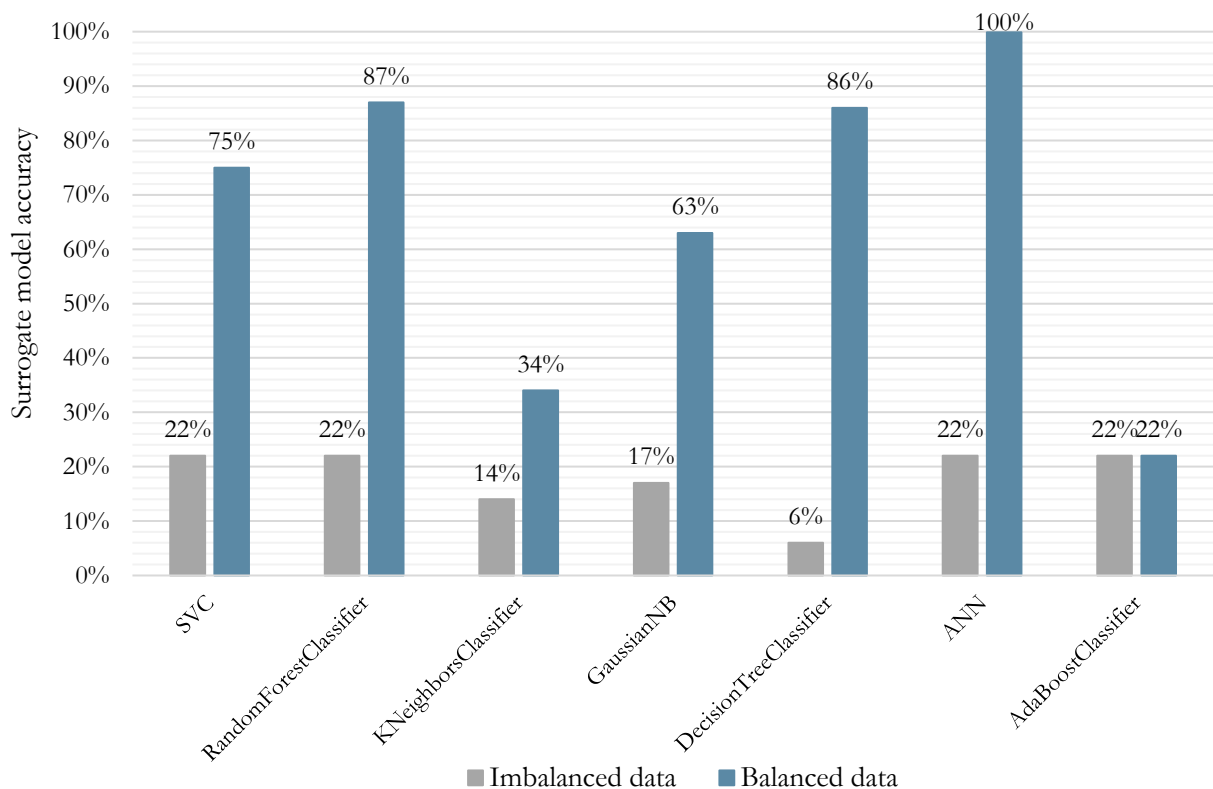

**Figure 22.** Dataset training illustration

Consequently, the new dataset is considered, and the surrogate modeling can be triggered.

### II.3.4. Surrogate model

Once the target output is identified and refined (**Figure 22**), training an efficient surrogate model can be carried out. The target represents the number of defective parts per million (dppm), therefore, the given data points are discrete values that can be identified as classes. The surrogate model predicts the number of defective (dppm) functions of the input tolerance variables ( $T$ ). In literature, a variety of classifiers is proposed. In this section, a comprehensive comparison is provided comparing imbalanced and balanced datasets using variant classifiers. The following classifiers implemented using Scikit-learn (Pedregosa *et al.*, 2011) and Keras (Chollet, 2015) Python package files: Support Vector Classifier (SVC)(Platt, 1999), Random forest (Ho, 1998), K-nearest neighbors (Goldberger *et al.*, 2004), Gaussian Naive Bayes (GaussianNB)(John & Langley, 1995), Decision tree (Breiman *et al.*, 2017), Artificial neural networks (ANNs)(Hinton *et al.*, 2006), and Ada boost (Freund & Schapire, 1997). The comparison of the implemented models on the imbalanced and balanced dataset is depicted in **Figure 23** using `accuracy_score` which returns the number of matches between the actual and predicted values (VanderPlas, 2016).



**Figure 23.** Comparison of imbalanced and balanced trained surrogate models

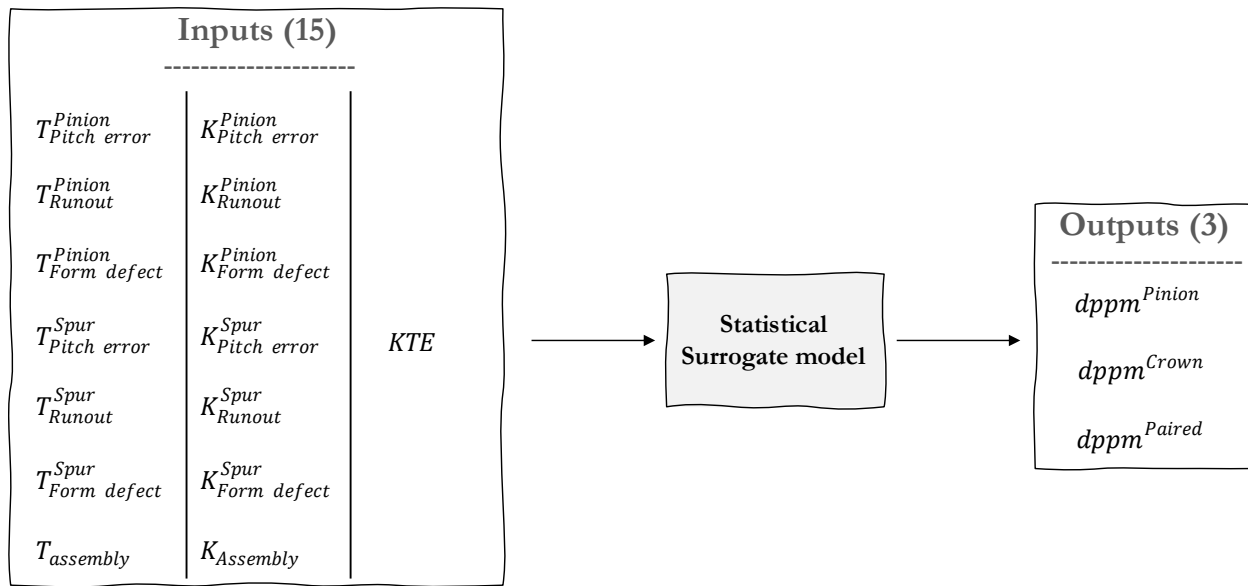

**Figure 24.** Surrogate model inputs and outputs

Accordingly, the artificial neural network led to a high-accuracy approximation surrogate, and the model representation is illustrated in **Figure 24**. Afterward, once the surrogate model is established, it can be deployed into the cost-tolerance optimization model (Chapter III) which aims at allocating cost-efficient tolerances.

## II.4. Conclusion

In this chapter, the application of numerical simulation and probabilistic approaches to different case studies is analyzed. A simple engineering design such as overrunning clutch can be modeled in 1D. Since the design's KCs are limited and independent, a simulation tool such as Monte-Carlo fits the design, evaluating the functional response time efficiently. The change in the 1D engineering design to a 3D electric motor which possesses more geometric errors, including rotational and translational errors, demonstrates the importance of an inexpensive approach to the study of the design. Therefore, a physics-based surrogate model is proposed to improve the calculation while maintaining the accuracy of the prediction. More exclusively, this thesis is dedicated to the examination of complex assembly mechanisms that include multiple types of geometric errors such as rotational, translational, and dimensional. In fact, the complexity of an assembly can be realized through the variety of errors and existing dependencies among the errors.

Therefore, analyzing the functional behavior of a complex mechanical assembly associated with the impacts of errors in the design is expensive and time-consuming which entails developing a novel and time-efficient approach. The necessity of an innovative approach shapes the prerequisite of this chapter to the application of machine learning techniques. In this regard, the examination of the micro gears with numerous geometric errors and dependencies directed the research to employ Artificial Intelligence (AI) in tolerance analysis.

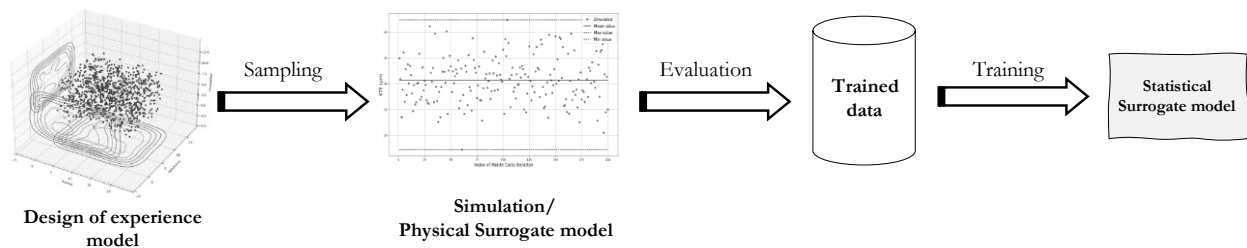

**Figure 25.** Statistical surrogate model process

**Figure 25** demonstrates the outlines of this section. The process initiates with a simulation/physical surrogate model and an appropriate design of experiments model which covers homogeneously the tolerance search area. Afterward, the yielded experiments required to be trained and refined in the scope of the empirical experiments. Finally, a prediction approach can be adapted to train the surrogate model. The application of AI promises a high-accuracy approximation of assembly precision prediction. Afterward, the tolerance analysis approaches are integrated into the tolerance allocation optimization to investigate optimal tolerance while satisfying the functional requirements of the design. In the next chapter, proposing a novel and modular model for the integration of the tolerance analysis technique into cost-tolerance optimization is explored.

## Chapter III: Integrating and optimizing production strategies in tolerance allocation

---

**T**olerance allocation is the process of determining the acceptable level of deviation from a nominal value for each dimension or feature of a product. Production strategies (e.g., practical resource allocation, reworking, and assembly) can be integrated and optimized by considering the tolerances of each dimension and feature when designing the production process. This can help to minimize associated costs and improve efficiency by ensuring that the production process can assemble components that meet the required functionality. Therefore, the need for a comprehensive tool to provide an optimal solution that satisfies design requirements as well as the production process is a necessity.

---



## **Table of Contents**

III.1. Activity-based cost-tolerance realization.....	81
III.2. Proposed cost-tolerance model adaptation and applications.....	84
III.2.1. Simulation-assisted tolerance optimization of the overrunning clutch.....	84
III.2.2. Physical behavior surrogate-assisted tolerance optimization of electric motor mechanism tolerancing.....	87
III.2.3. Statistical surrogate-assisted tolerance optimization of micro gear designs.....	93
III.3. Conclusion.....	96

### III.1. Activity-based cost-tolerance realization

In this section, a modular cost model is proposed which estimates the product's final cost involving activities and production strategies (see **Figure 26**). The activities include processing, inspection, scraping, and warranty, respectively, and the production strategies are defined as follows:

- 1) Resource allocation is purposed to assign available practical resources to components to increase manufacturing line efficiency.
- 2) A reworking decision is a decision to improve the components' conformity rate and decrease the number of scraps as well as the total manufacturing cost.
- 3) Assembly strategy selection is a decision to improve the assembly product conformity rate

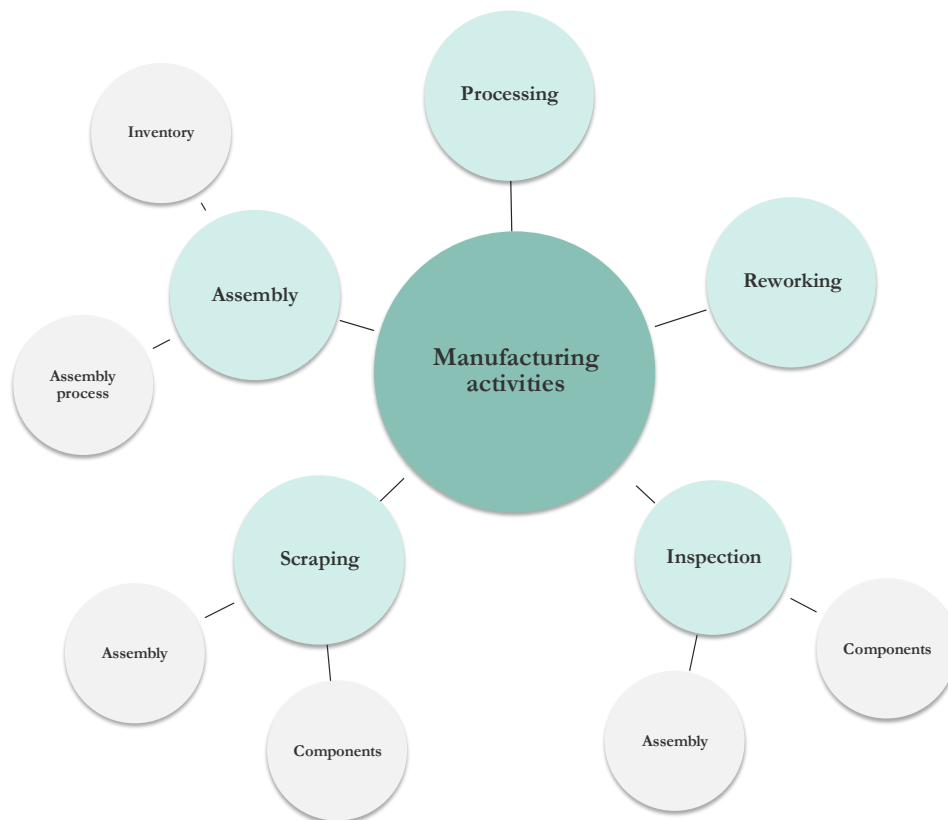

**Figure 26.** Manufacturing activities

The model leads us to study the economic impact of allocated tolerance ( $t$ ) and production strategies. In this model, contrary to the cost-tolerance models in the literature, the activities are weighted by the efficiency of the related activities which are correlated to the conformity ratio of the assembly ( $\lambda$ ) and components ( $\gamma$ ). In Chapter II, several techniques were proposed and compared to

assess the conformity ratios. Therefore, in this part, a cost-tolerance model is proposed to associate the conformities to the cost.

---

Parameters:

---

$N$	Set of components
$C_d$	Set of design constraints
$C_f$	Set of functional constraints
$C_r$	Set of reworking constraints
$R$	Set of available resources
$N_d$	Number of design constraints on characteristics
$N_f$	Number of functional constraints
$NC_i$	Number of characteristics on component $i$
$\sigma_i$	Process deviation for component $i$

---

Decision variables:

---

$t_{ij}$	Allocated tolerance to component $i$ and characteristic $j$
$a_{i,r}$	Allocated resource $r$ to component $i$
$\gamma'_i$	Component $i$ conformity rate after reworking
$\lambda$	Assembly conformity rate
$C_{Total}$	Manufacturing cost

---

The assembly and the components' conformity ratios depend on the allocated tolerances and selected strategies. Consequently, to examine the manufacturing cost, a statistical model is proposed where activities' costs are constant and deemed to be the average cost of the activity, however, activities' weights are associated with the allocated tolerances (Khezri *et al.*, 2023a). An abstraction of the cost-tolerance model is expressed in eq.(10).

$$\begin{aligned}
 & \text{Min } Cost_{Total}(t, a, s) \\
 & \text{Subject to,} \\
 & \sum_{r \in R} a_{i,r} = 1 \\
 & t \in [Tolerance\ domain] \\
 & s \in \{Production\ strategies\} \\
 & \gamma_i \geq \text{Quality rate requirement} \\
 & \lambda \geq \text{Quality rate requirement}
 \end{aligned}
 \tag{10}$$

$, \forall i \in N$

Furthermore, the associated ratios and cost model structure are detailed as follows:

- Inspection uncertainties, inclusively, affect the component conformity rate and assembly conformity rate. Therefore, two common failures are included: Type I and Type II. Type I failure rate ( $\alpha$ ) happens once the process is conformed, however, the inspection rejects it; And, Type II failure rate ( $\beta$ ) occurs when a non-conformed process returns as a confirmed process from the inspection. The following definitions explain comprehensively the probability terms employed.

$\gamma_i(1 - \alpha)$ :	Percentage of conformed components
$(1 - \gamma_i)\beta$ :	Percentage of non-conformed components
$\gamma_i\alpha$ :	Percentage of undetected non-conformed components
$(1 - \gamma_i)(1 - \beta)$ :	Percentage of detected non-conformed components
$\lambda(1 - \alpha)$ :	Percentage of marketable conformed assembly
$(1 - \lambda)\beta$ :	Percentage of marketable non-conformed assembly
$\lambda\alpha$ :	Percentage of undetected non-conformed assembly
$(1 - \lambda)(1 - \beta)$ :	Percentage of detected non-conformed assembly

- The  $Cost_{Total}(t)$  contains activities such as processing, inspection, scrap, and assembly.

$$Cost_{Total}(t) = Cost_{Processing} + Cost_{Inspection} + Cost_{Scrap} + Cost_{Rework} + Cost_{Assembly} \quad (11)$$

- Processing cost ( $Cost_{Processing}$ ) assesses processing cost for conformed components. It associates the parametric cost ( $C_{Proc}$ ) to the components' conformity ratio functions of the tolerances allocated on the components' characteristics.

$$Cost_{Processing} = \sum_{i \in N} \frac{C_{Proc i}}{\gamma'_i(1 - \alpha) + (1 - \gamma'_i)\beta} \quad (12)$$

- Reworking cost ( $Cost_{Reworking}$ ) determines the cost of reworking the components. This activity is deemed to be a production strategy; therefore, the decision variable  $rw$  is a binary variable where 1 indicates that reworking is performed and 0 means that reworking is not performed.

$$Cost_{Rework} = \sum_{i \in N} \frac{C_{Rework i} * rw}{\gamma'_i(1 - \alpha) + (1 - \gamma'_i)\beta} \quad (13)$$

- Assembly cost ( $Cost_{Assembly}$ ) calculates conformed assembly's cost.

$$Cost_{Assembly} = \frac{C_{Assembly}}{\lambda(1-\alpha) + (1-\lambda)\beta} \quad (14)$$

- Inspection cost ( $Cost_{Inspection}$ ) evaluates the inspection cost for the conformed components before assembly, as well as conformed assembly.

$$Cost_{Inspection} = \sum_{i \in N} \frac{C_{Inspection i}}{\gamma_i(1-\alpha) + (1-\gamma_i)\beta} + \frac{C_{Inspection}}{\lambda(1-\alpha) + (1-\lambda)\beta} \quad (15)$$

- Scrap cost ( $Cost_{Scrap}$ ) calculates the compensation associated with the non-conformed components and non-conformed assembly.

$$Cost_{Scrap} = \sum_{i \in N} \frac{C_{Scrap i}(\gamma_i'\alpha + (1-\gamma_i')(1-\beta))}{\gamma_i(1-\alpha) + (1-\gamma_i)\beta} + \frac{C_{Product Scrap}(\lambda\alpha + (1-\lambda)(1-\beta))}{\lambda(1-\alpha) + (1-\lambda)\beta} \quad (16)$$

Ultimately, the cost-tolerance model is detailed, and the dependencies are explained. The model is established by associating tolerancing impacts with the manufacturing cost. The impact of the allocated tolerances is assessed by a model evaluating the conformity rates. It is discussed in the next section.

### **III.2. Proposed cost-tolerance model adaptation and applications**

The proposed cost-tolerance model is an analytical tool, that assesses the assembly manufacturing cost associated with the manufacturing activities and the relevant impacts to obtain a conformed assembly. The modular structure of the proposed model enables the manufacturer to assess a wide range of assemblies. The applications of the model are analyzed in this section.

#### **III.2.1. Simulation-assisted tolerance optimization of the overrunning clutch**

##### *III.2.1.1 Application description and adapted approach*

In section II.2.1, a Monte-Carlo simulation approach is developed to predict assembly conformity functions of the tolerances on key characteristics and allocated resources (Khezri *et al.*, 2022b). Therefore, in this section, an adapted optimization model is proposed where the simulation approach and cost-tolerance model are integrated into one structure. In **Table 7**, associated costs, process deviations, and inspection errors are provided to model the manufacturing cost.

**Table 7.** Manufacturing data for the overrunning clutch

Components	Hub			Roller			Cage		
	R1	R2	R3	R1	R2	R3	R1	R2	R3
Resources									
Processing cost (cu)	5	7	9	3	2.5	2.95	2.95	3.15	4
Process deviation $\sigma_{ij}$ (mm)	0.566	0.133	0.100	0.166	0.300	0.208	0.208	0.133	0.09
Inspection cost (cu)	1			1.5			1		
Scrap cost (cu)	2			2			2		
Reworking cost (cu)	1			1			1		
Product assembly cost (cu)	3								
Product scrap cost (cu)	10								
Inspection cost (cu)	0.5								
<b>Note:</b> cu = Cost unit									

Afterward, to analyze the system behavior and estimate the manufacturing cost, a genetic algorithm is developed with the following tuning parameters : number of iterations = 1000, population size = 200, mutation probability = 0.04, crossover probability = 0.8, elite rate = 0.2. In **Figure 27**, the chromosome representation and crossover and mutation operators are illustrated.

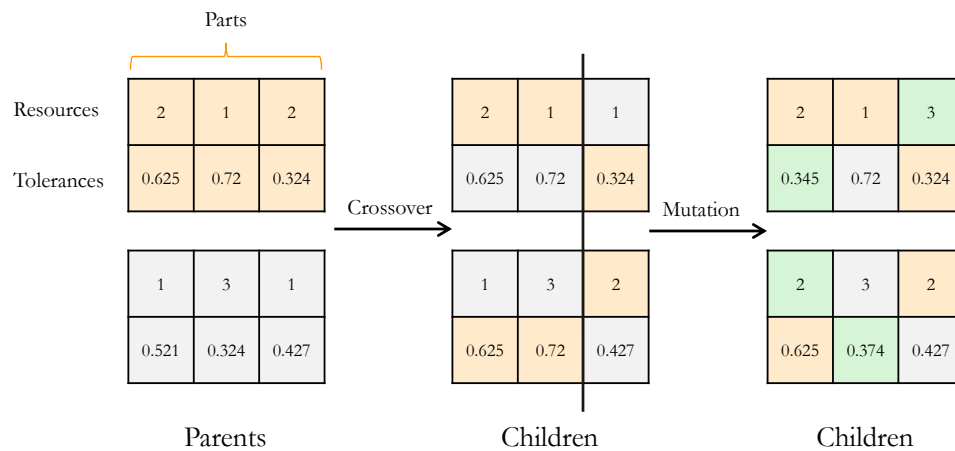
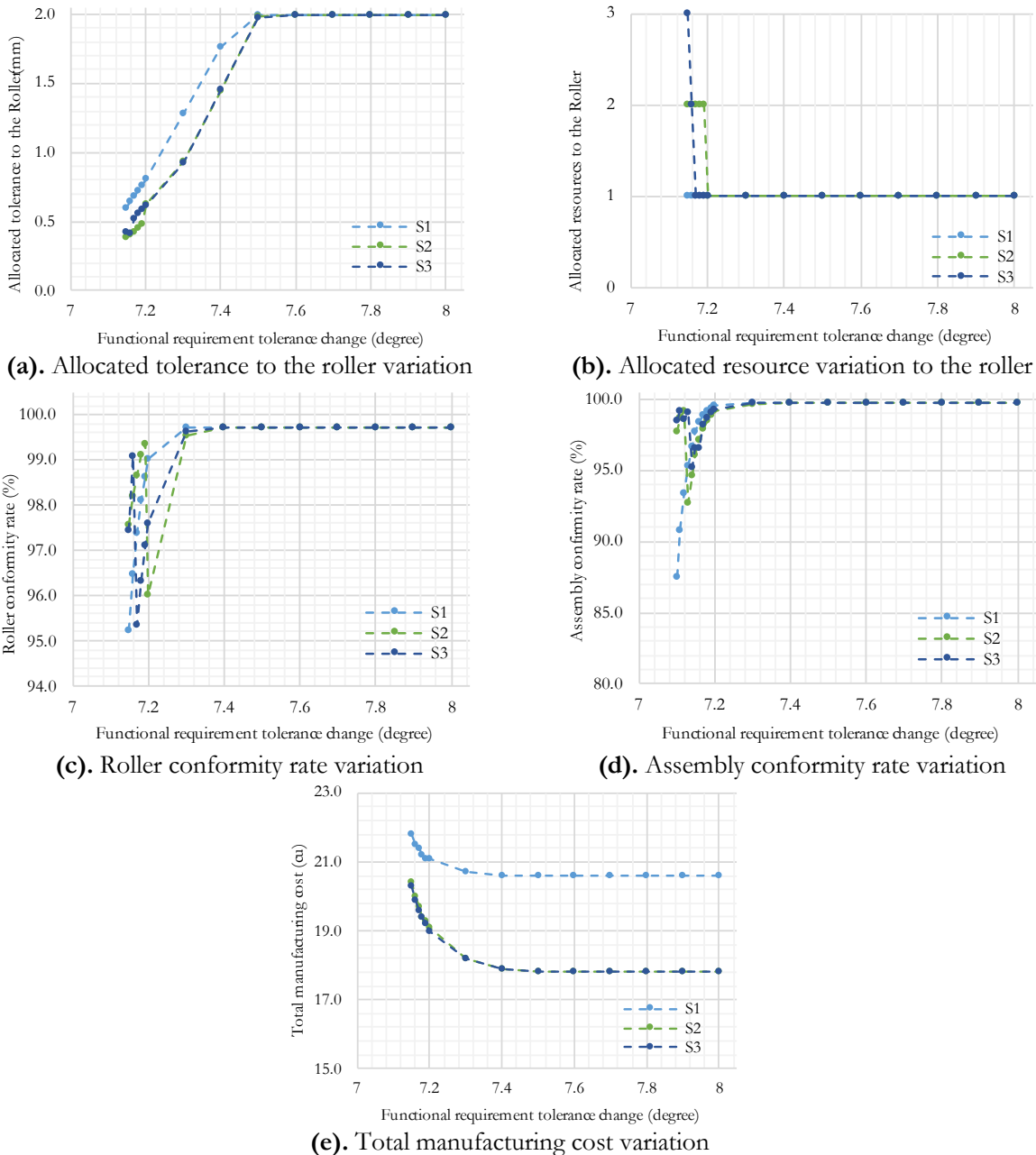

**Figure 27.** Genetic algorithm chromosome, crossover, and mutation presentations

A chromosome is structured in two sub-genes. The first sub-gene contains assigned resources' information to each component and the second sub-gene includes its allocated tolerances' information. Afterward, crossover and mutation operators are used to generate new children out of parents. Moreover, the associated cost value of each child will be evaluated and the best child in each iteration of the generation will be selected. In the end, the best child among all dominated children will be selected which contains the optimal tolerances and resources information to be allocated to each part.

III.2.1.2. Optimization analyses and discussions

In this section, a comprehensive result analysis is discussed. The analysis of the components regarding the tolerances allocated, the resources assigned, and the associated conformity rates are illustrated in **Figure 28**. The illustrated analysis concerns three scenarios: S1) Tolerance allocation only, S2) Tolerance and resource allocation, and S3) Scenario 2 including rework.



**Figure 28.** Optimization results related to the overrunning clutch

The study of different scenarios on the roller allocated tolerances and resources, besides associated conformity rates, depicts their impacts. Hence, scenario 2 integrates the resource allocation problem: the analysis illustrates the system behavior which leans toward allocating practical systems to yield a higher conformity rate. Within scenario 3, the reworking strategy was included, and the consequence can be found in the improvement in the conformity rate. The analysis of scenarios on the assembly can also be realized in **Figure 28(d)**. The application of simulation enables designers to locate the critical assembly tolerance range which is in the range of Practical Limit (PL) and 0.5 degrees. In this range, the deployment of different scenarios helps the manufacturing system to improve the assembly conformity rate and reduces the manufacturing cost.

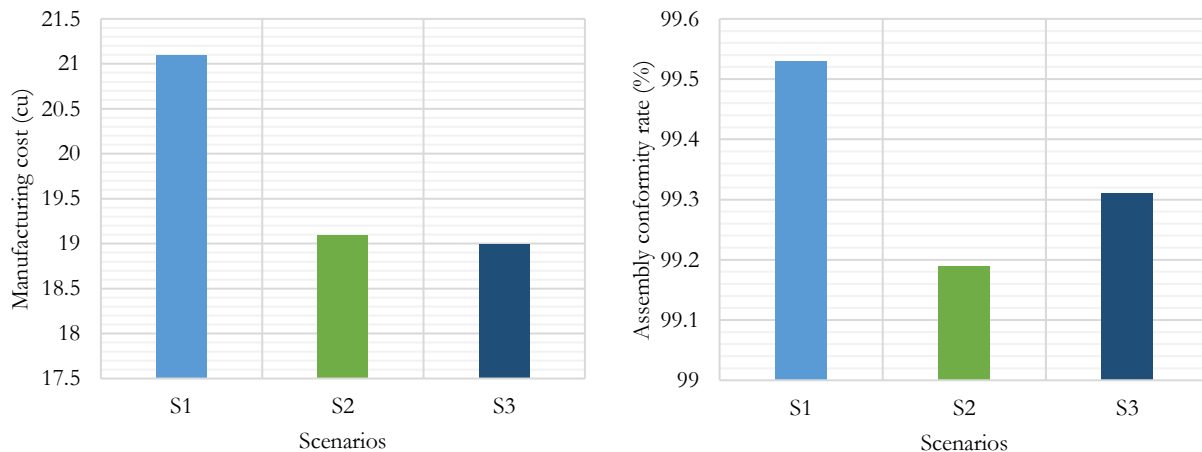

(a). Total manufacturing cost variation associated with different scenarios

(b). Assembly conformity rate variation associated with different scenarios

**Figure 29.** Precise assembly ( $t_y = 0.3$ ) cost and conformity analyses

As aforementioned, simulation was proposed to locate the critical tolerance range in the case study. To this fact, the analyses of a tighter functional requirement tolerance for instance  $t_y = 0.3$  are depicted in **Figure 29**. From the results, it can be deduced integrating resource allocation and reworking for more precise design can improve end-product quality as well as manufacturing cost.

### III.2.2. Physical behavior surrogate-assisted tolerance optimization of electric motor mechanism tolerancing

#### III.2.2.1. Application description and adapted approach

In this section, the over-constrained electric motor is examined. The application of the cost-tolerance optimization model is being studied using the tolerance analysis procedure developed in



section II.2.2. In this mechanical design, appropriate tolerances that are associated with features F11, F12, F13, F21, F22, F31, F32, and F33 are required to be allocated with the given design ( $C_d$ ), rework ( $C_r$ ), and functional ( $C_f$ ) constraints. These constraints prevent surfaces from inadvertent interferences by concerning designated gaps between surfaces and limits exceeding practical value. Subsequently, the set of equations is substituted for a surrogate model to improve the calculation time performance. The manufacturing data and nominal design values are noted in **Table 9** and **Table 8**.

**Table 8.** Nominal designs values on dimensions

Dimension	D11	D12	D13	D21	D22	D31	D32	D33
Nominal value $\mu_D$ (mm)	100	60	130	60	129.96	59.9	59.9	99.8

**Table 9.** Manufacturing data for the electric motor

Components	House			Body			Shaft		
	M11	M12	M13	M21	M22	M23	M31	M32	M33
Resources									
Processing cost (cost unit (cu))	5	8	10	3	2.5	2.95	2.95	3.15	4
Resource deviation (mm)	0.05	0.013	0.01	0.016	0.03	0.021	0.021	0.013	0.01
Inspection cost (cu)	1			1.5			1		
Scrap cost (cu)	0.5			0.5			0.5		
Reworking cost (cu)	1			1			1		
Product assembly cost (cu)	3								
Product scrap cost (cu)	10								
Inspection cost (cu)	0.5								

In this section, the tolerance analysis approach described in the previous chapter is integrated into a cost-optimization model. Through the use of optimization and surrogate approaches, the model is able to determine the optimal tolerances correlated to the Key Characteristics (KCs) of the components. A surrogate-assisted optimization approach is utilized, as illustrated in **Figure 30**. The approach involves defining the geometry design constraints, statistical relations, and function to be assessed. Tolerances and resource deviations are then introduced over the KCs and analyzed through the surrogate model, which evaluates the system's behavior. The Genetic Algorithm (GA) is used to obtain the optimal solution with the least cost. The algorithm is tuned with the following parameters (Khezri *et al.*, 2023a): number of iterations = 1200, population size = 150, mutation probability = 0.04, crossover probability = 0.5, elite rate = 0.01. Moreover, the main contribution of this work is to integrate the reworking and resource allocation decisions into tolerance allocation improving parts conformity rates. The chromosome developed in this algorithm is structured into two sub-genes.

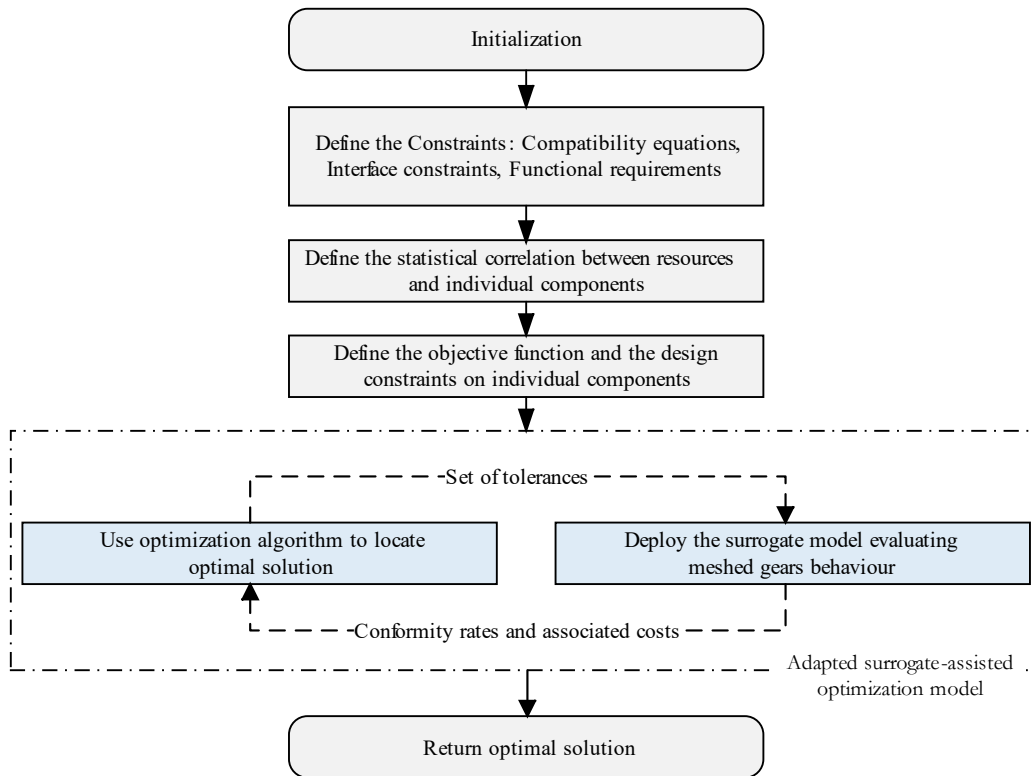

Figure 30. Adapted optimization approach

The first sub-gene contains assigned resources' information to each component and the second sub-gene includes allocated tolerances' information, accordingly (Figure 31).

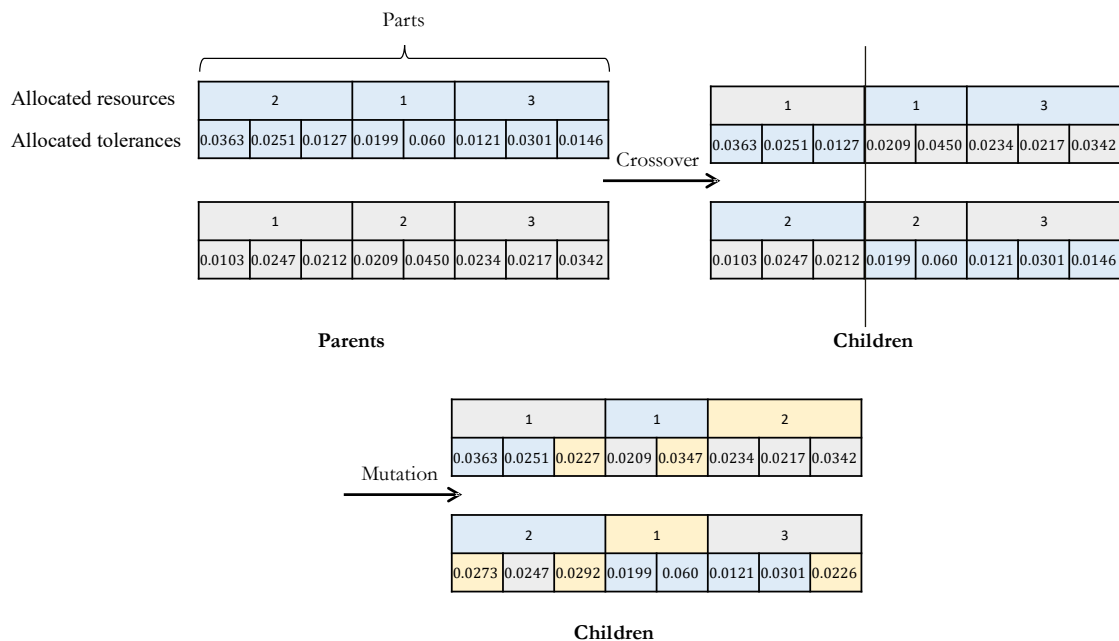

Figure 31. Genetic algorithm chromosome, crossover, and mutation presentations

III.2.2.2. Optimization analyses and discussions

In this section, to have a better comprehension of the problem, four different scenarios are intended. The first scenario (S1) takes available precise resources for each component to be processed. The second scenario (S2) takes available precise resources and applies reworking on components if it is required. The third scenario (S3) allocates optimal resources among available resources to each part. Lastly, the fourth scenario (S4) applies resource allocation and reworking for each component to be processed. Consequently, a comparison of resulted allocated tolerances to the house's main characteristics, allocated resources, cost, and conformity rates over iterated iterations for each scenario is illustrated in **Figure 32** and **Figure 33**. Moreover, allocated optimal resources and tolerances to each component and correlated design dimensions are detailed in **Table 10**.

**Table 10.** Optimally allocated tolerances and resources

	$t_{F11}$	$t_{F12}$	$t_{F13}$	$t_{F21}$	$t_{F22}$	$t_{F31}$	$t_{F32}$	$t_{F33}$	House	Body	Shaft
S1	$\pm 0.027$	$\pm 0.030$	$\pm 0.030$	$\pm 0.030$	$\pm 0.050$	$\pm 0.020$	$\pm 0.020$	$\pm 0.023$	M13	M21	M33
S2	$\pm 0.026$	$\pm 0.031$	$\pm 0.029$	$\pm 0.031$	$\pm 0.051$	$\pm 0.019$	$\pm 0.019$	$\pm 0.024$	M13	M21	M33
S3	$\pm 0.020$	$\pm 0.031$	$\pm 0.033$	$\pm 0.032$	$\pm 0.047$	$\pm 0.018$	$\pm 0.018$	$\pm 0.030$	M12	M21	M32
S4	$\pm 0.024$	$\pm 0.029$	$\pm 0.035$	$\pm 0.030$	$\pm 0.044$	$\pm 0.020$	$\pm 0.020$	$\pm 0.026$	M12	M21	M32

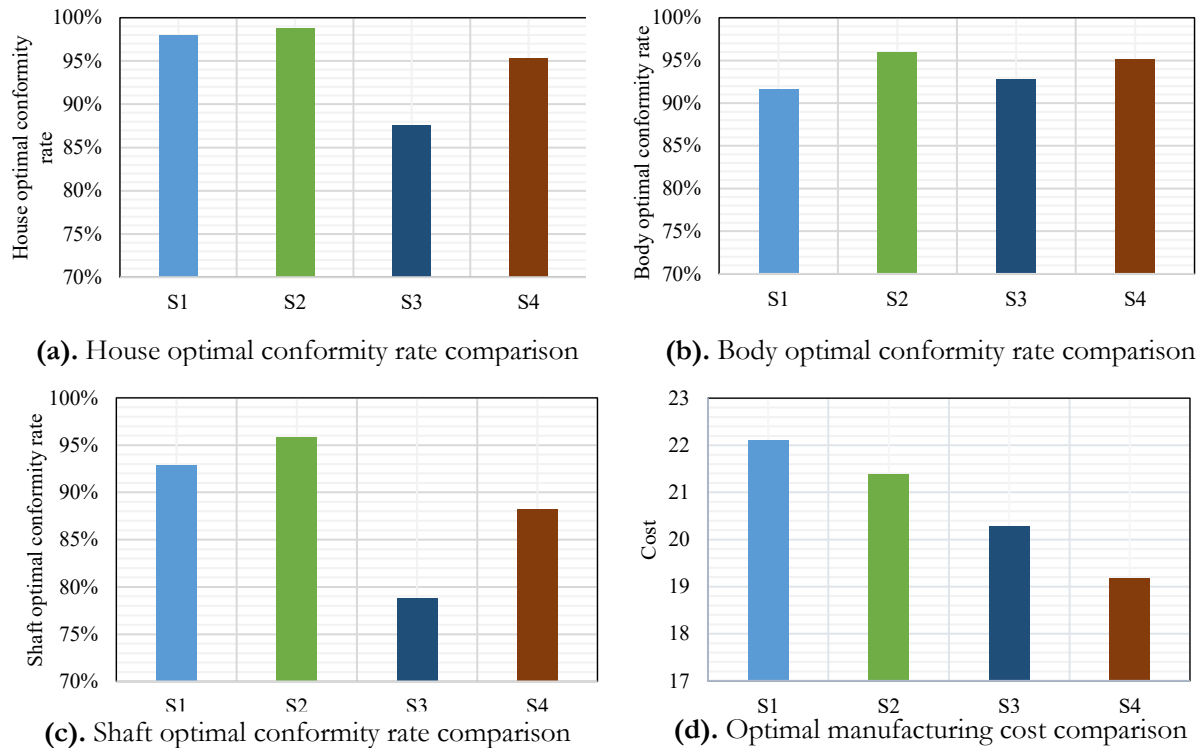

**Figure 32.** Optimal cost and components conformity rates associated with each scenario

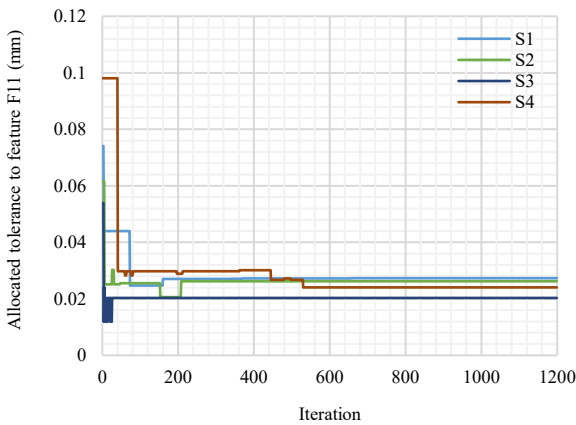

(a) Convergence of GA for the allocated tolerance to feature F11

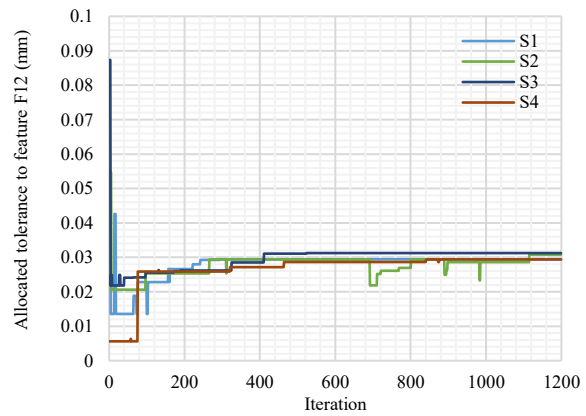

(b) Convergence of GA for the allocated tolerance to feature F12

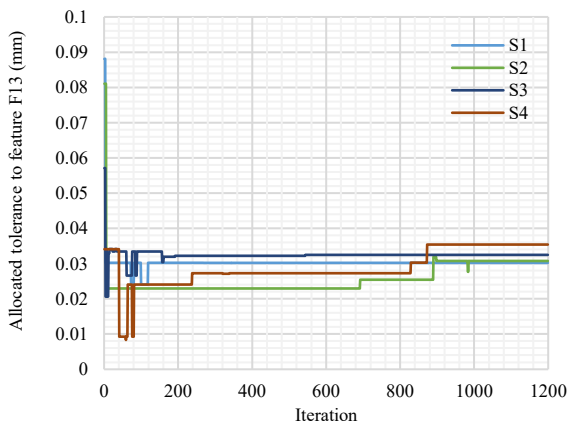

(c) Convergence of GA for the allocated tolerance to feature F13

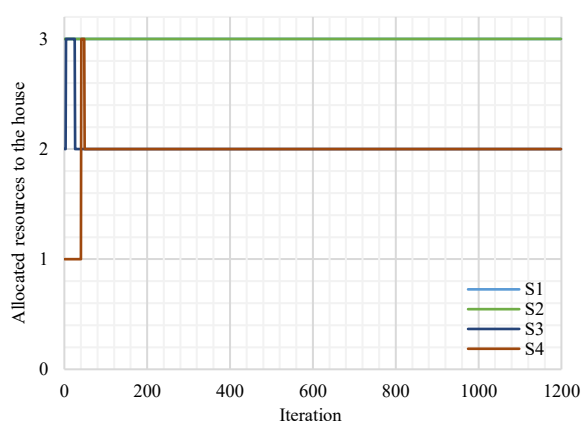

(d) Convergence of GA for the allocated resources to the house

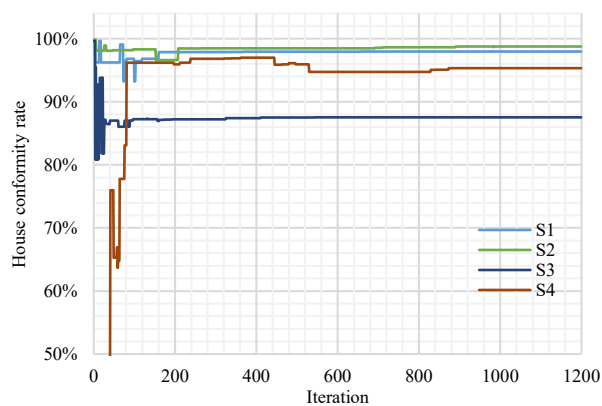

(e) Convergence of GA for the house conformity rate

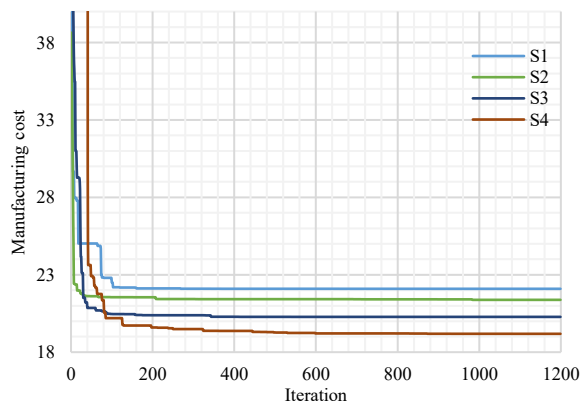

(f) Convergence of GA for the manufacturing cost

**Figure 33.** Genetic algorithm optimization results

The study of cost and conformity rates associated with different scenarios illustrates the impacts of resource allocation and reworking decisions. On one hand, it can be determined that applying resource allocation using available machine tools impacts associated cost decreasing the cost value. Tentatively, it influences the conformity rates due to imprecise allocated resources. On the other hand, the rework decision is applied to cover up the drop-in conformity rates caused due to resources' imprecision and improve conformity rates (**Figure 32** and **Figure 33**). Successively, the tolerances allocated on dimensions are influenced by the decisions, which resource to be assigned to the part, and whether reworking is necessary or not, the tolerances adapt, accordingly (**Table 10**).

So far, the minimal manufacturing cost associated with each scenario is located and the optimal tolerances and resources are allocated. Subsequently, allocated resource deviations and tolerances feed into the tolerance analysis approach estimating assembly functionality conformity rate and associated assembly cost. In this section, the simulation-assisted and the surrogate-assisted approaches were detailed. Consequently, the application of the simulation and the surrogate model estimate assembly functionality conformity rate. Appropriately, the assembly cost is calculated, the minimal manufacturing cost is summed up and the total manufacturing cost is achieved. A comparison of the two models is detailed in **Table 11**.

**Table 11.** Simulation and surrogate models obtained cost assembly, and functionality rates relate to each scenario

	Simulation-assisted optimization			Surrogate-assisted optimization		
	$\lambda$	$Cost_{Total}$ (cu)	Computing time	$\lambda$	$Cost_{Total}$ (cu)	Computing time
S1	97.44%	25.83	1 hr 18 min 17 sec	98.35%	25.84	5 min 5 sec
S2	97.44%	25.17	1 hr 12 min 56 sec	98.36%	25.11	5 min 33 sec
S3	95.54%	24.28	1 hr 10 min 48 sec	95.90%	24.23	4 min 55 sec
S4	95.54%	23.26	1 hr 10 min 45 sec	95.88%	23.35	5 min 8 sec

Ultimately, the implementation of surrogate-assisted cost tolerance optimization was demonstrated in this section. The integration of tolerance allocation taking into account available machine tools process deviations and the application of reworking to enhance component conformity rate were analyzed. Following the results achieved, resource allocation lesser manufacturing cost, however, it influences on component conformity rate. Therefore, rework is a practical decision to

---

enhance the conformity of the component. Moreover, the simulation deploys verifying allocated tolerances and resource viability estimating assembly and assembly functionality conformity rates.

### III.2.3. Statistical surrogate-assisted tolerance optimization for micro gear designs

#### III.2.3.1. Application description and adapted approach

This section proposes an embedded surrogate model cost-tolerance optimization approach (Khezri *et al.*, 2023b). The development initiates gathering onsite data which is measured by highly precise measurement tools and expert operators. Since data gathering consumes time due to the micro gear's geometric complexity, a mathematical and data-based simulation tool is alternatively proposed. While the simulation tool can offer valuable insights into calculating the KTE value and identifying the number of defectives in the gears meshing behavior, it can be too time-consuming to be incorporated directly into the optimization model. As a result, a series of experiments is conducted using the simulation tool, and the data is collected. Various classifiers are then trained to anticipate the behavior of the assembled system based on this data. The outcome of this process is an efficient surrogate model, which predicts the number of defective functions of tolerance variables. This surrogate model is then integrated into an optimization approach that allocates cost-effective tolerances.

#### III.2.3.2. Surrogate-assisted optimization approach

In this section, the proposed surrogate model is embedded into the cost-optimization model developed. Thereby, the optimization and previous surrogate approaches enable finding optimal tolerances correlated to the KCs of the gears. The implemented surrogate-assisted optimization is illustrated in **Figure 30**. The model initiates with the definition of the geometry design constraints, statistical relations, and objective function. Afterward, the tolerances are introduced over the KCs and are analyzed thanks to the surrogate model estimating the system's behavior. In order to obtain optimal tolerances the GA and a Self-adaptive Differential Evolution (SaDE) are implemented. SaDE is a population-based stochastic search technique (Qin & Suganthan, 2005). It is an improved version of the Differential Evolution (DE) and is instructed by executing mutation, crossover, and selection operators. The original DE algorithms perform five various learning strategies to yield the optimal solution and various control parameters such as *Itr*, *Pop*, *P<sub>c</sub>*, etc. On the other hand, SaDE uses two out of five learning strategies and does not require pre-specified control parameters (Brest *et al.*, 2007).

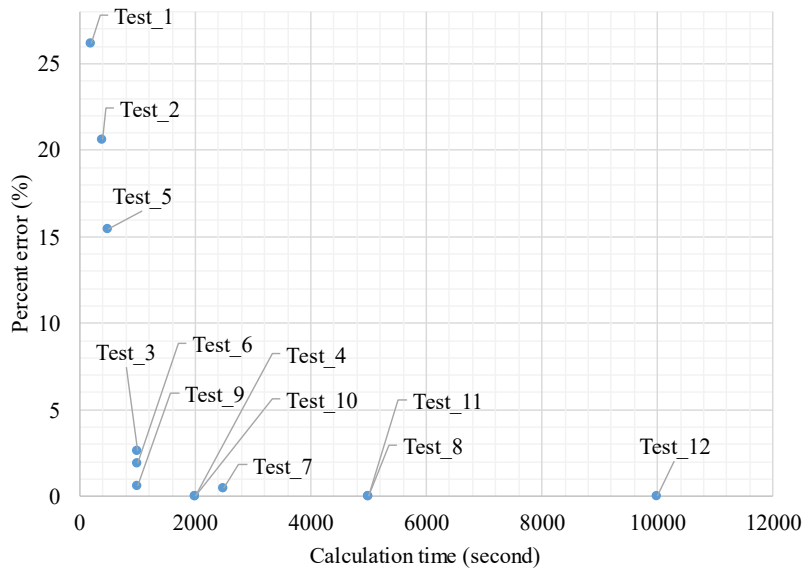

**Figure 34.** SaDE algorithm tuning parameters evaluation

**Table 12.** Optimization test sets

	Test_1	Test_2	Test_3	Test_4	Test_5	Test_6	Test_7	Test_8	Test_9	Test_10	Test_11	Test_12
<i>Itr</i>	100	200	500	1000	100	200	500	1000	100	200	500	1000
<i>Pop</i>	20	20	20	20	50	50	50	50	100	100	100	100

In this regard, several tests are designed and applied to assure global optimal solutions in an efficient time. The test sets and evaluated results are demonstrated in **Table 12** and **Figure 34**, respectively. Consequently, the optimization approach is tuned considering Test\_10 with  $Itr = 200$  and  $Pop = 100$ , and optimization analysis is carried out in the following section.

### *III.2.3.3. Optimization analysis and discussions*

The application of the optimization approach and the following results are analyzed in this section. The functional behavior of assembled gears and their functionality can be realized through the KTE value, which is considered as a monitoring and target value for quality level assessment; Moreover, the responses of the design and functionality constraints associated with the allocated tolerances have to fall in the control level predefined. Therefore, the sensitivity of the approach is studied with various KTE values where a higher KTE value implies a lower quality level.

**Figure 35** illustrates the correlation between the KTE value and the manufacturing cost. While the designer seeks to enhance assembled functionality by reducing the KTE value, tolerances

are getting tighter (**Figure 35(e)**). As a result, the manufacturing section is being imposed providing tighter and more precise components. Therefore, the higher the quality, the higher the manufacturing cost (**Figure 35(a)**). **Figure 35(a)** illustrates the relative change in cost referenced to the minimum manufacturing cost associated with a KTE value equals to 28 ( $\mu\text{m}$ ). In this case, SaDE provides efficient optimal solution in compared to GA. Moreover, in section 3.2, the correlation between the allocated tolerances and the number of defective components per million has been discussed. Consequently, **Figure 35(b) - Figure 35(d)** demonstrate the associated results. In this study, the crown wheel possesses a complex design with strict boundaries and slighter dimensions that are required to be controlled.

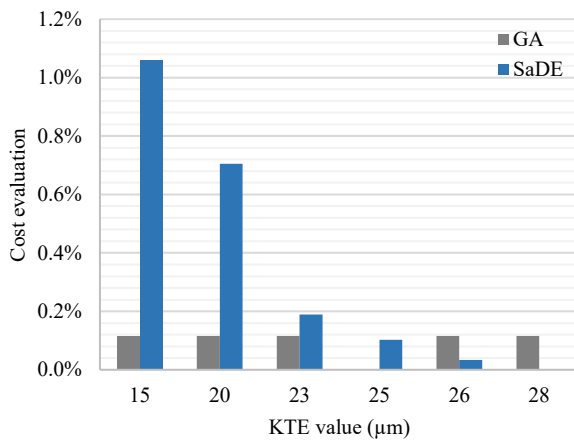

(a). Manufacturing cost evaluation

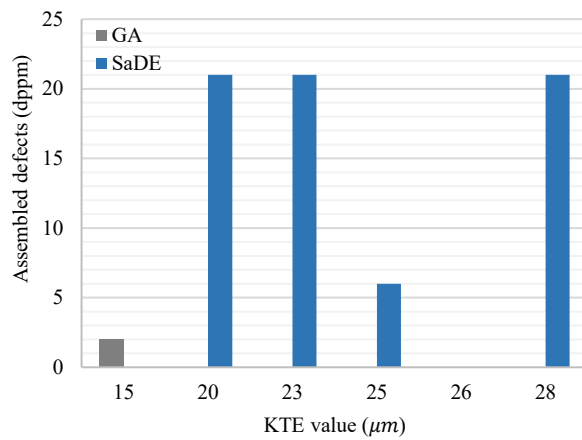

(b). Number of assembled defective evaluation

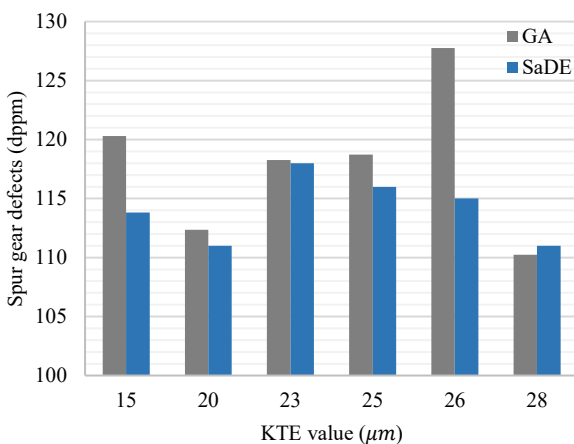

(c). Number of spur gear defective evaluation

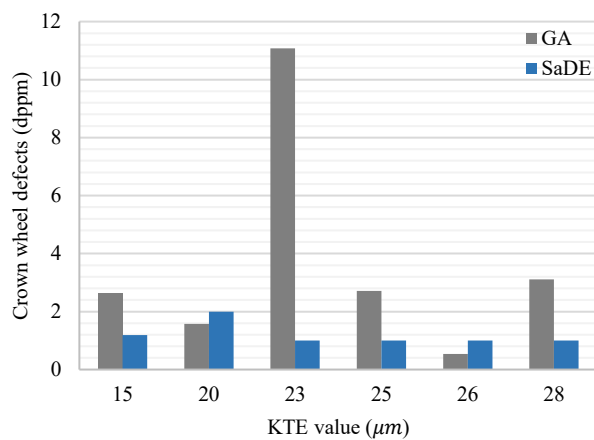

(d). Crown wheel number of defective evaluation



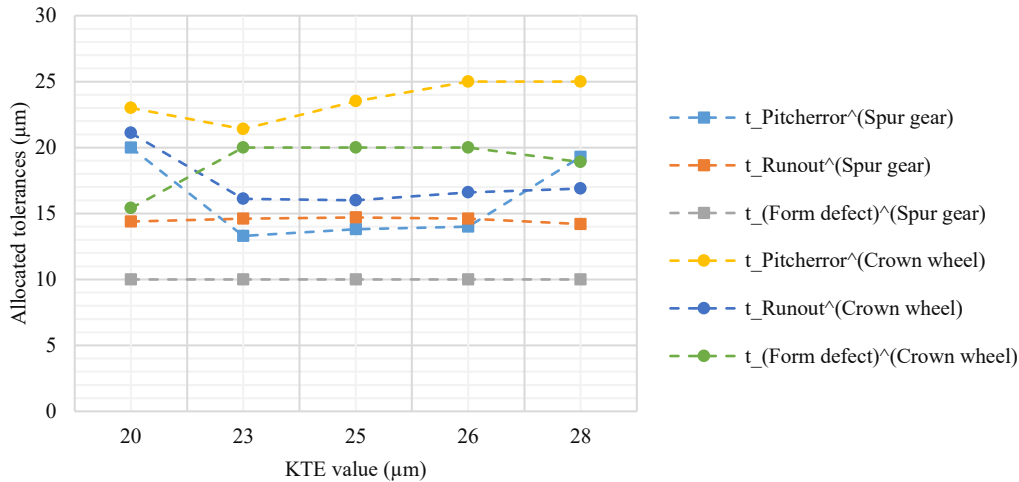

(e). Allocated tolerances on gears' features using SaDE approach

**Figure 35.** Surrogate-assisted optimization results

Therefore, the optimization approach allocates tighter tolerances on the crown wheel features in comparison to the spur gear, to avoid the increase in the number of defectives and manufacturing cost.

### III.3. Conclusion

Cost-tolerance optimization is a method used to balance the cost of manufacturing a product with the allowable tolerance of the product's dimensions or performance. In the literature, cost-optimization methods are limited to the parametric models which associate the impact of tolerance with the variation in the manufacturing cost. These models heavily rely on clinical data and are not easily adaptable to different types of products. This means that they cannot be easily modified to accommodate the specific needs of a variety of products. As a result of the limitations of the existing parametric models, which only account for the impact of tolerance on manufacturing cost variations, a specialized and modular model is required. Such a model should possess the capability to be adjusted to accommodate the specific requirements of various assembly designs with ease.

Consequently, in this chapter, an original modular cost-tolerance optimization model. Contrary to the parametric models, it enables designers to integrate production strategies such as resource allocation, reworking, and assembly, into the tolerance allocation model while the cost value associated with each module is fixed. This model aims at reducing manufacturing costs by identifying and targeting the most critical specifications of the product where tight tolerances are required. It can

help identifying specifications in the production process where the cost is high and the tolerance is low, allowing manufacturers to improve these specifications and reduce costs by optimizing the balance between cost and tolerance.

Since this model is structured as a modular model, each module or activity is associated with the impact of the activity on the assembly or components. The impacts can be evaluated using simulation or a surrogate model in order to estimate the efficiency of the activity. On the one hand, a simulation\surrogate-assisted cost-tolerance optimization is a valuable mean for manufacturers as it allows them to strike a balance between cost and quality, resulting in a more efficient and cost-effective production process while still producing high-quality products. On the other hand, this approach shows a strong dependency on the surrogate model which requires proficient techniques and skills to support insight into the assembly quality.

(This page left intentionally blank)

## Chapter IV: Selecting the fittest assembly strategy

---

The precision and functionality of an assembly are highly dependent on the dimensions of its components which is the major cause of quality issues. Typically, the overall tolerance of an assembly is calculated by summing up the individual component tolerances. This can make manufacturing the components with a high level of precision very costly and sometimes impossible. There are alternative methods such as selective assembly or individual for achieving high precision assemblies using less precise components. Selecting the fittest assembly strategy involves evaluating different options and determining which one is the best fit for a particular situation. Important factors such as product complexity, volume, cost, quality, etc. can be considered when selecting an assembly strategy. After considering these factors, it is essential to evaluate the different assembly strategies, comparing them to determine which one is the best fit for the particular assembly.

---

## **Table of Contents**

IV.1. Introduction.....	101
IV.2. Random assembly .....	102
IV.3. Selective assembly (SA).....	104
IV.3.1. KC identification.....	104
IV.3.2. Binning methods .....	105
IV.3.3. Bins combination criteria.....	107
IV.3.4. Mixed Strategy (MS) solutions .....	109
IV.4. Individual assembly (IA): Global Optimum Quality Criterion (GOQC).....	111
IV.5. Proposed assemblies applications.....	113
IV.5.1. Electric motor assembly strategies analyses .....	113
IV.5.2. Gears assembly strategies analyses .....	120
IV.6. Conclusions .....	128

## IV.1. Introduction

Assembly is an important step in the manufacturing process, as it involves bringing together individual components or subassemblies to create a finished product. It is a critical step in the manufacturing process, as it ensures that products are properly put together and functional, while also allowing manufacturers to improve efficiency, quality control, scalability, and cost savings. Also, it is essential for high-precision products because it ensures that the final product meets the required specifications and tolerances. This is important in high-tech industries such as aerospace, medical device, and semiconductor manufacturing where precision and accuracy are critical for the proper functioning of the product and the safety of the user. The high-precision assembly also ensures that the product will perform as intended throughout its intended lifespan, reducing the need for costly repairs or replacements.

An adaptive assembly is an approach to manufacturing that allows for the dynamic adjustment of assembly processes based on real-time feedback from sensors and other data sources. It is also known as "smart assembly" or "intelligent assembly" which can be applied in high-tech industries (Yi *et al.*, 2021). One of the main benefits of adaptive assembly is that it allows manufacturers to quickly respond to changes in product design or customer requirements, without the need for extensive retooling or redesign of assembly equipment. This can help to improve the efficiency and flexibility of the assembly process (Sun *et al.*, 2020). An adaptive assembly approach is developed and proposed in this section which evaluates various assemblies' strategies such as random assembly, selective assembly, and individual assembly.

In random assembly, products are assembled using components that have been randomly selected from a pool of available ones. This approach is often used in industries such as electronics, where many different components can be used to build a product, and it is not practical or cost-effective to pre-assemble all possible variations of a product. Selective assembly and individual assembly are two methods that can be used to improve the efficiency and flexibility of the assembly process without increasing too much the required time. Both selective assembly and individual assembly methods can be useful in situations where product complexity, customization, or production volume changes frequently. They can also improve the flexibility of the assembly process and make it more adaptable to changes in product design or production volume.

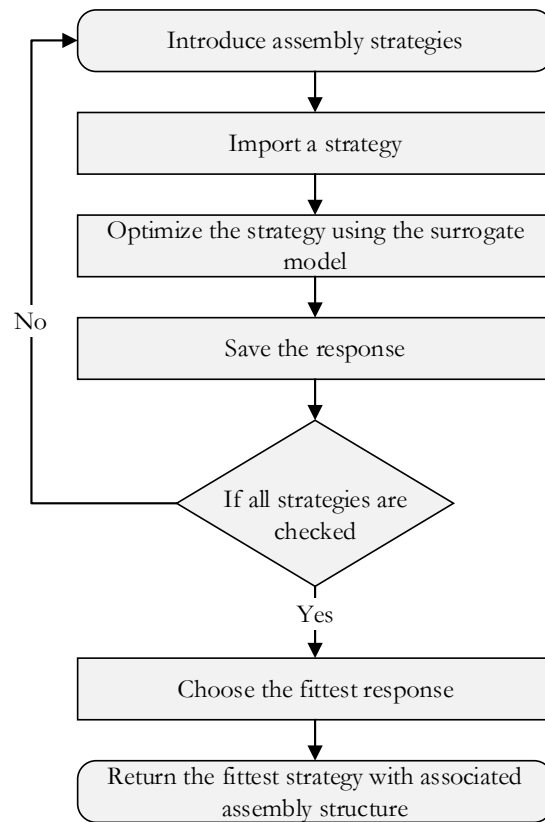
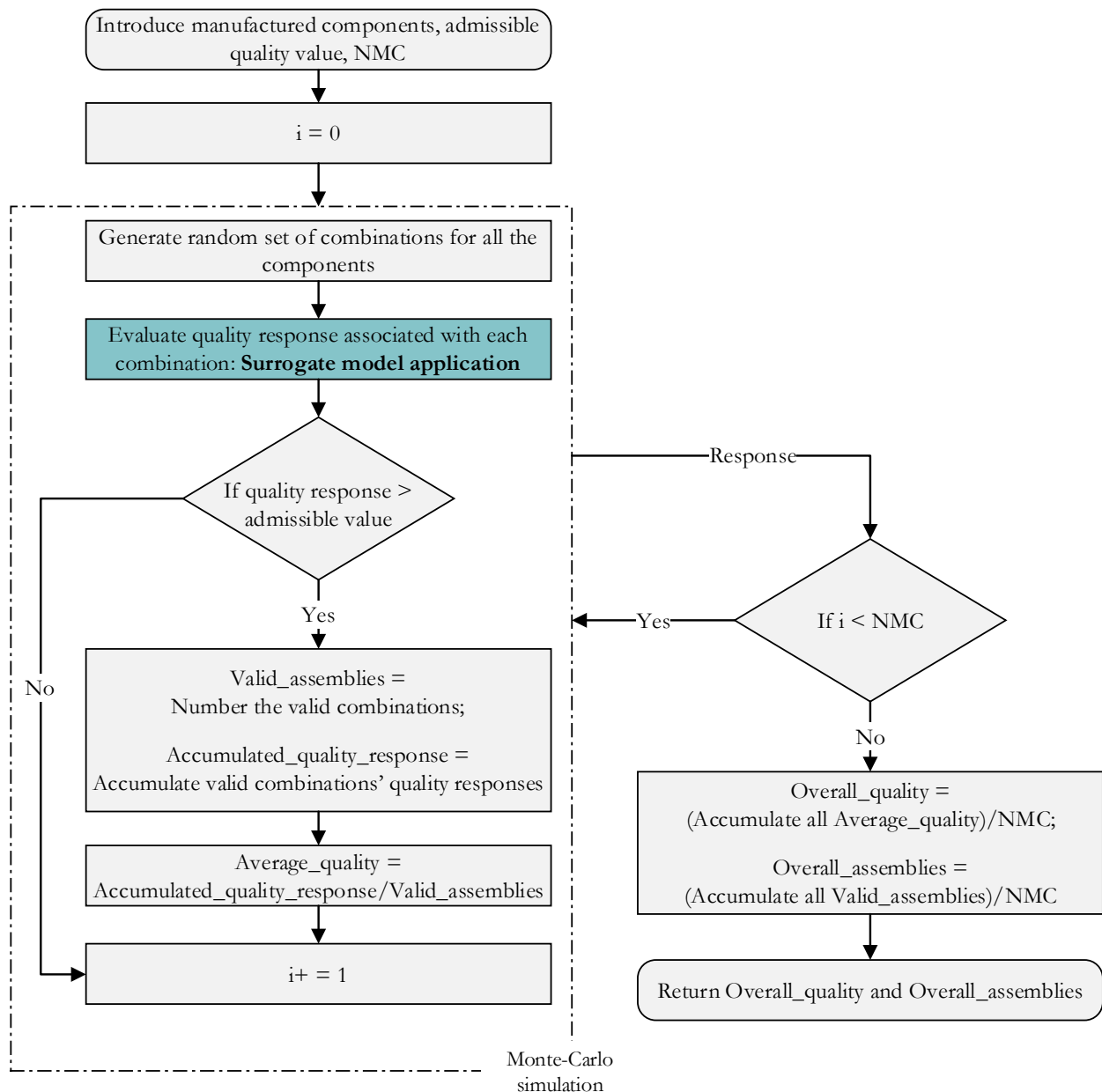

**Figure 36.** Adaptive assembly approach

The approach is detailed in **Figure 36**. This approach can be adapted to each type of assembly product and return the fittest assembly strategy. The application of the approach has a strong dependency on the tolerance analysis model which evaluates the quality response of the assembly. This section focuses on proposing suitable selective and individual assembly strategies using surrogate models developed in Chapter II to improve assembly quality. Therefore, the following section explains in detail the assembly approaches and associated issues.

## **IV.2. Random assembly**

Random assembly combines components or subassemblies in a random or unordered fashion, rather than following a specific sequence or blueprint. This approach can be simulated using the Monte-Carlo technique. In this part, it is assumed that components are manufactured and labeled. Each label contains a component specification. Afterward, the simulation method uses labels along with the associated specifications to assess the random assembly efficiency. The method's flow chart is outlined in **Figure 37**.



**Figure 37.** Random assembly simulation using Monte-Carlo

In this method, the application of the surrogate model is highlighted in the evaluation step which assesses the quality response of the randomly generated combinations. The generation of random combinations in practice reduces assembly costs. However, it doesn't minimize the risk of errors and defects in the final product. Random assembly requires that the operators or workers have a good understanding of the assembly process and the components being used.



### **IV.3. Selective assembly (SA)**

Selective assembly is a cost-effective solution for achieving high precision. Selective assembly involves inspecting components during production, grouping them into categories based on specific quality characteristics, and then only pairing components within those categories according to a pre-determined criterion. This approach transforms a product quality issue into a problem of system design and operation.

The development of optimal selection strategies for high-quality products is complicated in general. Therefore, this thesis proposes a selective assembly approach in which the nature of the optimal solutions is characterized by studying four main streams: (1) KC identification (section IV.3.1), (2) binning methods (section IV.3.2), (3) bins combination criteria (section IV.3.3), and mixed strategy solutions (section IV.3.4). The issues are realized in this section.

#### **IV.3.1. KC identification**

In selective assembly, the components are distributed among different bins which are organized according to the components' sizes and dimensions. This method applies to assemblies with components having one KC. Since a complex assembly may be assembled of components with multiple characteristics, a solution to this challenge is to identify the KC. The identification of the KC is recognized using sensitivity analysis to determine how the functionality of the assembly is affected based on variations in input characteristics.

In Chapter II, several statistical tolerance analysis models were investigated to estimate the assembly response corresponding to the tolerances allocated to the characteristics. Therefore, the assembly response can be determined using  $Y = f(X)$ , where  $f$  represents the tolerance analysis system function of the vector of characteristics  $X$ . Now, the identification of KCs can be investigated using sensitivity analysis. In this research, a probabilistic sensitivity analysis method so-called Sobol method is employed to identify the KCs on the components of the assembly. This method expresses relative sensitivities as the fraction of the variance of the assembly response that can be attributed to each uncertain characteristic (Sobol, 1993). The steps of Sobol sensitivity analysis are detailed in **Figure 38**.

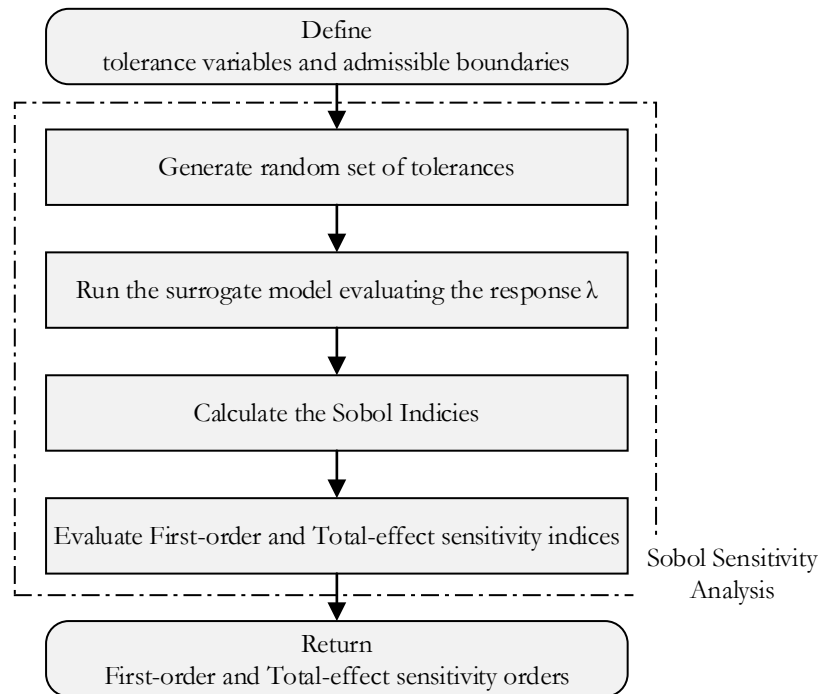

**Figure 38.** Sobol sensitivity analysis

In this method, to build a picture of the importance of each characteristic in determining the assembly response variance, first-order sensitivity index (S1) and total-effect Sensitivity Orders (ST) are measured. A higher sensitivity index means higher importance of the characteristic. The method is explained more in detail in Appendix II. Hence, KC is identified, and the components can be categorized and distributed among the bins.

### IV.3.2. Binning methods

Binning methods in selective assembly involve grouping components into clusters, or "bins", based on their similarity. Different binning methods can be used to classify and separate components based on their characteristics. Some common methods include (Matsuura & Shinozaki, 2011; Mease *et al.*, 2004; Siva Kumar *et al.*, 2007):

- Feature-based binning: This method uses geometric features, such as edges, corners, and points, to classify and group components.
- Dimensional binning: This method classifies, and groups components based on their dimensional characteristics, such as size, length, width, and height.

- Statistical binning: This method uses statistical techniques, such as principal component analysis (PCA) and linear discriminant analysis (LDA) to classify and group components based on their characteristics.

Each method has its advantages and disadvantages, and the choice of which method to use will depend on the specific application and the characteristics of the components. Since complicated assemblies come with multiple characteristics, the statistical method is investigated using the KC identification method discussed. Afterward, the binning method is divided into two approaches: an equivalent number of components or predefined tolerance boundaries.

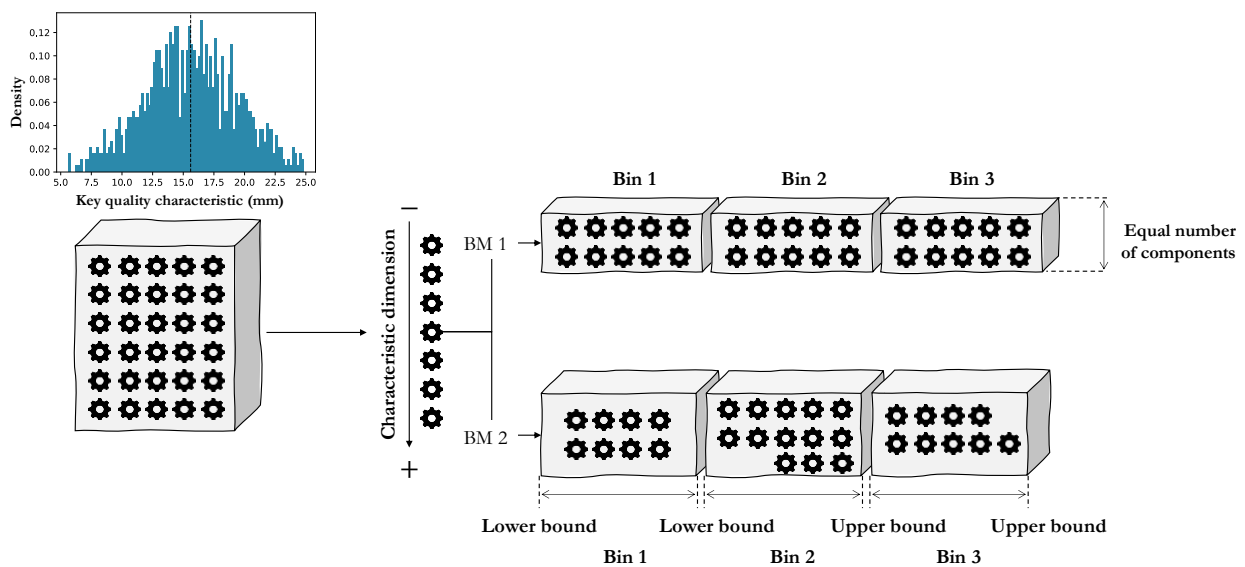

**Figure 39.** Binning methodology techniques

- (a) BM1: Equivalent number of components

The first binning method BM1 is based on the equal area (probability) that distributes the components in equal numbers among the existing bins. This method is a quantitative-based method in which an equivalent number of components can be found in all bins for each type of component. This method helps decrease the number of scraps and residuals in the inventory.

- (b) BM2: Define tolerance boundaries

This method is a qualitative-based method which is originated from the equal width (variance) partitioning method; however, the width of the bins can be adapted. The modification of the width is purposed to improve the assembly quality. Since the number of the distributed

components in the bins may differ, the number of residual components may increase. Therefore, the residual components will be stored in the inventory to be assembled for the next production cycle.

### IV.3.3. Bins combination criterions

In selective assembly, bin combination refers to the process of selecting the appropriate storage bin for a given component. This is typically done after the component has been classified and grouped based on its characteristics. The bin combination process is important for ensuring that the correct bins are combined, which can improve the efficiency and accuracy of the assembly process. Bin combination also helps to reduce the risk of errors and maximize the assembly's precision. The combination of several bins is referenced to criteria such as yielding the maximum number of assemblies or maximizing the quality of the assemblies required to be achieved.

---

Parameters:

---

$S$	Set of possible combinations of bins
$B_i^{co}$	Associated bin $i$ to component $co$
$n_i^{co}$	Number of components $co$ in bin $i$
$co$	Number of the variety of components
$QE_{i,i'}$	Evaluated quality value of combination bin $i$ associated with component 1 and bin $i'$ associated with component 2
$N_{i,i'}$	Number of the possible assemblies from combination bin $i$ associated with component 1 and bin $i'$ associated with component 2
$x_{i,i'}$	1 if bin $i$ associated with component 1 is combined with bin $i'$ associated with component 2

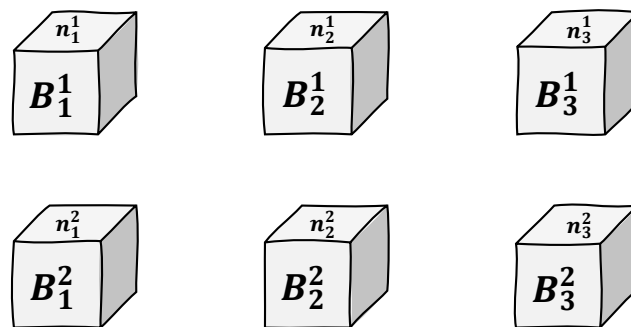

**Figure 40.** Exemplary assembly of two components

Let us assume a product assembled of two distinct components which are distributed among three existing bins (**Figure 40**). Each bin stores  $n$  number of specific types of components which can

## Selecting the fittest assembly strategy

---

vary. For instance, bin  $B_3^2$  which is indicated as the third bin, stores  $n_3^2$  number of component 2 inside. The set of possible combination  $S$  for the exemplary can be given as follow:

$$S = \{\{B_1^1, B_1^2\}, \{B_1^1, B_2^2\}, \{B_1^1, B_3^2\}, \{B_2^1, B_1^2\}, \{B_2^1, B_2^2\}, \{B_2^1, B_3^2\}, \{B_3^1, B_1^2\}, \{B_3^1, B_2^2\}, \{B_3^1, B_3^2\}\}$$

Consequently, the set  $\{B_2^1, B_2^2\}$  means that bins  $B_2^1$  and  $B_2^2$  are combined and the number of the assemblies for this combination is equal to the minimum number of the components in the bins  $N_{2,2} = \min\{n_2^1, n_2^2\}$ . This indicates the assumption that the redundant number of the other type of component will be stored.

The mathematical optimization model of the combination problem can be formulated as follows:

$$\text{mix}\backslash\text{max criterion} \tag{17}$$

Subject to,

$$\sum_{i=1}^3 \sum_{i'=1}^3 x_{i,i'} = 3 \tag{18}$$

$$\sum_{i'=1}^3 x_{i,i'} = 1 \quad \forall i \in [1,3] \tag{19}$$

$$\sum_{i=1}^3 x_{i,i'} = 1 \quad \forall i' \in [1,3] \tag{20}$$

where the optimization model is constrained to eq. (18) which indicates the cumulative combination should be equal to the number of the bin; and eq. (19) and eq. (20) illustrate that each bin corresponding to each component can be combined with one bin of the other component. Thus, the problem is defined, developed surrogate model can be integrated into the assembly problem which would help to define a variety of optimization criteria that vary. In this case, the criteria are proposed as follows:

(a). Quality criterion mean maximization (QCMM)

QCMM is an expected value that evaluates the quality of conformed assembled components within the selected bins. This criterion maximizes the quality of the assemblies; therefore, it represents the potential quality of an assembly that targets customer satisfaction. The increase

in quality increases customers' satisfaction. Equation (21) depicts the mathematic representation of the criterion:

$$Mean\ Quality = \sum_{i=1}^3 \sum_{i'=1}^3 \frac{QE_{i,i'}}{N_{i,i'}} \times x_{i,i'} \quad (21)$$

where  $QE_{i,i'}$  indicates the evaluated quality value of the possible assemblies which is divided by the number of the possible pairs  $N_{i,i'}$ . The summands of the value upon all paired bins depict the total mean value of the assemblies which is divided by 3 (the number of bins for each type of component) to estimate the expected quality value overall.

(b). Paired number maximization (PNM)

PNM indicates the expected number of conformed assemblies. This criterion illustrates the manufacturer's expectation of the production plan which means maximizing the number of assemblies. In eq. (22) the criterion is formulated:

$$Pairs = \sum_{i=1}^3 \sum_{i'=1}^3 N_{i,i'} \times x_{i,i'} \quad (22)$$

(c). Quality criterion inertia minimization (QCIM)

QCIM is the inertia of the quality value which measures spread around the mean value. It aims at improving the mean quality while minimizing the standard deviation.

$$Inertia = \sum_{i=1}^3 \sum_{i'=1}^3 (mean_s + deviation_s) \times x_{i,i'} \quad (23)$$

Subject to,

$$mean_{i,i'} = \frac{QE_{i,i'}}{N_{i,i'}} \quad , \forall i, i' \in [1,3] \quad (24)$$

$$deviation_{i,i'} = \sqrt{\frac{\sum_{j \in s} (QE_{i,i'} - mean_{i,i'})^2}{N_{i,i'}}} \quad , \forall i, i' \in [1,3] \quad (25)$$

#### IV.3.4. Mixed Strategy (MS) solutions

In the previous section, the proposed QCMM, PNM, and QCIM criteria are presented as indicators that present the customer's satisfaction value, the manufacturer's expectation, and a general

indicator, respectively. Contrary to QCIM which provides the assembly structure while minimizing the variation of the assembly from the mean value of the quality criterion, QCMM and PNM target the value which satisfies the customer and manufacturer, exclusively. Therefore, in this section, a mixed strategy-based approach is developed and proposed. A mixed strategy is an approach to this type of problem that optimizes the assembly while satisfying customers' and manufacture's expectations. In this approach, the manufacturer and customer call as players whose satisfaction criteria differ. Therefore, an appropriate approach to solve this problem is to define two levels of optimization such as leader level (upper-level) and follower level (lower-level) (Lachhwani & Dwivedi, 2018). Each level represents the criterion of each player that is required to be satisfied. The approach initiates with satisfying the lower-level criterion, so-called the superior player, and optimizing the criterion associated with each binning method. At this level, the optimum criterion, and the optimum assembly structure, as well as the payoff (corresponding criterion) for the upper-level player is obtained. Next, the approach satisfies the upper-level criterion and locates the solution among the lower-level solutions which satisfy the upper-level the most. In this regard, the first step that aims at locating the optimal solution is to set up a payoff matrix. The payoff matrix is a table in which binning methods are listed in rows and the criterion objectives (i.e. QCMM and PNM) are in the columns. The cells show the payoffs to each binning method and the optimal value of the objectives including the assembly structure and the value of the other objectives corresponding to the assembly structure. Once the matrix is set up, two decision rules can be taken as follows:

1) **MS1: Customer–manufacturer satisfaction**

In this strategy, the customer comes in the upper-level of the optimization and the manufacturer comes in the lower-level. Therefore, the lower-level obtains the assembly structure which obtains the maximum number of pairs; then, on the upper-level, the assembly structure which causes the maximum assembly quality will be selected.

2) **MS2: Manufacturer – customer satisfaction**

Contrary to MS1, the manufacturer leads the optimization approach and the customer follows the leader. It means that in the lower-level, the approach locates the optimum solutions which maximize the assembly quality corresponding to each binning method. Afterward, the manufacturer takes the next step and selects the solution which maximizes the number of pairs the most.

On these bases, in this section, the selective assembly and relevant subjects are discussed. In this method, components are distributed among existing bins, afterward, the bins are paired in a way that satisfies the requirements of the assembly. This method improves the assembly quality and number of the conformed assembly compared to random assembly, however, it may cause an increase in the number of residuals in the inventory department in one production time. An alternative to this method is to assemble components individually in a manner that maximizes the overall quality of the assemblies. This approach is proposed in the coming section.

#### **IV.4. Individual assembly (IA): Global Optimum Quality Criterion (GOQC)**

An alternative strategy for selective assembly is individual assembly which refers to the process of assembling a product one unit at a time, rather than in a batch or mass production process. In individual assembly, each product is assembled individually. This approach allows for more flexibility and customization in the assembly process, as well as the ability to address any issues or defects that may arise during the assembly of a single unit. Individual assembly is often used for high-precision or high-value products where quality and accuracy are crucial. It is also commonly used for low-volume or one-of-a-kind products, where mass production methods are not cost-effective. Individual assembly may take more time and resources than batch or mass production, but it allows for a higher degree of control over the production process and can produce higher-quality products. In this thesis, a novel exhaustive individual assembly approach is presented below.

GOQC is an individual assembly scheme that evaluates all the combinations of the components and selects the pairs with the maximum quality level. This method is adapted from the Kuhn–Munkres (or Hungarian) algorithm (Munkres, 1957), a combinatorial optimization algorithm, to solve the One-to-One (O-O) assignment problem. In this problem, one task is matched to one and the time complexity is  $O(n^3)$ , where  $n$  is the number of rows or columns in the quality matrix being optimized. Therefore, the model is adapted to match component-to-component and maximize the quality of the overall assemblies while satisfying the pre-defined quality level. For instance, let us assume the electric motor which is assembled of 3 components B, H, and S. The components B, H, and S are available in 2, 3, and 2 volumes in the inventory. Therefore, the set of all combinations  $C$  to have the assembly is a subset of all the matches  $C = \{B1H1S1, B1H1S2, B1H2S1, B1H2S2, B1H3S1, B1H3S2, B2H1S1, B2H1S2, B2H2S1, B2H2S2,$



$B2H3S1, B2H3S2\}$  of size  $|C| = \binom{2}{1} * \binom{3}{1} * \binom{2}{1} = 12$ . Possible network of the combination is illustrated in **Figure 41**.

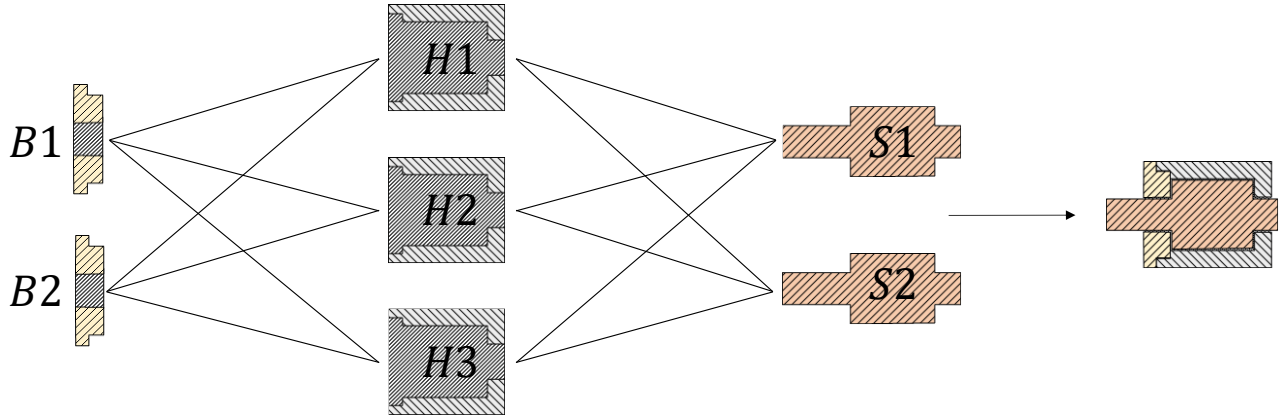

**Figure 41.** Individual assembly of the electric motor

The mathematical representation of the individual assembly of the electric motor can be expressed as follows:

$$\max Quality = \sum_{i \in A} \sum_{j \in B} \sum_{k \in C} QE_{ijk} \times x_{ijk} \quad (26)$$

Subject to,

$$\sum_{i \in \{B1, B2\}} x_{ijk} = 1 \quad \begin{array}{l} j \in \{H1, H2, H3\} \\ , k \in \{S1, S2\} \end{array} \quad (27)$$

$$\sum_{j \in \{H1, H2, H3\}} x_{ijk} = 1 \quad \begin{array}{l} i \in \{B1, B2\} \\ , k \in \{S1, S2\} \end{array} \quad (28)$$

$$\sum_{k \in \{S1, S2\}} x_{ijk} = 1 \quad \begin{array}{l} i \in \{B1, B2\} \\ , j \in \{H1, H2, H3\} \end{array} \quad (29)$$

$$QE_{ijk} \times x_{ijk} \geq \text{admissible quality} \quad \begin{array}{l} i \in \{B1, B2\} \\ , j \in \{H1, H2, H3\} \\ , k \in \{S1, S2\} \end{array} \quad (30)$$

In this method, the quality response  $QE$  of an individualized assembly can be assessed by the application of the surrogate model. Therefore, in this example, the proposed model in section II.2.2

is embedded into the assembly problem which assesses the assembly conformity rate of each assembly as well as the overall assembly conformity rate. In the following section, assembly strategies' applications are studied and analyzed.

## IV.5. Proposed assemblies applications

The application of the proposed approaches is illustrated and analyzed in this sub-section. The electric motor assembly problem and gears pairing problem illustrate the compatibility of the approaches for different assemblies with exclusive complexities.

### IV.5.1. Electric motor assembly strategies analyses

The electric motor is an assembly machine that is composed of a house, a body, and a shaft. In section II.2.2, a surrogate is developed to predict the assembly functionality and report the functionality in conformity rate. Afterward, in section III.2.2, the optimum tolerances and resources are allocated which specifies practical resources and optimal tolerances domains to manufacture a high-quality assembly cost-efficiently. Therefore, concerning the optimal solution, 150 components are produced separately. Consequently, all the possible combinations to have an assembly are equal to

$$\binom{150}{1}_{House} * \binom{150}{1}_{Body} * \binom{150}{1}_{Shaft} = 150 * 150 * 150 = 3375000. \text{ For more information, number of the}$$

possible assemblies in random assembly is equal to  $\left( \binom{150}{1}_{House} * \binom{150}{1}_{Body} * \binom{150}{1}_{Shaft} \right) + \left( \binom{149}{1}_{House} * \right.$

$$\left. \binom{149}{1}_{Body} * \binom{149}{1}_{Shaft} \right) + \left( \binom{148}{1}_{House} * \binom{148}{1}_{Body} * \binom{148}{1}_{Shaft} \right) + \dots + \left( \binom{1}{1}_{House} * \binom{1}{1}_{Body} * \binom{1}{1}_{Shaft} \right) = 150^3 +$$

$$149^3 + \dots + 1^3 = \sum_{i=1}^{100} i^3 = \frac{150^2 * 151^2}{4} = 128255625.$$

To evaluate the responses (assembly conformity rate) associated with the possible 3375000 combinations, firstly the components are labeled, house (**H**), body (**B**), and shaft (**S**), respectively. Next, the proposed surrogate model in section II.2.2 is deployed to assess the response for each assembly combination. **Figure 42** illustrates the structure of the assessed responses for all the possible combinations. Once the responses are obtained, assembly strategies can be assessed and compared.

## Selecting the fittest assembly strategy

Let us assume the admissible conformity rate is equal to 95.00% which indicates that if the assembly conformity is less than the value, it is rejected.

H1	S1	S2	S3	S4	S5	...	S150
B1	89.80%	89.32%	100.00%	100.00%	90.08%	...	99.04%
B2	90.17%	89.78%	100.00%	100.00%	90.49%	...	99.08%
B3	91.13%	90.95%	100.00%	100.00%	91.56%	...	99.17%
B4	94.00%	93.75%	100.00%	100.00%	94.19%	...	99.44%
B5	89.92%	89.52%	100.00%	100.00%	90.25%	...	99.06%
...	...	...	...	...	...	...	...
B150	90.44%	90.05%	100.00%	100.00%	90.74%	...	99.10%

**Figure 42.** Evaluated response for all the possible combinations of the houses, bodies, and shafts

On this base, if the manufacturer applies random assembly using the Monte-Carlo simulation over  $10^6$  iterations, 116 out of 150 assemblies are conformed and the assembly conformity means the value is equal to 96.77%. As explained in this section, selective assembly and individual assembly strategies are developed to improve the assembly decision as well as assembly quality.

Initially, individual assembly is adapted and analyzed. This method assembles components in a way that improves the quality of the assemblies overall. The Kuhn-Munkres algorithm is a solution for a two-dimensional problem. For a three-dimensional problem, one approach is to reduce it to multiple two-dimensional problems and then apply the Kuhn-Munkres algorithm to each one. For a three-dimensional problem, the time complexity would likely be  $O(n^6)$ , where  $n$  is the number of rows or columns. The method reported 150 conformed assemblies with a mean conformity value of 100%. The assemblies and responses are detailed in **Table 13**.

**Table 13.** Optimal IA assemblies

House labels	H1	H2	H3	H4	...	H50	H51	H52	...	H149	H150
Body labels	B108	B10	B123	B9	...	B6	B88	B61	...	B30	B89
Shaft labels	S113	S17	S100	S20	...	S30	S137	S116	...	S131	S125
Conformity rate	0.95	0.97	0.97	0.97	...	1.00	1.000	1.000	...	0.981	0.974

For instance, in this case, an optimal assembly can be obtained by combining house H5, body B6, and shaft S30 which yields a conformity rate of 100%. This method explores the possible combinations and reports the optimal combinations in return. On one hand, it promises the optimal assemblies, comprehensively. On the other one, it's a time-consuming method where the calculation time depends on the number of components and types, effectively. As aforementioned, in this case, the exploration space is equal to  $\underbrace{150}_{House} * \underbrace{150}_{Body} * \underbrace{150}_{Shaft}$ . Moreover, the application of this method requires a 100% inspection of the components which is costly.

The selective assembly for components with multiple characteristics is more complicated and requires identifying the relevant KC to each component. The Sobol method is employed to identify the KC on each component using the surrogate model developed. **Figure 43** demonstrates the Sobol index values for each characteristic and  $t_{F12}$  on house,  $t_{F21}$  on body, and  $t_{F32}$  on shaft are interpreted as KCs.

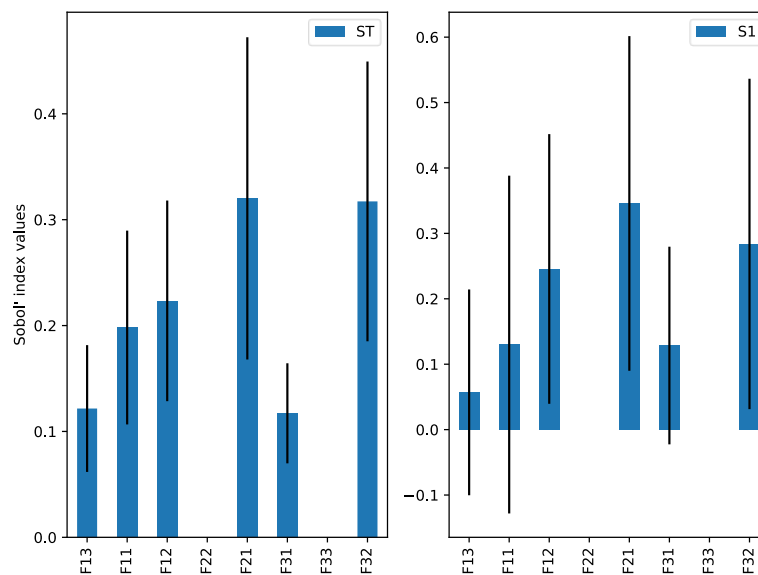
**Figure 43.** Electric motor KC identification using Sobol indices

## Selecting the fittest assembly strategy

The identification of the KCs enables us to distribute the components among the bins based on KCs. At this moment, the components are binned, and the bins attributed to each type of component can be assembled accordingly. Each type of component can be distributed by two different methods BM1 and BM2. Therefore, the number of possible binning methods is equal to  $\underbrace{2}_{House} * \underbrace{2}_{Body} * \underbrace{2}_{Shaft} = 8$ .

The proposed SA explores all the methods and delivers the optimal combination structure, individually. Finally, among the optimal solutions to each method, the ones which satisfy the criteria the most are selected. **Figure 44** and **Figure 45** demonstrate the optimal combinations which satisfy the pre-defined criteria as well as a histogram graph of the average conformity rate for random assembly among the optimal combinations. Please take note that in **Figure 44** and **Figure 45**, for a better demonstration of the assembly conformity, the vertical axes are limited to show in range 0 and  $10^4$  since most of the assemblies lie in 100% conformity. In this method, if the manufacturer seeks to maximize the number of the assemblies, binning method BM1 which distributes the components adequately can be considered for all the components; and the bins can be combined as follows: **HB1** is paired with **BB2** is paired with **SB1** with average conformity 98%; **HB2** is paired with **BB3** is paired with **SB2** with average conformity 97%; **HB3** is paired with **BB1** is paired with **SB3** with average conformity 97%. By this combination structure, a maximum number of 116 assemblies can be reached. This structure represents solution MS2 as well, which maximizes customer satisfaction with a 96.69% mean conformity rate. A comprehensive comparison is provided in **Figure 46**. **Table 14** provides the optimal criterion for each binning method and the extensive optimal solutions which are highlighted.

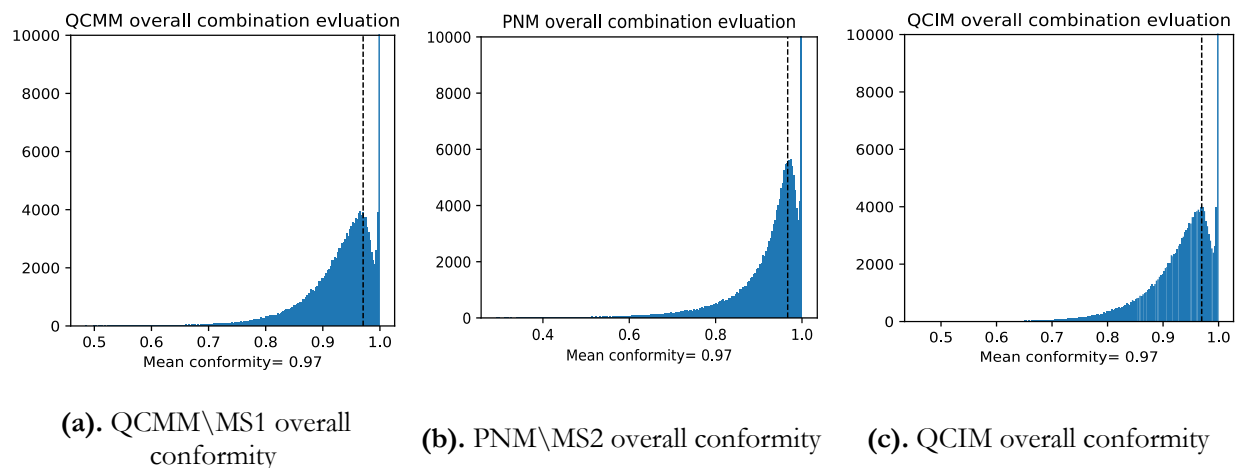

**Figure 44.** Overall combination evaluation for electric motor assembly

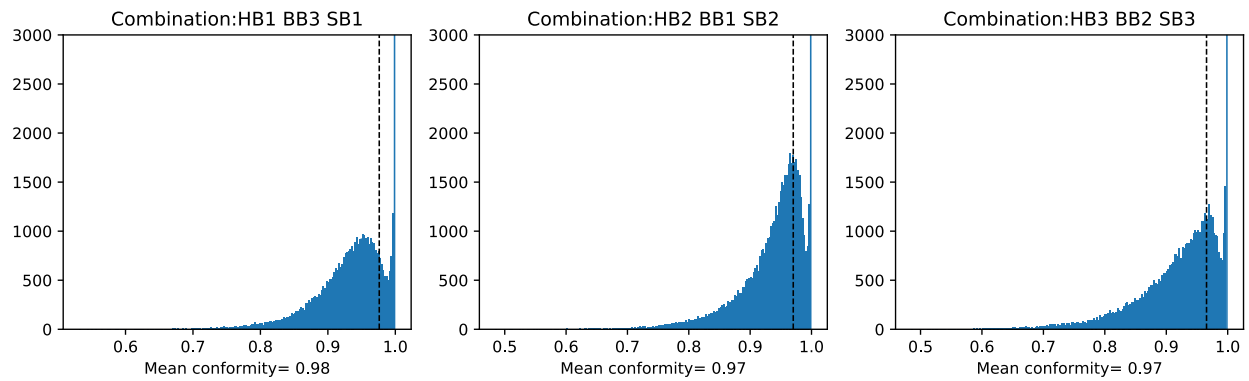

(a). QCMM\MS1 random internal assembly among optimal combinations evaluation (BM1-based bins)

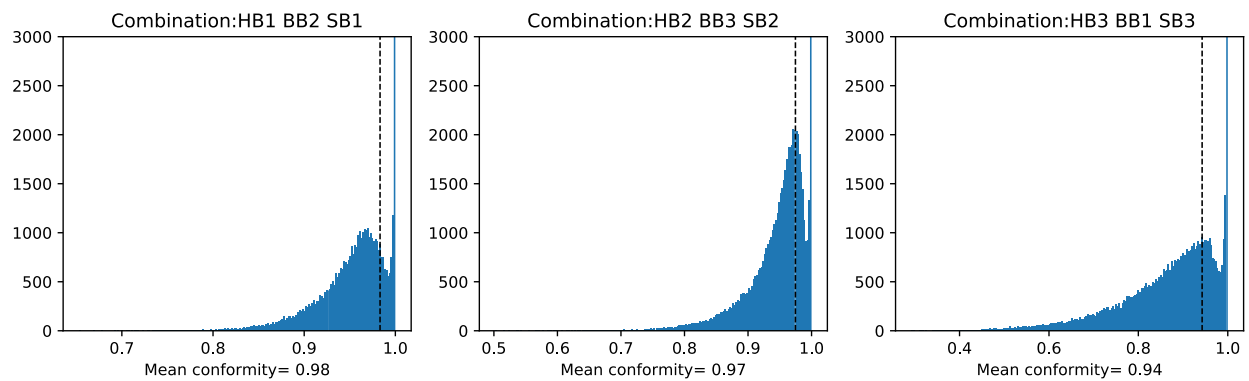

(b). PNM\MS2 random internal assembly among optimal combinations evaluation (BM1-based bins)

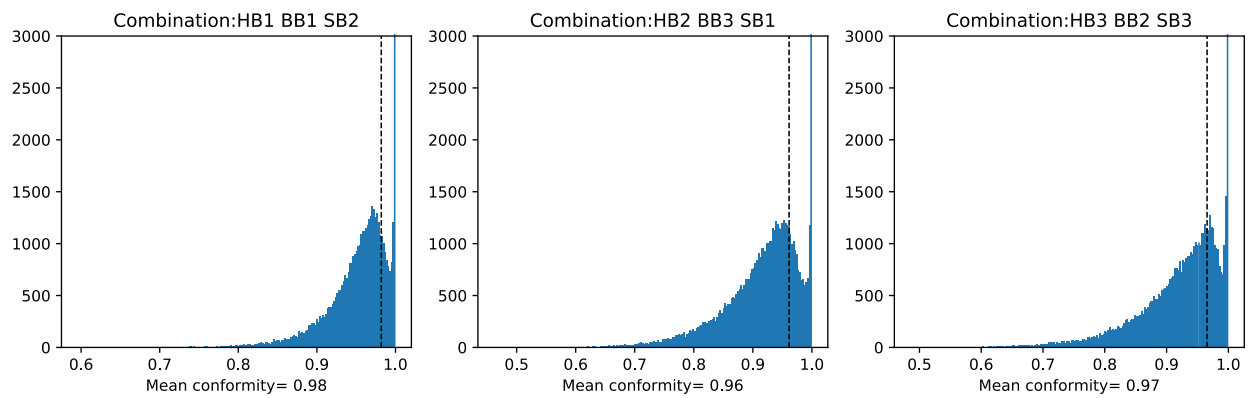

(c). QCIM random internal assembly among optimal combinations evaluation (BM1-based bins)

Figure 45. Random internal assembly among optimal combinations

*Selecting the fittest assembly strategy*

**Table 14.** SA binning methods and combination criterion assessment

	Maximize the Mean conformity	Maximize the number of the pairs	Minimize the Inertia
<b><i>BM1House * BM1Body * BM1Shaft</i></b>	Mean conformity = 97.06 Number of pairs = 114 Inertia = 1.02 <b>HB 1 is paired with BB 3 is paired with SB 1</b> <b>HB 2 is paired with BB 1 is paired with SB 2</b> <b>HB 3 is paired with BB 2 is paired with SB 3</b>	Number of pairs = 116 Mean conformity = 96.69 Inertia = 1.02 <b>HB 1 is paired with BB 2 is paired with SB 1</b> <b>HB 2 is paired with BB 3 is paired with SB 2</b> <b>HB 3 is paired with BB 1 is paired with SB 3</b>	Inertia = 1.02 Mean conformity = 97.10 Number of pairs = 114 <b>HB 1 is paired with BB 1 is paired with SB 2</b> <b>HB 2 is paired with BB 3 is paired with SB 1</b> <b>HB 3 is paired with BB 2 is paired with SB 3</b>
<b><i>BM1House * BM1Body * BM2Shaft</i></b>	Mean conformity = 96.70 Number of pairs = 85 Inertia = 1.03	Number of pairs = 88 Mean conformity = 96.48 Inertia = 1.03	Inertia = 1.02 Mean conformity = 97.00 Number of pairs = 85
<b><i>BM1House * BM2Body * BM1Shaft</i></b>	Mean conformity = 96.61 Number of pairs = 74 Inertia = 1.02	Number of pairs = 80 Mean conformity = 95.84 Inertia = 1.03	Inertia = 1.02 Mean conformity = 96.00 Number of pairs = 73
<b><i>BM1House * BM2Body * BM2Shaft</i></b>	Mean conformity = 96.19 Number of pairs = 60 Inertia = 1.03	Number of pairs = 77 Mean conformity = 95.29 Inertia = 1.03	Inertia = 1.03 Mean conformity = 96.01 Number of pairs = 58
<b><i>BM2House * BM1Body * BM1Shaft</i></b>	Mean conformity = 96.87 Number of pairs = 89 Inertia = 1.02	Number of pairs = 90 Mean conformity = 96.22 Inertia = 1.02	Inertia = 1.02 Mean conformity = 97.00 Number of pairs = 88
<b><i>BM2House * BM1Body * BM2Shaft</i></b>	Mean conformity = 96.48 Number of pairs = 84 Inertia = 1.02	Number of pairs = 87 Mean conformity = 95.84 Inertia = 1.03	Inertia = 1.02 Mean conformity = 96.00 Number of pairs = 84
<b><i>BM2House * BM2Body * BM1Shaft</i></b>	Mean conformity = 96.40 Number of pairs = 60 Inertia = 1.02	Number of pairs = 78 Mean conformity = 95.59 Inertia = 1.03	Inertia = 1.02 Mean conformity = 96.01 Number of pairs = 60
<b><i>BM2House * BM2Body * BM2Shaft</i></b>	Mean conformity = 95.95 Number of pairs = 58 Inertia = 1.03	Number of pairs = 106 Mean conformity = 95.31 Inertia = 1.03	Inertia = 1.03 Mean conformity = 96.6 Number of pairs = 58

Note: The optimal solutions are faded in  and the mixed solutions are faded .

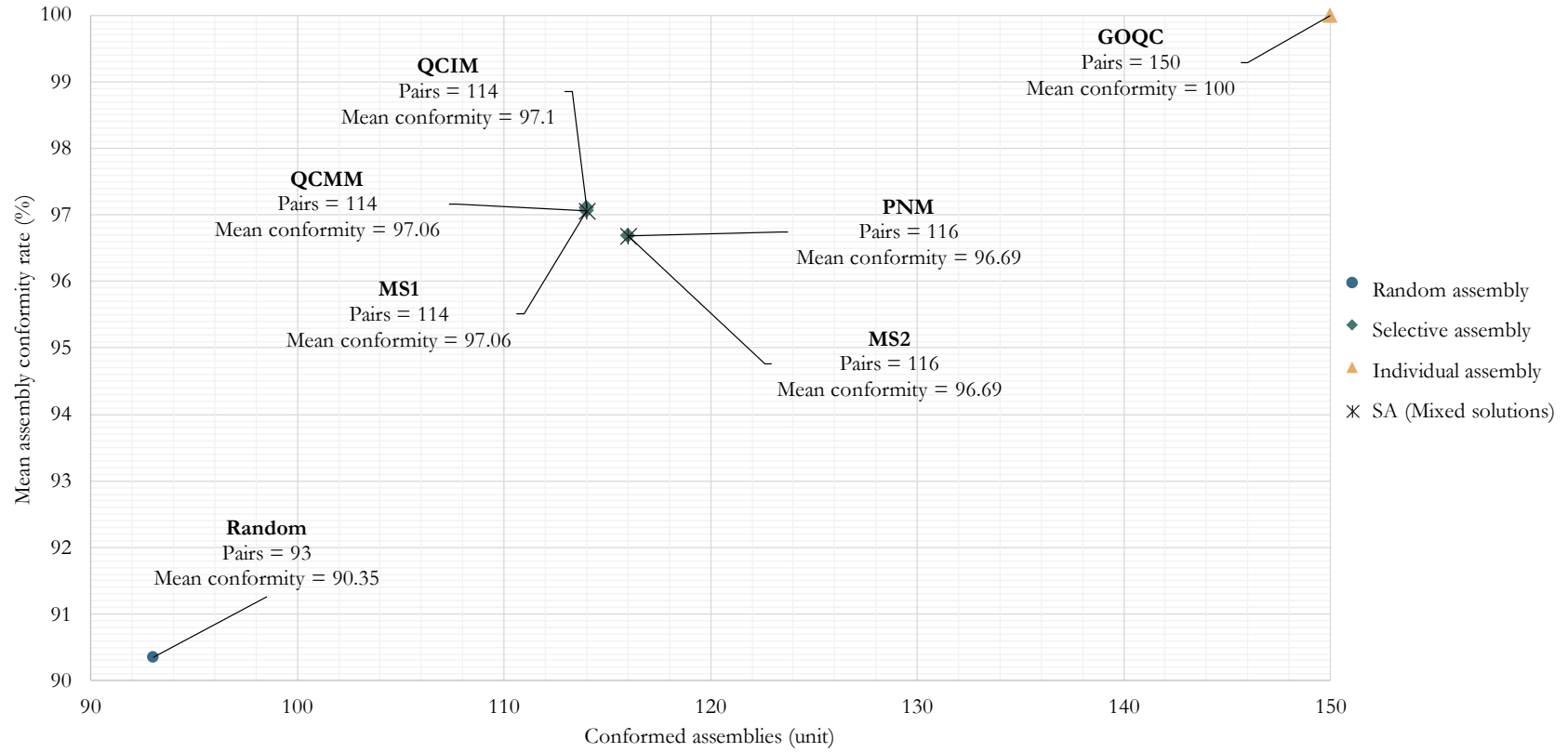

Figure 46. Electric motor assembly strategies comparison



**IV.5.2. Gears assembly strategies analyses**

In section II.3, a statistical surrogate model is developed to estimate a pair of spur gear and crown wheel conformity ratios as well as paired conformity associated with the geometrical deviations on each gear. The quality of paired gears is evaluated by calculating the KTE value which represents the global transmission error. Therefore, in this section, let us assume that the manufacturing department has produced 1000 conformed parts of each gear type which associate with different geometric deviations due to manufacturing imperfections. Therefore, the possible ways to pair two

gears are equal to  $\binom{1000}{1}_{Spur\ gear} * \binom{1000}{1}_{Crown\ wheel} = 1000 * 1000 = 10^6$ . And, the number of possible

combinations in random assembly is equal to  $\left(\binom{1000}{1}_{Spur\ gear} * \binom{1000}{1}_{Crown\ wheel}\right) + \left(\binom{999}{1}_{Spur\ gear} * \binom{999}{1}_{Crown\ wheel}\right) + \left(\binom{998}{1}_{Spur\ gear} * \binom{998}{1}_{Crown\ wheel}\right) + \dots + \left(\binom{1}{1}_{Spur\ gear} * \binom{1}{1}_{Crown\ wheel}\right) = 1000^2 + 999^2 +$

$998^2 + \dots + 1^2 = \sum_{i=1}^{1000} i^2 = \frac{1000*1001*2001}{6} = 333833500$ . Consequently, the surrogate model

comes to hand to evaluate the KTE value of all the possible combinations. In **Table 15**, a brief example of all combinations and evaluated KTE is detailed.

**Table 15.** Evaluated KTE for all the possible combinations of the spur gears and crown wheels

	C1	C2	C3	C4	C5	C6	C7	C8	...	C1000
<b>S1</b>	25.3	21.4	25.9	23.5	21.9	18.1	30.1	25.0	...	20.0
<b>S2</b>	24.9	16.8	25.2	24.3	20.2	14.4	27.2	23.0	...	15.2
<b>S3</b>	20.1	18.0	21.2	19.5	17.7	13.0	13.8	18.6	...	10.6
<b>S4</b>	22.1	21.6	22.5	23.8	17.2	17.9	25.2	23.0	...	12.6
<b>S5</b>	21.2	18.7	23.2	22.2	20.9	15.0	28.8	19.8	...	11.8
<b>S6</b>	24.4	16.3	25.7	23.2	19.2	17.5	25.6	20.7	...	15.0
<b>S7</b>	19.7	21.2	17.5	18.0	16.8	12.7	24.2	19.6	...	11.6
<b>S8</b>	21.2	17.7	20.8	20.0	18.2	13.9	21.9	15.4	...	7.4
...	...	...	...	...	...	...	...	...	...	...
<b>S1000</b>	19.6	16.3	22.1	17.9	19.3	12.7	25.2	20.4	...	11.4

Crown wheels are labeled with “C” and spur gears are marked with “S”. For instance, if spur gear S4 and crown wheel C3 be paired, the estimated KTE value is equal to 22.5 ( $\mu\text{m}$ ). The admissible KTE value for the pairing strategy is assumed to be 23 ( $\mu\text{m}$ ). It means that if the associated KTE with two paired gears exceeds the admissible value the pairing is not acceptable. A simple and common solution in practice is to assemble the gears randomly. A Monte-Carlo simulation for  $10^6$  random assemblies is employed which means each iteration pairs 1000 of each gear randomly and reports the number of feasible pairs and average KTE value of all the pairs. Finally, the simulation reported a 609 average number of pairs and a 22.71 ( $\mu\text{m}$ ) average KTE value.

Subsequently, selective assembly and individual assembly are applied to pair the gears efficiently while satisfying the quality requirements. Once **Table 15** is prepared, the individual assembly strategy GOQC is applied to find the optimal pairs which results in the minimum KTE for all the pairs. Contrary to the selective assembly which combines the bins, GOQC is proposed to apply an exhaustive exploration that evaluate all the possible combination and find the optimal for each of which the gears. The results of GOQC which pairs the gears individually to yield the minimum KTE overall are detailed in **Table 16**. For instance, the spur gear S3 is paired with crown wheel C893 and the predicted KTE is equal to 16.0 ( $\mu\text{m}$ ). The optimal overall KTE value for all the pairs is equal to 15.27 ( $\mu\text{m}$ ) and 982 gears are paired, optimally.

**Table 16.** Optimal IA pairs

<b>Spur gear label</b>	S1	S2	S3	S4	S5	S6	S7	S8	S9	S10	...	S1000
<b>Crown wheel label</b>	C689	C936	C893	C890	C154	C606	C703	C13	C776	C745	...	C255
<b>Evaluated KTE (<math>\mu\text{m}</math>)</b>	11.7	18.7	16.0	18.3	20.1	9.4	22.8	13.9	17.3	14.9	...	15.2

Since individual assembly is an expensive assembly in terms of calculation and inspection resources, selective assembly is faster and cheaper. The first step in the selective assembly is to identify the KC on each type of gear. To do so, as proposed in section IV.3.1, the proposed surrogate model and Sobol analysis are employed to identify the KC. **Figure 47** depicts the Sobol results using the surrogate model which identifies  $T_{Pitch\ error}^{Spur\ gear}$  and  $T_{Pitch\ error}^{Crown\ wheel}$  as the most vital characteristics having the most impact on the KTE value.

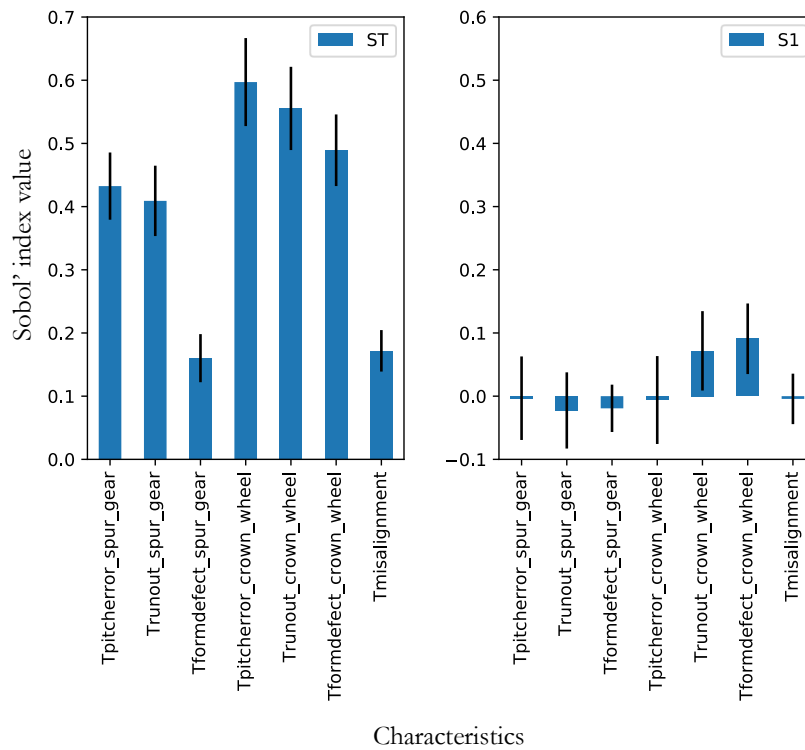

Figure 47. Gears KC identification using Sobol indices

Once the KC is identified, the next step in selective assembly is to distribute the gears between the bins regarding their  $T_{Pitch\ error}$ . In section IV.3.2 several binning methods are proposed, and the associated bins are detailed in Table 17. For instance, if the distribution of the spur gears is applied using BM2, the first bin SB1 contains 257 spur gears with a variation in the range of [1.03, 4.67) ( $\mu\text{m}$ ) on  $T_{Pitch\ error}^{Spur\ gear}$ , the second bin SB2 stores 334 spur gear in range of [4.67, 9.37) ( $\mu\text{m}$ ), and the last bin SB3 holds 409 gear in the range of [9.37, 15.1] ( $\mu\text{m}$ ).

Table 17. Binning methods comparison for the gear pairing

Binning methods	The number of the gears			The variation range of the		
	Bin 1	Bin 2	Bin 3	Bin 1	Bin 2	Bin 3
<b>BM1</b> <sup>Spur gear</sup>	334	333	333	[1.03, 5.82)	[5.82, 10.23)	[10.23, 15.1]
<b>BM2</b> <sup>Spur gear</sup>	257	334	409	[1.03, 4.67)	[4.67, 9.37)	[9.37, 15.1]
<b>BM1</b> <sup>Crown wheel</sup>	334	333	333	[1.03, 9.31)	[9.31, 17.19)	[17.29, 25.08]
<b>BM2</b> <sup>Crown wheel</sup>	264	362	374	[1.03, 8.01)	[8.04, 16.03)	[16.05, 25.08]

Consequently, the gears are distributed into the bins respecting the proposed binning methods and set to be combined. Next, based on the assembly criteria (section IV.3.3), the bins are combined, and the criteria are assessed. **Table 18** details the assessment of the criteria corresponding to each binning method, including the bins' pairing structure. More in detail, if the company prefers to improve the quality by minimizing the KTE value, the optimal decision is to distribute the gears among the existing bins based on method BM1 (section IV.3.2 (a)), and the bins' combination is structured as follows: SB1 is paired with CB2, SB2 is paired with CB1, and SB3 is paired with CB 3. By this structure, on average 710 gears will be paired and the average KTE value of 19.55 ( $\mu\text{m}$ ) is yielded.

**Table 18.** SA binning methods and combination criterion assessment

	Minimize the Mean KTE	Maximize the number of the pairs	Minimize the Inertia
<b><i>BM1</i></b> <i>Spur gear</i> * <b><i>BM1</i></b> <i>Crown wheel</i>	Mean KTE = <b>20.10</b> Number of pairs = <b>710</b> Inertia = <b>23.85</b> Spur class 1 is paired with Crown class 2 Spur class 2 is paired with Crown class 1 Spur class 3 is paired with Crown class 3	Number of pairs = <b>728</b> Mean KTE = <b>20.11</b> Inertia = <b>23.85</b> Spur class 1 is paired with Crown class 3 Spur class 2 is paired with Crown class 2 Spur class 3 is paired with Crown class 1	Inertia = <b>23.85</b> Mean KTE = <b>20.10</b> Number of pairs = <b>710</b> Spur class 1 is paired with Crown class 2 Spur class 2 is paired with Crown class 1 Spur class 3 is paired with Crown class 3
<b><i>BM1</i></b> <i>Spur gear</i> * <b><i>BM2</i></b> <i>Crown wheel</i>	Mean conformity = <b>19.66</b> Number of pairs = <b>666</b> Inertia = <b>23.40</b> Spur class 1 is paired with Crown class 2 Spur class 2 is paired with Crown class 1 Spur class 3 is paired with Crown class 3	Number of pairs = <b>693</b> Mean KTE = <b>19.67</b> Inertia = <b>23.40</b> Spur class 1 is paired with Crown class 3 Spur class 2 is paired with Crown class 2 Spur class 3 is paired with Crown class 1	Inertia = <b>23.40</b> Mean KTE = <b>19.66</b> Number of pairs = <b>666</b> Spur class 1 is paired with Crown class 2 Spur class 2 is paired with Crown class 1 Spur class 3 is paired with Crown class 3
<b><i>BM2</i></b> <i>Spur gear</i> * <b><i>BM1</i></b> <i>Crown wheel</i>	Mean KTE = <b>20.00</b> Number of pairs = <b>653</b> Inertia = <b>23.75</b> Spur class 1 is paired with Crown class 2 Spur class 2 is paired with Crown class 1 Spur class 3 is paired with Crown class 3	Number of pairs = <b>702</b> Mean KTE = <b>20.01</b> Inertia = <b>23.75</b> Spur class 1 is paired with Crown class 3 Spur class 2 is paired with Crown class 2 Spur class 3 is paired with Crown class 1	Inertia = <b>23.75</b> Mean KTE = <b>20.01</b> Number of pairs = <b>702</b> Spur class 1 is paired with Crown class 3 Spur class 2 is paired with Crown class 2 Spur class 3 is paired with Crown class 1
<b><i>BM2</i></b> <i>Spur gear</i> * <b><i>BM2</i></b> <i>Crown wheel</i>	Mean KTE = <b>19.55</b> Number of pairs = <b>617</b> Inertia = <b>23.30</b> Spur class 1 is paired with Crown class 2 Spur class 2 is paired with Crown class 1 Spur class 3 is paired with Crown class 3	Number of pairs = <b>674</b> Mean KTE = <b>19.57</b> Inertia = <b>23.33</b> Spur class 1 is paired with Crown class 1 Spur class 2 is paired with Crown class 3 Spur class 3 is paired with Crown class 2	Inertia = <b>23.30</b> Mean KTE = <b>19.56</b> Number of pairs = <b>663</b> Spur class 1 is paired with Crown class 3 Spur class 2 is paired with Crown class 2 Spur class 3 is paired with Crown class 1

Note: The optimal solutions are faded in  and the mixed solutions are faded .

A more comprehensive glance into the random pairings among the optimal combinations and the evaluation of the overall combinations is provided in **Figure 48** and **Figure 49**. The comparison of the overall KTE values of two mixed solutions MS1 and MS2 can be found in **Figure 48(b)** and **Figure 48(d)**. In the case of dedicated gears pairing, taking solution MS1 to combine the bins optimally results in 728 conformed pairs which the mean KTE value of 20.11( $\mu\text{m}$ ) is obtained. However, if the decision is on improving the quality initially, afterward improving the number of the pairs, taking solution MS2 improves the KTE value slightly to 20.10 ( $\mu\text{m}$ ) but decreases the number of the pairs to 710 pairs. Since solution MS1 doesn't show a great impact on improving the pairing strategy quality, solution MS2 could be a practical decision that maintains a fair quality as well as an optimal number of pairs owing to the mapping of the two solutions MS2 and PNM. Additionally, a comparison of the variety of assembly strategies is illustrated in **Figure 50**.

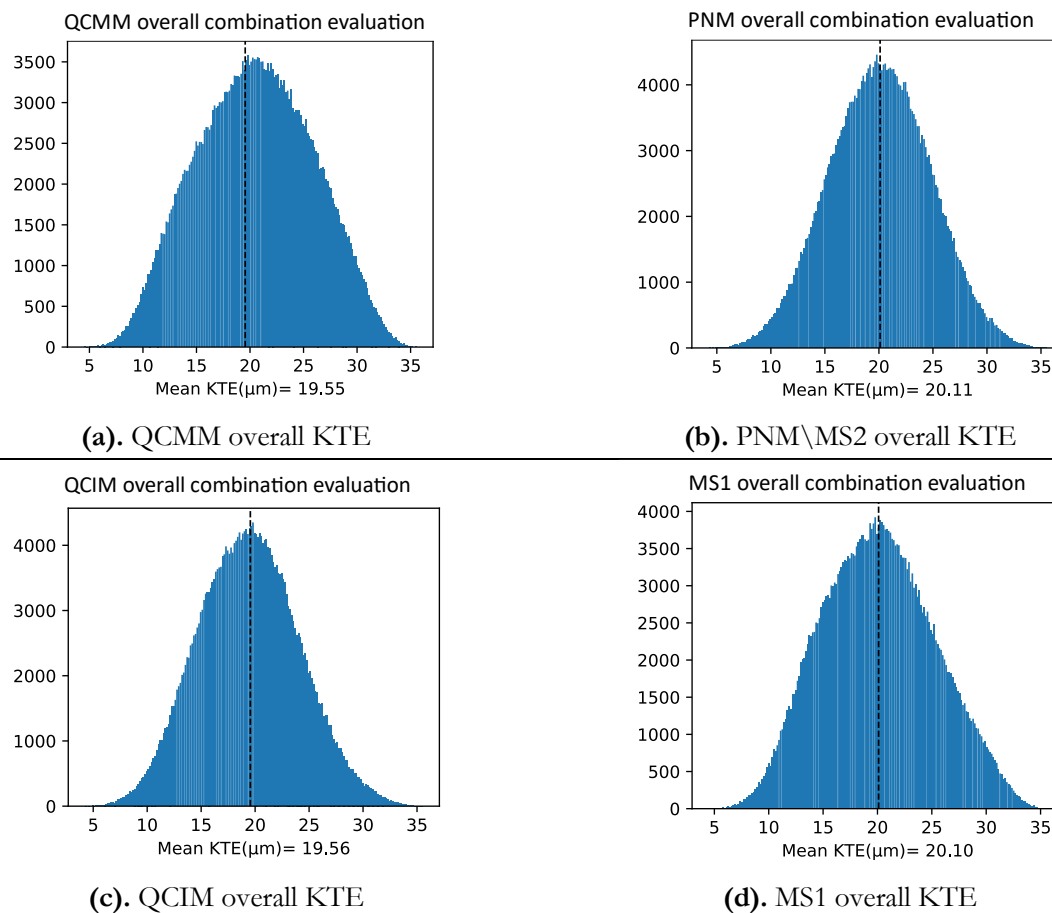

**Figure 48.** Overall combination evaluation for gear pairing

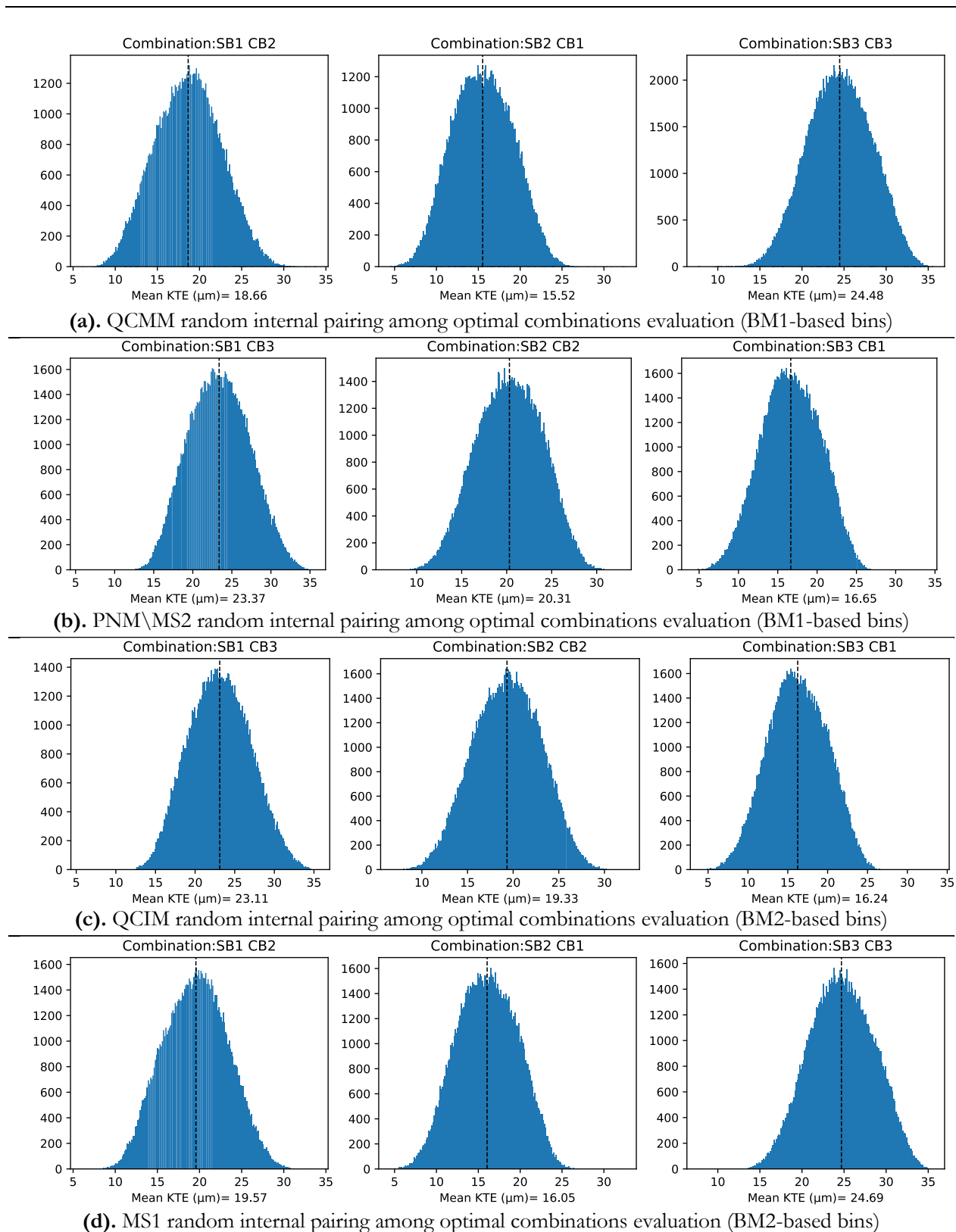

Figure 49. Random internal pairing among optimal combinations

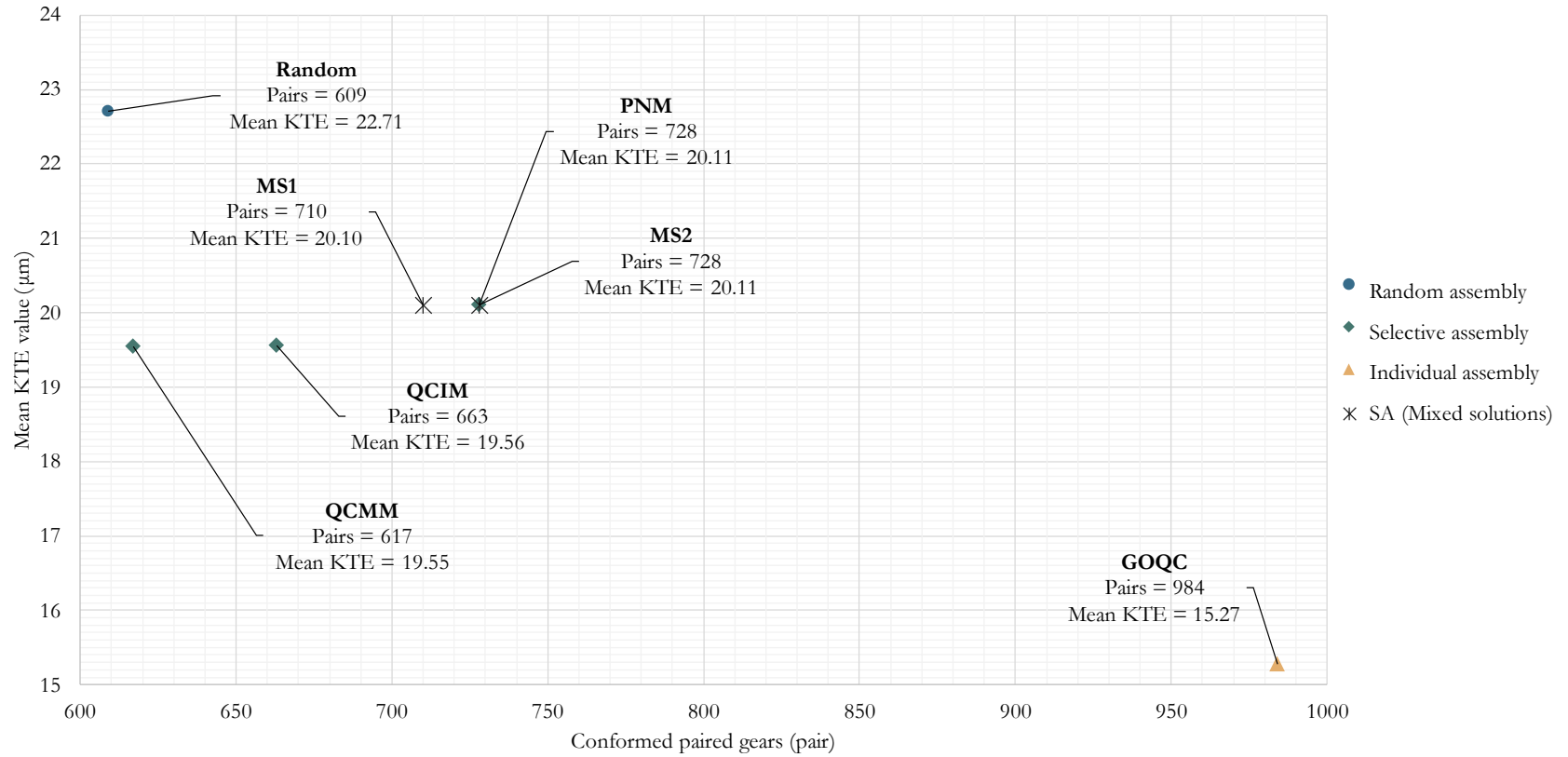

Figure 50. Gears' pairing strategies comparison



## **IV.6. Conclusions**

Assembly is a process to create products that function accurately and reliably, and that meet the tight tolerances and specifications required by various applications, such as in the aerospace, medical, and electronics industries. Assembly can lead to increased efficiency in production processes and can result in product performance efficiency. However, the assembly process may vary depending on the specific requirements for each assembly. The significance of assembly becomes evident in complex assemblies that require a well-defined assembly plan. Therefore, this chapter contributes to the primary definition of an inventive adaptive assembly which receives the tolerance analysis model of the assembly and proposes the fittest strategy by assessing several assembly strategies. Adaptive assembly can be particularly beneficial for high-precision products as it allows manufacturers to quickly adjust the assembly process to optimize for the specific requirements of each product. By adjusting the process, manufacturers can improve the accuracy and consistency of their assembly, which is essential for high-precision products.

Therefore, in this chapter, an adaptive assembly approach is proposed. This approach assesses several assembly strategies for an assembly with specific requirements, evaluates the quality response, and returns the fittest strategy which satisfies the customer\manufacturer the most. The results illustrate the applicability of the approach for a wide range of applications. The analyses of different assemblies demonstrate the importance of assembly strategy investigation where the assembly for an assembly may vary from another. Therefore, the benefits (+) and shortcomings (-) of different assemblies in this research are listed below:

Random assembly:

- + Increased efficiency and productivity, as multiple tasks can be completed simultaneously.
- + Cost savings, as assembly often requires less skill and training than other manufacturing processes.
- + High scalability, as random assembly may be applied for high-volume production runs.
- Limited customization options, as assembly lines are typically designed to produce one specific product or product line.
- Increased risk of non-conformed assemblies.

Selective assembly:

- + Greater flexibility in production, as individual components or subassemblies can be tailored to specific customer needs or market demands.
- + Reduced waste, as only the necessary components are assembled.
- + Increased efficiency and productivity, as assembly can be performed in parallel with other manufacturing processes, such as machining or welding.
- + Improved product quality, as selective assembly allows for more precise and accurate assembly of components.
- Greater complexity in planning and calculation.
- Increased risk of errors and defects, as selective assembly requires more attention to detail and quality control.

Individual assembly:

- + A high degree of customization, as each product can be tailored to the specific needs and preferences of individual customers.
- + Improved product quality, as individual assembly allows for more precise and accurate assembly of components.
- + Increased flexibility in production, as individual assembly can be easily adapted to accommodate changes in customer needs or market demands.
- + Reduced waste, as only the necessary components are assembled.
- Greater complexity in planning and calculation than selective assembly.
- Limited scalability, as individual assembly may not be feasible for high-volume production runs.

(This page left intentionally blank)

## Chapter V: Conclusions and perspectives

---

**W**ith the introduction of new technologies, the need for more complicated products has broadened which impacts the scope of tolerancing. The intricacy and crucial functionality of products are frequently only fulfilled through the use of high-precision components such as micro gears. Therefore, this thesis focused on developing a modular simulation or surrogate-assisted cost-tolerance optimization that integrates several production strategies. The benefits and shortcomings of the proposed model, including the future works to improve the model, are proposed in this section.

---

**Table of Contents**

V.1. Conclusions ..... 133

V.2. Critical limitations..... 136

V.3. Perspectives ..... 137

## **V.1. Conclusions**

The performance of a produced mechanical system is determined by its design, manufacturing, and assembly in the context of internal (e.g., processing material, processing precision, design precision, etc.) and external (e.g., customer requirement, raw material, etc.) conditions. The behavior of assemblies such as micro gears is frequently realized through the use of high-precision components. As a result, manufacturers face high-quality requirements, cost pressure, and an increasing number of defective variants. Therefore, in this thesis, several assemblies are deemed, the functional behaviors are analyzed by various analytical methods, and surrogate models were proposed and developed. The surrogate models are meant to estimate the effects of tolerance and their contributions to the functional behavior of an assembly.

Therefore, this thesis contributes to analyzing intricate assembled systems subject to various errors. The complexity of an assembly arises from the various types of errors and the relationships between them, making it difficult and time-consuming to analyze its functional behavior. To address this challenge, the use of machine learning techniques to develop a more efficient approach is analyzed through the use of AI in tolerance analysis to examine complex systems with numerous geometric errors and dependencies, to accurately predict assembly precision. The concept of this approach requires technical proficiency and powerful computational resources. Nonetheless, the outcome demonstrates a significant improvement in cost-effectiveness and time-saving.

Once, the surrogate model is established, production strategies such as resource allocation, reworking, and assembly strategies are proposed to improve the assembly quality as well as production cost. Following that, the relationships between tolerances, production strategies, and manufacturing cost should be identified. A novel framework consisting of a cost-activity model is then proposed in order to assess the minimum manufacturing cost while ensuring the quality level. Identifying specifications in the production process that have a high cost and low tolerance enables manufacturers to make improvements in these areas and decrease costs by finding an optimal balance between cost and tolerance and thus adapting the design. The modular structure of the model associates each module or stage of the production process with its impact on the assembly or components, providing a systematic and organized approach to analyzing and optimizing the manufacturing process. Also, the model associates allocated tolerances and production strategies with the conformity rates of the components using surrogate models and it evaluates the corresponding manufacturing cost.

On these bases, the contributions of the thesis which respond to the are concluded as follows and illustrated in **Figure 51**:

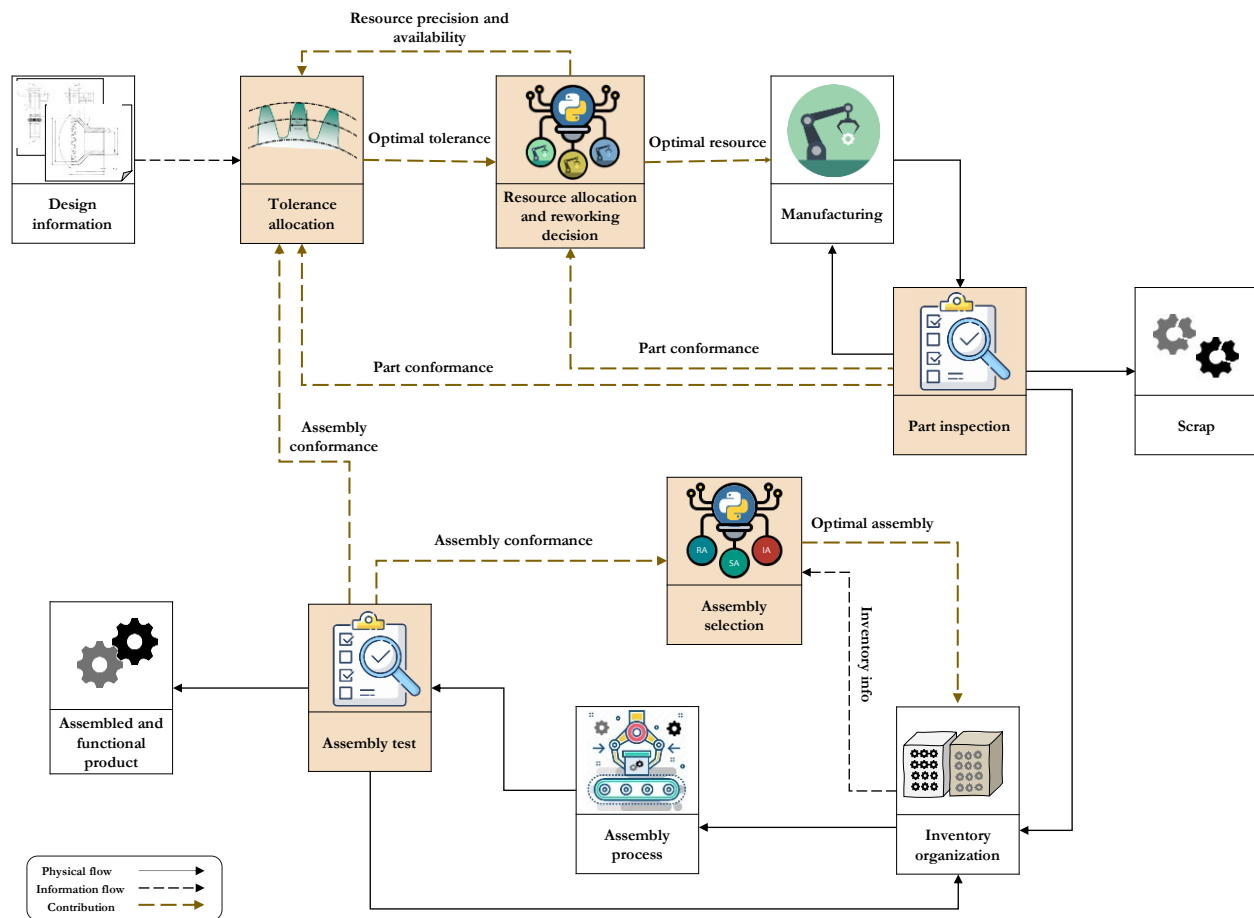

**Figure 51.** Thesis's established framework and contributions

**Various scientific questions have been addressed in this work:**

**Question 1:** What is the methodology for creating a reliable product through the implementation of adaptive tolerancing and mitigating uncertainties?

**Contribution 1:** *In Chapter II, this work examines the process of establishing specialized surrogate models for various assemblies which involves creating models simulating the behavior and performance of assemblies. These models can be analyzed using a range of analytical techniques to evaluate the assembly behavior and quality response. The outcome of the analysis can be represented as conformity rates, which are a measure of how well the assembly meets desired specifications. The conformity rates can then be incorporated into a decision tool model, which can be used to make informed decisions regarding assembly strategies and techniques. The use of specialized surrogate models and*

*analytical techniques in this manner allows for a more comprehensive and data-driven approach to assess assembly behavior and its quality response.*

**Question 2:** What is the most efficient way of adjusting tolerance in the realm of adaptive tolerance allocation, considering the application of multiple production strategies?

**Contribution 2:** *In Chapter III, production strategies (i.e. resource allocation, reworking, and assembly selection) are proposed to improve components and assembly manufacturing cost as well as quality. Cost-tolerance optimization model receives production strategies and associated inspection feedback. Afterward, it allocates cost-efficient tolerances to the components. Each strategy is proposed to improve the assembly at certain stages which are summarized as follows:*



- *Resource allocation: this decision can be taken before the stage components are manufactured. The optimization receives available resources' process deviations and locates the optimal tolerances and resources while minimizing manufacturing cost and assuring functional requirements.*
- *Reworking: this activity can help to improve a rejected component's quality by bringing it back to the processing line and performing reworking on the component. However, reworking applies to the rejected component if non-conformed characteristics lie in the reworking domain pre-defined by the designer. It helps decrease the scrap cost and increase component conformity.*
- *Assembly selection: this strategy assesses the quality response of several assembly approaches such as random assembly, selective assembly, and individual assembly. Afterward, it selects the strategy which grants the best quality response.*

**Question 3:** What is the effect of incorporating adaptive assembly approaches on the enhancement of assembly quality within production?

**Contribution 3:** *The adaptive assembly approach is proposed in Chapter IV, a method to evaluate the quality of output produced by different assembly strategies. These assembly strategies can include random assembly, selective assembly, and individual assembly. The goal of the adaptive assembly approach is to determine the best strategy for a specific assembly, based on the quality of the output produced by each strategy. By assessing the quality response related to each assembly strategy, the adaptive assembly approach helps identify the strategy that is most suitable for a particular assembly situation.*

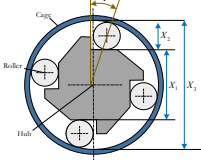
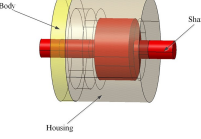

**Table 19.** A brief review of the applications and implementations

Case study	Tolerance allocation	Resource allocation	Reworking	Assembly comparison	Tolerance analysis technique	Optimization method
	Done	Done	Done	Random	Simulation	GA
	Done	Done	Done	Random Vs. Selective Vs. Individual	Simulation & Surrogate	GA
	Done	NA	NA	Random Vs. Selective Vs. Individual	Surrogate	GA, SaDE

NA = Not applicable

Based on these considerations, several case studies are proposed to address the scientific questions. The purpose of the case studies proposed in this context is to address and answer scientific questions that have arisen. The results of the case studies are presented in **Table 19** to facilitate analysis and interpretation.

## V.2. Critical limitations

The development of the surrogate, cost-tolerance models and production strategies in this thesis is performed under several assumptions, to reduce the complexities and to be more relevant to the suggested case studies (linear, non-linear, complex geometry). The limitations are listed:

- (1) Material removal (or subtractive) processes are one of the main technical assumptions in the mathematical model development of the tolerance analysis and rework strategy implementation. A non-conformed product considers reworkable if associated features have enough material to be removed and reach the pre-defined design. Since, operating additive processes such as Fused Deposition Modeling (FDM), Stereolithography (SLA), Selective Laser Sintering (SLS), and Direct Energy Deposition (DED), etc. increases the complexity of

the mathematical development of the tolerance analysis model, therefore, material removal processes are only considered.

- (2) In many real-world applications, the input data is subject to uncertainty. Traditional optimization methods aim to find the optimal solution for a specific set of input data but may fail when the actual input data differs from the assumed data. Therefore, in this thesis, for sake of simplicity and application, the relevant cost input data are assumed to be fixed.
- (3) The presence of uncertainty is a byproduct of the development of the surrogate models, and its existence is recognized and taken into consideration throughout the entire model development process. The presence of uncertainty can arise from many sources, such as measurement errors, imprecise model parameters, or incomplete data. It is an inherent aspect of many real-world systems and processes, and it is often important to quantify and understand the uncertainty in order to make informed decisions and draw accurate conclusions.
- (4) The proposed assembly strategies are proposed under certain limits due to time-consuming and deep computations. As an example, optimal yielded combinations in selective assembly would combine the specified bins, therefore, in case one bin related to one type of component runs out of components the other bins related to another type of component will store the redundant component for the next production.

### **V.3. Perspectives**

The limitations of this study play a crucial role in shaping the direction of future works. These limitations identify the factors that constrained the research and indicate the areas where further investigations or improvements are needed. The following list outlines the future works of this study:

- (1) New products and technologies are more orienting to additive processes and manufacturing which is expected to bring significant advancements and improvements in areas such as materials, speed, precision, and scalability. Therefore, an interesting technical issue that can be taken as a perspective is the implementation of additive processes and the associated impacts of statistical assessment.
- (2) In the field of tolerancing, uncertainty can have a significant impact on the accuracy of predictions and the efficiency of the manufacturing process, making it an important area of study and investigation. This uncertainty results in a region of uncertainty that encompasses

the tolerancing domain, as depicted in **Figure 52**. This figure highlights the significance of addressing and reducing uncertainty, which can be considered a critical area of scientific investigation in the field of tolerancing in future research. The demonstration of the impact of uncertainty on the development of the model underscores the importance of considering and addressing this factor in future studies.

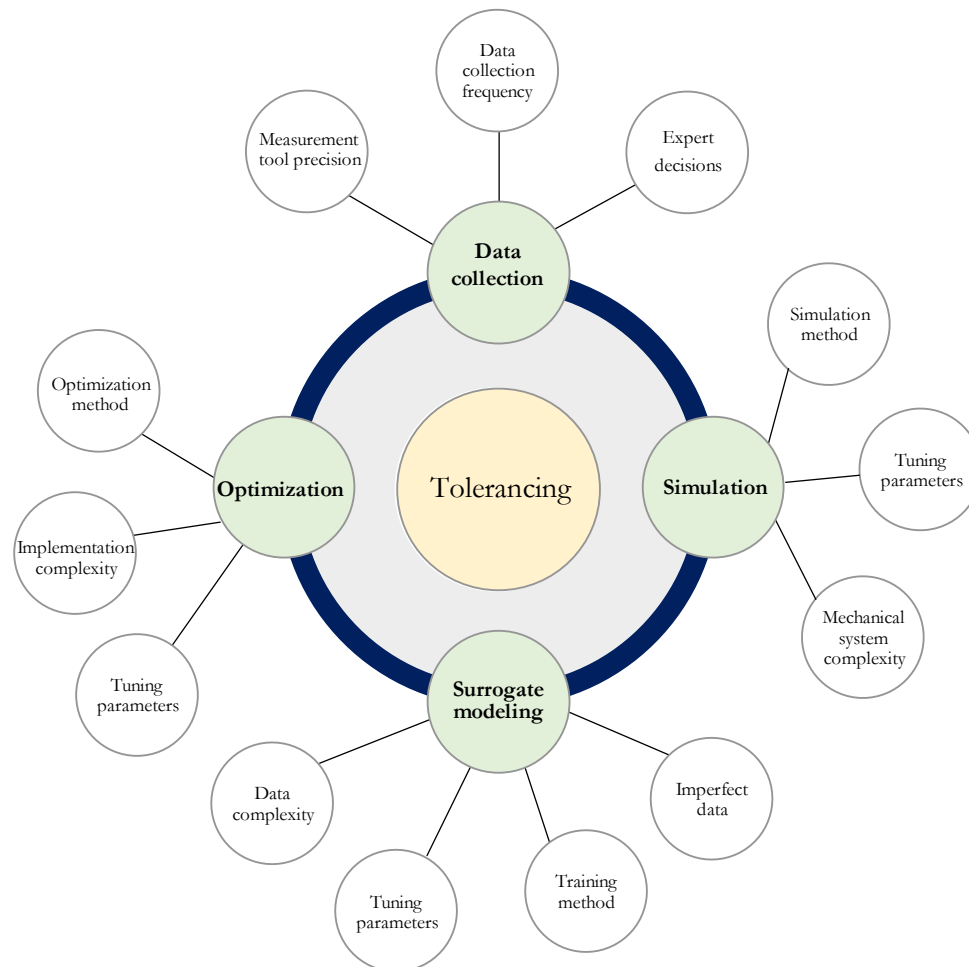

**Figure 52.** uncertainty in the tolerancing field

- (3) Robust optimization techniques take into account uncertainties in the input data and aim to find a solution that performs well under a variety of possible scenarios. This is achieved by formulating the optimization problem as a minimax problem, where the objective is to minimize the worst-case scenario. Several methods can be used for robust optimization, depending on the nature of the uncertain parameter and the constraints of the optimization problem. Here are some examples of robust optimization methods: Robust linear

programming (RLP), Robust quadratic programming (RQP), Robust semidefinite programming (RSDP), etc.

- (4) In this thesis, the surrogate model is used to estimate the assembly conformity of mechanisms under different operating conditions and to identify the design parameters that are most sensitive to variations. Using physics-based surrogate modeling in tolerance analysis incorporates the physics of the system, as well as the manufacturing and environmental variations that affect its performance. This surrogate model can then be used to perform simulations and optimizations, enabling engineers to quickly identify the most promising design configurations.
- (5) For future work of the assembly, an enhancement of the selective approach can be to improve combinations in which the unpaired components can be combined with other bins in a way that quality responses don't drop. Furthermore, since GOQC originated from Kuhn–Munkres algorithm, it has been proved that the complexity of the problem increases quickly with the dimensionality of the problem. Consequently, the approach can be adapted for solving high-dimensional assignment problems using appropriate heuristic or meta-heuristic approaches.

(This page left intentionally blank)

## References

- Andolfatto, L., Thiébaud, F., Lartigue, C., & Douilly, M. (2014). Quality-and cost-driven assembly technique selection and geometrical tolerance allocation for mechanical structure assembly. *Journal of Manufacturing Systems*, 33(1), 103-115. <https://doi.org/10.1016/j.jmsy.2013.03.003>
- Anselmetti, B. (2006). Generation of functional tolerancing based on positioning features. *Computer-Aided Design*, 38(8), 902-919. <https://doi.org/10.1016/j.cad.2006.05.005>
- Anwer, N., Ballu, A., & Mathieu, L. (2013). The skin model, a comprehensive geometric model for engineering design. *CIRP Annals*, 62(1), 143-146. <https://doi.org/10.1016/j.cirp.2013.03.078>
- Armillotta, A. (2020a). Selection of parameters in cost-tolerance functions: review and approach. *The International Journal of Advanced Manufacturing Technology*, 108(1-2), 167-182.
- Armillotta, A. (2020b). Selection of parameters in cost-tolerance functions: review and approach. *The International Journal of Advanced Manufacturing Technology*, 108(1), 167-182. <https://doi.org/10.1007/s00170-020-05400-z>
- Armillotta, A. (2022). An extended form of the reciprocal-power function for tolerance allocation. *The International Journal of Advanced Manufacturing Technology*, 119(11-12), 8091-8104. <https://doi.org/10.1007/s00170-021-08579-x>
- Asha, A., Kannan, S., & Jayabalan, V. (2008). Optimization of clearance variation in selective assembly for components with multiple characteristics. *The International Journal of Advanced Manufacturing Technology*, 38(9), 1026-1044. <https://doi.org/10.1007/s00170-007-1136-3>
- Babu, J. R., & Asha, A. (2014). Tolerance modelling in selective assembly for minimizing linear assembly tolerance variation and assembly cost by using Taguchi and AIS algorithm. *The International Journal of Advanced Manufacturing Technology*, 75(5), 869-881. <https://doi.org/10.1007/s00170-014-6097-8>
- Beaucaire, P., Gayton, N., Duc, E., & Dantan, J.-Y. (2013). Statistical tolerance analysis of over-constrained mechanisms with gaps using system reliability methods. *Computer-Aided Design*, 45(12), 1547-1555.
- Bjørke, Ø. (1978). *Computer-aided tolerancing*. Tapir.
- Breiman, L., Friedman, J. H., Olshen, R. A., & Stone, C. J. (2017). *Classification and regression trees*. Routledge.
- Brest, J., Bošković, B., Greiner, S., Žumer, V., & Maučec, M. S. (2007). Performance comparison of self-adaptive and adaptive differential evolution algorithms. *Soft Computing*, 11(7), 617-629. <https://doi.org/10.1007/s00500-006-0124-0>
- Bruyere, J., Dantan, J.-Y., Bigot, R., & Martin, P. (2007). Statistical tolerance analysis of bevel gear by tooth contact analysis and Monte Carlo simulation. *Mechanism and Machine Theory*, 42(10), 1326-1351. <https://doi.org/10.1016/j.mechmachtheory.2006.11.003>
- Caputo, A. C., & Di Salvo, G. (2019). An economic decision model for selective assembly. *International Journal of Production Economics*, 207, 56-69. <https://doi.org/10.1016/j.ijpe.2018.11.004>
- Cardew-Hall, M., Labans, T., West, G., & Dench, P. (1993). A method of representing dimensions and tolerances on solid based freeform surfaces. *Robotics and Computer-Integrated Manufacturing*, 10(3), 223-234. [https://doi.org/10.1016/0736-5845\(93\)90057-Q](https://doi.org/10.1016/0736-5845(93)90057-Q)
- Ceglarek, D., & Shi, J. (1995). Dimensional variation reduction for automotive body assembly. *Manufacturing Review*, 8(2).

- Chan, K. C., & Linn, R. J. (1998). A grouping method for selective assembly of parts of dissimilar distributions. *Quality Engineering*, 11(2), 221-234. <https://doi.org/10.1080/08982119808919233>
- Chase, K. W., Greenwood, W. H., Loosli, B. G., & Hauglund, L. F. (1990). Least cost tolerance allocation for mechanical assemblies with automated process selection. *Manufacturing Review*, 3(1), 49-59.
- Chen, H., Jin, S., Li, Z., & Lai, X. (2014). A comprehensive study of three dimensional tolerance analysis methods. *Computer-Aided Design*, 53, 1-13. <https://doi.org/10.1016/j.cad.2014.02.014>
- Chen, H., Jin, S., Li, Z., & Lai, X. (2015). A modified method of the unified Jacobian-Torsor model for tolerance analysis and allocation. *International Journal of Precision Engineering and Manufacturing*, 16(8), 1789-1800. <https://doi.org/10.1007/s12541-015-0234-7>
- Chollet, F. (2015). keras. In.
- Chou, C.-Y., & Chang, C.-L. (2001). Minimum-loss assembly tolerance allocation by considering product degradation and time value of money. *The International Journal of Advanced Manufacturing Technology*, 17(2), 139-146. <https://doi.org/10.1007/s001700170202>
- Clement, A., & Riviere, A. (1993). *Tolerancing versus nominal modeling in next generation CAD/CAM system*. Paper presented at the Proceedings of 3rd CIRP Seminar on Computer Aided Tolerancing.
- Clottey, T., & Benton Jr, W. (2020). Sharing quality-distribution information for the selective assembly of intermediary components in the automotive industry. *Production and Operations Management*, 29(1), 174-191. <https://doi.org/10.1111/poms.13094>
- Corlew, G., & Oakland, F. (1976). Monte-Carlo simulation for setting dimensional tolerances. *Machine Design*, 48(11), 91-95.
- Coullard, C. R., Gamble, A., & Jones, P. (1998). Matching problems in selective assembly operations. *Annals of Operations Research*, 76, 95-107. <https://doi.org/10.1023/A:1018960924601>
- Cui, L.-j., Sun, M.-y., Cao, Y.-l., Zhao, Q.-j., Zeng, W.-h., & Guo, S.-r. (2021). A novel tolerance geometric method based on machine learning. *Journal of Intelligent Manufacturing*, 32(3), 799-821. <https://doi.org/10.1007/s10845-020-01706-7>
- Dantan, J.-Y., Bruyere, J., Vincent, J.-P., & Bigot, R. (2008). Vectorial tolerance allocation of bevel gear by discrete optimization. *Mechanism and Machine Theory*, 43(11), 1478-1494. <https://doi.org/10.1016/j.mechmachtheory.2007.11.002>
- Dantan, J.-Y., Etienne, A., Mohammadi, M., Khezri, A., Homri, L., Tavakkoli-Moghaddam, R., & Siadat, A. (2022). Modular cost model for Tolerance allocation, Process selection and Inspection planning. *Procedia CIRP*, 114, 1-6. <https://doi.org/10.1016/j.procir.2022.10.001>
- Dantan, J.-Y., Gayton, N., Etienne, A., & Qureshi, A. J. (2012). Mathematical issues in mechanical tolerance analysis.
- Davidson, J., Mujezinovic, A., & Shah, J. (2002). A new mathematical model for geometric tolerances as applied to round faces. *J. Mech. Des.*, 124(4), 609-622. <https://doi.org/10.1115/1.1497362>
- Delos, V., & Teissandier, D. (2014). Minkowski sum of polytopes defined by their vertices. *arXiv preprint arXiv:1412.2564*. <https://doi.org/10.4236/jamp.2015.31008>
- Desmond, D., & Setty, C. (1961). Simplification of selective assembly. *International Journal of Production Research*, 1(3), 3-18. <https://doi.org/10.1080/00207546108943085>

- Desrochers, A., & Clément, A. (1994). A dimensioning and tolerancing assistance model for CAD/CAM systems. *The International Journal of Advanced Manufacturing Technology*, 9(6), 352-361. <https://doi.org/10.1007/BF01748479>
- Distler, R. (1977). Monte Carlo analysis of system tolerance. *IEEE Transactions on Education*, 20(2), 98-101. <https://doi.org/10.1109/TE.1977.4321121>
- Dong, Z., Hu, W., & Xue, D. (1994a). New production cost-tolerance models for tolerance synthesis. *Journal of Engineering for Industry*, 116(2), 199-206. <https://doi.org/10.1115/1.2901931>
- Dong, Z., Hu, W., & Xue, D. (1994b). New production cost-tolerance models for tolerance synthesis. <https://doi.org/10.1115/1.2901931>
- Drake, P. J. (1999). *Dimensioning and tolerancing handbook*: McGraw-Hill New York.
- Du, Z., Wu, J., & Yang, J. (2017). *Modified Jacobian-Torsor Based Error Modeling and Quantitative Sensitivity Analysis for Single Axis Assembly of Machine Tool*. Paper presented at the ASME 2017 International Design Engineering Technical Conferences and Computers and Information in Engineering Conference. <https://doi.org/10.1115/DETC2017-67716>
- Dumas, A., Dantan, J.-Y., & Gayton, N. (2015). Impact of a behavior model linearization strategy on the tolerance analysis of over-constrained mechanisms. *Computer-Aided Design*, 62, 152-163. <https://doi.org/10.1016/j.cad.2014.11.002>
- Etienne, A., Dantan, J.-Y., Qureshi, J., & Siadat, A. (2008). Variation management by functional tolerance allocation and manufacturing process selection. *International Journal on Interactive Design and Manufacturing (IJIDeM)*, 2(4), 207-218. <https://doi.org/10.1007/s12008-008-0055-3>
- Etienne, A., Dantan, J.-Y., Siadat, A., & Martin, P. (2009). Activity-Based Tolerance Allocation (ABTA)—driving tolerance synthesis by evaluating its global cost. *International Journal of Production Research*, 47(18), 4971-4989. <https://doi.org/10.1080/00207540701819225>
- Fang, X., & Zhang, Y. (1995). A new algorithm for minimising the surplus parts in selective assembly. *Computers & industrial engineering*, 28(2), 341-350. [https://doi.org/10.1016/0360-8352\(94\)00183-N](https://doi.org/10.1016/0360-8352(94)00183-N)
- Feng, C.-X., & Kusiak, A. (1997). Robust tolerance design with the integer programming approach. *Journal of Manufacturing Science and Engineering*, 119(4A), 603-610. <https://doi.org/10.1115/1.2831193>
- Fernández, A., García, S., Herrera, F., & Chawla, N. V. (2018). SMOTE for learning from imbalanced data: progress and challenges, marking the 15-year anniversary. *Journal of artificial intelligence research*, 61, 863-905. <https://doi.org/10.1613/jair.1.11192>
- Ferrer, G., & Ayres, R. U. (2000). The impact of remanufacturing in the economy. *Ecological Economics*, 32(3), 413-429. [https://doi.org/10.1016/S0921-8009\(99\)00110-X](https://doi.org/10.1016/S0921-8009(99)00110-X)
- Fortini, E. T. (1967). *Dimensioning for interchangeable manufacture*: Industrial Press.
- Franciosa, P., Gerbino, S., & Patalano, S. (2011). Simulation of variational compliant assemblies with shape errors based on morphing mesh approach. *The International Journal of Advanced Manufacturing Technology*, 53(1-4), 47-61. <https://doi.org/10.1007/s00170-010-2839-4>
- Freund, Y., & Schapire, R. E. (1997). A decision-theoretic generalization of on-line learning and an application to boosting. *Journal of computer and system sciences*, 55(1), 119-139. <https://doi.org/10.1006/jcss.1997.1504>
- Gao, J., Chase, K. W., & Magleby, S. P. (1995). *Comparison of assembly tolerance analysis by the direct linearization and modified Monte Carlo simulation methods*. Paper presented at the International



- Design Engineering Technical Conferences and Computers and Information in Engineering Conference. <https://doi.org/10.1115/DETC1995-0047>
- Goethals, P. L., & Cho, B. R. (2012). Designing the optimal mean for an asymmetrically distributed process. *International Journal of Productivity and Quality Management*, 9(1), 82-102. <https://doi.org/10.1504/IJPQM.2012.044013>
- Goka, E., Beaurepaire, P., Homri, L., & Dantan, J.-Y. (2019a). Probabilistic-based approach using Kernel Density Estimation for gap modeling in a statistical tolerance analysis. *Mechanism and Machine Theory*, 139, 294-309. <https://doi.org/10.1016/j.mechmachtheory.2019.04.020>
- Goka, E., Homri, L., Beaurepaire, P., & Dantan, J.-Y. (2019b). Statistical tolerance analysis of over-constrained mechanical assemblies with form defects considering contact types. *Journal of Computing and Information Science in Engineering*, 19(2). <https://doi.org/10.1115/1.4042018>
- Goldberger, J., Hinton, G. E., Roweis, S., & Salakhutdinov, R. R. (2004). Neighbourhood components analysis. *Advances in neural information processing systems*, 17.
- Grandjean, J., Ledoux, Y., & Samper, S. (2013). On the role of form defects in assemblies subject to local deformations and mechanical loads. *The International Journal of Advanced Manufacturing Technology*, 65(9-12), 1769-1778. <https://doi.org/10.1007/s00170-012-4298-6>
- Greenwood, W., & Chase, K. (1987). A new tolerance analysis method for designers and manufacturers. *Journal of Engineering for Industry*, 109(2), 112-116. <https://doi.org/10.1115/1.3187099>
- Groover, M. P. (2020). *Fundamentals of modern manufacturing: materials, processes, and systems*: John Wiley & Sons.
- Gurumani, R., & Shanmugam, S. (2011). Modeling and contact analysis of crowned spur gear teeth. *Engineering Mechanics*, 18(1), 65-78.
- Hallmann, M., Schleich, B., & Wartzack, S. (2020a). From tolerance allocation to tolerance-cost optimization: A comprehensive literature review. *The International Journal of Advanced Manufacturing Technology*, 107(11), 4859-4912. <https://doi.org/10.1007/s00170-020-05254-5>
- Hallmann, M., Schleich, B., & Wartzack, S. (2020b). How to consider Over-constrained Assemblies with Gaps in Tolerance-Cost Optimization? *Procedia CIRP*, 92, 88-93. <https://doi.org/10.1016/j.procir.2020.05.168>
- Hallmann, M., Schleich, B., & Wartzack, S. (2021). Process and machine selection in sampling-based tolerance-cost optimisation for dimensional tolerancing. *International Journal of Production Research*, 60(17), 5201-5216. <https://doi.org/10.1080/00207543.2021.1951867>
- Han, Y., Tu, Y., Ouyang, L., Wang, J., & Ma, Y. (2022). Economic quality design under model uncertainty in micro-drilling manufacturing process. *International Journal of Production Research*, 60(3), 1086-1104. <https://doi.org/10.1080/00207543.2020.1851792>
- He, J. (1991). Estimating the distributions of manufactured dimensions with the beta probability density function. *International Journal of Machine Tools and Manufacture*, 31(3), 383-396. [https://doi.org/10.1016/0890-6955\(91\)90083-F](https://doi.org/10.1016/0890-6955(91)90083-F)
- Head, T., Kumar, M., Nahrstaedt, H., Louppe, G., & Shcherbatyi, I. (2020). Scikit-optimize/scikit-optimize. (version 0.8. 1).
- Hillyard, R., & Braid, I. (1978). Analysis of dimensions and tolerances in computer-aided mechanical design. *Computer-Aided Design*, 10(3), 161-166. [https://doi.org/10.1016/0010-4485\(78\)90140-2](https://doi.org/10.1016/0010-4485(78)90140-2)
- Hinton, G. E., Osindero, S., & Teh, Y.-W. (2006). A fast learning algorithm for deep belief nets. *Neural computation*, 18(7), 1527-1554. <https://doi.org/10.1162/neco.2006.18.7.1527>

- Ho, T. K. (1998). The random subspace method for constructing decision forests. *IEEE transactions on pattern analysis and machine intelligence*, 20(8), 832-844. <https://doi.org/10.1109/34.709601>
- Homri, L., Goka, E., Levasseur, G., & Dantan, J.-Y. (2017). Tolerance analysis—form defects modeling and simulation by modal decomposition and optimization. *Computer-Aided Design*, 91, 46-59. <https://doi.org/10.1016/j.cad.2017.04.007>
- Homri, L., Teissandier, D., & Ballu, A. (2015). Tolerance analysis by polytopes: Taking into account degrees of freedom with cap half-spaces. *Computer-Aided Design*, 62, 112-130. <https://doi.org/10.1016/j.cad.2014.11.005>
- Hong, Y., & Chang, T. (2002). A comprehensive review of tolerancing research. *International Journal of Production Research*, 40(11), 2425-2459. <https://doi.org/10.1080/00207540210128242>
- Irani, S. A., Mittal, R. O., & Lehtihet, E. A. (2007). Tolerance chart optimization. *International Journal of Production Research*, 27(9), 1531-1552. <https://doi.org/10.1080/00207548908942638>
- Jaballi, K., Bellacicco, A., Louati, J., Riviere, A., & Haddar, M. (2011). Rational method for 3D manufacturing tolerancing synthesis based on the TTRS approach “R3DMTSyn”. *Computers in industry*, 62(5), 541-554. <https://doi.org/10.1016/j.compind.2011.02.003>
- Jayaraman, R., & Srinivasan, V. (1989). Geometric tolerancing: I. Virtual boundary requirements. *IBM Journal of Research and Development*, 33(2), 90-104. <https://doi.org/10.1147/rd.332.0090>
- Jeevanantham, A., & Kannan, S. (2013). Selective assembly to minimize clearance variation in complex assemblies using fuzzy evolutionary programming method. *ARPJ Journal of Engineering and Applied Sciences*, 8(4), 280-289.
- Ji, S., Li, X., Ma, Y., & Cai, H. (2000). Optimal tolerance allocation based on fuzzy comprehensive evaluation and genetic algorithm. *The International Journal of Advanced Manufacturing Technology*, 16(7), 461-468. <https://doi.org/10.1007/s001700070053>
- John, G. H., & Langley, P. (1995). *Estimating continuous distributions in Bayesian classifiers*. Paper presented at the Proceedings of the Eleventh conference on Uncertainty in artificial intelligence, Montréal, Qué, Canada. <https://doi.org/10.48550/arXiv.1302.4964>
- Kannan, S., & Jayabalan, V. (2001). A new grouping method to minimize surplus parts in selective assembly for complex assemblies. *International Journal of Production Research*, 39(9), 1851-1863. <https://doi.org/10.1080/00207540110035219>
- Kannan, S., Jayabalan, V., & Jeevanantham, K. (2003). Genetic algorithm for minimizing assembly variation in selective assembly. *International Journal of Production Research*, 41(14), 3301-3313. <https://doi.org/10.1080/0020754031000109143>
- Kannan, S., Sivasubramanian, R., & Jayabalan, V. (2009). A new method in selective assembly for components with skewed distributions. *International Journal of Productivity and Quality Management*, 4(5-6), 569-589. <https://doi.org/10.1504/IJPQM.2009.025186>
- Kannan, S. M., Asha, A., & Jayabalan, V. (2005). A new method in selective assembly to minimize clearance variation for a radial assembly using genetic algorithm. *Quality Engineering*, 17(4), 595-607. <http://doi.org/10.1080/08982110500225398>
- Kern, D. C. (2003). *Forecasting manufacturing variation using historical process capability data: applications for random assembly, selective assembly, and serial processing*. Citeseer, Retrieved from <http://hdl.handle.net/1721.1/29960>
- Khezri, A., Homri, L., Etienne, A., & Dantan, J.-Y. (2022a). *An integrated resource allocation and tolerance allocation optimization: A statistical-based dimensional tolerancing*. Paper presented at the 17th CIRP Conference on Computer Aided Tolerancing (CAT 2022, Metz, France). <https://doi.org/10.1016/j.procir.2022.10.012>

- Khezri, A., Homri, L., Etienne, A., & Dantan, J.-Y. (2023a). Hybrid Cost-Tolerance Allocation and Production Strategy Selection for Complex Mechanisms: Simulation and Surrogate Built-In Optimization Models. *Journal of Computing and Information Science in Engineering*, 1-20. <https://doi.org/10.1115/1.4056687>
- Khezri, A., Homri, L., Etienne, A., Dantan, J.-Y., & Lanza, G. (2022b). *A Framework for Integration of Resource Allocation and Reworking Concept into Design Optimisation Problem*. Paper presented at the Proceeding of the 10th IFAC Conference on Manufacturing Modelling, Management and Control (MIM 2022, Nantes, France). <https://doi.org/10.1016/j.ifacol.2022.09.524>
- Khezri, A., Schiller, V., Goka, E., Homri, L., Etienne, A., Stamer, F., Dantan, J.-Y., & Lanza, G. (2023b). Evolutionary Cost-Tolerance Optimization for Complex Assembly Mechanisms Via Simulation and Surrogate Modeling Approaches: Application on Micro Gears. <https://doi.org/10.21203/rs.3.rs-2487746/v1>
- Khezri, A., Schiller, V., Homri, L., Etienne, A., Dantan, J.-Y., & Lanza, G. (2023c). Development and analysis of a holistic function-driven adaptive assembly strategy applied to micro gears. *Journal of Manufacturing Systems*, 69, 48-63. <https://doi.org/10.1016/j.jmsy.2023.06.003>
- Kramer, G. A. (1992). *Solving geometric constraint systems: a case study in kinematics*. MIT press.
- Lachhwani, K., & Dwivedi, A. (2018). Bi-level and multi-level programming problems: taxonomy of literature review and research issues. *Archives of Computational Methods in Engineering*, 25(4), 847-877. <https://doi.org/10.1007/s11831-017-9216-5>
- Lanza, G., Haefner, B., & Kraemer, A. (2015). Optimization of selective assembly and adaptive manufacturing by means of cyber-physical system based matching. *CIRP Annals*, 64(1), 399-402. <https://doi.org/10.1016/j.cirp.2015.04.123>
- Laperrière, L., & Lafond, P. (1999). *Modeling tolerances and dispersions of mechanical assemblies using virtual joints*. Paper presented at the CD-ROM proceedings of 25th ASME design automation conference. <https://doi.org/10.1115/DETC99/DAC-8702>
- Law, A. M., & Kelton, W. D. (2000). Building valid, credible, and appropriately detailed simulation models. *Simulation Modeling and Analysis*. 3rd ed. Singapore: McGraw-Hill, 264-291.
- Lê, H.-N., Ledoux, Y., & Ballu, A. (2014). Experimental and theoretical investigations of mechanical joints with form defects. *Journal of Computing and Information Science in Engineering*, 14(4). <https://doi.org/10.1115/1.4028195>
- Lecompte, J., Legoff, O., & Hascoet, J.-Y. (2010). Technological form defects identification using discrete cosine transform method. *The International Journal of Advanced Manufacturing Technology*, 51(9-12), 1033-1044. <https://doi.org/10.1007/s00170-010-2687-2>
- Lee, C.-K. (2009). Manufacturing process for a cylindrical crown gear drive with a controllable fourth order polynomial function of transmission error. *Journal of Materials Processing Technology*, 209(1), 3-13. <https://doi.org/10.1016/j.jmatprotec.2008.03.065>
- Lee, J., & Johnson, G. E. (1993). Optimal tolerance allotment using a genetic algorithm and truncated Monte Carlo simulation. *Computer-Aided Design*, 25(9), 601-611. [https://doi.org/10.1016/0010-4485\(93\)90075-Y](https://doi.org/10.1016/0010-4485(93)90075-Y)
- Lee, Y.-H., Wei, C.-C., Chen, C.-B., & Tsai, C.-H. (2000). Minimization of scrap and rework costs by process tolerances allocation. *Engineering Optimization*, 32(5), 619-633. <https://doi.org/10.1080/03052150008941315>
- Li, G., Wang, Z., Zhu, W., & Kubo, A. (2017). A function-oriented active form-grinding method for cylindrical gears based on error sensitivity. *The International Journal of Advanced Manufacturing Technology*, 92(5), 3019-3031. <https://doi.org/10.1007/s00170-017-0363-5>

- Li, H., Zhu, H., Zhou, X., Li, P., & Yu, Z. (2016). A new computer-aided tolerance analysis and optimization framework for assembling processes using DP-SDT theory. *The International Journal of Advanced Manufacturing Technology*, 86(5-8), 1299-1310. <https://doi.org/10.1007/s00170-015-8266-9>
- Light, R., & Gossard, D. (1982). Modification of geometric models through variational geometry. *Computer-Aided Design*, 14(4), 209-214. [https://doi.org/10.1016/0010-4485\(82\)90292-5](https://doi.org/10.1016/0010-4485(82)90292-5)
- Lin, C.-Y., Huang, W.-H., Jeng, M.-C., & Doong, J.-L. (1997). Study of an assembly tolerance allocation model based on Monte Carlo simulation. *Journal of Materials Processing Technology*, 70(1-3), 9-16. [https://doi.org/10.1016/S0924-0136\(97\)00034-4](https://doi.org/10.1016/S0924-0136(97)00034-4)
- Lin, V. C., Gossard, D. C., & Light, R. A. (1981). Variational geometry in computer-aided design. *ACM SIGGRAPH Computer Graphics*, 15(3), 171-177. <https://doi.org/10.1145/800224.806803>
- Lin, Z.-C., & Chang, D.-Y. (2002). Cost-tolerance analysis model based on a neural networks method. *International Journal of Production Research*, 40(6), 1429-1452. <https://doi.org/10.1080/00207540110116282>
- Litvin, F., Chen, J.-S., Sep, T., & Wang, J.-C. (1995). Computerized simulation of transmission errors and shift of bearing contact for face-milled hypoid gear drive. *Journal of Mechanical Design*, 117(2A), 262-268. <https://doi.org/10.1115/1.2826133>
- Liu, D., Isik, T., & Rae Cho, B. (2021). Double-tolerance design for manufacturing systems. *IJSE Transactions*, 54(1), 1-12. 10.1080/24725854.2020.1852632
- Malaichamy, T., Sivasubramanian, R., Kumar, S. M., & Sundaram, M. C. (2016). Simulated annealing algorithm for minimising the surplus parts in selective assembly-A software approach. *Asian Journal of Research in Social Sciences and Humanities*, 6(9), 1567-1586. <http://doi.org/10.5958/2249-7315.2016.00890.X>
- Mansoor, E. (1961). Selective assembly—its analysis and applications. *International Journal of Production Research*, 1(1), 13-24. <https://doi.org/10.1080/00207546108943070>
- Mansuy, M., Giordano, M., & Hernandez, P. (2011). A new calculation method for the worst case tolerance analysis and synthesis in stack-type assemblies. *Computer-Aided Design*, 43(9), 1118-1125. <https://doi.org/10.1016/j.cad.2011.04.010>
- Matsuura, S., & Shinozaki, N. (2010). Optimal binning strategies under squared error loss in selective assembly with a tolerance constraint. *Communications in Statistics—Theory and Methods*, 39(4), 592-605. <https://doi.org/10.1080/03610920902763890>
- Matsuura, S., & Shinozaki, N. (2011). Optimal process design in selective assembly when components with smaller variance are manufactured at three shifted means. *International Journal of Production Research*, 49(3), 869-882. <https://doi.org/10.1080/00207541003604851>
- Mease, D., Nair, V. N., & Sudjianto, A. (2004). Selective assembly in manufacturing: statistical issues and optimal binning strategies. *Technometrics*, 46(2), 165-175. <http://doi.org/10.1198/004017004000000185>
- Memon, M., Hussain, T., & Memon, Z. A. (2012). Minimizing assembly errors by selecting optimum assembly sequence in the assembly of a rigid circular structure. *Mehran University Research Journal of Engineering & Technology*, 31(4), 743-754.
- Morse, E., Dantan, J.-Y., Anwer, N., Söderberg, R., Moroni, G., Qureshi, A., Jiang, X., & Mathieu, L. (2018). Tolerancing: Managing uncertainty from conceptual design to final product. *CIRP Annals*, 67(2), 695-717.

- Moskowitz, H. (2010). The partial information case for multivariate tolerance design using scrap or rework costs. *International Journal of Production Research*, 37(1), 139-154. [10.1080/002075499191977](https://doi.org/10.1080/002075499191977)
- Munkres, J. (1957). Algorithms for the assignment and transportation problems. *Journal of the society for industrial and applied mathematics*, 5(1), 32-38. <https://doi.org/10.1137/0105003>
- Mustajib, M. (2012). Concurrent engineering of tolerance synthesis and process selection for products with multiple quality characteristics considering process capability. *Makara Journal of Technology*, 16(1), 7-14. <https://doi.org/10.7454/mst.v16i1.1040>
- Mustajib, M. I., & Irianto, D. (2011). An Integrated Model for Process Selection and Quality Improvement in Multi-Stage Processes. *Journal of Advanced Manufacturing Systems*, 09(01), 31-48. [10.1142/s0219686710001788](https://doi.org/10.1142/s0219686710001788)
- Pedregosa, F., Varoquaux, G., Gramfort, A., Michel, V., Thirion, B., Grisel, O., Blondel, M., Prettenhofer, P., Weiss, R., & Dubourg, V. (2011). Scikit-learn: Machine learning in Python. *the Journal of machine Learning research*, 12, 2825-2830. <https://doi.org/10.48550/arXiv.1201.0490>
- Placek, C. (1989). Motorola, Westinghouse Nuclear Fuel Unit, Globe Metallurgical Named Malcolm Baldrige National Quality Award Winners. *Quality*, 13-14.
- Platt, J. (1999). Probabilistic outputs for support vector machines and comparisons to regularized likelihood methods. *Advances in large margin classifiers*, 10(3), 61-74.
- Portman, V., & Weill, R. (1996). Modelling spatial dimensional chains for CAD/CAM applications. In *Computer-aided tolerancing* (pp. 71-85): Springer.
- Pugh, G. A. (1992). Selective assembly with components of dissimilar variance. *Computers & industrial engineering*, 23(1-4), 487-491. [https://doi.org/10.1016/0360-8352\(92\)90167-I](https://doi.org/10.1016/0360-8352(92)90167-I)
- Qin, A. K., & Suganthan, P. N. (2005). *Self-adaptive differential evolution algorithm for numerical optimization*. Paper presented at the 2005 IEEE congress on evolutionary computation. <https://doi.org/10.1109/CEC.2005.1554904>
- Queipo, N. V., Haftka, R. T., Shyy, W., Goel, T., Vaidyanathan, R., & Tucker, P. K. (2005). Surrogate-based analysis and optimization. *Progress in aerospace sciences*, 41(1), 1-28. <https://doi.org/10.1016/j.paerosci.2005.02.001>
- Qureshi, A. J., Dantan, J.-Y., Sabri, V., Beaucaire, P., & Gayton, N. (2012). A statistical tolerance analysis approach for over-constrained mechanism based on optimization and Monte Carlo simulation. *Computer-Aided Design*, 44(2), 132-142. <https://doi.org/10.1016/j.cad.2011.10.004>
- Ramesh, R., Jerald, J., Page, T., & Arunachalam, S. (2009). Concurrent tolerance allocation using an artificial neural network and continuous ant colony optimisation. *International Journal of Design Engineering*, 2(1), 1-25. <http://doi.org/10.1504/IJDE.2009.028444>
- Requicha, A. A. (1983). Toward a theory of geometric tolerancing. *The International Journal of Robotics Research*, 2(4), 45-60. <https://doi.org/10.1177/027836498300200403>
- Requicha, A. A. (1984). Representation of tolerances in solid modeling: Issues and alternative approaches. In *Solid Modeling by Computers* (pp. 3-22): Springer.
- Rezaei Aderiani, A., Wärmefjord, K., & Söderberg, R. (2018). A multistage approach to the selective assembly of components without dimensional distribution assumptions. *Journal of Manufacturing Science and Engineering*, 140(7), 071015. <https://doi.org/10.1115/1.4039767>
- Rezaei Aderiani, A., Wärmefjord, K., Söderberg, R., & Lindkvist, L. (2019). Developing a selective assembly technique for sheet metal assemblies. *International Journal of Production Research*, 57(22), 7174-7188. <https://doi.org/10.1080/00207543.2019.1581387>

- Roth, M., Schaechtl, P., Giesert, A., Schleich, B., & Wartzack, S. (2021). Toward cost-efficient tolerancing of 3D-printed parts: a novel methodology for the development of tolerance-cost models for fused layer modeling. *The International Journal of Advanced Manufacturing Technology*, 119(3-4), 2461-2478. <https://doi.org/10.1007/s00170-021-08488-z>
- Saravanan, A., Jerald, J., & Rani, A. D. C. (2020). An explicit methodology for manufacturing cost-tolerance modeling and optimization using the neural network integrated with the genetic algorithm. *AI EDAM*, 34(3), 430-443. <https://doi.org/10.1017/S0890060420000219>
- Schleich, B., Anwer, N., Mathieu, L., & Wartzack, S. (2014). Skin model shapes: A new paradigm shift for geometric variations modelling in mechanical engineering. *Computer-Aided Design*, 50, 1-15. <https://doi.org/10.1016/j.cad.2014.01.001>
- Shin, H., Benton, W., & Jun, M. (2009). Quantifying suppliers' product quality and delivery performance: A sourcing policy decision model. *Computers & Operations Research*, 36(8), 2462-2471. <https://doi.org/10.1016/j.cor.2008.10.005>
- Shin, S., & Cho, B. (2007). Integrating a bi-objective paradigm to tolerance optimization. *International Journal of Production Research*, 45(23), 5509-5525. <https://doi.org/10.1080/00207540701325181>
- Singh, P., Jain, P., & Jain, S. (2009). Important issues in tolerance design of mechanical assemblies. Part 1: tolerance analysis. *Proceedings of the Institution of Mechanical Engineers, Part B: Journal of Engineering Manufacture*, 223(10), 1225-1247. <https://doi.org/10.1243/09544054JEM1304A>
- Singh, P. K., Jain, S. C., & Jain, P. K. (2005). Advanced optimal tolerance design of mechanical assemblies with interrelated dimension chains and process precision limits. *Computers in Industry*, 56(2), 179-194. <https://doi.org/10.1016/j.compind.2004.06.008>
- Sirona, D. (2023). Retrieved from <https://www.dentsplysirona.com/fr-fr/decouvrez-nos-produits/instruments/turbines.html>
- Siva Kumar, M., Kannan, S., & Jayabalan, V. (2007). A new algorithm for minimizing surplus parts in selective assembly by using genetic algorithm. *International Journal of Production Research*, 45(20), 4793-4822. <https://doi.org/10.1080/00207540600810085>
- Sobol, I. M., ' (1993). Sensitivity estimates for nonlinear mathematical models. *Math. Model. Comput. Exp*, 1(4), 407-414. [https://doi.org/10.1016/S0378-4754\(00\)00270-6](https://doi.org/10.1016/S0378-4754(00)00270-6)
- Sofiana, A., Rosyidi, C. N., & Pujiyanto, E. (2019). Product quality improvement model considering quality investment in rework policies and supply chain profit sharing. *Journal of Industrial Engineering International*, 15(4), 637-649. 10.1007/s40092-019-0309-7
- Spotts, M. F. (1978). How to use wider tolerances, safely, in dimensioning stacked assemblies. *Machine Design*, 50(9), 60-63.
- Srinivasan, V., & Jayaraman, R. (1989). Geometric tolerancing: II. Conditional tolerances. *IBM Journal of Research and Development*, 33(2), 105-124. <https://doi.org/10.1147/rd.332.0105>
- Sun, X., Bao, J., Li, J., Zhang, Y., Liu, S., & Zhou, B. (2020). A digital twin-driven approach for the assembly-commissioning of high precision products. *Robotics and Computer-Integrated Manufacturing*, 61, 101839. <https://doi.org/10.1016/j.rcim.2019.101839>
- Sutherland, G., & Roth, B. (1975). Mechanism design: accounting for manufacturing tolerances and costs in function generating problems.
- Teissandier, D., Couetard, Y., & Gérard, A. (1999). A computer aided tolerancing model: proportioned assembly clearance volume. *Computer-Aided Design*, 31(13), 805-817. [https://doi.org/10.1016/S0010-4485\(99\)00055-X](https://doi.org/10.1016/S0010-4485(99)00055-X)

- Tsutsumi, D., Gyulai, D., Kovács, A., Tipary, B., Ueno, Y., Nonaka, Y., & Fujita, K. (2020). Joint optimization of product tolerance design, process plan, and production plan in high-precision multi-product assembly. *Journal of Manufacturing Systems*, 54, 336-347. <https://doi.org/10.1016/j.jmsy.2020.01.004>
- Turner, J. (1993). A feasibility space approach for automated tolerancing. <https://doi.org/10.1115/1.2901670>
- VanderPlas, J. (2016). *Python data science handbook: Essential tools for working with data*. " O'Reilly Media, Inc."
- Varghese, P., Braswell, R. N., Wang, B., & Zhang, C. (1996). Statistical tolerance analysis using FRPDF and numerical convolution. *Computer-Aided Design*, 28(9), 723-732. [https://doi.org/10.1016/0010-4485\(96\)00005-X](https://doi.org/10.1016/0010-4485(96)00005-X)
- Vasseur, H., Kurfess, T., & Cagan, J. (1997). Use of a quality loss function to select statistical tolerances. <https://doi.org/10.1115/1.2831121>
- VDI2608:2001. (2001). Tangential composite and radial composite inspection of cylindrical gears, bevel gears, worms and worm wheels. In. Verein Deutscher Ingenieure e. V, Beuth, Berlin.
- Victor Raj, M., Saravana Sankar, S., & Ponnambalam, S. (2011a). Genetic algorithm to optimize manufacturing system efficiency in batch selective assembly. *The International Journal of Advanced Manufacturing Technology*, 57(5), 795-810. <https://doi.org/10.1007/s00170-011-3326-2>
- Victor Raj, M., Saravana Sankar, S., & Ponnambalam, S. (2011b). Optimization of assembly tolerance variation and manufacturing system efficiency by using genetic algorithm in batch selective assembly. *The International Journal of Advanced Manufacturing Technology*, 55(9), 1193-1208. <https://doi.org/10.1007/s00170-010-3124-2>
- Walter, M., Spruegel, T., & Wartzack, S. (2015). Least cost tolerance allocation for systems with time-variant deviations. *Procedia CIRP*, 27, 1-9. <https://doi.org/10.1016/j.procir.2015.04.035>
- Wang, K., Du, S., & Xi, L. (2020). Three-dimensional tolerance analysis modelling of variation propagation in multi-stage machining processes for general shape workpieces. *International Journal of Precision Engineering and Manufacturing*, 21(1), 31-44. <https://doi.org/10.1007/s12541-019-00202-0>
- Wang, K., Yin, Y., Du, S., & Xi, L. (2021). Variation management of key control characteristics in multistage machining processes considering quality-cost equilibrium. *Journal of Manufacturing Systems*, 59, 441-452. <https://doi.org/10.1016/j.jmsy.2021.03.013>
- Wang, W., Li, D., He, F., & Tong, Y. (2018). Modelling and optimization for a selective assembly process of parts with non-normal distribution. *International Journal of Simulation Modelling*, 17(1), 133-146. [http://doi.org/10.2507/IJSIMM17\(1\)CO1](http://doi.org/10.2507/IJSIMM17(1)CO1)
- Whitney, D. E., Gilbert, O. L., & Jastrzebski, M. (1994). Representation of geometric variations using matrix transforms for statistical tolerance analysis in assemblies. *Research in Engineering Design*, 6(4), 191-210. <https://doi.org/10.1007/BF01608399>
- Wirtz, A. (1993). *Vectorial tolerancing a basic element for quality control*. Paper presented at the Proc. of 3rd CIRP Seminars on Computer Aided Tolerancing.
- Wu, D., Yan, P., Guo, Y., Zhou, H., & Chen, J. (2022). A gear machining error prediction method based on adaptive Gaussian mixture regression considering stochastic disturbance. *Journal of Intelligent Manufacturing*, 33(8), 2321-2339. <https://doi.org/10.1007/s10845-021-01791-2>

- Wu, H., Li, X., Sun, F., Zheng, H., & Zhao, Y. (2021). Optimization design method of machine tool static geometric accuracy using tolerance modeling. *The International Journal of Advanced Manufacturing Technology*, 118(5-6), 1793-1809. <https://doi.org/10.1007/s00170-021-07992-6>
- Yan, X., & Ballu, A. (2019). Review and comparison of form error simulation methods for computer-aided tolerancing. *Journal of Computing and Information Science in Engineering*, 19(1). <https://doi.org/10.1115/1.4041476>
- Yi, Y., Yan, Y., Liu, X., Ni, Z., Feng, J., & Liu, J. (2021). Digital twin-based smart assembly process design and application framework for complex products and its case study. *Journal of Manufacturing Systems*, 58, 94-107. <https://doi.org/10.1016/j.jmsy.2020.04.013>
- Zeng, W., Rao, Y., Wang, P., & Yi, W. (2017). A solution of worst-case tolerance analysis for partial parallel chains based on the unified Jacobian-Torsor model. *Precision Engineering*, 47, 276-291. <https://doi.org/10.1016/j.precisioneng.2016.09.002>
- Zhang, C., & Wang, H.-P. (1993). The discrete tolerance optimization problem. *Manufacturing Review*, 6, 60-60.
- Zhang, C., & Wang, H.-P. (1998). Robust design of assembly and machining tolerance allocations. *IIE Transactions*, 30(1), 17-29. <https://doi.org/10.1023/A:1007437427523>
- Zhou, Z., Huang, W., & Zhang, L. (2001). Sequential algorithm based on number theoretic method for statistical tolerance analysis and synthesis. *J. Manuf. Sci. Eng.*, 123(3), 490-493. <https://doi.org/10.1115/1.1378795>
- Ziegler, P., & Wartzack, S. (2015). Sensitivity analysis of features in tolerancing based on constraint function level sets. *Reliability Engineering & System Safety*, 134, 324-333. <https://doi.org/10.1016/j.ress.2014.09.017>



# Appendices

## Appendix I: Numerical simulation of geometric deviations on gears

The numerical simulation of the gear is the activity that develops an algorithm for gear meshing simulation and subsequently calculates the Kinematic Transmission Error (KTE). KTE is the rotation delay between driving and driven gears caused by disturbances of inevitable random noise factors such as elastic deformation, manufacturing error, and alignment error in assembly. However, this activity needs to model correctly the imperfections observed on the gear flank surfaces. A non-exhaustive list of methods to model surface imperfections can be divided into five (5) groups (Yan & Ballu, 2019): parametric methods, morphing mesh methods, random noise methods, skin models, and model-based methods. Discrete Cosine Transform (DCT) is a model-based method used to model the form defects of surfaces. It consists in decomposing the deviations of a surface into cosine basis shapes and reconstructing the original deviations by using a weighted sum of these basic shapes. The decomposition phase allows us to calculate the cosine coefficients of the surface's deviations. These cosine coefficients represent the unique signature of the surface's deviations.

The modeling of deviations in gears involves the development of two surrogate models. The first model connects the deviations from the standard (such as runout, pitch error, misalignments, leads, profile errors, etc.) to the cosine coefficients and components of homogeneous matrices, which represent each deviation type (i.e. rotations  $[\alpha \ \beta \ \gamma]$  and translations  $[u \ v \ w]$ ). The goal of this model is to predict the cosine coefficients and deviation matrices from the deviations from the standard so that these values can be used in numerical gear simulations. The second model links the cosine coefficients and deviation matrices to the KTE from gear meshing simulations. The objective of this model is to predict the KTE using the cosine coefficients and deviation matrices of the gears.

The number of inputs depends on the number of features in two gears and can be calculated as follow:

$$\begin{aligned} \text{Number of features\inputs} = N_{formDefects} + N_{PitchError} + \\ N_{Runout} + N_{Misalignment} \end{aligned} \quad (31)$$

Where  $N_{formDefects}$ ,  $N_{PitchError}$ ,  $N_{Runout}$ , and  $N_{Misalignment}$  are equal to

$$N_{formDefects} = \sum_k^{z_{spur\ gear}} N^k + \sum_k^{z_{crown\ wheel}} N^k$$

$$N_{PitchError} = z_{spur\ gear} * 6 + z_{crown\ wheel} * 6$$

$$N_{Runout} = 1 * 6$$

$$N_{Misalignment} = 1 * 6$$

where  $z$  represents the number of teeth on each gear. Therefore, the number of geometrical deviations on a spur gear with  $z_{spur\ gear} = 13$  and a crown wheel with  $z_{crown\ wheel} = 19$  and 9 points on each tooth is equal  $\left( \frac{3 * 3 * 13 + 3 * 3 * 19}{Total\ number\ of\ form\ defect\ deviation} \right) + \left( \frac{6 * 13 + 6 * 19}{Total\ number\ of\ pitch\ errors} \right) + \left( \frac{6 + 6}{Total\ number\ of\ runout\ errors} \right) + \frac{6}{Number\ of\ misalignmnet\ errors} = 498$ .

## Appendix II: Sobol sensitivity analysis

Any numerical computer model  $f$  may be viewed as a function  $Y = f(X)$ , where  $X$  is a vector of  $n$  uncertain model inputs  $\{X_1, X_2, \dots, X_n\}$ , and  $Y$  is a chosen univariate response (note that in this research  $X$  represents a set of tolerances  $T$  and  $Y$  represents assembly conformity rate  $\lambda$ ). Sobol sensitivity analysis is intended to determine the contribution of each input parameter and its interactions with the overall model response variance. Furthermore, it will be assumed that the inputs are independently and uniformly distributed within the unit hypercube, i.e.  $X_i \in [admissble\ lower\ bound, admissble\ upper\ bound]$  for  $i = 1, 2, \dots, n$ . This incurs no loss of generality because any input space can be transformed onto this unit hypercube. Sobol's method is based on the decomposition of the model response and can be expanded into summands of different dimensions (Sobol, 1993):

$$Y = f_0 + \sum_{i=1}^n f_i(X_i) + \sum_{i<j}^n f_{ij}(X_i, X_j) + \dots + f_{1\dots i\dots n}(X_1 \dots X_i \dots X_n) \quad (32)$$

where  $f_0$  is a constant and  $f_i$  is a function of  $X_i$ ,  $f_{ij}$  a function of  $X_i$  and  $X_j$ , etc. The total variance of the response  $Y$  can be decomposed into partial variances, attributing variability of the response  $Y$  to each input parameter, including interactions:

$$\text{Var}(Y) = \sum_{i=1}^n V_i + \sum_{i<j}^n V_{ij} + \dots + V_{1\dots i\dots n} \quad (33)$$

S. t.

$$V_i = \text{Var}[E(Y|X_i)] \quad , i = 1, 2, \dots, n$$

$$V_{i,j} = \text{Var}[E(Y|X_i, X_j)] - (V_i + V_j) \quad i = 1, 2, \dots, n, \quad i \neq j$$

where  $E$  is the conditional expected values and  $V$  is the variance of the model response which can be decomposed into terms attributable to each input, as well as the interaction effects between them. The Sobol sensitivity indices for first-order  $S_i$  and total-effect  $S_T$  are then defined as:

$$S_i = \frac{V_i}{\text{Var}(Y)}, \quad S_{ij} = \frac{V_{ij}}{\text{Var}(Y)}, \quad \dots, \quad S_{1\dots i\dots n} = \frac{V_{1\dots i\dots n}}{\text{Var}(Y)} \quad (34)$$

$$1 = \sum_{i=1}^n S_i + \sum_{i<j}^n S_{ij} + \dots + S_{1\dots i\dots n}$$

$$S_{Ti} = S_i + S_{ij} + \dots + S_{1\dots i\dots n}$$

The  $S_i$  measures the impact of the varying input  $X_i$  by estimating the partial variance of response  $Y$  associated with this input. Moreover, the  $S_{Ti}$  assesses the contribution to the response variance of  $X_i$ , including all variance caused by its interactions, of any order, with any other input variables.

### Appendix III: Finding data depository

The data that support the findings of this study on the case of micro gears are available in the Recherche Data Gouv <https://doi.org/10.57745/3EELGX> and <https://doi.org/10.57745/E3DW9W>. The first dataset contains the outcome of numerous gear simulations based on intricate gear models. Within this file, there are 40,000 statistical tolerance analysis results based on a Monte-Carlo simulation (MC sample size = 1000000). The data is categorized by color and further elaborated as follows (see **Table 20**): (1) 15 input parameters (colored in light blue within the Excel file), some of which are tolerances defined by designers and applied to the gear characteristics as boundaries to meet, while others are shifts on key parameters of these gears, primarily due to their manufacturing. The final input parameter is the Kinematic Transmission Error (KTE). (2) Three outputs are available (colored in gold in the provided file): the number of non-

conformities of each type of produced gear and the most significant output, the amount of the final conformity rate (the most expensive ones).

**Table 20.** Simulated gears dataset representation

Spur gear pitch tolerance	Spur gear runout tolerance	spur gear form defect tolerance	...	KTE value	Assembled non-conformity	Spur non-conformity	Crwon non-conformity
10.001	10.001	5.001	...	15.001	1.00E+06	2.00E+00	1.16E+02
20.001	16.6677	8.001	...	15.0014	1.00E+06	2.40E+01	4.98E+02
15.001	23.3343	11.001	...	15.0018	1.00E+06	1.00E+00	5.40E+01
25.001	12.2232	14.001	...	15.0021	9.97E+05	0.00E+00	2.50E+01
12.501	18.8899	17.001	...	15.0025	9.98E+05	7.00E+01	9.98E+02
22.501	25.5566	5.601	...	15.0029	1.00E+06	8.99E+03	2.25E+04
17.501	14.4454	8.601	...	15.0033	1.00E+06	4.87E+04	6.43E+04
...	...	...	...	...	...	...	...
24.0809	14.0895	9.1937	...	29.9999	6.73E+03	1.71E+02	2.10E+03
19.0809	20.7561	12.1937	...	30.0002	9.97E+04	8.00E+00	6.44E+02
29.0809	27.4228	15.1937	...	30.0006	4.17E+05	1.00E+00	3.43E+02

The second dataset comprises 1000 Spur gears and 1000 Crown wheels with distinct geometric deviations that result from inaccuracies during the manufacturing process. The dataset includes both the inputs and outputs of the proposed adaptive assembly system for gear pairing. The inputs consist of labeled gears and the Kinematic Transmission Error (KTE) values for various combinations of the two types. The outputs entail the results of selective assembly binning analysis and individual assembly analysis for the specific pairing of the two gears.

#### Appendix IV: Trained neural network architecture

The trained neural network model architecture in section II.3.4 is detailed below.

Layer (type)	Output Shape	Param #
dense_6 (Dense)	(None, 512)	8192
dense_7 (Dense)	(None, 256)	131328
dense_8 (Dense)	(None, 128)	32896
dense_9 (Dense)	(None, 64)	8256
dense_10 (Dense)	(None, 32)	2080
dense_11 (Dense)	(None, 501)	16533
Total params: 199,285		
Trainable params: 199,285		
Non-trainable params: 0		

The rectified linear unit (ReLU) activation function is used in all hidden layers and a softmax activation function in the output layer. The model was trained using the Root Mean Square Propagation (RMSprop) optimization algorithm with a learning rate of 0.001. The model achieved an accuracy of 99.59% on the test set, indicating strong predictive performance.

### Appendix V: Complementary cost-tolerance optimization results

In sections III.2.1 and III.2.2, cost-tolerance optimization applications are given. More complementary information is provided in **Figure 53** and **Figure 54**. **Figure 53** illustrates the variations in allocated tolerances and resources when designers impose a change in the functional requirement. Moreover, the conformity rate fluctuations associated with the changes are detailed.

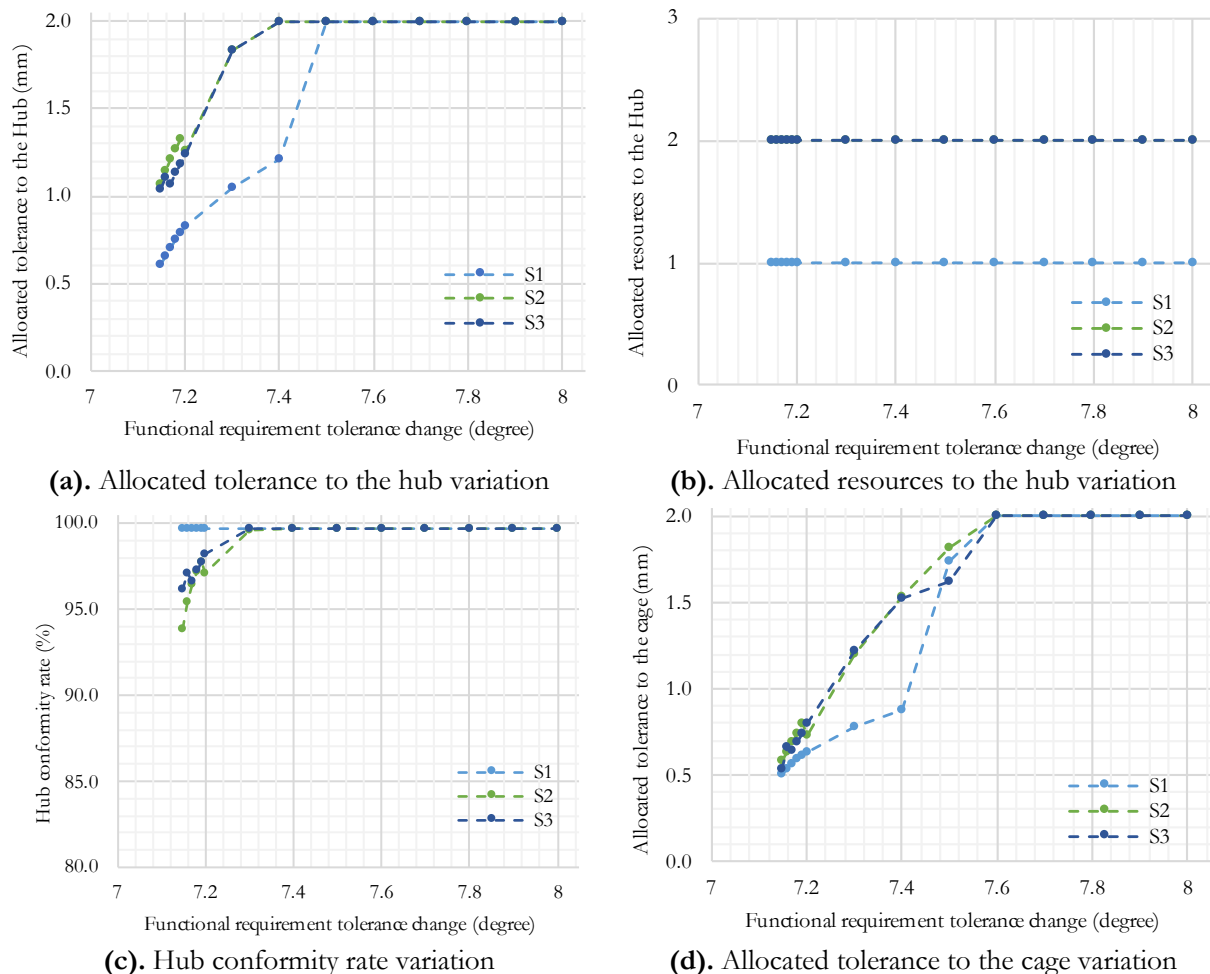

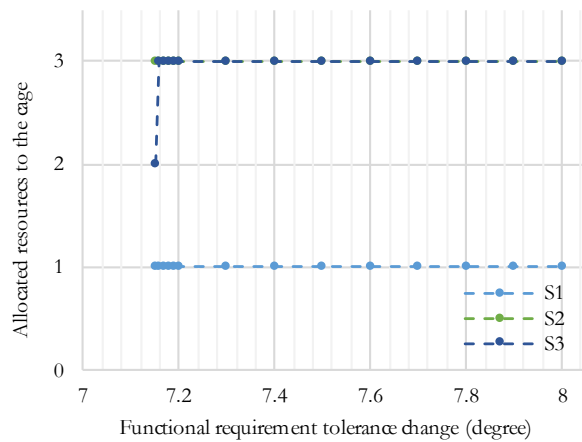

(e). Allocated resources to the cage variation

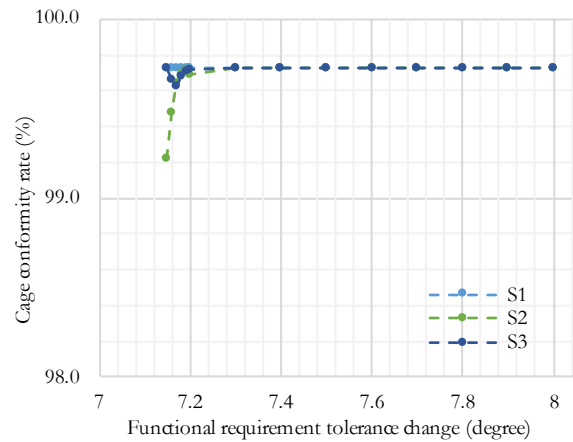

(f). Cage conformity rate variation

**Figure 53.** Complementary information related to Figure 28

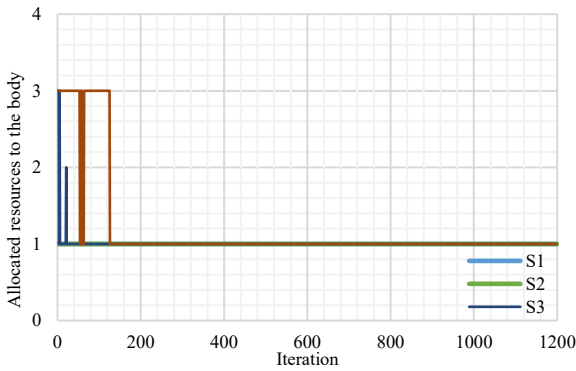

(a) Convergence of GA for the allocated resources to the body

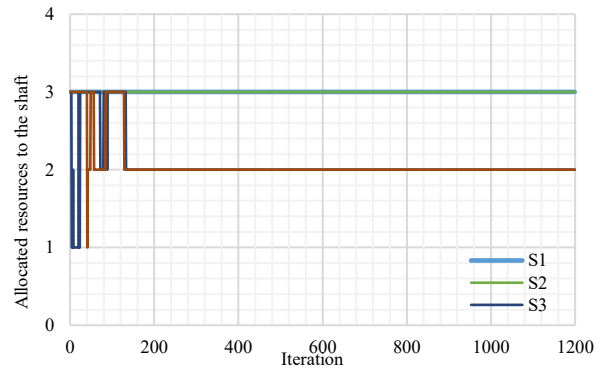

(b) Convergence of GA for the allocated resources to the shaft

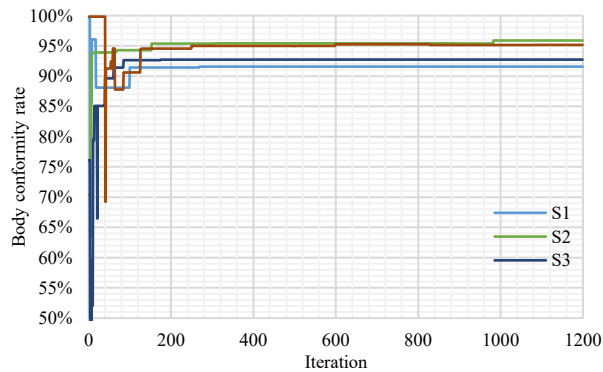

(c) Convergence of GA for the body conformity rate

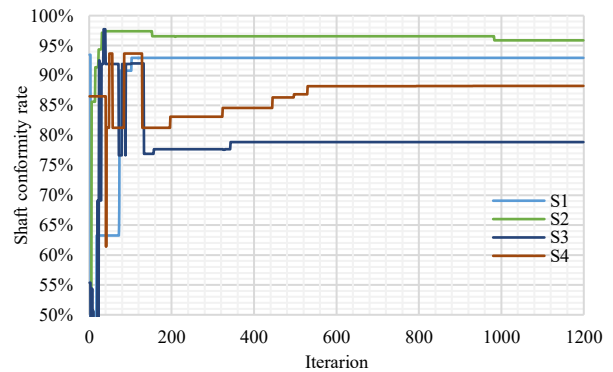

(d) Convergence of GA for the shaft conformity rate

**Figure 54.** Complementary information related to Figure 33

**Figure 54** depicts the convergency of the GA while reaching the minimum manufacturing cost and convergency impacts on the allocated resources and associated conformities to the house and shaft.

# Surrogate model and optimization for dynamic tolerance allocation and assembly strategies

## Résumé

Cette thèse se concentre sur le développement fonctionnel de systèmes assemblés complexes, tels que les micro-engrenages, qui reposent sur des composants de haute précision. La performance de ces systèmes est déterminée par divers facteurs, notamment la conception, la fabrication, l'assemblage et les conditions internes et externes. Pour faire face à la complexité de ces assemblages et au défi que représente l'analyse de leur comportement fonctionnel, des modèles de substitution sont proposés pour estimer les effets de la tolérance et leur impact sur la fonctionnalité. L'utilisation de techniques d'apprentissage automatique, en particulier l'IA, est explorée comme une approche efficace pour prédire la précision de l'assemblage et améliorer la rentabilité et le gain de temps. En plus de proposer des modèles de substitution, cette thèse présente des stratégies de production, telles que l'allocation des ressources, le retraitement et les stratégies d'assemblage, afin d'améliorer la qualité de l'assemblage et de réduire les coûts de production. Un nouveau cadre de modèle coût-activité est également introduit pour identifier les spécifications à coût élevé et à faible tolérance dans le processus de production et permettre aux fabricants d'optimiser l'équilibre entre le coût et la tolérance tout en maintenant la qualité. La structure modulaire du modèle offre une approche organisée et systématique de l'analyse et de l'optimisation du processus de fabrication.

**Mots clés :** Allocation dynamique de tolérance; Qualité géométrique; Optimisation; Méta-modèle; L'assemblage adaptatif.

## Abstract

This thesis focuses on the functional behavior of intricate assembled systems, such as micro gears, which rely on high-precision components. The performance of these systems is determined by various factors, including design, manufacturing, assembly, and internal and external conditions. To address the complexity of these assemblies and the challenge of analyzing their functional behavior, surrogate models are proposed to estimate the effects of tolerance and their impact on functionality. The use of machine learning techniques, particularly AI, is explored as an efficient approach to predict assembly precision and improve cost-effectiveness and time-saving. In addition to proposing surrogate models, this thesis presents production strategies, such as resource allocation, reworking, and assembly strategies, to enhance assembly quality and reduce production cost. A novel cost-activity model framework is also introduced to identify high-cost and low-tolerance specifications in the production process and enable manufacturers to optimize the balance between cost and tolerance while maintaining quality. The modular structure of the model provides an organized and systematic approach to analyzing and optimizing the manufacturing process.

**Keywords:** Dynamic tolerance allocation; Quality management; Optimization; Surrogate model; Adaptive assembly.