



HAL
open science

Implementation of Carbon Capture Utilization and Storage in global socio-techno-economic models : long-term optimization of the energy system and industry decarbonization

Lucas Desport

► **To cite this version:**

Lucas Desport. Implementation of Carbon Capture Utilization and Storage in global socio-techno-economic models : long-term optimization of the energy system and industry decarbonization. Optimization and Control [math.OC]. Université Paris sciences et lettres, 2023. English. NNT : 2023UP-SLM058 . tel-04546774

HAL Id: tel-04546774

<https://pastel.hal.science/tel-04546774>

Submitted on 15 Apr 2024

HAL is a multi-disciplinary open access archive for the deposit and dissemination of scientific research documents, whether they are published or not. The documents may come from teaching and research institutions in France or abroad, or from public or private research centers.

L'archive ouverte pluridisciplinaire **HAL**, est destinée au dépôt et à la diffusion de documents scientifiques de niveau recherche, publiés ou non, émanant des établissements d'enseignement et de recherche français ou étrangers, des laboratoires publics ou privés.



THÈSE DE DOCTORAT
DE L'UNIVERSITÉ PSL

Préparée à Mines Paris – PSL

**Implementation of Carbon Capture Utilization and Storage in
global socio-techno-economic models: long-term optimization
of the energy system and industry decarbonization**

*Intégration de la capture, utilisation et stockage du carbone dans les
modèles socio-technico-économiques : optimisation long terme du
système énergétique mondial et décarbonation de l'industrie*

Soutenue par

Lucas Desport

Le 22 septembre 2023

Ecole doctorale n°84

**Sciences et Technologies de
l'Information et la
Communication**

Spécialité

**Contrôle, optimisation,
prospective**

Composition du jury :

Bob, VAN DER ZWAAN Professeur, University of Amsterdam	<i>Rapporteur</i>
Sergey, PALTSEV Professeur, Massachusetts Institute of Technology (MIT)	<i>Rapporteur</i>
Olivier, DESSENS Senior Research Associate, University College London (UCL)	<i>Examineur</i>
Philip, LLEWELLYN CCUS R&D Manager, TotalEnergies	<i>Examineur</i>
Nadia, MAÏZI Professeure, Mines Paris – PSL	<i>Examinatrice</i>
Sandrine, SELOSSE Chargée de recherche, Mines Paris – PSL	<i>Directrice de thèse</i>

Abstract

It is now unequivocal that climate change is due to human activity, increasing global temperatures, and a range of related impacts on biodiversity, weather, land productivity, and sea levels, etc. It is therefore vital to engage in a transition that will allow us to limit global warming, which implies mitigating or even eliminating carbon dioxide (CO₂) and other greenhouse gases that result from our use of fossil fuels, our agriculture, and our industry. Eradicating these emissions is not simple and faces environmental, social, economic, and technical challenges. One technical solution to tackling CO₂ is to capture it and then store it underground or utilize it to produce fuels, chemicals, or minerals. This technology is known as Carbon Capture Utilization and Storage (CCUS). Since climate change is a global, social, economic, and technical problem, we employ Integrated Assessment Models (IAMs) in this thesis. These models connect the energy system to the broader economy and the Earth system and project the future of the global economy and energy system. They can evaluate what policies and technologies should be developed throughout the 21st century to meet commitments such as net-zero emission targets or the Paris Agreement. IAMs are as numerous as they are diverse, some focusing more on energy economics – known as top-down models – and others on the technologies of the energy system – known as bottom-up models, with different modeling paradigms and assumptions. Given the wide variety of IAMs, differences arise in the treatment and consideration of systems; we therefore employ two different models in this work, namely, TIAM-FR and EPPA, developed respectively by Mines Paris – PSL and MIT. The core work consists in implementing CCUS technologies in both models. In TIAM-FR we review the techno-economic assumptions and modeling of CO₂ transport and storage and CO₂ capture in the power sector, the hydrogen sector, and biorefineries. We implement direct air capture (DAC) and CO₂ capture in the cement industry and the steel industry, and we model CO₂ utilization to produce minerals and synthetic methanol, gasoline, diesel, jet fuels, and methane. We employ these models and their new CCUS features to answer the question of the role and potential of CCUS in the global energy transition. More specifically, we address three research questions: 1) Which drivers ensure CCU to contribute significantly to emissions reductions? 2) How far are we from deploying air capture at scale? 3) What are the role and potential of CCUS to decarbonize the cement and steel industries? Our results reveal that CCU's potential is very sensitive to the uncertainties underlying its cost, but also to the cost of hydrogen. Besides, the potential for CCU decreases as CCS becomes expensive and DAC becomes cheap. Thus, the potential for CCU is uncertain, but it may prove important for the industry for mineralizing steel slags and recycling them in the cement industry or decarbonizing the aviation sector. Concerning DAC, we find that this technology contributes significantly to net-zero ambitions with costs below \$400/tCO₂, especially when there is no international emissions trading system available. However, the availability of CO₂ storage as well as its impacts on land and the power system could hinder its deployment in some regions of the world. Finally, negative emissions generated by cement and steel industries represent a substantial potential for the decarbonization of the global industry, with up to 3 Gt of negative emissions. In addition, CCS remains the only solution to combat industrial process CO₂ emissions. Although EPPA and TIAM-FR give different results for solving a net-zero target by 2070 in terms of CCS capacities and temporal deployment, the bottom line is the same: CCS is required to achieve the transition, especially thanks to negative emissions. However, CCU is not as effective as CCS and remains a technology for the long-term future.

Résumé

Il est désormais sans équivoque que le changement climatique est dû à l'activité humaine, provoquant une augmentation de la température et tous les impacts qui en découlent sur la biodiversité, la météo, la productivité des terres, le niveau de la mer, etc. Il est donc vital de s'engager dans une transition qui nous permettra de limiter le réchauffement climatique, ce qui implique de limiter les émissions de dioxyde de carbone (CO₂) et les autres gaz à effet de serre qui résultent de notre utilisation de combustibles fossiles, de notre agriculture et de notre industrie. L'éradication de ces émissions se heurte à des défis environnementaux, sociaux, économiques et techniques. L'une des solutions techniques au problème du CO₂ consiste à le capturer, puis à le stocker sous terre ou à l'utiliser. Cette technologie s'appelle le captage, utilisation et stockage du carbone (CCUS). Le changement climatique étant un problème mondial, social, économique et technique, nous utilisons des modèles d'évaluation intégrée (IAM) qui relient le système énergétique à l'économie et au système terrestre et projettent leur avenir. Ils permettent d'évaluer les politiques et les technologies les plus à même de respecter des engagements tels que les objectifs d'émissions *net zero*. Les IAM sont aussi nombreux que diversifiés, certains se concentrant davantage sur l'économie de l'énergie – connus sous le nom de modèles *top-down* – que sur les technologies du système énergétique – connus sous le nom de modèles *bottom-up*, avec différents paradigmes et hypothèses de modélisation. C'est pourquoi deux modèles différents sont utilisés dans cette thèse, à savoir TIAM-FR et EPPA, développés respectivement par Mines Paris - PSL et le MIT. Le cœur du travail consiste à implémenter les technologies CCUS dans les deux modèles. Nous modélisons le transport et du stockage du CO₂, ainsi que la capture du CO₂ dans les secteurs de l'électricité, de l'hydrogène, de l'industrie et des bioraffineries, puis directement de l'air (DAC) et enfin l'utilisation du CO₂ pour produire des minéraux et des carburants synthétiques (essence, diesel, méthanol, méthane, et carburateurs). Nous utilisons ces modèles pour évaluer le rôle et le potentiel de CCUS dans la transition énergétique mondiale. Plus précisément, nous abordons trois questions de recherche 1) Quels sont les facteurs qui permettent l'utilisation du CO₂ de contribuer de manière significative à la réduction des émissions ? 2) Sous quelles conditions le DAC se déploie à grande échelle et pour quelles conséquences ? 3) Quel est le rôle et le potentiel de l'utilisation du CCUS et pour décarboner l'industrie ? Nos résultats révèlent que le potentiel de l'utilisation du CO₂ est très sensible aux incertitudes sous-jacentes à son coût, mais aussi au coût de l'hydrogène. En outre, le potentiel du CO₂ diminue à mesure que le stockage du CO₂ devient coûteux et que le DAC devient bon marché. Ainsi, le potentiel du CCU est incertain mais peut s'avérer important pour l'industrie ou l'aviation. En ce qui concerne le DAC, cette technologie contribue de manière significative aux ambitions à condition que son coût soit inférieur à 400 \$/tCO₂, en particulier lorsqu'il n'existe pas de système international d'échange de permis d'émission. Cependant, la disponibilité du stockage du CO₂ ainsi que les impacts sur le système électrique peuvent entraver son déploiement. Enfin, les émissions négatives générées par les industries du ciment et de l'acier représentent un potentiel conséquent. D'ailleurs, le CCS reste la seule solution pour lutter contre les émissions de CO₂ de l'industrie. Si les résultats de EPPA et de TIAM-FR pour atteindre l'objectif *net zero* d'ici 2070 diffèrent en termes de capacités de CCUS et de déploiement temporel, les conclusions sont similaires : le CCS et les émissions négatives sont nécessaires pour réaliser la transition. Cependant, utiliser le CO₂ est moins efficace et nécessaire que de le stocker sous terre.

Acknowledgements

To begin with, I thank the rapporteurs of the manuscript – Sergey Paltsev and Bob van der Zwaan – for the time you took to review my work and help improve it. I also thank the honorable jury – Nadia Maïzi, Sandrine Seloisse, Olivier Dessens, and Philip Llewellyn – for accepting to be a member of my Ph.D. committee and reviewing my work.

My PhD journey began in 2019, shortly after completing my master's degree in energy systems optimization (OSE). It all started when my supervisor, Sandrine Seloisse, reached out to me with a compelling proposition: a doctoral research opportunity in CCUS modeling in collaboration with Mines Paris - PSL, TotalEnergies, and the Massachusetts Institute of Technology (MIT). Initially, I was not fully convinced about pursuing a Ph.D, but as I delved deeper into the offer, I realized its immense potential. It took me just one day to make up my mind and submit my application.

I want to express my sincere gratitude to Dr. Sandrine Seloisse, my supervisor, and Catherine Auguet-Chadaj, who suggested me for this remarkable position. Sandrine's extensive expertise, unwavering guidance, continuous support, and pragmatic advice have proven to be invaluable assets, especially when tackling complex challenges.

I would like to extend my gratitude to Professor Nadia Maïzi, the esteemed director of the Center for Applied Mathematics (CMA), and Professor Gilles Guerassimoff, deputy director of CMA. Their decision to allow me to pursue my Ph.D. at this prestigious institution has been instrumental in shaping my academic journey. Furthermore, their constant availability for guidance and advice whenever I sought it has been precious.

Working at CMA has been an incredible experience, made even more enriching by the collaboration with my fellow doctoral colleagues: Naima, Amir, Carlos, Victor, Sophie, Rabab, Paul, Matthieu, Gildas, Thibaut, Gregorio, Dhekra, Louis, Zixuan, Amal, Yacine, and Cindy.

I would also like to express my appreciation for the dedicated staff members who have supported and facilitated my journey: Alice, Claire, Amel, Gilles, Edi, Valérie, Sandrine, Sonia, Sophie, Jean-Paul, Damien, Sébastien, Wellington, Valentina, and Maju. Your contributions have made this research endeavor both productive and enjoyable. I am also grateful to Fabrice Devaux, who gave me his trust and engaged me as an engineer in his – former – CCUS team during three months at TotalEnergies, La Défense. It was the opportunity to discover CCUS technologies but also the people: Benjamin, Behrang, Chloé, Julie, and Li. Thank you for your welcome.

Due to the pandemic, it was not an easy task to organize a visit to MIT, but it finally happened twice in 2022 with a total of 14 weeks spent in this prestigious destination. I am grateful to Prof. Sergey Paltsev, Deputy Director of the Joint Program on the Science and Policy of Global Change, for giving me the opportunity to work at this prestigious university and with his team: Prof. Angelo Gurgel, Prof. Jennifer Morris, Howard Herzog, and Dr. Henry Chen – it was such a chance working with you, and I feel I learned a lot from you. I also thank all the great people I met there – Micaela, Fannie, Magnus, Michiel, and Dom.

I cannot be more grateful than to my dear parents and family, who gave their unconditional support, especially during difficult moments. I want to thank all my dear friends who participate somehow to this adventure. Last but not least, thank you Laura.

Contents

Abstract.....	2
Résumé.....	4
Acknowledgements.....	6
List of figures.....	12
List of tables.....	16
Acronyms.....	18
Introduction.....	20
Contributions.....	24
Chapter 1: Perspectives of CCS and CCU.....	26
1. Overview of CO ₂ capture, CO ₂ utilization, CO ₂ transport, and CO ₂ storage across the world.....	26
1.1. CO ₂ capture.....	26
1.2. CO ₂ utilization.....	28
1.3. CO ₂ transport.....	29
1.4. CO ₂ storage.....	30
1.5. Dynamics.....	31
2. Towards the deployment of CCU and CCS: what are the challenges?.....	32
2.1. Techno-economic challenges.....	32
2.2. Market-related challenges for CCU.....	33
2.3. Infrastructures.....	33
2.4. Policies.....	34
2.5. Acceptability.....	35
3. Projecting the future of CCU and CCS with prospective energy models.....	35
3.1. Introduction to prospective energy modeling.....	36
3.2. State of the art: The role of CCU and CCS in the power sector.....	39
3.3. State of the art: The role of CCU and CCS in fuel supply.....	40
3.4. State of the art: The role of CCU and CCS in the industry sector.....	40
3.5. State of the art: The role of CCU and CCS in generating negative emissions.....	41
4. Knowledge gaps.....	43
4.1. CO ₂ utilization.....	43
4.2. Direct air capture.....	48
4.3. Negative emissions in the industry.....	50
4.4. Other knowledge gaps.....	50
5. Conclusion.....	51
Chapter 2 – Presentation and comparison of EPPA and TIAM-FR: Structures and optimization paradigm.....	52

1.	Presentation of TIAM-FR	52
1.1.	Structure of the TIAM-FR model	53
1.2.	Optimization paradigm of TIAM-FR.....	58
2.	The EPPA model.....	62
2.1.	Static component.....	63
2.2.	Equilibrium problem	65
2.3.	Structure of the EPPA7 model	66
3.	Methodological and structural comparison of EPPA7 and TIAM-FR.....	75
4.	Towards a fusion?	78
5.	Conclusion	79
Chapter 3 – Implementation of CCU and CCS in bottom-up and top-down global energy models.....		82
1.	CO ₂ accounting	83
2.	The power sector.....	84
3.	Hydrogen generation.....	87
3.1.	Update of the production processes	87
3.2.	Grey and blue production routes	88
3.3.	Green production routes.....	92
3.4.	Hydrogen trade opportunities.....	94
4.	Biorefineries.....	96
5.	Industry sector.....	97
5.1.	The cement industry.....	98
5.2.	The iron and steel industry.....	102
6.	Direct air capture.....	103
6.1.	DAC in EPPA	103
6.2.	DAC in TIAM-FR.....	107
7.	CO ₂ utilization.....	107
7.1.	CO ₂ to methanol.....	108
7.2.	CO ₂ to methane	110
7.3.	CO ₂ to fuels.....	113
7.4.	CO ₂ mineralization.....	116
8.	CO ₂ transport and storage	117
8.1.	Initial representation and limits.....	117
8.2.	Literature review of CO ₂ transport and storage: costs and potentials	119
8.3.	New modeling of CO ₂ transport and storage	123
9.	Shared Socioeconomic Pathways.....	126
10.	Conclusion	129
Chapter 4 – Exploring the role and potential of CCU, DAC, and industrial negative emissions in the global energy transition.....		130

1. Scenarios.....	130
1.1. Baseline.....	130
1.2. Climate policies.....	131
2. What drives the deployment of CCU?.....	134
2.1. How the climate policy impacts the deployment of CCU?.....	134
2.2. How important is the assumption on CCU cost?.....	135
2.3. How sensitive are CCU investments to hydrogen production costs?.....	136
2.4. Is there a trade-off between CCS and CCU?.....	137
2.5. Can a low-cost DAC help CCU deployment?.....	139
2.6. Conclusion and discussion.....	140
3. Exploring the conditions and implications of deploying direct air capture at scale.....	142
3.1. DAC deployment.....	143
3.2. Implications of DAC deployment.....	148
3.3. Conclusion.....	152
4. Negative emissions in industry.....	152
4.1. The cement industry.....	153
4.2. The iron and steel industry.....	159
5. Key results from EPPA and TIAM-FR: energy, emissions, and CCUS contribution.....	166
6. Conclusion and discussion.....	172
Conclusion.....	174
Limitations and perspectives.....	176
Recommendations.....	178
Appendices.....	180
Appendix 1: Techno-economic characteristics and emissions of fossil power plants equipped with CO ₂ capture in TIAM-FR.....	180
Appendix 2: Techno-economic characteristics of steel manufacturing processes in TIAM-FR....	183
Appendix 3: Deployment of DAC at 380\$/tCO ₂	185
References.....	187

List of figures

Figure 1: CO ₂ capture projects in the world (SCCS, n.d.)	28
Figure 2: Current global shares of CO ₂ utilization.....	29
Figure 3: CO ₂ transport network in the US (NPC, 2019a).....	30
Figure 4: Pipeline of commercial facilities since 2010 (Global CCS Institute, 2022a)	31
Figure 5: Venture capital investments in CCU start-ups for the 2015-2021 period (IEA, 2022c)	32
Figure 6: Diagram of bottom-up and top-down approaches inspired from (Assoumou, 2006).....	37
Figure 7: Generic Modeling in TD models	38
Figure 8: Occurrence of sector-specific capture means in the 23 models of the review.....	44
Figure 9: Occurrence of specific CO ₂ utilization routes	44
Figure 10: Regional disaggregation of the TIAM-FR model.....	53
Figure 11: Representation of time in TIAM-FR	54
Figure 12: Elementary representation of commodity flows and technologies in TIMES.....	55
Figure 13: Reference Energy System (RES) of TIAM-FR.....	55
Figure 14: Equilibrium in TIAM-FR: the user explicitly provides the demand curve, and the model maximizes suppliers' surplus (Loulou and Labriet, 2008)	62
Figure 15: The circular flow of goods and services in EPPA7	64
Figure 16: The expenditure function structure (Chen et al., 2022)	66
Figure 17: Social accounting matrix of EPPA7 (Chen et al., 2017)	68
Figure 18: Spatial disaggregation in EPPA7.....	69
Figure 19: Dynamics for capital stock evolution (Chen et al., 2022)	72
Figure 20: Accounting of CO ₂ fluxes in TIAM-FR	83
Figure 21: Example of a FuelTech for the transport sector and the methanol commodity	84
Figure 22: Input and outputs of power plants with CO ₂ capture in TIAM-FR.	87
Figure 23: Cost of avoided CO ₂ by scenario and technology	92
Figure 24: Hydrogen value chain from production to consumption.	94
Figure 25: Reference Energy System of the cement industry in TIAM-FR	99
Figure 26: Global composition of cement (IEA, 2022h)	101
Figure 27: Maximum CO ₂ emissions by steel producing technology represented in the TIAM-FR model	103
Figure 28: DAC units can either use solar or wind dedicated assets (left and middle) or grid electricity (right)	106
Figure 29: Four assorted designs for CO ₂ conversion technologies in TIAM-FR.....	108
Figure 30: Conceptual block-flow diagram inspired from (Chauvy et al., 2020).....	111
Figure 31: Costs shares of Fischer-Tropsch processes from different studies	115
Figure 32: Nesting structure of Fischer-Tropsch process in EPPA	116
Figure 33: Input/output flows in CO ₂ mineralization processes.	117
Figure 34: Initial RES for CO ₂ Capture Transport and Storage.....	119
Figure 35: Open saline aquifers (left) and closed saline aquifers (right) (Bentham et al., 2014)	122
Figure 36 : Cost of onshore CO ₂ transport depending on CO ₂ flow rate (Smith et al., 2021b)	122
Figure 37 : Cost of offshore CO ₂ transport depending on CO ₂ ship size (IEAGHG, 2020).....	122
Figure 38: Competition between pipeline and shipping to transport CO ₂ (IEAGHG, 2020)	123
Figure 39: New SubRES for CO ₂ transport and storage	124
Figure 40: Comparison of global energy demand profiles between initial assumptions and new estimations considering a SSP2-2°C scenario.	128
Figure 41: Comparison of cement demand projections with initial and new demand scenarios	128
Figure 42: Comparison of steel demand projections with initial and new demand scenarios	129
Figure 43: GHG emissions cap in the NZ70 scenario in EPPA and TIAM-FR.....	133

Figure 44: Amount of CO ₂ captured and utilized in the REF, CB2C and CB15C scenarios by type of CO ₂ and sector from which it was captured.....	135
Figure 45: CO ₂ captured and utilized in the NZ70 scenario with the High, Medium, and Low cost of CO ₂ conversion technologies	136
Figure 46: Cumulative demand for CO ₂ -based products in NZ70 with different cost cases for hydrogen production	137
Figure 47: Global average production cost of hydrogen in the NZ70 scenario	137
Figure 48: Cumulative amount of CO ₂ utilized as a function of CO ₂ TnS costs	138
Figure 49: Global power generation depending on the cost of CO ₂ transport and storage in the NZ70 scenario	138
Figure 50: Global cost of hydrogen over the century depending on the cost of CO ₂ transport and storage in the NZ70 scenario.....	139
Figure 51: Cumulative quantity of CO ₂ utilized as a function of DAC costs in the NZ70 scenario...	140
Figure 52: Comparison of CCU contribution between a conservative and optimistic cases of CCU drivers in the NZ70 scenario.....	141
Figure 53: Shares of regions and countries deploying CCU in the conservative and optimistic scenarios	141
Figure 54: CO ₂ origin and nature in the most pessimistic and optimistic scenarios regarding CCU drivers	142
Figure 55: Emissions profile of the reference scenario with no DAC (NoDAC)	143
Figure 56: Temporal generation of negative emissions of for a medium, low, and very low cost of DAC	144
Figure 57: Cumulative regional negative emissions through DACCS in the Low and Very low cases	145
Figure 58: Regional cumulative negative emissions from DACCS for a Low cost scenario	146
Figure 59: Temporal GHG emissions in Brazil and Indonesia with Medium cost of DAC and penalty on BECCS.....	146
Figure 60: Cumulative regional generation of negative emissions in scenarios with GHG trading across regions (GT) and without GHG trading across regions (NoGT) in a Medium cost DAC case	147
Figure 61: Global electricity generation in a Medium cost with BECCS penalty (right) or not (left)	148
Figure 62: Electricity generation in Brazil and Indonesia in the Medium_BECPen scenario	148
Figure 63: Effect of DACCS deployment to the global price of GHG emissions	149
Figure 64: Effect on DACCS deployment to the price of GHG emissions when emissions trading across regions is disabled.....	149
Figure 65: Range of land use requirements for DACCS units and their power supply (wind or solar) in 2070	150
Figure 66: Regional land use requirements for DACCS in the Medium_NoGT scenario in 2070 (high estimate).....	151
Figure 67: Global CO ₂ emissions from the cement industry in the reference scenario	154
Figure 68: Global CO ₂ emissions of the cement industry in NZ70 and CM0	154
Figure 69: Regional generation of negative emissions for the cement industry in the CM0 and CM0_R scenarios.....	155
Figure 70: Composition of cement in the REF, NZ70, and CM0 scenarios	156
Figure 71: Global composition of alternative aggregates in the REF, NZ70 and CM0 scenarios.....	156
Figure 72: Global production of clinker in the REF, NZ70 and CM0 scenarios	157
Figure 73: Global energy consumption of cement plants	157
Figure 74: Positive and negative CO ₂ emissions from industry in the CM0 scenario	158
Figure 75: Global CO ₂ emissions of the ISI in the reference scenario	159
Figure 76: Temporal evolution of the steel industry in the reference scenario.....	160
Figure 77: Temporal evolution of the final energy used by the steel industry in the reference scenario	160

Figure 78: Biogenic CO ₂ captured from the ISI across scenarios.....	161
Figure 79: Global CO ₂ emissions from the cement industry in the NZ70 and CM0 scenarios	161
Figure 80: Steel production technologies over the 21st century in the IS0 scenario	162
Figure 81: Energy consumption of the ISI over the 21 st century in the IS0 scenario	163
Figure 82: Cumulative scrap use across scenarios.....	163
Figure 83: Temporal evolution of steel cost across scenarios.....	164
Figure 84: Temporal evolution of global steel technologies in the ISB0 scenario	165
Figure 85: Comparison of the final energy mix of steel industries when assuming different biomass efficiencies	166
Figure 86: Emissions profile of TIAM-FR and EPPA in the NZ70 scenario	167
Figure 87: Global primary energy use in the NZ70 scenario.....	168
Figure 88: Global profile of electricity generation in the NZ70 scenario in EPPA and TIAM-FR....	169
Figure 89: Global and sectorial CO ₂ capture in TIAM-FR.....	169
Figure 90: Global hydrogen demand in the NZ70 scenario (results from TIAM-FR).....	170
Figure 91: Global hydrogen production in the NZ70 scenario (results from TIAM-FR).....	170
Figure 92: Fate of the CO ₂ captured in TIAM-FR.....	171
Figure 93: Regional deployment of CO ₂ capture in EPPA and TIAM-FR.....	171

List of tables

Table 1: Techniques, technologies, applications, and existing projects for CO ₂ capture	26
Table 2: Deployment rate of DAC in existing studies	42
Table 3: Overview of CCU modeling methods in energy models and studies	46
Table 4: Techno-economic assumptions of existing studies modeling DAC	48
Table 5: Region-specific capital and labor scalars in TIAM-FR	53
Table 6: Energy services demand and respective drivers	56
Table 7: Global exogenous CO ₂ emissions from land use (in MtCO ₂ /yr) (Ritchie et al., 2020)	57
Table 8: Sectors in EPPA7 and their labels	70
Table 9: Substitution elasticities in EPPA7 (Chen et al., 2022).....	70
Table 10: Advances backstop technologies in EPPA7	71
Table 11: Comparison table of TIAM-FR and EPPA7.....	76
Table 12: Corresponding tables for the region of (Ferrari et al., 2019) and TIAM-FR.....	86
Table 13: Levelized cost estimations for grey and blue hydrogen production routes (Parkinson et al., 2019).....	88
Table 14: Fuel costs by scenario (Parkinson et al., 2019).....	89
Table 15: Assumptions for coal gasification w/wo carbon capture	89
Table 16: CAPEX reduction assumptions for coal gasification with carbon capture (IEA, 2015).....	89
Table 17: Assumptions SMR w/wo carbon capture.....	90
Table 18: CAPEX reduction assumptions for SMR (JRC, 2021) (IEA, 2015).....	90
Table 19: Assumptions for the biomass route w/wo carbon capture	90
Table 20: CAPEX reduction assumptions for biomass gasification with CCS (IEA, 2015)	91
Table 21: CAPEX estimation of fossil and bio-based routes in the Central Scenario.....	91
Table 22: CAPEX estimation of fossil and bio-based routes in the Low Scenario	91
Table 23: CAPEX estimation of fossil and bio-based routes in the High Scenario.....	91
Table 24: Assumptions for the electrolysis process (DNV-GL, 2020).....	93
Table 25: Attribution of future techno-economic parameters for electrolysis processes.....	93
Table 26: Main technical assumptions for shipping	95
Table 27: Techno-economic performances of the hydrogen transport value chain	95
Table 28: Technological characteristics of biorefineries	96
Table 29: Economic characteristics of biorefineries.....	97
Table 30: Range of thermal energy consumption in dry and wet kilns (Sahoo et al., 2018)	98
Table 31: Region-specific stocks of wet and dry cement plants' capacities (in Mt of cement per year) (McCarten et al., 2021).....	98
Table 32: Techno-economic properties of cement plants (unit: ton of clinker).....	100
Table 33: Consumptions and emissions of cement plants (unit: ton of clinker).....	100
Table 34: Different finishing processes for different compositions of cement in TIAM-FR	101
Table 35: Possible uses of biomass in the iron and steel industry in TIAM-FR.....	102
Table 36: Techno-economic parameters of DACCS (NASEM, 2019a) fed with grid electricity in \$2018 in the US	104
Table 37: Techno-economic parameters for DACCS (NASEM, 2019) fed with solar photovoltaics VS wind in \$2018 in the US	105
Table 38: Parametric assumptions for assessment of CO ₂ utilization technologies.....	107
Table 39: Comparison of the techno-economic performances of CO ₂ -to-Methanol processes	109
Table 40: Comparison of the techno-economic performances of CO ₂ -to-Methane processes	111
Table 41: Techno-economic performances of Fischer-Tropsch processes	114
Table 42: Estimations of global potential for CO ₂ storage (Pale Blue Dot., 2020)	119
Table 43: Studies and CO ₂ storage potentials updated from (Selosse and Ricci, 2017).....	120

Table 44: Cost estimation for CO ₂ storage operations as mentioned in (Hendriks et al., 2004).....	121
Table 45: Region allocation between TIAM-FR and IIASA database	127
Table 46: NDCs recalibrated for the regions of TIAM-FR.....	131
Table 47: Ambitions and suitability of scenarios.....	133
Table 48: Case-specific techno-economic assumptions for CO ₂ -based products	134
Table 49: Regional variation of DAC according to WACC and capital scalars	145
Table 50: Biogenic GWP factor values for specific rotation periods	153
Table 51: Techno-economic characteristics of power generation units with carbon capture	180
Table 52: Emissions characteristics of power generation units with carbon capture.....	181

Acronyms

AEEI	Autonomous energy efficiency improvement
BECCS	Bioenergy with CCS
BF	Blast furnace
BOF	Basic oxygen furnace
CAC	Cost of avoided CO ₂
CAPEX	Capital expenditure
CB	Carbon budget
CCGT	Combined Cycles Gas Turbine
CCS	Carbon Capture and Storage
CCU	Carbon Capture and Utilization
CCUS	Carbon Capture Utilization and Storage
CGE	Computable General Equilibrium
CH ₄	Methane
CO ₂	Carbon dioxide
CRC	Capital Recovery Factor
CRTS	Constant returns to scale
CtM	Coal-to-Methanol
DAC	Direct Air Capture
DACCS	Direct Air Carbon Capture and Storage
DACCU	Direct Air Carbon Capture and Utilization
DRI	Direct Reduction of Iron
EAF	Electric Arc Furnace
EFOM	Energy Flow Optimization model
EOR	Enhanced Oil Recovery
EPPA	Emissions Projection and Policy Analysis
ETSAP	Energy Technology System Analysis Program
FGR	Flue gas recycling
FIXOM	Fixed (operation and maintenance) expenditures
FT	Fischer-Tropsch
GAMS	General Algebraic Modelling System
GCCSI	Global CCS Institute
GDP	Gross Domestic Product
GHG	Greenhouse gas
GTAP	Global Trade Analysis Program
GWP	Global Warming Potential
H ₂	hydrogen
HFC	Hydrofluorocarbon
IAM	Integrated Assessment Model
IEA	International Energy Agency
IEAGHG	IEA Greenhouse Gas R&D programme
IGCC	Integrated Gasification Combined Cycles
IPCC	International Panel on Climate Change
ISI	Iron and Steel Industry

LCA	Life Cycle Analysis
LCOE	Levelized cost of electricity
LCOH	Levelized cost of hydrogen
MarkAL	Market Allocation
MeOH	Methanol
MIT	Massachusetts Institute of Technology
N ₂ O	Nitrous oxide
NDCs	Nationally Determined Contributions
NETs	Negative Emissions Technologies
NGCC	Natural Gas Combined Cycles
NH ₃	Ammoniac
NOX	Nitrous oxide
NtM	Natural Gas-to-Methanol
OECD	Organization for Economic Co-operation and Development
OPEX	Operational Expenditure
PC	Pulverized Coal
PEM	Proton exchange membrane
PFA	Pulverized Fly Ashes
PFC	Perfluorocarbon
PtL	Power-to-Liquids
R&D	Research and Development
RES	Reference Energy System
RWGS	Reverse Water-Gas Shift
SAM	Social Accounting Matrix
SF	Sulfate Fluor
SMR	Steam Methane Reforming
SNG	Synthetic Natural Gas
SO ₂	Sulfate dioxide
SOEC	Solid oxide electrolysis cell
SSP	Shared Socio-economic Pathway
TIAM- FR	French version of the TIMES Integrated Assessment Model
TIMES	The Integrated MarkAL-EFOM System
TnS	Transport and Storage
TRL	Technology Readiness Level
UN	United Nations
VAROM	Variable (operation and maintenance) expenditures
VOC	Volatile Organic Compounds
VRE	Variable Renewable Energy

Introduction

Context

This research work responds to one of the greatest challenges of the 21st century, namely the fight against climate change. It is now unequivocal that climate change is due to human activity, and in particular to the use of fossil resources that increases the greenhouse effect. The climate change we are experiencing is already observable: temperatures have increased by +1.1°C on a global scale compared to pre-industrial levels, biodiversity is declining, continental glaciers and polar ice caps are melting, and sea levels have risen by 15cm (IPCC, 2021). Beyond the scientific work, people around the world have experienced global warming in recent years with, *inter alia*, hotter, longer, and drier summers. The IPCC estimates that we are currently on a trajectory likely to heat up our world by 3°C compared to the pre-industrial era, threatening life on Earth.

It is therefore vital to engage in a transition that will allow us to limit global warming, which implies limiting or even eliminating our greenhouse gas (GHG) emissions. These gases are mainly carbon dioxide (CO₂), methane (CH₄), and nitrous oxide (N₂O), which are the result of our use of fossil fuels, our agriculture, and our industry. But eradicating these emissions is not simple and faces environmental, social, economic, and technical challenges. Climate change is therefore a global problem affecting all levels of society, all countries, and all economic sectors.

To face this challenge, the international community has unified around the Paris Agreement, a treaty that was adopted in 2015 by the member countries of the United Nations Framework Convention on Climate Change (UNFCCC). The agreement aims to address the global challenge of climate change by strengthening the efforts of countries around the world to reduce their GHG emissions and limit the rise in global temperature. Under the Paris Agreement, countries have agreed to limit the increase in global average temperature to well below 2°C compared to pre-industrial levels, and to pursue efforts to limit the increase to 1.5°C. To achieve this goal, countries have committed to regularly reporting on their emissions and their efforts to reduce them, as well as to providing financial and technical assistance to developing countries to support their climate action. The Paris Agreement is seen as a significant achievement in the global effort to combat climate change, as it represents a unified commitment by countries around the world to address this critical issue. As of 2021, 196 countries have signed the agreement, and 191 have ratified it.

The solutions to the climate problem are based on two pillars: reducing our consumption and changing our production patterns. The first involves limiting and substituting our demand for energy, food, and industrial products, and the second refers to technical solutions that allow us to decarbonize our energy, food, and industrial products. Technical solutions include energy efficiency measures, energy carriers (electricity, heat, hydrogen) decarbonization, and compensation measures – which consist in counterbalancing emissions by removing CO₂ from the atmosphere. The decarbonization of electricity, heat, and hydrogen can be achieved with the use of renewable energies, nuclear power, or Carbon Capture Utilization and Storage (CCUS) technologies. Offsets can be achieved through CCUS as well as natural solutions such as afforestation, reforestation, biochar. In this research, we focus on the role of CCUS technologies in combatting climate change. Carbon Capture and Storage (CCS) can be distinguished from Carbon Capture and Utilization (CCU) as they denote different fates of CO₂: while the former aims at permanently sequestering CO₂ in the geosphere, the latter employs CO₂ to generate goods, although in some cases, the carbon is likely to be released back into the atmosphere. CO₂ can be extracted from the ground, captured from factory flue gases, or directly captured from the atmosphere. Several capture technologies exist, and they are usually designed according to the content of the flue gas. In view of the numerous solutions, planning is required to evaluate technically feasible pathways

that can achieve the transition by minimizing adverse effects on society, the environment, and the economy.

To this purpose, socio-economic and energy models are built and employed to propose long-term mitigation pathways consistent with ambitious climate targets limiting global temperature elevation to 1.5-2°C. Some of them are optimization models that generally minimize the cost of the transition. Frequently, optimization models are divided into two families: bottom-up (BU) and top-down (TD). BU models focus on the energy sector, and thus are suited to assess the technical feasibility of the transition. TD models represent all economic sectors and interactions between consumers and producers and thus are suited to assess the economic impact of the energy transition. Therefore, they deliver complementary insights into the transition. In addition, if they combine energy modeling with another type of modeling, they are also called Integrated Assessment Models (IAMs) due to their ability to assess and control different facets of the transition at the same time, e.g. climate, environment, economy, energy sector, etc.

Scope and objectives

Objectives

The purpose of this Ph.D. is to explore the value that CCUS might bring to the future energy system and to society in the upcoming transition, by employing socio-technico-economic and climate models at world scale. Therefore, the core work is about implementing CCUS technologies in a BU model and in a TD model in order to investigate the role and potential of CCUS in the global energy transition from two complementary perspectives. Besides, depending on the research question addressed, one or the other of the two models is more appropriate. In this research, the BU model is the French version of the TIMES Integrated Assessment Model (TIAM-FR) and the TD model is the Emission Projection and Policy Analysis (EPPA) model. TIAM-FR is more suited to assess the temporal and sectoral deployment of CCUS technologies in detail, while the EPPA version captures the economic benefits or impacts of CCUS penetration. The main research question addressed in this Ph.D. is to determine how CCUS can help decarbonize the world energy system and industry, using TIAM-FR and EPPA. To this end, the objectives are:

- analyze the findings regarding the utilization of CO₂ in terms of the scale, costs, and regional variability of various uses for representation in the EPPA model;
- enrich the TIAM-FR model with multiple CCUS technologies;
- assess the subsequent infrastructure needs and costs associated with evaluating the realistic nature of the various scenarios;
- analyze the potential decarbonization of industry through CCUS, focusing on the cement industry, iron and steel, hydrogen, and other industries;
- investigate through various scenarios the contribution of different low-carbon options to discuss the role CCUS technologies can play to reach the climate target and global decarbonization of the industry sector.

At the core of this thesis, Chapters 3 and 4 tackle these objectives according to more precise research questions about CCU and negative emissions, determined in Chapter 1.

Scope

This Ph.D. was funded by TotalEnergies but took place essentially in the Center for Applied Mathematics (CMA) of Mines Paris – PSL, in Sophia Antipolis, where I spent my time developing TIAM-FR, and writing the thesis. At the CMA, Dr. Sandrine Selosse supervised my work and provided her expertise on energy modeling and CCUS. From February to April 2022 and during September 2022, I visited the Massachusetts Institute of Technology (MIT) to implement CCUS in the EPPA model,

under the supervision of Prof. Sergey Paltsev and his team who helped me master the model and enrich it with CCUS technologies. From time to time, I also visited my colleagues at TotalEnergies in Paris La Défense, led by Dr. Fabrice Devaux.

Structure

The starting point of this thesis is about understanding what CCUS is in terms of technology, economics, and challenges. The first section of **Chapter 1** is dedicated to an overview of the global capacities of CO₂ capture, CO₂ utilization, CO₂ transport, and CO₂ storage across sectors and across regions. Given the current state of CCU and CCS, we want to explore how they can evolve according to increased energy and material demand as well as climate policies. However, the development of CCS and CCU faces several challenges, e.g. competitiveness, infrastructures, and acceptability. In addition, the chapter introduces the energy prospective discipline and the various methods employed to project the future of CCUS. Indeed, the scientific community is increasingly involved in this discipline, as seen in the IPCC reports, to explore the contribution of different solutions to the global energy transition. This chapter analyzes the findings from prospective studies regarding CCUS and discusses the knowledge gaps that are addressed in Chapter 3 and Chapter 4. Thus, it allows us to articulate the general research question into three research questions relative to the role and potential of CO₂ utilization and CO₂ removal.

Chapter 2 is dedicated to the description of TIAM-FR and the EPPA model. They are first described separately in terms of spatial, temporal, energy, and economic representation. In addition, we depict how the optimization process of the solver of each model operates. This complementary analysis aims at understanding the strengths and weaknesses of both models in order to better exploit them according to the research question we want to address. We further discuss our choice of using them in tandem for the analysis of the results in the fourth chapter.

Chapter 3 is central to this doctoral thesis as it depicts the main improvements and new implementations achieved under TIAM-FR and EPPA. In addition to modeling CO₂ capture, CO₂ storage, and CO₂ utilization, other processes that either compete with or facilitate the deployment of CCS and CCU have also been modeled, such as hydrogen. Indeed, hydrogen can both enhance and compete with CCUS as it can substitute CCS options, notably in the industry sector, but it is also an essential co-reactant in most CO₂ utilization processes. Thus, modeling efforts have been engaged to better understand the place of CCU and CCS among the other decarbonization options. The modeling work includes the power sector which is essential to decarbonize; the hydrogen sector working in tandem with CO₂-to-fuels processes; biorefineries equipped with carbon capture that produce biofuels competing with synthetic fuels; the industry sector, inevitably relying on carbon capture for its decarbonization; direct air capture (DAC) capable of generating negative emissions that can offset hard-to-abate emissions in other sectors; CO₂ utilization pathways including fuels and minerals; and the transport and storage of CO₂, as the final link of the CCS chain. Other modeling work is related to the implementation of Shared Socioeconomic Pathways (SSP), recognized by the modeling community as plausible transition pathways toward global energy system decarbonization, involving geopolitics. This work thus addresses the question of energy and material demand as a solution to fighting climate change. In general, this chapter aims to detail the sources and assumptions, and show how each modeling development was conducted.

In **Chapter 4**, we answer the knowledge gaps highlighted in Chapter 1 with one or both of our models depending on the research questions and the adequacy of the model to answer them. The first analysis concerns the drivers of CO₂ utilization in the global energy transition, notably: the stringency of the climate target, the cost of CO₂ conversion technologies, the cost of hydrogen, the affordability of DAC, and whether a very high cost of CO₂ transport and storage could act in favor of CO₂ utilization. Thus, this section addresses the first knowledge gap expressed in Chapter 1, based on the observation that very few studies attempt to assess the global potential of CCU and its contribution to the industry sector.

The second section analyzes the potential deployment of DAC in a net-zero world, and its implications on the global energy system, the economy, and land use. The third section focuses on the decarbonization potential of the biggest industries, namely steel and cement. The last analysis compares the results of EPPA and TIAM-FR under common assumptions and discusses the deployment of CCUS technologies from these different perspectives.

We conclude by summarizing the work and formulating the limits and perspectives of the results, as well as recommendations addressed to policymakers.

Contributions

Articles in peer-reviewed journals

- Desport, L., Selosse, S., 2022. An overview of CO₂ capture and utilization in energy models. *Resources, Conservation and Recycling* 180, 106150. <https://doi.org/10.1016/j.resconrec.2021.106150>
- Desport, L., Selosse, S., 2022. Perspectives of CO₂ utilization as a negative emission technology. *Sustainable Energy Technologies and Assessments* 53, 102623. <https://doi.org/10.1016/j.seta.2022.102623>
- Desport, L., Gurgel, A., Morris, J., Herzog, H., Chen, H., Selosse, S., Paltsev, S., 2023. Deploying direct air capture at scale: how close to reality? *Energy Economics* 107244. <https://doi.org/10.1016/j.eneco.2023.107244>

Presentation in conferences

- Andrade, C., Desport, L., Seck, G.S., Selosse, S., 2022. Assessing the role of negative emission technologies in the low carbon transition of the iron and steel sector. Presented at the GHGT-16 - 16th International Conference on Greenhouse Gas Control Technologies.
- Andrade, C., Desport, L., Seck, G.S., Selosse, S., 2022. Negative-zero emission opportunities for the Iron and Steel industry on a global scale. Presented at the 16th International Conference on Greenhouse Gas Control Technologies - (GHGT-16) 2022.
- Desport, L., Andrade, C., Selosse, S., 2022. Net-zero emission opportunities for the Iron and Steel industry at a global scale. Presented at the Applied Energy Symposium 2022: Clean Energy towards Carbon Neutrality (CEN2022).
- Desport, L., Andrade, C., Selosse, S., 2022. Trade-offs between CO₂ utilization and CO₂ transport and storage in the global energy transition. Presented at the 16th International Conference on Greenhouse Gas Control Technologies (GHGT-16). <https://doi.org/10.2139/ssrn.4279696>
- Desport, L., Paltsev, S., Morris, J., Herzog, H., Gurgel, A., Chen, H., Selosse, S., 2022. Global economic and environmental impacts of deploying synthetic jet fuels in the aviation sector. Presented at the 43rd IAEE Conference.
- DESPOINT, L., Selosse, S., 2021. The role of carbon capture, utilization and storage in the global energy system: long-term optimization and decarbonation of the industry, in: 1st IAEE Online Conference (The International Association for Energy Economics). Paris (en ligne).

Posters

- Desport, L., Selosse, S., 2020. The role of Carbon Capture Utilization and Storage in the global energy transition: long-term optimization on the industry sector. Presented at the ISDRS conference.

Scientific mediation

Ma thèse en 180 secondes, 2021, Ecole Nationale Supérieure (ENS), 45 Rue d'Ulm, Paris, France.

Classes

- Carbon Capture Utilization and Storage: concepts, challenges, and perspectives. MSc *Optimisation des Systèmes Energétiques*, Mines Paris - PSL, 2021,2022,2023 & MSc *Climate Change and Sustainable Finance*, EDHEC, 2022,2023.
- La décarbonation de l'industrie. Master « Développement Industriel », Université Nice Côte d'Azur, 2020, 2021.

Chapter 1: Perspectives of CCS and CCU

To explore the future of CCS and CCU, it is important to understand the current technological and commercial status, as well as the state of the art of research in the field. Therefore, the first section of this chapter is dedicated to an overview of the global capacities of CO₂ capture, CO₂ utilization, CO₂ transport, and CO₂ storage across sectors and across regions. This section also describes how these activities work technically. Given the current status of CCU and CCS, we want to explore how they could evolve in line with ever-increasing material and energy demand, and climate policies. However, the development of CCS and CCU faces several challenges related to competitiveness, infrastructure, policies, and acceptability, described in Section 2. Prospective models are essential tools to discuss the future of CCUS, and Section 3 introduces prospective modeling. In recent years, the scientific community has become increasingly involved in this discipline, as seen in the IPCC reports. We therefore propose a state of the art of CCUS in prospective studies, focused on different sectors of the economy, namely the power sector, the transport sector, the industry sector, and – more broadly – regarding the generation of negative emissions. Finally, Section 4 identifies and discusses the knowledge gaps related to CCUS in prospective studies.

Pour explorer l'avenir de la CCS (capture et stockage du CO₂) et du CCU (utilisation du CO₂), il est important de comprendre le statut technologique et commercial actuel, ainsi que l'état de l'art de la recherche dans le domaine. La première section de ce chapitre est consacrée à un aperçu des capacités mondiales de capture du CO₂, d'utilisation du CO₂, de transport du CO₂ et de stockage du CO₂ dans tous les secteurs et régions. Cette section décrit également le fonctionnement technique de ces activités. Étant donné l'état actuel du CCS et CCU, nous voulons explorer comment ils pourraient évoluer en fonction de la demande croissante en matières et en énergie, ainsi que des politiques climatiques. Cependant, le développement du CCS et du CCU est confronté à plusieurs défis liés à la compétitivité, à l'infrastructure, aux politiques et à l'acceptabilité, comme décrit dans la Section 2. Les modèles prospectifs sont des outils essentiels pour discuter de l'avenir du CCS et du CCU, et la Section 3 introduit la modélisation prospective. Ces dernières années, la communauté scientifique s'est de plus en plus impliquée dans cette discipline, comme le montrent les rapports du GIEC. Nous proposons donc un état de l'art du CCS et du CCU dans des études prospectives, axées sur différents secteurs de l'économie, notamment le secteur de l'énergie, le secteur des transports, le secteur industriel et, plus largement, en ce qui concerne la génération d'émissions négatives. Enfin, la Section 4 identifie et discute des lacunes de connaissance liées au CCS et CCU dans des études prospectives.

1. Overview of CO₂ capture, CO₂ utilization, CO₂ transport, and CO₂ storage across the world

1.1. CO₂ capture

CO₂ capture is not a recently discovered technique; technologies such as amine-based CO₂ capture and CO₂ separation have been employed since the 1920s in the petrochemical industry to separate the CO₂ usually found in natural gas from saleable gaseous hydrocarbons. During this process the CO₂ is simply removed and released into the atmosphere. It was not until the early 2000s that scientists began to devise other techniques and technologies to avoid releasing CO₂ into the atmosphere. There are four major techniques and various technologies classified in Table 1.

Table 1: Techniques, technologies, applications, and existing projects for CO₂ capture

Technique	Technologies	Example of application	Existing pilots, demonstrations, and commercial units
-----------	--------------	------------------------	---

Post-combustion capture	Chemical absorption, Chemical adsorption, membranes, cryogeny	Coal-fired power plants, natural gas combined cycle, cements plants, steel mills, etc.	Quest (Duong et al., 2019), Boundary Dam and Petra Nova (Mantripragada et al., 2019)
Pre-combustion capture	Gasification, cryogeny reverse water gas shift reactors	Integrated gasification combined cycle, Steam methane reforming, Coal-to-Liquids, etc.	Weyburn (Plasynski et al., 2008), Great Plains (NETL, n.d.)
Oxy-combustion capture	Cryogeny	Natural gas combined cycle, cement plants	Schwarze Pumpe (Global CCS Institute, 2012),
Process capture	Chemical absorption, chemical adsorption, membranes, cryogeny, calcium looping	Cement plants, steel mills, ethanol plants, Refineries, gas processing	Sleipner (Baklid et al., 1998), IL-ICCS (SCCS, 2022)

Post-combustion capture refers to the capture of CO₂ diluted in flue gas streams after the combustion of hydrocarbons. The concentration of CO₂ varies from 3% to 14% depending on the nature of the fuel (Kothandaraman et al., 2019). Post-combustion capture can be achieved through chemical absorption, i.e., the CO₂ reacts with a liquid solvent; chemical adsorption, i.e., the CO₂ reacts with a solid sorbent; membranes, i.e., the CO₂ is separated from the other components through a filter; or cryogeny, i.e., the flue gas is cooled to the liquefaction temperature of CO₂.

Pre-combustion capture refers to the removal of carbon atoms from the fuel, before burning it. It requires a gasification reactor in which the fuel is decomposed into H₂, H₂O, CO, CO₂, CH₄, and other light molecules. The CO₂ is then separated from the other components through cryogeny or a reverse water gas shift (RWGS) reactor.

Oxy-combustion capture consists in burning the fuel with pure oxygen rather than air to perform perfect combustion whose flue gas is composed of almost pure CO₂. Then the CO₂ only needs to be collected. Thus, there is no CO₂ capture unit as such in oxy-combustion capture but rather an air separation unit (ASU) that cryogenizes ambient air to recover pure O₂.

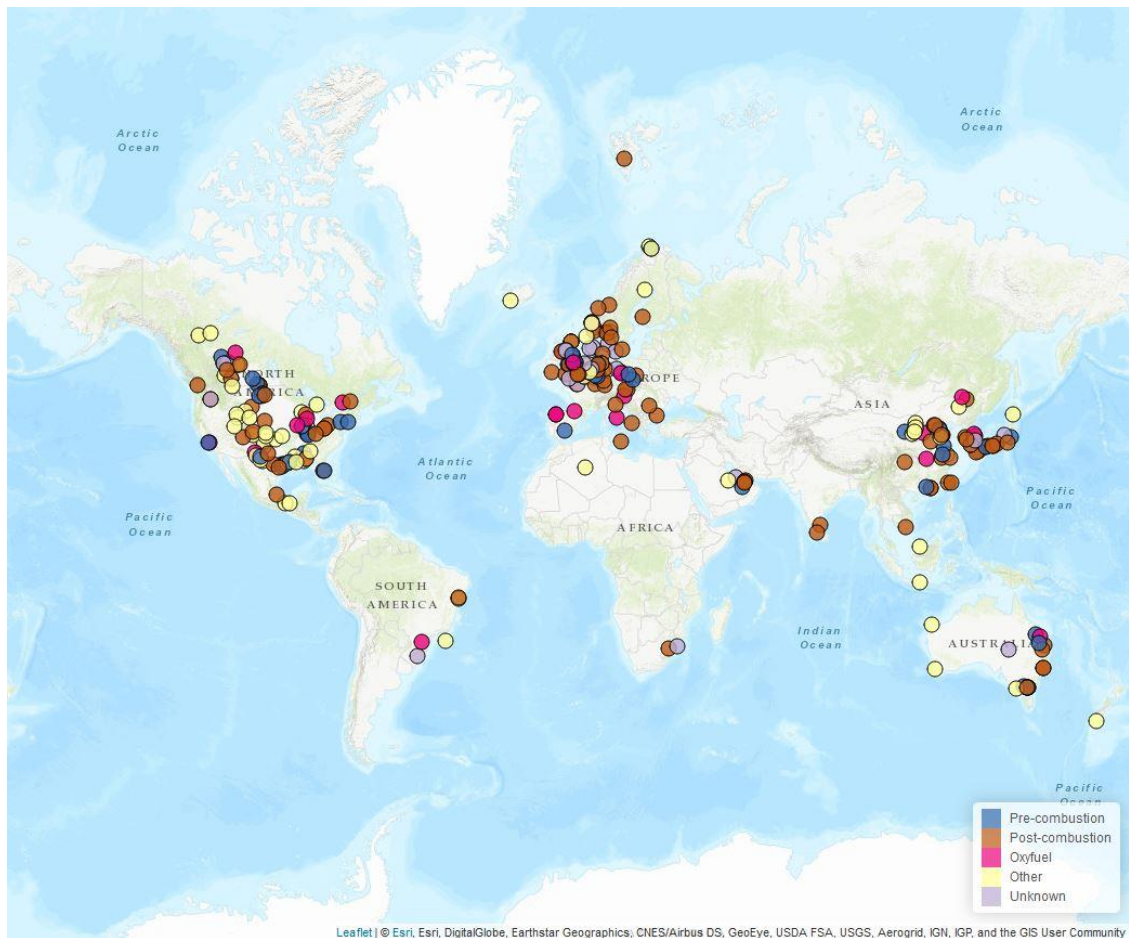

Figure 1: CO₂ capture projects in the world (SCCS, n.d.)

Anthropogenic CO₂ emissions are not only due to fuel combustion, they are also a product of chemical reactions caused by human activities. Notably, the cement, steel, and chemical industries were responsible for the emissions of so-called process emissions by 2.1 Gt/y in 2019 (IEA, 2022a). These emissions can be captured by the aforementioned technologies and specific technologies such as calcium looping in the case of cement.

Today, there are 35 commercial operating facilities in the world that capture CO₂ for different purposes. The following map (Figure 1) represents the existing CO₂ capture projects in the world at different stages of development (from operational to finished or cancelled) (SCCS, n.d.). It clearly illustrates that the leading countries are located in North America, Brazil, Europe, the Gulf States, China, Japan, South Korea, and Australia. Most of these projects capture carbon from existing coal power generation.

1.2. CO₂ utilization

The utilization of CO₂ is not recent either. Although it is an inert molecule, it has some advantages in the manufacture of industrial goods. Globally, 230 MtCO₂ are used every year to manufacture urea, in enhanced oil recovery (EOR), and for other minor applications including beverage production, horticulture, cooling, and fire extinguishers (IEA, 2019a). Urea is the most widespread fertilizer used in agriculture (Z. Zhang et al., 2020), and is manufactured by reacting CO₂ with ammonia (NH₃). EOR consists in pressurizing an oil field with CO₂ to recover the fuel. When used in greenhouses, CO₂ optimizes the photosynthesis of flora. The shares of current CO₂ utilizations are given in Figure 2. Other applications include electronics, pneumatics, pulp and paper, coffee decaffeination, wine-making and pharmaceutical processes (Global CCS Institute, 2011). The CO₂ used globally is not captured upstream but mostly recovered on site as a co-product of chemical processes, except for some EOR projects in the US for which the CO₂ is extracted from the ground.

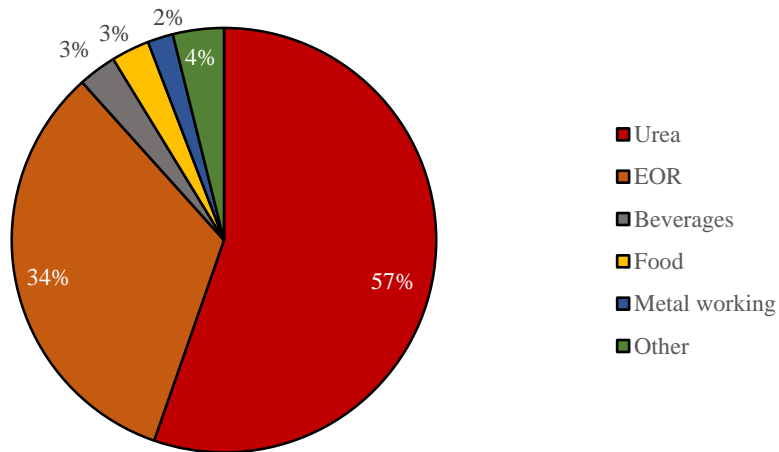

Figure 2: Current global shares of CO₂ utilization

Thus, two technological pathways of CO₂ utilization can be differentiated: direct utilization of CO₂ (DUC), and conversion of CO₂ into a valuable product in which CO₂ is a co-reactant. Direct utilization of CO₂ aims at employing the chemical properties of the carbon dioxide molecule in industrial processes as a utility, thus participating in the manufacture of a final product that does not contain CO₂. The concept of CO₂ conversion is not to run a process, but to utilize CO₂ as a feedstock – a reactant or a co-reactant – in order to transform it into a valuable product. Ultimately, CO₂ is retained in the final product, which is not the case for DUC processes. However, when consuming the final product, CO₂ can be released back into the atmosphere. Considering the aforementioned examples, the CO₂ used to make sparkling beverages is released when opening a can, and urea decomposes into nitrogen and CO₂ when spread on fields. In addition, in EOR fields, the CO₂ may leak or may result in fossil CO₂ emissions anyway since it can be used to recover petroleum products. Therefore, CO₂ is not currently employed in a way that mitigates CO₂ emissions in these situations, but rather as a utility for producing goods. Other pathways for CO₂ utilization enabling CO₂ emissions mitigation are described in Chapter 3.

1.3. CO₂ transport

CO₂ can be transported from one place to another when the location of the capture site does not match with a CO₂ sink or a CO₂ utilization facility. In the US, CO₂ has been extracted from the Rocky Mountains (Wyoming and Colorado) for decades, from which it is transported to EOR fields in Texas or North Dakota. Stretching over 8,000 kilometers, the first and only CO₂ pipeline network has operated in the US for more than 40 years, transporting more than 66 Mtpa (NPC, 2019a). To be transported, the CO₂ needs to be compressed and cooled to reach a supercritical state at which it has the density of a liquid but flows like a gas. This solution minimizes losses and ensures the routing of CO₂.

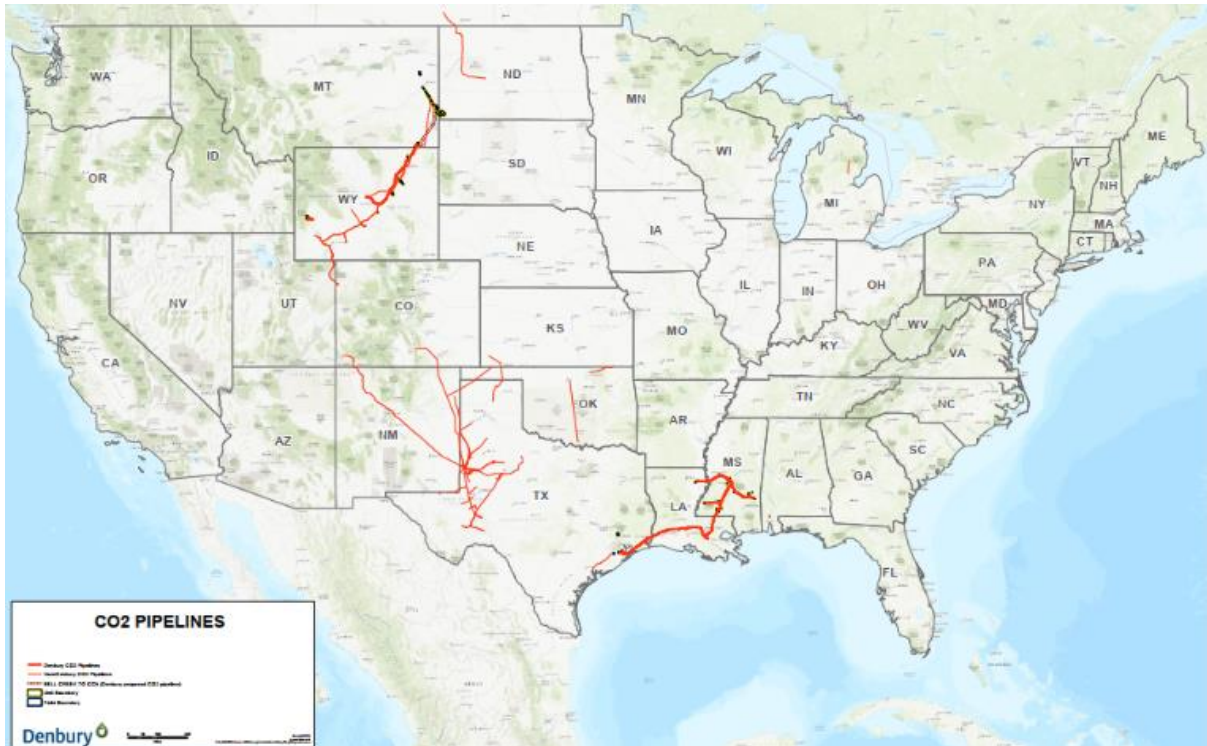

Figure 3: CO₂ transport network in the US (NPC, 2019a)

Alternative CO₂ transportation solutions include rail, barges, trucks, and shipping. The latter is promising, as ships can transport CO₂ in large quantities to different offshore CO₂ storage sites, unlike pipelines which are inflexible infrastructures. The first CO₂ shipping project called *Langskip* was announced in 2020 in Norway and aims at shipping 1.5 Mtpa for 25 years from different capture sites in Northern Europe to offshore CO₂ storage wells in Norway (IEA, 2022b). Thus, the USA and Norway are the only countries where large-scale transport projects have been or are currently being developed.

1.4. CO₂ storage

Once CO₂ is captured and transported to a storage site, it can finally be buried underground in order to avoid emitting this CO₂ into the atmosphere. CO₂ storage consists in trapping CO₂ into geological formations so that the CO₂ is permanently sequestered. There are four ways to trap CO₂ into geological formations:

- structural and stratigraphic trapping occurs when CO₂ rises to the surface due to its low density but is trapped by impermeable concave rocks;
- residual CO₂ trapping refers to the porosity of the rock, i.e., the CO₂ gets trapped by the pores of the rock;
- CO₂ can also solubilize with underground brines;
- after several years of injection, the CO₂ reacts with the rocks under certain pressure and temperature conditions. It thus solidifies underground. This phenomenon is called mineral trapping.

Throughout the life of the CO₂ storage project, the injection is controlled, and these aforementioned phenomena are monitored for safety issues.

There are different configurations for geophysical wells: depleted oil fields, depleted gas fields, and saline aquifers. Depleted hydrocarbon reservoirs are accessible, well-known reservoirs but may have lower capacities than saline aquifers. These wells can either be onshore or offshore. Onshore storage sites are also more accessible than offshore sites albeit subject to social acceptance issues (see Section 2.5).

If the CO₂ stored is climate-neutral, i.e., it has been captured from biomass combustion or directly from the atmosphere, then CO₂ storage can also bring so-called negative emissions, referring to the removal of CO₂ from the atmosphere. This clearly is an advantage compared to the utilization of CO₂, since most CO₂-based products eventually release the CO₂ back to the atmosphere when they are consumed.

Currently, there are 30 commercial storage sites of which 27 correspond to EOR storage (SCCS, n.d.) situated in North America, Europe and Asia. This represents a capacity of 42.5 MtCO₂ per year (Global CCS Institute, 2022a), or roughly 1% of global CO₂ emissions (land use not included) (Ritchie et al., 2020). The pioneer CCS project was the Sleipner project with a capacity of 1 Mtpa captured and stored on a Norwegian offshore gas platform in the North Sea. The CO₂ is injected in an offshore saline aquifer 800 meters below sea level (Eiken et al., 2011).

1.5. Dynamics

On the one hand, the prospects for CCS were explored a long time ago by the scientific community, with a first synthesis report on CCS published in 2005 (IPCC, 2005). However, commercial projects and investments in CCS have not experienced an expansion similar to renewables. Only recently, the number of commercial projects at early and advanced development stages has increased significantly (Figure 4), with potentially more than 250 Mtpa of CCS in the coming years. This recent increase in investments can be explained by the pressure exerted by climate commitments.

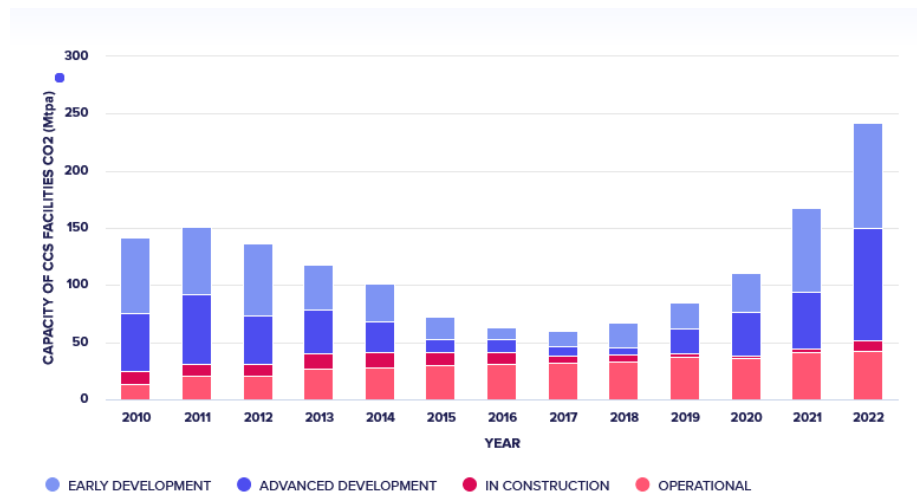

Figure 4: Pipeline of commercial facilities since 2010 (Global CCS Institute, 2022a)

On the other hand, CO₂ utilization is well established in industrial processes, mainly for EOR and fertilizers, but alternative CO₂ utilizations addressing the problem of emissions reductions have only aroused interest in recent years (Figure 5).

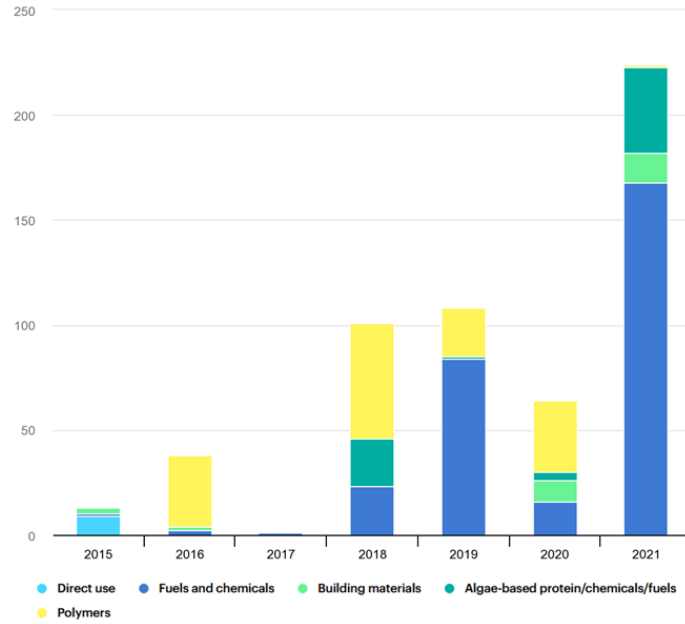

Figure 5: Venture capital investments in CCU start-ups for the 2015-2021 period (IEA, 2022c)

2. Towards the deployment of CCU and CCS: what are the challenges?

2.1. Techno-economic challenges

A major drawback of CCU and CCS is the expense of the operations and the capex-intensive investments, which applies to every link of the CCUS chain. Moreover, CCUS operations rely on considerable energy requirements.

As the first link of the chain, CO₂ capture is frequently criticized for its high cost (Bui et al., 2018). The cost of carbon capture can be expressed in terms of CO₂ avoided, considering the LCOE¹ with and without CO₂ capture (resp. $LCOE_{wCC}$ and $LCOE_{woCC}$), and the emissions with and without CO₂ capture (resp. $Emissions_{wCC}$ and $Emissions_{woCC}$):

$$Cost\ of\ avoided\ CO_2 = \frac{LCOE_{wCC} - LCOE_{woCC}}{Emissions_{woCC} - Emissions_{wCC}}$$

Techno-economic studies in particular have assessed that CO₂ capture concepts are capex-intensive (Ali, 2019; David and Herzog, 2000), and that operations are more expensive for units that have diluted CO₂ in their flue gas (Budinis et al., 2018; Naims, 2016; Rubin et al., 2015). Estimations of the cost of avoided CO₂ are in the range of \$50-130/tCO₂, but for configurations where the CO₂ stream is almost pure or very concentrated, the cost of avoided CO₂ could be in the range of \$20/tCO₂ (IEA, 2021a; Irlam, 2017; Leeson et al., 2017). Another concern regarding CO₂ capture is the energy penalty, representing the additional energy required and provided by the plant itself to capture its own CO₂, compromising its overall efficiency. The penalty, expressed as the percentage of incremental energy, can exceed 50% (Gustafsson et al., 2021; House et al., 2009) but the average value is around 30% (Vasudevan et al., 2016).

The challenges related to CO₂ utilization mainly concern the cost of hydrogen since most CO₂-based products are manufactured with the H₂ molecule, e.g., synthetic jet fuels, methane, and methanol. Indeed, manufacturing low-carbon hydrogen through electrolysis or CCS is capital intensive. Therefore, this process represents a substantial risk for investors. Chauvy et al. (2019) determined that CO₂-based

¹ Levelized Cost of Electricity.

formic acid, salicylic acid, and urea are the only options that could compete with conventional routes to date (Chauvy et al., 2019). Zhou et al. (2022) concluded that synthetic jet fuels are currently roughly 8 times more expensive and could remain at least twice as expensive in 2050 (Zhou et al., 2022). Pérez-Fortes et al. (2016) found that synthetic methanol was almost twice as expensive as conventional methanol for an H₂ breakeven cost of 1.4 \$/kg (Pérez-Fortes et al., 2016). A major barrier facing CCU deployment is the unavailability of technologies (low TRL) at different levels of the value chain. While capture and transportation of CO₂ have been successfully carried out for years, the conversion processes, direct utilization of CO₂, and utilization of CO₂-based products are not yet mastered. Some pathways sure are at the commercial stage (EOR, urea production) but are not considered to be beneficial for the environment and emissions mitigation. Moreover, current technologies that convert and enhance CO₂ into other valuable products are highly energy consuming. In addition, they often require high temperatures and pressure that only fuels can bring, whereas electricity is not suitable for this kind of requirement. These fuels may be bio-based or low-carbon hydrogen, but the high energy requirements of the processes require large surfaces and installed low-carbon power generation. Furthermore, the impact of CCU processes on GHG emissions appears limited. For many usages of CO₂-based products, such as fuels and chemicals, the sequestration is short to medium-term, i.e., it has no or low interest for climate mitigation, except if such pathways avoid emissions compared to the conventional process. Even when climate-neutral CO₂ is used, de Kleijne et al. (2022) studied the global warming potential (GWP) factors of CO₂-based products that eventually release the CO₂, and proved that these CO₂-based products are only effective if they retain the CO₂ for more than 25 years (de Kleijne et al., 2022). Other studies have also claimed that the GHG mitigation potential of CCU is much lower than that of CCS (Abanades et al., 2017; Cuéllar-Franca et al., 2019; Cuéllar-Franca and Azapagic, 2015).

2.2. Market-related challenges for CCU

Other non-technical barriers specific to CCU are market related, first because the current demand for CO₂-based products (mainly fertilizers) is still low and not expected to grow substantially (IEA, 2019a). However, some CO₂-based products such as synfuels can benefit from their high substitutability for current products.

Second, chemicals and fuels markets are difficult to penetrate because they are already saturated, capital-intensive and highly competitive (de Pee et al., 2018). To date, EOR is the only CO₂ utilization process that can compete with conventional processes (Hepburn et al., 2019), thus stakeholders have no interest in investing in other CCU options for now. Finally, chemical and fuel markets are difficult to penetrate because they are already saturated, capital-intensive and highly competitive (de Pee et al., 2018). As a result, we find it difficult to imagine new players entering the market with products manufactured via CCU given the current conditions. It is much more likely that incumbent stakeholders will retrofit their existing assets with CCU. Competition also occurs between other equally useful low-carbon options for decarbonizing the various sectors of an energy system (van Ewijk and McDowall, 2020). In general, investors choose the cheapest technology to satisfy energy demand as they usually perform a cost minimization. Given the wide pallet of possibilities, CCU options are not likely to rank high in the merit order in most cases.

2.3. Infrastructures

Since emission points do not generally match with storage and utilization sites, infrastructure to transport the CO₂ is vital to the carbon capture industry. As previously mentioned, this is currently the weakest link in the chain. The US is the only country to have developed a large network, but its operation is mainly focused on recovering oil rather than other – more efficient – storage options.

Building so-called “CO₂ hubs”, which consists in concentrating the industries requiring CO₂ as feedstock with other emitting CO₂ within a nested web, would help to decrease the infrastructure costs involved in transporting CO₂ (Bui et al., 2018; IEA, 2019b). The principle of CO₂ hubs is to create

synergies between capture units, renewable energy generation, smart grids, CO₂ utilization units, and CO₂ wells (Sandalow et al., 2019). Such hubs are currently at development stages in Europe (IOGP, 2019). In any case, it will be necessary to build CO₂ pipelines, and governments have an important role to play in supporting these infrastructures and in building business models for CO₂ hubs (IEA, 2020a; Kapetaki et al., 2019). Besides, cross-country pipelines are needed to move CO₂ safely, more efficiently, and more affordably (Carbon Capture Journal, 2022).

Regarding CCU, low-carbon hydrogen and electricity are crucial. Low-carbon electricity is both a competitor and a promoting agent for CO₂ utilization because a large part of CO₂-based products can be manufactured through electrochemical conversion processes that are cost-driven by electricity, whose price is less volatile than that of hydrocarbon, providing more stable feedstock. Dedicated low-carbon electricity is thus a lever that can ensure processes to avoid CO₂ emissions compared to conventional processes. This option would prove even more interesting if this low-carbon electricity could be generated at costs below \$50/MWh (de Pee et al., 2018). Likewise, hydrogen is both a competitor and a co-reactant of some CO₂ utilization processes. The clean production of hydrogen is an important milestone for CCU deployment. To illustrate the importance of this lever, Dutta et al. (2017) explored the potential of CO₂-based products when the availability of renewable hydrogen varies and confirmed that the potential for CO₂-to-fuels is way greater when renewable H₂ is an unlimited resource (Dutta et al., 2017).

As for many novel technologies, process scaling is a well-known lever to improve the efficiency of processes and reduce costs (Kim, 2021; Mauler et al., 2021; Yoshida et al., 2021). Wind power generation has proved that scale expansion enables savings (Wiser et al., 2021). This solution is also recommended for electrochemical conversions (Luna et al., 2019), because electrolysis could gain much by scaling up its production capacities (Morgan et al., 2013).

2.4. Policies

Over and above technical levers, the development of CCUS could also benefit from effective policies. The following list enumerates three main policy levers that would drive CCU and CCS deployment:

- CO₂ pricing that attributes a value to CO₂, which would enhance CO₂ utilization and steer CO₂ capture projects;
- policy incentives developed by countries in order to lower the capital cost of CCU and CCS installation;
- legal and policy frameworks to ensure fair competition between actors, and to avoid regional actors being penalized by others.

The main existing policies are implemented in North America and include:

- financial incentives for CCUS projects in the US through the Inflation Reduction Act (Global CCS Institute, 2022b);
- the 45Q section tax credit in the US, first introduced in 2008 to subsidize CO₂ storage projects (IEA, 2022d);
- tax credit in Canada of 37.5% for all types of CCUS equipment (IEA, 2022e).

It is often argued that the financial costs of CCUS are too high to be endured in the long term (IEA, 2021a; Irlam, 2017; Leung et al., 2014). Nevertheless, industrials need equipment, systems, and technological advancements to ensure that CCUS can become competitive, instead of depending on government subsidies or tax credits.

2.5. Acceptability

As for all alternative ways of providing public services or goods, the acceptability and public acceptance² of CCS and CCU constitute a major challenge. Concerning CCS and CCU, the issue has been largely addressed in the past 10 years, especially in Western Europe, and particularly in Germany. Hence, the factors influencing public support are well known: information, understanding of risks and benefits, and cultural differences that make people more skeptical in some countries than others (Karimi and Toikka, 2018). Notably, the level of concern of laypeople is crucial to ensure that new technologies are accepted.

Regarding CCS, the negative perception of the public is a major challenge in the diffusion of the technology. Researchers have found that information about the technology and its functioning makes CCS more acceptable (Saito et al., 2019; Whitmarsh et al., 2019). Understanding the potential risks, i.e., leakages, CO₂ blowouts, and seismicity, is as important as understanding the benefits, i.e., positive climate impacts and a smoother ecological transition. Notably, it has been found that biomass with CCS is better accepted than coal-fired plants with CCS (Dütschke et al., 2016; Linzenich et al., 2019; Whitmarsh et al., 2019), which suggests that the origin of the carbon matters due to its effect on climate change. Similar observations have been reported for CCU. (Offermann-van Heek et al., 2018) noted that the CO₂ source and whether it needs to be transported influences public acceptance. Therefore, information about projects involving CCU is again relevant to determine its acceptability (Offermann-van Heek et al., 2018). This information includes health concerns, the quality of CO₂-based products, and sustainability risks, although these concerns remain quite low (Arning et al., 2017). In fact, it has been proven that the acceptability of CCU is higher than that of CCS (Linzenich et al., 2019; Strategy CCUS, 2022; Whitmarsh et al., 2019). Overall, it is not carbon capture *per se* that raises concerns, but the fate of the CO₂ captured. Another common result of studies related to acceptability of new technologies is that CCS suffers from the *Not In My Backyard* phenomenon, meaning that social acceptance of CCS is higher than local acceptance of CCS. In other words, while people tend to be in favor of combating climate change with CCS, they do not want to sleep on a CO₂ reservoir mattress (L'Orange Seigo et al., 2014).

Overall, it is important for policymakers and researchers to consider the factors influencing social acceptance of CCU and CCS when evaluating their potential to contribute to climate change mitigation efforts. An example of such efforts in the research field is the studies carried out by (d'Amore et al., 2021, 2020), in an attempt to optimize both economic benefits and social acceptance of CCS projects in Europe. They found that an intermediate solution exists between the two, suggesting that it is worth increasing public acceptance with a moderate additional cost of the supply chain (+8%). More recently, van der Zwaan et al. (2022) demonstrated the global impact of limited CCS diffusion as a consequence of limited public acceptance of CCS technologies. They conclude that the limitation of CCS diffusion has non-negligible effects on the energy system: reduced electricity generation, reduced industrial final energy use, and high net additional costs of up to \$800 billion per year by 2050 (van der Zwaan et al., 2022).

3. Projecting the future of CCU and CCS with prospective energy models

Now that we have established the current status of CCUS and its challenges, we introduce an approach that enables us to project the possible futures of CCU and CCS through the 21st century. Prospective is employed by different types of models. The first subsection below introduces this discipline and details how models employ it. We then review the knowledge established by prospective studies on how CCS and CCU can contribute to attaining climate ambitions. We propose a sector-specific state-of-the-art

² Acceptability refers to an *a priori* acceptable concept while acceptance refers to an *a posteriori* project.

regarding the power sector, fuel supply, the transport sector, the industry sector, and negative emissions. Incidentally, it is quite clear that CCS has an extremely limited role to play, if any, in the transport, residential, and commercial sectors. Some technical studies have imagined the implementation of mobile CO₂ capture units on vehicles (Luo and Wang, 2017; Schmauss and Barnett, 2021; Sharma and Maréchal, 2019), but none of these technologies are considered in energy models.

3.1. Introduction to prospective energy modeling

Prospective modeling refers to a discipline that relates to the exploration of the future. It can be used to describe something that is expected or likely to happen, or something that is currently being planned or considered. For example, a prospective study is a type of research that is designed to look at events or outcomes that could occur. Thus, prospective research aims at exploring the future using our knowledge of the present and our expectations for the future. While forecasting studies aim at predicting the future in the short and medium terms, prospective studies do not aim at predicting the future. In addition, they attempt to shed light on the consequences of decisions and choices made today.

Gaston Berger, a French mathematician, formulated the essence of prospective modeling as a discipline that relies on events no one can fully capture: “the past is not the past anymore, the future is not yet.” The need for prospective models became particularly apparent in the 1970s when the Club of Rome started thinking about the impact of progress on the environment. Initiated by Aurelio Peccei, this approach puts into perspective the idyllic idea that progress is good for both human well-being and the environment. The group aimed at understanding the main challenges the world was facing, resulting in the elaboration of the first mathematical model whose purpose was to assess the global long-term effect of economic growth through 5 variables: population, life quality, investments, natural resources, and pollution. Their works delivered a report entitled *The Limits to Growth*, whose conclusion give a very dark future of an economy likely to “overshoot and collapse” (Meadows et al., 1972).

The IPCC started summarizing the prospective scenarios of the scientific literature in their first assessment report (IPCC, 1990), whose conclusions were used at the Rio Convention in 1992. As the long-term future is highly uncertain and subject to many parameters, prospective modeling is employed through scenarios whose results are analyzed and discussed on the basis of their assumptions. These scenarios can assume different paradigms for the future related to:

- policy measures, which can refer to economic incentives such as subsidies or carbon taxes;
- climate or environmental constraints, such as limiting the global temperature rise to 1.5°C and carbon budgets;
- technology costs and technical feasibilities, i.e., as specific technologies are still not well-known, scenarios related to their future costs and availabilities can be imagined;
- econometric principles governing consumer behavior.

One can distinguish two branches of energy models: energy system models (ESMs) and value chain models (VCMs). On the one hand, ESM focus on modeling the energy system by considering several options for decarbonization, i.e. electrification, low-carbon fuels, CCUS, carbon dioxide removal (CDR), policies, and demand reduction. Therefore, many technologies can help mitigate GHG emissions, and these models need to represent different value chains to capture the competition between them (e.g., hydrogen, biomass) and deliver a realistic assessment of future needs. On the other hand, value chain models (VCMs) focus on specific chains. In the case of CCUS, all technological steps are considered, from capture sites to utilization sites, comprising transport and the many other processes involved, such as storage, trade, etc. VCMs can be employed to study the optimal design of a CCUS project. This ensures a detailed, comprehensive representation of the chain and may capture information that ESMs cannot grasp in terms of technology feasibility and details, as well as geographical constraints and technology insertion into the geographic scope of the current energy system.

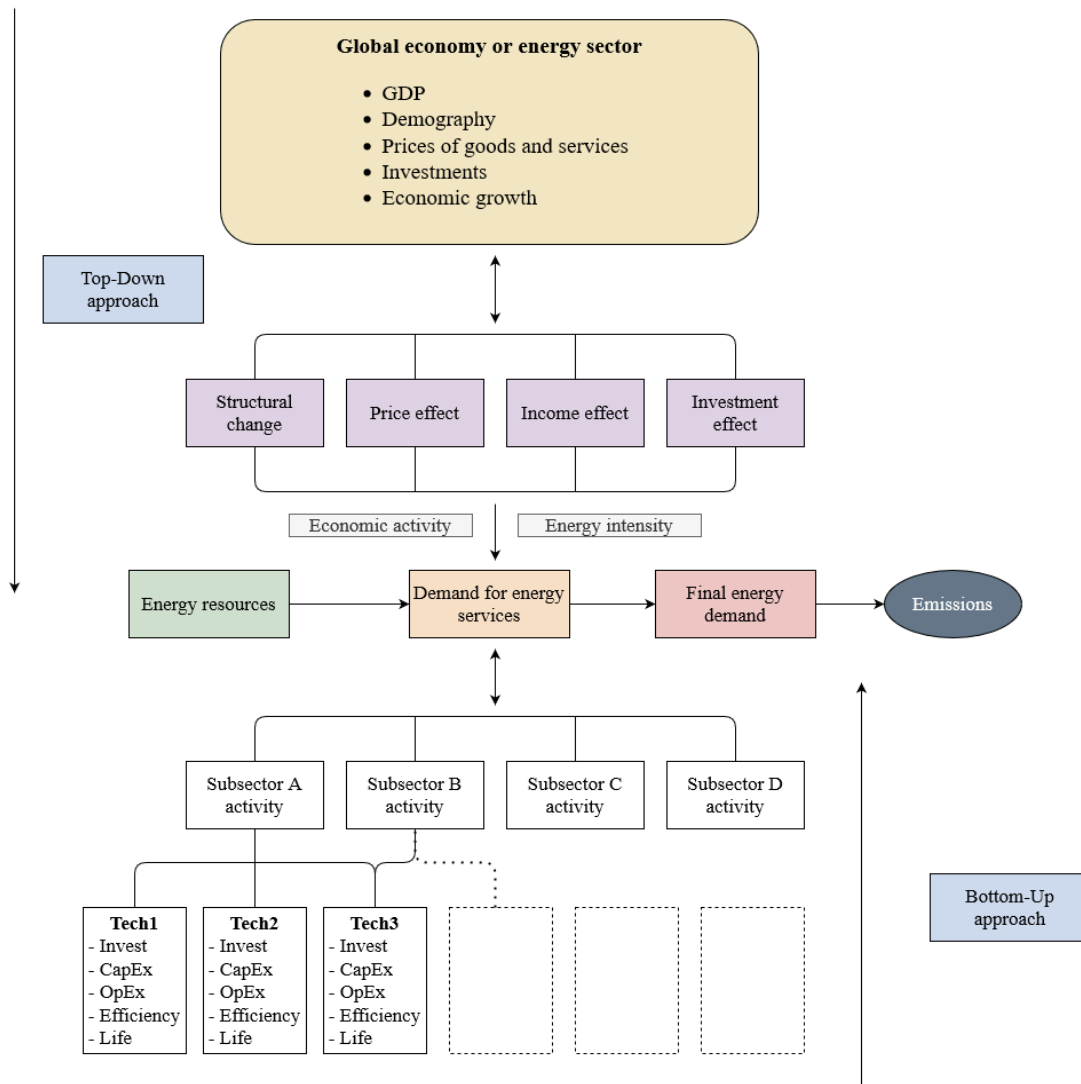

Figure 6: Diagram of bottom-up and top-down approaches inspired from (Assoumou, 2006)

Thus, the scope studied in VCMs and ESMs is not the same, the former being more specific and focused on a unique supply chain, while ESMs integrate several chains. Generally, ESMs are utilized in prospective studies attempting to forecast a sustainable path to reach energy system decarbonization. Consequently, these models are time dynamic, i.e., they solve multi-period problems based on optimized solutions, and need to parametrize the value chains, mainly with techno-economic and environmental performances. Conversely, VCMs do not usually deliver results over time, but propose a new static way of including value chains in the current energy mix to mitigate a determined quantity of carbon. Taking the example of CCUS, VCMs often need to parametrize their modeling with geographical data on the location of capture, utilization, and storage sites. To be more specific, the ESM family includes two members, namely bottom-up (BU) and top-down models (TD), that are distinguished by the way they integrate and represent the energy sector.

BU models are characterized by their high level of technological detail. The models' rich representation of the energy system enables the modelers to describe any process in a complete way, including energy, material and pollutant flows, and the economic and financial properties related to an investment, including capital costs, operation costs, lifetime, discount rate, etc. (Sathaye and Sanstad, 2004). These data are most often extracted from existing techno-economic studies (Algehed et al., 2009), which explains the high diversity of inputs from one model to another. Such a need for an extensive database constitutes a major drawback for BU models. BU models mainly try to determine an optimal framework

that minimizes the total annual cost of fulfilling energy demand or maximizing energy efficiency by selecting the appropriate technologies under several constraints, e.g., potentials and availability of resources, carbon tax, or GHG emissions limited to an upper bound. The results vary from one model to another depending on the level of temporal, spatial, technical and economic detail, as well as the ability of models to consider sector coupling (Prina et al., 2020). These models are mainly addressed at decisions-makers in search of robust strategic planning of energy generation in respect of climate goals. Nevertheless, BU models are criticized for providing results with poor behavioral and economic realism (J.-C. Hourcade et al., 2006). Since they only model the evolution of an energy system over time, they are unable to assess the future demand for energy services across sectors, which is highly dependent on interactions with the rest of the economy. Therefore, these models need to be fed with exogenous energy demand forecasts (Helgesen, 2013) which can be imported from TD models (Loulou and Labriet, 2008). TIMES models are good examples of BU models (ETSAP, 2021, p. 2021).

Indeed, TD models are based on the interactions between the energy system and the rest of the economy, notably through econometric techniques and computable general equilibrium (CGE), since they model all sectors of the economy. They are known to give a broad representation of the entire economy at the expense of low technology explicitness (Assoumou et al., 2018), i.e. available technologies are often aggregated into technology packages with few details on how the process works and neglecting sector coupling. Typically, the coal power sector is embodied in one process, whilst BU models feature different processes for coal power generation, including supercritical pulverized coal, atmospheric fluidized beds, and others. However, their strength is that they can capture feedback from markets by representing primary production factors and consumption of goods considering prices, incomes, and savings. Thus, TD models perform a general equilibrium of the entire economy, while BU models perform a partial equilibrium of the energy sector. One branch of TD models is called CGE, which operates on the basis of microeconomics through social accounting matrixes, elasticities of various kinds and constant elasticities of substitution (CES) functions (Rutherford, 2009). Governments and economists employ this family of models to assess the impact of an energy policy on the rest of the economy. Figure 7 shows a generic simplified diagram of the process of a CGE model.

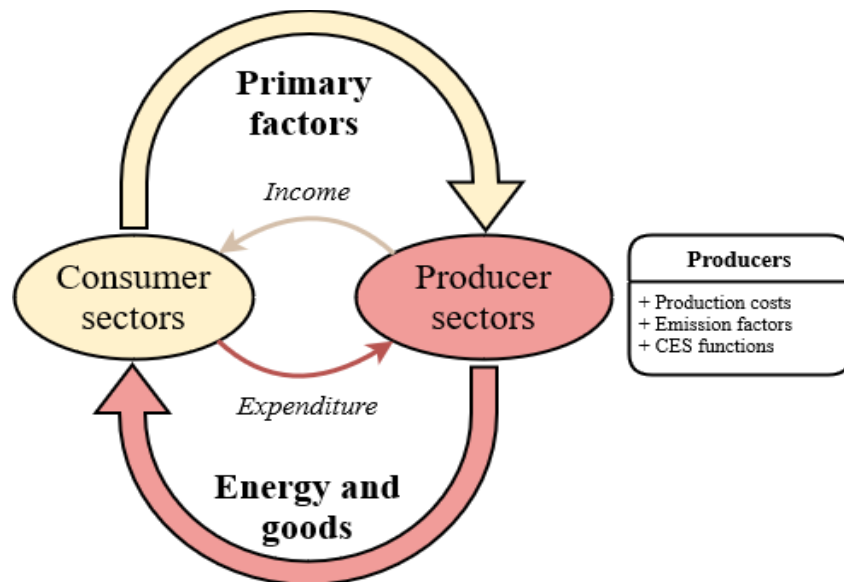

Figure 7: Generic Modeling in TD models

In TD models, techno-economic properties of the processes composing the energy sector or the producer sector are not diverse but mostly aggregated and require other information such as CES functions (represented in the side box). In exchange, TD models focus better on modeling the economic feedback that consumers return to producers (represented by the top arrow)

Behind the CES functions of CGE models are price elasticities and elasticities of substitution that reflect the preferences and willingness of consumers to switch from one way of consuming to another (Chen

et al., 2017, p. 5). These elasticities are nested to form a cost function with multi-level nodes representative of the consumers' behavior regarding a utility.

Thus, ESM can either be classified as BU or TD, depending on the aggregation level of the technology. Some models combine both BU and TD characteristics and are classified as hybrid (Helgesen, 2013; J.-C. Hourcade et al., 2006). Although it is a hard exercise to hybrid them, it can be interesting as the strengths of one may make up for the weaknesses of the other. Moreover, ESM can be coupled with a climate model to form an integrated assessment models (IAM) used to assess the interactions between the economy and the environment. The models and the scenarios they generate are tools for decision-makers in strategic, tactical or operational planning (Subramanian et al., 2018).

In the IPCC AR6, 1,686 scenarios from the scientific literature were collected and classified into 8 categories according to their climate change impact, e.g., “below 1.5°C with high overshoot”, or “likely below 2°C”. Thereafter, scenarios are denoted according to “societal choices for the development of future emissions”, following narratives consistent with current climate policies, moderate action, gradual strengthening of current policies, extensive use of negative emissions or renewables, low demand scenarios, and shifting pathways (IPCC, 2022). These scenarios feed into discussions and comparisons of key indicators related to the mitigation of climate change and energy. These include for example the amount of CO₂ captured and stored for different sectors of the economy in different regions, or the quantity of negative emissions or CCS-related key indicators found in the reports of the IPCC Working Group III.

3.2. State of the art: The role of CCU and CCS in the power sector

As the power sector is expected to be the first sector to be decarbonized, carbon capture in this sector has been studied for a while in IAMs (Azar et al., 2006; Luckow et al., 2010; Muratori et al., 2017; Selosse et al., 2013). There are many technologies potentially contributing to this effort, including renewables (solar, wind geothermal energy, tidal, hydro, etc.), nuclear, bioenergy, and fossil fuels (gas, oil, and coal) with carbon capture. In IAMs, these alternative power generations compete according to their cost and their ability to mitigate CO₂ emissions. In addition, they are constrained by their regional potential, technical feasibility (e.g., intermittency, CO₂ transport and storage, water disposal), land footprint, and social acceptance. According to the assumptions made by the modelers regarding all of these aspects, the deployment of CCS assets may vary substantially across studies (Koelbl et al., 2014). Besides, the demand for electricity is influenced by the modeling paradigm (TD or BU), and by the assumed competition with other energy carriers.

The IPCC recognizes that the future electricity system will decarbonize, which involves low-carbon technologies including CCS (IPCC, 2022). CCS in the power sector allows fossil fuels to be used for longer periods, reducing the potential risk of stranded assets (Byrd and Cooperman, 2016; Flora and Tankov, 2022). Notably, CCS makes sense in some regions of the world depending on the share of coal and gas in the current energy mix, e.g., in China. Moreover, the IPCC claims that the electricity sector could become a net-negative sector providing CO₂ permits for other sectors, in which case bioenergy with CO₂ capture and storage (BECCS) would be important. As IAMs usually perform a cost-optimization, BECCS is very attractive since it mitigates emissions while generating energy (Bui et al., 2018; Kraxner et al., 2015). In the context of Europe, Holz et al. (2021) showed that the availability of CCS leads to slightly lower costs (2%) that should be put into perspective with the social acceptance and CO₂ transport and storage operations. In their main scenario, CCS technologies generate 2-13% electricity depending on the cost scenario. For the US, Williams et al. (2021) proposed nine scenarios of which only one deploys gas with CCS. In their report on net-zero emissions by 2050, the IEA also reports low potentials for CCS power generation globally in the range of 3% (IEA, 2021b), although higher shares close to 8% were found in the past (IEA, 2020a). In the long run, (Morris et al., 2021) found much higher potentials for CCS (roughly 40% of total electricity generation by 2100) and argue that it provides a reliable and stable power for the future. Overall, fossil CCS in the power sector shows

very different potentials across scenarios and models, if any, but the IPCC feels confident in stating that BECCS makes sense for electricity generation. Besides, utilizing CO₂ after capturing it from power assets does not appear as an interesting option at all.

3.3. State of the art: The role of CCU and CCS in fuel supply

This section reviews the knowledge of the role of CCUS in generating a large array of liquid and gaseous fuels, through the prism of prospective studies. The following paragraphs distinguish CCS for blue hydrogen, CCS for biofuels, and CCU for diesel, gasoline, jet fuels, methanol, and methane.

While the future of hydrogen is quite uncertain in the near term, it may have an important role to play in the long run for the transport sector and industry (IPCC, 2022), with an average of 80 EJ in a 1.5°C scenario. To satisfy this demand for low-carbon hydrogen, CCS plays a major role either through steam methane reforming with CCS, or through biomass gasification with CCS (IEA, 2021b; Seck et al., 2022b; Sgobbi et al., 2016). Thus, when hydrogen is deployed to fulfill the demand sectors, CCS competes with large-scale electrolyzers in prospective studies. Their respective deployment is mainly driven by access to fossil fuels and renewable potentials, in addition to CO₂ storage capacities.

Regarding biofuels, the combination of biorefineries with CCS to produce biodiesel, biogasoline, biojet fuel, biomethanol, and bioethanol seems of great interest as it enables the production of very-low-to-negative biofuels (Johnson et al., 2014; Mukherjee et al., 2020; Watanabe et al., 2022). The IPCC does not emphasize the benefits of combining biomass with CCS to produce liquid fuels, but it does highlight the competition between biofuels and electricity and hydrogen in the transport sector (IPCC, 2022). Moreover, (Muratori et al., 2017; Vaughan et al., 2018) proved through IAMs the potential role of biofuels with CCS. Their findings show that these technologies can be very competitive against other energy carriers, provided that bioenergy crop production is sustainable.

The CCU pathway looks promising as it can generate a large array of synthetic fuels. These fuels are also called “drop-in” fuels as they are compatible with a conventional fueling infrastructure and combustion engines (Zhou et al., 2022). However, CO₂ utilization to produce synthetic fuels is not mentioned by the IPCC as a mitigation strategy for the transport sector in long-term prospective exercises, because it is often excluded from IAM representations, potentially due to a lack of trust in mitigating climate change or because it is not mature enough. Nevertheless, several researchers have explored the potential contribution of synthetic fuels in the future through the prism of prospective models. Studies converge on the following conclusions:

- the potential for CO₂-to-fuels increases as CCS becomes unavailable (Blanco et al., 2018a; IEA, 2020a; Williams et al., 2021);
- CCU acts either as a competitor or a complement to biofuels (Blanco et al., 2018a; IEA, 2021b; Teske, 2019; Williams et al., 2021). The frontier between the two is not so clear but refers to the local potential for growing biomass and its use in other sectors of the energy system;
- aviation is the sector that would rely the most on synthetic fuels, as the volumetric or gravimetric energy-density requirements make electrification and hydrogen use difficult (Blanco et al., 2018a; IEA, 2021b; Teske, 2019). Other transport sectors such as light-duty vehicles or heavy-duty vehicles may also be targeted, but in lower proportions;
- the deployment of CO₂-to-fuels processes steers the electricity sector as it requires low-carbon electricity to manufacture clean synthetic fuels (Capros et al., 2019; Williams et al., 2021).

3.4. State of the art: The role of CCU and CCS in the industry sector

Across studies and reports, CCS is the main mitigation option for the industry sector for several reasons (Holz et al., 2021; IEA, 2020a, 2021b; IPCC, 2022). First, more than 60% of global industrial emissions are due to three heavy industries, namely cement, steel, and chemicals. These industries are also called ‘hard-to-abate’ because of their high temperature processes (more than 1,000°C), which require burning fuels with high energy density. Such fuels are difficult to substitute with renewables. Second, these

industries are burdened with process-related CO₂ emissions, independent from the nature of the fuel they burn. Such emissions can only be abated through CCS or by shifting to an alternative production route that does not emit CO₂, e.g., wood constructions can replace cement and concrete constructions. Thirdly, industrial assets generally have a long lifespan up to 60 years (de Pee et al., 2018), which makes replacement very costly. As for the power sector, the industry can take advantage of CCS as it allows assets to be used longer, by installing CO₂ capture units (IPCC, 2022). It has also been demonstrated that the availability of CCS leads to substantial low transition costs and enables continued growth for industrial goods (Paltsev et al., 2021). Therefore, CCS seems inevitable for heavy industries, but competes with other decarbonization measures for other industries, namely electrification, efficiency, biomass, and hydrogen. CCU was found to be an interesting option for providing low-carbon feedstock for the chemical industry (IPCC, 2022). It is rarely mentioned as a mitigation strategy for other industries.

3.5. State of the art: The role of CCU and CCS in generating negative emissions

Negative emissions represent greenhouse gas (GHG) fluxes directed from the atmosphere to the biosphere or the geosphere, or from the biosphere to the geosphere. In other words, negative emissions account for GHG removed from the atmosphere, enabling a net reduction of the concentration of that GHG in the air. Several technological pathways exist to remove CO₂ from the atmosphere with different implications in terms of economics, land use, water use, removal efficiency, and energy consumption (Chiquier et al., 2022; Gabrielli et al., 2020; IEA, 2022f). These carbon dioxide removal techniques (CDR) can be divided into two categories: natural climate solutions (NCS) and negative emission technologies (NETs). The first category employs and enhances natural phenomena to remove carbon dioxide. The best known are afforestation and reforestation, which consist in increasing the photosynthesis of the biosphere. The second category relies on industrial processes involving mechanical and chemical engineering techniques. The best-known NET is bioenergy with Carbon Capture and Storage (BECCS). This technique consists in burning, gasifying, or fermenting biomass, which results both in energy generation and the emission of biogenic CO₂ that is subsequently captured and stored underground. As the carbon emitted has been absorbed from the atmosphere during the plant's growth, the CO₂ removed is considered climate neutral and thus generates negative emissions. In addition, as its name suggests, direct air capture (DAC) filters the ambient air to recover pure CO₂ at the end of the process. There are two types of technology: a low-temperature (LT) process using solid sorbents, and a high-temperature (HT) process with liquid solvents that feature different properties in terms of kinetics and heat transfers (McQueen et al., 2021). The principle is to make the CO₂ react with solid or liquid sorbents and regenerate these sorbents in an endothermic reaction. Then, the CO₂ is compressed to be stored or used. As the CO₂ in the air is more diluted than in the biomass flue gases, much higher amounts of energy are required in the range of 4-6 GJ/tCO₂ and 8-12 GJ/tCO₂ respectively for LT and HT (NASEM, 2019a), compared to that of 1.0-2.6 GJ/tCO₂ for BECCS. In contrast, much less land and water are required. Regarding the costs, there are significant uncertainties, with estimations ranging from \$20 to \$1,000/tCO₂ captured for DAC (Fasihi et al., 2019; IEAGHG, 2021a; IPCC, 2018; Keith et al., 2018; McQueen et al., 2021), and about \$30 to \$400/tCO₂ for BECCS (Fuss et al., 2018; Hepburn et al., 2019; IEAGHG, 2021b), mainly depending on how biomass is transformed. The latter comes with substantial needs for land and water to grow dedicated biomass. Thus, there are considerable uncertainties and trade-offs regarding the performances and implications of NETs, especially for DAC.

BECCS has been widely studied in IAMs (Minx et al., 2017), demonstrating its large contribution to mitigating CO₂ emissions while delivering energy services (Bauer et al., 2020; Rogelj et al., 2018), even when biomass availability and CO₂ storage are constrained (Selosse, 2019), with moderate impacts on food prices (Fajardy et al., 2021; Muratori et al., 2020). Recent efforts have been made to consider other CDR solutions than BECCS in energy models (Köberle, 2019), including DAC. For models considering

DAC, the quantity of negative emissions generated from DAC is very high, exceeding the current levels of CO₂ emissions globally (Akimoto et al., 2021; Chen and Tavoni, 2013; Fuhrman et al., 2021; Marcucci et al., 2017; Realmonte et al., 2019). They also show that DACCS delays the phase-out from fossil fuels and can thus act as backstop technology to fulfill climate ambitions. Studies are unanimous regarding the necessity of DAC in achieving deep decarbonization targets, i.e., net-zero targets or 1.5°C scenarios. The unavailability of DAC either makes the problem infeasible (Akimoto et al., 2021; Realmonte et al., 2019), or more costly (Marcucci et al., 2017). The sensitivity of DAC deployment shows that DAC becomes more necessary as the climate policy becomes more stringent. In other words, the transition is more complex to achieve without DACCS. Studies that assess the impact of DAC deployment on the rest of the energy system show that DAC mitigates the need to decarbonize the energy sector drastically and to reduce power generation (Akimoto et al., 2021; Marcucci et al., 2017; Realmonte et al., 2019), as well as land use change and water withdrawals (Fuhrman et al., 2021, 2020). Besides, when DACCS is available, BECCS contribution is reduced by roughly 30%, and BECCS is found to be not competitive with DACCS in scenarios where DAC is very cheap (Akimoto et al., 2021). Therefore, DACCS appears to substitute BECCS. Given that all of the models optimize the cost of the energy transition, the reason that DAC appears as a major tool is due to its economic benefits: the models estimate the reduction in CO₂ abatement costs between 19% and 90% (Table 2). Similar findings were also made in a national model focusing on the UK (Daggash et al., 2019). Overall, CDR was found to be inevitable to offset residual emissions and to accelerate near-term mitigation (IPCC, 2022). However, some pathways may be more attractive than others. Reviewing the few models that consider negative emissions through CCU, we realized that the potential for negative emissions was limited to less than 500 Mtpa (Desport and Selosse, 2022a), mainly thanks to CO₂ mineralization techniques.

Table 2: Deployment rate of DAC in existing studies

Study	Features			Peak deployment [Gt/y]		Reduction of CO ₂ abatement cost
	Model	Modeling paradigm	Fate of CO ₂	2050	2100	
(Chen and Tavoni, 2013)	WITCH	Top-down	Storage	1	16 - 37	N/A
(Marcucci et al., 2017)	MERGE-ETL	Top-down	Storage	*	14 - 38	19 to 35%
(Realmonte et al., 2019)	WITCH & TIAM-Grantham	Both	Storage	0	20 - 30	60 to 90%
(Fuhrman et al., 2021)	GCAM	Bottom-up	Storage	0.24 - 12	4.6 - 32	N/A
(Akimoto et al., 2021)	DNE21+	Bottom-up	Storage	5 - 21	10 - 44	50 to 90%
			Utilization	<0.07	0.05 - 1	
(Strefler et al., 2021)	REMIND-MAgPIE	Hybrid	Storage	1 - 5	1.5 - 3.5	25%
(Galimova et al., 2022)	LUT Energy Transition Model	Bottom-up	Utilization	3.6	N/A	N/A
(IEA, 2021)	WEM/ETP	Hybrid	Storage	0.63	N/A	N/A

*the deployment of DAC is allowed by the modelers after 2065

4. Knowledge gaps

In view of the previous section, CCS seems inevitable in industry and for generating negative emissions, but the necessity of deploying CCS in the power sector is still uncertain and across scenarios depends mainly on assumptions regarding policy, the use of nuclear, and the competitiveness of renewables. Thus, the deployment of CCS truly depends on external assumptions regarding the power sector, which is also the case for the transport sector and fuel supply. Indeed, many energy carriers compete with each other in the transport sector, namely biofuels, hydrogen, electricity, methanol, ammonia, gas, and drop-in fuels. Consequently, the fuel supply sector also depends on the transport energy mix, and *vice versa*. Given the state of the art, we determined that the contribution of CO₂ utilization, direct air capture, and negative emissions in the industry was very uncertain.

4.1. CO₂ utilization

The knowledge about CO₂ utilization in prospective studies suffers from a major intrinsic gap, i.e., IAMs generally do not model CCU (Desport and Selosse, 2022b; IPCC, 2022). We performed an overview of energy models representing CCU options in their framework (Table 3) and searched the scientific literature for energy models that consider the capture and use of CO₂. To do so, we browsed the ScienceDirect platform with keywords such as “CO₂ utilization, CO₂ conversion, energy models, modeling, CCU, Power-to-Gas and Power-to-Liquids” to find energy models taking into consideration at least one route that CO₂ utilization offers. We also looked at the IAMC platform (IAMC-Documentation contributors, 2021) and systematically reviewed each global model's presentation to see whether CCU was included as an option. The only selection criterion was that energy models should consider at least one CO₂ utilization route and provide sufficient detail to analyze the modeling. We examined each model in terms of:

- technology representation from capture to utilization in order to identify the origin of CO₂ (process CO₂, fossil CO₂, atmospheric CO₂ or biogenic CO₂) and the final products made using CO₂. We call “technology bricks” a stand-alone process producing an energy or material commodity such as a power plant or a CO₂ conversion process;
- modeling assumptions, i.e., the consideration of carbon taxes, techno-economic assumptions of CCU technologies, technology learning, etc.;
- model type, whether energy system models (ESMs) or value chain models (VCMs) and bottom-up (BU) or top-down (TD) (Section 3);
- geographical perimeter;
- time horizon;
- climate target;
- the parametrization, i.e., the parameters used by the modelers in the study to characterize CCU.

Table 1 describes the 24 studies that were reviewed. Currently, energy models rarely consider CCU as a decarbonization option (Butnar et al., 2020), yet their representation in energy models is vital for decision-makers to determine whether this technology set should be deployed extensively, as well as its role in mitigating climate and reducing the cost of carbon capture (Mac Dowell et al., 2017). Nonetheless, the few studies focusing on the use of CO₂ in energy models are mainly produced in the context of CO₂ emissions reduction, and particularly in the context of the Paris Agreement. Sometimes, CO₂ utilization is seen and modeled as a commercial opportunity (IEA, 2019b; Tapia et al., 2014), i.e., once CO₂ is captured and employed to produce goods, and this is the prime interest of modeling. Including CO₂ utilization as a novel option for energy models, researchers try to establish new paradigms, especially for the transport sector since the most targeted CO₂ utilization is fuel manufacture. Ultimately, the purpose of modeling CO₂ utilization is to advise decision-makers on best practices to achieve the energy transition by considering a number of side effects on other centers of interest such as environmental and socio-economic impacts.

From our overview, 17 ESMs integrate the use of CO₂ as a lever to reach a climate target – in competition with other alternatives – of which 6 are IAMs. Thus, the remaining 7 models are VCMs. As Table 1 shows, we note a clear domination of BU models in the modeling of CO₂ utilization, which is relevant in terms of emissions mitigation. Besides, modelers have focused on the utilization of climate-neutral and industrial CO₂ (Figure 8), and the modeling of CO₂-to-fuel routes, including synthetic oil, synthetic gas, and methanol (Figure 9).

The consideration of climate-neutral CO₂ utilization is relevant as it ensures a low or null impact on CO₂ accumulation in the atmosphere. The most climate-effective CO₂ utilization routes, namely concrete curing, plastics, and CO₂ mineralization, are poorly studied, while they could generate negative emissions, although the potential is quite low (Desport and Selsosse, 2022a). To generate negative emissions, DACCS looks much more promising (Section 3.5), but knowledge gaps persist.

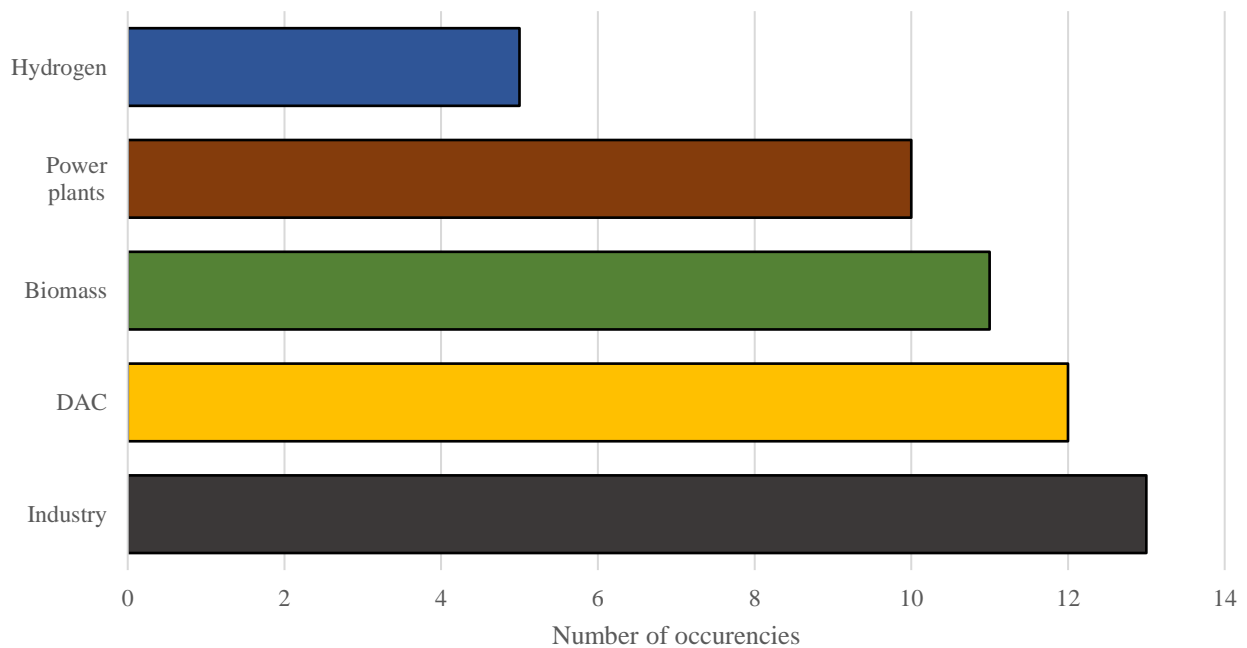

Figure 8: Occurrence of sector-specific capture means in the 23 models of the review

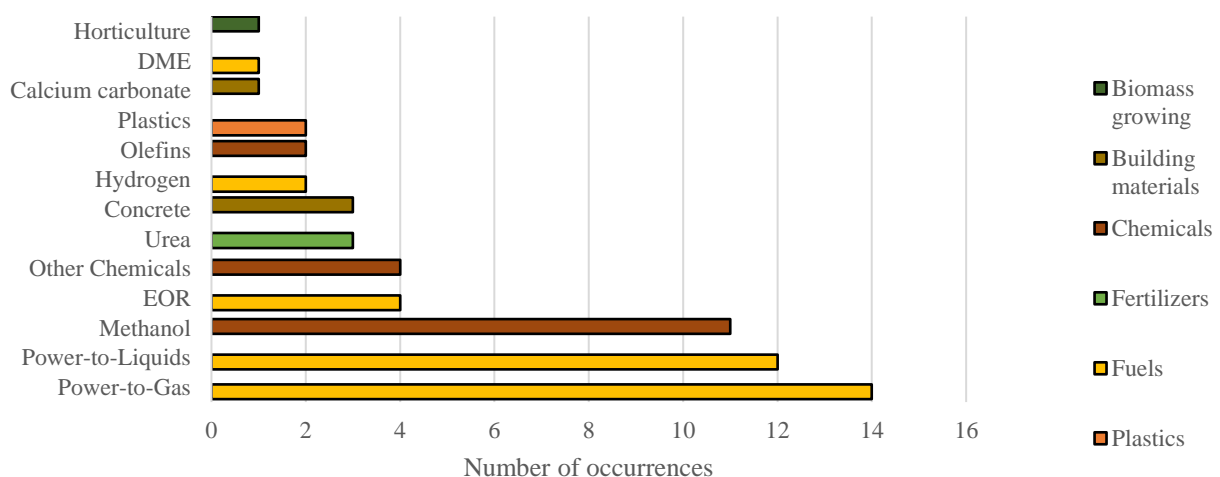

Figure 9: Occurrence of specific CO₂ utilization routes

To conclude, our review shows that a complete representation of CCU is absent from energy models. In particular, top-down modeling would be required to better understand the socio-economic effects of

CCU deployment. Also, in order to better quantify CO₂ capture capacities, we argue that CCU needs to be modeled at all possible capture sites and for all CO₂ utilization processes. Although indispensable, the modeling of CO₂ capture does not systematically include biogenic and atmospheric CO₂, and the modeling of CO₂ utilization mainly addresses the production of fuels and chemicals while leaving aside other key utilizations for industry. Moreover, CCU should be further explored at the global level. Consequently, decision-making in favor of CCU seems to be hazardous at this point in time. As CO₂ utilization has been demonstrated to be an immature technology currently more suited to the medium term, we believe that the research modeling community still has time to study the matter of CCU in all of its complexity before advising decision-makers to gamble on CCU with major investment plans.

Table 3: Overview of CCU modeling methods in energy models and studies

Paper	Context	Model type	Region	Time horizon	Climate target	CO ₂ capture	CO ₂ utilization	Parametrization	Description of CCU modeling
(Fasihi et al., 2017)	The aim is to take advantage of the Maghreb's potential for solar and wind power generation to manufacture fuels with atmospheric CO ₂ and green H ₂ to satisfy European fuel demand.	Supply Chain - BU	Maghreb and Europe	2050	NZE emission	DAC	Power-to-Gas; Power-to-Liquids	CapEx and OpEx; Lifetime; Efficiencies; Other specific technical parameters	The capture of CO ₂ is ensured only by DAC units fed with renewable electricity and heat. The utilization of CO ₂ begins with its transformation into fuel products along with renewable hydrogen. The study provides two very detailed block-flow diagrams to represent the utilization units, production, storage, and delivery of synfuels. The results rely on techno-economic assumptions that might be debatable for DAC.
(Farfan et al., 2019)	This study looks at capturing CO ₂ emissions from cement plants to produce fuels and assesses the potential of CCU to mitigate cement factory emissions. The purpose is to estimate the quantity of CO ₂ captured from the cement industry that could be used to make synthetic fuels.	Supply Chain – BU	World	2050	Different scenarios 1) Cement Sustainable Initiative target 2) 42.9% emissions reduction 3) Only process-related emissions remain	Cement plants	Power-to-Gas; Power-to-Liquids	Carbon capture efficiencies; Energy needs; Emissions levels per ton of cement; PtX energy and material flows	The authors simulate the potential of the cement industry in supplying CO ₂ for fuel manufacture. Non-transparent modeling of CO ₂ utilization with little techno-economic information about Power-to-X processes. The authors provide some references concerning the capture technologies, namely carbon looping and amine scrubbing.
(Kätelhön et al., 2019)	The idea is to assess the potential of CO ₂ to replace hydrocarbon feedstocks for the chemical industry. The authors propose new paradigms for the chemical industry across three scenarios.	Energy system – BU	World	2030	Decarbonization of the chemical industry	Industry; DAC	Power-to-Gas; Methanol; Olefins; Other chemicals	Energy consumption; Efficiencies; Environmental footprints;	This optimization is of a particular kind since it does not minimize the total annual cost, but rather the GHG emissions of the system. The CO ₂ supply is ensured by high-purity industrial processes and DAC. Two main assumptions are made considering the carbon footprints of CCU plants involving a High-TRL scenario and a Low-TRL scenario. Technology data is summarized in open-access documentation, mainly from Ecoinvent and IHSdatabases.
(Bazzanella and Ausfelder, 2017)	This study analyzes how the European chemical industry could take advantage of new technologies to decarbonize its activity. The authors identify promising low-carbon technologies considering their potential impact on CO ₂ emissions reduction, costs, technical performances and barriers.	Energy system – BU	Europe	2050	Decarbonization of the chemical industry	Power plants; Industry	Urea; Methanol; Power-to-Gas; Power-to-Liquids; Plastics	Energy and material flows; Environmental impacts; CapEx and OpEx	The modeling of CCU is based on techno-economic parameters of processes with their related material and energy flows, as well as their environmental impacts. The added value of the study is that CCU routes are compared with alternative routes including electrification, biomass and recycling. Many efforts have been made to describe the new clean production systems the authors consider. The study includes sector-coupling with the energy sector and the transport sector.

Paper	Context	Model type	Region	Time horizon	Climate target	CO ₂ capture	CO ₂ utilization	Parametrization	Description CCU modeling
(IEA, 2021b) & (IEA, 2019b)	Explores the implications of the unavailability of CO ₂ storage on the energy sector, including the need for CO ₂ utilization. Potential and opportunities are assessed in three different scenarios 1) Clean Technology Scenario (CTS) 2) Low Carbon Storage (LCS) and 3) Reference Technology Scenario (RCS). In the CTS and LCS, the focus is on the industry sector.	Energy system – BU	World	2060	75% cut in CO ₂ emissions compared to 2017 levels	Industry; DAC; Power plants; Biomass; Hydrogen	Urea; Methanol; Concrete; Other chemicals; Plastics; Power-to-Gas; Power-to-Liquids	Energy and material flows; Environmental impacts; CapEx and OpEx	The IEA Energy Technology Perspectives (ETP) model depicts new opportunities for the energy system to shift from polluting production to clean production. This model is thus technology-oriented and yet poor assumptions are given about the economics of CCU processes. The modeling is based on the TIMES framework. The CO ₂ tax is not applied to synfuels made of biogenic CO ₂ .
(Leonzi o et al., 2020)	This study takes place in the context of a UK energy transition that aims to abate 6.4 Mton of CO ₂ per year. The authors consider both storage and utilization and their related role in abating CO ₂ emissions.	Supply Chain – BU	UK	2030	6.4 MtCO ₂ /yr emission reduction	MEA absorption; PZ absorption	Methanol;Power-to-Gas;Polyurethane; Horticulture;Concrete;Calcium carbonate	Production costs; Capture costs; Material flows; Plants location	The specific constraints of CCU modeling are made explicit. For example, CO ₂ cannot be sent to multiple storage sites, storage capacity is limited, minimum CO ₂ abatement, etc. A detailed description of how the model works is provided. A carbon tax of 80 euros per ton is assumed.
(Leonzi o et al., 2019)	A model is designed to assess the potential of carbon dioxide utilization and storage in Germany to satisfy methanol demand.	Supply Chain – BU	Germany	2030	160 MtCO ₂ /yr emission reduction	MEA absorption; PZ absorption; Membranes; PSA; VSA	Hydrogen; Methanol	Capture costs; Material flows; Plants location	
(Leonzi o and Zondervan, 2020)	The model is designed to represent CCUS supply chains and define their framework to significantly reduce CO ₂ emissions whilst minimizing total costs. The model is built for the Italian regions.	Supply Chain – BU	Italy	2030	77 MtCO ₂ /yr emission reduction	MEA absorption; PZ absorption; Membranes; PSA; VSA	Power-to-Gas	Capture costs; Material flows; Methane production costs; Plants location; Economic incentives for PtG processes	
(Blanco et al., 2018b)	The authors utilize a bottom-up model to evaluate the potential of methanation in the EU energy transition.	Energy system – BU	Europe	2050	80 to 95% CO ₂ reduction by 2050 (vs. 1990)	Industry; DAC; Power plants; Biomass; Hydrogen	Power-to-Gas	CapEx and OpEx; Efficiencies; Availability; Lifespan; Energy and material flows	TIMES representation of technology bricks. No variable costs are represented as they are mainly supported by CO ₂ feedstock of methanation processes. The modelers provide 3 different scenarios for PtG costs and 8 different policy scenarios of which two with no CO ₂ storage available. A variable CO ₂ price is considered.
(Blanco et al., 2018a)	The authors utilize a bottom-up model to evaluate the potential of PtL in the European energy transition.	Energy system – BU	Europe	2050	80 to 95% CO ₂ reduction by 2050 (vs. 1990)	Industry; DAC; Power plants; Biomass; Hydrogen	Power-to-Liquids; Methanol	CapEx and OpEx; Efficiencies; Availability; Lifespan; Energy and material flows	TIMES representation of technology bricks with a high level of detail (23 processes). The modelers provide different scenarios for PtL costs. A variable CO ₂ price is considered.

Paper	Context	Model type	Region	Time horizon	Climate target	CO ₂ capture	CO ₂ utilization	Parametrization	Description CCU modeling
(Dutta et al., 2017)	The proposed model is employed to assess the contribution of CO ₂ utilization to produce power and chemicals. Instead of minimizing the total cost, they maximize CO ₂ avoidance. Three scenarios considering different renewable H ₂ availabilities are studied.	Energy system – BU	World	Not stated	1 to 59% CO ₂ emissions reduction compared to 2013 level	N/A	Hydrogen; DME; Methanol; Olefins; Urea	Environmental impacts	The model is fed with CO ₂ avoidance inputs that reflect the CO ₂ that would not be emitted into the atmosphere if the alternative CCU option were chosen by the model. The total amount of CO ₂ avoided resulting from the optimization is evaluated considering the CO ₂ emission factors of remaining fuels. Three scenarios are discussed including with unlimited renewable hydrogen. Costs are not considered since the objective function is to maximize CO ₂ avoidance.
(Tapia et al., 2014)	First-of-a-kind study working on the optimal design and planning of a CCUS value chain that only considers EOR as a CO ₂ utilization option.	Supply Chain – BU	N/A	Not stated	No stated target	N/A	EOR	OpEx; Lifespan	The authors run an optimization model maximizing the profit that can be generated from EOR and provide a description of its basic framework. Data about operation costs are included. The study focuses on the end-of-the-pipe, meaning that only utilization is considered and not capture.
(Teske, 2019)	Global complete energy transition pathways at different regional scales for a decarbonized world in 2050.	Energy system – BU&TD	World	2100	Decarbonization target	Biomass	Power-to-Liquids	CapEx; Efficiencies	The modeling methodology of CCU is described simply but the interaction between the capture of CO ₂ , the utilization and the combination with hydrogen is not explicit.
(Williams et al., 2021)	The United States is supposed to reach carbon neutrality by mid-century following IPCC recommendations. Two models are developed and utilized to model the entire US and industrial system. One is capable of making technology choices at the demand-side level. The other addresses the sequential hourly variation of renewable energy over a sampling of representative days to find the lowest cost solution to decarbonize energy supply.	Energy system – BU	USA	2050	Decarbonation target	Industry; DAC; Biomass	Power-to-Liquids; Power-to-Gas	CapEx and OpEx; Efficiencies; Availability; Lifespan; Energy and material flows	The modeling of CCU is achieved in a typical BU fashion. It comprises the capture of CO ₂ from highly concentrated streams in industry or biogenic CO ₂ directly from air or biomass conversion. Then CO ₂ is utilized for a single purpose, i.e., to manufacture fuels as energy carriers or feedstocks (e.g. for the chemical industry). In most scenarios, the captured CO ₂ is biogenic, so the majority of manufactured fuels are climate-neutral.
(Khalili et al., 2019)	Exploration of scenarios for the transportation sector in the context of the Paris Agreement. The aim is to study the penetration of new options in the transportation sector to reach 100% renewable by 2050.	Energy system – BU&TD	World	2050	Decarbonization target	N/A	Power-to-Liquids; Power-to-Gas	CapEx and OpEx; Efficiencies; Availability; Lifespan	The modeling of the transport sector is very concise and identifies great potential for rail, marine and aviation sectors to be decarbonized through synfuels, while road transport is more likely to be decarbonized by electric and hydrogen cars. The modeling of new opportunities is mainly achieved by feeding the model with new processes and their related costs, efficiencies and environmental impacts.

Paper	Context	Model type	Region	Time horizon	Climate target	CO ₂ capture	CO ₂ utilization	Parametrization	Description CCU modeling
(Bogdanov et al., 2019)	Modeling of the energy sector and its interactions with the transport sector and industry to capture the interest of sector coupling to reach a climate-neutral European energy system. Capture technologies are not allowed for the power sector but Power-to-X solutions can be addressed for the transport sector with atmospheric CO ₂ .	Energy system – BU	World	2050	Decarbonization target	DAC	Power-to-Gas; Power-to-Liquids	CapEx and OpEx; Lifespan; Energy and material flows; Efficiencies; Learning rates	The model includes many Power-to-X possibilities in which the CO ₂ supply is systematically ensured by cheap DAC processes with a CapEx below 200 \$/t. The choices in PtX pathways are mostly driven by techno-economic inputs. The authors also state that minimum and maximum capacity limits are input into the model so that the penetration of such technologies remains feasible. A detailed description of techno-economic assumptions is provided in Supplementary Information.
(Capros et al., 2019)	Power-to-X routes are introduced into a European energy model to propose sustainable optimal profiles of energy supply in a climate-neutral energy system.	Energy system – BU	Europe	2070	80% emission cut compared to 1990 or climate neutrality	DAC;Power sector;Industry;Biomass	Power-to-Gas; Power-to-Liquids; Other chemicals	CO ₂ emissions from energy and processes; Production costs	In order to ensure the climate benefit of Power-to-X solutions, the authors only consider a non-fossil origin for CO ₂ , but the model also considers CO ₂ capture for the power sector. Additionally, dihydrogen molecules feeding these processes come from carbon-neutral electricity. Synthetic fuels are available only for road transport and compete with at least 8 other fuel types, which restricts the potential PtX roll-out.
(Siskos et al., 2015)	A technology-rich model running over endogenous demand is utilized to propose a decarbonization strategy solely for the European transport sector, in which Power-to-X solutions are made available within the model.	Energy system – BU&TD	Europe	2050	Decarbonization	DAC;Power sector;Industry;Biomass	Power-to-Gas; Power-to-Liquids; Other chemicals	CES functions; CO ₂ emissions from energy and processes; Production costs	The PRIMES-TREMOVE model is an extension of the PRIMES model devised to generate endogenous energy demand profiles. The modeling is thus composed of two dynamic steps 1) a technology choice module determining the vehicle technologies with their related fuels as a result of a discrete problem based on technology costs 2) a transport demand module simulating the demand for transport considering the transport activity and the maximized passenger utility. CES functions are utilized to describe the technologies and fuel choices of consumers.
(Takeshita, 2013)	Global assessment of CO ₂ capture and storage in a cost-optimal fashion. The authors include one technology to convert pure CO ₂ into methanol for industrial thermal demand.	Energy system – BU	World	2050	50% cut in CO ₂ emissions compared to 2005 level	Power plants; Biomass; Fischer-Tropsch process	Methanol	Techno-economic attributes; Emissions reductions	The authors perform a cost-optimal scenario with price-induced energy demand reductions and fuel switching, notably. CO ₂ utilization is not at the core of the study but is part of a rich description of the supply chain in a bottom-up fashion, enabling sector coupling studies.
(Quarton and Samsatli, 2020)	In the context of growing interest in CCS and CCU technologies, the authors take into consideration this set of technologies to decarbonize the British energy system.	Energy system – BU	UK	2050	Decarbonization target	Power plants; Hydrogen	Methanol	Techno-economic parameters; Demands; Existing capacities;	The authors provide a transparent mathematical description of the model formulation for CO ₂ utilization technologies with the total rate of CO ₂ production from industrial emissions, economic penalties, and rewards for CCUS processes. Economic incentives for CCUS are modeled, i.e., CO ₂ pricing and variation of the methanol market price.
(Cunha et al., 2020)	No particular study on CO ₂ utilization has been performed with this model, to our knowledge. However, the model still represents EOR as an option to produce liquid fuels.	Energy system – TD	World	2100	N/A	Power plants; Hydrogen; Industry	EOR	Carbon storage coefficient; CO ₂ injection rate per barrel; Production costs	The model makes a distinction between EOR storage fields and saline aquifers. The potential for CO ₂ storage is calculated from the amount of oil that can be recovered with CO ₂ injection, considering a coefficient varying between 0.27 and 0.32 tCO ₂ per barrel.

Paper	Context	Model type	Region	Time horizon	Climate target	CO ₂ capture	CO ₂ utilization	Parametrization	Description CCU modeling
(S. Zhang et al., 2020)	In order to deploy CCUS or mitigate CO ₂ emissions, the authors design the best utilization framework. The models are solved both by cost minimizing and emission minimizing.	Supply Chain – BU	North-East China	Not stated	70 MtCO ₂ /yr emissions reduction	Power plants; Industry; Biomass	Power-to-Gas; Power-to-Liquids;	Dehydration costs; Capture costs; Pipeline transportation costs; Injection costs; Revenue from EOR; Emission factors from LCA; CO ₂ sources; CO ₂ reservoirs	Very detailed mathematical assumptions are provided regarding the CO ₂ sources to be selected for capture, the pattern for CO ₂ pipeline transportation, CO ₂ capture technology, utilization and storage nodes, and optimal cost-based deployment strategy of CCUS supply chains.
(Akimoto et al., 2021)	The authors employ a global BU model to explore the long-term deployment of CO ₂ utilization combined with direct air capture (DAC) in 2°C and 1.5°C scenarios involving decarbonization around 2050.	Energy system – BU	World	2100	2°C and 1.5°C maximum temperature elevation	Industry; Biomass; DAC; Power sector	Power-to-Gas; Power-to-Liquids; Methanol; Mineralization; Other chemicals	Capture Costs; Energy and CO ₂ balances;	Clear disaggregation of CO ₂ sources and CO ₂ utilization is employed. The synthetic fuels act as perfect substitutes for conventional fuels. Lack of transparency regarding the modeling of the utilization of CO ₂ to produce chemicals. Costs for PtL are unknown.
(Detz and van der Zwaan, 2019)	The authors explore the feasibility of transitioning towards negative emissions by 2050 and the contribution of CO ₂ utilization to reach this target. They use exogenous CO ₂ demands for various utilizations and various origins.	Energy system – BU	World	2050	1.5°C scenarios	Industry; Biomass; DAC; Power sector	Power-to-Gas; Power-to-Liquids; Methanol; Mineralization; Plastics; Other chemicals	Techno-economic performances are either stated explicitly in supplementary material or cited.	High level of transparency but lack of sensitivity and perspective in the results.

4.2. Direct air capture

The IPCC highlights that “very few studies and pathways include CDR options [other than BECCS]” (IPCC, 2022). In Table 4, we review the global energy models that consider DAC in their framework, according to the assumed cost of DAC, their energy need, the type of DAC, and whether they include a regionalization of these parameters. The aim is to identify what facet of DAC is not addressed currently in the models.

Table 4: Techno-economic assumptions of existing studies modeling DAC

Study	DAC technology modeled	Range of DAC cost in 2050 [\$/tCO ₂]	Range of energy needs in 2050 [tCO ₂]	Energy consumption	Includes CO ₂ compression?	Regional variation of capital costs	GHG Trade
(Chen and Tavoni, 2013)	HT	379 - 509	8.1 GJ	High-temperature heat	Yes	Included for transport and storage	Carbon market among regions
			490 kWh	Zero to low-carbon electricity			
(Marcucci et al., 2017)	HT	350 - 470	5.0-8.1 GJ	Natural gas	Yes	Not included	Carbon market among regions
			500 kWh	Grid electricity			
(Realmonte et al., 2019)	HT	106 - 318	5.3-8.1 GJ	Natural gas	Lack of evidence / Not explicit	Not mentioned	Not mentioned
			361-500 kWh	Electricity			
	LT	53 - 371	4.4-7.2 GJ	Natural gas and waste heat			
			167-306 kWh	Electricity			
(Fuhrman et al., 2021)	HT	78 - 296	5.3-8.1 GJ	Natural gas	Lack of evidence / Not explicit	Not mentioned	Carbon market among regions starting from 2025
			361-500 kWh	Electricity			
	HT	101 - 384	1,389-1,667 kWh	Electricity			
	LT	137 - 402	694-1,528 kWh	Electricity			
(Akimoto et al., 2021)	HT	226 - 831	1535	Grid electricity	Lack of evidence / Not explicit	Not mentioned	Not mentioned
	LT	203 - 744	6.3 GJ	Natural gas and heat			
			250 kWh	Electricity			
(Strefler et al., 2021)	HT	103	10 GJ	Natural gas or hydrogen	Lack of evidence / Not explicit	Not mentioned	Global uniform carbon prices
			556 kWh	Electricity			
(Galimova et al., 2022)	Not mentioned	38 - 84*	4.6 - 4.7**	Not mentioned	Lack of evidence / Not explicit	Not included	Not mentioned
(IEA, 2021)	Not mentioned	123 - 335 (DAC report)	6.6 - 10.0 GJ (DAC webpage)	Not mentioned	Yes	Not mentioned	Not modeled

Economic values are in USD 2018

* Values including the cost of fuel

** Values mentioned in the reference associated (Fasihi et al.) but not specified in the article

Capital costs and energy consumption are the main contributors that determine the overall cost of DAC. As shown in Table 4, the range of the assumed cost of DAC in 2050 is wide (\$20 to \$1,000/tCO₂ captured), depending on the scenarios and the uncertainty behind these costs. This range is displayed for 2050 because this information can be found in all of the studies, which allows them to be compared on the same basis. These costs only refer to capital and labor but do not include the cost of fuel, as it is

an endogenous output of the models. Even when fuel costs are accounted for, the costs assumed by modelers are rather at the low end, given the range of uncertainty on DAC costs. Moreover, it is generally the low range that is mostly used and discussed in the scenarios – although the studies may consider fairly wide ranges.

The cost of fuel strongly depends on the nature of the energy purchased, namely electricity, heat, or natural gas – depending on the region they are produced in, as well as the type of process design (LT or HT). Overall, the assumptions taken by energy modelers in terms of energy needs are no higher than 10 GJ/tCO₂ captured, but the lower end may vary substantially among studies depending on the process design, from 2.5 to 6.8 GJ/tCO₂. It is not often explicit whether the modelers took into account the operational cost and energy needed to compress the CO₂ once it is captured, while it is estimated to increase energy needs by 0.42 GJ/tCO₂ (APS, 2011). It is also not clear how the modelers consider energy consumption and intermittency, i.e., whether dedicated renewable assets – with or without batteries – are installed, or DAC units are connected to the grid. Chen and Tavoni (2013) explicitly use only zero to low-carbon electricity to run DAC plants, including nuclear, intermittent renewables of fossil fuels combined with CCS, which raises questions about how the distribution and allocation are managed. A mean often cited in the literature to further reduce the cost of DAC is to use excess heat (Beuttler et al., 2019; Fasihi et al., 2019; Wevers et al., 2020), which consists in taking advantage of free waste heat generated by some industrial processes locally, thus benefitting from low-cost energy. For LT processes only, Realmonte et al. (2019) consider waste heat recovery from industrial processes using natural gas by defining an industry-dependent recovery factor of between 20 and 40% of the energy input. Waste heat recovery is also considered for nuclear and concentrated solar plants, such that for each PJ of electricity generated from them, respectively 1.3 and 4.5 PJ of waste heat can be recovered. There is no record of the capital and operational costs of the recovery process. Another way often considered to generate heat is natural gas, which increases the cost of net CO₂ removed as additional fossil CO₂ is generated from the combustion (NASEM, 2019b). In some cases, models consider a full electric supply involving heat generated from heat pumps. However, there is little information on how electricity is provided. It seems the models do not consider dedicated renewable assets to feed DAC plants, but rather assume grid electricity distribution. This assumption is reasonable as long as the electricity used is carbon-free – which is not made explicit in all publications. If consuming grid electricity is envisioned, then it may be credible at a certain point in time when the grid is expected to be decarbonized; 2050 for instance. Otherwise, dedicated intermittent renewable assets involve the installation of batteries, increasing the cost of capital. Marcucci et al. (2017) acknowledge that a limitation of their modeling is the simplistic representation of intermittency of solar and wind.

Each model considers regional costs for energy generation, as power supply is determined endogenously, thus identifying leading regions of the world in DAC deployment. Regional costs also include transport and storage of CO₂ in three studies of the panel, but none considers regional variation for capital expenditures of the DAC process itself.

Finally, five of the above studies consider DAC as a means to generate negative emissions, and three of them consider the utilization of CO₂. As CO₂ can be enhanced to produce valuable fuels, chemicals, or building materials helpful for decarbonizing other sectors, the deployment of DAC can be driven by this other opportunity, which is important to model if the aim is to maximize the chances of developing DAC. However, all studies consider opportunities other than DAC for generating negative emissions. In particular, BECCS is always considered and found to compete with DACCS. Afforestation techniques are also considered and found to be as potent as BECCS in generating negative emissions (Fuhrman et al., 2021; Realmonte et al., 2019). In addition, the models focusing on CCU also consider other CO₂-supplying options besides DAC, such as combustion CO₂ or process CO₂.

We identify the following knowledge gaps regarding the techno-economic modeling of DAC:

- The techno-economic literature acknowledges that the cost range for capturing CO₂ from the air is wide, and yet studies tend to overlook the lower end of this range. To our knowledge, there is little information about the role of DAC at around \$1000/tCO₂;
- generally, the studies use exogenous cost decreases, or cap the deployment of DAC. Such assumptions are empirical and in fact depend on past investments in DAC, in an endogenous manner;
- the regionality of DACCS cost is limited to the transport and storage costs. As the costs of capital and labor vary across regions on the world, we want to address this issue;
- the energy consumption of DAC is also subject to considerable uncertainty and has been considered in past studies. However, what is still unclear is how to supply energy to DAC units, whether with dedicated intermittent electricity if DAC is to be deployed, or grid electricity;
- assessment of DAC to provide climate-neutral CO₂ to manufacture low-carbon synthetic fuels is rarely considered.

4.3. Negative emissions in the industry

Concerning the potential for negative emissions in the industry, research on the deployment of biomass to decarbonize the steel industry has focused primarily on the national and regional levels. It seems that simply substituting fossil fuels with biomass in the steel industry might not be sufficient to significantly reduce emissions. (Pinto et al. 2018) find that the decarbonization of the Brazilian steel industry can reach a higher GHG reduction pathway using a combination of biomass and the best available technologies. In Sweden, the use of biomethane to produce heat for the steel sector could reach 9% emissions substitution (Ahlström et al. 2020). Furthermore, utilizing biomass through the existing steel production processes in Sweden can reach a reduction of up to 43% (Nwachukwu et al. 2021). At European level, similar CO₂ reductions can be achieved, up to 42% when substituting fossil fuels with biomass in the existing steel producing facilities (Mandova et al. 2018b). CCS was not included as an option in any of these studies. As for the cement industry, (Ren et al., 2023) reviewed the existing models including negative emissions and other mitigation strategies for the cement industry. It appears that only two models – including theirs – consider the use of negative emissions to decarbonize the cement industry at a regional level, i.e., China (Ren et al., 2023) and Japan (Watari et al., 2022). They both conclude that using BECCS in the cement industry is critical to reach the net-zero target in this sector. However, they mention sustainability concerns regarding biomass management, which could be even more substantial if studied at the global level.

We did not identify any industry sectors other than cement and steel that have been the subject of a prospective study.

4.4. Other knowledge gaps

In addition, the perspectives for CCS in natural gas extraction have not been explored in any model, to the best of our knowledge, despite the fact that it is currently the most commercially effective CCS option with several existing facilities in Norway and Australia (Section 1). This knowledge gap is however difficult to address, since it requires considerable data about the number of natural gas fields and the related CO₂ concentration, which is usually unknown unless prospecting geological analysis is conducted for each single field. Likewise, the modeling of EOR has attracted little attention even though EOR is currently the second largest consumer of CO₂ (Section 1). To our knowledge, only three models have explored future CCUS operations for EOR, of which two are VCMs determining the optimal design of CO₂ transportation from capture sites to EOR fields in China (Cunha et al., 2020; Tapia et al., 2014; S. Zhang et al., 2020).

5. Conclusion

In this chapter, we presented the current state of CO₂ capture, utilization, transport and storage, highlighting that the technologies have been deployed for many years, but however remain marginal in the global energy mix. Unlike other low-carbon alternatives, such as renewable wind and solar, CCS has not penetrated the market yet. However, significant quantities of CO₂ are used as a feedstock in some industries. It should be noted that the deployment of CCU and CCS faces many challenges related to the energy requirements, cost, lack of infrastructure and policies, and acceptability issues. Considering these parameters, the future of CCS and CCU can be explored through prospective modeling, which consists in projecting the future of energy systems and observing the place and contribution of CCU and CCS in the 21st century. The existing literature has proven the importance of CCS in achieving the Paris Agreement, without which it would be more technically and financially complex. In particular, the deployment of negative emissions through BECCS or DACCS is crucial to offset the most expensive residual emissions as well as to eliminate the process-related CO₂ emissions of the industry sector.

However, knowledge gaps remain regarding the delivery of negative emissions with CCU, notably with CO₂-based minerals that can be reused in the cement industry (Desport and Selosse, 2022a). Nevertheless, we identify most importantly that the representation of CCU in global energy models is lacking, which makes it difficult to study and compare the results regarding its future (Desport and Selosse, 2022b). In general, although the costs of CO₂ capture are increasingly known, there are large uncertainties about direct air capture. Other concerns about the assessment of costs relate to CO₂ transport and CO₂ storage costs, which can vary greatly depending on the distances to cover, and the specific features of CO₂ reservoirs. Finally, the future potential of negative emissions in the industry sector is lacking evidence.

To fill these gaps, we will employ one bottom-up model and one top-down model. The following chapter is dedicated to describing these models and explain how combining them can help deliver complementary insights.

Chapter 2 – Presentation and comparison of EPPA and TIAM-FR: Structures and optimization paradigm

As mentioned in the previous chapter, the purpose of prospective energy models is to envision the possible futures of the global energy system. Investment decisions concerning the deployment of technologies to achieve an environmental target are an important output of such models, *inter alia*. Numerous models exist involving different natures, scopes, technology explicitness or economic realism, and solving paradigms (IAMC-Documentation contributors, 2021). However, the CCS and CCU technologies described in the previous chapter reveal how extraordinarily complex they are, since they interact with many sectors and end-users of the energy system and the rest of the economy. Besides, CCU opportunities were found to be poorly modeled at the global level and in an integrated manner (Desport and Selosse, 2022b). Therefore, it appeared valuable to us to model and assess the future of CCU and CCS from two perspectives with two different models.

In this chapter, we present the two models we developed to carry out this study, namely TIAM-FR and EPPA, respectively owned by Mines Paris – PSL and MIT. We first present them separately and compare their characteristics in the third subsection to analyze their strengths and shortcomings. We further discuss our choice of using them in tandem for the analysis of the results in the fourth chapter.

Comme mentionné dans le chapitre précédent, l'objectif des modèles énergétiques prospectifs est d'envisager les futurs possibles du système énergétique mondial. Les décisions d'investissement concernant le déploiement de technologies visant à atteindre un objectif environnemental sont une sortie importante de tels modèles, entre autres. De nombreux modèles existent, impliquant différentes natures, étendues, explicitations technologiques ou réalismes économiques, ainsi que des paradigmes de résolution (IAMC-Documentation contributors, 2021). Cependant, les technologies de CCS et CCU décrites dans le chapitre précédent révèlent leur extraordinaire complexité, car elles interagissent avec de nombreux secteurs et utilisateurs finaux du système énergétique et du reste de l'économie. De plus, il a été constaté que les opportunités de l'UCG étaient mal modélisées à l'échelle mondiale et de manière intégrée (Desport et Selosse, 2022b). Il nous a donc semblé précieux de modéliser et d'évaluer l'avenir de l'UCG et de la CSC selon deux perspectives avec deux modèles différents.

Dans ce chapitre, nous présentons les deux modèles que nous avons développés pour mener à bien cette étude, à savoir le TIAM-FR et l'EPPA, respectivement détenus par Mines Paris – PSL et le Massachusetts Institute of Technology (MIT). Nous les présentons d'abord séparément et comparons leurs caractéristiques dans la troisième sous-section pour analyser leurs forces et faiblesses. Nous discutons ensuite de notre choix de les utiliser conjointement pour l'analyse des résultats dans le quatrième chapitre.

1. Presentation of TIAM-FR

TIAM-FR is the French version of the TIMES Integrated Assessment Model (TIAM). TIAM is the global version of the TIMES family models developed under the Energy Technology System Analysis Program (ETSAP, 2021). The Integrated MARKAL³-EFOM⁴ System (or TIMES) is the successor of two model paradigms known as MARKAL and EFOM, which respectively model market allocations and commodities fluxes and were developed in the early 1980s by ETSAP. TIMES is a generator of partial equilibrium techno-economic models representing the energy system of geographical areas – or regions – on a long-term horizon. It enables an assessment and discussion of the evolution of energy systems from a technological perspective and according to climate policies (taxes, agreements, etc.). It has been used for a wide range of applications at the local level (Andrade, 2022; Genave, 2021; Selosse

³ MARKAL stands for Market Allocation (Assoumou, 2006)

⁴ EFOM stands for Energy Flow Optimization Model (Grohnheit, 1991)

et al., 2018), national level (Assoumou, 2006; Doudard, 2017; Gaur et al., 2022; Millot et al., 2020; Seljom and Tomasgard, 2017), continental level (Postic, 2015; Siggini, 2022), and global level (Boubault and Maïzi, 2019; Kang, 2017; Morfeldt et al., 2015; Seck et al., 2022a; Selsosse, 2019).

As part of the TIMES model family, TIAM-FR is a linear programming partial equilibrium model. It is categorized as a bottom-up model because of its technology-rich description of the energy system, depicting and tracking how energy is extracted, transformed, and used in the world. Linear programming is formulated in the GAMS (General Algebraic Modelling System) language and solved with the linear programming optimizer CPLEX, by minimizing the total discounted cost of the energy system. The main results that can be discussed with TIAM-FR are the levels of GHG emissions, the primary energy use, the final energy use, the technologies processing final energy and satisfying energy demand, the marginal cost of producing energy or material commodities, and the total cost of satisfying global energy demand.

1.1. Structure of the TIAM-FR model

1.1.1. Spatial representation

TIAM-FR is a global energy model divided into fifteen regions shown in Figure 10. This disaggregation comprises 7 countries (USA, Canada, Mexico, China, India, South Korea, and Japan); some regions like Africa and Latin and Central America are highly aggregated, mainly due to a lack of national data for these regions and for simplicity. Energy trades are modeled between these regions, including crude oil, natural gas, coal, and bioenergy (Kang, 2017). For each region, specific socio-economic parameters are associated reflecting the cost of capital and labor (Table 5), along with the energy resources available (Pye et al., 2020).

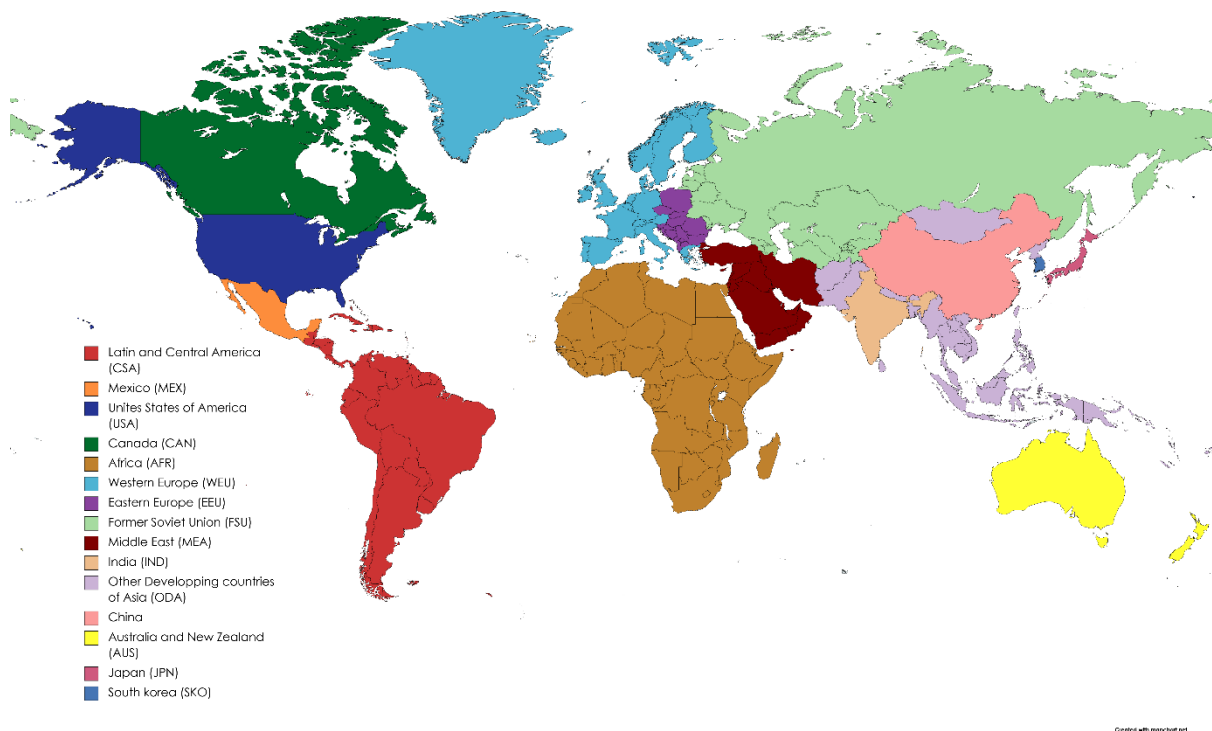

Figure 10: Regional disaggregation of the TIAM-FR model

Table 5: Region-specific capital and labor scalars in TIAM-FR

	AFR	AUS	CAN	CHI	CSA	EEU	FSU	IND	JPN	MEA	MEX	ODA	SKO	USA	WEU
Capital	1.25	1.25	1	0.9	1.25	1	1.25	0.9	1.4	1.25	1	1.25	1	1	1.1
Labor	0.7	0.8	1.0	0.6	0.7	0.7	0.7	0.6	1.0	0.7	0.8	0.6	0.8	1.0	0.9

1.1.2. Time representation

The base year of TIAM-FR is 2018. The model projects the world energy system until 2100 and solves the optimization problem every 10 years. The model is disaggregated into several periods over the time horizon (Figure 11). First, the model horizon is divided into periods called “milestone years” for which investment and activity decisions are chosen by the model to run the energy system at a particular year in the middle of each period, and they evolve linearly between the successive milestone years. These milestone years are divided into seasons (winter W, spring R, summer S, and fall F) to represent the time variability of energy demands and energy potentials over seasons. Furthermore, seasons are divided into so-called “time slices” defined as portions of the days (D), nights (N), and peak demands (P). This representation is useful to consider the intermittency of some renewable energies as well as the satisfaction of the crucial peak energy demand at some moments of a day, depending on the region and sector.

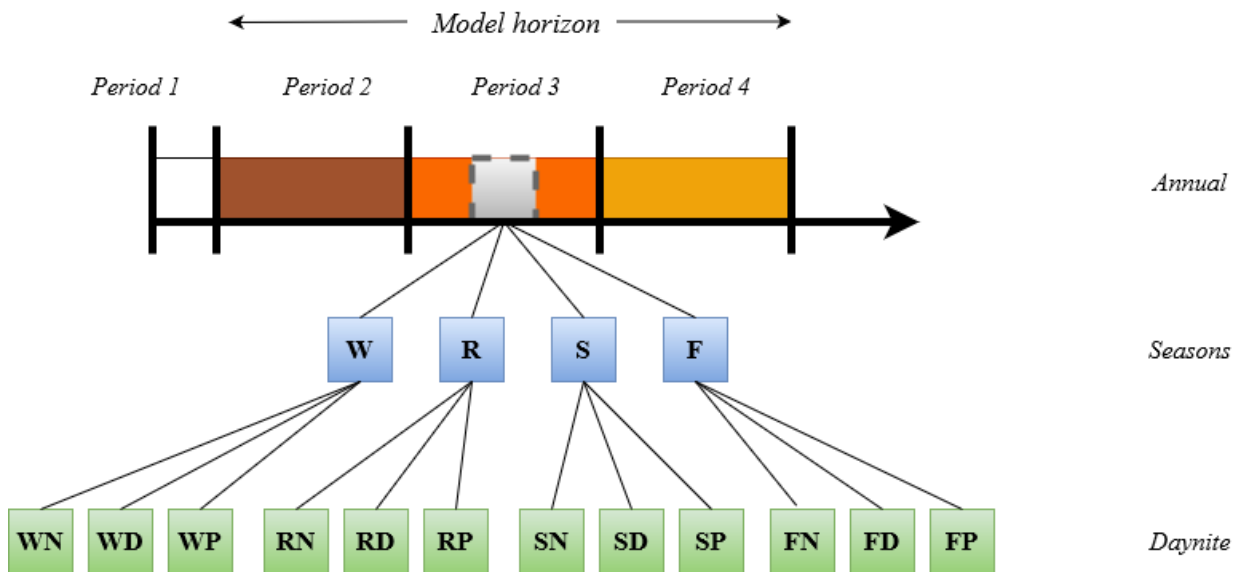

Figure 11: Representation of time in TIAM-FR

1.1.3. Energy representation

Thus, for each period in each region, the energy system is represented as a succession of commodities and processes linked together with energy and material flows. Processes are fundamental in TIMES modeling as they embody the techno-economic properties of the energy system. They are characterized by their capital expenditure (CAPEX), variable expenditures (VAROM), fixed expenditures (FIXOM), discount rate, lifespan, availability factor, capacity factor, efficiencies, and GHG emissions. A technology – or process – consumes a certain amount of a commodity to transform it into another commodity that can be consumed subsequently (Figure 12). The architecture of all commodities, processes and flows constitutes the Reference Energy System (RES) in TIMES modeling.

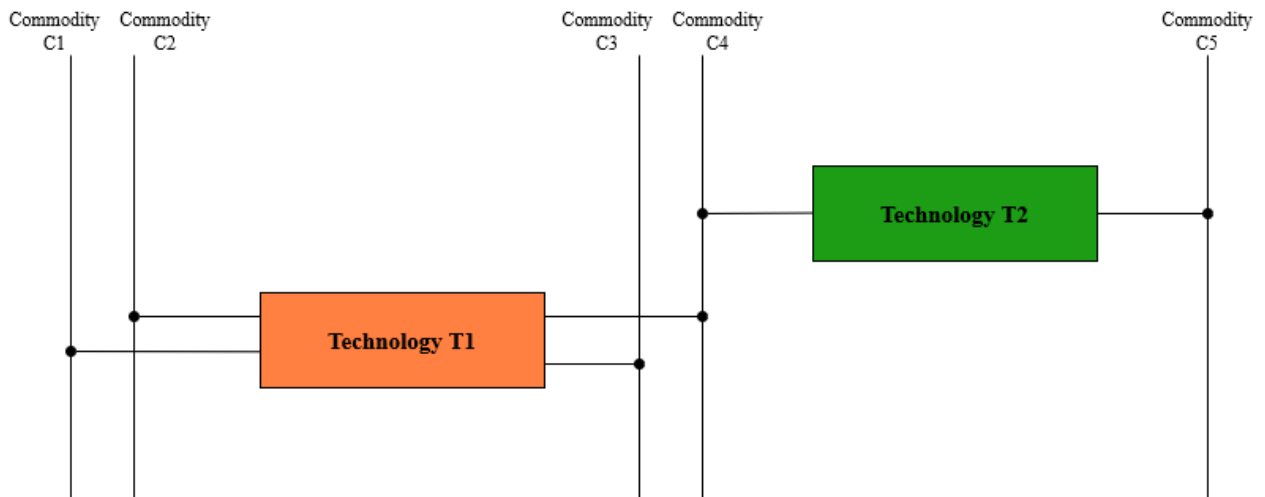

Figure 12: Elementary representation of commodity flows and technologies in TIMES

In TIAM-FR, the RES network links primary energy extraction and renewable energy potentials around the world to transform them into final energy that satisfies the energy demand of five sectors, i.e. the agriculture, commercial, residential, transport, and industry sectors. The technologies can be primary sources of energy (extraction processes), activity processes (power plants, factories, refineries, end-use devices such as cars and heating systems), or inter-regional exchange (IRE) used for trading commodities between regions. The commodities can be energy carriers (electricity, heat, fossil fuels, etc.), energy services (light duty transport, lighting needs, agriculture energy demand, etc.), materials (cement, steel, etc.), or GHG emissions (CO_2 , CH_4 , and N_2O). Figure 13 displays a synthetic view of the RES of TIAM-FR.

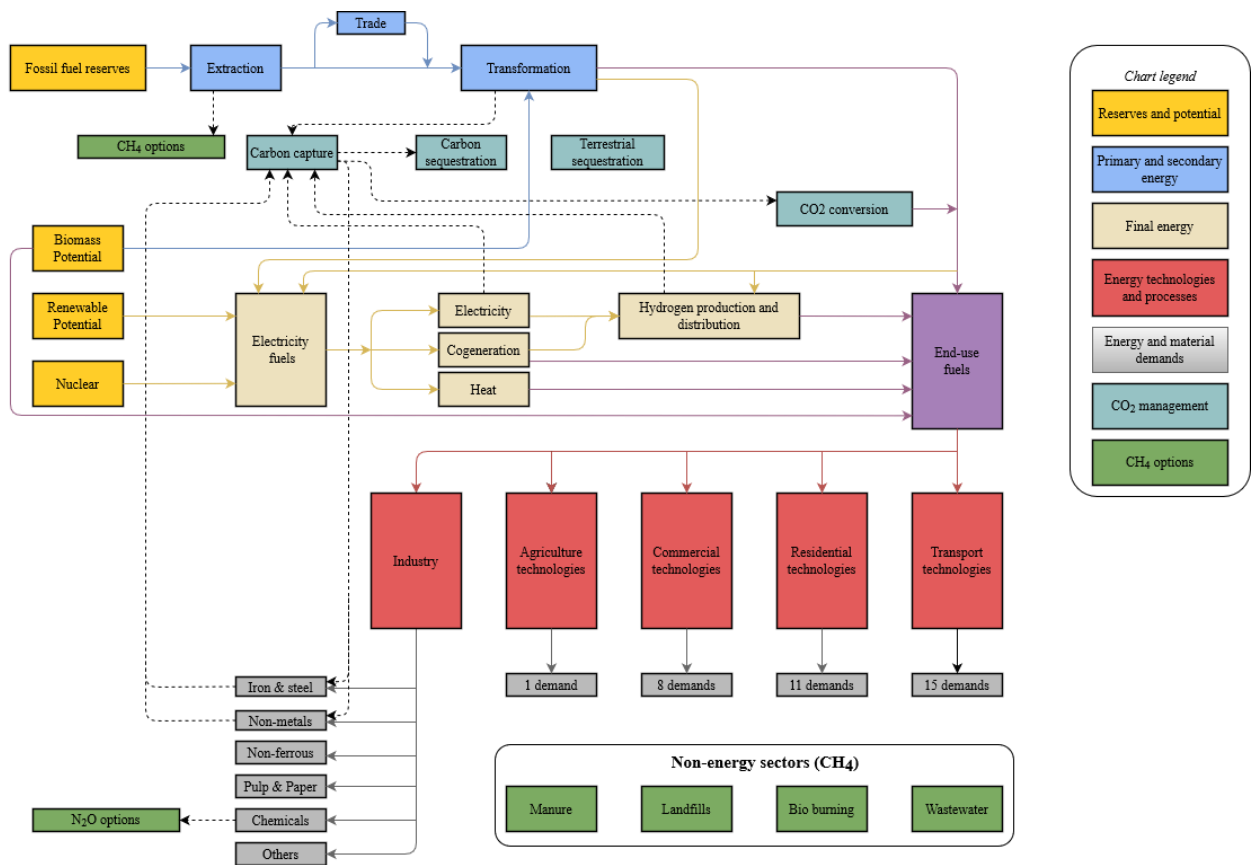

Figure 13: Reference Energy System (RES) of TIAM-FR

Thus, the global energy system is represented with the objective of satisfying each energy demand. The demand curves for demand commodities are obtained externally from other models that calculate the future socio-economic characteristics of the different regions of the world. In TIAM-FR, the base year demands come from the IEA Energy Balances (IEA, 2020b), and are projected according to their respective drivers and the elasticity of demands to their own driver, represented in equation (1).

Table 6 reports the demands respective to their driver. The elasticities and the drivers are intended to reflect changing patterns in energy service demands regarding socio-economic changes (gross domestic product, population, and households). For example, the demand for road transport by car is projected according to the evolution of GDP per capita, subject to a certain elasticity.

$$Demand_{r,t} = Demand_{r,t-1} \times driver^{elasticity_{r,t}} \quad (1)$$

Table 6: Energy services demand and respective drivers

Code	Description	Unit	Driver
TRT	Transport - Road Auto	Bv-km	GDPP
TRB	Transport - Road Bus	Bv-km	POP
TRL	Transport - Road Light Duty	Bv-km	GDP
TRC	Transport - Commercial Trucks	Bv-km	GDP
TRM	Transport - Medium Trucks	Bv-km	GDP
TRH	Transport - Road Heavy Duty	Bv-km	GDP
TRW	Transport - Road Two Wheels	Bv-km	POP
TRE	Transport - Road Three Wheels	Bv-km	POP
TAI	Transport - International Aviation	PJ	GDP
TAD	Transport - Domestic Aviation	PJ	GDP
TTF	Transport - Rail Fret	PJ	GDP
TTP	Transport - Rail Passengers	PJ	POP
TWD	Transport - Domestic Water	PJ	GDP
TWI	Transport - International Water	PJ	GDP
NEU	Non-Energy Uses	PJ	GDP
RSH	Residential - Space Heating	PJ	HOU
RSC	Residential - Space Cooling	PJ	HOU
RHW	Residential - Hot Water	PJ	POP
RLI	Residential - Lighting	PJ	GDPP
RCK	Residential - Cooking	PJ	POP
RRF	Residential - Refrigeration	PJ	HOU
RCW	Residential - Clothes Washing	PJ	HOU
RCD	Residential - Clothes Drying	PJ	HOU
RDW	Residential - Dishwashing	PJ	HOU
REA	Residential - Other Electric	PJ	HOU
ROT	Residential - Other	PJ	HOU
CSH	Commercial - Space Heating	PJ	GDP
CSC	Commercial - Space Cooling	PJ	GDP
CHW	Commercial - Hot Water	PJ	GDP
CLA	Commercial - Lighting	PJ	GDP

CCK	Commercial - Cooking	PJ	GDP
CRF	Commercial - Refrigeration	PJ	GDP
COE	Commercial - Other Electric	PJ	GDP
COT	Commercial - Other	PJ	GDP
AGR	Agriculture	PJ	GDP
IIS	Industry - Iron and Steel	Mt	GDP
INF	Industry - Non-Ferrous	Mt	GDP
ICH	Industry - Chemicals	PJ	GDP
ILP	Industry - Pulp and Paper	Mt	GDP
INM	Industry - Non-Metals	Mt	GDP
IOI	Industry - Other Industry	PJ	GDP
ONO	Other Non-Specified Consumption	PJ	GDP

Bv-km: Billion vehicles per kilometer; GDPP: Gross Domestic Product per Capita; POP: Population; HOU: Households

The methodology employed for energy and material demand projections is described in Chapter 3.

1.1.4. The climate module

In TIAM-FR, the emissions of the three main GHG (CO₂, CH₄, and N₂O) are modeled, considering their diverse origins. For combustion emissions, the emission factors are extracted from the World Conversion Factors database (OECD, 2019). We also consider process CO₂ emissions generated by the cement and steel industries, with different references from the literature (see Chapter 3). CO₂ emissions due to land-use changes are implemented exogenously from the base year onwards using the data from (Ritchie et al., 2020).

Table 7: Global exogenous CO₂ emissions from land use (in MtCO₂/yr) (Ritchie et al., 2020)

Year	AFR	AUS	CAN	CHI	CSA	EEU	FSU	IND	JPN	MEA	MEX	ODA	SKO	USA	WEU
2018	739	111	443	148	1012	37	798	111	0	0	18	296	0	74	74
2020	657	99	394	131	900	33	709	99	0	0	16	263	0	66	66
2030	575	86	345	115	787	29	621	86	0	0	14	230	0	57	57
2040	493	74	296	99	675	25	532	74	0	0	12	197	0	49	49
2050	410	62	246	82	562	21	443	62	0	0	10	164	0	41	41
2060	328	49	197	66	450	16	355	49	0	0	8	131	0	33	33
2070	246	37	148	49	337	12	266	37	0	0	6	99	0	25	25
2080	164	25	99	33	225	8	177	25	0	0	4	66	0	16	16
2090	82	12	49	16	112	4	89	12	0	0	2	33	0	8	8
2100	27	4	16	5	37	1	30	4	0	0	1	11	0	3	3

The methane and N₂O emissions generated by manure, wastewater, and waste landfills are taken from EMF-22 (Labriet and Loulou, 2005).

Once these emissions are accounted for, the TIAM-FR model is equipped with a Climate Module capable of estimating the impact of the energy system on key environmental indicators such as:

- The changes in GHG concentrations in the atmosphere, the upper ocean, and the lower ocean
- The total change (over the pre-industrial period) in atmospheric radiative forcing due to anthropogenic causes
- The temperature changes (over the pre-industrial period)

These indicators are calculated with climate equations taken from (Nordhaus, 1999) and fully described in (Loulou and Labriet, 2008). Because TIAM-FR assesses changes to both the energy system and the climate, the model is considered as an Integrated Assessment Model (IAM).

1.2. Optimization paradigm of TIAM-FR

In linear programming, an optimization problem consists in minimizing or maximizing an objective function which is expressed by decision variables subject to constraints. In TIAM-FR, the optimization problem determines the partial economic equilibrium⁵ of the energy system, or the total discounted cost minimized over all periods of the model's horizon, while respecting any technical, environmental, and policy constraints.

$$\min c \cdot X \quad (2)$$

$$s. t. \quad \forall t \in T, \forall i \in I, Q_{k,i}(t) \geq D_i(t) \quad (3)$$

$$B \cdot X \geq b \quad (4)$$

Where

X	The vector of all variables associated with the vector c
c	The vector of discounted costs
I	Demand for energy services
T	Years of the horizon studied
$Q_{k,i}(t)$	Technology capacities k able to satisfy the demand i of period t
$D_i(t)$	Exogenous demand for energy service I to be satisfied at period t
B, b	Matrix and vector of exogenous constraints

Equation (2) describes the objective function, or the total discounted cost to be minimized. Equation (3) expresses that the supply must equal or exceed the demand. Equation (4) gathers and expresses all technical constraints. By solving the problem, the model gives, for each period and each region, the values of decision variables and the marginal cost associated with each constraint. Before describing the decision variables in the model, some parameters relative to the formulation of TIMES must be defined.

$r \in R$	Represents one region r among the set R of all regions
$t \in T$	Represents one period t among the set T of the time horizon
$v \in V$	Represents the vintage v among the set V of all vintages
$s \in S$	Represents the time slice s among the set S of all time slices
$p \in P$	Represents the process p among the set P of all processes
$c \in C$	Represents the time slice c among the set C of all commodities

1.2.1. Decision variables

For TIMES models including TIAM-FR, the decision variables present in equations (2) and (4) are described below.

$ACT(r, v, t, p, s)$	Activity level of technology p , in region r and period t (optionally vintage ⁶ v and time-slice s). Typical units: PJ for all energy technologies. The s index is relevant only for processes that produce or consume commodities specifically declared as time-sliced.
----------------------	--

⁵ Partial equilibrium means that the computation focuses on a single sector of the economy, which is the energy sector here.

⁶ The role of the "vintage" function is illustrated to deal with processes whose characteristics change over time (other than the cost of the investment) when building new capacity.

$CAP(r, v, t, p)$	Total installed capacity of technology p , in region r and period t , all vintages together. The CAP variables are only defined when a bound or user-constraint is specified for them.
$NCAP(r, v, p)$	New capacity addition (investment) for technology p , in period v and region r . For all technologies the v value corresponds to the vintage of the process, i.e., year in which it is invested. For vintaged technologies (declared as such by the user) the vintage (v) information is reflected in other process variables, discussed below.
$FLOW(r, t, p, c, s)$	The quantity of commodity c consumed or produced by process p , in region r and period t (optionally with vintage v and time-slice s). The $FLOW$ variables confer considerable flexibility to the processes modeled in TIMES, as they allow the user to define flexible processes for which input and/or output flows are not rigidly linked to the process activity.
$SIN(r, t, p, c, s)$ and $SOUT(r, v, t, p, c, s)$	Quantity of commodity c stored or discharged by storage process p , in time-slice s , period t (optionally with vintage v), and region r .
$TRADE(r, t, p, c, s)$	Quantity of commodity c (PJ per year) sold (exp) or purchased (imp) by region r through export (resp. import) process p in period t (optionally in time-slice s).

1.2.2. Objective function

The objective function corresponds to the net present value of the total discounted cost of the energy system of each region, which can be expressed as follows:

$$NPV = \sum_r \sum_t (1 + d_{r,t})^{BY-t} \times Cost_{r,t} \quad (5)$$

Where

NPV	Net Present Value
$d_{r,t}$	Discount rate of region r at period t
BY	Base year (2018 in TIAM-FR)
$Cost_{r,t}$	Annual cost in region r at period t

1.2.3. Constraints

The model minimizes the equation (5) while satisfying a large number of constraints listed below (Loulou, 2008).

2.1.1.1.1 Capacity transfers

Investment in a technology increases that technology's capacity throughout the life of the process. This constraint considers for each technology the installed capacity that is accessible in period t and the investments made before or during period t , as long as the

$$CAP(r, t, p) = \sum_{\substack{t' < t \\ t-t' < LIFE(r,p)}} NCAP(r, t', p) + RESID(r, t, p) \quad (6)$$

Where

$LIFE(p)$	Represents the lifespan of a process p in a region r
$RESID(r, t, p)$	Represents the residual capacities of a process p corresponding to investments that were made prior to the model's base year (exogenous)

2.1.1.1.2 Use of capacity

The maximum utilization of the installed capacity during the assigned time slice is configured by the user-defined availability factor $AF(r, t, p, s)$. The equation below ensures that the model may use some or all of the installed capacity during certain time slices.

$$ACT(r, t, p, s) \leq AF(r, t, p, s) \cdot CAP2ACT(r, p) \cdot FR(r, s) \cdot CAP(r, v, t, p) \quad (7)$$

Where

$CAP2ACT(r, p)$ Represents the conversion factor between units of capacity and activity of a process p in a region r
 $FR(r, s)$ Is equal to the duration of time slices s

2.1.1.1.3 Process activities

The equation below links the activity level of a process with the inlet and outlet commodity flows. The Primary Commodity Group PCG is the group of commodities that defines the activity of a technology.

$$ACT(r, t, p, s) = \sum_{c \in PCG(p)} \frac{FLOW(r, t, p, c, s)}{ACTFLO(r, p, c)} \quad (8)$$

Where

$ACTFLO(r, p, c)$ Represents the conversion factor from the activity of the process to the flow of a particular commodity (often equal to 1)

2.1.1.1.4 Commodity balance equation

This ensures that the flow of each commodity present in a region r and generated either from production processes, imports, or stocks, is superior or equal to the flow of the commodity summed over the exports, the consumption, the stocks, or any exogenous demand.

$$\begin{aligned} & \sum_{p, c \in TOP(r, p, c, out)} (FLOW(r, v, t, p, c, s) + SOUT(r, v, t, p, c, s) \cdot STG_{EFF}(r, v, p)) \\ & + \sum_{p, c \in RPC_IRE(r, p, c, imp)} TRADE(r, t, p, c, s, imp) \\ & + \sum_{p \in Release(r, t, p, c)} NCAP(r, t, p, c) \cdot COM_IE(r, t, c, s) \\ & \geq \sum_{p, c \in TOP(r, p, c, in)} (FLOW(r, v, t, p, c, s) + SIN(r, v, t, p, c, s)) \\ & + \sum_{p, c \in RPC_IRE(r, p, c, exp)} TRADE(r, t, p, c, s, exp) + \sum_{p \in Sink(r, t, p, c)} NCAP(r, t, p, c) \\ & + FR(c, s) \cdot DM(c, t) \end{aligned}$$

Where

$TOP(r, p, c, in/out)$ Identifies that there is an input/output flow of commodity c into/from process p in region r
 $RPC_IRE(r, p, c, imp/exp)$ Identifies that there is an import/export flow into/from the region of commodity c via process p
 $STG_{EFF}(r, v, p)$ Is the efficiency of storage process p
 $COM_IE(r, t, c, s)$ Is the infrastructure efficiency of commodity c (i.e., the transmission efficiency of the electricity grid)

$Release(r, t, p, c)$	Is the amount of commodity c recuperated per unit of capacity of process p dismantled
$Sink(r, t, p, c)$	Is the quantity of commodity c required per unit of the new capacity of process p

2.1.1.1.5 Definition of flow relationships in a process

With several commodities of commodity groups $cg1$ and $cg2$ in and out of a process p , the following constraint leaves some freedom to individual input or output flows.

$$\sum_{c \in cg2} FLOW(r, v, t, p, c, s) = FLOFUNC(r, cg1, cg2, s) \cdot \sum_{c' \in cg1} FLOW(r, v, t, p, c, s)$$

2.1.1.1.6 Limiting flow shares in flexible processes

Given the above equation, the model is quite flexible when a process has several commodities as inputs or outputs. The following constraint can control the shares of input/outputs either with lower, fixed or upper bounds, depending on the process

$$FLOW(c, p, r, t) \begin{cases} \leq FLOSHAR(c, p, r, t) \cdot \sum_{c' \in cg} FLOW(c', p, r, t) \\ \geq FLOSHAR(c, p, r, t) \cdot \sum_{c' \in cg} FLOW(c', p, r, t) \\ = FLOSHAR(c, p, r, t) \cdot \sum_{c' \in cg} FLOW(c', p, r, t) \end{cases}$$

2.1.1.1.7 Peaking reserve constraint

This constraint imposes that the total capacity of all processes producing a commodity c at each time period and in each region r must exceed the average demand in the time-slice s where peaking occurs by a certain percentage. This percentage is the Peak Reserve Factor, $RESERV(r, t, c)$. It is chosen to insure against several contingencies, such as

- a possible commodity shortfall due to uncertainty regarding its supply
- unplanned equipment down time
- random peak demand that exceeds the average demand during the time-slice when the peak occurs

$$\begin{aligned} & \sum_{\substack{p \in TOP(r, p, c, out) \\ c \in PCG}} CAP2ACT(r, p) \cdot Peak(r, v, p, c, s) \cdot FR(s) \cdot CAP(r, v, t, p) \cdot ACTFLO(r, v, p, c) \\ & + \sum_{\substack{p \in TOP(r, p, c, out) \\ c \in PCG}} Peak(r, v, p, c, s) \cdot FLOW(r, v, t, p, c, s) + TRADE(r, t, p, c, s, i) \\ & \geq (1 + RESERVE(r, t, c, s)) \\ & \cdot \sum_{p \in TOP(r, p, c, in)} FLOW(r, v, t, p, c, s) + TRADE(r, t, p, c, s, e) \end{aligned}$$

Where

$Peak(r, v, p, c, s)$ Specifies the fraction of technology p 's capacity in a region r for a period t , and a commodity c that is allowed to contribute to the peak load in slice s

2.1.1.1.8 User constraints (UCs)

In addition to the constraints detailed above, a large number of constraints were defined by the previous users of the model mentioned in the introduction. They were implemented in order to constrain the outputs of the model in specific scenarios, such as the quantity of biomass available, the maximum generation share of intermittent electricity, or the total nuclear and hydro capacities deployable in the power sector. With UCs, the user may render the modeling more realistic.

1.2.4. Equilibrium in TIAM-FR

As mentioned above, TIAM computes a linear problem, which means that there are no economies of scale, but does not mean that production functions behave in a linear fashion. Each technology may be implemented at any capacity, continuously from a lower limit to a particular upper limit. In a real economy, technologies tend to be invested in discrete sizes influencing the capital cost.

The suppliers of a commodity are processes, and the consumers of a commodity can be other processes or demands. As TIAM is a sequence of processes and technologies, many suppliers are also consumers, but not of the same commodity. The set of suppliers of a commodity is defined by its supply curve, plotting the marginal production cost of a commodity as a function of the quantity produced. By solving the optimization problem, the model chooses the least cost supply curve depending on the many constraints it is subject to. Thus, the supply curve is endogenous. However, as we assume that there are no price elasticities, the demand curve for energy services is exogenous. Therefore, the model is limited to minimizing the cost of supplying these demands. When the supply meets the demand, the model has reached an equilibrium quantity Q_E and an equilibrium price P_E , corresponding to the marginal system value of the commodity in the economy, in accordance with the assumption of competitive markets with perfect foresight.

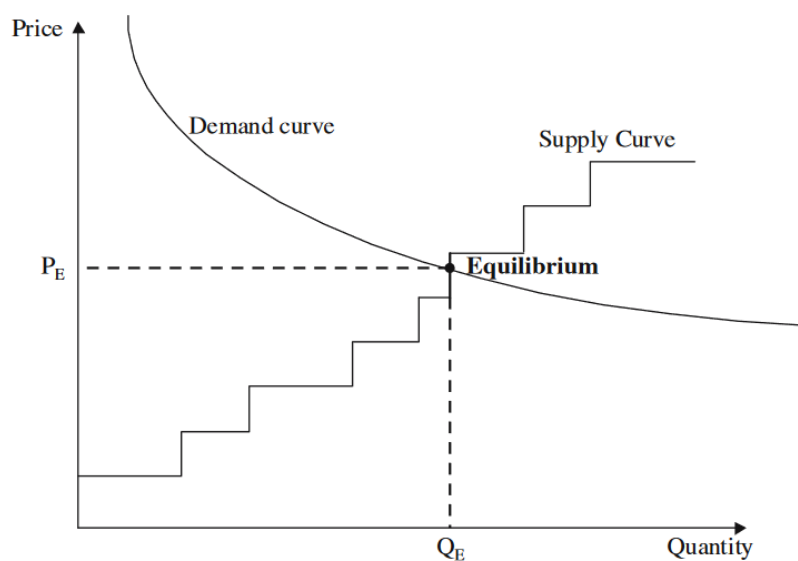

Figure 14: Equilibrium in TIAM-FR: the user explicitly provides the demand curve, and the model maximizes suppliers' surplus (Loulou and Labriet, 2008)

This equilibrium is reached for each commodity and each period, as each agent has perfect foresight, i.e., complete knowledge of the market's present and future parameter.

To summarize, TIAM is a linear, bottom-up, technology explicit, multi-regional, partial equilibrium model, that assumes competitive markets and perfect foresight.

2. The EPPA model

The Economic Projection and Policy Analysis (EPPA) model is an optimization tool developed by the Massachusetts Institute of Technology (MIT). EPPA is a top-down, computable general equilibrium (CGE) model that performs an optimization of the global economy, including the energy sector. It has been widely used for energy economics (Fajardy et al., 2021; Kapsalyamova and Paltsev, 2020; Paltsev et al., 2011), land-use (Gurgel et al., 2007, 2021), technology (Morris et al., 2019a; Smith et al., 2021a), and climate policy analysis (Karplus, 2011; Octaviano et al., 2016), either at the global level or national level. The main outputs that can be discussed with EPPA are the emission levels, the temporal energy mix, energy prices, energy demand, and land-use changes. The strength of EPPA lies in its capability to consider feedbacks from the consumer side and endogenous technology learning

The first version of EPPA was developed in the 1990s and formulated in GAMS, solved by the PATH solver (Yang et al., 1996). In the next version, EPPA adopted the MPSGE language, which is a subsystem of GAMS developed by (Rutherford, 1999) that simplifies the effort of building a CGE model (Chen et al., 2022). The model described hereafter is in its seventh version (EPPA7).

2.1. Static component

As illustrated in Figure 15, EPPA7 represents the circular flows of goods and services in the economy between three types of agent: a representative household, producers, and a government. The household (consumer sector) owns primary factors (labor, capital, and natural resources), provides them to producers, and receives income for the service they provide (wages, capital earning and resource rent). The household allocates income to consumption and savings. In addition, the household pays taxes to the government and receives net transfers from it. The producers transform primary factors and intermediate inputs, *i.e.* outputs from other producers, into goods and services sold to other producers (domestic or foreign) or households, or governments, and receive payments in return. The government collects taxes from households to finance government consumption and transfers. In addition, the government can be considered as a production sector that purchases goods and services to produce an aggregated government output that can be viewed as a public good. The demand for the public good is not endogenous, and instead it is assumed that part of household income is allocated to acquiring the public good.

For a typical CGE model, EPPA7 finds the equilibrium by solving a mixed complementarity problem (MCP), where three inequalities must be satisfied: zero-profit, market clearance, and income balance conditions.

Zero-profit conditions represent cost-benefit analyses for economic activities. This requires that any activity operated must earn zero profits, *i.e.*, the value of inputs must equal or surpass the value of outputs (Chen et al., 2017). For households, the economic activity is the utility; for each producer, the economic activity is the output. A typical zero-profit condition expressed in MCP format is:

$$MC - MB \geq 0; Q \geq 0; [MC - MB] \cdot Q = 0 \quad (1)$$

For instance, if a zero-profit condition is applied to a production activity, then if the equilibrium output $Q > 0$, the marginal cost MC must equal the marginal benefit MB , and if $MC > MB$ in equilibrium, the producer has no reason to produce. Note that $MC < MB$ is not an equilibrium state since Q will increase until $MC = MB$. Other activities such as investment, imports, exports, and commodity aggregation modeled using the Armington assumption (Armington, 1969) have their own zero-profit conditions.

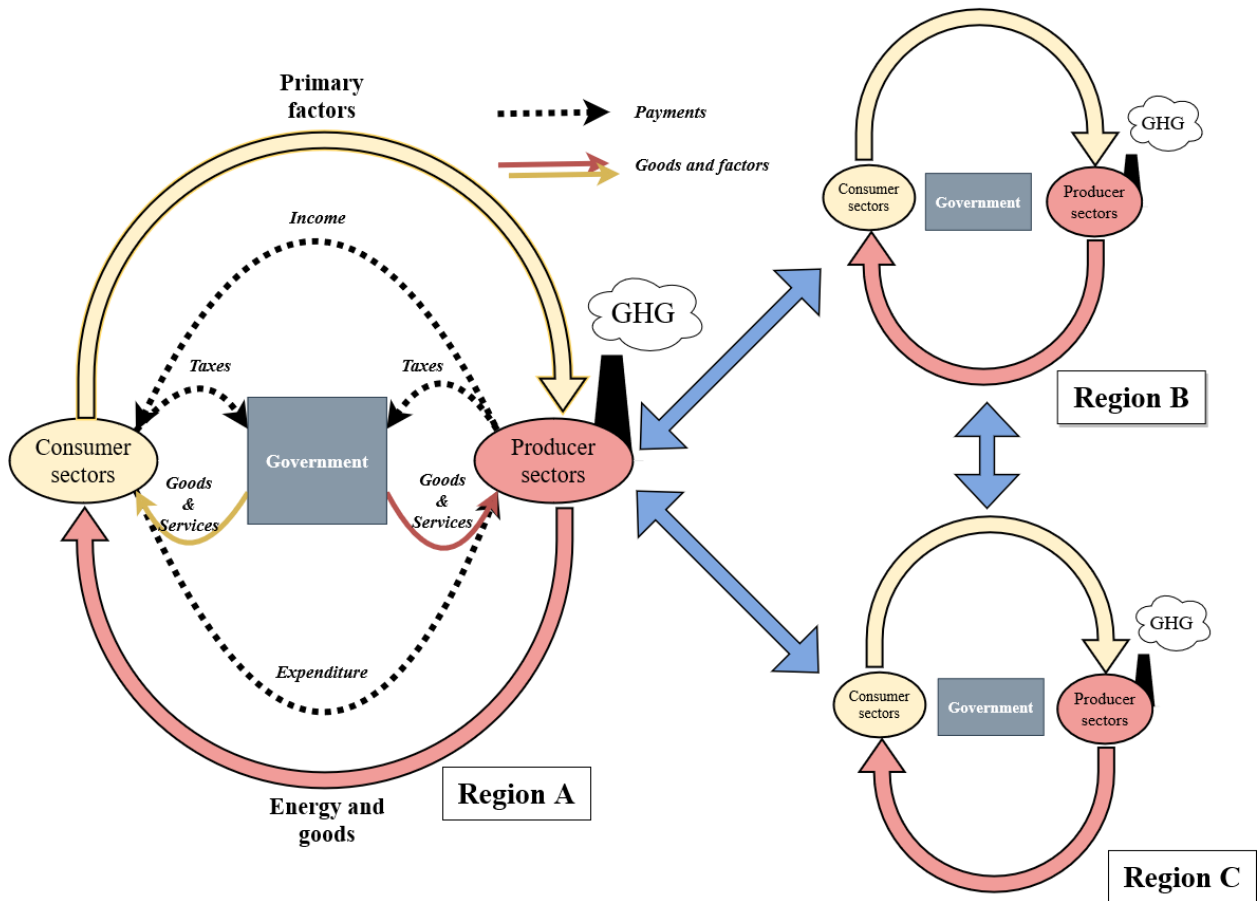

Figure 15: The circular flow of goods and services in EPPA7

For each market-clearing condition, the price level is determined based on market demand and supply. A typical market-clearing condition in MCP format is:

$$S \geq D; P \geq 0; [S - D] \cdot P = 0 \quad (2)$$

The market-clearing condition states that for each market, if there is a positive equilibrium price P , then P must equalize supply S and demand D . If $S > D$ in equilibrium, then the commodity price is zero. Similarly, in Condition (2), $S < D$ is not in equilibrium because in that case, P will continue to increase until the market is clear ($S = D$).

Income-balance conditions specify household and government income levels that support their spending levels. They require that, for each agent, the income values must equal the value of factor endowments and tax revenues. A typical income-balance condition in MCP format is:

$$E \geq I; E \geq 0; [E - I] \cdot E = 0 \quad (3)$$

That expenditure E equals income I always holds in CGE models. Another important feature of the general equilibrium is that only relative prices matter — meaning that the overall price level is not determined. Hence, this requires that a numeraire good is chosen, whose price is set to unity.

Many CGE models, including EPPA7, use nested Constant Elasticity of Substitution (CES) functions. In a CES function, the elasticity of substitution specifies the extent to which one input can be substituted by others under a given level of output when the relative price of inputs changes. The Armington aggregation for imported and domestic products uses a CES function, and the elasticity of substitution between domestic and imported products controls the degree to which products differ. In a production activity that uses fossil fuel and others as inputs, the substitution elasticity between fossil fuel and other

inputs determines to what level the fossil fuel use can be replaced by other inputs if the fossil fuel price increases. Similarly, the elasticity of substitution in a utility function characterizes consumer preference (i.e., the substitution possibility between various consumption goods when facing a price change). CES functions are constant returns to scale, which means if all inputs are doubled, the output will be doubled as well, therefore all inputs of CES production and consumption structures that are used throughout EPPA7 are necessary inputs. The model adopts a Stone-Geary preference with a time-varying shift parameter (*a.k.a.* “subsistence consumption”) to overcome this limitation. Specifically, the income elasticities are calibrated for the final demand of crops, livestock, food, and transportation (including public and private transportation) based on empirical evidence (Kishimoto, 2018; Reimer and Hertel, 2004).

2.2. Equilibrium problem

The optimal solution of EPPA7 is found by solving the following problem.

In each region r , and for each sector i , a representative firm – or producer – chooses a level of output y , quantities of primary factors k (indexed by f) and intermediate inputs x from other sectors j to maximize profits subject to the constraints of its production technology. The producer’s problem is then

$$\begin{aligned} \max_{y_{ri}, x_{rji}, k_{rfi}} \quad & \pi_{ri} = p_{ri} y_{ri} - C_{ri}(p_{ri}, w_{rf}, y_{ri}) \\ \text{such that} \quad & y_{ri} = \varphi_{ri}(x_{rji}, k_{rfi}), \end{aligned} \quad (1)$$

Where π and C denote the profit and cost functions, respectively; and p and w are the prices of goods and factors respectively.

As mentioned above, in EPPA7, production is represented with constant elasticity of substitution (CES) technologies which express constant returns to scale (CRTS) and simplifies Equation (1). Indeed, the linear homogeneity enables us to express unit cost and unit profit functions and CRTS involves that firms make zero economic profits at equilibrium:

$$p_{ri} = c_{ri}(p_{rj}, w_{rf}) \quad (2)$$

Where c is the unit cost function.

In each region, a representative agent is endowed with the supplies of the factors of production, the services of which may be sold or leased to firms. In each period, the representative agent chooses consumption and saving to maximize a welfare function subject to a budget constraint given by the level of income M :

$$\begin{aligned} \max_{d_{ri}, s_r} \quad & W_{ri}(d_{ri}, s_r) \\ \text{such that} \quad & \\ M_r = \sum_f w_{rf} K_{rf} = p_{rs} s_r + \sum_i p_{ri} d_{ri} \end{aligned} \quad (3)$$

where s is saving, d is the final demand for commodities, and K is the aggregate factor endowment of the representative agent in region r .

Consumer preferences are also represented through CES utility functions. For each region, there exists a unit expenditure function that corresponds to the configuration in (3), given by:

$$p_{rw} = E_r(p_{ri}, p_{rs}) \quad (4)$$

Figure 16 presents the structure of the expenditure function that characterizes the preference of the representative household.

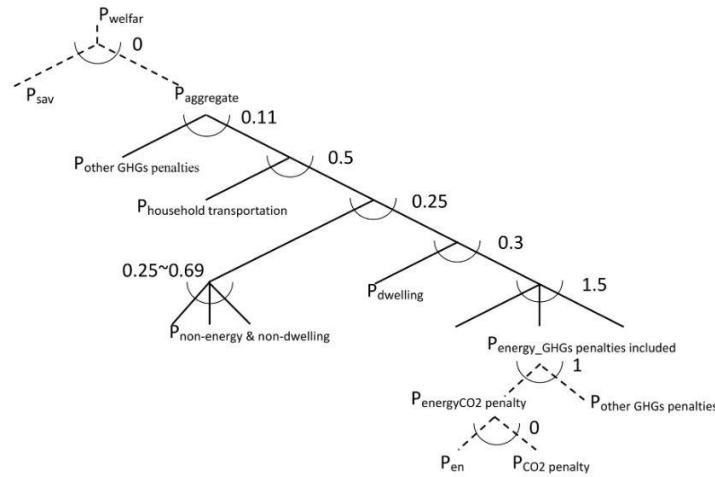

Figure 16: The expenditure function structure (Chen et al., 2022)

2.3. Structure of the EPPA7 model

2.3.1. Social Accounting Matrix

Social Accounting Matrices (SAMs) contain data representative of the economy of each region in the model for the base year of 2014 (Chepeliev, 2020). They quantify the flows of goods and services between sector of the economy. EPPA7 can track the physical flows of fuels and resources in the economy, and their greenhouse gas emissions, in order to identify the specific sectors that are most affected by the policies studied.

A social accounting matrix (SAM) contains the base year input-output and supply-demand structures of the economy. It provides a consistent picture of production activities, market transactions, and income-expenditure flows between different agents in the economy. Figure 17 provides the structure for the SAM of each region in EPPA7, which is constructed based on the micro-consistent format of SAM presented in (Rutherford, 1999) — each row corresponds to a market-clearing condition, and columns characterize the zero-profit condition of an activity, except for the last column which represents the income-balance condition of the economy. Variables in blue denote the output of each activity, the supply of each market, or the endowment of the representative agent (those in the last column); variables in black are the input of each activity, the demand of each market, or the aggregate consumption of the representative agent (those in the last column). To keep the symbols clean, sectorial and regional indices of each variable are dropped. Domestic production activities are presented in Columns 1–3, where $XP0$, N_E0 , and H_E0 denote outputs by sector d (all sectors except for nuclear and hydropower), n_e (nuclear power), and h_e (hydropower), respectively. $XDP0$, N_S0 , and H_S0 are energy and non-energy inputs from domestic production, and $XPM0$, N_OT0 , and H_OT0 are imported energy and non-energy inputs. Domestically produced and imported inputs are aggregated together by applying the Armington assumption. $LABD$, N_L0 , and H_L0 are labor inputs; $KAPD$, N_K0 , and H_K0 are capital inputs; and $FFACTD$, N_R0 , and H_R0 are other resource inputs. When CO₂ emissions are priced, the carbon penalty will be reflected in higher prices for energy inputs. For the crops sector and the industry sector with CO₂ emissions related to production rather than energy consumption, the carbon penalty for emission levels $OUTCO2$ becomes a necessary input. Lastly, TD , TI , and TF are taxes on output, intermediate input, and primary input, respectively. Columns 4–6 are for activities of capital formation inv , international transportation services ($htrn$), and household transportation ($XDIO$). The inputs of capital formation include $XDIO$ (domestic produced inputs) and $XMIO$ (imported inputs) with the output $INV0$, which becomes part of the next period's capital stock. The regional input for international transportation services is denoted by VST , while the output is $\sum \sum VST$. Household transportation $TOTTRN$ includes the service from privately owned vehicles (which needs inputs from the service sector TSE , from the other sector TOI , and from the refined oil sector TRO), and the service from the

purchased transportation $PURTRN$. Taxes paid by this activity are denoted by TP . Columns 7–12 are activities for adding carbon and GHG penalties to the consumer prices of various energy consumptions. In these columns, $EIND$, $EUSEP$, and ε are sectorial energy use without a carbon penalty, sectorial energy use with a carbon penalty, and the emissions coefficient, respectively. Similarly, we have $HEFD$ and $TEFD$ for household non-transport energy use and household transport energy use, both excluding carbon penalties. $HEUSEF$ and $TEUSEF$, on the other hand, denote the same types of energy use with the carbon penalty included.

Column 13–16 are activities for Armington aggregation a , trade m , total household consumption z , and welfare (utility) function w , respectively. Armington output $A0$ is the aggregation of domestic product $D0$ and imports $XM0$, and the latter comes from exports of other regions $WTFLOW$ plus the international transportation service $\sum VTWR$, which is the same as $\sum \sum VST$. Total household consumption $CONS0$ includes Armington goods (the sum of XDC (domestic produced commodities) and XMC (imported commodities), household transportation $TOTTRN$, and non-transportation energy consumption $ENCE$. Household utility $W0$ is derived from consumption $CONS0$ and saving $INV0$. The government activity $govt$ represents how the government's Armington consumption (sum of domestic commodities $XDG0$ and imported commodities $XMG0$) and the associated tax payment TG are converted into government output $G0$. Column 19 is for the income balance condition of the representative household ra . The total (gross) household income is constituted of net labor income $LABOR$, net capital income $CAPITAL$, resource rents including $FFACT$, N_R , H_R , and the tax payment GRG , while the household expenditure is allocated to purchasing utility $w0$ and spending on government output GRG , which is exogenously determined and is assumed to increase proportionally to GDP growth since the government is treated as a passive entity in EPPA7.

On the other hand, Rows 1–4 are market clearing conditions for domestic production, loanable funds, international transportation, and household transportation, respectively. Rows 5–11 are market clearing conditions for Armington goods, Rows 12–14 are market clearing conditions for imports, total household consumption, and utility, respectively. Rows 15–19 are market clearing conditions for primary factors (labor, capital, and natural resources), Row 20 and Row 21 are market clearing conditions for government service and emissions constraint, respectively, and Row 22 presents the resource for tax payment GRG and where it goes.

	d	d_d	d_e	d_e	d_e	d_e	d_e	d_e	Indus ^t	Indus ^t	Indus ^t	Indus ^t	Indus ^t	Inv	yt	Item	eid	eid _g	eid _{gh}	teid _g	teid _{gh}	a	m	z	v	govt	ra
	elec aggr	fossil gen aggr	tele aggr	tele hele	tele sele	tele sele	tele rele	ran an	ran agrito	ran agrito	ran ngrass	ran nfor	ran to for	Inv	yt	Item	eid	eid _g	eid _{gh}	teid _g	teid _{gh}	a	m	z	v	govt	ra
note:																											
pd	xp0	xp0	xp0	xp0	xp0	xp0	xp0																				
pd_d			xp0	xp0	xp0	xp0	xp0																				
pd_d			xp0	xp0	xp0	xp0	xp0																				
pd_n			xp0	xp0	xp0	xp0	xp0																				
pd_t			xp0	xp0	xp0	xp0	xp0																				
plnemi(nat)																											
plnemi(agri)																											
plnuse(nat)																											
prv																											
pt																											
ptm																											
pal_c																											
pal_g																											
pal_g																											
pal_gh																											
pal_c																											
pal_ch																											
pa																											
pm																											
pu																											
pv																											
pl																											
pk																											
pl																											
pr																											
pg																											
pcarb																											
plcarb																											
TAX																											

Figure 17: Social accounting matrix of EPPA7 (Chen et al., 2017)

2.3.2. Production sectors and regions

The economy is split into 8 energy sectors, namely crude oil, refined oil, liquid fuel from biomass, oil shale, coal, natural gas (conventional, shale, and tight), electricity, and synthetic gas from coal gasification. In addition, there are 9 non-energy sectors, comprising crops, livestock, forestry, food, energy intensive industry, manufacturing, service, commercial transport, and household transport. Together, they form the global economy. As shown in Figure 18, EPPA7 disaggregates the global economy into 18 regions, of which 10 are countries (USA, Canada, Mexico, Brazil, Russia, China, South Korea, Japan, India, and Indonesia).

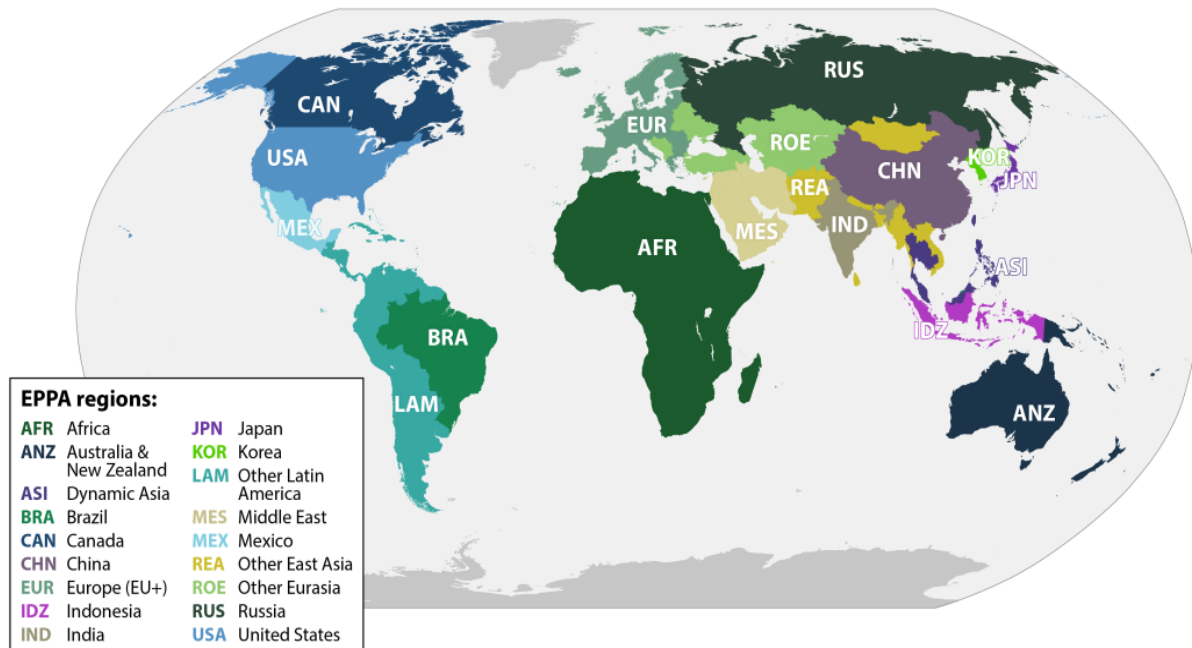

Figure 18: Spatial disaggregation in EPPA7

The core data used to represent the sectors among regions of the world come from the GTAP-power 10 of the Global Trade Analysis Program (GTAP) (Chepeliev, 2020), which details and classifies the global economy. The data are extracted for the base year 2014 and aggregated to match with the structure of EPPA7.

Production technologies are described using nested CES functions whose key elasticities of substitution used in reference runs of the model are given in Table 9. Elasticities of substitution were re-evaluated and updated based on the review of the literature and expert elicitation conducted by (Cossa, 2004).

One of the main applications of EPPA7 is to provide projections of emissions of GHG and air pollutants. The GHG emissions considered in EPPA7 are CO₂, CH₄, N₂O, PFCs, HFCs, SF₆, and the air pollutants included are CO, VOCs, NOX, SO₂, BC, OC, and NH₃. As with the energy data, the base year combusted CO₂ emissions (i.e., emissions from burning fossil fuels) are calibrated to IEA (2016), which provides the base year data. The process-based CO₂ emissions (emissions from industrial processes other than burning fossil fuels) are from Our World in Data (2022).

Table 8: Sectors in EPPA7 and their labels

Sector	EPPA7 notation
Agriculture - Crops	CROP
Agriculture - Livestock	LIVE
Agriculture – Forestry	FORS
Food products	FOOD
Coal	COAL
Crude oil	OIL
Refined oil	ROIL
Gas	GAS
Electricity	ELEC
Coal-fired generation	cele
Gas-fired generation	gele
Hydro generation	hele
Nuclear generation	nele
Oil-fired generation	oele
Other generation	rele
Solar generation	sele
Wind generation	wele
Transmission and distribution	tele
Energy-intensive industries	EINT
Other industries	OTHR
Ownership and Dwellings	DWE
Services	SERV
Transport	TRAN

Table 9: Substitution elasticities in EPPA7 (Chen et al., 2022)

Type of substitution elasticity	Notation	Value
Production elasticities		
Between energy and non-energy input (labor-capital bundle)	e_kl	0.6-1.0
Between labor and capital	l_k	1.0
Between electricity and fossil energy bundle for the aggregated energy	noe_el	0.5
Between fossil energy inputs for the fossil energy bundle	esube	1.0
Between conventional fossil generations	enesta	1.5
Between natural resource and other inputs	esup	0.3-0.5
Consumption elasticities		
Between non-energy and energy-dwelling bundle	delas	0.25
Between non-energy goods	d_elas	0.25-0.69
Between energy and dwelling	dw	0.3
Between energy goods	en	1.5
Between wind power and other aggregated generation	elas_w	1.0-4.0
Between solar power and other aggregated generation	elas_s	1.0-4.0
Trade elasticities		
Between domestic and imported goods	sdm	1.0-3.0
Between imported goods	smm	0.5-5.0

2.3.3. New technologies

The new technologies in EPPA7, also called backstop technologies, are mainly addressed at decarbonizing the power sector. Based on engineering data (see Section 3 for details), we consider

“backstop technologies”— new or alternative technology options not presented explicitly in GTAP 10 — as shown in Table 7. This follows an approach in modeling technical change where “blueprints” of potential technologies are specified. In EPPA7, these potential technologies generally cost more than the conventional technology given the base year prices of inputs, but as input prices change, they may become less expensive. Because of this, so far, most backstop technologies have not run at commercial scales or have not operated at all, but they may become economical in the future pending changes such as higher fossil fuel prices or policy interventions.

Table 10: Advances backstop technologies in EPPA7

Backstop technology	EPPA7 label
Refined oil sector	ROIL
First generation biofuels	Bio-fg
Second generation biofuels	Bio-oil
Oil shale	Synf-oil
Gas sector	GAS
Synthetic gas from coal	Synf-gas
Hydrogen	H ₂
Electricity sector	ELEC
Advanced nuclear	Adv-nucl
IGCC w/ CCS	Ig-gap
NGCC	Ngcc
NGCC w/ CCS	Ngcao
Bio-electricity	Bioelec
Wind power combined with bio-electricity	Windbio
Wind power combined with gas-fired power	Windgas
Transport sector	TRAN
Electric vehicles	<i>Evtrn & evtrn2</i>

2.3.4. Dynamic process

Six particularly critical features of EPPA7 govern the evolution of the economy and its energy-using characteristics over time. These are: (1) the rate of capital accumulation, (2) population and labor force growth, (3) changes in the productivity of labor and energy, (4) structural changes in consumption, (5) fossil fuel resource depletion, and (6) the availability of initially unused “backstop” energy-supply technologies. We discuss each of these features below. The recursive dynamic setting of the model means that production, consumption, savings and investment in each period are determined by prices in that period, with the model solving every 5 years from 2015 onward (Chen et al., 2022)

2.1.1.1.9 The vintage of capital stocks

Dynamics determined endogenously include savings, investment, and fossil fuel resource depletion. As in previous versions of EPPA7, savings and consumption are aggregated in a Leontief approach in the household’s utility function. All savings are used as investment, which meets the demand for capital goods. The capital is divided into a malleable portion KM_t and a vintage non-malleable portion $V_{1,t}$. The dynamics of the malleable capital are described by:

$$KM_t = INV_{t-1} + (1 - \theta)(1 - \delta)^5 KM_{t-1} \quad (5)$$

In Equation (5), θ is the fraction of the malleable capital that becomes non-malleable at the end of period $t - 1$, and INV_{t-1} and δ are the investment and depreciation rate, respectively. The factor of 5 is used because the model is solved in five-year intervals. The newly formed non-malleable capital $V_{1,t}$ comes from a portion of the survived malleable capital from the previous period:

$$V_{1,t} = \theta(1 - \delta)^5 KM_{t-1} \quad (6)$$

EPPA7 considers the cases where part of the vintage capital can survive beyond 20 years, and physical productivity of installed vintage capital does not depreciate until it reaches the final vintage. This reflects an assumption that, once in place, a physical plant can continue to produce the same level of output without further investment. This is combined with the assumption that malleable capital depreciates continuously. Hence a physical plant can be considered to be part vintage and part malleable, with the needed updates and replacement (short of the long-term replacement of a plant) accounted in the depreciation of malleable capital. This process can be described by:

$$V_{2,t+1} = V_{1,t}; V_{3,t+2} = V_{2,t+1}; V_{4,t+3} = V_{3,t+2} + (1 - \delta)^5 V_{4,t+2} \quad (7)$$

In the above setting, $V_{4,t+3}$ comes not only from $V_{3,t+2}$ but also from $(1 - \delta)^5 V_{4,t+2}$, which is the survived vintage capital beyond 20 years old, i.e., $V_{4,t+3}$ represents the sum of vintage capital stocks that are at least 20 years old. With this formulation, the life to capital is extended without the need to create in the model more vintages of capital types. Extra vintages add significantly to model complexity. We retain the formulation that in any given period t , there are always only four classes of vintage capital $V_{1,t}$, $V_{2,t}$, $V_{3,t}$, and $V_{4,t}$ but the effective lifetime of capital is 25 years (the 5-year life of the initial malleable stock, plus the 5-year time-step for each of the four explicit vintages) plus the half life of the final vintage.

Figure 19 demonstrates the dynamics for capital stock evolution presented graphically in (5), (6), and (7). To better illustrate the idea, “model year” and “vintage year” are plotted as the vertical and horizontal axes, respectively, with the former denoting the time period of the model and the latter representing the year when the vintage capital is formed. Therefore, $V_{3,2020}$ for the model year of 2020 was formed in the year 2010. The fact that $V_{4,2025}$ comes from both $V_{3,2020}$ and the survived $V_{4,2020}$ gives an example for the formulation of (7). Vintage capital $V_{n,t}$ is sector-specific, and while factor substitution in response to change in relative price is possible for the malleable portion, it is not possible for the non-malleable portion.

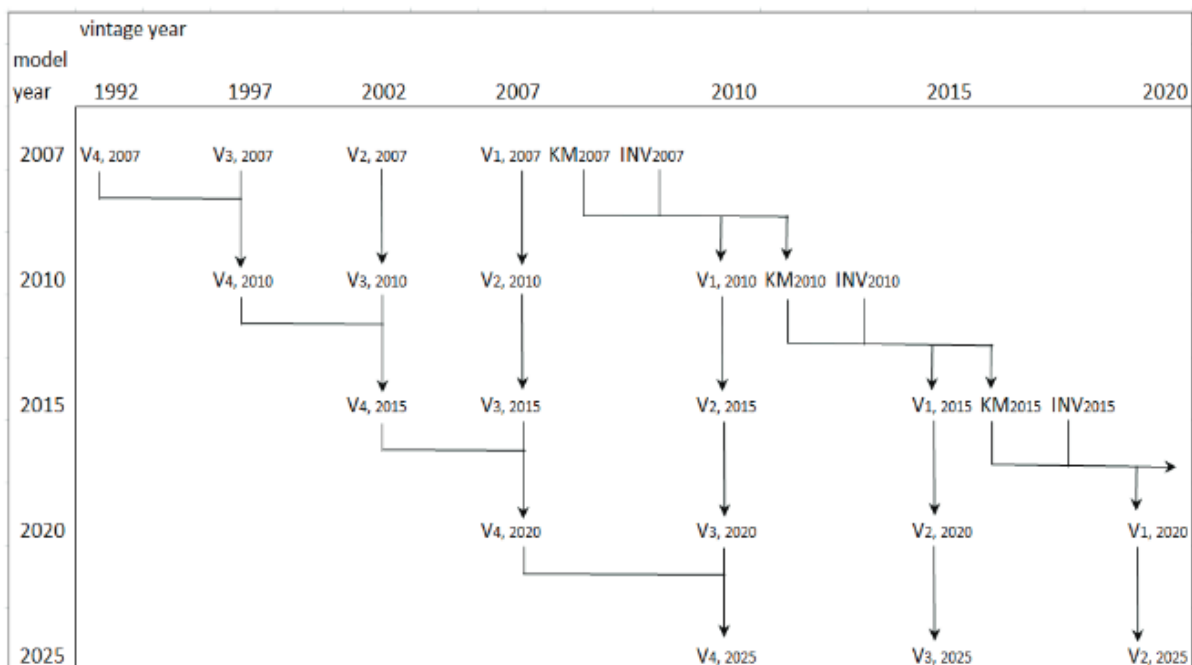

Figure 19: Dynamics for capital stock evolution (Chen et al., 2022)

2.1.1.1.10 Natural Resource Depletion

To capture the long-run dynamics of fossil fuel prices, fossil fuel resources $R_{e,t}$ are subject to depletion based on their annual production levels $F_{e,t}$ at period t . Values of $F_{e,t}$ are then multiplied by a factor of five to approximate depletion in intervening years, to align with the five-year time step:

$$R_{e,t+1} = R_{e,t} - 5F_{e,t} \quad (8)$$

Estimates are provided in Paltsev et al. (2005). The revised outlook for the growing output of shale gas production is included due to the technology breakthrough that makes the extraction of shale resources more economically feasible (Jacoby et al., 2012; Paltsev et al., 2011). Exhaustible resources are depleted over time based on production levels simulated at 5-year intervals in the model and interpolated including years not explicitly simulated.

2.1.1.1.11 Population, productivity, and labor supply

A number of key variables within the EPPA7 model are determined by algebraic relationships among outputs of the model in per capita terms. This requires that the model keep track of the population in each region over the simulation horizon. Regional population in EPPA7 is specified as an exogenous long-run trend based on United Nations data (UN, 2000, 2001). EPPA7 separately tracks changes in labor force size and changes in productivity growth per worker. Labor productivity is modeled as factor-augmenting; thus it makes no difference in terms of the effect on labor supply whether augmentation is due to more workers or more productivity per worker, but distinguishing augmentation due to labor force growth from productivity makes it possible to identify the separate effects of population growth (on labor force) and pure productivity growth. Labor force growth is thus computed based on the population projection and this is combined with labor productivity growth to compute the labor augmentation factor. Specifically, for region r and time t the supply of labor is scaled from its base-year value $L_-(r, 0)$ by an augmentation parameter whose rate of growth, $g_{r,t}$, represents the combined effect of increased labor input in natural units and chained rates of increase of labor productivity:

$$L_{r,t+1} = L_{r,0}(1 + g_{r,t})^t \quad (9)$$

The augmentation rate, $g_{r,t}$, is now composed of the $g_{r,t}^L$, the growth of labor force, and $g_{r,t}^p$, the growth of productivity. The productivity component requires an exogenous initial rate at $t = 0$ and a terminal rate at $t = T$, with rates for intervening periods determined by a logistic function:

$$g_{r,t}^p = (g_{r,t}^p - g_{r,t}^p) \frac{1 + \alpha}{1 + \alpha\beta t} + g_{r,t} \quad (10)$$

2.1.1.1.12 The values of the logistic parameters α and β are set at 0.1 and 0.07, respectively. This representation means productivity augmentation adjusts from the initial rate to the final rate in an S-shaped fashion. This growth for the first two periods (1997-2000, and 2000-2005) is overridden by specifying an augmentation factor so that simulated GDP growth matches the historical rate over these periods based on data from the International of Monetary Fund.

2.1.1.1.13 Autonomous Energy Efficiency Increases (AEEI)

One of the stylized facts of economic development is that countries tend to use first more energy, then less energy per unit of GDP as their economies expand from very low to high levels of activity (Schmalensee et al., 1998). In simulations used to analyze energy or climate policy it is customary to model these dynamics by means of exogenous time trends in the input coefficients for energy or fossil fuels. Such trends are employed in the EPPA7 model to control the evolution of demand reduction factors that scale production sectors' use of energy per unit of output. The rate of growth of these factors is called the autonomous energy efficiency improvement (AEEI), which is a reduced-form parameterization of the evolution of non-price-induced, technologically driven changes in energy

demand. Rates of increase are the same across developed regions and for China, whose gradual emergence from non-market production systems has seen rising efficiency of resource allocation and a very rapid fall in the use of energy per unit output. This pattern is different for other developing countries that have shown little reduction in energy intensity or even increases. To follow the historic pattern for developing economies, we assume a gradual decrease in AEEI over the next few decades and energy efficiency improvement later in the century. The actual path of energy use per unit output that results from the model simulation depends on energy prices and other structural changes. The resulting energy intensity of GDP for a reference case is discussed in Section 8.1. As discussed in Section 3.2, energy is not an explicit input in the COAL, OIL, and GAS sectors. We assume no AEEI trend in ROIL. In the ELEC sector we assume a rate of AEEI improvement that leads to an efficiency of conversion of fuels to electricity that approaches 0.5 in the reference.

In EPPA7, we include a 1% per year AEEI improvement for all other sectors except for the power sector.¹³ We assume a 0.3% per year AEEI improvement for the power sector as for the previous EPPA7, which leads to an efficiency of fuel-to-electricity conversion that approaches 0.5 by the end of the century. Energy use levels also determine the remaining fossil fuel reserves. Estimates for oil, gas, and coal resources are from previous versions of EPPA7. Details are provided in Paltsev et al. (2005). We incorporate the revised outlook for the growing output of shale gas production due to the technology breakthrough that makes the extraction of shale resources more economically feasible (EIA, 2013; Jacoby et al., 2012; Paltsev et al., 2011).

2.1.1.1.14 Penetration of new technologies

The MCP formulation presented in Section 2 allows no output from a backstop technology if it is not economic to operate. To model the penetration of a backstop technology, previous versions of EPPA7 have adopted a “technology-specific factor” that is required to operate the backstop technology but may only be available in limited supply — especially when the technology is in an early stage of introduction. The resource rent of the technology-specific factor goes to the representative household, which is the owner of that factor. Parameterizing the supply of a technology-specific factor for backstop technologies is challenging, as very often such technologies have not yet entered the market. Recent work by Morris et al. (2019b) provides a theoretical framework to improve the representation of backstop penetration. Morris et al. sought a theoretically-based formulation that captures key observations of technology penetration (*e.g.* gradual penetration, falling costs) that could be parameterized based on observations.

In short, Morris et al. argue that when demand for the output of the backstop technology increases over time, the investment for operating the backstop technology goes up, and so does the technology-specific factor supply, which may eventually become a nonbinding input for the operation of the backstop technology. The study parameterizes the technology-specific factor supply by the analogue of nuclear power expansion in the U.S. from its introduction in the late 1960s to the mid-1980s. More specifically, Morris et al. argue that during that period, when nuclear power was expanding, it was regarded as the next-generation technology poised to take over most of the base load generation; therefore, the experience of nuclear power expansion may provide a good approximation for representing the expansions of other new technologies. Thus, to model the penetrations of backstop technologies in EPPA7, the settings and empirical findings of Morris et al. are incorporated into the model:

$$bbres_{bt,t+1} = \alpha \cdot [bout_{bt,t} - (1 - \delta)^5 \cdot bout_{bt,t-1}] + \beta \cdot [bout_{bt,t}^2 - (1 - \delta)^5 \cdot bout_{bt,t-1}^2] + bbres_{bt,t} \cdot (1 - \delta)^5 \quad (11)$$

In Equation (11), $bbres_{bt,t}$ is the technology-specific factor supply for technology bt in period t , and $bout_{bt,t}$ is the output of bt in period t . The estimates from Morris et al. are $\alpha = 0.9625$ and $\beta = 1.3129 \cdot 10^{-7}$. Morris et al. also specify a value of 0.3 for the benchmark substitution elasticity between the technology-specific factor and other inputs.

In brief, the EPPA7 model is a multisectoral dynamic CGE model used to assess energy, economic, and climate scenarios and their respective impacts. It is classified as a top-down energy model.

3. Methodological and structural comparison of EPPA7 and TIAM-FR

In order to both summarize and compare EPPA7 and TIAM-FR, we propose the following Table 11. Above all, the two models are fundamentally different, in terms of modelling paradigm. On the one hand, TIAM-FR minimizes the total annual discounted cost of operating the energy system, by choosing the most cost-effective technologies to invest in. This approach is also called “bottom-up” as the investment decisions in technologies (bottom) make the energy system (up). On the other hand, the EPPA7 model maximizes the welfare of all the actors in the economy (up) – not only the energy sector (down), in a top-down approach. Although they propose different approaches, they both seek to optimize the global energy system. The bottom-up approach really focuses on the technical feasibility of optimizing the energy system but does not assume feedbacks from the consumer sector, as no price elasticities or primary factors are considered – although they could be. Besides, in any decarbonization scenario requiring massive investments in new technologies, the paradigm shift can only impact the cost of capital (Assoumou et al., 2018). Bottom-up models like TIAM-FR draw their strength from their technology-rich description, enabling the study of sector coupling (Prina et al., 2020) as well as the impact and market penetration of new technologies (Subramanian et al., 2018). Conversely, top-down models generally show poor technology description as they are built by economists to assess the evolution of the global economy based on microeconomic theories, and under environmental constraints. Therefore, TD models are particularly good at describing the reactions between the economy and energy. Nonetheless, the EPPA7 model shows a rather advanced technical description of the electricity sector (Morris et al., 2019a, 2019b), and Chapter 3 explains how we have further enriched it.

The spatial representation of both models is quite similar, which allows a fair comparison of the results of the two models regarding trade and regional analysis. Indeed, we count 8 identical prominent regions responsible for the majority of both GHG emissions and energy production, and similar trading of energy commodities between them is considered.

However, the temporal dimension opposes the two models, with TIAM-FR projecting the future using perfect foresight and EPPA7 being myopic. The perfect foresight property means that the model solves over the entire horizon – as it knows all the necessary information in the future; but EPPA7 as a myopic model solves by iterating the optimization problem every 5 years. The clairvoyance of models conflicts with the reality of decision-making; while our policymakers make decisions with little information on the short term, and imperfect information at that, the models know everything about the distant horizon. There is therefore a gap in the decision-making process, whereby the models prefer to invest earlier than the decision-makers. In that sense, although myopic models provide less detailed information on the temporality of decisions, their behavior is closer to reality (Keppo and Strubegger, 2010) as they move to an implementation phase of long-term targets. Fuso Nerini et al. have compared the two approaches and concluded that: (1) myopic models tend to postpone strategic investment decisions as their decisions are fixed by interval (here 5 years for EPPA7); (2) the carbon prices estimated by perfect foresight models tend to be underestimated; and (3) both types can be used in tandem with the perfect foresight model to provide the least-cost technical pathway to achieve the environmental target, with the myopic model providing information on how those goals can be achieved in an implementation phase (Fuso Nerini et al., 2017).

An additional discrepancy between the two models lies in their representation of land use and land-use change. Both models quantify the land used to produce first-generation or second-generation biomass. However, TIAM-FR is incapable of considering the CO₂ emissions due to land use or land-use change

endogenously, contrary to EPPA7. In the former, only the CO₂ emissions due to deforestation and forest degradation are considered, whatever the climate scenario under discussion. Consequently, higher amounts of CO₂ emissions are considered in EPPA7, which renders the decarbonization problem more difficult with this model. In addition, caution should be taken when bioenergy is used in large amounts in the solution of TIAM-FR. Kang et al. defined different scenarios regarding the availability of land to produce bioenergy, including a “low” for which the problem of land-use CO₂ accounting is less important (Kang, 2017).

Finally, the two models show minor differences in the consideration of climate and how it is impacted by the energy sector. The three main GHG are considered endogenously in both models. The remaining emissions responsible for 2% of the greenhouse effect concerning iron sulfur and fluorinated gases (Ritchie et al., 2020) are considered exogenously in TIAM-FR and endogenously in EPPA7. As mentioned above, CO₂ emissions from land use are not taken into consideration in TIAM-FR. The impact of GHG emissions is accounted for by TIAM-FR in terms of temperature elevation thanks to the climate module. The EPPA7 model mainly addresses the impact of GHG emissions on the economy but, when coupled with the MIT Integrated Global Systems Model (IGSM), EPPA7 is capable of considering the effects of pollution on human health in addition to climate indicators such as temperature, water cycles, etc. (Sokolov, 2005).

Table 11: Comparison table of TIAM-FR and EPPA7

Light blue characters refer to exogenous data/values

**The acronyms in parentheses are those used in TIAM-FR and EPPA7, respectively to the left and right of the slash. If no slash, the same acronym is used in both models*

Feature	Details	TIAM-FR	EPPA7
Owner		Mines Paris – Centre for Applied Mathematics	MIT Joint Program on the Science and Policy of Global Change
Model scope and methods	Solution concept	Partial equilibrium with fixed demands	Computable General Equilibrium (CGE)
	Solution horizon	Perfect foresight	Recursive dynamic (myopic)
	Solution method	Linear optimization	Mixed integer problem
	Optimization problem	Cost minimization of the energy system	Maximization of welfare
	Solver	CPLEX	PATH
Spatial dimension	Number of regions	15	18
	Identical regions*	United States (USA), Canada (CAN), Mexico (MEX), China (CHI/CHN), Japan (JPN), India (IND), Australia and New Zealand (AUS/ANZ), Africa (AFR)	
	Other regions*	Latin and Central America (CSA), Former Soviet Union (FSU), Western Europe (WEU), Eastern Europe (EEU), Other Developing countries of Asia (ODA), South Korea (SKO), and Middle East (MEA).	Russia (RUS), Other Latin America (LAM), Brazil (BRA), Europe (EUR), Other Eurasia (ROE), Middle East (MES), Korea (KOR), Dynamic Asia (ASI), Indonesia (IDZ), and Other East Asia (REA).
Temporal dimension	Base year	2018	2014

	Time-step	10 years	5 years
	Horizon	2100	2100
	Time slices	12 (4 seasons, with days divided into 3 periods)	N/A
Time discounting type		5%	Endogenous
Emissions and climate	CO ₂	Fossil CO ₂ , process CO ₂ , land-use change	Fossil CO ₂ , Process CO ₂ , land use and land-use change
	CH ₄	Fossil combustion, land use, industry	Fossil combustion, land use, industry
	N ₂ O	Fossil combustion, land use, industry	Fossil combustion, land use, industry
	Other GHG	CFC, HFC, SF₆, PFC	CFC, HFC, SF ₆ , PFC
	Concentrations	CO ₂ , CH ₄ , N ₂ O	CO ₂ , CH ₄ , N ₂ O, and other GHG
	Radiative forcing	Yes	Yes
	Temperature change	Yes	No
	Climate change impact	None	Agriculture and GDP
Socio-economic drivers	Population	Population, GDP, household, elasticity of demands to their own drivers	Population, GDP, labor productivity, factor productivity, AEII
Energy	Electricity	Coal w/wo CCS, Gas w/wo CCS, bioenergy w/wo CCS, geothermal power, nuclear power, solar PV (centralized & distributed), solar CSP, wind onshore, wind offshore, hydroelectricity, ocean power	Coal w/wo CCS, gas w/wo CCS, bioenergy w/wo CCS, geothermal power, nuclear power, solar power, wind power, hydroelectricity
	Hydrogen	Coal gasification w/wo CCS, gas reforming w/wo CCS, biomass gasification w/wo CCS, electrolysis (centralized and distributed)	<i>Not within scope</i>
	Refined liquids	Coal-to-liquids w/wo CCS, biomass-to-liquids w/wo CCS, oil refining,	Coal-to-liquids w/o CCS, gas-to-liquids w/o CCS, oil refining
	Refined gases	Biomass-to-gas wo CCS	Coal-to-gas
	Heat generation	Coal, natural gas, oil, biomass, geothermal, CSP, CHP	<i>Not within scope</i>
Energy end-use technologies	Passenger transport	Passenger trains, buses (electric, hybrid, conv.), LDV, EV, H ₂ LDV, hybrid LDV, aircraft	Conventional LDVs, electrical LDVs
	Freight transport	Freight trains, heavy-duty vehicles (electric, H ₂ , hybrid, gas), freight ships,	Water transport, air transport

	Industry	Cement and non-metallic, Iron and steel, non-ferrous, chemicals, pulp and paper, other	<i>Aggregated</i>
	Residential and commercial	Space heating and space cooling (inc. heat pumps), cooking, refrigeration, washing, lighting, water heating, clothes drying, other electrical uses, other non-electrical uses	<i>Not within scope</i>
	Technology learning	<i>Exogenous assumptions</i>	Endogenous
Land-use	Land cover	Energy crops	Cropland, energy crops, forest (managed and natural), pasture
	Agriculture and forestry demand	Aggregated exogenous demand	Food, livestock, bioenergy, agricultural residues
	Agricultural commodities	Wheat, rice, oilseeds, sugar crops, wood, logging residues	N/A
Trades		Hard coal, brown coal, natural gas (pipeline), LNG, crude oil, oil distillates, gasoline, heavy fuel, agricultural commodities, hydrogen	Oil, coal, gas, electricity, emissions permits, capital
MAIN outputs		Set of investments in all technologies, operating levels of all technologies, imports and exports of each type of tradeable commodity (including permits), extraction level of primary energy, emissions level of CO ₂ , CH ₄ and N ₂ O by each technology, the change of concentration in the GHG, the change in global temperature induced by the radiative forcing	GDP, consumption, CO ₂ , CH ₄ , N ₂ O and other GHG emissions, operating level of each agent, producer and consumer prices including permits), primary energy use, technology-specific power generation

Therefore, TIAM-FR is more suitable to study the deployment of cost-optimal technologies interacting with various sectors of the energy system, while EPPA7 is appropriate to study the evolution of the global economy subject to a climate constraint, in which technology is only a part of the solution. Their difference is reflected in the results they generate.

4. Towards a fusion?

BU models have been recognized to underestimate the value of the carbon tax resulting from their exercise (Assoumou et al., 2018; van Vuuren et al., 2009) stemming from the relatively low cost estimation of achieving an environmental constraint (Algehed et al., 2009; J. C. Hourcade et al., 2006), while TD models produce lower energy demands with less details on the functioning of the energy system (Assoumou et al., 2018; Krook-Riekkola, 2017) but assess policy implementation better. Hence, BU and TD models propose different guidance for policy-makers (Helgesen, 2013). Fortes et al. argue that “*in BU models, optimizing the cost of the scenarios with the best environmental quality index may have the worst economic and social sustainability indexes*” (Fortes, 2017) and we can complement this assertion by claiming that in TD models, the resulting technical solution may be difficult to achieve, or

suboptimal. Therefore, BU models and TD models are complementary which has encouraged some modelers to link these two types in a hybrid fashion.

The ideal model is somewhere at the crossroads of the technology explicitness of BU models, and the macro-economic completeness and microeconomic realism of TD models. Thus, there is a need for both policymakers and modelers to strike an ideal approach that can deliver the three types of information. The question of coupling models was first discussed by Wene et al. (Wene, 1996). To take up this challenge, they expressed two ways and methodologies of bridging the gap between BU and TD: soft-linking and hard-linking. It has been argued that designing a model from scratch integrating both BU and TD approaches would be too complex and difficult to control, and would make the interpretation of results even harder (Schäfer and Jacoby, 2005). Instead of a complete integration of the two approaches, linking the models appears to be a more consistent method. It involves identifying and connecting similar commodities in both models to make them interact through iterations with feedback of information.

Soft linking is referred to as the complete control of modelers on BU and TD models. Modelers assess the consistent information that should be exchanged between BU and TD to make the models converge. The transfer of information is manual and designed into a procedure that takes the form of an algorithm. Consequently, due to practical reasons, a high amount of information cannot be exchanged. Thus, soft linking is a practical, transparent way of linking. However, it could lead to major differences in terms of results output (Wene, 1996). This methodology requires exact identification of model overlaps, occurring at the regional level description, the production side and the demand side. Hard linking consists in automatically managing and formalizing the transfer of information within a program, allowing both a greater amount of information exchanged and more iterations. The program is built such as the two models form one, as they do not run independently.

Assoumou et al. (2018) have argued that modelers can benefit from coupling economic and technology models, but the final model might not converge due to high technical and mathematical challenges. These concerns were also expressed by Hourcade et al. (2006), who pointed out that “the development of these models faces several challenges related to theoretical consistency, computational complexity, empirical validity and policy relevance”.

Given the complexity of linking the two models and because the results may be difficult to analyze, we choose to run the models separately and interpret the results independently, being aware of their structural and philosophical differences.

5. Conclusion

This chapter has presented, detailed, and compared the two tools at work in this thesis. It highlights the fundamental differences but also their points of convergence. First, they do not operate on the basis of a common paradigm, as EPPA7 is categorized as a top-down model and TIAM-FR a bottom-up model. Therefore, EPPA7 is more focused on the economy and the interactions with the energy sector. EPPA7 operates at a more aggregated level of the world economy, since TIAM-FR only represents the energy sector. Despite their structural differences, they both deliver insights into what the energy and climate transition could look like, in terms of technology deployment and GHG emissions. Thus, EPPA7 is much more difficult to handle, with a lot of economic theories behind its code. Their respective strengths and weaknesses are reported in the following table.

Model	Main strengths	Main weaknesses
TIAM-FR	<ul style="list-style-type: none"> - The technology-rich framework enables the identification of key technologies for the future - Interactions between technologies and between sectors can be tracked 	<ul style="list-style-type: none"> - No feedback from the consumer side: the energy demands remain constant no matter the energy cost

	- Time-slices enable to address the problem of intermittency	- Strong assumptions must be made regarding the cost evolution of technologies - The analysis omits other sectors of the economy outside energy
EPPA7	- Consideration of economic behavior of micro-economic principles - Demands reflect consumers' choices - Technologies expand based on their deployment rate	- Few technologies are considered and lack of sector coupling - Difficult to analyze

We have shown that linking EPPA7 and TIAM-FR was not necessarily useful or easy, although past studies have highlighted the interest of coupling them. Taking stock of these strengths and weaknesses, we aim to confront the results related to CCU and CCS, for the following two reasons:

- While they can deliver antagonistic results (e.g., regarding the deployment of CCU and CCS), these can be explained by their different assumptions, underlying theories, or framework.
- However, conclusions may be drawn and supported by similar results in both models.

The analysis of their results under a common climate constraint is presented in Chapter 4. The following chapter explains how, starting from these two models, CCS and CCU were incorporated as new opportunities to address the climate constraint.

Chapter 3 – Implementation of CCU and CCS in bottom-up and top-down global energy models

The modeling of CCU and CCS is central to this doctoral thesis. The main improvements and new implementations were achieved under TIAM-FR and EPPA. In addition to modeling CO₂ capture, CO₂ storage, and CO₂ utilization, other processes that either compete with or facilitate the deployment of CCS and CCU were also modeled, such as hydrogen. Indeed, hydrogen can both enhance and compete with CCUS as it can substitute CCS options, notably in the industry sector, but it is also an essential co-reactant in most CO₂ utilization processes. Thus, modeling efforts have been engaged to better understand the place of CCU and CCS among the other decarbonization options.

The modeling work includes the power sector which is essential to decarbonize; the hydrogen sector working in tandem with CO₂-to-fuels processes; biorefineries equipped with carbon capture that produce biofuels competing with synthetic fuels; the industry sector, inevitably relying on carbon capture for its decarbonization; Direct air capture (DAC) capable of generating negative emissions that can offset hard-to-abate emissions in other sectors; CO₂ utilization pathways including fuels and minerals; and the transport and storage of CO₂, as the final link of the CCS chain. Other modeling works are related to the implementation of Shared Socioeconomic Pathways (SSP), recognized by the modeling community as plausible pathways toward global energy system decarbonization, involving geopolitics. Sections 3 and 9, which are respectively about hydrogen modeling and SSP integration, feature studies carried out for and with the ETSAP group that were used to improve TIAM-FR. Sections 6 and 7.3, which are respectively about the modeling of DAC and CO₂ utilization, were joint research carried out with MIT and Mines Paris – PSL that served for both models. The rest of the modeling works concern TIAM-FR development only.

The following chapter aims to detail the references and assumptions, and how each modeling development was carried out. We emphasize that all new implementations, improvements, and updates were made in such a way that any researcher can handle the new version of the models (whether TIAM-FR or EPPA), i.e., we strived to make the modeling transparent within the code.

La modélisation du CCS et du CCU est développée dans les modèles TIAM-FR et EPPA. En plus de modéliser la capture, le stockage du CO₂ et l'utilisation du CO₂, d'autres processus en concurrence avec ou facilitant le déploiement du CCS et du CCU ont également été modélisés, tels que l'hydrogène. En effet, l'hydrogène peut à la fois renforcer et concurrencer le CCUS, car il peut substituer aux options de CCS, notamment dans le secteur industriel, mais il est également un co-réactif essentiel dans la plupart des processus d'utilisation du CO₂. Ainsi, des efforts de modélisation ont été déployés pour mieux comprendre la place du CCS et du CCU parmi les autres options de décarbonisation.

Le travail de modélisation comprend le secteur de l'énergie, essentiel pour décarboniser ; le secteur de l'hydrogène travaillant en tandem avec les processus de conversion de CO₂ en carburants ; les bioraffineries équipées de capture de carbone produisant des biocarburants en concurrence avec les carburants synthétiques ; le secteur industriel, inévitablement dépendant de la capture de carbone pour sa décarbonation ; la capture directe de l'air (DAC) capable de générer des émissions négatives pouvant compenser les émissions difficiles à éliminer dans d'autres secteurs ; les voies d'utilisation du CO₂, y compris les carburants et les minéraux ; et le transport et le stockage du CO₂, comme dernier maillon de la chaîne de la CCS. D'autres travaux de modélisation sont liés à la mise en œuvre des Shared socio-economic pathways (SSP), reconnues par la communauté de modélisation comme des trajectoires plausibles vers la décarbonisation du système énergétique mondial, impliquant la géopolitique. Les sections 3 et 9, respectivement sur la modélisation de l'hydrogène et l'intégration des SSP, présentent des études réalisées pour et avec le groupe ETSAP qui ont été utilisées pour améliorer TIAM-FR. Les sections 6 et 7.3, respectivement sur la modélisation de la DAC et de l'utilisation du CO₂, étaient des recherches conjointes menées avec le MIT et Mines Paris – PSL et ont servi pour les

deux modèles. Le reste des travaux de modélisation concerne uniquement le développement de TIAM-FR.

Ce chapitre vise à détailler les références et les hypothèses, ainsi que la manière dont chaque développement de modélisation a été réalisé. Nous insistons sur le fait que toutes les nouvelles mises en œuvre, améliorations et mises à jour ont été réalisées de manière à ce que n'importe quel chercheur puisse manipuler la nouvelle version des modèles (que ce soit TIAM-FR ou EPPA), c'est-à-dire que nous avons cherché à rendre la modélisation transparente.

1. CO₂ accounting

As the environmental impact of CCS and CCU is very dependent on the nature of the carbon – fossil or climate-neutral – the modeling we have developed ensures transparent accounting of CO₂ emissions in which each sector is responsible only for its direct emissions, illustrated in Figure 20.

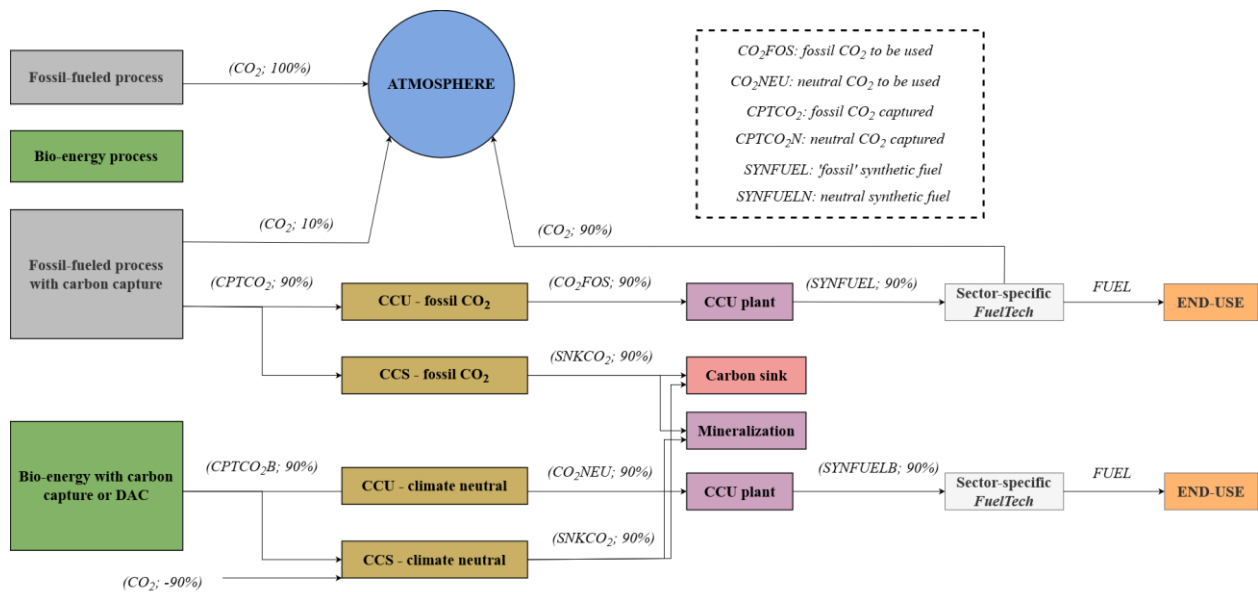

Figure 20: Accounting of CO₂ fluxes in TIAM-FR

The left side of the brackets represents the type of CO₂ and the right side is the share of CO₂ captured (resp. emitted) from (resp. by) the initial hydrocarbon

Whatever fossil resource a process is fueled by, 100% of the carbon that resource contains will be emitted into the atmosphere in the form of CO₂. When the same process, fueled by whatever fossil resource, is equipped with a carbon capture unit, 10% of the carbon will be released into the atmosphere because of the imperfect capture efficiency (90%), but 90% of the CO₂ captured (CPTCO₂) will be sent to dummy processes (represented in yellow in Figure 2), so the solver chooses whether this CO₂ is used or stored. These sector-specific dummy processes are practical as they enable the bulk of captured CO₂ to be aggregated into two commodities for storage (SNKCO₂) or utilization (CO₂FOS). On the one hand, the CCUFOS commodity is converted by the CCU plant into a fuel (SYNFUEL) containing fossil carbon (by 90% of the initial amount) and processed by a sector-specific *FuelTech* before being consumed in the end-use process. In TIMES modeling, so-called *FuelTechs* are the abbreviation of *Fuel Technologies* and are commonly used to avoid duplicating end-use processes according to the type of fuel they consume. For example, the model features a *FuelTech* entitled FT_TRAMET (Figure 21) that processes all kinds of methanol commodities to generate a single methanol commodity (TRAMET) for end-use processes in the transport sector (TRA), namely trucks, light vehicles, etc. At this level of the reference energy system (RES), the CO₂ is reemitted and allocated to the sector in charge of its emission, according to the emissions factor of the fuel.

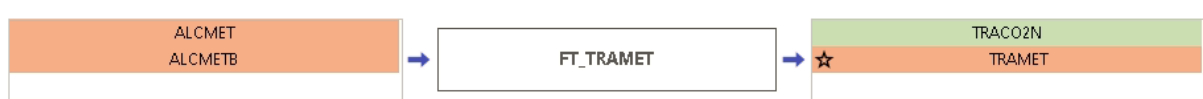

Figure 21: Example of a FuelTech for the transport sector and the methanol commodity
The two ALCMET and ALCMETB commodities both refer to methanol but were not generated from the same process, enabling their tracking.

This way, the 90% CO₂ that has been avoided by the capture unit is finally released into the atmosphere at the level of the *FuelTech*. On the other hand, the CO₂ to be stored (SNKCO₂) can be sent to an onshore (SINKON), offshore (SINKOFF), or mineralized (CCUS) storage process, depending on the regional storage capacity and costs. Thus, the 90% CO₂ that was avoided at the capture unit is sealed.

In the case where the carbon captured is climate neutral, i.e., either atmospheric or biogenic, the CO₂ emissions are accounted for slightly differently. When a process is fueled by bioenergy, the emissions are accounted for as zero, although indirect GHG emissions due to land use change or biomass harvesting are – or can be – attributed to an upstream sector. When a process is fueled by biomass and equipped with a carbon capture unit, there are still no direct emissions. However, 90% of the CO₂ flue gas is captured (CPTCO₂B) and likewise sent to dummy processes. If the CO₂ is used, it is aggregated into a single commodity (CO₂NEU) representing a flux of CO₂ that is not harmful to the environment due to its origin. This CO₂ commodity can be used by any CCU plant, but it will produce a fuel (SYNFUELB) that generates no CO₂ emissions when it is processed by the *FuelTech*. Thus, the CO₂ that has been captured and utilized has no direct impact on the environment. However, if the climate-neutral CO₂ captured is to be stored, then the negative emissions are accounted for by the dummy processes: for every ton of CO₂ captured from a given sector, the same amount of CO₂ is deducted from the emissions of this sector.

Thus, this modeling ensures that any CO₂ emissions or CO₂ reductions are accounted for under the right sector relative to their scope 1⁷.

This work was carried out in close cooperation with Dr. Carlos Andrade, Research Engineer at IFP Energies Nouvelles, during his post-doctoral research on the role of Negative Emissions Technologies (NET) for long-term decarbonization of the industry sector.

2. The power sector

The power sector is at the heart of the energy transition because numerous low-carbon power technologies are available, including CCS options, and numerous opportunities exist to electrify end-use processes, *e.g.*, heat pumps, electric cars, stoves, *etc.* Electricity is also essential to decarbonize intermediate processes such as electrolyzers, and most importantly here, CO₂ conversion technologies. Furthermore, the electricity used to manufacture hydrogen and synthetic fuels will also compete with these low-carbon fuels, especially in the transport sector. Therefore, power sector modeling needs to be addressed carefully as it interacts with CCS and CCU technologies.

When we first handled TIAM-FR, we needed to update the power sector to include more recent data than in 2011. Firstly, we reviewed the economics of wind and solar based on the 2019 World Energy Outlook (IEA, 2019c). This publication includes the capital costs, the fixed operational costs, and the availability factors of the plants, all specified for each region of the model.

⁷ Scope 1 emissions are direct emissions from sources that are owned by an organization, such as emissions from burning fossil fuels to run a business. Scope 2 emissions are indirect emissions from the generation of purchased electricity, heat, or steam. Scope 3 emissions are all other indirect emissions that occur in the value chain of the organization, such as the extraction and production of purchased materials and fuels, transportation and distribution of purchased electricity and steam, and the disposal or treatment of waste.

Concerning fossil-fueled power plants with and without CO₂ capture, we used the reports by the Global CCS Institute (GCCSI) (Irlam, 2017) and the IEAGHG (IEAGHG, 2017), providing techno-economic information at a high level of detail, and for different types of technologies. The former provides technical details on coal-power plants with carbon capture, while the latter is more focused on natural gas combined cycles (NGCC) with CO₂ capture. For instance, coal-fired plants in the GCCSI report include four types of technology (pulverized coal (PC), ultra-supercritical PC (USC PC), and integrated gasification combined cycles) with different types of CO₂ capture technologies (post-combustion, oxy-combustion, and pre-combustion), plus two different oxy-combustion technologies including the ITM technology (Mancini and Mitsos, 2011). In the same report, for natural gas-fired plants, the author considered only one type (NGCC) and one capture technology. However, the report by IEAGHG considers two processes (NGCC with and without flue gas recycling (FGR), and two capture rates at 90% and 98.5%. Likewise, USC PC power plants are studied with the same capture rates, but no energy efficiency cases are considered.

The bottom line of the GCCSI report is that NGCC plants are the cheapest, while IGCC plants are the most expensive. Respectively, implementing carbon capture and storage increases the levelized cost of electricity (LCOE) by 57% and 45%, but these two technologies are expected to undergo the largest cost reduction in the future. The author was able to identify the countries where CCS in the power sector is cheapest due to lower fuel costs, lower labor costs, and lower equipment costs, especially in North America and China. On the contrary, Germany and Poland are some of the most expensive locations to build a coal-fired power plant with CCS, due to higher fuel and labor costs.

The IEAGHG reports the same findings regarding the competitiveness of NGCC compared to PC plants. The results on LCOE are in line with the GCCSI report, as they estimate an increase of 43% for NGCC and 80% for USC PC (GCCSI estimate is 70%). More significantly, they highlight two points:

- Increasing the CO₂ capture rate from 90% to 98.5% increases both the LCOE and the CAC⁸ for NGCC, while it can only improve the CAC of USC PC by 4.3%.
- Designing the plants with FGR is found to be effective, decreasing the LCOE by 2-3% and the CAC by 8-12%.

Considering these two reports enables us to cross-check the references and enrich the model with different capture technologies and power generation processes. We can then identify, according to the model's optimization process, what types of power plant (with CO₂ capture) are optimal in the energy transition, considering regional availability and the cost of fuel, labor, and capital. Construction duration was taken from (Morris et al., 2019a). The techno-economic assumptions for each process are given in Appendix 1.

The previous paragraphs only address the techno-economic behavior of *brand-new* power plants with CCS. However, we also implemented retrofitting options into the model for existing coal and natural gas-fired plants. As mentioned in Chapter 2, the existing capacities associated with their efficiencies and availability factors are detailed regionally with respect to data from the World Energy Balance 2019 (IEA, 2021c). Considering the composition of the power sector for the base-year, we implemented the retrofitting options, whose costs are very likely to be higher than an equivalent new plant installation for several reasons (IPCC, 2005):

- The age, small size, and lower efficiencies of existing plants increase energy penalties when CO₂ capture units are installed.
- The design of the existing plant does not allow for an optimal heat recovery for sorbent regeneration.

⁸ Cost of avoided CO₂ refers to the cost of mitigating CO₂ when comparing the levelized cost and the CO₂ emissions intensity of a unit with and without CO₂ capture.

- Existing plants may not be equipped with desulphurization and NO₂ control which complexifies the installation of the capture unit.
- Other contextual parameters such as land availability make it even more difficult, and costlier.

For the above reasons, we did not use the data from the IEAGHG and the GCCSI reports to implement retrofitting of existing power plants. Instead, we used the data from the IPCC special report on carbon dioxide capture and storage (IPCC, 2005).

An additional important feature to characterize the costs of carbon capture – in general, not only for the power sector – is to assume a cost decrease as research develops more efficient processes and new capacities are built (technology learning). As we do not consider endogenous technology learning in TIAM-FR, we need to specify exogenous CAPEX decreases and efficiency increases in the future, taken from (Budinis et al., 2018)⁹. These values are available in Appendix 1.

Furthermore, we updated processes related to bioenergy with CO₂ capture (BECC) and co-firing processes with CO₂ capture (CFCC). Originally, the model was equipped with 32 co-firing processes described in (Kang, 2017; Selosse, 2019) corresponding to different co-firing options (co-milling, separate feeding, parallel combustion) and different levels of co-firing (maximum 5%, 10% or 40% of biomass). In addition, four bioenergy processes were implemented: pellet gasification or direct combustion, and torrefied pellets gasification or direct combustion. For these processes, we assume that CO₂ capture can be implemented to convert it into a BECC plant, eventually generating negative emissions if the CO₂ captured is then stored. As Morris et al. (2019) did for their estimation of BECC costs (Morris et al., 2019a), we applied a scalar representing the difference in cost between plants with and without CO₂ capture in the GCCSI report. For the bioenergy gasification plants, we applied the scalar between IGCC and IGCC with CO₂ capture, and for bioenergy direct combustion plants, we applied the scalar between PC and PC with CO₂ capture. The scalars are different depending on whether they refer to the CAPEX, or the fixed and variable OPEX. We took the same approach to consider the energy penalty of carbon capture. Likewise, the same methodology was applied to the 32 co-firing processes. The techno-economic assumptions for each process are given in Appendix 1.

Finally, we specified region-specific costs for carbon capture technologies in the power sector, based on the findings of (Ferrari et al., 2019). These authors studied how the climate and economics of specific regions of the world leverage the LCOE, by considering representative sites, which we had to associate with the regions defined in the model, as shown in the following table – with some rough approximation:

Table 12: Corresponding tables for the region of (Ferrari et al., 2019) and TIAM-FR

Location studied in Ferrari et al. (2019)	TIAM-FR region
Eastern Europe (Poland)	EEU, FSU
Western Europe (the Netherlands)	WEU
United States (Wisconsin and Wyoming)	USA
Canada	CAN
South Africa	AFR
Australia	AUS
India	IND
China	CHI
Japan	JPN, SKO
South-East Asia	ODA
South America (Brazil and Chile)	CSA, MEX
Middle East	MEA

⁹ See Table 14 in the research article. We took the average cost decrease relative to plants without CCS.

For these locations, the authors collected the climate conditions such as ambient air temperature, pressure, humidity, and sea water temperature, and they highlight that these influence the condensing temperature. The lower these values are, the more efficient the capture process is. But other parameters, such as the quality of coal, and the cost of capital and labor, also play a major role. Their conclusions highlight that the LCOE of PC plants may vary by 40%, and 57% for NGCC, and PC remains advantageous compared to NGCC only in China and Indonesia, where economic conditions are favorable. The best locations are in the USA, India and China. Similar conclusions are drawn in (Irlam, 2017).

Given the modelling framework explained in Section 1, we implemented into TIAM-FR 8 processes for coal-fired plants and 7 processes for natural gas-fired plants, and we updated the 32 co-firing processes and the four bioenergy processes – all with CO₂ capture. Figure 22 below shows the inputs and outputs of power plants with carbon capture.

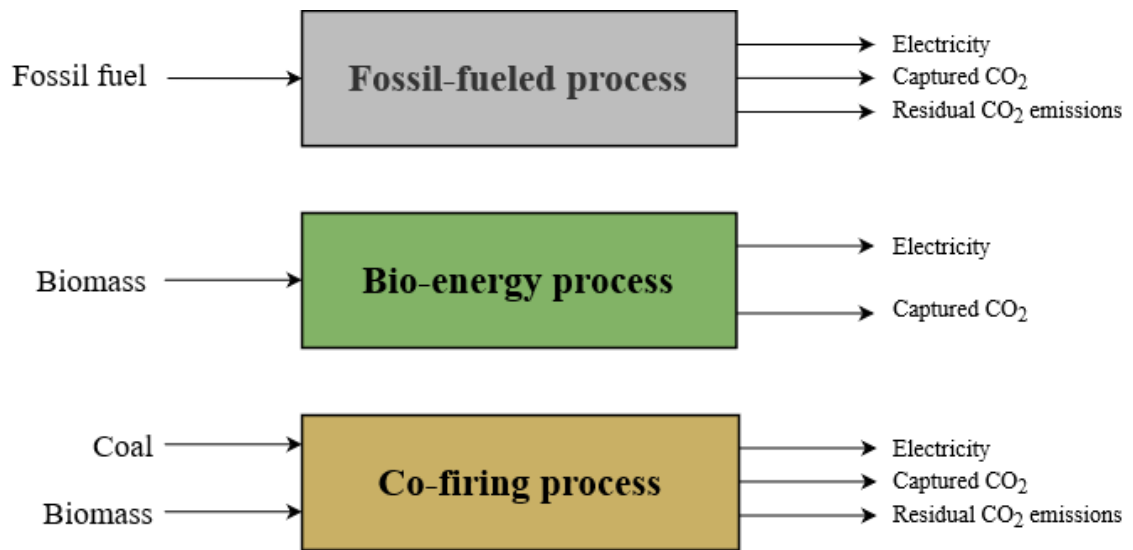

Figure 22: Input and outputs of power plants with CO₂ capture in TIAM-FR.

Note that we show no CO₂ emissions for the BECC plant as we consider bioenergy as a renewable climate-neutral energy carrier although upstream emissions associated to its harvest are accounted for.

3. Hydrogen generation

Hydrogen production is an essential sector to model, first because it interacts in many ways with CO₂ to produce CO₂-based goods, second because its decarbonization can be accomplished with CCS techniques, and third because hydrogen competes downstream with CCS options in the industry sector. Therefore, we devoted a lot of time to better representing hydrogen generation in TIAM-FR. Notably, the hydrogen sector is not modeled *per se* in EPPA, but we bypassed this problem, as explained in Section 7. Reviewing the techno-economic literature on hydrogen generation, it appears that many different estimations exist, especially regarding the CAPEX of the process. In order to propose transparent modeling, and include different levels of optimism concerning the cost of producing hydrogen, we developed different cost scenarios based on Parkinson et al. (2019) for the blue and grey routes, and (DNV-GL, 2020; Schmidt et al., 2017) for the green route. In a second subsection, we detail the introduction of new opportunities into the model to ship hydrogen from low-cost places such as Australia to demanding regions such as Japan.

3.1. Update of the production processes

The former representation of hydrogen production in TIAM-FR lacked details and transparency regarding the techno-economic values initially implemented in the model. Besides, quite old data (2004) were used to describe the performances of the hydrogen value chain. Overall, in studies, the

transparency of the techno-economic assumptions related to hydrogen is often neglected, possibly due to the confidentiality of the data. To avoid this, we demonstrate here how we built a techno-economic database for hydrogen production routes based on publicly available data from the scientific literature. For the various scenarios selected, we justify the assumptions about the performances and costs of each production route, present and future.

We divide this subsection into two, with the first part referring to the grey and blue processes, i.e., processes that transform hydrocarbon fuels into hydrogen (without and with CCS), and the second referring to green hydrogen or electrolysis processes.

3.2. Grey and blue production routes

The grey production routes refer to the conventional routes. These consist either in gasifying coal products, or hydrogenating natural gas, which generate both combustion and process CO₂ emissions. Blue production routes refer to processes that use the same chemical reactions as grey routes but are equipped with a carbon capture unit limiting the CO₂ emissions.

In our modeling, we assume no electricity consumption for blue and grey hydrogen plants, i.e., the plants modeled have a single energy commodity input that is coal, gas, or biomass, and they generate their own electricity onsite. Regarding the economic life of projects, we assume that the production units without CCS operate for 25 years, and production units with CCS for 20 years, to consider that the lifespan of capture units is shorter than the plant itself. The capture ratio is set at 90% and so is the availability factor (Rubin et al., 2015). We also assume a discount rate of 10% for all production routes. The emissions factors (EIA, 2022) report direct CO₂ emissions only, including combustion and process CO₂.

Considering these basic assumptions, we take advantage of a publication of (Parkinson et al., 2019) that develops different cost scenarios for hydrogen production, as shown in Table 13. The authors made a first estimation based on peer-reviewed publications, then they identified the critical parameters that influence the levelized cost of hydrogen (LCOH), and varied these parameters to generate a self-made estimation. As no levelized cost can be implemented in TIAM-FR, we need to disaggregate the LCOH of each scenario into capital cost (CAPEX), fixed operational costs (FIXOM), variable operational cost (VAROM), and other attributes, that will subsequently be used to specify the characteristics of each process depending on the scenario. As shown in the figure below, we do not consider the pyrolysis of methane, as it shows a very low TRL.

Table 13: Levelized cost estimations for grey and blue hydrogen production routes (Parkinson et al., 2019)

Technology	Literature estimates [\$/kgH ₂]			Parkinson et al. (2019) estimates [\$/kgH ₂]		
	Low	Medium	High	Low	Medium	High
SMR	1.03	1.26	2.16	1.03	1.26	2.16
SMR w/CCS	1.22	1.88	2.81	1.93	2.09	2.26
Coal	0.96	1.38	1.88	0.96	1.38	1.88
Coal w/CCS	1.40	2.17	3.60	2.24	2.46	2.68
Biomass	1.48	2.24	3.00	1.48	2.24	3.00
Biomass w/CCS		2.27		3.15	3.37	3.60

Among the six cost scenarios in Figure 4, we select the values of the authors' estimation, as they reviewed the literature estimates by considering more realistic assumptions and ranges for the Low and High cases. For each of those four scenarios, we report the cost of fuel assumed for their calculation in Table 14, which allows us to retrieve the rest of the techno-economic parameters of hydrogen processes, following the formula of LCOH:

$$LCOH = \frac{CAPEX \times CRC}{OH} + \frac{FIXOM}{OH} + VAROM + FUEL$$

There are three unknowns in the equation above, but the CAPEX is the most important one, representing roughly 50% of the LCOH according to estimations (IEAGHG, 2017; NETL, 2022). Therefore, we transform this equation with three unknowns into an equation with one unknown, which is the CAPEX, by making assumptions on:

- The fuel efficiency,
- The share of FIXOM relative to CAPEX (FIXOM equals to a certain percentage of CAPEX),
- The value of VAROM.

These assumptions are clearly specified for each grey and blue process in the following paragraphs. Thus, CAPEX stands as the unknown variable of the equation above. Ultimately, we should be able to characterize the techno-economic features of each process, based on either assumptions or calculations, but keeping a certain competitiveness between processes based on the LCOH by (Parkinson et al., 2019).

Table 14: Fuel costs by scenario (Parkinson et al., 2019)

Parameters	Unit	Low	Central	High
Natural gas cost	USD/GJ	3.3	4.0	8.4
Coal cost	USD/GJ	1.3	2.0	2.7
Biomass cost	USD/GJ	2.9	4.0	5.0
Electricity cost	USD/kWh	0.07	0.07	0.07

For the CCS routes, the cost of CO₂ transport and storage was included in the literature estimations and varies from 0 to \$16/tCO₂ according to studies. As we did not find the cost of CO₂ transport and storage that the authors assumed in their own estimation, we assumed it empirically as \$10/tCO₂ which is a generic value for CO₂ transport and storage (Smith et al., 2021b), and we deducted this from their estimation.

3.2.1. The coal gasification route w/wo carbon capture

The assumptions shown in Table 15 were used to retrieve the costs of coal gasification plants. Table 16 shows the exogenous assumptions that assume a cost decrease for coal gasification equipped with carbon capture only.

Table 15: Assumptions for coal gasification w/wo carbon capture

Parameter	Unit	Value woCC	Reference	Value wCC	Reference
FIXOM	%CAPEX	5%	(IEA, 2019d)	5%	(IEA, 2019d)
VAROM	\$/GJ	0.19	(JRC, 2021)	0.26	(JRC, 2021)
Efficiency LHV	%	60%	(IEA, 2019d)	58%	(IEA, 2019d)
Emissions	tCO ₂ eq/tH ₂	20.2	(IEA, 2019d)	2.1	(IEA, 2019d)

woCC: without carbon capture; wCC: with carbon capture

Comparing the efficiency of blue and grey plants, there is a slight difference between the two due to the CO₂-concentrated nature of flue gas from the gasification unit, and little additional energy is required to capture this CO₂.

Table 16: CAPEX reduction assumptions for coal gasification with carbon capture (IEA, 2015)

Year	CAPEX decrease
2030	-23%
2050	-27%

Notably, in The Future of Hydrogen (IEA, 2019d), the IEA assumes no cost decrease at all for coal gasification routes, contrary to the Technology Roadmap (IEA, 2015). As for other sectors in the model, we take the position that the cost of capture units will decline over time, but the cost decrease of the gasification units themselves is negligible.

3.2.2. The SMR route w/wo carbon capture

The steam methane reforming (SMR) route is the most used method in the world to manufacture hydrogen to supply the chemical and petrochemical industries (IEA, 2021d). It consists in making methane molecules react with steam, producing hydrogen and CO₂. Equipping an SMR with a capture unit significantly increases costs. The loss in efficiency is higher than that of coal gasification because of the less concentrated flue gas.

Table 17: Assumptions SMR w/wo carbon capture

Parameter	Unit	Value woCC	Reference	Value wCC	Reference
FIXOM	%CAPEX	5%	(IEA, 2019d)	3%	(IEA, 2019d)
VAROM	\$/GJ	0.09	(JRC, 2021)	0.62	(JRC, 2021)
Efficiency LHV	%	76%	(IEA, 2019d)	69%	(IEA, 2019d)
Emissions	tCO ₂ /tH ₂	8.9	(IEA, 2019d)	1.0	(IEA, 2019d)

woCC: without carbon capture; wCC: with carbon capture

The cost decrease is assumed for assets both with and without CCS. This assumption stems from the fact that larger capacities of SMR with CCS are expected to be developed, so consequently cost improvements are expected, not only for the capture unit but also for the SMR itself.

Table 18: CAPEX reduction assumptions for SMR (JRC, 2021) (IEA, 2015)

Year	CAPEX decrease woCC	CAPEX decrease wCC
2030	-20%	-49%
2050		-51%

woCC: without carbon capture; wCC: with carbon capture

3.2.3. The biomass route w/wo CCS

Unlike coal gasification and SMR, the biomass route is not mature yet, increasing the uncertainty regarding the costs (IEA Bioenergy, 2018; Rosa and Mazzotti, 2022). This method consists in gasifying the biomass to generate water and hydrogen, in a similar approach to the coal route. The lower heating value of biomass (LHV) is assumed to be equal to 19 GJ/t (IPCC, 2006).

Table 19: Assumptions for the biomass route w/wo carbon capture

Parameter	Unit	Value woCC	Reference	Value wCC	Reference
FIXOM	%CAPEX	5%	(IEA, 2015)	5%	(IEA, 2015)
VAROM	\$/GJ	1.09	(JRC, 2021)	1.09	(JRC, 2021)
Efficiency LHV	%	55%	(JRC, 2021)	36%	(JRC, 2021)
Emissions	tCO ₂ /tH ₂	0		-11.7	(Parkinson et al., 2019)

woCC: without carbon capture; wCC: with carbon capture

For the cost decrease, we apply the same assumptions as the coal route.

Table 20: CAPEX reduction assumptions for biomass gasification with CCS (IEA, 2015)

Year	CAPEX decrease
2030	-23%
2050	-27%

The above assumption results in an estimation of the CAPEX of non-electrolysis routes, consistent with the cost scenarios of Parkinson et al. (2019). Because uniform assumptions were chosen depending on the process, the information retrieved guarantees the same competitiveness between routes, as shown by Parkinson et al. (2019). These assumptions and results about the CAPEX are used as inputs into the TIAM-FR model.

Table 21: CAPEX estimation of fossil and bio-based routes in the Central Scenario

Technology	CapEx 2020	CapEx 2050
Unit	\$/kWH₂	\$/kWH₂
Coal gasification	1412	1412
SMR	917	733
Biomass gasification	1653	1653
Coal gasification with carbon capture	2545	1859
SMR with carbon capture	1964	1004
Biomass gasification with carbon capture	2731	1995

Table 22: CAPEX estimation of fossil and bio-based routes in the Low Scenario

Technology	CapEx 2020	CapEx 2050
Unit	\$/kWH₂	\$/kWH₂
Coal gasification	996	996
SMR	575	460
Biomass gasification	574	574
Coal gasification with carbon capture	2232	1631
SMR with carbon capture	1706	872
Biomass gasification with carbon capture	2419	1767

We noted one inconsistency in the High scenario, which is that the CAPEX of SMR with capture is smaller than without capture. This is due to the assumptions made on the CAPEX reduction of SMR with CCS by the IEA (IEA, 2015). Therefore, we revise this assumption in the High scenario, so that no cost reductions are assumed in this case.

Table 23: CAPEX estimation of fossil and bio-based routes in the High Scenario

Technology	CapEx 2020	CapEx 2050
Unit	\$/kWH₂	\$/kWH₂
Coal gasification	1946	1946
SMR	2253	2253
Biomass gasification		2732
Coal gasification with carbon capture		2857

SMR with carbon capture	3125	3125
Biomass gasification with carbon capture		3058

We calculate for each scenario, present and future, the cost of avoided CO₂ for the coal, biomass, and gas routes. Note that the cost of transport and storage of CO₂ is included.

$$\text{Cost of avoided CO}_2 = \frac{LCOH_{woCCS} - LCOH_{wCCS}}{CO2_{wCCS} - CO2_{woCCS}}$$

Interestingly, the Low scenario is related to lower production costs, but higher costs of avoided CO₂. Therefore, if the Low scenario is chosen when running the model, it can be expected that conventional hydrogen production routes would be preferred. Conversely, in the Central scenario, the cost of avoided CO₂ is cheaper which may bring about the deployment of larger amounts of carbon capture units.

We emphasize that these estimations are strongly dependent on the cost of fuel, which is determined both endogenously and exogenously by the model, depending on the cost curves implemented (see Chapter 2).

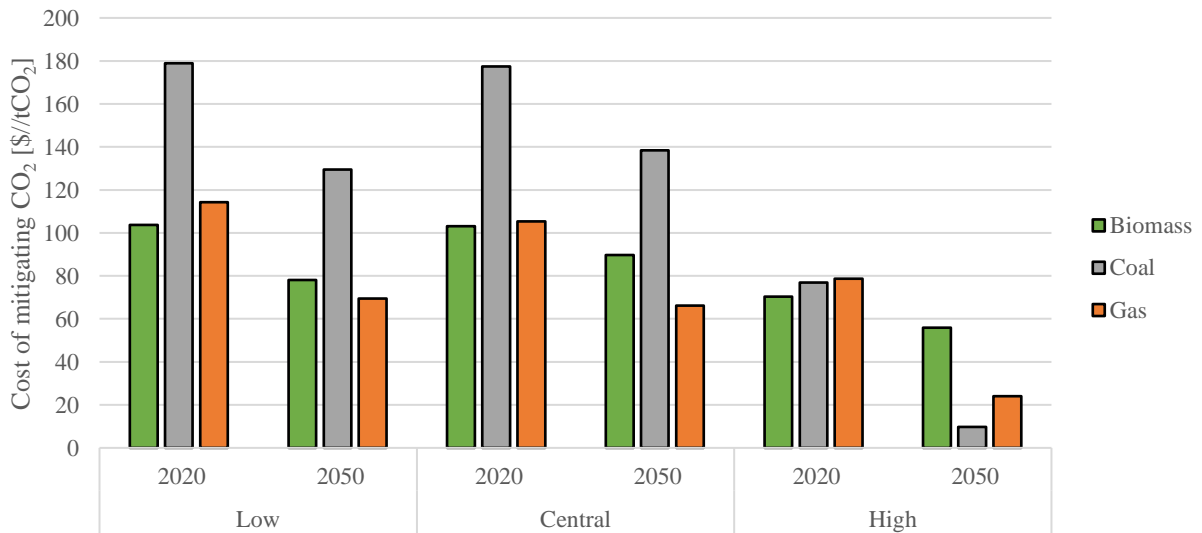

Figure 23: Cost of avoided CO₂ by scenario and technology

For conservative scenarios, the model runs with the Central scenario. When sensitivity analysis relative to the cost of hydrogen is considered, the other two scenarios are used.

3.3. Green production routes

For the electrolysis routes, we did not consider the findings of Parkinson et al. (2019) because they provide aggregated data that are not based on the electrolysis technology, but on the source of the electricity (nuclear, PV or wind), while TIAM-FR decides endogenously on the electricity mix to feed electrolyzers.

Indeed, there are several types of electrolyzer, mostly known as alkaline, proton exchange membrane (PEM), and solid oxide electrolysis cell (SOEC). We decided not to integrate the SOEC technology because of its very low maturity. Regarding the other two, they differ in their techno-economic parameters and lifetimes, alkaline being cheaper but less durable than PEM.

On the one hand, we used an expert elicitation study (Schmidt et al., 2017) delivering median CAPEX and lifetimes for both alkaline and PEM technologies in 2020 and 2030 in two cases:

- R&D: Costs under an extreme research and development (R&D) funding scenario
- RD&D: Costs under an extreme research and development (R&D) funding scenario and production scale-up

As the study was published in 2017 and hydrogen has not since experienced a massive funding scenario, we do not use the data from the RD&D scenario in 2020.

On the other hand, we use the assumptions from the DNV-GL report (DNV-GL, 2020) for the FIXOM (2% of CAPEX) and efficiencies, present and future.

Table 24: Assumptions for the electrolysis process (DNV-GL, 2020)

Technology	Year	Efficiency
Alkaline	2020	64.1%
	2030	68.0%
	2040	69.4%
	2050	70.9%
PEM	2020	60.0%
	2030	60.6%
	2040	69.4%
	2050	70.9%

With this data, we define electrolysis processes in TIAM-FR:

- HPEM105 which refers to centralized PEM electrolyzers,
- HALK105 which refers to centralized alkaline electrolyzers,
- HPEM205 which refers to decentralized PEM electrolyzers,
- HALK205 which refers to decentralized alkaline electrolyzers.

The decentralized and centralized processes have the same techno-economic properties. However, the decentralized ones can only be fed with intermittent electricity, while the centralized ones use grid electricity. In addition, decentralized processes can only work when intermittent energy is available, which is made explicit in TIMES language by specifying the so-called *TimeSlice* level of process activity as DAYNITE. We emphasize one specificity about the lifetime of the electrolysis facility which can be decomposed between the stack of the electrolyzer and the rest of the facility, which is supposed to last 20 years (JRC, 2021). We decide to consider the fact that the technical life of the stack is way shorter than 20 years, thereby we choose to calculate the lifetime of the whole facility as the empirical average of 20 years, and the lifetime of the stack. Similar to the previous work with blue and grey hydrogen where we define different scenarios, here we use Low, Central and High scenarios. Independently from the scenario, all electrolyzers have the same properties, according to the technology. Future costs (after 2030) vary as shown in Table 25.

Table 25: Attribution of future techno-economic parameters for electrolysis processes

Properties for 2030 and beyond	Low	Central	High
CAPEX	Mean value of RD&D elicitation results	Mean value of R&D elicitation results	Same as 2020
PEM	\$910/kWe	\$1,200/kWe	\$1,463/kWe
Alkaline	\$550/kWe	\$750/kWe	\$1,050/kWe
FIXOM	Following DNV-GL report	Following DNV-GL report	Following DNV-GL report

	2.0% of CAPEX p.a.	2.0% of CAPEX p.a.	2.0% of CAPEX p.a.
Efficiency	Following DNV-GL report (Future 2030)	Following DNV-GL report (Low scenario)	Same as 2020 following DNV-GL report (High scenario)
PEM	50.0 kWh/kgH ₂	55.5 kWh/kgH ₂	59.5 kWh/kgH ₂
Alkaline	49.0 kWh/kgH ₂	47.6 kWh/kgH ₂	52.9 kWh/kgH ₂
Lifetime	Same as 2020	Mean value of R&D elicitation results	Same as 2020
PEM	85,000 hours	76,250 hours	50,500 hours
Alkaline	82,500 hours	72,500 hours	65,500 hours

This work made it possible to design a database that is scenario dependent. The possibility of this choice is important because the performance of the means of hydrogen production varies enormously and in fact reflects the level of modelers' optimism or pessimism regarding this sector. This can also make it easy to study the impact of the cost of hydrogen production on the model's results, and in particular its competition with CCS or other energy carriers.

3.4. Hydrogen trade opportunities

With the help of Leiqiong CAI, an intern at TotalEnergies, and Li Chen, a research engineer at TotalEnergies, we modeled solutions for shipping hydrogen between regions of the world. An extensive literature review on the techno-economic performances of shipping hydrogen was carried out, including the liquefaction and regasification processes. An Excel tool was created that calculates the cost of shipping H₂, depending on the shipping distance. As some regions in the world have higher renewable potentials than others, those regions with high energy demand but low potential could import low-carbon hydrogen. In particular, several studies have looked at how to generate low-carbon hydrogen in Australia (Alkhaledi et al., 2022; Johnston et al., 2022; Raab et al., 2021), Latin America (Heuser et al., 2019), Africa (Niermann et al., 2021), and the Middle East, and how to ship it to future hydrogen economies such in Japan, South Korea and Europe. These regions and countries in the Northern Hemisphere are keen to use hydrogen to decarbonize their energy consumption, but are faced with relatively low renewable potentials. Thus, for the four aforementioned regions, and these three consumption regions, we enhanced the Excel tool to calculate the cost of trading hydrogen between the regions in question, including liquefaction and regasification processes, and land storage (Figure 24).

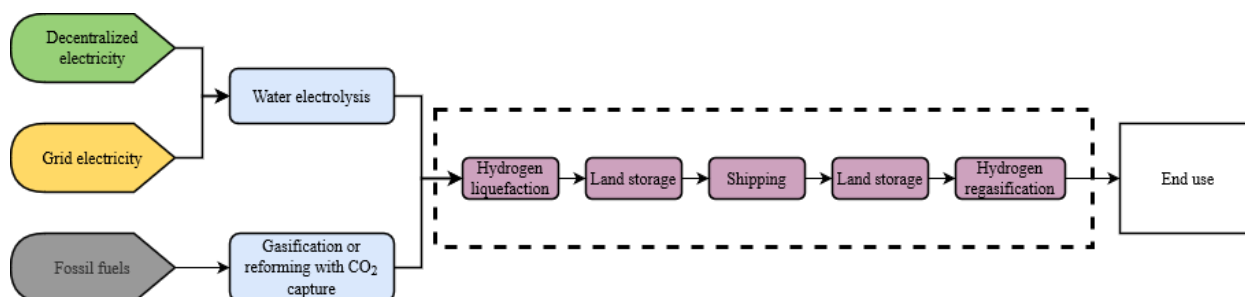

Figure 24: Hydrogen value chain from production to consumption. The dashed rectangle encircling the purple blocks refers to the scope of the modelling.

Shipping gaseous hydrogen requires huge volume, high-pressure storage tanks due to the low density of gaseous hydrogen. Liquefying hydrogen at very low pressures and temperatures increases the hydrogen density by 790 times (71 kg/m³) compared to its gaseous phase at normalized atmospheric pressure (0.0899 kg/Nm³), and by about 1.7 times compared to its gaseous phase at 700 bars (42.1 kg/m³). A liquefaction process consists of three main stages: precooling, cryogenic, and liquefying. The first two stages are combined with compressors, expanders, condensers, and heat exchangers. These are energy-intensive stages consuming roughly 12 kWh/kgH₂ (Heuser et al., 2019). After liquefaction, temporary storage should be considered as the ship may not be ready to load the liquid hydrogen right

away. Storage consists of on-land tanks, including a pump that transfers the liquid hydrogen to the ship, and a compressor that sends the so-called boil-off gases (BOG) to the liquefier. These BOG are hydrogen gaseous losses that occur due to the difference in pressure between the tank and the atmosphere. This process requires approximately 0.2 kWh/kgH₂ (Ishimoto et al., 2020). Once loaded into cryogenic tanks onboard, the liquid hydrogen is shipped to another place. It is assumed that future commercial projects will feature a capacity of 80,000 m³, with an average speed of 16 knots, operating 8,000 hours per year. Initially, these ships would be fueled with heavy fuel oil (HFO), but we assume that BOG will be recovered when advanced technologies are available.

Table 26: Main technical assumptions for shipping

Attribute	Value	Unit
Hydrogen carrier capacity	80,000	m ³
Boil-off gas (BOG) production rate per day	0.2	%/day
Maximum storage rate to ship tank capacity	98	%
Minimum storage rate to ship tank capacity	4	%
Shipping speed	16	knots/h
Annual operating hours of shipping	8,000	hours

Once it has arrived at destination, the liquid hydrogen is buffered again in a storage tank before being regasified. The regasification process consists in pumping, heating and expanding the gas to the desired pressure (1.7 bar). This requires around 2,9 kWh/kg H₂ of electricity (Laouir, 2019).

The costs of liquefaction, shipping, land storage, and regasification are shown in Table 27 below, with their respective references.

Table 27: Techno-economic performances of the hydrogen transport value chain

Process	Reference	Attribute	Value	Unit
Liquefaction	(Raab et al., 2021)	Electricity input	0.006	PJ/PJ
		CAPEX	29.42	€/GJH ₂ _a
		FIXOM	0.588	€/GJH ₂
		VAROM	1.004	€/kgH ₂
		CAPEX	4.981	\$/GJ_a
Shipping	(Niermann et al., 2021)	FIXOM	0.100	\$/GJ_a
		Electricity input	0.087	PJ/PJ
		CAPEX	0.010	€/GJ_a
		FIXOM	0.003	€/GJ_a
		VAROM	0.145	€/kg
Regasification	(DNV-GL, 2020)	Electricity input	0.360	PJ/PJ
		CAPEX	3.277	€/GJH ₂ _a
		FIXOM	0.083	€/GJH ₂ _a
Land storage	(Raab et al., 2021)	FIXOM	0.083	€/GJH ₂ _a

Concerning the efficiency and variable cost of shipping, these depend on the shipping distance. Indeed, the longer hydrogen travels, the more losses occur, which affects the transport efficiency and the energy efficiency (in terms of HFO input per H₂ output), which in turn affects the emissions and the variable costs.

In terms of modelling, we consider shipping hydrogen:

- from Australia (Melbourne) to Japan (Kobe), South Korea (Busan), and Western Europe (Rotterdam);
- from Latin America (Valparaiso) to Japan (Kobe) and Western Europe (Rotterdam); and
- from the Middle-East (Dubai) to Western Europe (Rotterdam).

The distances were taken from a website estimating shipping distances from one port to another (SEA-DISTANCES.ORG, 2022). We assume that hydrogen shipping is available starting from 2025, and that BOG recovery is available from 2035 onwards, avoiding fossil emissions from HFO combustion.

4. Biorefineries

Still with the objective of enriching TIAM-FR with carbon capture technologies, it is important to consider biomass transformation processes equipped with carbon capture. These denote processes taking place in the refinery supply sector that transform raw biomass, such as wood or corn, into liquid or gaseous biofuels, such as ethanol, jet fuels, or diesel. This processing of biomass products can generate negative emissions while producing biofuels if a capture unit is set up. In this section, we only focus on the first- and the second-generation processes, respectively converting biomass into liquid fuels with edible biomass and non-edible biomass. In particular, we concentrate on the fermentation of corn into bioethanol and biodiesel. The input and output commodities are as follows.

Two main references were used here, that is, a report by (IEAGHG, 2021b), on which most of the data is based, and a report by (IEA Bioenergy, 2019), which gives information on second-generation fermentation processes (without CCS). As the IEAGHG report is already based on a techno-economic literature review of biomass processes, we did not find it beneficial to replicate the report, and we simply collected the data and adapted it to the TIMES language. Thus, most of the work consisted in understanding these studies and organizing the data for the model, with the right commodities, processes, and their associated constraints. Below is the list of the processes that were added to the model:

Table 28: Technological characteristics of biorefineries

Row Labels	CO ₂ Capture		Energy input [PJ input/PJ output]					
	[kt/PJ]	Wheat	Maize	Crop starch	Wood	Logging residues	Electricity	Gas
First generation biodiesel plant (FP)					1.			
					77			
Second generation biodiesel plant (FT)					2.			
					28			
First generation bioethanol plant					1.71		0.04	0.38
Second generation bioethanol plant (cellulosic)						2.87		
Second generation bioethanol plant (corn stover)				0.35			0.11	0.74
Second generation bioethanol plant (wheat straw)				3.34				
Second generation biodiesel plant with CO ₂ capture (FP)			63			1.		
						71		
Second generation biodiesel plant with CO ₂ capture (FT)			122			2.		
						28		
Second generation biodiesel plant with CO ₂ capture (FT-MAX)			151			2.		
						28		
First generation bioethanol plant with CO ₂ capture			37			1.71	0.05	0.4
Second generation bioethanol plants with CO ₂ capture			37	3.34				
Second generation bioethanol plant with CO ₂ capture (MAX)			276	3.34				

The new processes implemented can be divided into two categories: biodiesel refineries and bioethanol refineries, fed with different types of biomass, whose global potentials and harvesting costs were established by (Kang, 2017). The biodiesel plants either work with a fast pyrolysis (FP) process or a Fischer-Tropsch (FT) process. In the cases when a CO₂ capture unit is set up, the efficiency can be improved to its maximum, hence the specification in the first columns of Table 28 and Table 29.

Table 29: Economic characteristics of biorefineries

Process	Capital cost	Fixed O&M	Variable O&M	Lifetime
First generation biodiesel plant (FP)	32.89		1.35	25
Second generation biodiesel plant (FT)	255.08		10.17	25
First generation bioethanol plant	16.04		0.63	25
Second generation bioethanol plant (cellulosic)	48	3.07		25
Second generation bioethanol plant (corn stover)	83.25	1.46		25
Second generation bioethanol plant (wheat straw)	148.89		5.94	20
Second generation biodiesel plant with CO ₂ capture (FP)	52.52		2.12	20
Second generation biodiesel plant with CO ₂ capture (FT)	256.81		10.29	20
Second generation biodiesel plant with CO ₂ capture (FT)	268.35		10.7	20
First generation bioethanol plant with CO ₂ capture	16.74		0.67	20
Second generation bioethanol plants with CO ₂ capture	150.05		6	20
Second generation bioethanol plant with CO ₂ capture	197.37		7.88	20

The operation of these processes is detailed in the references cited above: all technical and economic assumptions such as process lifetimes, discount rates, energy content of energy commodities and availability factors are those of the references, except that we separated the cost of CO₂ transport and storage in the OPEX and CAPEX of CCS installations.

With regard to constraints, we updated the regional capacities and production of bioethanol and biodiesel thanks to public data from the OECD-FAO and in particular the Agricultural Outlook by this same international organization (OECD-FAO, 2019). This ensures that the model produces the right amount of biodiesel and bioethanol globally for the first years of the horizon.

5. Industry sector

Because the cement and steel industries are responsible for more than 50% of GHG emissions from the industrial sector globally, we focused on these two sectors. Although the chemical industry also plays a major role, we decided not to include it in our modeling due to its complexity and the diverse processes involved, which would have taken too long and compromised the work on the rest of the industry. The cement sector and iron and steel sector were initially modeled in a simple manner only representing energy uses, such as process heat, machine drive, steam generation, etc., as described in (Fais et al., 2016). This representation of the industry had the benefit to explicitly addressing the questions of energy shifting and energy efficiency measures. However, the industry sector cannot only rely on these two decarbonization measures. Notably, this representation made it difficult to model CCUS options, account for CO₂ process emissions, and analyze energy and material flows. Therefore, we strived to represent explicitly the cement industry and the ISI, which required an in-depth understanding of their manufacturing processes. The new representation includes modeling from the primary materials extraction, i.e., limestone and raw iron, to the delivery of the end-product, i.e., cement and finished steel. The new modeling now combines the strength of the previous modeling with the possibility to invest in fuel-switching measures or in CCUS options with or without negative emissions. In the next two subsections – each dedicated respectively to the cement industry and ISI industries – we explain how we made their representation explicit. A common task for both industries involved calibrating their energy systems using the IEA 2018 World Energy Balance. This enabled us to describe the energy and material flows of the industries for the base year of the model (2018) and for each region of the model. Starting from this global picture, the second task was to propose opportunities for the model to invest

in cleaner production assets. Part of this work was carried out in close cooperation with Dr. Carlos Andrade, Research Engineer at IFP Energies Nouvelles during his post-doctoral research on the role of Negative Emissions Technologies (NET) for long-term decarbonization of the industry sector.

5.1. The cement industry

Cement is the second most consumed product in the world, after water (“About Cement & Concrete,” 2022). Its production was estimated at 4,282 Mt in 2018 (IEA, 2022g). Unlike many industries, cement production is fairly well distributed around the globe and is traded very little (Farfan et al., 2019; GID, 2021; Liu et al., 2021). Cement is turned into concrete, which is then used to build houses, bridges, roads, etc. The manufacturing process involves the decarbonation of limestone ($CaCO_3$) according to the following endothermic chemical formula:

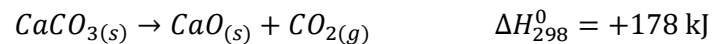

The above reaction refers to the first step of cement production, also known as the calcination reaction, which occurs in a rotary kiln at very high temperatures up to 1,450°C (ECRA, 2017). After passing through the kiln, granular calcium oxide – or clinker – is ground into a powder and mixed with other aggregates, such as gypsum. The combination of gypsum and clinker forms a commonly used cement known as Portland cement. There are different types of kiln, which can be classified either as wet or dry. The difference is that the latter use dehydrated limestone, which requires additional investments to process the dehydration, but less energy. The first cement plants in the world were of the wet type, but it is now acknowledged that dry processes are economically preferable, due to their energy efficiency (Table 30).

Table 30: Range of thermal energy consumption in dry and wet kilns (Sahoo et al., 2018)

Wet kiln	Dry kiln
5.86-6.28 [GJ/tclinker]	2.93-4.60 [GJ/tclinker]

Consequently, the wet process also emits more CO₂ into the atmosphere, since most of the energy used in cement manufacturing is fossil. Nonetheless, dry cement plants still emit roughly 800 kgCO_{2e} per ton of cement (Griffin et al., 2013). To reach very high temperatures, the kilns need to operate energy-dense fuels such as coal, gas, and oil. But more than 50% of the emissions from a cement plant are actually due to the calcination reaction, which results in emissions of so-called process CO₂ (NPC, 2019b). Thus, the main challenges underlying the decarbonization of the cement sector concern:

- Inevitable process CO₂ emissions that can be tackled either through carbon capture techniques, or offsets, or material shifting, e.g., by replacing the production of cement with other building materials or reducing the clinker content of cement (Bataille et al., 2018).
- The energy intensity, which requires relying on energy-dense fuels with high-energy diffusion, excluding electrification of the processes.
- Localized and scattered emissions that can be tackled at the level of each cement, which can make efforts difficult to aggregate.

For the calibration of the base year (2018), we used the Global Database of Cement Production Assets (McCarten et al., 2021) to specify which type of technology is used in each region to produce cement, i.e. dry process or wet process (Table 31). Only one different source was used for China (Global Cement, 2013), as the former was missing details. We also calibrated the energy consumption of both types according to the values of the IEA 2018 Energy Balances (IEA, 2021c), and their emissions accordingly.

Table 31: Region-specific stocks of wet and dry cement plants’ capacities (in Mt of cement per year) (McCarten et al., 2021)

AFR	AUS	CAN	CHI	CSA	EEU	FSU	IND	JPN	MEA	MEX	ODA	SKO	USA	WEU

Wet	0	0	1	600	1	0	6	0	0	0	0	0	0	1	0
Dry	194	41	28	3200	203	150	141	373	149	217	87	709	93	297	498

It is assumed that the remaining lifetime of existing cement plants is 30 years. Thus, for the base year and the next thirty years, the model can satisfy, in whole or in part, the global demand for cement. However, we gave the model the opportunity to decarbonize this industry through three levers: fuel switching, CCS, and CCU measures. Thus, the energy system of the cement sector is divided into three parts (Figure 25).

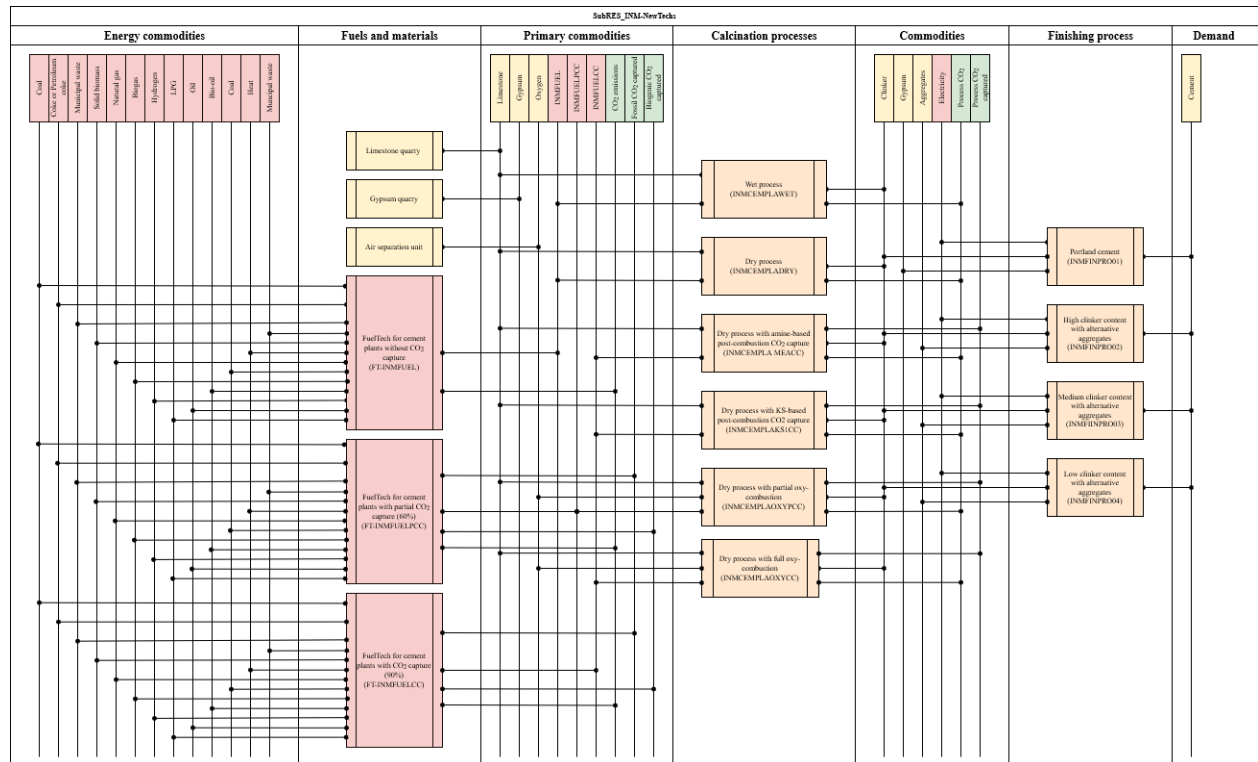

Figure 25: Reference Energy System of the cement industry in TIAM-FR

Firstly, fuel-switching measures allow the model to employ low-carbon energies or energy carriers such as hydrogen, electricity, bioenergy (i.e., bio-oil, biochar, pellets, solid biomass, and biogas). However, these energies are not freely available. Indeed, hydrogen cannot replace the fuel that is used to generate high temperatures in the kiln, because of differences in heat transfers, and investment would be required to redesign burners and retrofit plants (de Pee et al., 2018). Therefore, we assume that hydrogen can constitute only 5% of the gaseous energy mix of a cement plant, consistent with blending 5% of the energy content of H₂ in a natural gas pipeline (Di Lullo et al., 2021; Mahajan et al., 2022). This maximum share increases to 15% by 2040. Likewise, electricity is not a perfect substitute for coal or gas in kiln furnaces, although it is – and can be – used for other purposes in cement plants e.g., for grinding limestone, forklifts, or other electric devices. We empirically assume that the maximum utilization of electricity in cement plants for all regions of the model equals the maximum share of electricity observed – which is 21% in South Korea (IEA, 2021c) – multiplied by 20%, to provide room for improvement. Although municipal waste (MW) is not considered as a renewable energy, we adopt the same approach: the maximum utilization of MW in cement plants for all regions of the model equals the maximum share of MW observed – which is 1.8% in Eastern Europe – multiplied by 20%. However, we consider that solid biomass and gaseous biomass can respectively substitute coal and natural gas in cement plants. We neglect the small retrofitting investments required to process biomass (de Pee et al., 2018; ECRA, 2017). As shown in Figure 25, the energy commodities for cement plants can be processed into three different *FuelTechs*, each one corresponding to a type of cement plant, whether it is not

equipped with carbon capture (INMFUEL), partially equipped with carbon capture (INMFUELPC), or fully equipped with carbon capture (INMFUELCC). This differentiation is made in order to properly account for CO₂ emissions and captured CO₂. Concerning the amount of CO₂ capture, we obviously differentiate the biogenic (CPTINDCO₂B) and fossil CO₂ (CPTINDCO₂N), while process CO₂ is accounted for at the level of the process (CPTINDCO₂P). The costs for limestone are taken from (Ferrari et al., 2019) – delivering regional costs – and from (ETSAP, 2010) for gypsum and oxygen.

Secondly, in addition to the existing wet and dry plants, new cement plants are available representing different types of kiln and different CO₂ capture types. The scope of the cement plant we model includes limestone grinding, coal grinding – or fuel conditioning, pulp mill, heaters and pre-heaters, the kiln, the cooler, and clinker grinding. We distinguish two cases for CO₂ capture: post-combustion and oxy-combustion. For post-combustion capture, we model two types of solvent, i.e. monoethanolamine (MEA) and KS-1. The former is the most common chemical for CO₂ capture, and has been used for decades, while the latter has gained interest as it requires less energy to regenerate, with a longer lifespan and a higher CO₂ uptake (DOE, 2017; Global CCS Institute, 2021; Ho et al., 2009), but at higher cost (Griffin et al., 2013). We thus distinguish the following:

- A cement plant equipped with MEA-based post-combustion capture (INMCEMPLAMEACC).
- A cement plant equipped with KS1-based post-combustion capture (INMCEMPLAKS1CC).

The oxy-combustion technique is very interesting to consider for the cement industry. This technique requires an Air Separation Unit (ASU) to provide the oxygen to the fuel, emitting almost pure CO₂. Two options have been developed for the cement industry: either partial oxy-combustion, only to the calciner, or full oxy-combustion, to the whole kiln, thus covering both process and combustion CO₂ emissions. The partial capture covers approximately 60% of the emissions (ECRA, 2017; Griffin et al., 2013). We thus distinguish the following:

- A cement plant equipped with partial oxy-combustion capture (INMCEMPLAOXYPC).
- A cement plant equipped with full oxy-combustion capture (INMCEMPLAOXYPC).

The techno-economic assumptions were extracted from (CEMCAP, 2016; ECRA, 2017; Griffin et al., 2013) and are gathered in Table 32 and Table 33.

Table 32: Techno-economic properties of cement plants (unit: ton of clinker)

Process	CAPEX	FIXOM	VAROM	Discount rate	Lifespan	Start
Units	[\$/t]	[\$/t]	[\$/t]		[years]	
Wet process	392	22	1	10%	32.5	2018
Dry process	415	22	1	10%	32.5	2018
Dry process with amine CO₂ capture	653	32	4	15%	27.5	2030
Dry process with KS1 CO₂ capture	653	53	1	15%	27.5	2030
Dry process with partial oxyfuel capture	653	38	1	15%	27.5	2030
Dry process with oxyfuel capture	579	38	1	15%	27.5	2030

Table 33: Consumptions and emissions of cement plants (unit: ton of clinker)

Row Labels	Fuel	Limestone	Oxygen	Process CO ₂ emitted	Process CO ₂ captured
Units	[GJ/t]	[t/t]	[t/t]	[kg/t]	[kg/t]
Wet process	5,17	1.26		556	

Dry process	3,90	1.26		556	
Dry process with amine CO₂ capture	9,64	1.26		56	500
Dry process with KS1 CO₂ capture	8,24	1.26		56	500
Dry process with partial oxyfuel capture	4,57	1.26	0,16	196	280
Dry process with oxyfuel capture	5,27	1.26	0,26	47	428

Notably, the emissions from combustion CO₂ and the possible amounts of capture CO₂ are not shown here as they are endogenously determined according to the energy mix chosen by the optimization. All alternative technologies are available in 2030, and the annual availability factor is set at 90% for every process.

Thirdly, different finishing processes were implemented in the model. They refer to the final process that converts clinker into commercial cement. The conventional finishing process refers to the transformation of clinker into Ordinary Portland Cement (OPC), which consists in grinding and mixing clinker with gypsum, respectively by 95%wt and 5%wt (Fazio and Pennington, 2006). Thus, the finished cement is highly clinker-intensive, but an alternative finishing process consists in reducing the clinker share and using alternative aggregates such as blast furnace slag, fly ash, and limestone. Globally, cement is composed of 70.6% clinker today (Figure 26). In TIAM-FR we do not model natural pozzolana due to the lack of data, so we consider limestone for the base year.

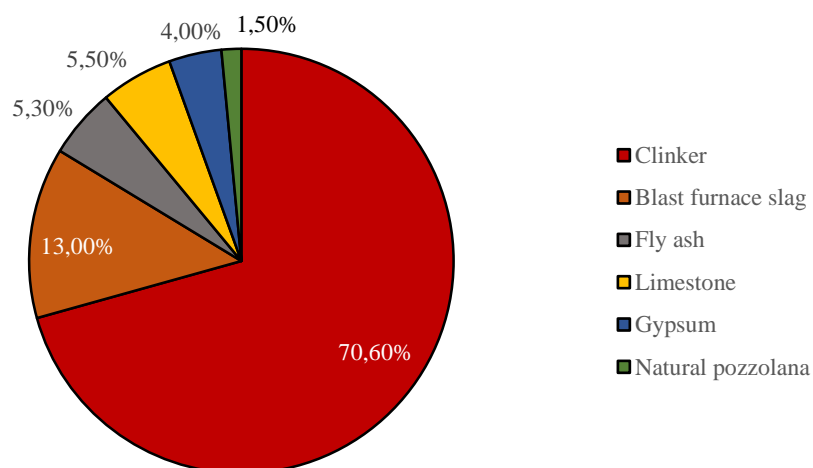

Figure 26: Global composition of cement (IEA, 2022h)

In TIAM-FR, four finishing processes are distinguished, the first one being the conventional process. The second one mixes clinker with 5% alternative aggregates other than gypsum, and the third and fourth processes respectively reduce the share of clinker to 80% and 65%, which is the minimum required (Kosmatka, 1988).

Table 34: Different finishing processes for different compositions of cement in TIAM-FR

Name	Clinker share	Gypsum share	Alternative aggregate share
Finishing process 1	95%	5%	0%
Finishing process 2	95%	0%	5%
Finishing process 3	80%	0%	20%
Finishing process 4	65%	0%	35%

Alternative aggregates include limestone, gypsum, fly ash, mineralized fly ash, and mineralized steel slag, whose modeling is explained in Section 7.4. The model is free to choose the share of these five inputs in the total amount of alternative aggregate output.

Finally, we included retrofitting options for existing dry cement plants. We did not include wet plants, as they are expected to be phased out. Therefore, we accounted for the energy penalty and additional costs of retrofitting an existing dry plant based on (Griffin et al., 2013).

5.2. The iron and steel industry

The iron and steel industry (ISI) is modelled as one of the six subsectors of the industry sector, namely cement, chemistry, pulp and paper, alumina, and the rest of the industry. The energy consumption of the model's base year, i.e. 2018, relies on the energy balances of the steel industry from the IEA database (IEA 2020b). The demand satisfied by the model is described in terms of tons of materials based on the (World Steel Association 2020). As a result, each region has a certain energy efficiency that converts the energy used into tons of steel, depending on the efficiency of the existing assets in 2018. Steel demand is projected over the 21st century based on the gross domestic product (GDP) per capita. Indeed, the quantity of steel produced by a country has been proven to be a function of this socio-economic driver (Neelis and M.K Patel. 2006.; van Ruijven et al. 2016). Regarding the projection of GDP per capita, those are extracted from the IIASA SSP database (Riahi et al. 2017). The database enables us to calculate the elasticity of final energy demand of the industry to GDP per capita. Roughly, the steel demand would increase from 1.8 Mt in 2018 to 2.4 Mt in 2050 and decreases to 2.1 Mt in 2100. China is the largest producer of steel in 2018, representing 51% of the total steel production. This share would increase to 57% by 2050, but decrease to 55% by 2100.

Table 35: Possible uses of biomass in the iron and steel industry in TIAM-FR

Process	Availability date	Fossil fuel use	Bioproduct substitution	Maximum substitution potential	Reference
Coke oven	2018	Coal	Charcoal	0%-5%	(Mousa et al., 2016)
Pelletization	2018	Coal	Charcoal	0%-100%	(Nwachukwu et al., 2021)
Sintering	2018	Coke	Charcoal	0%-40%	
Blast Furnace / with CCS (including the Top Gas recycling option)	2018 / 2025	Coke	Charcoal	0%-6%	(Suopajarvi et al., 2017)
		Coal	Charcoal	0%-100%	
		Natural gas	Biomethane	0%-100%	
Direct Reduction of Iron (MIDREX) / with CCS	2018 / 2025	Natural gas	Biomethane	0%-100%	(Tanzer et al., 2020)
COREX / with CCS	2020 / 2025	Coal	Charcoal	0%-45%	(Norgate et al., 2012)
		Coke	Charcoal	0%-45%	
HISARNA / with CCS	2030	Coal	Charcoal	0%-45%	
ULCORED / with CCS	2030	Coal	Charcoal	0%-100%	(Tanzer et al., 2020)
		Natural gas	Biomethane	0%-100%	
		Natural gas	Biomethane	0%-100%	
ULCOWIN	2050	Coal	Charcoal	0%-100%	
Cupola	2018	Natural gas	Biomethane	0%-100%	(Yang et al., 2021)
		Coal	Charcoal	0%-100%	
EAF	2018	Natural gas	Biomethane	0%-100%	(Tanzer et al., 2020)
		Coal	Charcoal	0%-100%	
DRI-H ₂ integrated steel plant	2030	Coal	Charcoal	0%-100%	(Tanzer et al., 2020)
		Natural gas	Biomethane	0%-100%	
Final production of steel	2018	Natural gas	Biomethane	0%-100%	

In TIAM-FR, we model both conventional and alternative innovative technologies. Conventional technologies comprise the BF-BOF route, the DRI-EAF (MIDREX), and the EAF. Alternative technologies include the TGR BF-BOF, Corex, HISARNA, ULCORED, ULCOWIN, ULCOLYSIS, and DRI-H₂ processes, which can be equipped with a carbon capture unit. Retrofitting options of CCS to existing portfolios technologies is possible. It is available as well to retrofit existing MIDREX technologies to allow the consumption of hydrogen. In TIMES modeling, all these processes are characterized by their economics (ETSAP; Kuramochi et al. 2012; Wörtler et al. 2013; Vogl et al. 2018; West 2020; Keys et al. 2021), namely their CAPEX, variable and fixed OPEX, their lifetime, and discount rate, as well as their material and energy flows (ETSAP; Griffin et al. 2013; Sikström 2013; Keys et al. 2021), and their GHG emissions as well. The different techno-economic assumptions, for

the current and alternative steel producing technologies are detailed in the supplementary material. All techno-economic characteristics of the processes modelled in TIAM-FR are available in Appendix 2. We have included new opportunities to use biomass for both conventional and alternative steel producing routes. Table 35 presents a summary of the different potentials found in the literature to substitute fossil fuels with bioproducts for the different iron and steel technologies. In general, charcoal can substitute only a small share of the use of coke as it does not present the same physical and chemical characteristics. On the other hand, charcoal can substitute most of the coal (see the fifth column of Table 1), while biomethane is a perfect substitute to natural gas. Raw biomass cannot be used directly in any of these processes as it presents high moisture content, volatile matter content, low calorific value, low grindability, etc. (Mousa et al. 2016). It is also important to notice that biogas or syngas produced directly from anaerobic digestion and gasification cannot be used directly in the ISI as they do not present the same chemical composition as natural gas, so purification and upgrading are required beforehand. The solver can choose the optimal amount of bioproducts (any combination between 0% and the maximum substitution potential) to substitute fossil fuels so that the cost of producing steel is minimal.

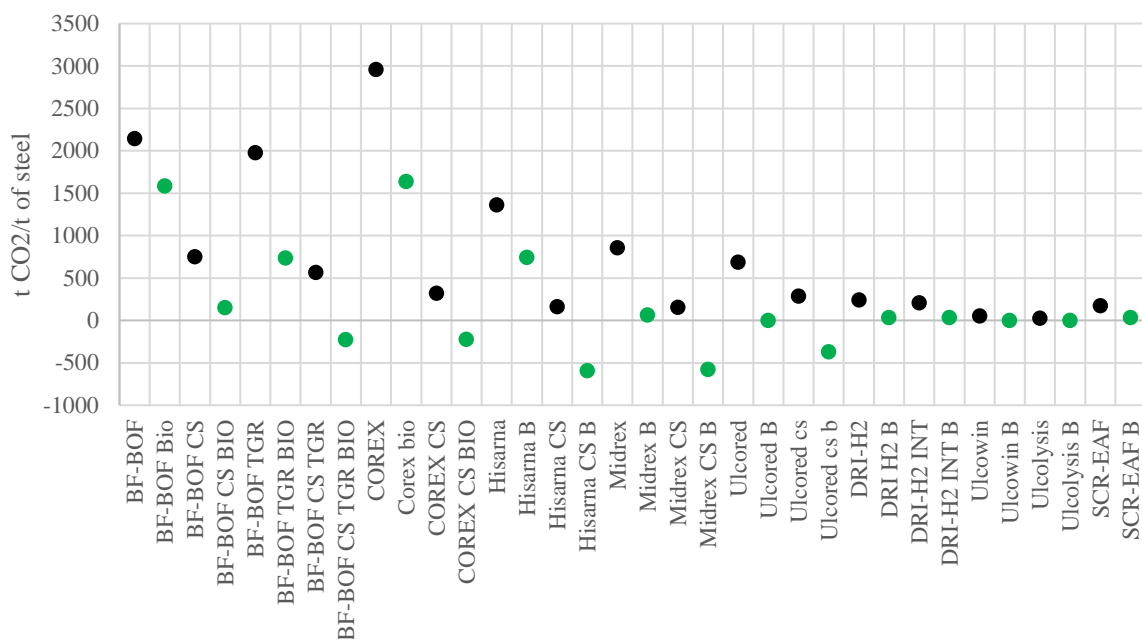

Figure 27: Maximum CO₂ emissions by steel producing technology represented in the TIAM-FR model

Before 2030, charcoal is available only in Brazil as around 20% of its steel production is based on this commodity (SINDIFER 2020), and in Norway that uses some charcoal in the steel industry. The use of bioproducts in the rest of the regions is made possible starting from 2030. The harvesting potentials of the different bioproducts (wood, agriculture residues, organic waste, etc.) are taken from (Kang 2017). Figure 27 represents the maximum emissions reduction achievable, by substituting fossil fuels by biomass. Thus, the lowest emissions levels can be obtained with the Hisarna and Midrex CCS processes. Without biomass and CCS, the COREX process is the most polluting route as it has high energy requirements, which are mostly covered by coal. This route produces 2,9 ktCO₂/t steel. Finally, the emission intensities for each of the commodities used in the model are based on the values from (IPCC 2023).

6. Direct air capture

6.1. DAC in EPPA

Top-down models represent technologies in an aggregate way. Currently, the only operational technology for DAC is the solid sorbent technology, which is a low-temperature (LT) process. Potentially, it would operate at lower costs than high-temperature processes. Hence, in our study we choose to focus on the LT technology. Therefore, we consider the DAC facility that includes heat pumps

that provide low-temperature heat to regenerate the sorbent. Although this is a less mature technology, it is also the most promising because it avoids the need for high temperature heat generally provided by natural gas, thereby increasing net CO₂ removal compared to HT processes.

While we limit ourselves to one DAC technology, we model two types of facilities: one powered by grid electricity, and the other one powered by dedicated variable renewable assets (VRA), namely solar photovoltaics and wind. This distinction is made since delivering CO₂-rich electricity to DAC plants can have the opposite effect of CO₂ removal as certain grids in the world are still carbon intensive, such that the CO₂ emissions associated with electricity generation would exceed the CO₂ removed from the air. Thus, modeling DAC plants with dedicated assets would increase the chances of DAC being deployed before the grid is decarbonized, at the expense of much higher capital costs.

The capital and operational costs in this study are extracted from the National Academies of Sciences, Engineering, and Medicine study (NASEM, 2019) using their *Low*, *High*, and *Worst* cases. The energy requirements are taken from (Herzog, 2022), calculating that 1,071 kWh/tCO₂ are required using a heat pump with a coefficient of performance (COP) of 3.5. For the “High” scenario, the COP of the heat pump is assumed to be 3, increasing the energy consumption to 1,167 kWh/tCO₂. If the CO₂ is to be stored, we add to these consumptions 120 kWh/tCO₂ representing the electricity necessary for the compression of CO₂ (APS, 2011), and we include the cost of CO₂ transport and storage based on Smith et al. (2021). All DAC plants have a 1 Mtpa capacity and are designed for 20 years of operation with a capacity factor of 90% and a discount rate of 11% (NASEM, 2019). In the cases where power is supplied to DAC plants with VRA, we include additional capital costs to reflect the need for batteries and the construction of excess VRA capacity to ensure the energy needs of the DAC units can be met given the intermittency of the VRA. As we want the plants to run 90% of the time, the renewable capacities need to be oversized according to their capacity factor.

$$C_{VRA} = \frac{Tec \times C_{DAC}}{8760 \times CF_{VRA}} \#(1)$$

Where Tec is the total energy consumption in MWh/tCO₂, C_{DAC} is the capacity of the DAC plant in Mtpa, and CF_{VRA} equals to 35% and 20% capacity factors respectively for wind and solar (Morris et al., 2019a). The required battery capacity $C_{battery}$ is then calculated estimated as follows:

$$C_{battery} = C_{VRA} \times 24 \times (1 - CF_{VRA}) \#(2)$$

The costs for batteries are assumed to be equal to \$300/kWh (McQueen et al., 2021a). The main techno-economic parameters of DACCS are shown in Tables 3 and Table 4 with grid electricity supply and with VRE supply, respectively. The techno-economic parameters of DACCU exclude costs and energy consumption related to storage. The tables include the estimated total CO₂ capture cost in the four scenarios, and Table 3 displays the total cost of net CO₂ removed considering the indirect CO₂ emissions of electricity generation through a cost factor (NASEM, 2019). Note that, in the model, we assume no indirect emissions due to solar and wind power generation.

Table 36: Techno-economic parameters of DACCS (NASEM, 2019a)) fed with grid electricity in \$2018 in the US

	Units	Very low	Low	Medium	High
Power		Grid	Grid	Grid	Grid
"Overnight" Capital Cost	\$/tpa	132	720	1,944	5,186
Total Capital Requirement	\$/tpa	142	777	2,099	5,601
Fixed O&M (FIXOM)	\$/tpa	11	11	22	48

Scaled CRR	\$/tCO ₂	17	91	246	658
FIXOM Recovery Required	\$/tCO ₂	19	19	31	60
Variable O&M (VAROM)	\$/tCO ₂	8	8	8	8
Electricity input	MWh/tCO ₂	1,2	1,2	1,2	1,2
Fuel cost	\$/tCO ₂	122	122	122	122
Total capture cost	\$/tCO ₂	177	252	419	859
Indirect CO ₂ emissions*	tCO ₂ /tCO ₂	0,58	0,58	0,58	0,58
Cost factor		2,38	2,38	2,38	2,38
Total cost of net CO ₂ removed	\$/tCO ₂	439	616	1,014	2,058

*the average carbon intensity of global electricity is 475 kgCO₂/MWh (IEA, 2019e)

Table 37: Techno-economic parameters for DACCS (NASEM, 2019) fed with solar photovoltaics VS wind in \$2018 in the US

	Units	Very low	Low	Medium	High
Power		Solar/Wind*	Solar/Wind*	Solar/Wind*	Solar/Wind*
"Overnight" Capital Cost	\$/tpa	915/830	1,382/1,284	2,482/2,384	5,456
Total Capital Requirement	\$/tpa	988	1,492/1,386	2,680/2,575	5,892
Fixed O&M (FIXOM)	\$/tpa	11	11	22	48
Scaled CRR	\$/tCO ₂	127	195/181	350/336	770
FIXOM Recovery Required	\$/tCO ₂	19	20	32	61
Variable O&M (VAROM)	\$/tCO ₂	8	8	39	41
Electricity input	MWh/tCO ₂	1.2	1.2	1.2	1.3
Fuel cost	\$/tCO ₂	172/127	172/127	172/127	186/137
Required installed VRE capacity	MW/Mtpa	544/386	544/386	544/389	588/420
Battery capacity	MWh/Mtpa	2,448/2,122	2,448/2,122	2,448/2,122	2,644/2,291
Total capture cost	\$/tCO ₂	327/263	407/348	605/574	1,069/1,036

*All techno-economic properties regarding solar and wind are taken from (Morris et al., 2019a)

We distinguish three DAC processes, depending on how they are powered:

- SDACCS and SDACCU are DAC units with dedicated solar assets generating respectively CO₂ permits and CO₂ as a raw material.
- WDACCS and WDACCU are DAC units with dedicated wind assets generating respectively CO₂ permits and CO₂ as a raw material.
- EDACCS and EDACCU are DAC units powered with grid electricity respectively delivering negative emissions in the form of CO₂ permits, and CO₂ as a raw material.

The nesting structures of DAC processes implemented in EPPA are shown in Figure 1. As a CGE model, EPPA uses nested constant elasticities of substitution (CES) functions to specify production technologies and substitution possibilities between inputs. The monetary inputs used by a DAC plant are capital, labor (including fixed and variable operating costs), and grid electricity, or solar or wind. At the top-level nest of the production function enters the Technology-Specific Factor (TSF), representing the adjustment cost for technology diffusion, and required to run the DAC plant. Thus, the TSF limits the penetration of new technologies such as DAC, based on empirical evidence on the penetration of past technologies (Morris et al., 2019b).

We assume that capital and labor nests are Cobb-Douglas functions (Balistreri et al., 2003) and the elasticity of substitution for TSF is based on Morris et al. (2019b). The function between the energy input (either solar, wind or grid electricity) and the Capital-Labor nest is assumed to be a Leontief function, meaning that they are needed in fixed proportions and cannot be substituted. As such, technology energy efficiency improvements are not considered. We do not account for the land use of the DAC unit itself or the land used by dedicated solar and wind, as we assume that the land used by solar or wind farms do not compete with crop land.

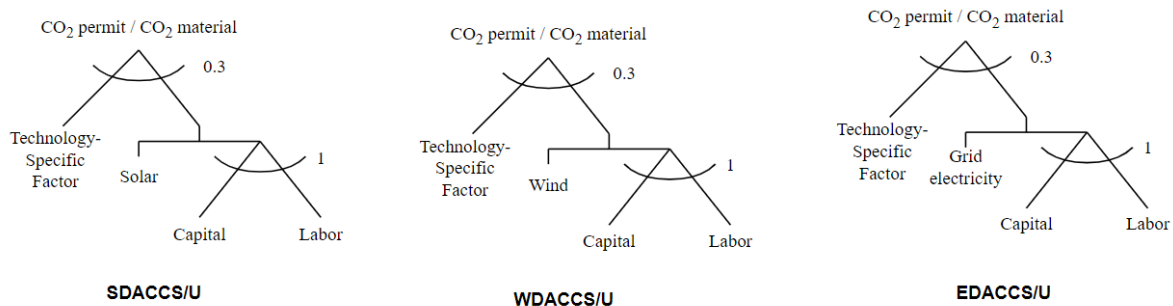

Figure 28: DAC units can either use solar or wind dedicated assets (left and middle) or grid electricity (right) For SDACCS, WDACCS and EDACCS, the output is a CO₂ permit, but for SDACCU, WDACCU, and EDACCU, the output is pure CO₂ ready to be converted into synthetic fuels

There are two options for the CO₂ that is captured from DAC: either it is compressed by the DAC plant and sent to storage to generate CO₂ permits, or it is used onsite by a Fischer-Tropsch process comprised of an electrolyzer and a compressor train, generating a slate of fuels made up of 47% sustainable aviation fuels (SAF) for the aviation sector, and 53% refined oil for other sectors (Zang et al., 2021). Likewise, these CO₂ utilization facilities are powered with grid electricity or dedicated wind or solar.

This work was carried together with the MIT Joint Program on the Science and Policy of Global Change. Dr. Sergey Paltsev, Senior Research Scientist, Dr. Angelo Gurgel, Research Scientist, Dr. Jennifer Morris, Principal Research Scientist, and Howard Herzog, Senior Research Engineer, participated in the modeling of DAC and provided their expertise on energy modeling and DAC technologies.

6.2. DAC in TIAM-FR

The approach adopted in EPPA was replicated in TIAM-FR, i.e. we considered the same techno-economic properties for DAC technologies including the variability of wind and solar and the surplus capital of the batteries.

7. CO₂ utilization

This section relates how CO₂ utilization was implemented in both models. TIAM-FR was enriched with four CO₂ utilization options, namely, CO₂-to-methanol, CO₂-to-methane, CO₂-to-liquid fuels (Fischer-Tropsch), and CO₂ mineralization processes. In EPPA, we were able to implement only one CO₂ utilization pathway technology due to lack of time. We chose to implement Fischer-Tropsch technologies because the literature review revealed that synthetic jet fuels are likely to be more interesting than synthetic methanol and methane in the future energy transition (see Chapter 1), and because the methanol commodity is not modeled in EPPA.

All CO₂ utilization processes are subject to a common advantageous assumption, which is that the CO₂ captured does not incur the costs of CO₂ transportation. In other words, we assume that all CO₂ utilization facilities process the CO₂ on-site, immediately after capture. This assumption was made for simplicity, as it is difficult to determine the distance between a capture site and a conversion site. Besides, it makes sense to assume that the facilities willing to convert CO₂ do so with their own captured CO₂, and do not import CO₂ from a client.

In the following sections, we adopted the same methodology, which consists in:

1. Reviewing the techno-economic literature for each CO₂ utilization option.
2. Collecting techno-economic data and standardizing them for each reference.
3. Under common assumptions about the cost of energy – essentially electricity and hydrogen – estimating the expense of the process described in an article compared to the conventional process. The assumptions are shown in Table 38.
4. Ranking the references according to their optimism.

This methodology stems from the fact that there are large uncertainties regarding the cost of CO₂ utilization. Thereby, it is important to classify values found in the literature and not rely on a single reference.

Table 38: Parametric assumptions for assessment of CO₂ utilization technologies

Parameters	Unit	Value
CO₂ cost	\$/tCO ₂	100
Grid electricity cost	\$/MWh	100
Hydrogen cost	\$/kg	3
Lifetime	Years	20
Capital Recovery Charge Rate	%	10.6%
Availability factor	%	90%

Finally, several designs of CO₂ utilization facilities were implemented (Figure 29). Their design depends on the nature of the CO₂ processed (fossil or climate neutral – see Section 1), and the type of energy input (variable renewable energy (VRE), or centralized electricity). The energy input can either be electricity or hydrogen. In the case where electricity is the energy input, this means that the electrolysis process is contained in the CO₂ conversion technology and may take advantage of the exothermic heat from the CO₂ conversion reaction. Investments for new CO₂ conversion capacities are available starting from 2030.

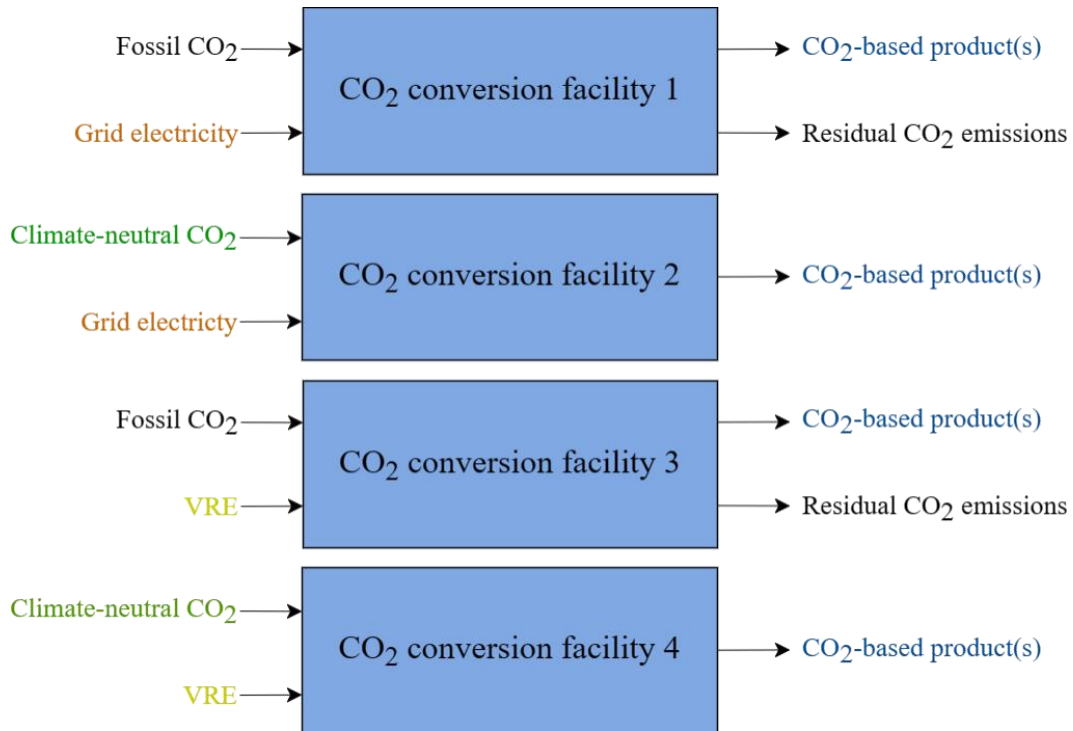

Figure 29: Four assorted designs for CO₂ conversion technologies in TIAM-FR

For the next three sections, in which we explain how we modeled CO₂ conversion into fuels (methanol, gas, and oil derivatives), all capital and fixed operational costs are calculated in \$/GJ_a, in compliance with the process capacity claimed in the studies. The capacities assumed in the studies are quite low, suggesting that economies of scale can be achieved in the future. Therefore, we assume that CAPEX investments decline by 2040, by leveraging them to a commercial capacity of 11.2 PJ/y (Winchester et al., 2013), according to the following formula:

$$CAPEX_{2040} = CAPEX_{2030} \times \left(\frac{C_{2030}}{C_{2040}} \right)^{0.68}$$

The value of the exponent in the above formula is taken from (Zhang et al., 2019).

7.1. CO₂ to methanol

Methanol (CH₃OH or MeOH) is an alcohol, used both as an industrial chemical product and a fuel. From 65 million tons produced worldwide in 2013 (Ampelli et al., 2015), production rose to 250 Mtpa in 2021 (IEA, 2022i), responsible for 222 Mt of CO₂ emissions in 2018 (IEA, 2022j), and representing about 3.4% of the direct CO₂ emissions of the industry sector. Methanol is mainly manufactured from natural gas or coal approximately at a rate of 50% and 40% (resp.) (IEA, 2017). The average market price of methanol is 400 €/t (Pérez-Fortes et al., 2016). About 60% of methanol production is used in the chemical industry, and the rest goes to the transportation sector (Pérez-Fortes et al., 2016). In the chemical industry, methanol is used to produce a large array of derivatives: formaldehyde, olefins, and acetic acid are the main products synthesized from methanol, as the graph below shows. The use of methanol as a fuel accounts for 37% (Pérez-Fortes et al., 2016), and there are two main applications. Firstly, methanol can be blended with gasoline, resulting in a cleaner, more efficient fuel (Methanol Institute, 2020). This process involves the polymerization of methanol into long-chain hydrocarbons, requiring reasonable pressure and temperature conditions (10-20 atm and 300-400°C) (Dowson and Styring, 2015). Currently in China, gasoline is mixed with 15% methanol without the need to redesign vehicle engines (Ampelli et al., 2015). The second application is the production of gasoline, which could potentially replace gasoline traditionally refined from crude oil.

The world's regional supply and demand for methanol is very heterogenous, with China dominating the market and possessing more than 50% of production plant capacities (Anwar et al., 2020). Europe is a small consumer and producer of methanol but still imports methanol to satisfy its demand (Ampelli et al., 2015).

The utilization of CO₂ for methanol production is gaining interest to reduce fossil-based production and thus reduce the carbon footprint of the product. The main process to convert CO₂ into methanol is hydrogenation, in which the CO₂ reacts with green hydrogen.

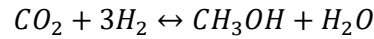

To date, renewable methanol is manufactured via CO₂ conversion in two major plants. The first one started operation in 2008 in Osaka, Japan. Mitsui Chemical Inc., the owner of the plant, utilizes CO₂ captured from factory flue gas and H₂ to react with hydrogen, itself produced using photolysis. The company manages the production of methanol at a rate of 100 t/y (Pérez-Fortes et al., 2016). The second plant is Carbon Recycling International, which has produced methanol for fuel applications in Iceland since 2007 at a rate of 50,000 L per annum. The process is renewable as it uses geothermal power and the CO₂ emitted from volcano activity (Armstrong, 2015).

In TIAM-FR, methanol is only modeled as an energy carrier, not as a chemical good. The energy demand for methanol as a chemical is implicitly modeled and included in the overall energy demand of the chemical industry. However, the production and use of methanol as a fuel was initially under the scope of TIAM-FR. Existing conventional technologies represented in the model are the so-called Coal-to-Methanol (CtM) and Natural Gas-to-Methanol (NtM) routes, which consist in a Fischer-Tropsch reaction in a presence of a catalyst. Pure methanol can be used for four means of transportation: buses, heavy trucks, light trucks, and cars. The blending of methanol with gasoline was not modeled initially.

We reviewed the techno-economic literature on CO₂-to-methanol processes, and found three contributions (Hank et al., 2018; Pérez-Fortes et al., 2016; Zhang et al., 2019). They all use hydrogenation reaction. The techno-economic values resulting from their studies are harmonized and summarized in Table 39. Pérez-Fortes et al. (2016) consider a gate-to-gate facility purchasing and processing carbon dioxide and hydrogen along with utilities to generate methanol. Conversely, Hank et al. (2018) and Zhang et al. (2019) study a gate-to-gate facility processing electricity to generate hydrogen on-site that is eventually reacted with carbon dioxide to produce methanol. In order to compare the studies on a fair basis, for these two references we subtracted the costs of the electrolyzer and applied its energy efficiency in order to retrieve the amount of hydrogen effectively used as input for the reaction [18].

Table 39: Comparison of the techno-economic performances of CO₂-to-Methanol processes

		Units	Pérez-Fortes et al. (2016)	Zhang et al. (2019)	Hank et al. (2018)
[1]	"Overnight" Capital Cost	\$/GJ _a	28.4	18.5	24.6
[2]	Total Capital Requirement	\$/GJ _a	30.7	20.0	26.6
[3]	Capital Recovery Charge Rate	%pa	10.6%	10.6%	10.6%
[4]	Fixed O&M	\$/GJ _a	1.3	1.0	1.0
[5]	Variable O&M	\$/GJ	0.04	0	0
[6]	Project Life	years	20	20	20
[7]	Capacity Factor	%	90%	90%	90%
[8]	Annual Capacity	PJ _a	8.8	2.0	0.9
[10]	Operating hours	h/y	7884	7884	7884
[11]	Capital Recovery Required	\$/GJ	3.2	2.1	2.8

[12]	FIXOM Recovery Required	\$/GJ	0.13	0.10	0.10
[13]	Total CO ₂ input	kt/y	642	150	57
[14]	CO ₂ input	t/GJ	0.073	0.075	0.064
[15]	CO ₂ cost	\$/t	100	100	100
[16]	Total CO ₂ cost	\$/GJ	7.3	7.5	6.4
[17]	Total H ₂ input	t/y	87,560	17,921	7,810
[18]	H ₂ input	kg/GJ	10.0	9.0	8.7
[19]	H ₂ cost	\$/kg	3	3	3
[20]	Total H ₂ cost	\$/GJ	30.0	27.0	26.0
[21]	Total fuel cost	\$/GJ	38	35	32
[22]	Total production cost	\$/t	819	732	703
[23]	Markup Over Regular Plant		2.05	1.83	1.76

In each study, the cost of energy (electricity or hydrogen) drives the overall cost of methanol. Once the capital cost of the electrolyzer is subtracted, the resulting capital cost of the CO₂ conversion plant is not that high.

The last indicator, called “Markup”, can be used to compare the production cost [27] with the market price of methanol, estimated at €400/t (Chauvy et al., 2019; Pérez-Fortes et al., 2016), and thus gives an insight on the relative economic performance of the proposed process for each reference. The differences between the three designs are not significant. However, the design by Hank et al. (2018) stands out from the other two due to its lower energy (H₂) and material (CO₂) requirements. Overall, the design by Pérez-Fortes et al. (2016) proves to be the most expensive, followed by the process by Zhang et al. (2019), whilst Hank et al. have the best performances.

As the possibilities to use methanol would be limited to the transport sector if MtG was not available, we add a process that converts methanol into gasoline through a so-called methanol-to-gasoline (MtG) process (Hennig and Haase, 2021). The process consists in dehydrating methanol in two steps with different catalysts, in order to recover a slate of fuels including gasoline (50%), LPG (38%), and fuel gas (12%), which is used in a CCGT to recover electricity both used internally (68%) and exported (32%). The reaction is highly exothermic, which requires cooling the reactor to 420°C, using electricity (Smith, 2011).

In addition, we model the blending of methanol with gasoline for the transport sector. We ensure that methanol can be blended with gasoline at a maximum of 15% of the volume (Methanol Institute, 2016), or 7.49% of the energy content.

7.2. CO₂ to methane

Methane (CH₄) is a colorless, nontoxic hydrocarbon, present in natural gas fields. Although it is emitted worldwide in lower proportions than CO₂, methane is a greenhouse gas whose impact in global warming is 28 times more potent than CO₂ (IPCC, n.d.). Emissions occur both when combusting hydrocarbons and extracting natural gas. Therefore, CO₂-to-methane technologies appear as attractive alternative pathways than could help reduce the emissions caused by natural gas extraction. Besides, due to recent geopolitical events, the price of natural gas has reached record highs, which may render alternative technologies more competitive.

To date, methane synthesis from CO₂ conversion is at a research and demonstration stage and is expected to reach commercial scale within 6 years (Chauvy et al., 2019). In Australia, CSIRO demonstrated the methanation of CO₂ with 99% selectivity and 96% converted CO₂ (Lippi et al., 2017). In France, the Jupiter 1000 project started operating a 25 m³/h capacity methanation unit (GRTgaz,

2018). Methanation, also called Power-to-Gas (PtG), is expanding rapidly following an exponential trend in North America and Europe (Thema et al., 2019).

Methanation consists in reacting CO₂ and H₂ to generate CH₄ molecules, in the presence of catalysts. The reaction occurs in three steps. The first one is the Sabatier reaction, where CO₂ directly reacts with H₂ to form hydrogen. The second and third steps consist in a Reverse Water Gas Shift (RWGS) reaction, where CO₂ is turned into CO, which eventually reacts with H₂:

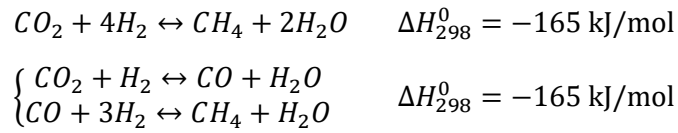

The reaction is highly exothermic, which requires recirculating heat loops and cooling the reaction bed to maintain the temperature at 350°C (Chauvy et al., 2021a). The gas produced by the abovementioned reactions is thus a mixture of CH₄, CO₂, H₂O, and H₂, whose shares depend on the operation of the reaction, but methane dominates. This gas is called synthetic natural gas (SNG) and requires upgrading, which involves dehydrating it and ensuring that the volumetric shares of each molecule respect the specifications of the grid into which the SNG will be injected. Therefore, upgrading raw SNG involves recirculating CO₂ and hydrogen into the reactor bed. Conceptually, hydrogen should be produced with electrolyzers running on renewable or low-carbon electricity. Thus, enhancing hydrogen into methane allows renewable energy to be stored. Figure 30 shows a simple block-flow diagram of how a methanation unit works. Here, we are interested only in the two blocks on the right together processing hydrogen and generating heat and SNG. Although water is a by-product, we do not pay attention to this commodity as it is not modeled in TIAM-FR.

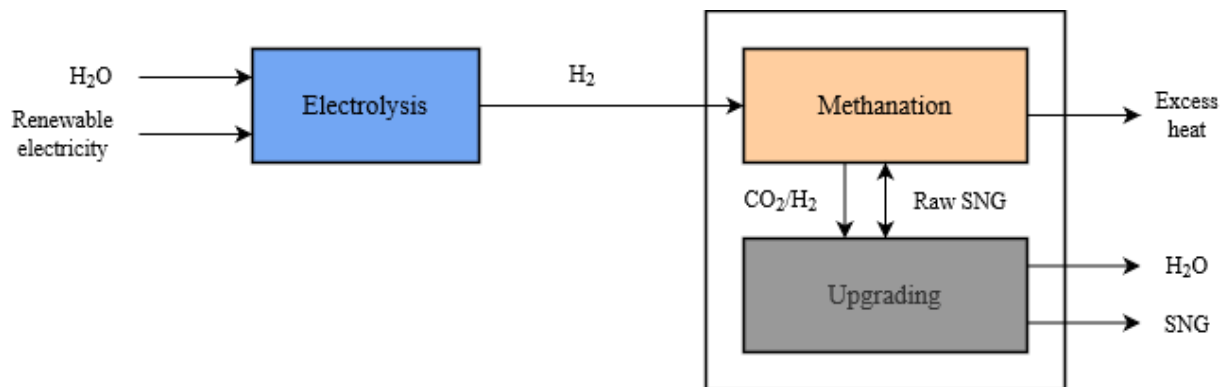

Figure 30: Conceptual block-flow diagram inspired from (Chauvy et al., 2020)

Techno-economic studies assessing the methanation reaction were collected for comparison before implementing them in the model (Table 40). (Chauvy et al., 2021a) studied the integration of a CO₂ methanation unit with a CO₂ capture unit installed at a cement plant. The authors take advantage of the excess heat from the methanation reaction by installing heat exchangers that return heat back to the CO₂ capture unit. (Gorre et al., 2019) optimized the operation of a plant by considering different types of electricity consumption, i.e. whether or not electrolysis and methanation should be operated simultaneously depending on the hourly price of electricity and gas, and using hydrogen and gas storage. (Szima and Cormos, 2018) proposed and optimized a design that uses excess heat to generate electricity from a steam turbine. In addition, the vapor in the output of the steam turbine is recycled, condensed, and used to cool the SNG and the methanation reactor.

Table 40: Comparison of the techno-economic performances of CO₂-to-Methane processes

Units	Chauvy et al. (2021)	Gorre et al. (2019)	Szima and Cormos (2018)
-------	-------------------------	------------------------	----------------------------

[1]	"Overnight" Capital Cost	\$/GJ_a	80.1	56.1	159.0
[2]	Total Capital Requirement	\$/GJ_a	86.5	60.5	171.7
[3]	Capital Recovery Charge Rate	%pa	10.6%	10.6%	10.6%
[4]	Fixed O&M	\$/GJ_a	6.5	1.03	3.2
[5]	Variable O&M	\$/GJ	0	0	0
[6]	Project life	years	20	20	20
[7]	Capacity factor	%	90%	90%	90%
[8]	Operating hours	h/y	7884	7884	7884
[9]	Capital Charge Recovery	\$/GJ	9.1	6.4	18.1
[10]	FIXOM Recovery Required	\$/GJ	0.68	0.11	0.34
[11]	CO ₂ input	t/GJ	0.0505	0.0550	0.0530
[12]	CO ₂ cost	\$/t	100	100	100
[13]	Total CO ₂ cost	\$/GJ	5.1	5.5	5.3
[14]	H ₂ input	t/GJ	10.0	10.7	9.4
[15]	H ₂ cost	\$/t	3.0	3.0	3.0
[16]	Total H ₂ cost	\$/GJ	30	32	28
[17]	Electricity input	kWh/GJ	0.63	0.33	0.65
[18]	Electricity cost	\$/MWh	100	100	100
[19]	Total electricity cost	\$/GJ	0.06	0.03	0.07
[20]	Total fuel cost	\$/GJ	35.1	37.6	33.4
[21]	Total production cost	\$/GJ	44.9	44.1	51.9
[22]	Markup Over Regular Plant		2.1	2.1	2.6

The bottom line of the selected studies is that costs are mainly driven by the cost of hydrogen – and implicitly electricity, and the cost of CO₂ capture. Capital cost is not important here, as we assume that the electrolyzer is outside of the scope. The cost of electricity to cool the methanation reactor and the upgrading process is negligible. Regarding the total production [21], studies have produced similar results. However, there are differences in the CAPEX intensiveness and the fixed operational costs, which do not make a substantial difference in the total production cost. Considering a price of natural gas equal to €17.7/GJ in 2021 (Eurostat, 2022) – or \$20.9/GJ – the SNG markup varies from 2.1 to 2.6. Whatever the configuration of the methanation process, producing SNG is more expensive than extracting natural gas. Chauvy et al. (2021) and Gorre et al. (2019) include the electrolyzer in the scope of their study, while we, in TIAM-FR, separate hydrogen generation from CO₂ utilization. Therefore, in the table below we do not consider this part of the process, but assume that H₂ is the input, along with electricity, which is used to run compressors and cool the reactor. In addition, the excess heat is considered as a by-product the model can use to run other processes in the energy system. This excess heat is independent from the process design, but stems from the exothermic property of the methanation reaction, such that a maximum of 185 MJ of heat can be recovered per GJ of methane produced, considering the energy density of methane (892 kJ/mol).

In TIAM-FR, methane is not modeled as an energy commodity *per se*, but is somehow included in the commodity representing natural gas. In addition, methane is modeled as an environmental commodity, *i.e.*, a contributor to global warming. The potential and costs of natural gas extraction are taken from

(Pye et al., 2020), and can be used in every sector. Therefore CO₂-to-methane processes can substitute much more energy in the global system in comparison to CO₂-to-methanol processes.

7.3. CO₂ to fuels

In this subsection, we explain our modeling of Fischer-Tropsch (FT) processes, which generate a slate of liquid fuels, mainly including diesel, gasoline, and jet fuels from hydrogen and CO₂. The CO₂ is first converted into CO through a RWGS reactor and then mixed with hydrogen to form a syngas that will react in the presence of a catalyst at temperatures between 150-200°C, following an endothermic reaction:

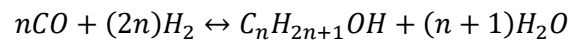

The products of the FT process are carbon chains whose output share depends on the catalyst and the temperature employed (Dieterich et al., 2020). Such processes are also called Power-to-Liquid (PtL) processes. Different designs of FT processes have been proposed in the literature.

(Schmidt et al., 2018) proposed to recover heat from the FT synthesis through a steam generator, which is used to run a solid oxide electrolysis cell (SOEC) at high temperature. The resulting hydrogen is then used in the FT reactor. The fuels are then upgraded through several steps including distillation, hydrocracking and isomerization to produce up to 60% of jet fuels suitable for aircraft (Schmidt et al., 2018).

(Schemme et al., 2018) develop a process that includes a RWGS reactor, a reformer, and an FT reactor with a cobalt catalyst, a hydrocracker, and a distillation column. They take advantage of the wax and gaseous hydrocarbons generated as by-products of the FT reactor along with diesel and jet fuel. The wax is recycled to the hydrocracker to generate additional fuel, and the short hydrocarbons go directly to an autothermal reformer (ATR) reacting with oxygen and vapor to generate hydrogen and carbon monoxide sent to the FT reactor. Besides, excess heat from the FT reaction is recycled towards the distillation column. The authors claim that there are no CO₂ emissions. The process claims to produce 38% jet fuel and the rest is diesel.

(Falter et al., 2016) consider a case-specific reactor that runs on solar energy for regions of the globe where direct normal solar irradiation is superior to 2,500 kWh/(m²a). The solar concentration assets are used to generate electricity and, for a DAC unit, an electrolyzer and an FT reactor. Short hydrocarbons are recycled to run a small CHP plant returning electricity and heat back to the FT reactor and the hydrocracking and distillation units. Therefore, emissions could occur if the CO₂ used is fossil. The authors considered other scopes where the CO₂ is imported from a power plant, and the electricity is from the grid. The output fuels are jet fuel (54%) and naphtha (62%).

(Zang et al., 2021) defined CO₂ capture and electrolysis as being outside of their scope. The CO₂ and hydrogen are imported and compressed separately, before being reacted in a RWGS and converted in a FT reactor. Hydrogen is also used for the hydrocracking process. Besides, part of the unreacted hydrogen is recycled in the FT reactor and sent to a boiler and a steam turbine to provide heat to the upgrade processes (hydrocracking and distillation). The boiler also uses light gases resulting from the distillation. Therefore, emissions could occur if the CO₂ employed is fossil. Jet fuel, diesel, and gasoline are all generated from this process, respectively comprising 47%, 27%, and 26% of the energy output.

(Marchese et al., 2021) investigated assorted designs for FT processes that mainly differ from the way the exhaust energy and light hydrocarbons are redistributed in the process, either to the DAC unit or the RWGS reactor, or both. But the scope of our work does not include the DAC unit, so 4 designs out of 5 are not of interest to us. Likewise, as hydrocarbons are recycled and burned to return energy back into the system, CO₂ emissions occur if the carbon is fossil. Jet fuel, diesel, and gasoline are all generated from this process, respectively comprising 27%, 37%, and 35% of the energy output.

(Albrecht et al., 2017) studied different PtL cases, including Biomass-to-Liquids (BtL). The design they propose is the most detailed of the 6 studies reviewed. They propose a design in which the gaseous fuels are recycled to an oxyfuel burner that generates heat and CO₂ for the RWGS reactor. Therefore, there are no additional CO₂ emissions. The authors do not explicitly detail the shares of fuel yield.

This literature review of techno-economic studies for FT processes revealed that there are several ways to design such a process. Consequently, the performances, i.e., their costs, energy consumption and material consumption, are affected as shown. For instance, the processes detailed by Albrecht et al. (2017) and Schemme et al. (2018) generating CO₂ for the RWGS reactor thus require much less CO₂ imports than the other designs. Overall, there are substantial differences between the different estimations of the techno-economic performances. Looking at the markup – which was calculated according to the reference cost of \$10/GJ (Zhou et al., 2022) – it is quite clear that the first three references are more optimistic than the last three, especially in terms of capital investments.

Table 41: Techno-economic performances of Fischer-Tropsch processes

	Parameter	Units	Schmidt et al. (2018)	Schemme et al. (2018)	Falter et al. (2016)	Zang et al. (2021)	Marchese et al. (2021)	Albrecht et al. (2017)
[01]	"Overnight" Capital Cost	\$/GJ_a	18.5	52.3	30.7	107.7	83.0	74.6
[02]	Total Capital Requirement	\$/GJ_a	20.0	56.5	33.1	116.3	89.7	80.6
[03]	Capital Recovery Charge Rate	%	10.6%	10.6%	10.6%	10.6%	10.6%	10.6%
[04]	Fixed O&M (FIXOM)	\$/GJ_a	0.9	5.42	2.1	5.5	2.9	4.3
[05]	Variable O&M (VAROM)	\$/GJ	0	0.00	0.11	1.7	0.3	0.9
[06]	Project Life	years	20	20	20	20	20	20
[7]	Capacity Factor	%	90%	90%	90%	90%	90%	90%
[8]	Annual Capacity	PJ/y	0.8	8.7	2.3	5.15	9.7	4.3
[9]	Capital Recovery Required	\$/GJ	2.1	6.0	3.5	12.3	9.5	8.5
[10]	FIXOM Recovery Required	\$/GJ	1.0	6.0	2.3	6.1	3.2	4.7
[11]	CO ₂ input	t/GJ	0.073	0.069	0.090	0.152	0.172	0.066
[12]	CO ₂ cost	\$/t	100	100	100	100	100	100
[13]	Total CO ₂ cost	\$/GJ	7.3	6.9	9.0	15.2	17.2	6.6
[14]	H ₂ input	kg/GJ	12.4	10.9	9.0	14.3	10.2	10.1
[15]	H ₂ cost	\$/kg	3	3	3	3	3	3
[16]	Total hydrogen cost	\$/GJ	37	33	27	43	31	30
[17]	Total fuel cost	\$/GJ	44.5	39.5	36.1	58.2	47.9	37.0
[18]	Total production cost	\$/GJ	47.7	51.5	42.0	78.3	60.9	51.2
[19]	Markup Over regular plant		4.8	5.1	4.2	7.8	6.1	5.1
[20]	Direct CO ₂ emissions	kgCO ₂ /GJ	0	0	7	22	32	0
[21]	Share of jet fuel	%GJ	100%	38%	54%	47%	27%	N/A
[22]	Share of gasoline	%GJ			46%	26%	37%	N/A
[23]	Share of diesel	%GJ		62%		27%	35%	N/A

The following figure compares the cost shares and main contributors of FT processes according to the studies and their designs.

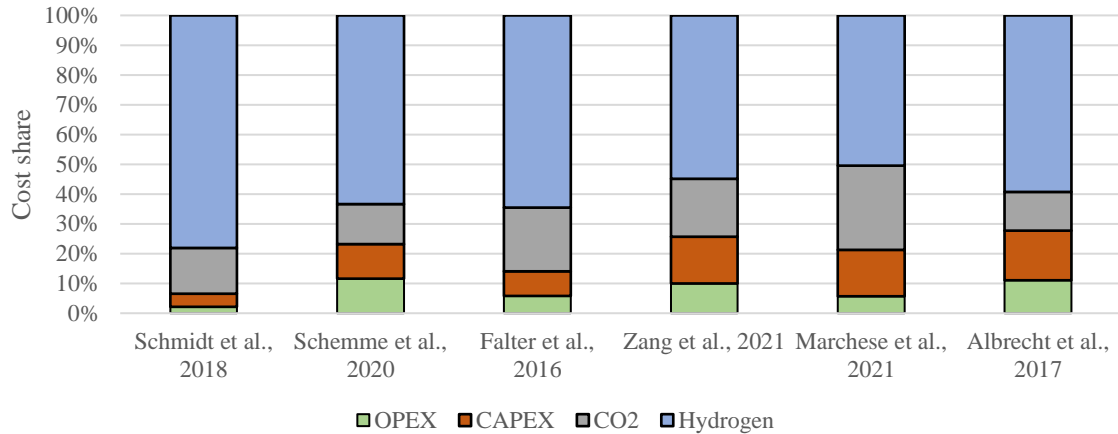

Figure 31: Costs shares of Fischer-Tropsch processes from different studies

Now that the costs have been studied, the next two subsections explain how FT processes were implemented both in TIAM-FR and EPPA.

7.3.1. Modeling in TIAM-FR

In TIAM-FR, the output energy commodities involved in FT processes reflect the reality, i.e. gasoline, naphtha, jet fuel, and diesel are explicitly declared in the model. They are produced by the extraction and refining of crude oil, so FT processes can behave as alternative refineries. They are obviously particularly important for the transport sector, but also for industry. As previously assumed for CO₂-to-methanol and CO₂-to-methane processes, we consider only two inputs for FT processes, i.e., hydrogen and CO₂ (Figure 29).

7.3.2. Modeling in EPPA

Before implementing a CO₂ conversion unit in EPPA, several tasks need to be accomplished, especially because EPPA does not model hydrogen. Therefore, we had to review the scope of the FT process, compared to what was done in TIAM-FR, and include the electrolyzer in the scope of the process modeled. We chose to consider a PEM electrolyzer with the same techno-economic properties as the one described in Section 3. Thereby, the energy input is not hydrogen here but grid electricity or Variable Renewable Electricity (VRE), as Figure 32 shows, and so Table 41 was adapted accordingly.

The production of jet fuels – and other oil commodities – through the FT process in EPPA combines CO₂, electricity, capital and labor, and the so-called Technology-Specific Factor (TSF) using a series of nested CES functions, as illustrated in Figure 32. We represent trade-off possibilities among products using a sequence of nested constant elasticity of transformation (CET) functions. We assume that there is no trade-off for the product slate, meaning that the chemical behavior of the FT plant is constant and always delivers the same share of fuels. The FT process of EPPA is assumed to behave in the same ways as the process implemented by (Zang et al., 2021), with 47% jet fuels and 53% refined oil (EPPA does not differentiate diesel and gasoline). We also assume that there is no trade-off between CO₂ and electricity, i.e. the process cannot perform energy or material efficiency to optimize the use of CO₂ or electricity. However, we consider a value-added elasticity equal to 1 (Balistreri et al., 2003; Hertel, n.d.). The TSF was introduced by (Morris et al., 2019b) to represent the penetration of a backstop technology. This factor is required to operate the FT process, but its supply is limited, especially at the early stage (see Chapter 2). As is standard in EPPA, we apply the markup shown in Table 41 to the output of our FT process, which determines the cost of e-fuels compared to a conventional process. In addition, the cost shares of Figure 31 were used to represent the weight of each input in the total cost.

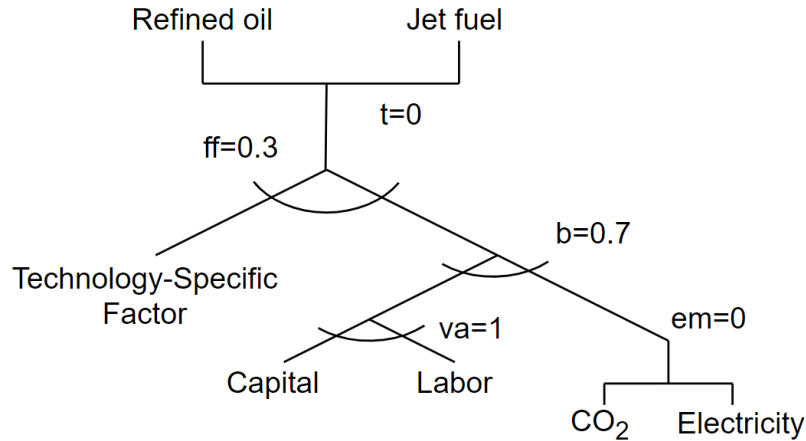

Figure 32: Nesting structure of Fischer-Tropsch process in EPPA

As Figure 29 shows, CO₂ emissions are accounted for if the CO₂ used is fossil. In EPPA, the CO₂ can be sourced from the industry sector, bioenergy with carbon capture, or direct air capture.

This work was carried out together with the MIT Joint Program on the Science and Policy of Global Change. Dr. Sergey Paltsev, Senior Research Scientist, Dr. Angelo Gurgel, Research Scientist, Dr. Jennifer Morris, Principal Research Scientist, and Howard Herzog, Senior Research Engineer, provided their expertise on energy modeling and CCUS technologies.

7.4. CO₂ mineralization

Carbon mineralization refers to the inorganic reaction that transforms gaseous CO₂ into solid carbonates. The transformation is considered permanent since the decomposition of carbonates cannot occur without considerable energy input, and because carbonates are thermodynamically stable. Besides, carbonates are environmentally benign (NPC, 2019c). A typical carbonation reaction consists in reacting a metal oxide (MO) with CO₂:

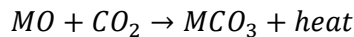

In nature, this chemical reaction rarely occurs due to the elevated temperatures required. But, as an example, limestone (CaCO₃) is a calcium carbonate naturally present in nature, e.g. rocks, shells, and pearls. In the presence of water, more complex reactions occur with silicates such as serpentine and olivine (Neeraj and Yadav, 2020):

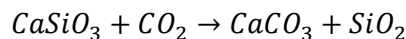
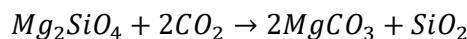

Thus, the two most common products of CO₂ mineralization are calcium carbonate (CaCO₃) and magnesium carbonate (MgCO₃). These inorganic compounds are vital to numerous living beings because of the metals they contain, which are essential for vertebrate animals to grow bones. But calcium carbonate and magnesium carbonate also have industrial applications that may result in carbon release (Woodall et al., 2019).

Given the modeling scope of TIAM-FR, we are only able to model the use of carbonates for aggregates in the cement industry, i.e., aggregates are mixed with clinker to form ready-to-use cement (see Section 5.1). Indeed, the paper industry and chemical industry – for which we could have considered to model carbonates utilization – are regrettably too implicitly modeled to be envisioned as a carbonate consumer, as only energy flows are considered and not material flows. Another barrier to modeling CO₂ mineralization is the availability of the metal oxide. In TIAM-FR, there is no explicit source of CaO or

MgO. However, steel slags are outputs of some processes in the iron and steel industry, in particular blast furnace processes (see Section 5.2).

We found no proper techno-economic study of CO₂ mineralization in the literature. However, we found separate references that either assess the technical feasibility (Meng et al., 2021; Sanna et al., 2014; Siriruang et al., 2016) or the cost of mineralizing CO₂ (NASEM, 2019a; Sanna et al., 2014). For slags, an average of 443 kt of CO₂ are required to produce 1 Mt of mineral, along with 400 kWh of electricity and 354 kWh of heat per ton of CO₂ sequestered. We assume that the mass of the mineral in the output equals the sum of the mass of CO₂ and slag in the input.

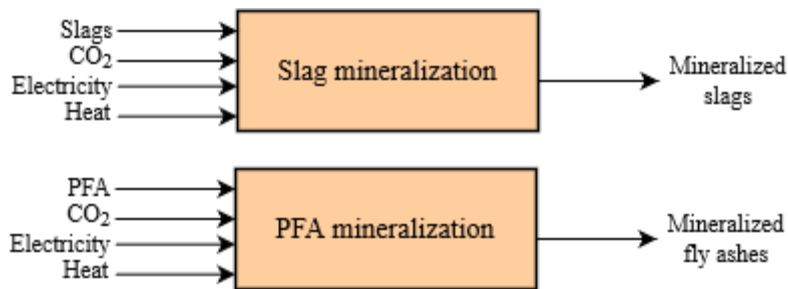

Figure 33: Input/output flows in CO₂ mineralization processes.

In addition, we considered the modeling of fly ash mineralization. Fly ash – or pulverized fly ash (PFA) – is a polluting residue from coal combustion. These pollutants must be removed from the flue gas before entering the capturing unit of a coal power plant, as they could damage the amine reactant. Therefore, we assume that PFA becomes an output of coal power plants equipped with capture units, and that they can be used to sequester CO₂ through the following process (Figure 33). Similar to slags, we assume that the mass of the mineral in the output equals the sum of the mass of CO₂ and PFA in the input. According to (Huijgen et al., 2006), 150 kt of CO₂ are required to produce 1 Mt of PFA. We assume that the same amounts of electricity and heat are required, in line with slag mineralization.

In Figure 33, emissions reduction is respectively allocated to the industry sector and the electricity sector for slag and PFA mineralization, as these mineral wastes are generated from those sectors.

NASEM estimates that the cost of mineralizing CO₂ with steel slag is \$75-100/tCO₂ and \$40-250/tCO₂ for PFA (NASEM, 2019a). Thus, there is substantial uncertainty behind these costs, especially since there is also uncertainty regarding the quantity of CO₂ needed to mineralize either PFA or slags. We consider three cost scenarios for CO₂ mineralization, i.e., the lower bound, the upper bound, and the average of the aforementioned costs. For the sake of simplicity, we do not include the CO₂ ratio uncertainty.

8. CO₂ transport and storage

8.1. Initial representation and limits

Originally, CO₂ transport and storage (CO₂TnS) was implemented in the model as part of the CCS chain, enabling to avoid fossil emissions and generate negative emissions. We describe here how CO₂TnS was encoded, and why we chose to review the modeling.

Ten types of geophysical well were initially modeled in TIAM-FR:

- Depleted oil fields onshore (SINKDOO) and offshore (SINKDOF)
- Depleted gas fields onshore (SINKDGO) and offshore (SINKDGF)
- Deep saline aquifers onshore (SINKDSA) and offshore (SINKDSO)
- Enhanced oil recovery sinks onshore (SINKEOR) and offshore (SINKEOF)
- Enhanced coal bed methane recovery sinks <1000m (SINKCB1) and >1000m (SINKCB2)

The RES of CO₂TnS was built as described in Figure 34. A SubRES contains different CO₂ capture technologies for the power sector that generate three outputs: electricity, carbon dioxide (ELCCO₂N), and captured CO₂ (SNKELCCO₂ or SNKTOTCO₂). ELCCO₂N refers to emissions of fossil CO₂ while TOTCO₂ refers to emissions of biogenic CO₂ (or climate-neutral CO₂), which is also used to aggregate all sectoral CO₂ emissions. As it was implanted in the first place, the amount of ELCCO₂ equals the quantity of fossil fuel burnt multiplied by its emission factor. The amount of SNKELCCO₂ (resp. SNKTOTCO₂) equals the quantity of fossil fuel burnt (resp. biomass) multiplied by its emission factor and the capture efficiency of the unit.

$$ELCCO2N = Fuel [PJ] \times Conversion\ factor [ktCO2/PJ]$$

$$SNKELCCO2 = Fuel [PJ] \times Conversion\ factor \left[\frac{ktCO2}{PJ} \right] \times capture\ efficiency [\%]$$

Consequently,

$$SNKELCCO2 = ELCCO2N \times capture\ efficiency [\%]$$

The storage processes have 3 commodities as an input, and none as an output. When one kt of captured CO₂ enters the storage process, the same quantity of CO₂ – which has been emitted upstream – is effectively removed here. In addition, the storage process consumes a so-called *dummy* commodity in the same proportions (1 ktCO₂). This commodity, representative of the cost of CO₂ transportation, is generated from dummy processes. For each type of CO₂ well, these processes embed the potential of CO₂ storage for each region of the model. Many references could be used to represent the cost of CO₂ transport and storage and the potential for CO₂ storage, as described in (Selosse, 2019).

The CO₂ storage wells (SINK*) behave as new technologies for the model to invest in and reduce CO₂ emissions, according to their capital cost, as well as their fixed and variable costs (for storing CO₂ only), discount rate, and lifetime, with no reference associated with the number implemented. No capital costs are considered for CO₂ transport infrastructures, but levelized costs are used instead.

The existing representation of CO₂TnS appears tedious since it requires CO₂ storage wells to be both sector-specific and CO₂-specific. As our work consists in implementing CO₂ capture opportunities in the industry and supply sectors, this representation would involve duplicating these processes for each sector and each type of CO₂, making the RES highly disaggregated, thereby the management of the processes and the interpretation of the results would have been too complex. Besides, the following paragraphs of this section demonstrate that the need to disaggregate CO₂ sink types is quite limited given the state of the knowledge. Furthermore, we believe that the existing modeling can be improved in terms of transparency and explicitness since the sectors (e.g. power sector) that can invest in CO₂ capture units (e.g. a coal-fired power plant with post-combustion capture) emit more CO₂ than they actually do for their scope 1, but the deduction occurs when the commodity SNKELCCO₂ enters the storage process. Firstly, this may result in problems accounting for CO₂. Secondly, in reality, the capture unit effectively prevents the ELCCO₂ from being emitted at the level of the capture unit. Finally, owing to recently published data on CO₂ transport and storage, the costs and potential of CO₂ transport and storage need updating, as the data used are either too old, or not properly referenced.

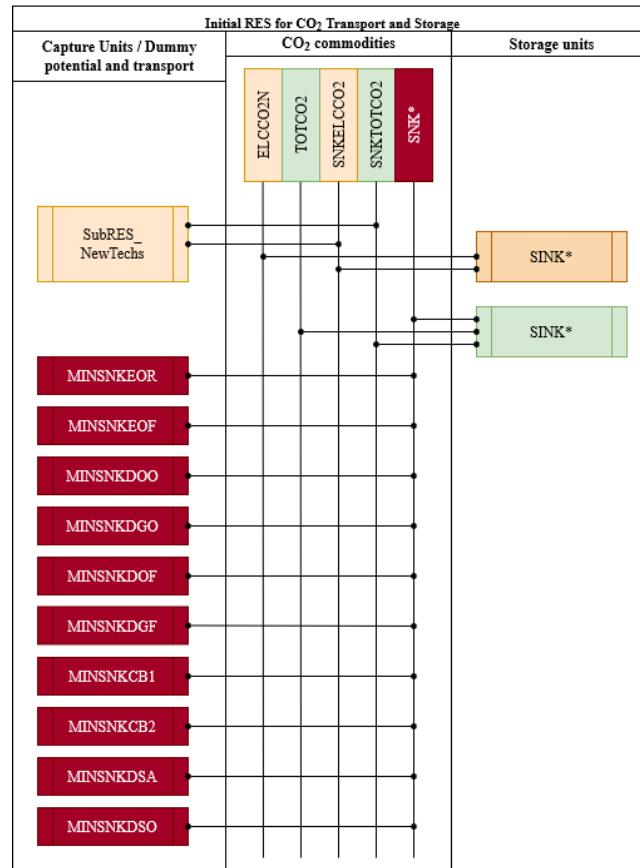

Figure 34: Initial RES for CO₂ Capture Transport and Storage

8.2. Literature review of CO₂ transport and storage: costs and potentials

In this section, we explain how the literature review and our consultation of experts¹⁰ have warned us against the high values available in the global estimations of the literature, which are nonetheless essential for characterizing the potential for CO₂ storage in IAMs.

8.2.1. CO₂ storage potentials

Overall, the potentials for CO₂ storage stated in the literature and used in the models are estimations, not measurements. We speak respectively of resources and reserves when potentials are estimated and when they are proven by *in situ* studies. To date, only one reference has listed proven reserves (Pale Blue Dot., 2021); they can be viewed on an interactive map of the OGCI (OGCI, 2020). This map shows the storage sites and details that have been assessed for a specific storage project. These are proven reserves, and the aggregated values can be found in the third column of Table 42. The values are higher in the second column because it includes the potential estimated by both projects and scientific studies.

Table 42: Estimations of global potential for CO₂ storage (Pale Blue Dot., 2020)

*The aggregated resource represents the summed storage resource across all maturity classes and as such should not be viewed as representative of the global potential

Classification	CO ₂ storage resource (Gt)	
	Project and no project	Project specified
Stored	0.028	0.028
Capacity	0.106	0.106

¹⁰ The experts consulted include Dr. Sylvain Thibeau, expert in CO₂ geological storage at TotalEnergies, Dr. Mahmoudreza Jazayeri Noushabadi, Senior reservoir engineer at TotalEnergies, Howard Herzog, Senior research engineer at Massachusetts Institute of Technology, and Dr. Solène Chiquier, Postgraduate associate at Massachusetts Institute of Technology.

Sub-Commercial	408	65.59
Undiscovered	11,859	18.92
Aggregated*	12,267	84.77

These potentials correspond to the sum of country-based potentials that have been assessed in dedicated projects in the USA, Canada, the United Kingdom, Norway, China, South Korea, Indonesia, Japan and Australia. Therefore, in the current state of knowledge, the potential for CO₂ storage is localized and relatively low (between 66 and 408 GtCO₂), considering that storage needs to reach carbon neutrality (IEA, 2021)¹¹. It is likely that storage potentials are higher, but estimates vary greatly depending on the references (Consoli and Wildgust, 2017; Dooley, 2013; Hendriks et al., 2004; Kearns et al., 2017; Selosse, 2019) and on the scope of the study, *i.e.* the type of storage considered, the geological characteristics (porosity, permeability), and the methodology adopted (Thibeau et al., 2014). Indeed, a simple method to estimate the storage potential in saline aquifers is to refer to the following equation, where V is the volume of the saline aquifer, ρ is the density of CO₂ (subject to pressure P , and temperature T) and E is the storage efficiency factor which can vary from 0.1 to 5 or even 10 depending on the study.

$$\text{Storage capacity} = V * \rho(P, T) * E$$

Consequently, the potential is very sensitive to the factor E , which may explain high values in the estimation of potentials that are observed with distance and sometimes considered as overestimated. In this regard, a recent study demonstrated that the potential of a saline aquifer storage has been re-evaluated at about 300 Gt against more than 923 Gt initially, due to initially over-optimistic assumptions (Thibeau et al., 2022).

In the literature, there is no global potential for geological storage of CO₂ with a high confidence index, due to estimation methods that are not unanimously accepted. The only studies we have at the global level are estimates which, moreover, do not necessarily deal with the technical feasibility of injection, *i.e.* brine treatment, overpressure problems, seismic risks, injection rate, etc. For this reason, summing these potentials in order to obtain an overall potential is discouraged (Consoli and Wildgust, 2017). Therefore, we can only rely on existing estimations, the results of which are as follows:

Table 43: Studies and CO₂ storage potentials updated from (Selosse and Ricci, 2017)

Study	Scenario	Potential [GtCO₂]
(Hendriks et al., 2004)	Low	561
	Best	1,557
	High	4,823
(Dooley, 2013)		9,961
(Kearns et al., 2017)	Low	7,908
	High	55,581
(Consoli and Wildgust, 2017)	Low	8,735
	High	30,846
Proven reserves (Pale Blue Dot., 2021)		408

Although these estimates may seem unrealistic to some experts, others instead assume that they are underestimated. Consider the study by (Kearns et al., 2017), which estimates storage potential as between 7,000 and 55,000 Gt worldwide. Because this study only assesses saline aquifers and ignores other storage opportunities, it is possible that these potentials are underestimated. In particular, hopes are being pinned on basaltic CO₂ storage (Goldberg et al., 2018; IEAGHG, 2011), whose potentials are

¹¹ The report does not provide the cumulative amount of CO₂ stored. We estimated the value as around 115 GtCO₂, based on Figure 2.21 of their report.

not well known. Nevertheless, we are aware of the issues and limitations related to the estimation of geological CO₂ storage resources and reserves.

8.2.2. Costs of CO₂ transport and storage

In recent years, the costs of CO₂ storage have been investigated in detail. Researchers have proposed various estimations depending on the onshore storage characteristics of the well, the region where the well would be operated, and the type of geophysical well.

We selected three recent references of importance in assessing storage costs:

- (Pale Blue Dot Energy, 2016), which estimates the costs and potentials of offshore storage in the UK. The methodology, data, and results are available in a report.
- (NETL, 2017), which estimates in detail the techno-economic performance of onshore saline aquifer storage in the US. The authors make their cost model available.
- (Smith et al., 2021b), who estimate the costs of onshore storage worldwide, based *inter alia* on the aforementioned reference.

All of the above give disaggregated costs in terms of investment and operation, while older references tend to give aggregated discounted costs per ton of CO₂ stored. The data show that the aggregate costs of CO₂ transport and storage are in fact mostly borne by storage, especially onshore.

The aforementioned publications show that depth and reservoir capacity are the two most important parameters in the cost of storage. It can be seen that both are of the same order of magnitude, which is why storage costs in saline aquifers are considered to be comparable to those in depleted gas fields. This is because saline aquifers are generally shallower than depleted gas fields and have much greater storage capacities. These advantages outweigh the capital costs of drilling wells and monitoring the site, which are generally already present in the case of depleted gas fields. As far as offshore storage is concerned, there is only one reference that compares costs with onshore storage (Hendriks et al., 2004) to our knowledge. The difference can vary from double to triple depending on the depth of the reservoir, for the same injection capacity (Table 44).

Table 44: Cost estimation for CO₂ storage operations as mentioned in (Hendriks et al., 2004)

	Depth of storage (m)		
	1000	2000	3000
Aquifer onshore	1.8	2.7	5.9
Aquifer offshore	4.5	7.3	11.4
Natural gas field onshore	1.1	1.6	3.6
Natural gas field offshore	3.6	5.7	7.7
Empty oil field onshore	1.1	1.6	3.6
Empty oil field offshore	3.6	5.7	7.7

Values are in €/MgCO₂

More recent references estimate a difference of 50 to 100% more expensive offshore than onshore (CO₂Europe, 2011; Smith et al., 2021b). These additional costs are mainly due to the higher drilling costs offshore, although monitoring is less expensive than onshore because the sensors can be installed anywhere at sea, whereas onshore must deal with the hazards of the terrain (relief, protected areas, human infrastructure, housing, acceptability, etc.).

Furthermore, one can differentiate between open saline aquifers and closed saline aquifers. Each is distinguished by the shape of its reservoir (concave or not) and the other geological formations that surround it. If the reservoir is surrounded by impermeable rocks, then the reservoir is closed. This difference is significant in the treatment of brine and with respect to injection conditions. Indeed, in the case of a closed aquifer, the injection pressure must be low so that the reservoir can absorb the overpressure progressively and avoid seismic risks or leaks. In the case of open reservoirs, leakage is inevitable by nature. The brine can then either migrate to other geological formations; spill into the

ocean with harmful impacts on ecosystems; migrate to groundwater; or be pumped to the surface to be desalinated at extremely high cost because of the brine's very high salinity. The risks are therefore greater in the case of open saline aquifers, although they may potentially contain more CO₂ than closed aquifers, and thus present costs of the same order of magnitude.

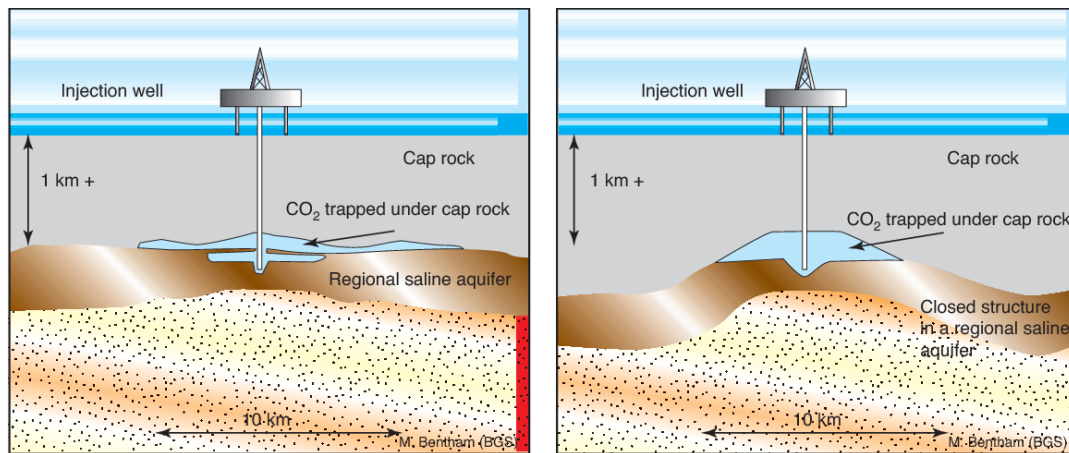

Figure 35: Open saline aquifers (left) and closed saline aquifers (right) (Bentham et al., 2014)

To summarize, recent estimations evaluate the cost of storing CO₂ as follows:

- onshore: \$5-20/tCO₂ according to the injection capacity and the depth of the well
- offshore: \$10-30/tCO₂ per ton according to the injection capacity and the depth of the well

It is also important to mention that:

- the cost of storing CO₂ in depleted field is not necessarily cheaper compared to saline aquifers, even though the well has already been drilled;
- the nature of the saline aquifer (closed or open) plays a key role.

Regarding the costs of transporting CO₂, research focuses on the competition between shipping and pipelines, notably the incremental cost of transporting CO₂ offshore compared to onshore.

Several studies evaluate the best way to transport CO₂ offshore – either pipelines or shipping – both in economic and environmental terms (Bjerketvedt et al., 2020; IEAGHG, 2020; Roussanaly et al., 2017, 2013; ZEP, 2011). A first determining parameter in the cost assessment is the transport capacity. Between 1 and 5 Mtpa, costs can be reduced by a factor of 3 by pipeline and about 1.5 by ship as Figure 36 and Figure 37 show.

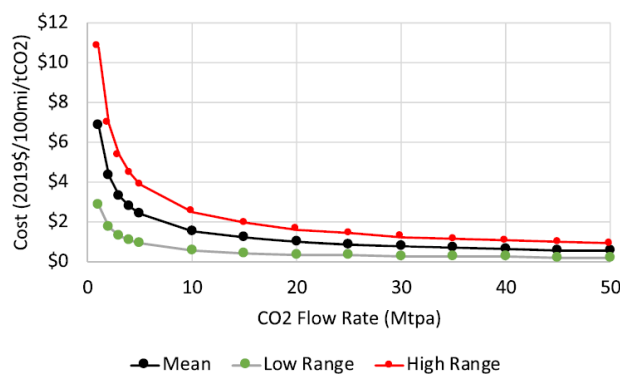

Figure 36 : Cost of onshore CO₂ transport depending on CO₂ flow rate (Smith et al., 2021b)

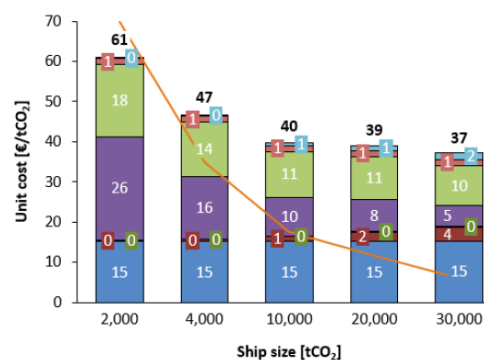

Figure 37 : Cost of offshore CO₂ transport depending on CO₂ ship size (IEAGHG, 2020)

The other determining parameter in the evaluation of costs is the distance. It is estimated that the ship becomes more competitive than the pipeline for distances between 500 and 1,000 miles and beyond,

due to the substantial capital cost of pipelines, which represent about 80% of the discounted cost, compared to 25% for ships (IEAGHG, 2020). In addition, the risk is different: if the CO₂ storage project fails, ships can be reused to transport other goods, whereas pipelines have a captive use.

In most models, it is assumed that the aggregated cost of CO₂ transport and storage equals \$10/tCO₂, which has been recognized as a reasonable assumption for onshore storage (Smith et al., 2021b) as long as the infrastructure offers high transport and injection capacities. For the European Union, estimates vary from around €10/tCO₂ (Pale Blue Dot Energy, 2016) to more than €60/tCO₂ (IEAGHG, 2020).

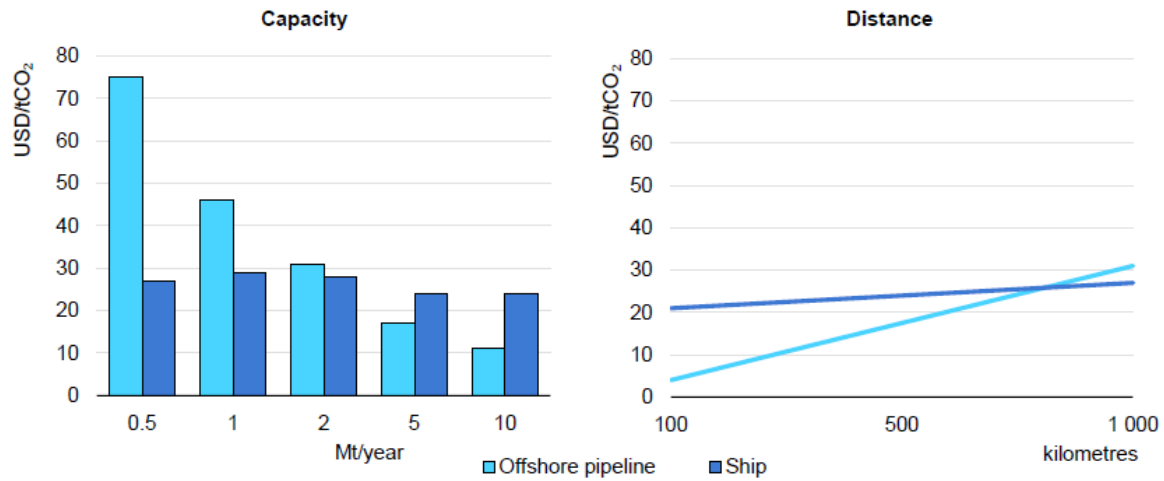

Figure 38: Competition between pipeline and shipping to transport CO₂ (IEAGHG, 2020)

In conclusion, it is a difficult exercise to model CO₂ transport and storage as there are very few references that standardize and generalize the costs and potentials of transport and storage. In the literature, most studies focus on either one project, one type of transport or storage, one region, or several at once. However, we have been able to propose something standardized and more realistic than the initial modeling, thanks to the research and results of Smith et al. (2021b).

8.3. New modeling of CO₂ transport and storage

In view of the shortcomings of the initial version and the findings of the literature review, we decided to review both the modeling and data of CO₂ transport and storage.

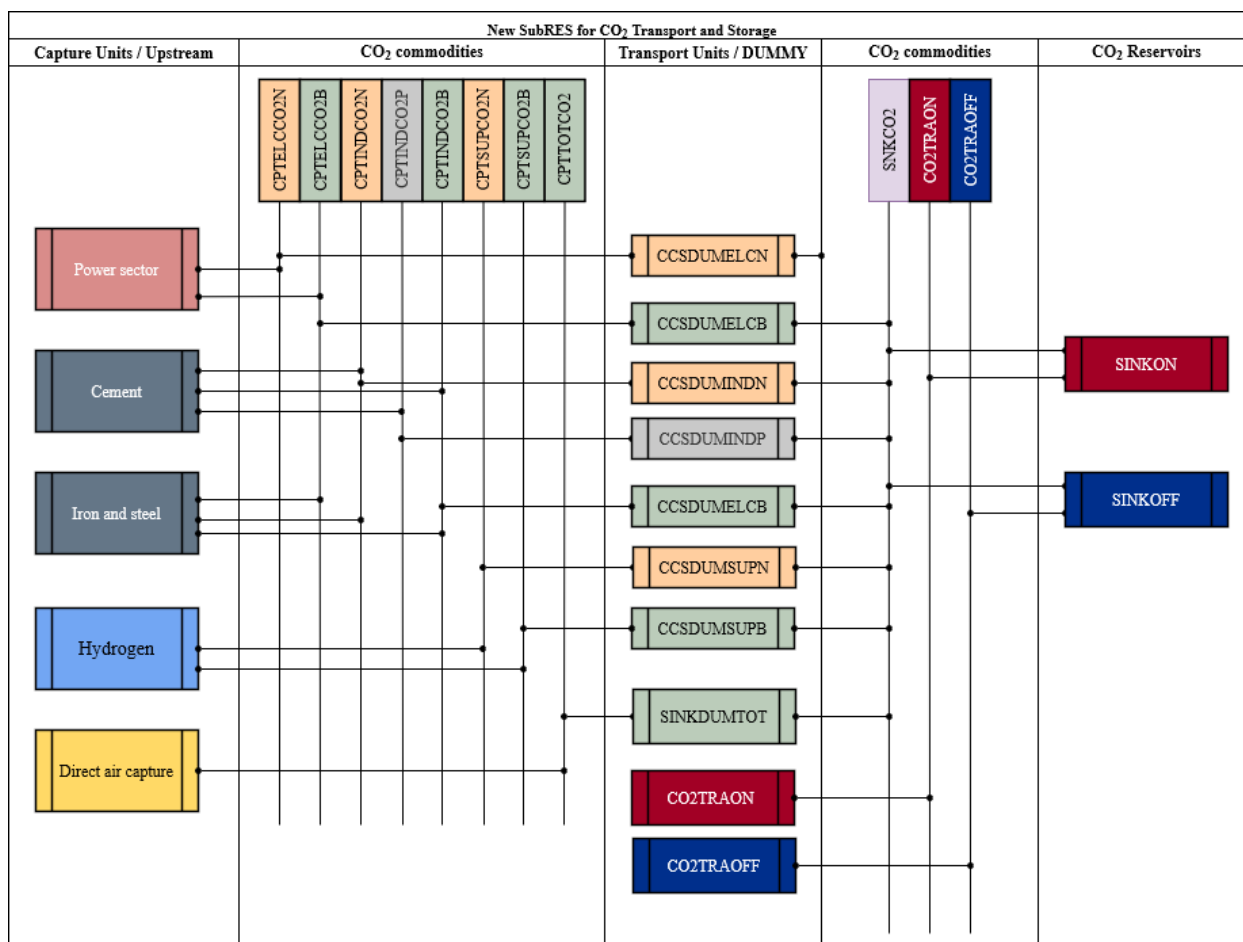

Figure 39: New SubRES for CO₂ transport and storage

In TIAM-FR, we chose to employ the regional CO₂ storage potential used in (Kearns et al., 2017) and in the EPPA model, for two reasons; firstly, it is practical and consistent to run the two models on this common basis; secondly, this is the most recent estimation of CO₂ storage potential that is also used in the IEA-ETP energy model (IEA, 2021e). The following paragraphs explain our choice.

First, CO₂ capture opportunities have been added to the model, as discussed in sections 2, 3, 4, 5, and 6, which correspond to new or updated sectors (e.g. cement, hydrogen, etc.) delivering three types of CO₂ commodity: fossil, process, or climate-neutral CO₂. In Figure 39, they are respectively colored in orange, grey, and green. Dummy processes labeled generically CCSDUM???X¹² aggregate all captured CO₂ types into a single commodity called SNKCO₂, as described also in Section 1. We apply a COM_BNDNET constraint on the SNKCO₂ commodity, which forces the model to balance the output and input of SNKCO₂ to zero (see Section 1). This guarantees that the CO₂ is effectively stored whether in an onshore well (SNKON) or offshore well (SNKOFF). Indeed, we decided to aggregate the CO₂ storage potential into onshore and offshore options only, without worrying about the type of geophysical well, e.g. saline aquifer, depleted field, etc. This choice stems from the opinions of the experts reviewed, who claim that no one can tell, for now, what type of CO₂ storage is statistically cheaper, although they propose different estimations for an average cost of CO₂ storage.

We are now left with only two storage processes: onshore and offshore, in comparison with the ten processes initially present. We left aside the option of considering EOR, as we were discouraged from modeling it for the following reasons:

¹² The suffix of the label corresponds to the sector ??? and the type of CO₂.

- It is difficult to determine both present and future storage potentials. Recent literature does not talk about the amount of CO₂ that can be stored in EOR but rather the number of barrels that can be recovered via EOR.
- The behavior of an EOR field is very case-specific depending on the geology of the well impact key parameters such as:
 - The amount of CO₂ that can be injected,
 - The amount of CO₂ that remains in storage out of that which rises to the surface with the oil,
 - The achievement of a steady state where CO₂ no longer needs to be brought in and the oil is simply recovered by recycling the CO₂.
- Operating costs are also difficult to determine because of the parameters listed above.

Regarding the transport of CO₂, we have two processes for transporting CO₂ onshore and offshore, at a cost that are defined by user-designed cost curves, as proposed in the WITCH model (Marcucci et al., 2017). Initially, we aimed to disaggregate the transport on the technological level, i.e., between pipeline and ship. Indeed, the interest of a model from the TIMES family is to be able to differentiate the processes according to their technology in order to better choose them to resolve the problem according to their technical-ecological characteristics. In this case, the following factors differentiate the costs of transporting CO₂ by offshore pipeline or ship:

- The distance covered.
- The fuel consumption of the ship.
- The transport capacity (costs are drastically reduced if 2 Mtpa is transported instead of 1 Mtpa).

Therefore, at some point, the model must be able to understand the distance from capture to storage in order to choose between pipeline and ship. However, this requires knowledge of:

- The offshore storage potentials according to the distance from the coast.
- The location of the capture sites.

All of this would be possible if the model was geonormalized, i.e., if it could choose to make investments located at a precise position. This is not the case. We therefore abandoned this idea and simply differentiate the cost difference between onshore and offshore storage, no matter how technically the shipping is achieved. In terms of cost of transport and storage, we use the work of (Smith et al., 2021b) to represent the costs with different assumption levels (high, medium and low). Similar to storage, these are the most recent estimations of CO₂ storage costs for global energy models, and also used in the EPPA model.

To realistically model the operations of CO₂ storage, we introduced a constraint on the CO₂ injection rate that is consistent with the average injection rates of a well over its economic lifetime. We express this constraint as a ratio of the annual average injection rate to the total capacity of the well:

$$\text{ratio of injection rate} = \frac{\text{average injection rate [Gt/y]}}{\text{capacity of the well [Gt]}}$$

To calculate this ratio, we used the data published by (Jahediesfanjani et al., 2018) that estimated the injection rate per well and basin, along with their storage capacity. This results in a ratio equal to 2.6% which was used as an ACT_BND constraint to the SINK processes in order to limit their annual operation with an acceptable injection rate.

Finally, we consider that the exchange of captured CO₂ between countries is allowed by international regulations under the London Protocol (IEAGHG, 2021c). As some of the regions in the model are country-aggregated (e.g., WEU, AFR, CSA, etc.), it is important to assume that countries can store CO₂ in a different country from where it was emitted and captured.

9. Shared Socioeconomic Pathways

In order to consider plausible energy demand projections, we explored the exogenous data that drive the TIAM-FR model in terms of future energy and material demands. As explained in Chapter 2, the model uses base-year demands projected over the entire 21st century from the following formula:

$$Demand_{r,t} = Demand_{r,t-1} \times driver^{elasticity_{r,t}}$$

Therefore, it requires assuming two important things:

1. The socio-economic driver according to which each demand evolves. This could be GDP, population, GDP per capita, number of households, or GDP per household. In Chapter 2, Table 1 gives the attribution of each demand to its driver based on previous works (Anandarajah et al., 2011).
2. The elasticity of each demand to its own driver, depending on the region and time. This elasticity represents the degree of decoupling between the demand and its driver (Loulou and Labriet, 2008).

When we first handled the model, we explored the values of the aforementioned elasticities and realized that they were not referenced and that they were all decreasing linearly from 1 to 0.8, whether the region belongs to the OECD or not, but independently of the driver. This assumption raises a problem of realism, as energy and material demands are known to behave differently from the evolution of their driver, *e.g.* iron and steel demand as well as cement demand show different historical decouplings with GDP per capita (Neelis and Patel, 2006; van Ruijven et al., 2016). More importantly, this modeling involves the fact that energy and material demands do not depend on a climate policy, such that the comparison of a *Business As Usual* scenario and a net-zero emissions scenario is made on the same demand basis. To overcome this problem, price elasticities can be introduced into TIMES models to capture the response of the consumer sector to the production cost of a good or service, reflecting the price of CO₂ emissions. However, given the large number of material and energy demands that TIAM-FR features, we found it too difficult to recover price elasticities for each demand in each region. Furthermore, these price elasticities are time dependent.

Owing to newly published socio-economic data, the approach we adopted consists of updating the energy and material demands from existing prospective studies from the International Institute for Applied System Analysis (IIASA), based on the climate scenarios they developed. Recently in the climate change research community, five narratives have been designed corresponding to different socio-economic and geopolitics pathways for the 21st century (Riahi et al., 2017). They try to capture how the world could tackle the challenges of climate change in terms of adaptation, impacts, vulnerabilities, and mitigation according to how the narrative describes the evolution of inequalities, region rivalry, fossil-fueled development, and sustainable development. These pathways, also called Shared Socio-economic Pathways (SSP), allow energy modelers to compare and analyze their results with each other according to the SSP they are referring to. Each SSP has been studied by different laboratories to understand how to solve the climate problem according to their narrative. Their results are publicly available online (IIASA, n.d.) in a detailed database that displays the final energy demand of industry, residential and commercial sectors, and transportation, according to:

- The region of the world, namely the OECD, Reforming Economies, Asia, Middle East and Africa, and Latin America.
- The SSP.
- The climate target based on radiative forcing constraints from 1.9 W/m² to 6.0 W/m², and also including a baseline with no climate constraint.

For each one of these, the database gives GDP and population growth. We extract the SSP-based households from the OECD Env-Growth model (OECD, n.d.). The socio-economic drivers are then

used to calculate for each SSP, each region R , and each climate target CT , the elasticities of sector-specific energy demand DEM to their own drivers DRV over time t . We calculate the elasticities based on the following formula:

$$elasticity_{SSP,CT,R,DEM}(t) = \frac{\frac{DEM_{SSP,CT,R}(t) - DEM_{SSP,CT,R}(t-1)}{DEM_{SSP,CT,R}(t)}}{\frac{DRV_{SSP,CT,R}(t) - DRV_{SSP,CT,R}(t-1)}{DRV_{SSP,CT,R}(t-1)}}$$

The sector-specific demands are divided into industry, residential and commercial sectors, and transportation, which is much more aggregated than in TIAM-FR, so we allocate each subsector of TIAM to the right sector of IIASA database. Likewise, as the regions in the SSP database are much more aggregated than in TIAM-FR, we make the following allocation:

Table 45: Region allocation between TIAM-FR and IIASA database

TIAM	IIASA
AFR	Middle East and Africa
AUS	OECD
CAN	OECD
CHI	Asia
CSA	Latin America
EEU	Reforming Economies
FSU	Reforming Economies
IND	Asia
JPN	OECD
MEA	Middle East and Africa
MEX	Latin America
ODA	Asia
SKO	OECD
USA	OECD
WEU	OECD

Once all elasticities are calculated from the equation stemming from the two other equations above, then demands are calculated:

$$DEM_{SSP,CT,R}(t) = DEM_{SSP,CT,R}(t-1) \times \left(1 + \left(\frac{DRV_{SSP,CT,R}(t)}{DRV_{SSP,CT,R}(t-1)} - 1 \right) \times elasticity_{SSP,CT,R,DEM}(t) \right)$$

This methodology has developed a transparent energy demand projection that is based both on the SSP and the climate target considered by the user. It enables us to compare our results with other SSP-based studies as well as to take into consideration the impact of a climate target on the energy demands. For instance, Figure 40 compares the initial global energy demand projection¹³ of the SSP2 ETSAP-TIAM model with other projections of SSP2-2°C scenarios from different models in the IIASA database. It clearly reveals that the initial demand implemented in the ETSAP-TIAM model was overestimated, even though there are some differences between models.

¹³ Transport demands (road auto, road bus, road light duty, commercial trucks, medium trucks, road heavy duty, road two wheels, road three wheels) and industrial demands (pulp and paper, cement, aluminium, and steel) were excluded from the projections as they are expressed in Bv.km and Mt respectively.

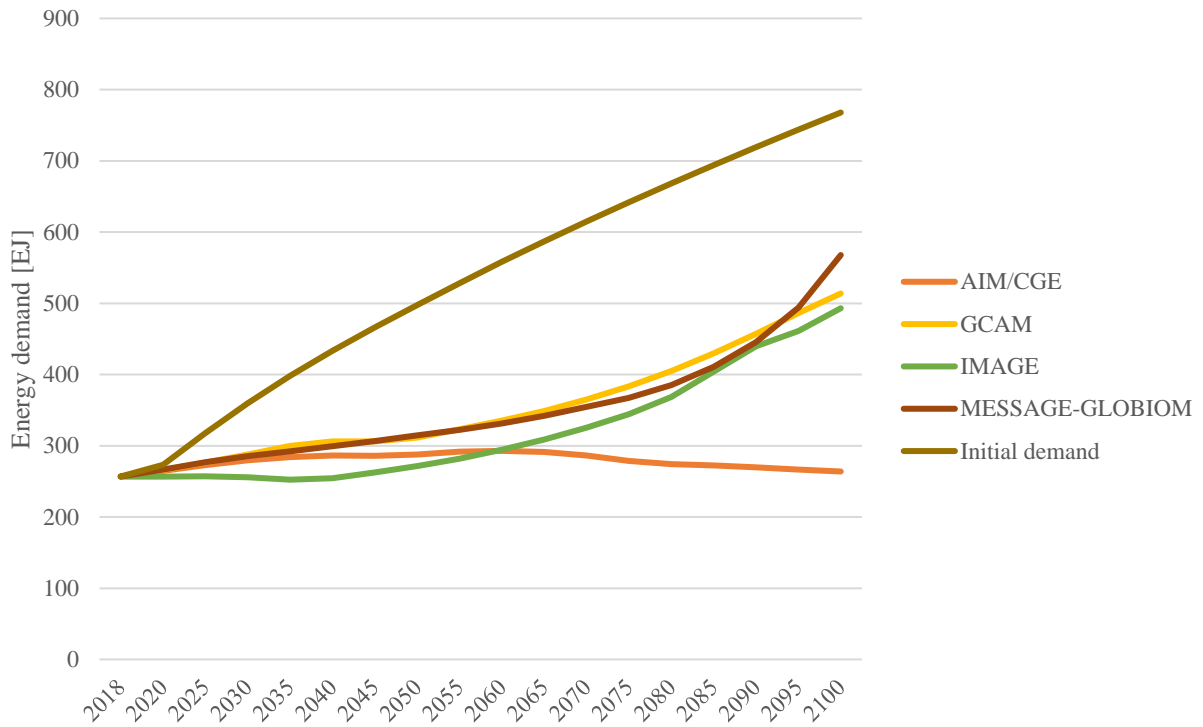

Figure 40: Comparison of global energy demand profiles between initial assumptions and new estimations considering a SSP2-2°C scenario.

It is worth mentioning that each SSP was studied in detail by one research group and one model (IIASA, n.d.), and that the MESSAGE-GLOBIOM model focused on the SSP2 scenario, which is the reason why we selected the demand projections of this model for the SSP2-2C scenarios. Considering these new demand scenarios also has a high impact on the cement and steel demands, as Figure 41 and Figure 42 show.

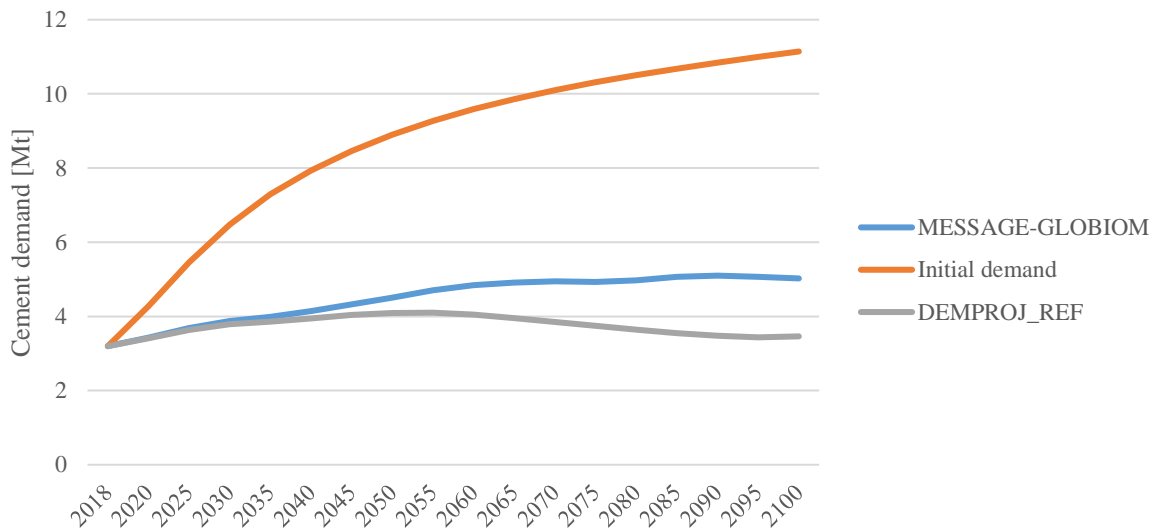

Figure 41: Comparison of cement demand projections with initial and new demand scenarios

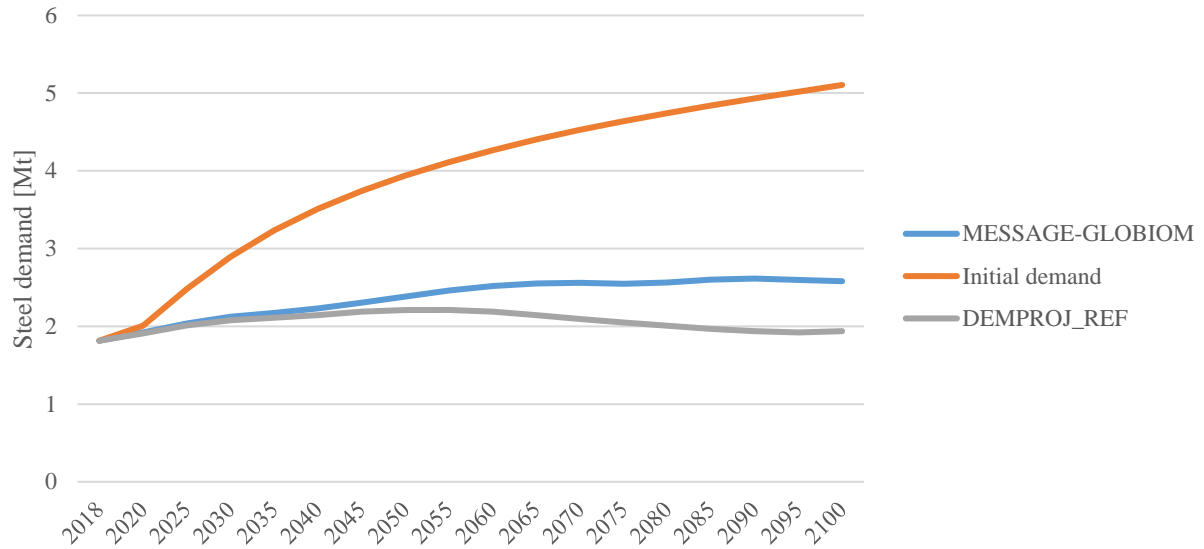

Figure 42: Comparison of steel demand projections with initial and new demand scenarios

This work was carried out in the context of the ETSAP program. We had the opportunity to develop these projections with the help of Dr. James Glynn, Senior Research Scholar at Columbia University.

10. Conclusion

This chapter synthesized and collected the techno-economic assumptions to model CO₂ capture, CO₂ utilization, and CO₂ transport and storage. It answered most of the knowledge gaps in CCUS modeling mentioned in Chapter 1, relating to lack of transparency, lack of CCUS consideration in top-down models, lack of integrated modeling, and lack of options to decarbonize the industry sector through CCU.

In TIAM-FR, a transparent, explicit representation of the new technologies is accessible for peers to review, discuss, and use the data employed in this thesis. Moreover, the framework designed for CO₂ allocation brought more transparency regarding CO₂ accounting. Almost 200 processes were either implemented or updated in the model with new energy efficiency measures for the power, hydrogen, and industry sectors. New opportunities for negative emissions were developed in the iron and steel sector, through DAC, and CO₂ mineralization. Finally, new fuel-shifting measures were implemented with CO₂ conversion, biorefineries, hydrogen, and biomass use in the iron and steel industry. With these three pillars, the model is now equipped to better assess how technology can help decarbonize the world energy system.

In EPPA, the aviation sector is now entirely disaggregated from the rest of the transport sector. It is now possible to decarbonize aircraft through CCU techniques, which was also made possible since we added new opportunities to generate negative emissions and climate-neutral CO₂ from DAC.

In general, the thorough examination of the literature uncovered a wide range of techno-economic assumptions, notably for CO₂ utilization, hydrogen, CO₂ transport and storage, and DAC, owing to the mature state of these technologies which justifies our reference study selection. These studies will allow us, in the following chapter, to design cost scenarios in order to assess the impact of cost on CCUS technologies. Finally, through the modeling of negative emissions with DAC and with BECCS processes in the steel industry, we considerably increased the potential of CCUS to decarbonize the global energy system of TIAM-FR and EPPA.

Chapter 4 – Exploring the role and potential of CCU, DAC, and industrial negative emissions in the global energy transition

This chapter responds to the knowledge gaps mentioned in Chapter 1, employing one or both of our models depending on the research questions and the adequacy of the model to answer them. The first analysis concerns the drivers of CO₂ utilization in the global energy transition; notably, the stringency of the climate target, the cost of CO₂ conversion technologies, the cost of hydrogen, the affordability of DAC, and whether a very high cost of CO₂ transport and storage would work in favor of CO₂ utilization. Thus, this section addresses the first knowledge gap expressed in Chapter 1, claiming that very few studies attempt to assess the global potential of CCU and its contribution to the industry sector. The second analysis studies the potential deployment of DAC in a net-zero world, and its implications on the global energy system, the economy, and land use. The third analysis focuses on the decarbonization potential of the biggest industries, namely steel and cement, and explores the contribution of biomass and negative emissions in these sectors. The first and third analysis are carried out with TIAM-FR and the second analysis is carried out with EPPA; we explain the choice of the model in the respective sections. The fourth and last analysis compares the results of EPPA and TIAM-FR under the same assumption and discusses the deployment of CCUS technologies from these different perspectives.

Ce chapitre répond aux lacunes de connaissance mentionnées dans le chapitre 1, en utilisant l'un ou l'autre de nos modèles selon les questions de recherche et l'adéquation du modèle pour y répondre. La première analyse porte sur les moteurs de l'utilisation du CO₂ dans la transition énergétique mondiale ; notamment, la rigueur de l'objectif climatique, le coût des technologies de conversion du CO₂, le coût de l'hydrogène, l'accessibilité du DAC, et si un coût très élevé du transport et du stockage du CO₂ jouerait en faveur de son utilisation. Ainsi, cette section aborde la première lacune de connaissance exprimée dans le chapitre 1, affirmant que très peu d'études tentent d'évaluer le potentiel mondial de la CCU et sa contribution au secteur industriel. La deuxième analyse étudie le déploiement potentiel du DAC dans un monde à émissions nettes nulles, et ses implications sur le système énergétique mondial, l'économie et l'utilisation des terres. La troisième analyse se concentre sur le potentiel de décarbonation des plus grandes industries, notamment l'acier et le ciment, et explore la contribution de la biomasse et des émissions négatives dans ces secteurs. La première et la troisième analyse sont réalisées avec TIAM-FR et la deuxième analyse est réalisée avec EPPA ; nous expliquons le choix du modèle dans les sections respectives. La quatrième et dernière analyse compare les résultats d'EPPA et de TIAM-FR sous la même hypothèse et discute du déploiement des technologies CCUS selon ces différentes perspectives.

1. Scenarios

Throughout this chapter, we submit the two models – EPPA and TIAM-FR – to various climate policy scenarios. This section aims to describe their characteristics and clarify their components. It also intends to explain how we defined a scenario that can be run in both models in order to compare their results at some point

1.1. Baseline

First, we defined a baseline scenario for each of our two models in a consistent manner despite their different characteristics, i.e., some constraints are common to both models but others are specific to one of them, and if so, we will specify them when necessary. We assume the world evolves towards a path consistent with SSP4, in which modest improvements in education, health, and governance are achieved, but continued dependence on fossil fuels, high greenhouse gas emissions, and limited action

on climate change. In this scenario, global economic growth is moderate and converges towards a single, global, middle-class lifestyle, with increasing urbanization and declining rural populations. Combined with a 3.4 W/m² climate scenario, it is designed to “assess the impacts of warming if societies rapidly reduce emissions, but fail to mitigate fast enough to limit warming to below 2°C” (CarbonBrief, 2019). In addition to that, we include the current pledges made by countries through their Nationally Determined Contributions (NDCs) (UNFCCC, 2023). The NDCs are commitments made by countries under the Paris Agreement to reduce their greenhouse gas emissions and enhance their efforts to adapt to the impacts of climate change. NDCs are specific and quantifiable actions, policies, and measures that countries propose to take in order to contribute to the global effort to combat climate change. As the name suggests, they are expressed by each country, while our models aggregate countries into regions such as Africa, Central and South America, etc. Therefore, we compiled the NDCs and aggregated them for the regions in our models, as summarized in Table 46. It shows that regions and countries have different ambitions in terms of the timing of their target, their target itself – some are willing to achieve net zero emissions while others are not, and whether the target is for CO₂ only or all GHGs.

Table 46: NDCs recalibrated for the regions of TIAM-FR

Region	Milestone year	Net GHG target [GtCO_{2,eq}]	Which GHG?
USA	2030	3.40	All GHGs
	2050	0	All GHGs
AUS	2030	0.55	All GHGs
	2050	0	All GHGs
CAN	2030	0.80	All GHGs
	2050	0	All GHGs
SKO	2030	0.62	CO ₂
	2050	0	CO ₂
JPN	2030	0.72	CO ₂
	2050	0	CO ₂
WEU & EEU	2030	2.77	All GHGs
	2050	0	All GHGs
IND	2030	5.05	CO ₂
	2070	0	CO ₂
CHI	2030	6.20	CO ₂
	2060	0	CO ₂
MEX	2030	0.51	All GHGs
FSU	2030	6.34	All GHGs
ODA	2030	6.08	All GHGs
CSA	2030	3.55	All GHGs
AFR	2030	3.86	All GHGs
MEA	2030	4.40	All GHGs

The targets are maintained after each milestone year and until 2100.

1.2. Climate policies

For climate-constrained scenarios in TIAM-FR, we can employ a global carbon budget (CB), which consists in limiting the cumulative amount of CO₂ emissions that can be generated throughout the 21st century. This way, the solver is free to tackle CO₂ emissions when it optimizes as the cheapest, and the

cheapest could occur very late in the century. The values of the carbon budget depend on the climate policy targeted. We use the values of Friedlingstein et al. (2022) for a 1.5°C scenario and a 2°C scenario that assessed the median values of the carbon budgets for these policies at 380 and 730 GtCO₂ (Friedlingstein et al., 2022). However, by essence these values do not include a limitation of non-CO₂ GHG, which means that the levels of CH₄ and N₂O emissions are not constrained and may compromise the underlying climate target of limiting temperature increase. To overcome this, in addition to the carbon budget, we implement a cap on regional CO₂ or GHG emissions based on the NDCs in Table 46. Hence, the carbon budget combined with the NDCs enables the model to follow a realistic emissions pathway during the first decades. Indeed, if only the carbon budget is set up, the solver is tempted to continue emitting massively until mid-century and compensate for emissions later to an unrealistic extent. The use of NDCs prevents the solver from relying too massively on negative emissions during the last decades. Nevertheless, this strategy is limited by the NDCs themselves for some countries or regions only tackling CO₂ and not GHGs. This is the case for high emitters such as China and India. In this scenario, the energy, transport and material demands are consistent with an SSP2-2.6, which is a middle-of-the-road scenario with moderate economic growth and improved education, health, and governance. In this scenario, there is a focus on increasing energy efficiency and expanding the use of low-carbon energy sources, but emissions reductions are limited, and greenhouse gas emissions decline. Global inequality increases, but at a slower rate than in other scenarios, and global population grows to around 9 billion by 2100.

Such a carbon budget is difficult to implement in EPPA as it is a recursive model, which involves optimizing at each time step by following a trend on GHG emissions. The carbon budget can be respected by the solver by defining an implicit price on GHG emissions that reflects the carbon budget. Due to the time needed and because this process of defining the price of GHG is difficult to master, we were discouraged from using a carbon budget in EPPA. Besides, even if we had implemented a carbon budget, it would have ignored the regional GHG emissions targets since carbon budgets cannot be set up regionally.

We compare the reference scenario to the *NZ70* scenario, which involves a GHG emissions-free world by 2070 in every region. In addition to the NDCs, this scenario engages all regions on a path with a linear decrease in GHG emissions towards net-zero by 2070. The emissions trend of the path towards net-zero by 2070 is shown in Figure 43. We assume that GHG trades between regions and between GHGs are available starting from 2030, unless specified.

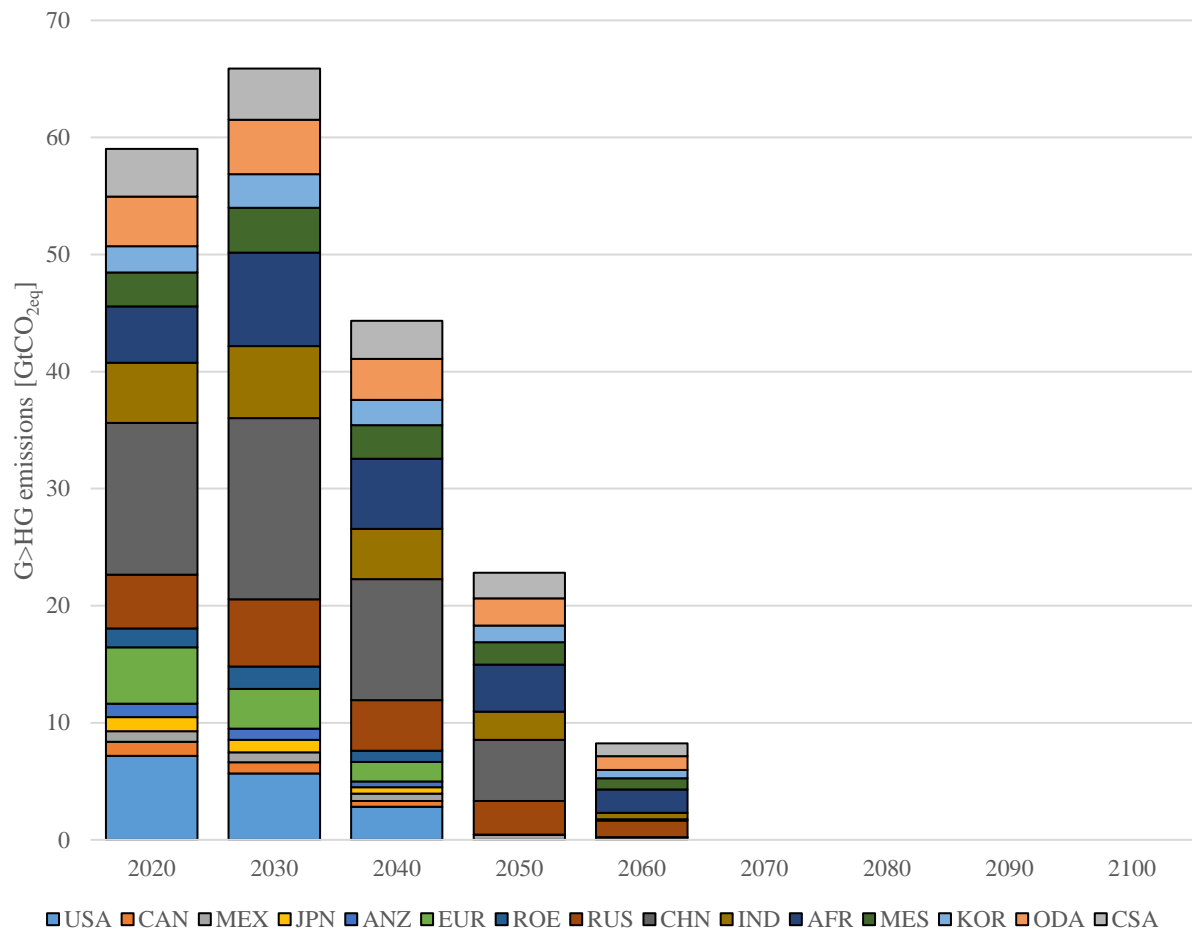

Figure 43: GHG emissions cap in the NZ70 scenario in EPPA and TIAM-FR

To summarize, we gathered the scenarios described hereabove in the following Table 47, in which we detail whether the scenario can be used in both models or not.

Table 47: Ambitions and suitability of scenarios

Name	Ambition	Milestone years	GHG Trade	Additional features	Fitted for EPPA?	Fitted for TIAM-FR?
REF	NDC	N/A	No	Demand curve of SSP4-3.4	No	Yes
CB15C	Carbon budget of 380 GtCO ₂	2022-2100	Between regions and GHG	NDCs Demand curve of SSP2-1.9	No	Yes
CB2C	Carbon budget of 730 GtCO ₂	2022-2100	Between regions and GHG	NDCs Demand curve of SSP2-2.6	No	Yes
NZ70	Net-zero GHG emissions following the cap of Figure 43	2070	Between regions and GHG	NDCs	Yes	Yes

Some variations and sensitivities to these scenarios will be applied regarding the cost of the technologies (Sections 2 and Section 3), the availability of biomass and sectorial emissions policies (Section 4) or trading of emission permits (Section 3 and Section 4).

2. What drives the deployment of CCU?

In light of what was debated in Chapter 1 about the lacunas of CCU modeling in global energy models, we consider that Chapter 3 has already filled this gap, and thus the following analysis exploits the modeling to address the questions of CCU competitiveness and CCU contribution to climate policies. We have chosen to carry out the following analysis with our bottom-up model (TIAM-FR) as it is a technology-rich model enabling us to track which and how CO₂ utilization processes work, depending on the large variety of CO₂ sources and demands for CO₂-based products. In addition, we evaluate the sensitivity of CCU deployment to the cost of hydrogen (see Chapter 3), which would not have been possible with EPPA since it does not model hydrogen *per se*.

The following analysis assumes conservative assumptions regarding the costs of CO₂ utilization, hydrogen, and DAC (see the *High* cases in Chapter 3). The table below refers to the *High*, *Medium* and *Low* cases based on the estimation of the levelized cost of producing CO₂-based products:

Table 48: Case-specific techno-economic assumptions for CO₂-based products

	High	Medium	Low
Fischer-Tropsch fuels	(Zang et al., 2021)	(Albrecht et al., 2017)	(Falter et al., 2016)
Synthetic methane	(Szima and Cormos, 2018)	(Chauvy et al., 2021b)	(Gorre et al., 2019)
Synthetic methanol	(Pérez-Fortes et al., 2016)	(Zhang et al., 2019)	(Hank et al., 2018)
Mineralized slags (NASEM, 2019b)	\$31/t	\$27/t	\$23/t
Mineralized fly ashes (NASEM, 2019b)	\$29/t	\$21/t	\$14/t

As the analysis progresses, the cost cases will be relaxed towards the *Medium* and *Low* cases. However, we assume a low cost of CO₂ transport and storage (\$10/tCO₂) from the beginning as it is generally assumed in IAMs (Smith et al., 2021b), and we will study how CCU deployment reacts to higher costs in subsection 2.4.

2.1. How the climate policy impacts the deployment of CCU?

Assuming high costs for CO₂ conversion, hydrogen production, and DAC, we explore the deployment of CCU in the *REF*, *NZ70*, *CB2C* and *CB15C* scenarios (see Table 47 for the definition of the scenarios). Figure 44 shows the cumulative quantity of CO₂ captured and utilized in each scenario over the century. As expected, the more stringent the climate constraint, the more CCU is required. In the *REF* scenario, CCU is deployed only in countries having ambitious NDCs, and even more in countries having low access to land and primary energy, such as South Korea and Japan, with cumulative 5.9 and 3.3 GtCO₂ utilized respectively in these countries. The CO₂ is used to manufacture FT fuels essentially for the agriculture machines, aviation, and residential sectors. In the remaining countries and regions, CO₂ is converted into methanol, which is also the primary interest of the *NZ70* scenario. Across all scenarios, the methanol generated is never used raw, but enhanced by the Methanol-to-Gasoline (MtG) process. Methanol is thus used as a petrochemical product to generate gasoline, which is a fuel that can be employed in all sectors of the economy, while methanol can only be burnt by transport engines. Whatever the scenario, CO₂-based fuels dominate the demand for CO₂ over minerals, which is due to the flexibility of fuels that can be used in any economic sector, while mineralized ash and slag can only be employed in the cement sector, whose demand is fixed exogenously. Therefore, the demand for CO₂ to manufacture minerals is limited by the demand for cement. All regions deploy CCU, but China leads

with cumulative 16 GtCO₂ utilized over the 21st century in the *NZ70* scenario. The country takes advantage of its big cement and steel industries to mineralize CO₂, representing 27% of the total CO₂ used.

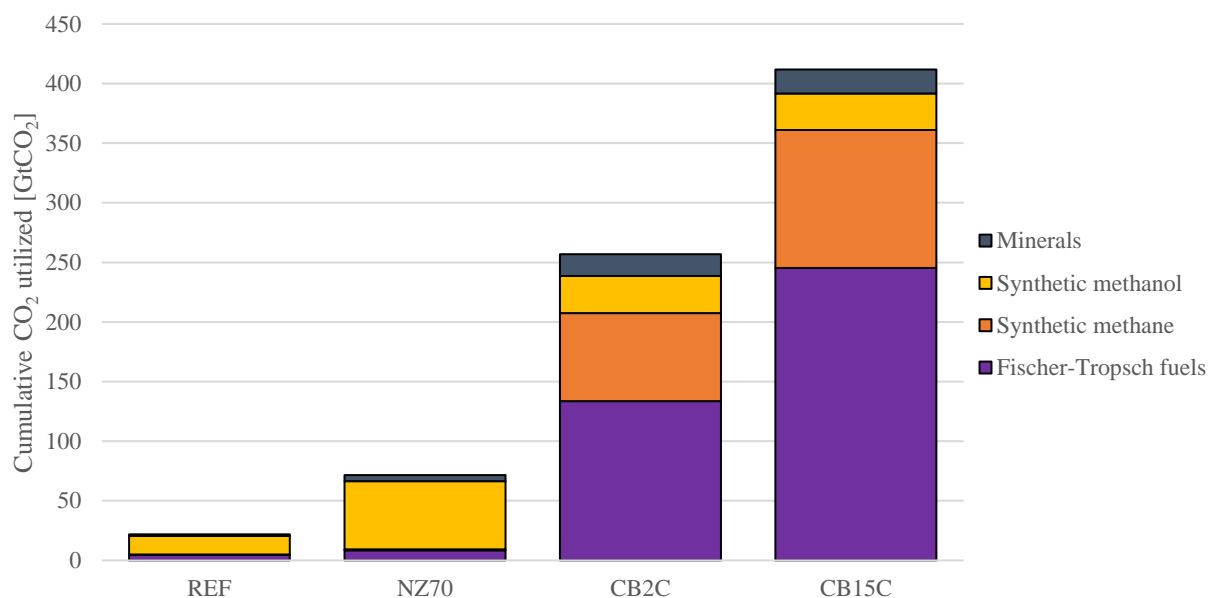

Figure 44: Amount of CO₂ captured and utilized in the REF, CB2C and CB15C scenarios by type of CO₂ and sector from which it was captured

FT fuels are produced to satisfy demands from light-duty transport, aviation, residential and agriculture as of 2050. China and India become the biggest producers of synthetic fuels in the scenarios with carbon budgets. In *CB2C* and *CB15C*, synthetic methane is manufactured all over in the world for the industrial sector both as a chemical feedstock and an energy carrier, but not before 2080.

Due to the nature of the constraint in carbon budget scenarios, more CCU is required because only CO₂ is tackled, and the use of CCU avoids emissions from fuel combustion without the need to shift to other energy carriers and end-use processes. Manufacturing synthetic fuels instead of extracting fossil fuels also avoids emissions due to extraction, e.g. 7.3 tCO₂/GJ in Canada for oil and gas fields. Moreover, the CO₂ emissions from synthetics fuels might be climate neutral if the CO₂ used is biogenic or atmospheric, which is the case for 63% of the CO₂ in the *CB15C* scenario, resp. 45% in *CB2C* and 91% in *NZ70*. However, the climate module calculates that *NZ70*, *CB2C*, and *CB15C* achieve respectively a global temperature limitation by 2100 of 1.46°C, 1.72°C, and 1.60°C because carbon budget scenarios do not combat non-CO₂ GHGs. Thus, CCU enables lower net CO₂ emissions levels in the carbon budget scenarios than in the *NZ70*, but the climate benefits are not necessarily greater.

Climate policy thus impacts investments in CCU depending on the stringency of the climate constraint and the nature of the constraint itself.

2.2. How important is the assumption on CCU cost?

In the *NZ70* scenario, we explore the sensitivity of CCU deployment to its own costs, by introducing two cases referring respectively to the Medium and Low cases of the CO₂ conversion technologies described in Chapter 3 and Table 48 of this chapter. In Figure 45, we show the demand for CO₂-based products in different cost scenarios. The cumulative quantity of CO₂ utilized can be doubled if one assumes a low-cost case. Nevertheless, this sensitivity is almost entirely driven by the uncertainty regarding FT processes. Thus, if the total quantity of CO₂ utilized is doubled, the quantity of CO₂

utilized by FT processes is multiplied by eight. Consequently, more synthetic gasoline, diesel and jet fuels are generated in the *Low* case, and these fuels are 95% climate-neutral, i.e. manufactured from biogenic CO₂ captured from biorefineries. As the cost of CCU decreases, +50% of FT fuels are used in the residential and transport sectors for light-duty demands. Moreover, low-cost FT fuels participate more significantly in the decarbonization of global aviation with 35% of carbon-neutral fuels in the *Low* case compared to 2% in the *High* case. Indeed, FT fuels are deployed only in Japan and South Korea in the *High* case, while almost all regions and countries manufacture FT fuels in the *Low* case.

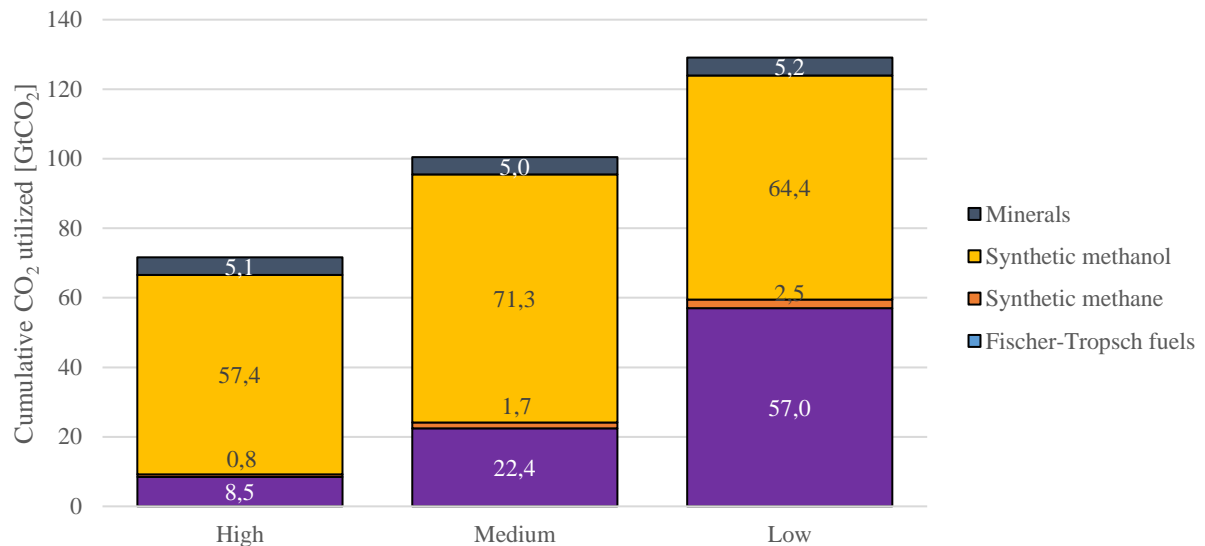

Figure 45: CO₂ captured and utilized in the NZ70 scenario with the High, Medium, and Low cost of CO₂ conversion technologies

Although it represents a small share of total CO₂ utilization, synthetic methane is three times greater in the *Low* case than in the high case. It is used in the same sectors and regions, but at higher levels. There is more methanol produced in the *Medium* case than in the *Low* case, which is also related to the cost assumption behind the FT process, as it produces gasoline in fixed shares, while CO₂-to-methanol processes convert their output into gasoline. Therefore, the two processes are competing, and in the *Medium* case, the CO₂-to-Methanol process appears more competitive than the FT process. In the meantime, minerals play a stable role whatever the cost case. The maximum potential of CO₂ mineralization is actually reached in the *High* case, as it constitutes an efficient alternative to decarbonize the cement sector.

2.3. How sensitive are CCU investments to hydrogen production costs?

Returning to the conservative High case for CCU processes, we now explore the sensitivity of CCU deployment to the cost of hydrogen by introducing two cases referring to the *Low* and *Medium* assumptions of the hydrogen production technologies described in Section 3 of Chapter 3. With TIAM-FR, we observe that demand for CO₂-based products is also sensitive to hydrogen (Figure 46). In the *Low* case, FT fuels, methane, and methanol respectively increase by 32%, 107%, and 56%, while the cost of hydrogen is reduced by roughly 20% compared to the High case (Figure 47). Although the demand for synthetic FT fuels and methane is sensitive to hydrogen cost, it still remains much lower than the overall methanol yield, suggesting that a low hydrogen cost does not drive up the production of FT fuels as much as other synthetic fuels.

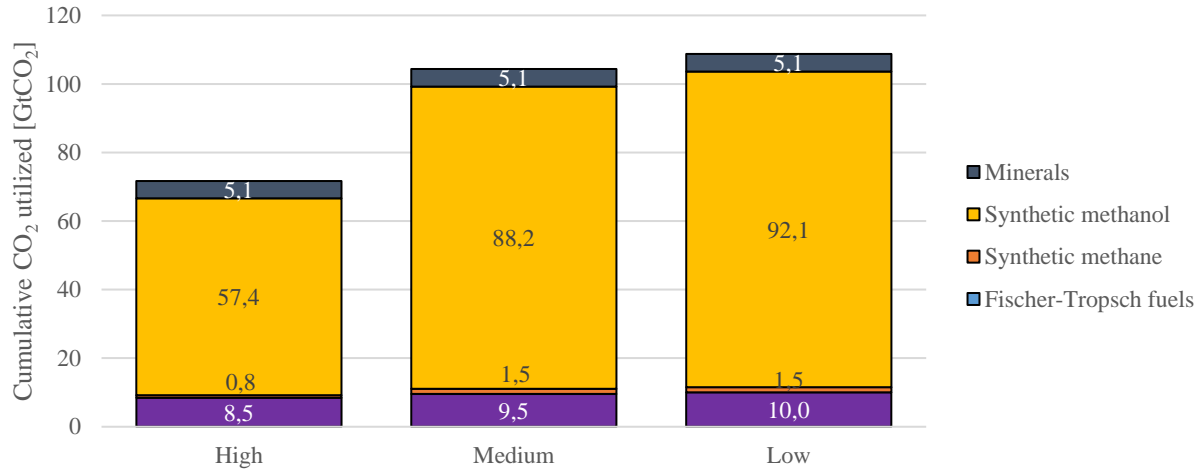

Figure 46: Cumulative demand for CO₂-based products in NZ70 with different cost cases for hydrogen production

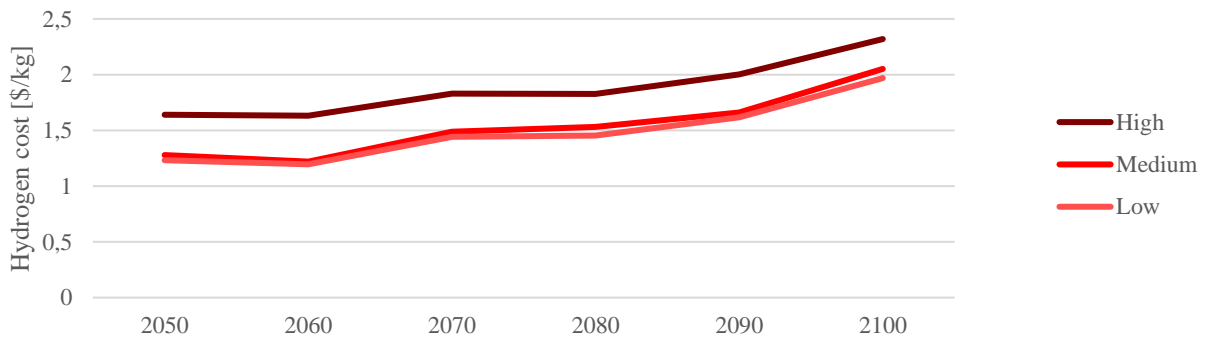

Figure 47: Global average production cost of hydrogen in the NZ70 scenario

As expected, the production of minerals is not sensitive to the cost of hydrogen, since the mineralization process does not run with hydrogen.

2.4. Is there a trade-off between CCS and CCU?

Because CCU activities do not require investments for the transport and storage of CO₂ *per se*, CCU may become more competitive than CCS if high costs of transport and storage (TnS) are considered. In other words, we wonder whether making CCS less competitive would make CCU more competitive. Generally, in energy models, the cost of CO₂ transport and storage is merely represented through a standard cost of \$10/tCO₂ (Smith et al., 2021b), while studies show it can exceed \$60/tCO₂ (see Chapter 3) or even higher (Clean Air Task Force, 2023). Thus, we explore how a high cost of CO₂ TnS impacts the deployment of CCU through the NZ70 scenario by gradually varying the cost of transport and storage from \$10/tCO₂ to \$70/tCO₂.

As a matter of fact, the cumulative quantity of CO₂ utilized decreases as the cost of CO₂ TnS increases (Figure 48). This observation is true for synthetic fuels, with quantities reduced by 16% for FT fuels, 22% for methane, and 30% for methanol, when comparing the cheapest case with the most expensive one. However, we observe the reverse effect for minerals, whose quantity slightly increases by 2% to compensate in part the less effective geological sequestration. The explanation for this counterintuitive result lies in the collateral effect of CCS being expensive.

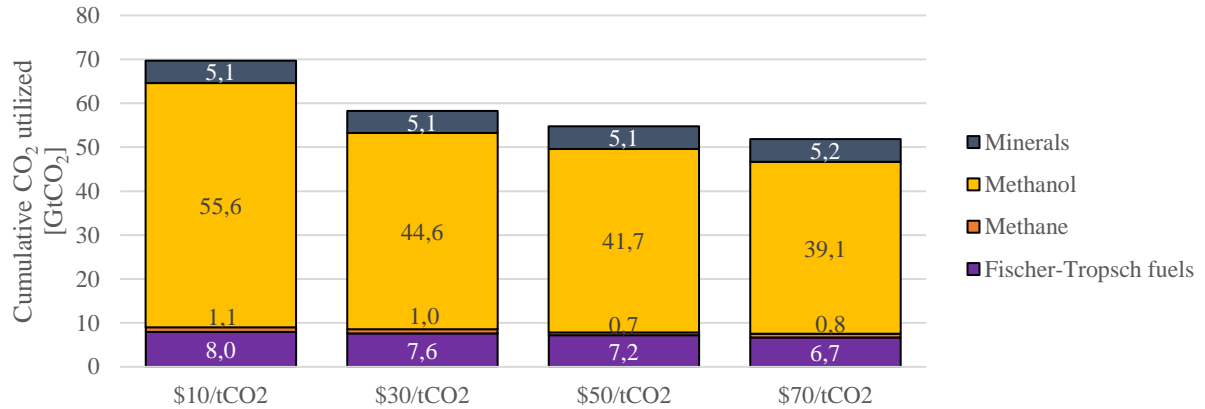

Figure 48: Cumulative amount of CO₂ utilized as a function of CO₂ TnS costs

When CCS is cheap, the power sector deploys more CCS to decarbonize electricity at a cost approximately 20% more affordable than when CCS is expensive. When comparing the cheapest case for CO₂ TnS with the most expensive one, the contribution of CCS is reduced by 19%, which in turn also makes hydrogen 25% more expensive when comparing the cases with \$10/tCO₂ and \$70/tCO₂ for CO₂ TnS (Figure 50).

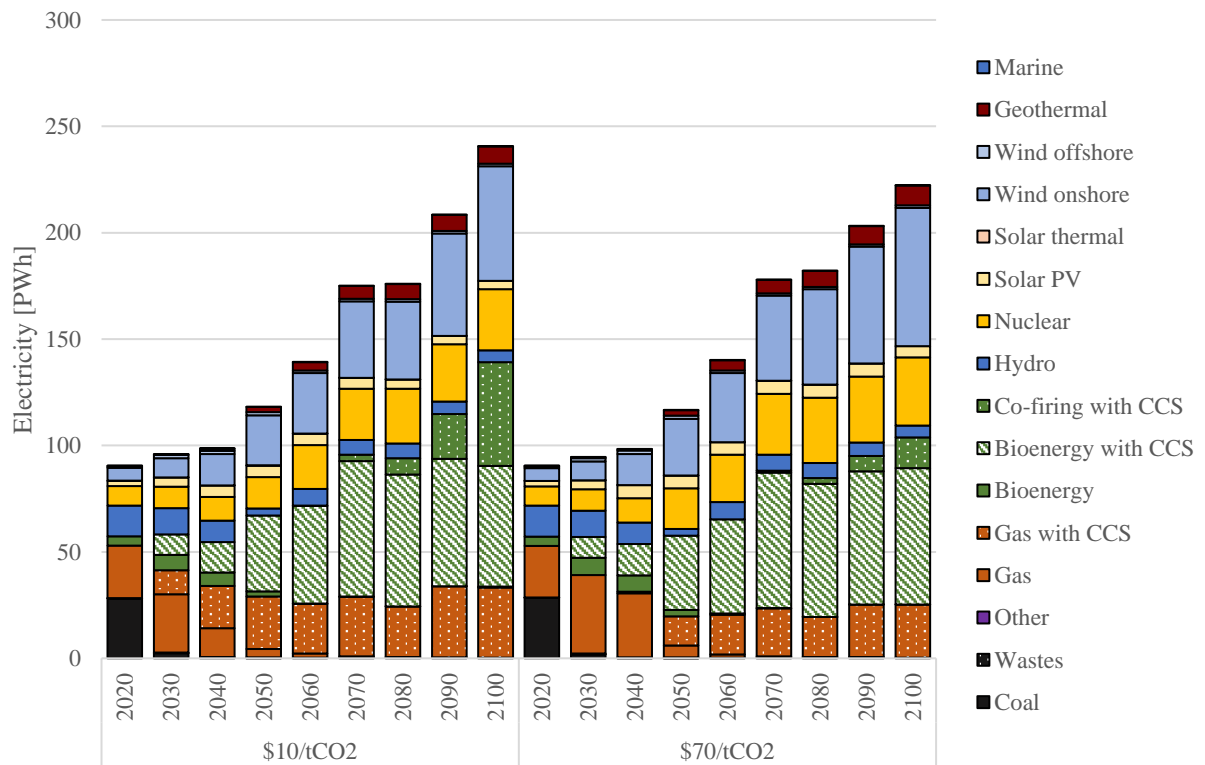

Figure 49: Global power generation depending on the cost of CO₂ transport and storage in the NZ70 scenario

So, when CCS is expensive, electricity cost increases and the rest of the CCU chain is impacted: less CO₂ is captured, and electricity and hydrogen are more expensive. Altogether, the impacts of expensive CCS make CCU less competitive than when CCS is cheap.

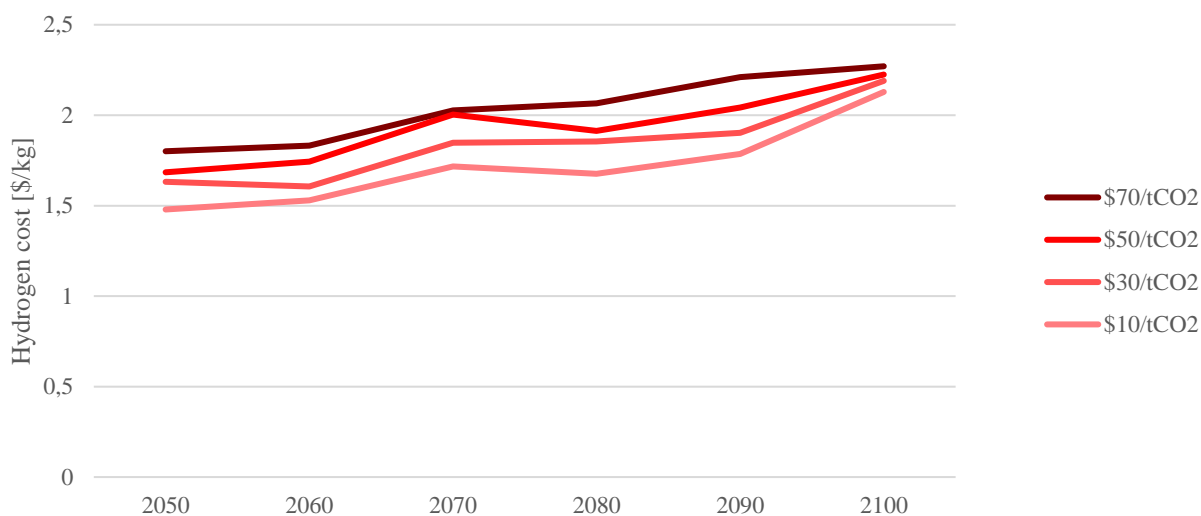

Figure 50: Global cost of hydrogen over the century depending on the cost of CO₂ transport and storage in the NZ70 scenario

2.5. Can a low-cost DAC help CCU deployment?

In this subsection, we explore whether affordable DAC can steer CCU investments. We thus introduce three cases – *Medium*, *Low* and *Very low* – referring to the DAC cost cases described in Chapter 3. Whatever the scenario described in subsection 2.1, DAC is never used to generate raw CO₂ or negative emissions. In Figure 51, we observe that the cumulative quantity of CO₂ utilized decreases as the cost of DAC is reduced. Deploying cheap DAC disrupts the balance of the merit order compared to when DAC is not available or expensive; as there is no constraint except for supplying electricity to DAC units to generate negative emissions, it becomes more cost-effective to invest in DACCS than in DACCU to mitigate CO₂ concentration in the atmosphere. Nevertheless, this result is mainly driven by the decrease of the CO₂ used to manufacture methanol (which is turned into gasoline) while minerals, methane, and FT fuels remain at a constant level, suggesting that these alternatives cannot be substituted by DACCS; FT fuels remain crucial in South Korea and Japan and mineralization remains a no-regret choice in China, India, Japan and South Korea. However, the gasoline generated from synthetic methanol and used in the transport sector can be offset at a lower cost by DACCS. Similar observations were made with the *CB2C* and *CB15C* scenarios.

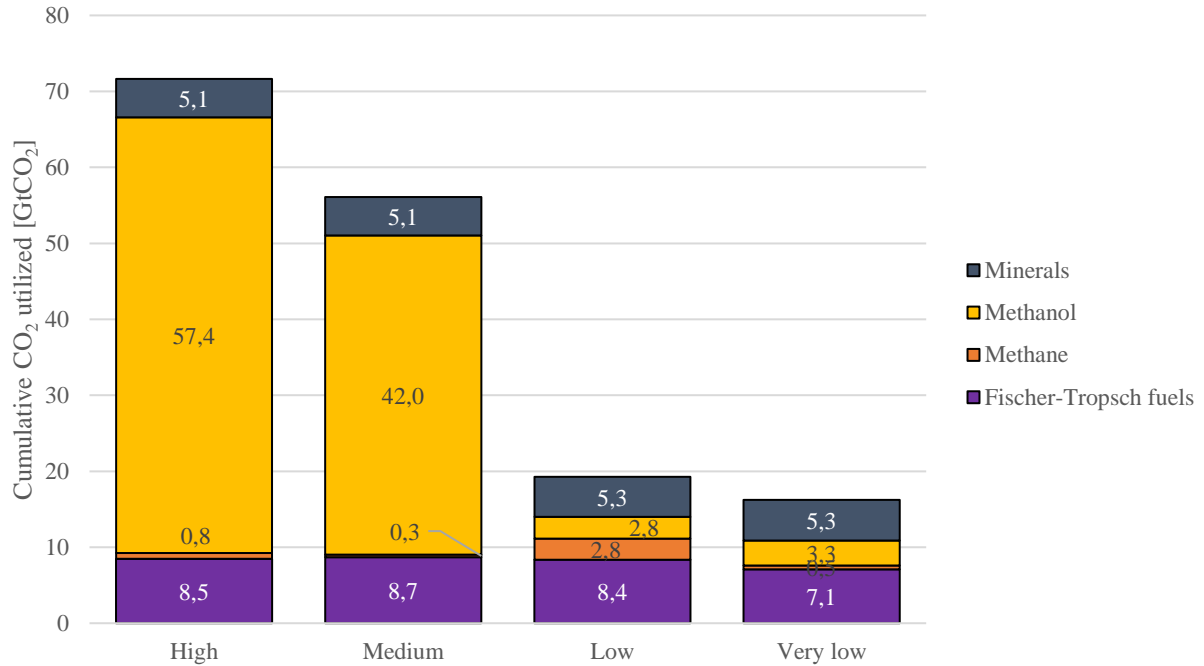

Figure 51: Cumulative quantity of CO₂ utilized as a function of DAC costs in the NZ70 scenario

Therefore, lowering the cost of DAC would not necessarily steer the utilization of CO₂ as DACCS behaves as a backstop technology preventing the deployment of complex CCU chains. Consequently, the amount of DACCS in the *Medium*, *Low* and *Very low* cases is very important, with respectively 100, 413 and 457 Gt of CO₂ negative emissions. More broadly, the affordability of carbon dioxide removal would comprise CCU deployment, unless policies aim to limit the use of emissions compensation.

2.6. Conclusion and discussion

We explored the drivers that could affect the deployment of CO₂ utilization in the global energy transition. Our investigation reveals that the way the climate constraint is defined, as well as the assumed cost of hydrogen production and the CO₂ conversion processes themselves, impact the contribution of CCU. According to our results, CCU is deployed more significantly when the climate policy follows a carbon budget. However, an excessive cost of CO₂ transport and storage or a low cost of DAC compromise the deployment of CCU. With expensive CCS, the overall transition accordingly becomes expensive, making hydrogen and electricity more costly, affecting the deployment of CCU. Even if the impact of the cost of CO₂ TnS on CCU deployment is moderate, it proves that CCU investments are not substitutes for CCS investments, and that CCU needs CCS to be commercialized.

When cheap DAC is available, the interest of CCU is reduced as the emissions targets can be achieved with inexpensive negative emissions.

Consecutive to the conclusions drawn from the previous sections, we introduce two cases called *Conservative* and *Optimistic*, in order to compare extreme unfavorable or unfavorable conditions in the deployment of CCU (Figure 52). The *Conservative* scenario assumes all unfavorable assumptions possible for the future roll-out of CCU (expensive CCU process, expensive hydrogen production, cheap CO₂ TnS, and cheap DAC), while the *Optimistic* scenario assumes all favorable assumptions possible for the future roll-out of CCU (cheap CCU process, cheap hydrogen production, expensive CO₂ TnS, and expensive DAC). We observe that the contribution of CCU is approximately three times greater in the optimistic scenario, with 223 and 72 GtCO₂ utilized over the century respectively for the *Optimistic* and *Conservative* scenarios. As mentioned in the previous sections, methanol and Fischer-Tropsch fuels are the main interest for CCU investments as they enable the production of low-carbon fuels to substitute fossil fuels in the industry, residential, and aviation sectors.

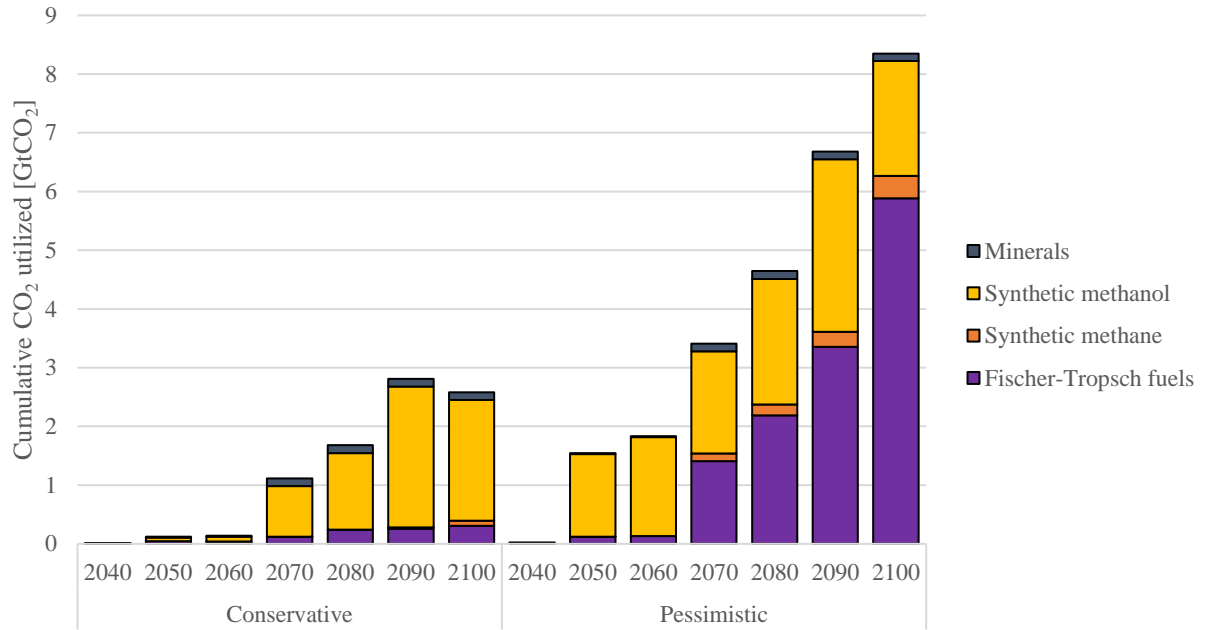

Figure 52: Comparison of CCU contribution between a conservative and optimistic cases of CCU drivers in the NZ70 scenario

However, when looking at the temporal deployment, the results indicate that CCU would not be deployed in the near term. Indeed, respectively for the *Optimistic* scenario, we account for 1.5 Gtpa of CO₂ captured and converted in 2050, but less than 150 Mt in the conservative scenario. Note that in the *Optimistic* scenario (resp. *Conservative*), 80 (resp. 69%) of the CO₂ used is actually employed during the 2075-2100 period.

Concerning the regions and countries investing in CCU, they are represented quite evenly, depending on the size of their energy demand, with Africa, China, the Middle East and the US representing more than 60% of investments. However, smaller economies like South Korea, Canada, and Japan also deploy CCU to cope with their low primary energy resources and high import costs. They also require CCU to achieve their NDC by 2050.

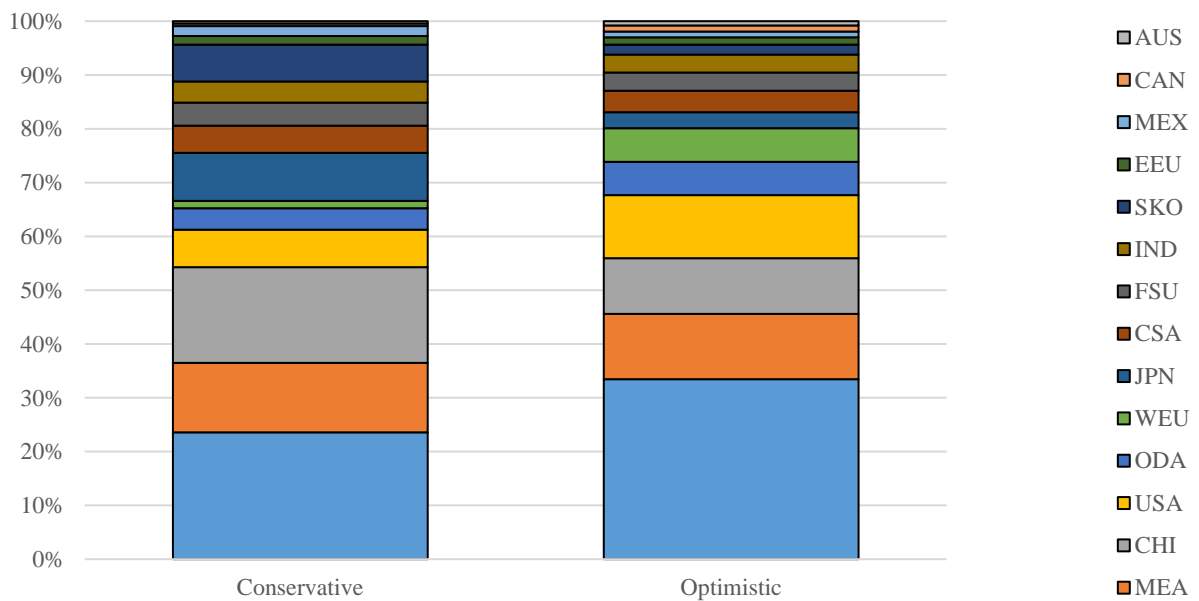

Figure 53: Shares of regions and countries deploying CCU in the conservative and optimistic scenarios

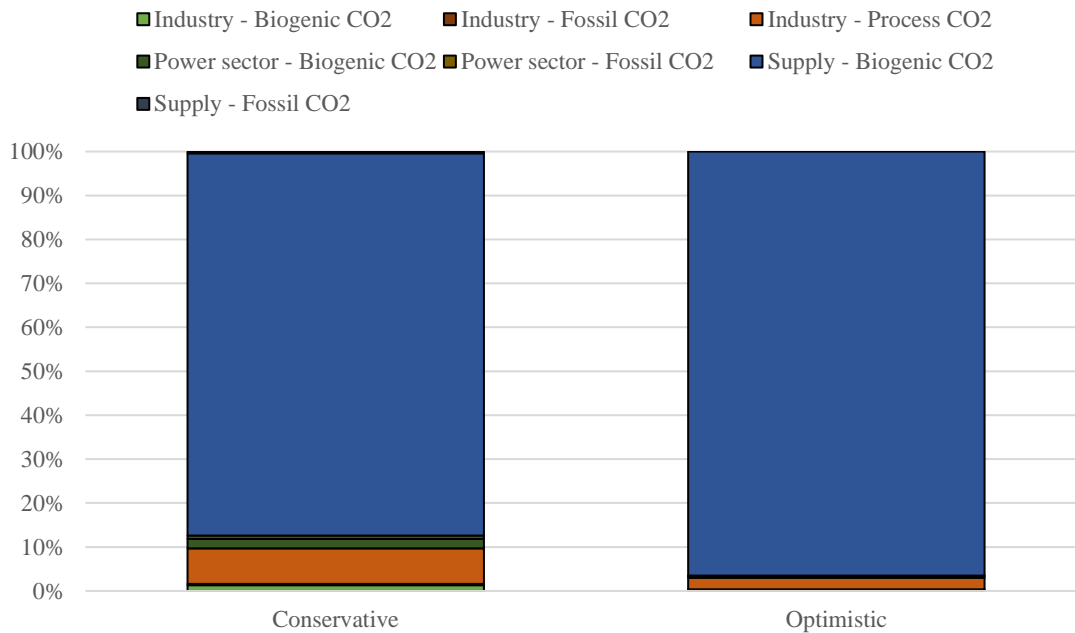

Figure 54: CO₂ origin and nature in the most pessimistic and optimistic scenarios regarding CCU drivers

Whatever the scenario, more than 90% of the CO₂ employed in CO₂ conversion processes is biogenic, captured from the supply sector, i.e. from ethanol, diesel, and gasoline biorefineries. It is essential that the CO₂ used to manufacture fuels be climate-neutral in order to ensure that the CO₂-based methanol and FT fuels limit their impact on climate change. More than 85% of the fossil and process CO₂ used is mineralized to eliminate the emissions from industry.

To conclude, CCU is mainly a long-term technological solution for big economies and countries having low access to primary energy sources. To achieve their ambitious NDCs, these countries and regions should take advantage of cheap, climate-neutral CO₂ to manufacture low-carbon CO₂-based fuels helpful to decarbonize critical sectors such as aviation.

3. Exploring the conditions and implications of deploying direct air capture at scale

Consecutive to the results on DAC and CCU – highlighting that cheap DAC makes CCU even less competitive, we employ the EPPA model to further explore the potential of DAC technology. This analysis aims at analyzing the requirements and consequences of the deployment of DAC on the global economy (land use, fuel prices, and economic growth). Hence, we employ the top-down model (EPPA) here.

This work was carried out together with the MIT Joint Program on the Science and Policy of Global Change. Prof. Sergey Paltsev, Senior Research Scientist, Dr. Angelo Gurgel, Research Scientist, Dr. Jennifer Morris, Principal Research Scientist, and Howard Herzog, Senior Research Engineer, participated in the modeling of DAC and provided their expertise on energy modeling and DAC technologies.

With DAC available in 2030, we use a scenario targeting net-zero GHG emissions by 2070, which keeps the increase in global average temperature to below 1.5°C according to the projections of the MESM (Sokolov et al., 2018). We compare two cooperation frameworks related to the trading of GHGs:

- GHGs can be traded across regions and across GHGs starting from 2030;

- GHGs are not tradeable across regions but are across GHGs, e.g. CO₂ mitigation can compensate for CH₄ or N₂O mitigation.

In these climate policy scenarios, we apply sensitivity tests to the cost of DAC and the impact of limited BECCS capacities (*BECPen*). The former refers to the cost cases in Table 36 and Table 37¹⁴, and the latter assumes that BECCS costs increase linearly with the share of cropland used for BECCS if BECCS exceeds 5% of the regional cropland area. This case provides a proxy for factors that could limit the deployment of BECCS, including the effect of climate change on land productivity (Günther and Ekaradt, 2022) and potential environmental and societal concerns about biomass competing with food production and ecosystem services provision (Kang, 2017). The reference scenario (NoDAC) is consistent with achieving the net-zero target by 2070 without DAC available.

3.1. DAC deployment

First, we analyze how the deployment of DAC is affected by assumptions about the cost of DAC, the availability of BECCS and the presence of international emissions trading. We then discuss the induced requirements on the energy system and impacts on the economy, land use, and food prices. The scenarios can be compared with the reference scenario which does not allow for DAC investments (NoDAC). Consequently, only BECCS and afforestation/reforestation can be deployed in order to generate negative emissions, as Figure 55 shows. The modeling of BECCS in EPPA and its contribution to reach the 1.5°C target were discussed in Fajardy et al. (2021).

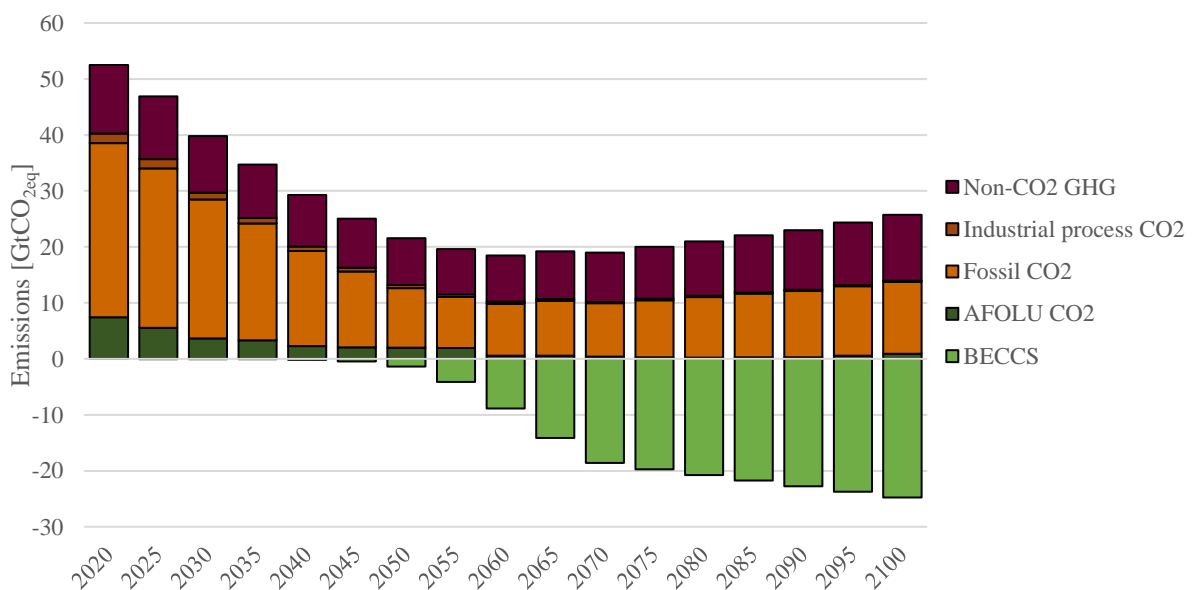

Figure 55: Emissions profile of the reference scenario with no DAC (NoDAC)

3.1.1. Cost of DAC and BECCS availability

Introducing a high-cost DAC as a new technology in EPPA for a *NZ70* scenario does not impact the resulting solution, i.e. DAC is not found competitive for a cost close to \$860-1000/tCO₂, either to generate negative emissions or produce synthetic fuels. For a medium cost (\$420-570/tCO₂), DACCS is slightly penetrating the generation mix of negative emissions, proving competitive only in Africa and Indonesia and providing 1.3% of total global negative emissions (Figure 56). At this level, DAC is not deployed at scale: at best, DACCU provides 90 MtCO₂ in 2075 and DACCS provides 730 MtCO₂ in

¹⁴ Four costs cases are expressed in these tables. The *Very low* case refers to \$160/tCO₂, the *Low* case refers to \$240/tCO₂, the *Medium* case refers to \$400/tCO₂, and the *High* case refers to \$840/tCO₂ when DAC is fed with US grid electricity.

2060. The total amount of negative emissions is unchanged compared to the NoDAC scenario, suggesting that DACCS substitutes BECCS in these regions.

Assuming a low cost (~\$250-400/tCO₂), DACCS contributes by generating 44% of the cumulative amount of negative emissions, or 435 GtCO₂ over the century, especially deploying in Africa and other regions and countries (Indonesia and Brazil especially) having affordable access to large renewable potentials. In this configuration, the cost of DACCS is comparable to the cost of BECCS, although BECCS is still dominating the generation of negative emissions in regions with large biomass potentials such as Africa, Latin America, Indonesia and Brazil. For a very low cost of DACCS (~\$180-330/tCO₂), it finally overcomes BECCS: 875 GtCO₂ of negative emissions are produced through 2100, and Africa clearly dominates the market (Figure 57).

We find that DAC is deployed at scale at a cost of less than \$380/tCO₂ for EDACCS, (resp. \$450/tCO₂ and \$520/tCO₂ for wind and solar). However, the gigaton scale is reached only in 2065 and 2070 (Appendix 3).

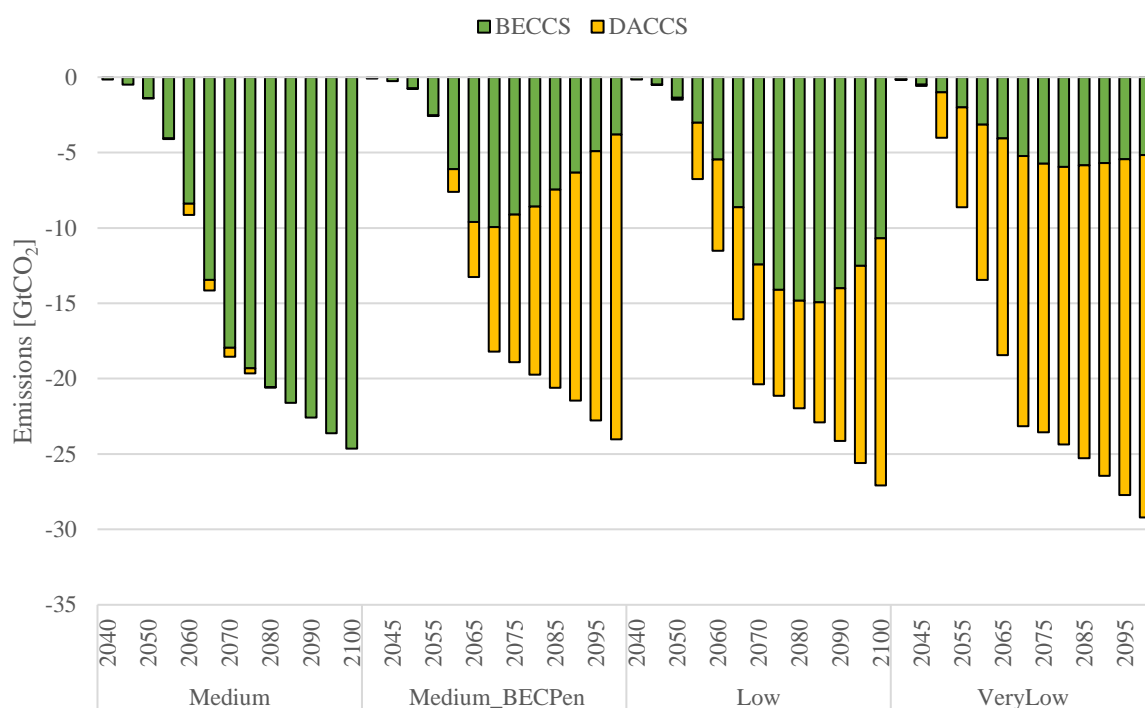

Figure 56: Temporal generation of negative emissions of for a medium, low, and very low cost of DAC

The major regions involved in the generation of negative emissions through DACCS are Africa, Indonesia, Canada, and Brazil. Canada is generating all its negative emissions from DAC with grid electricity which is fully decarbonized by 2035 and sold at prices that are 10-26% lower than the US thanks to cheap wind and large hydroelectricity capacities. Africa initially relies on grid electricity to run DACCS units through mid-century, benefiting from a fully decarbonized power system, but as the price of renewables continues to decline (reaching around \$30/MWh by the end of the century), it becomes more competitive to run stand-alone DACCS units powered with dedicated wind or solar. We observe the same in Indonesia and Brazil. Thus, employing dedicated renewables for DACCS presents an opportunity to generate massive amounts of negative emissions late in the century.

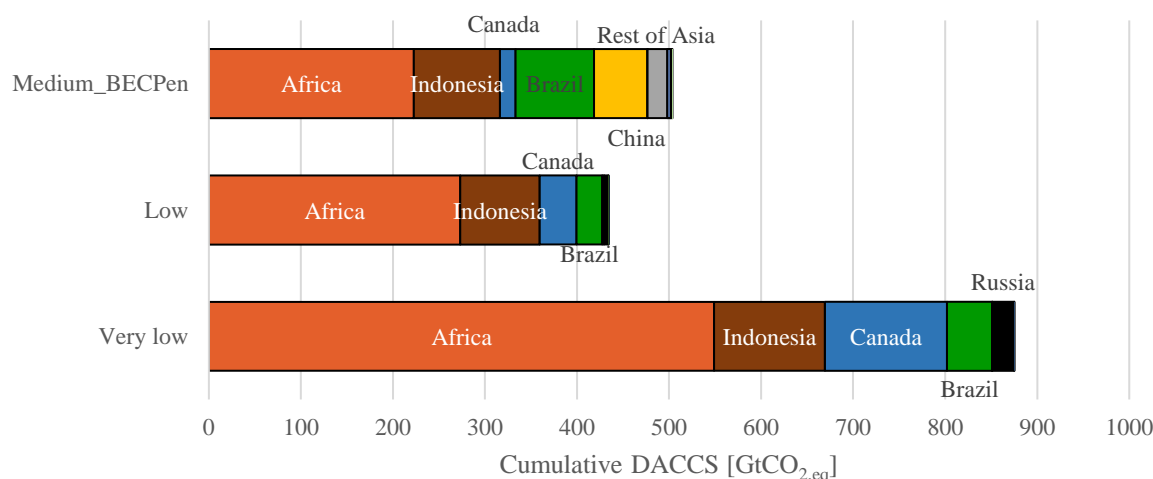

Figure 57: Cumulative regional negative emissions through DACCS in the Low and Very low cases

Synthetic fuels generation with DAC remains small, even in the *Very low* case, utilizing less than 0.7% of the total amount of carbon captured from the air over the century. This represents 6.1 GtCO₂ turned into 1 EJ of synthetic fuels, of which 93% is generated between 2095 and 2100. These results contrast with the ones of Akimoto et al. (2021).

In order to enlarge the window of uncertainty related to the potential of DAC, we consider another scenario with a medium cost and a limited expansion of BECCS. It reveals that DACCS deployment is very sensitive to the availability of BECCS, as 59% of the cumulated negative emissions is generated from DACCS compared to 1.3% in the original case (Figure 56), which represents 504 and 12 GtCO₂ of cumulative negative emissions, respectively. Even for a high-cost DAC, the technology competes with BECCS when the latter is constrained, i.e., DACCS contributes 24% of total negative emissions, but deploys after 2080 with 173 GtCO₂ cumulated.

3.1.2. How do regionalized costs affect DAC deployment?

The above results assume globally uniform capital costs for DAC units themselves but do factor in regional variation for the cost of the electricity needed to run the units and for the cost of CO₂ transport and storage (see Section 3.3). However, it is questionable that DAC costs are uniform globally, and so we also consider regionalized capital costs for DAC based on the capital scalars presented in Table 49. The first regionalization approach refers to the regional financial risk for investors to invest in low-carbon technologies such as DAC. It is considered through the Weighted Average Capital Cost (WACC). The second regionalization approach takes into account the more or less easy access to capital in different countries.

Table 49: Regional variation of DAC according to WACC and capital scalars

Region	USA	CAN	MEX	JPN	ANZ	EUR	ROE	RUS	ASI
WACC (Ameli et al., 2021)	5,1%	5,4%	11,8%	2,4%	6,1%	4,2%	5,8%	5,8%	6,8%
Capital scalar (Ferrari et al., 2019)									
relative to USA	1,00	1,14	1,03	0,97	1,06	1,06	0,98	0,98	0,98
Region	CHN	IND	BRA	AFR	MES	LAM	REA	KOR	IDZ
WACC	6,6%	8,2%	9,2%	11,8%	6,8%	9,2%	6,8%	6,8%	6,8%
Capital scalar relative to USA	0,82	0,99	1,03	1,10	0,97	1,03	0,98	0,97	0,98

In Figure 58, we show the regional deployment of DACCS considering these two regional assumptions for a *Low* cost case. The scenario *Baseline* refers to the case where costs are not regionalized.

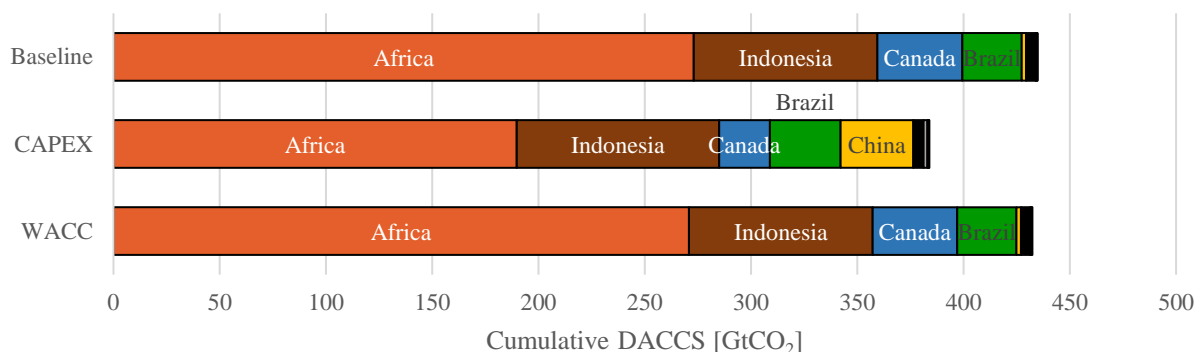

Figure 58: Regional cumulative negative emissions from DACCS for a Low cost scenario

The results suggest that regionalization does not matter when WACC is regionalized. When regionalizing through CAPEX, the regions deploying DAC are the same, but the levels differ, especially in China and Africa. The overall deployment slightly decreases from 432 GtCO₂ to 384 GtCO₂. Thus, considering regionalized capital scalars for DAC impacts the regional deployment but does not change the global quantity significantly.

3.1.3. What if no Emission Trading System (ETS) emerges?

The results in the previous section all assume GHG trading across regions. In that setting, several regions produce negative emissions for sale abroad, especially Africa, Latin America, Brazil and Indonesia. Under the *Medium* cost case, nearly all of the negative emissions are from BECCS, so the countries benefiting most from the sale of offsets abroad are those rich in land and biomass resources. When BECCS is limited, many of the regions that would have produced more BECCS if possible switch to DACCS to continue to sell permits abroad. Indonesia and Brazil are examples (Figure 59). Whether produced by BECCS or DACCS, the trade of negative emissions depends on a high level of international cooperation and the establishment of an emissions trading system (ETS) that is maintained over the century. This leads to the question of how realistic the assumption of a global emissions trading system is.

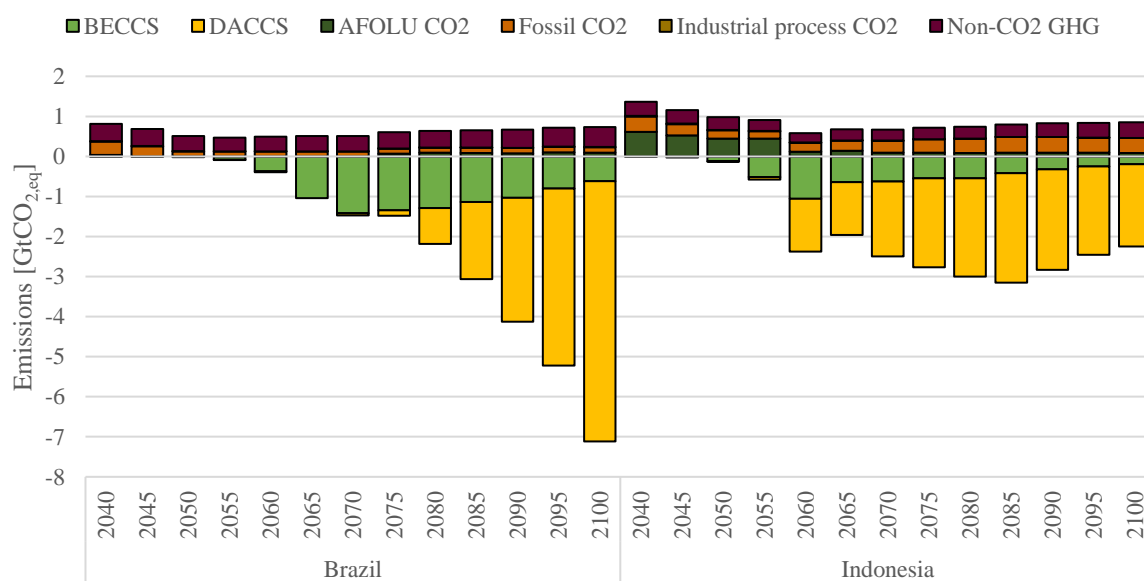

Figure 59: Temporal GHG emissions in Brazil and Indonesia with Medium cost of DAC and penalty on BECCS

One can imagine a future in which no international emissions trading scheme ever emerges, considering the slow pace of discussions currently and the wide range of political relations between countries. Therefore, we explore the deployment of DAC in scenarios where GHG trading is only allowed between GHGs within a region, but not between different regions, focusing on the *Medium* cost case. Under these assumptions, DACCS appears essential in achieving the climate target, (Figure 60), especially for countries having low access to BECCS and afforestation solutions, such as South Korea and Japan, and those for which land-based NET options are expensive or cannot compete with other demands for land (e.g. for food), such as China and India. Thus, DACCS availability is beneficial to some regions more than others when international GHG trading is not allowed. Without GHG trading, regions or countries such as the US, Rest of Europe (ROE), Rest of Asia (REA), Mexico (MEX), Brazil (BRA) or Latin America (LAM) can no longer export permits generated from BECCS, and many other regions will not deploy their own BECCS due to scarce and/or expensive access to land and bioenergy, and so the global amount of BECCS over the course of the century is reduced significantly (from 891 GtCO₂ with international emissions trading to 347 GtCO₂ without trading). In Indonesia (IDZ) and Africa (AFR), the permits generated from DACCS were being produced for export, so are no longer generated without global emissions trading. Conversely, in the absence of global emissions trading, China (CHN), India (IND), Korea (SKO), Japan (JPN), and the Middle East (MES) deploy DACCS either because BECCS cannot fulfill their own demand for offsets, or because DACCS is more competitive than BECCS. China and India alone generate 73% of global negative emissions from DACCS in that case, and globally the cumulative amount of negative emissions from DACCS increases significantly (from 12 GtCO₂ with international emissions trading to 300 GtCO₂ without trading). Nevertheless, BECCS still dominates the market globally. Note that, even for a high-cost DAC, the technology is deployed at scale in the aforementioned countries and regions with 135 GtCO₂ cumulatively over the century, of which 49% are in India (resp. 30% in China).

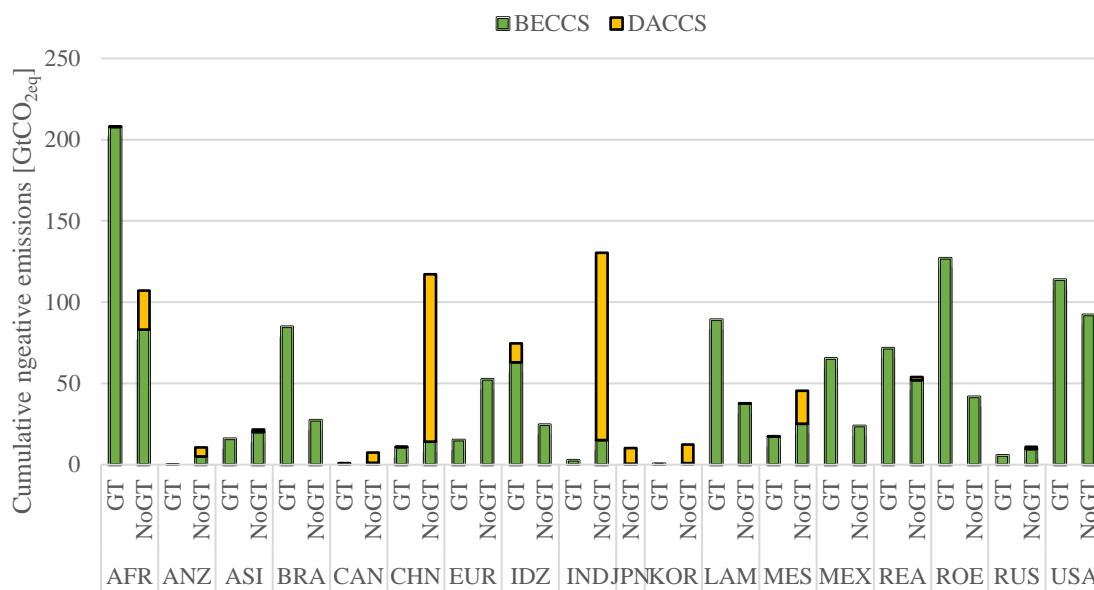

Figure 60: Cumulative regional generation of negative emissions in scenarios with GHG trading across regions (GT) and without GHG trading across regions (NoGT) in a Medium cost DAC case

The magnitude of these results raises questions about the feasibility of storing such amounts of CO₂. Based on the regional CO₂ storage assessment of Kearns et al. (2017), the limited availability of CO₂ storage capacities of India, South Korea and Japan might compromise the deployment of DACCS in these regions.

3.2. Implications of DAC deployment

To discuss the implications of DAC deployment, we focus on the *Medium* cost case of DAC ($\$420\text{--}570/\text{tCO}_2$), as it appears to us as a reasonable assumption for the future techno-economic performances of this technology (Herzog, 2022).

3.2.1. Energy system

Although important in some scenarios to achieve the climate target, DACCS also stresses the power sector, as illustrated in Figure 61. In the *Medium* cost case with a penalty on BECCS, the electricity dedicated to DACCS uses up to 13% of total electricity generation. As the deployment of BECCS is limited, less power is generated from this process, and additional power is needed to run DAC units, which explains why the total power is higher than in the *Medium* cost case (+10%), but the total electricity supplied to other sectors is reduced (-4%). However, this profile can be very different at the country level. For instance, Indonesia and Brazil generate more electricity for the DAC units than for their own consumption (Figure 62). The electricity used to run the DAC units comes from dedicated wind and solar, which suggests that these countries take advantage of their huge and cheap renewable potential to generate profits from selling permits to other countries. Nevertheless, the profile of the Brazilian and Indonesian power systems raises questions about the consistency of such a strategy with other development goals and social/political acceptance of such a huge roll-out of wind turbines and solar farms just to generate emissions permits.

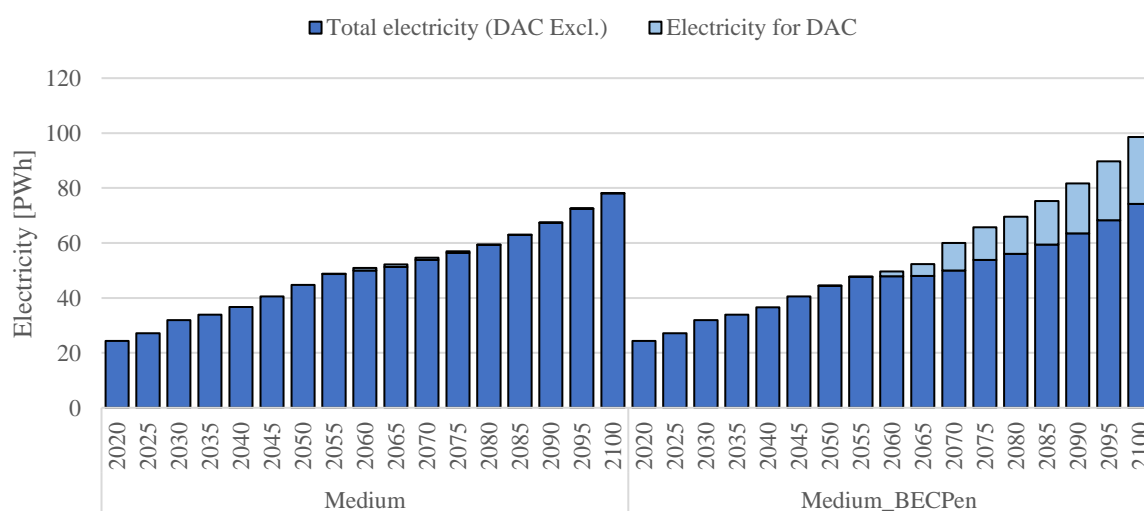

Figure 61: Global electricity generation in a *Medium* cost with BECCS penalty (right) or not (left)

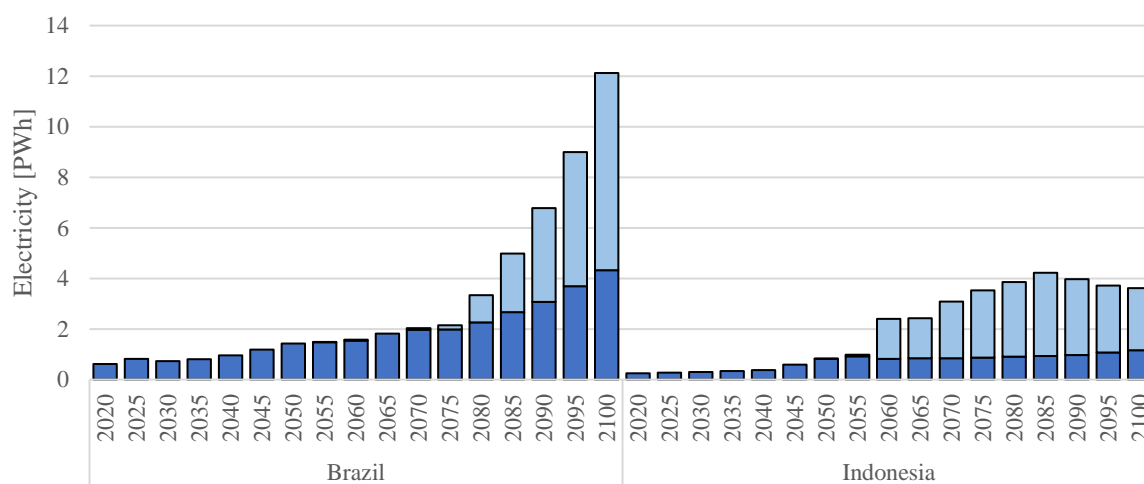

Figure 62: Electricity generation in Brazil and Indonesia in the *Medium_BECPen* scenario

3.2.2. Economics

In terms of economic implications, the stakes are high if DACCS is to be deployed at scale. When comparing the price of CO₂ in cases where DAC is available or not, we observe a clear decoupling of the values at the moment DACCS is deployed (Figure 63), enabling a reduction of up to \$150/tCO₂ compared to the baseline (*NoDAC*), depending on the cost assumption for DAC, which is consistent with other findings (e.g. Akimoto et al., 2021; Marcucci et al., 2017; Realmonte et al., 2019). However, such benefit is only brought when the cost of DAC is considered low to very low. Focusing on the *Medium* case with BECCS restricted, it is clearly favorable to consider implementing DACCS as BECCS cannot provide enough emissions permits to cap the price of CO₂. Consequently, gains in GDP can be as high as 11% at the global level when comparing the *Medium_BECPen* scenario with a scenario when there is no DAC and a BECCS penalty. As Figure 64 shows, the price of CO₂ tends to decrease over time in cases where DACCS is massively deployed. This is explained by the decrease of the price of electricity in the regions deploying DACCS and especially those consuming cheap renewables. For example, in the *VeryLow* case, the price of CO₂ is reduced by 25% in the period 2070-2100.

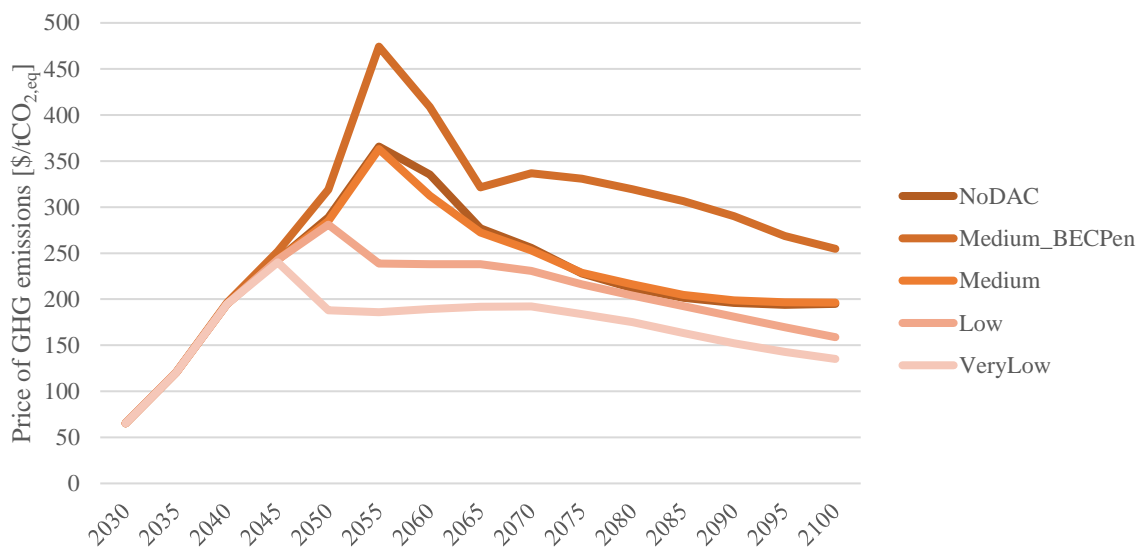

Figure 63: Effect of DACCS deployment to the global price of GHG emissions

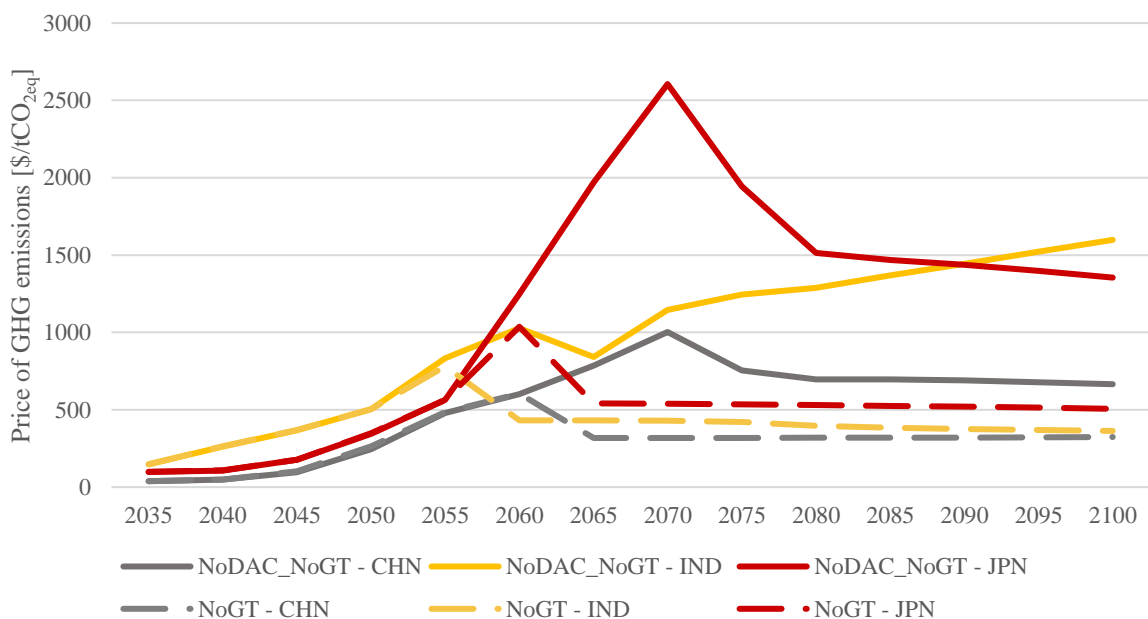

Figure 64: Effect on DACCS deployment to the price of GHG emissions when emissions trading across regions is disabled

The benefits of DACCS are even more substantial at the national level for regions relying substantially on NETs to achieve their decarbonization when international GHG trading is not allowed, namely South Korea, Japan, China and India. In Figure 64, we observe a clear decoupling between the solid lines, representing the price of CO₂ without ETS and DAC, and the dashed lines when there is no ETS but DACCS is deployed. In turn, over the century, China, and India could save between 4% and 8% of their GDP if DAC is available in a world without global emissions trading compared to if DAC is not available. Therefore, for some regions, the issues behind DAC availability may be of great importance if no international ETS emerges.

3.2.3. Land use

As some scenarios deploy large amounts of DACCS, we evaluate the land use requirements *ad hoc*. Based on NREL data, we assume that the total land use of wind (resp. solar PV) power requires 16±10 ha/GWh.y⁻¹ (resp. 1.8 ha/GWh.y⁻¹) and installing a 1 Mtpa low-temperature DAC unit requires 81-506ha (NASEM, 2019). With these values, we evaluate the land footprint of all DAC units – no matter how they are supplied – plus the dedicated renewables required to supply them (but we do not consider the incremental land increases embedded in grid electricity that is distributed to DAC units as we do not know the origin of electrons in this case).

Depending on the assumptions (low end or high end of the range), we estimate that land requirements can vary by up to three times (Figure 65). These values should be compared with the land use of BECCS in the scenario where there is no DAC, which is 8.4 Mkm². In the *Very low* case with no global emissions trading, the land use required reaches up to 1.14 Mkm², of which 37% is allocated to India, which suggests that 13% of the country would be used to generate emissions permits through DAC. Our results appear more realistic in the *Medium_NoGT* scenario, where the maximum land use for DACCS and its power supply is 0.48 Mkm² dispatched over regions (Figure 66). Nonetheless, 0.2% of China’s territory would be covered by large machines scrubbing CO₂ from the air (dark blue bar), excluding the land footprint of grid electrons. Japan would need to develop wind energy massively to supply its DAC units, representing 13% of its territory (marine areas excluded), but the land use of DACCS would be less threatening if the wind turbines were installed offshore, or if solar panels substituted wind turbines.

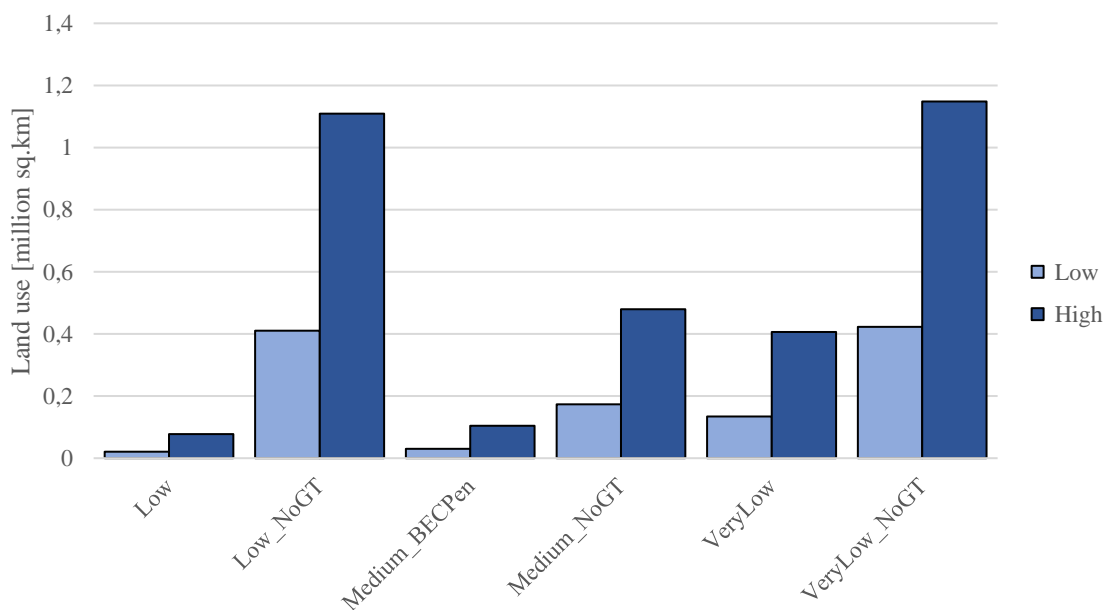

Figure 65: Range of land use requirements for DACCS units and their power supply (wind or solar) in 2070

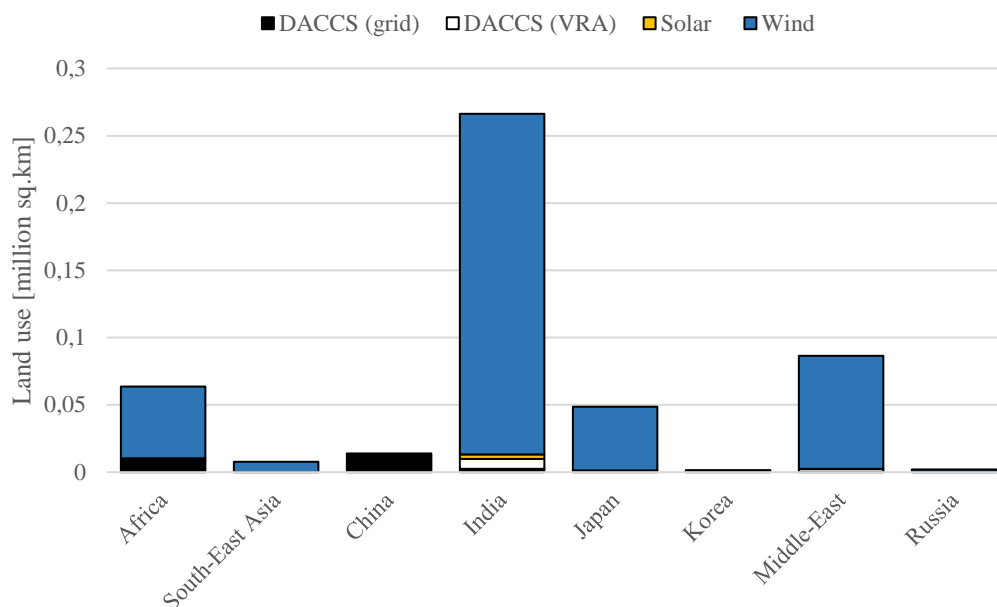

Figure 66: Regional land use requirements for DACCS in the Medium_NoGT scenario in 2070 (high estimate)

Overall, our assessment is very sensitive to the type of energy consumed by DAC units, reflecting the assumptions on wind and solar above, but, contrary to the land required by BECCS, the land required by DAC does not compete with crop areas, as wind turbines can be installed in agricultural fields. If one needs to limit the impact of DAC on total land use, alternative energies to wind power (e.g., nuclear) should be considered, or wind turbines should be set up offshore, when possible, although it would increase the cost of electricity supply.

3.2.4. DAC in advanced countries

One can see that the US and Europe are not deploying DAC in the results displayed above, while these two regions are currently developing projects and funding research programs related to DAC (Clean Air Task Force, 2022; DOE, 2022). Besides, the US is currently subsidizing DAC through tax credits contained in the Inflation Reduction Act (Global CCS Institute, 2022b). In this section, we explore the policy and technical conditions to have DAC deployed in these two regions.

The results of Section 4.1 do not reveal any deployment of DAC in the US or Europe, even for the *Very low* cost case (in which the US and Europe still entirely rely on BECCS to provide both power and CO₂ removal at a price that cannot compete with DACCS), and even in the case where BECCS is penalized. When we assume that no international GHG trading would occur, these regions require a very cheap DAC technology to be competitive with BECCS, and even then, DAC only represents 5% (resp. 2%) of the total negative emissions of Europe (resp. USA). If we assume both a BECCS penalty and no international GHG trading, then DACCS at low or very low cost becomes competitive with BECCS in the US and Europe, i.e. low-cost DACCS contributes to more than 95% of European and American negative emissions. Thus, if BECCS capacities would be limited in the US and Europe, and there was no global emissions trading, then DACCS would replace BECCS for costs approaching \$250/tCO₂. The maximum DACCS deployment observed in these regions, is when BECCS is not available at all, in a world where international GHG trading is not allowed: the US and Europe deploy respectively 89 and 59 Gt of negative emissions cumulated from DACCS, but 99% of that is generated after 2050. Thus, our results suggest that DACCS would only compete with BECCS in Europe and the US under the following policy and technical conditions:

1. No international trading
2. BECCS is either limited or unavailable
3. DAC technology costs fall below \$400/tCO₂

For Europe, our results contrast with the estimates of Lux et al. (2023), who claim that up to 288 Mtpa DAC capacities would be required by 2050 to decarbonize Europe, with a cost between 66 and 104 €/tCO₂ (Lux et al., 2023). Although the emissions reduction target in that study is carbon neutrality by 2050, we argue that their results would be worth discussing with a higher cost of DAC. For the US, Williams et al. (2021) also found that DAC would be necessary if land use was limited (Williams et al., 2021).

3.3. Conclusion

The role of negative emissions in achieving deep decarbonization targets has been demonstrated through Integrated Assessment Models (IAMs). While many studies have focused on bioenergy with carbon capture and storage (BECCS), relatively little attention has been given to direct air capture (DAC) in IAMs beyond assessing the role of low-cost DAC with carbon storage (DACCS). This could be due to a lack of data regarding CO₂ utilization or because expensive DAC is simply not credible to decarbonize our economies efficiently. In this study, we employed an economy-wide model to more fully explore the potential role of DAC, considering the full range of cost estimates (\$180-\$1,000/tCO₂), DAC units supplied by either dedicated renewables or grid electricity, and both the storage of captured CO₂ (DACCS) or its utilization (DACCU) to produce fuels. Our results show that the deployment of DAC is driven by its cost and is dominated by DACCS, with little deployment of DACCU. We analyze the technical and policy conditions making DACCS compete with BECCS, investigating scenarios in which BECCS is limited and there is no emissions trading across countries. With an international emissions trading system (ETS), we find that Africa takes advantage of its large and cheap renewable potential to export emissions permits and contributes more than half of total global negative emissions through DAC. However, DAC also proves essential when no ETS is available, particularly in Asian countries due to scarce and expensive access to land and bioenergy. Finally, we find that DACCS can stress the power sector and use significant amounts of land depending on what energies supply DAC assets.

4. Negative emissions in industry

The industry sector has been discussed in Chapter 1 as a sector that could potentially generate negative emissions other than from DAC or BECCS. Besides, the industry sector is more difficult to decarbonize than the power sector, and negative emission technologies (NETs) for the industry emerge as an interesting option that has not been studied much in former prospective analysis. Notably, the cement industry and the iron and steel industry are the biggest industrial emitters of GHGs and their decarbonization is hampered by the very complexity of their processes, which leads us to employ the bottom-up model here (TIAM-FR). The aim is to understand the technical feasibility of decarbonizing these activities through carbon capture and NETs, among other options.

This analysis is carried out separately, i.e., in subsection 4 we address the research question for the cement industry only, and in subsection 4.2, we address the research question for the iron and steel industry (ISI) only. We made this choice for practical reasons, in particular because the modeling of the cement industry and the ISI were developed separately. Notably, for each, we answer the questions of the potential and contribution of negative emissions technologies (NETs), regional biomass availability, technical feasibility, and trading.

We explore the decarbonization of the cement and steel industry through the *REF* scenario and the *NZ70* plus the following cases.

1. *Carbon neutral steel/cement (ISO/CM0)*: the ISI (resp. cement industry) is forced to achieve carbon neutrality by 2050 (GCCA, 2022; Net Zero Steel, 2021), in addition to achieving the global net-zero target by 2070. We assume a global GHG trade system available in 2030 dedicated to steel and cement emissions where some regions can achieve larger negative emissions than necessary in order to compensate the net positive emissions in other regions.

2. *Zero emissions by region (ISO_R/CMO_R)*: each region of the world commits to decarbonize its own steel (resp. cement) industry by 2050. Emissions permits are not traded among regions, but biomass trading is allowed and can help some regions to generate negative emissions.
3. *GWP of biomass (ISB/CMB)*: biomass carbon neutrality, as generally assumed in models and calculations, has increasingly been demonstrated as incorrect and misleading (Norton et al., 2019; Slade et al., 2018), because the period of time during which the biomass regrowth reabsorbs atmospheric CO₂ far exceeds the CO₂ emissions from biomass combustion, thus having the opposite effect of what is called ‘renewable energy’ – this is mainly true for woody biomass and less so for energy crops. Since concerns are expressed regarding the climate effectiveness of bioenergy in fighting climate change, we analyze the decarbonization potential of the ISI and cement industry by varying the carbon debt of bioenergy. Instead of considering that burning biomass emits zero emissions and that storing 1 ton of biogenic CO₂ generates 1 ton of negative emissions, we assign a GWP potential, based on the rotation period for growing biomass (Guest et al. 2013). We distinguish two cases corresponding to the GWP of biomass depending on the rotation period (Table 50, Table 49).

Rotation (years)	GWP (kgCO _{2eq} /kgCO ₂)	Scenarios
50	-0.8	<i>ISB50/CMB50</i>
100	-0.56	<i>ISB100/CMB100</i>

Table 50: Biogenic GWP factor values for specific rotation periods

4. For the final scenario (*ISB0/CMB0*) we assume that biomass use for industrial activities is prohibited as of 2030 due to sustainability concerns.

This work was carried out in close cooperation with Dr. Carlos Andrade, Research Engineer at IFP Energies Nouvelles, during his post-doctoral research on the role of Negative Emissions Technologies (NET) for long-term decarbonization of the industry sector.

4.1. The cement industry

In this first analysis, we explore the decarbonization of the cement sector through the *REF* scenario and the *NZ70* plus the following two cases.

1. *Carbon neutral cement (CMO)*: this forces the cement industry to achieve carbon neutrality by 2050 for developed regions (AUS, CAN, JPN, SKO, USA, WEU) and by 2060 for developing regions (AFR, CHI, CSA, EEU, FSU, IND, MEA, MEX, ODA), in addition to achieving the global net-zero target by 2070. Through this ambitious target, it will be possible to analyze more deeply the potential contribution of NETs, as the model is set to compensate the residual CO₂ emissions released by fossil-based processes. We assume a global GHG trade system dedicated to cementitious emissions where some regions can achieve larger negative emissions than necessary in order to compensate the net positive emissions of other regions. Until 2050, only developed regions can trade CO₂ emissions, and from 2060 all regions can trade emissions.
2. *Zero emissions by region (CMO_R)*: establishing this kind of global CO₂ trading system might be hard to achieve. Thereby, each region of the world commits to decarbonize its own cement industry. However, biomass trade between regions is allowed and may be substantial since some regions could lack biomass to generate sufficient negative emissions. Similar assumptions to *ISO* and *CMO* are followed: developed regions commit to achieve carbon neutrality by 2050, and developing regions by 2060.

In our reference scenario, the levels of CO₂ emissions from the cement industry drop dramatically as of 2050 (Figure 67), partly because countries pledge to climate neutrality and especially because China halves the emissions of its cement industry to reach carbon neutrality by 2060. Hence, the cement industry’s global CO₂ emissions are divided by 3 in 2050 compared to 2018 levels, and by 9 in 2070. Thus, even in the reference scenario, tremendous efforts are required, and the cement industry is called on to contribute. In 2070, 20% of the remaining emissions are combustion CO₂, while representing 45% of the total bulk in 2018, indicating that the energy mix is transformed. Consequently, the incremental

effort for the cement industry to become carbon-neutral is not as great as might be expected. Thus, negative emissions are not required for the cement sector in the *REF* scenario (see Section 1.1) of this chapter).

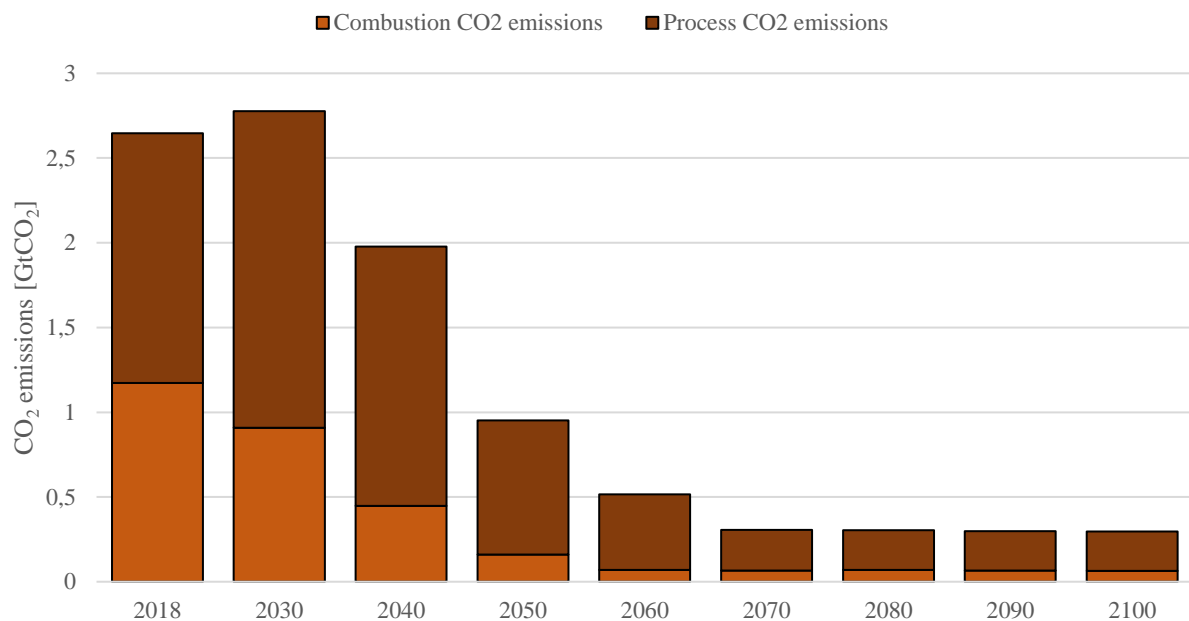

Figure 67: Global CO₂ emissions from the cement industry in the reference scenario

4.1.1. To what extent can NETs help decarbonize the cement sector?

Here, we observe how the cement industry evolves when both the global energy system and the cement industry are more constrained than in the *REF* scenario (Figure 68). In the *NZ70* scenario, combustion CO₂ emissions fall to almost zero, leaving less than 200 Mt of process CO₂. In the meantime, negative emissions from the cement industry are almost useless: only India generates 33 Mt of cement-related CO₂ permits in 2050 so that Canada and the US can achieve their NDCs.

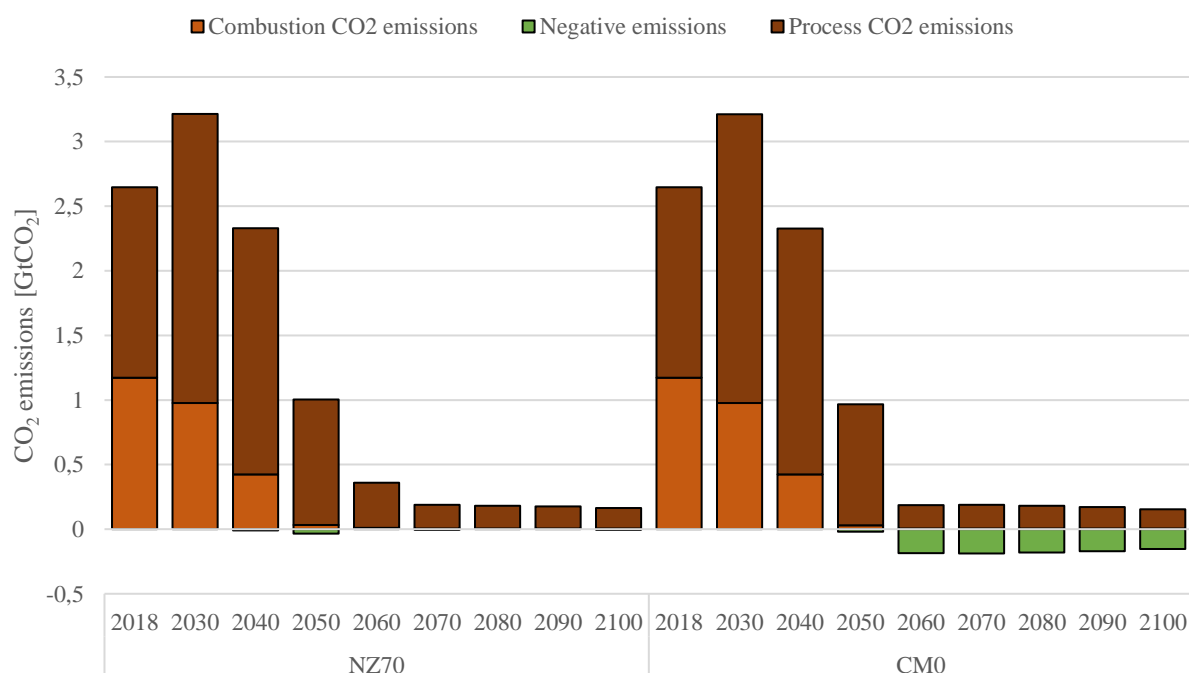

Figure 68: Global CO₂ emissions of the cement industry in NZ70 and CM0

In the *CM0* scenario, the cement industry is set to reach carbon neutrality, so negative emissions compensate for the remaining process emissions, but not all regions contribute equally to this effort. When comparing the regions generating CO₂ permits in the *CM0* and *CM0_R* scenarios, the net quantity of offsets does not change but they are distributed unevenly (Figure 69). In the *CM0* scenario, China achieves carbon neutrality in its cement industry by importing CO₂ permits from South-East Asia (ODA), Mexico (MEX), the Middle-East (MEA), and Western Europe (WEU), while India buys permits for cement plants from South America (CSA).

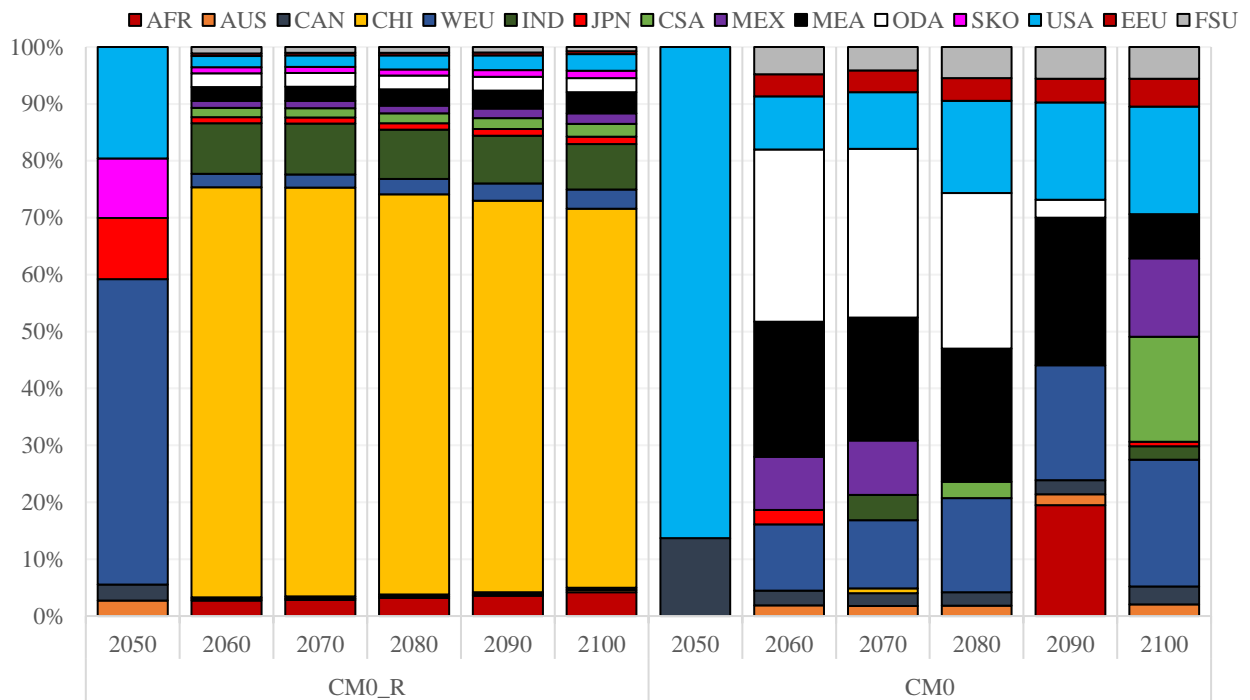

Figure 69: Regional generation of negative emissions for the cement industry in the *CM0* and *CM0_R* scenarios

Thus, our results show through the *REF* scenario and the *NZ70* scenario that negative emissions for the cement industry are not critical, but it is essential to cut combustion emissions and process CO₂ emissions as much as possible. Then, if the cement industry commits to carbon neutrality, negative emissions should be deployed globally by less than 200 MtCO₂. Therefore, efforts should be concentrated on alternative technologies and fuels to decarbonize this industry.

4.1.2. How the industry combines technology and fuels to decarbonize cement?

The alternative technologies for the cement industry are essentially plants with optimized energy consumption (dry processes) or plants equipped with carbon capture units of different kinds (see Chapter 3). In addition, end-of-the-pipe techniques to reduce clinker share in cement composition can be employed. This process consists in replacing the limestone and gypsum of cement with mineralized aggregates (cf. Section 2) and increasing the share of aggregates in cement composition. In Figure 70, mixing processes with only 65% clinker appear to be a no-regret investment whatever the policy scenario. Indeed, reducing the clinker share in cement composition reduces the overall energy required to manufacture one ton of cement. In 2030, most of the initial cement production is replaced with processes mixing clinker with 5% alternative aggregates composed entirely by steel slags (Figure 71). In 2050, it starts to be ground with limestone too, and in 2070 and beyond, mineralized slag and fly ash from coal combustion in the power sector represent roughly 15 to 22% of aggregates composition, or 10 to 15% of cement composition. Thus, this alternative cement production pathway reduces energy consumption for clinker production, which avoids the emission of process and combustion CO₂ in cement plants.

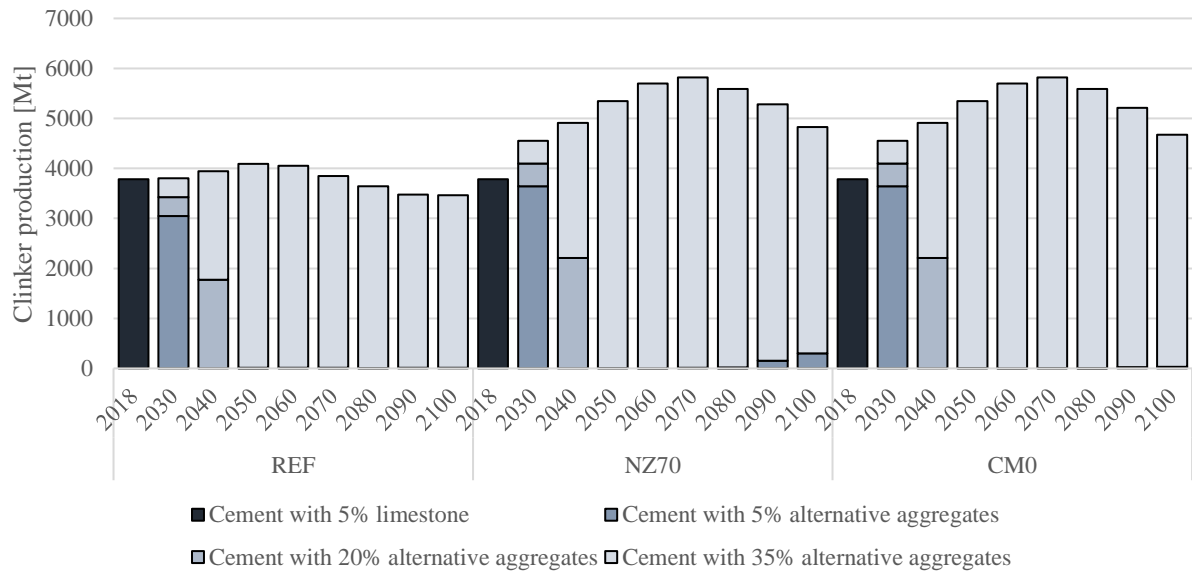

Figure 70: Composition of cement in the REF, NZ70, and CM0 scenarios

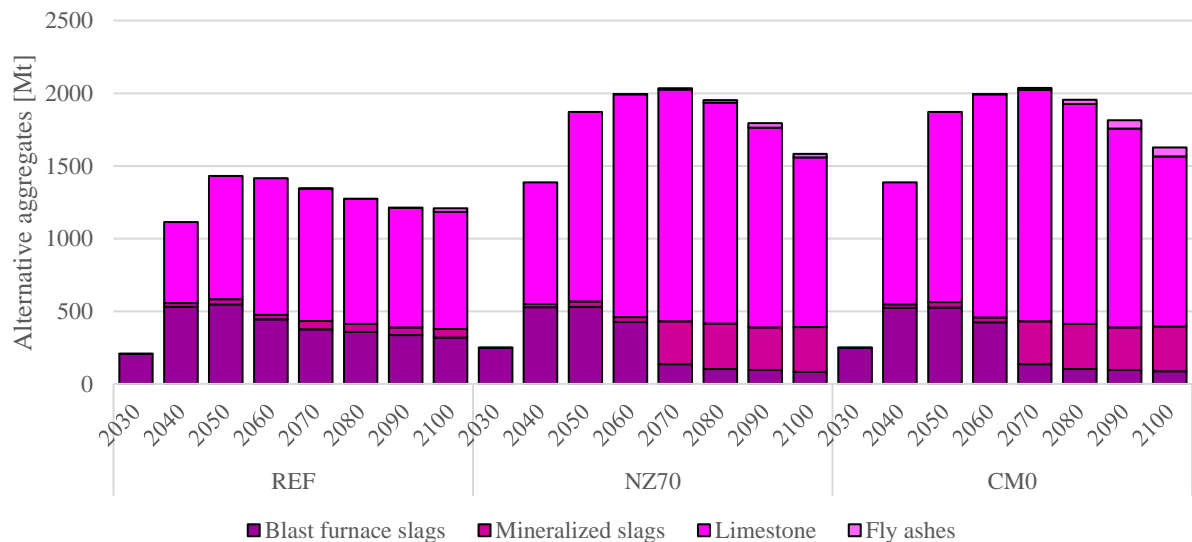
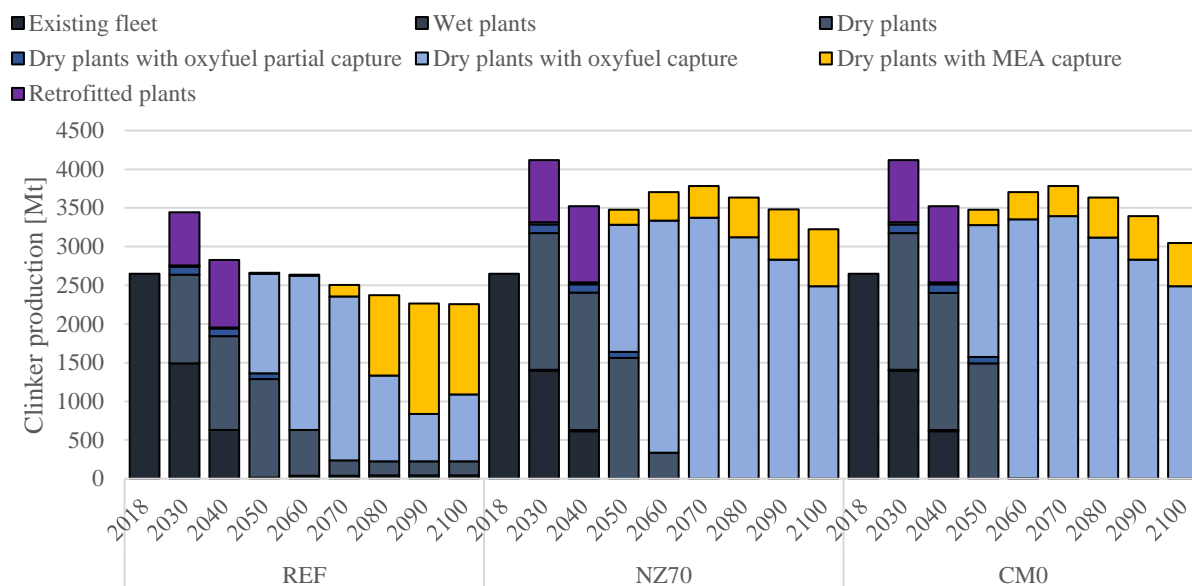
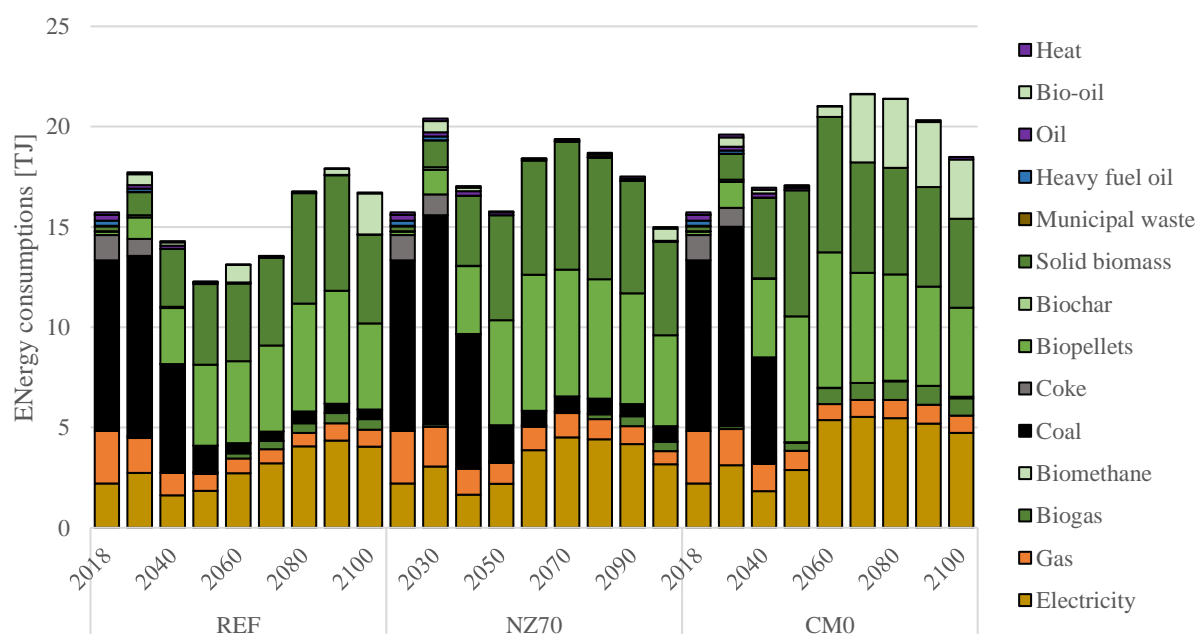

Figure 71: Global composition of alternative aggregates in the REF, NZ70 and CM0 scenarios

With regard to the technologies that produce clinker (Figure 72), the existing processes are either replaced with new dry plants or retrofitted with carbon capture as of 2030, the latter ensuring 20% of global clinker production. Besides, small capacities of new plants equipped with oxyfuel capture produce 3.5% of global production. The initial processes are then progressively phased-out by 2050, making way for new dry plants equipped with oxyfuel capture and producing more than 50% of global clinker. This transition pathway is common to all scenarios until 2050. However, in the *NZ70* and *CM0* scenarios, the entire clinker production is ensured by facilities equipped with carbon capture, while some dry and wet process still operate in the *REF* scenario. In all scenarios, the bulk of remaining process CO₂ emissions in Figure 67 and Figure 68 corresponds to emissions that escape capture units. Oxyfuel technology is preferred over monoethanolamine (MEA) technology, as it is less capital intensive and energy intensive. Notably, electricity can be used in oxyfuel technology to manufacture the oxygen required to perform perfect combustion with higher capture rates than when using MEA technology.



Nonetheless, 45% of global production is still produced from energy-intensive dry plants in 2050 across all scenarios, which explains why Figure 67 shows that the cement industry still emits approximately 1 Gt of process CO₂ in 2050. In the meantime, the energy mix of the cement industry in 2050 is almost fully decarbonized in the *REF* and *NZ70* scenarios, thanks to solid biomass, pellets, electricity and biogas (Figure 73). Therefore, biomass plays a great role in the decarbonization of the cement industry. It requires constraining the cement industry to zero CO₂ emissions (*CM0*) to completely phase out coal consumption. Note that the energy consumption of the *CM0* scenario is 8% to 23% greater than in the *NZ70* scenario because there are more oxyfuel plants in the *CM0* scenario and they require more electricity to manufacture oxygen. In addition, there is no significant difference between the energy mix in the *CM0* the *CM0_R* scenarios. In the *CM0_R* scenario, although CO₂ permits are not traded between the cement industries in the world, biomass products are; China increases its biopellet imports by 10% in *CM0_R* compared to *CM0*, resp. 33% in India. This implies that the permits are thus traded indirectly through biomass.



Thus, the cement industry reaches the CO₂ levels observed after 2060 thanks to carbon capture units combined with a bio-based energy mix.

4.1.3. Discussion

Although the cement industry does not achieve carbon neutrality in the *REF* and *NZ70* scenarios, large amounts of negative emissions are generated by cement plants. As Figure 72 and Figure 73 show, bioenergy is combined with carbon capture in dry kilns. However, these quantities of biogenic CO₂ are not used to decarbonize the cement sector *per se* but are instead employed to decarbonize the rest of the industry sector. Figure 74 accounts for the total negative emissions generated by cement kilns in the *CM0* scenario constituting the difference between the negative emissions used to offset cement emissions, and those used to offset the emissions of the rest of the industry. It reveals that the cement industry participates massively in the global decarbonization of the industry sector.

In its net-zero report, the IEA also concludes that the cement industry can save huge amounts of CO₂ by increasing blending of alternative aggregates into cement to lower the portion of clinker (IEA, 2021b). Moreover, carbon capture technologies appear as the most effective technologies to tackle the emissions of cement plants, and they conclude similarly that coal is phased out in 2050 and replaced with gas (40%), and biomass and renewable waste (35%). However, it is not mentioned that the cement industry could turn net negative, and supply other industries with carbon permits. In the strategy of the Global Cement and Concrete Association, who pledge net-zero emissions by 2050, the contribution of bioenergy is unclear (embedded in “alternative fuels”) but may represent up to 9% of emissions savings (GCCA, 2022). We argue that increasing the bioenergy contribution could be worth considering to tackle the environmental and economic aspects of cement decarbonization.

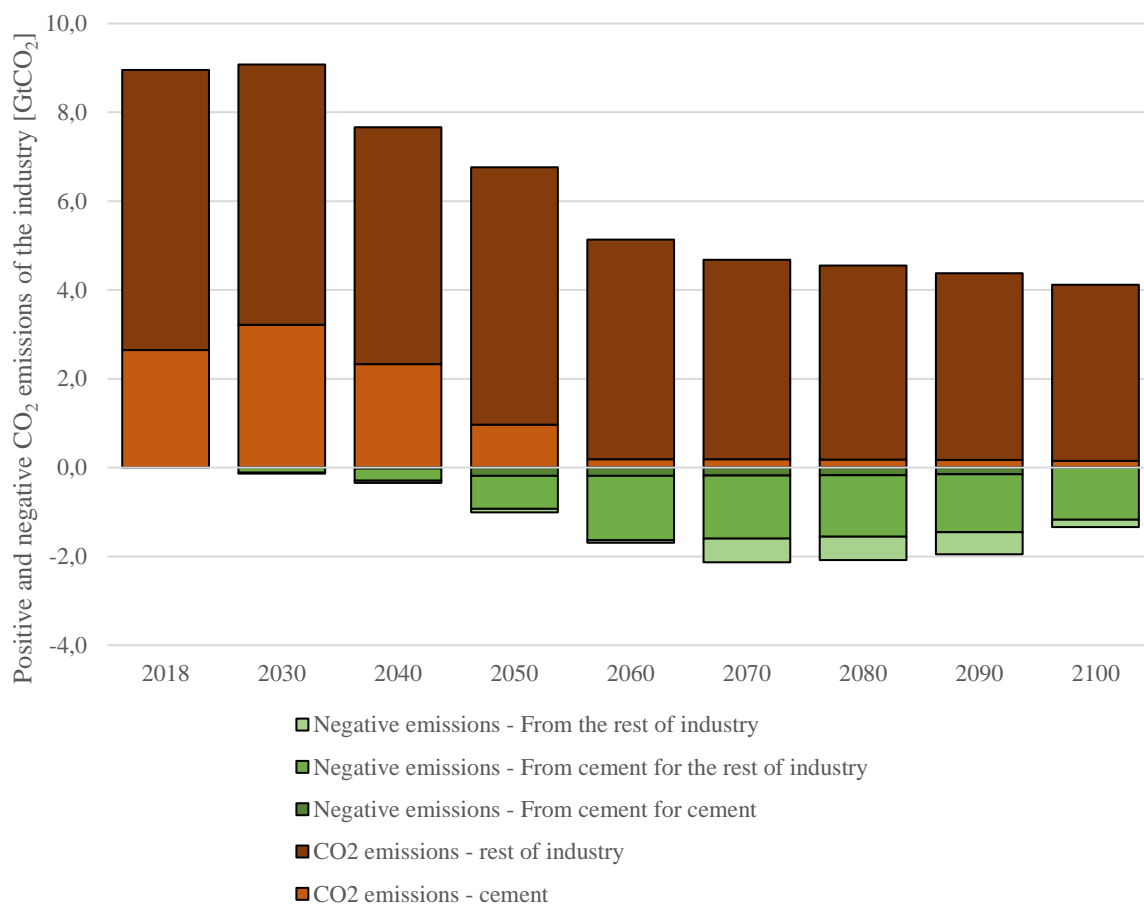

Figure 74: Positive and negative CO₂ emissions from industry in the *CM0* scenario

4.2. The iron and steel industry

In this second analysis of industry, we study the role of NETs in decarbonizing the iron and steel industry (ISI). All the scenarios comprise some parametric constraints. First, the share of the electric arc furnace (EAF) route in total steel production from 2050 is at least 50% of that presented in 2018, and it can represent a maximum 50% of total steel production in regions where scrap-based steel production has been poorly developed, and 60% in those regions that have a high share of EAF in final steel production. Second, by 2050 the share of the blast furnace (BF) route (including CCS and top gas recycling) is limited to 33% of the 2018 share in developing regions, and 25% in developed ones. After 2050, it is possible to stop using the BF route. Third, the share of MIDREX (including the CCS route) can represent a maximum 50% of the total steel output. Finally, the direct reduction of iron with hydrogen (DRI-H₂ route) can represent a maximum 30% of steel production by 2050, after which it is no longer constrained. These constraints are established with the purpose of integrating into the model the fact that the deployment of new technologies has to be progressive as its adoption is limited by several institutional, behavioral, social, and economic factors (Iyer et al. 2015). The different constraints are linearized between periods.

In the reference scenario (*REF*), the levels of CO₂ emissions from the ISI remain relatively constant until 2050, but almost halve by 2060 due to the long-term pledge of China to become CO₂ neutral that year (Figure 75). Emissions then decline slowly from 1.34 Gt to 0.75 Gt by the end of the century. Through this figure, we observe that CO₂ capture is deployed since the levels of process CO₂ emissions are reduced by 83%, while combustion emissions are only reduced by 47%, suggesting that the energy mix is not decarbonized sufficiently. Thus, substantial efforts remain necessary to reach carbon neutrality by 2050.

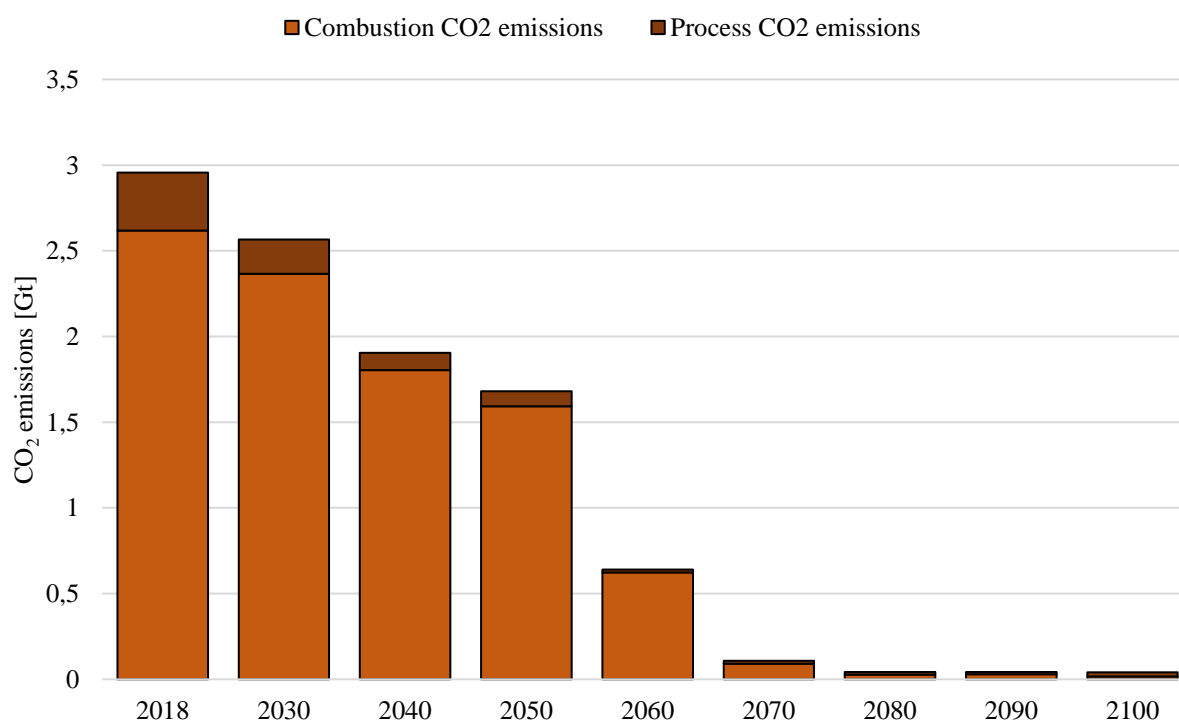

Figure 75: Global CO₂ emissions of the ISI in the reference scenario

Indeed, if the processes that produce steel are renewed by less polluting technologies (Figure 76) – including scrap recycling, direct reduction of iron (DRI), and carbon capture technologies – the biggest

efforts should be concentrated on the final use of energy, which remains largely fossil (Figure 77). Notably, bioenergy is almost absent from the steel energy mix.

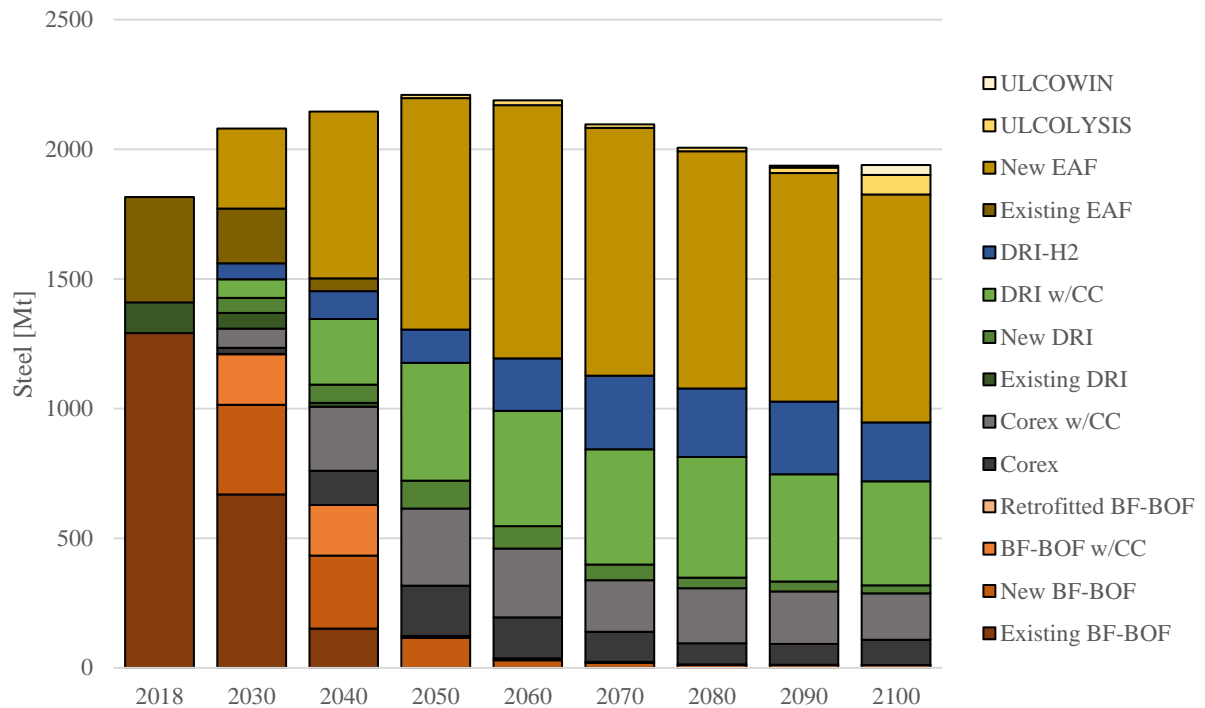

Figure 76: Temporal evolution of the steel industry in the reference scenario

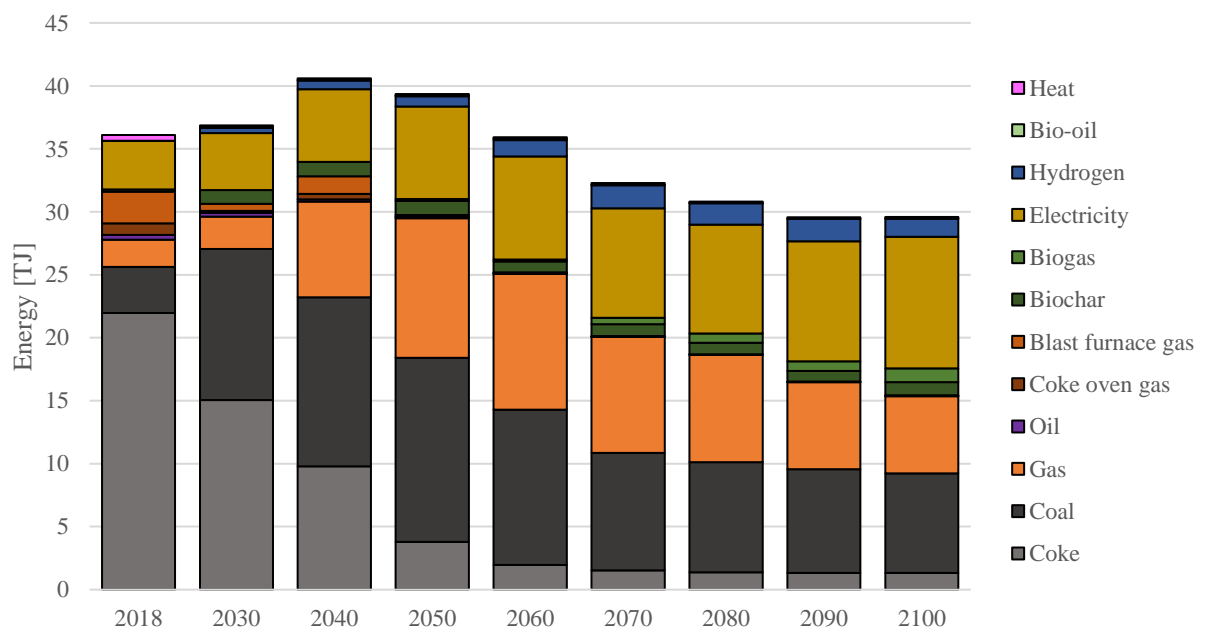

Figure 77: Temporal evolution of the final energy used by the steel industry in the reference scenario

4.2.1. To what extent can help NETs decarbonize steel?

In the NZ70 scenario, negative emissions in the ISI are deployed from 2030 to 2060 at levels below 100 MtCO₂ globally (Figure 78), but Figure 79 shows that these negative emissions are not generated to compensate for the emissions of the ISI itself, but are instead used to offset difficult-to-abate emissions in other industries (e.g., pulp and paper, aluminum, automobile, food).

The ISI generates significant amounts of negative emissions *for the ISI* with roughly 800 MtCO₂ globally in 2050 (Figure 79), but only when the carbon neutrality of the ISI is targeted (*IS0*). However, these huge amounts of negative emissions are deployed during one decade only (2045-2055) to help the ISI achieve the targeted neutrality by compensating the unavoidable combustion emissions of fossil fuels in steel mills. From 2055 to 2075, as the ISI decarbonizes its energy mix, the pressure on negative emissions falls, with roughly 500 Mtpa of negative emissions generated by the ISI for other sectors. Thus, NETs play a transitional role so that the ISI can be CO₂-free by 2050, and in the long term, NETs in the ISI participate in the decarbonization of remaining emissions from other industrial sectors.

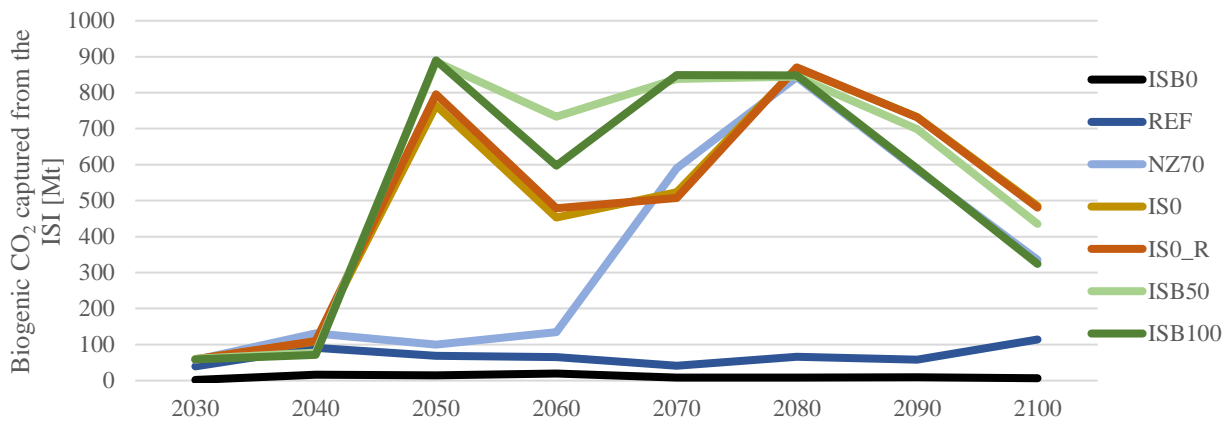

Figure 78: Biogenic CO₂ captured from the ISI across scenarios

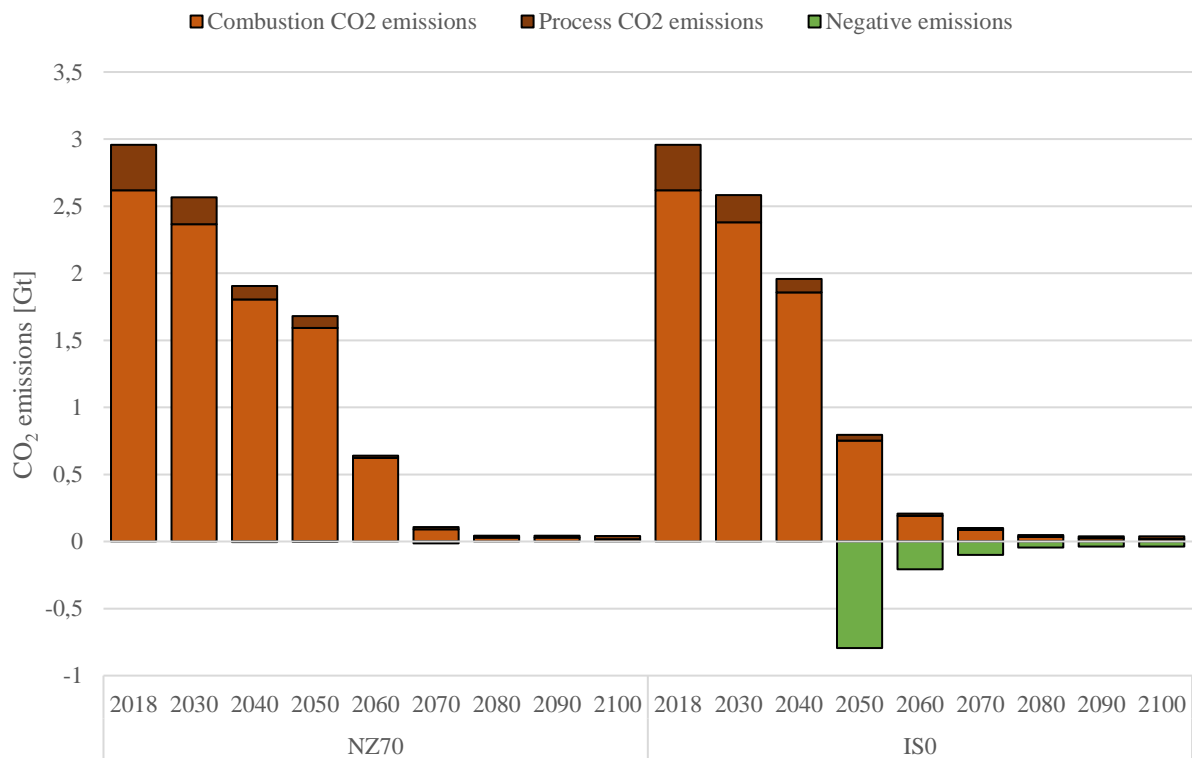

Figure 79: Global CO₂ emissions from the cement industry in the NZ70 and CM0 scenarios

Figure 78 shows that under the *NZ70* scenario, the ISI does not deploy NETs in the mid-term, and that as of 2070 onwards, the level of biogenic CO₂ captured from the ISI is similar to in scenarios targeting net-zero ISI by 2050. Therefore, the policy imposing net-zero steel by 2050 impacts the deployment of NETs. This assumes high rotation periods for biomass involving roughly 20% more negative emissions

to compensate for the emissions from wood harvesting in 2050 and 2060, because substantial amounts of wood are converted into biochar during these periods (Figure 81).

4.2.2. How does the ISI combine energy and processes to decarbonize?

Figure 80 and Figure 81 show the transition pathway of the ISI in terms of technology and energy respectively. Firstly, we observe that the ISI is massively electrified, with 57% of electricity-based steel in 2070, governed by EAF processes constrained to generate up to 50% of global steel production. As the EAF route is less CAPEX-intensive than alternative routes also avoiding raw material costs, and because electricity remains affordable (on average \$80/MWh globally), this recycling route is found to be cost-optimal by the solver. Additional electricity-based capacities of ULCOWIN and ULCOLYSIS are deployed significantly as of 2060, therefore they do not contribute to the decarbonization of the ISI in 2050, but they play a role in the long term.

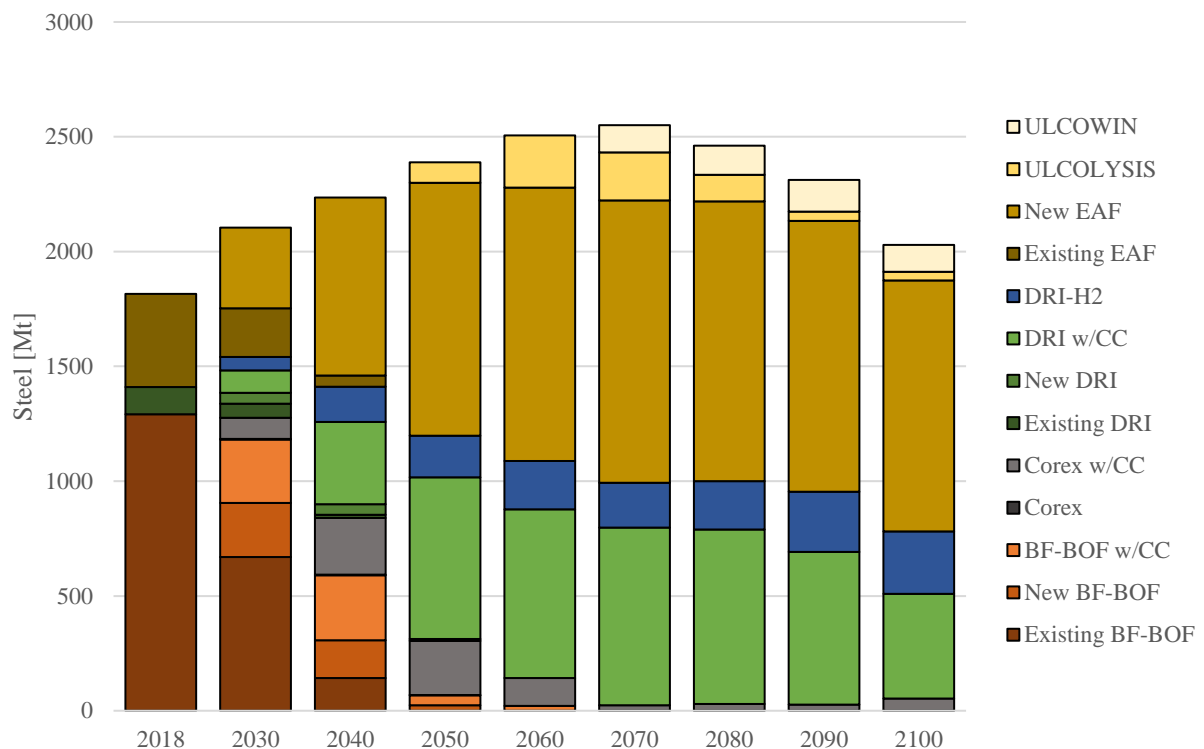

Figure 80: Steel production technologies over the 21st century in the ISO scenario w/CC: with carbon capture

Secondly, the gas used in existing DRI processes is progressively replaced with biogas starting from 2050 to achieve carbon neutrality. Then, biogas almost entirely substitutes gas in DRI processes equipped with capture units, which become the second ranking process to manufacture steel. The biogas employed in DRI is mainly manufactured from the fermentation of wheat (45%), sorghum (32%), and maize (23%), which are first generation biomass, and so potentially raise concerns regarding food security. The biogenic CO₂ captured from this process ensures that residual process emissions of EAF and DRI with carbon capture are offset. It also compensates for the remaining CO₂ emissions of coal combustion in Corex gas in DRI processes.

Hydrogen then becomes the fourth biggest energy carrier, ensuring approximately 5% of steel production in 2050 and 12% in 2070. Hydrogen is employed in DRI-H₂ processes that generate few process emissions. The hydrogen is manufactured from SMR combined with CCS and electrolysis in 2070 by 60% and 23% respectively (see Section 5). We note that Japan and Korea import hydrogen entirely from Australia and base their steel production on EAF and DRI-H₂ because these countries do not have carbon storage capacities and low access to land and bioenergy.

Gas and coal are not completely phased out, as the Corex process runs on coal, and natural gas is also processed in DRI assets. Nevertheless, these two aforementioned processes are equipped with carbon capture units.

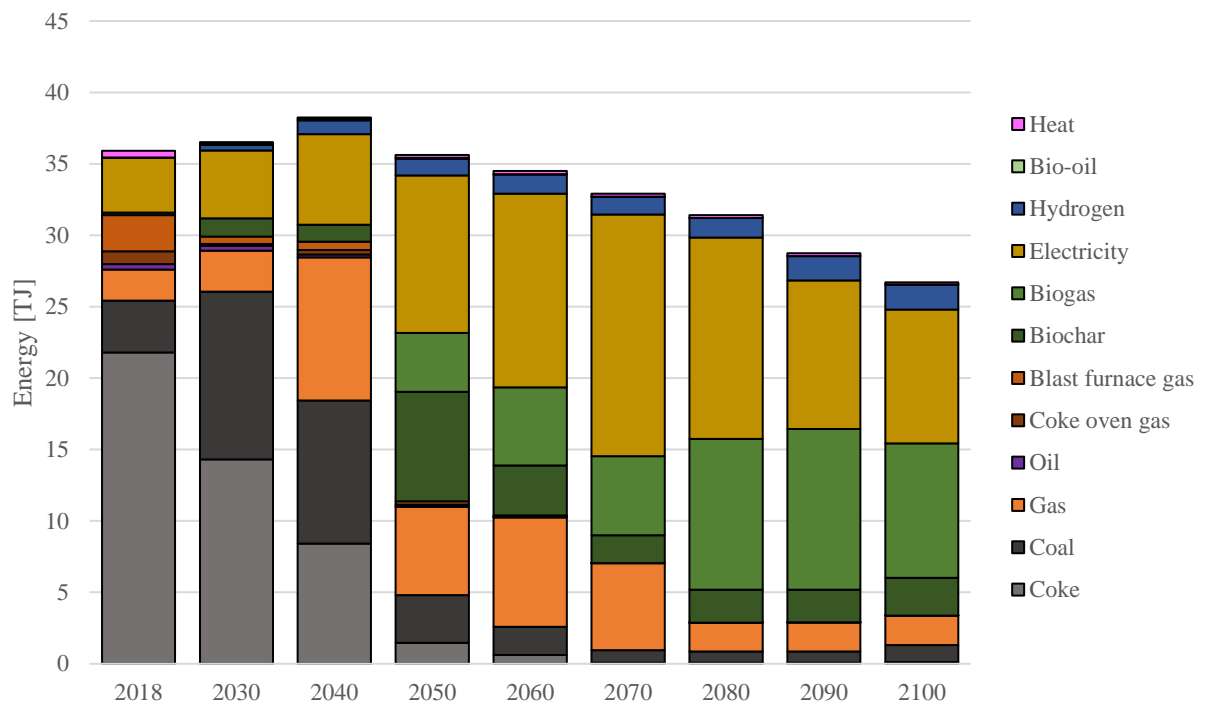

Figure 81: Energy consumption of the ISI over the 21st century in the ISO scenario

The existing BF-BOF assets are progressively phased out by 2070, while they are the main production route today, thus suggesting a drastic transformation of the ISI. Some of these existing units are replaced with BF-BOF equipped with carbon capture, eventually phased out by 2070. Besides, in 2050, we do not observe any deployment of BF-BOF equipped with Top Gas Recycling (TGR) but instead Corex processes are rolled out. These processes are highly energy intensive, and our results show that they are massively supplied with biochar instead of coal in order to generate substantial negative emissions.

Regarding the use of steel scrap, we do not see any significant difference across scenarios (Figure 82). In all scenarios, roughly 70% of steel scrap is exported to the cement sector and recycled as an aggregate, and the remaining 30% are mineralized. We simply note that the share of CO₂ mineralization increases when a policy is established.

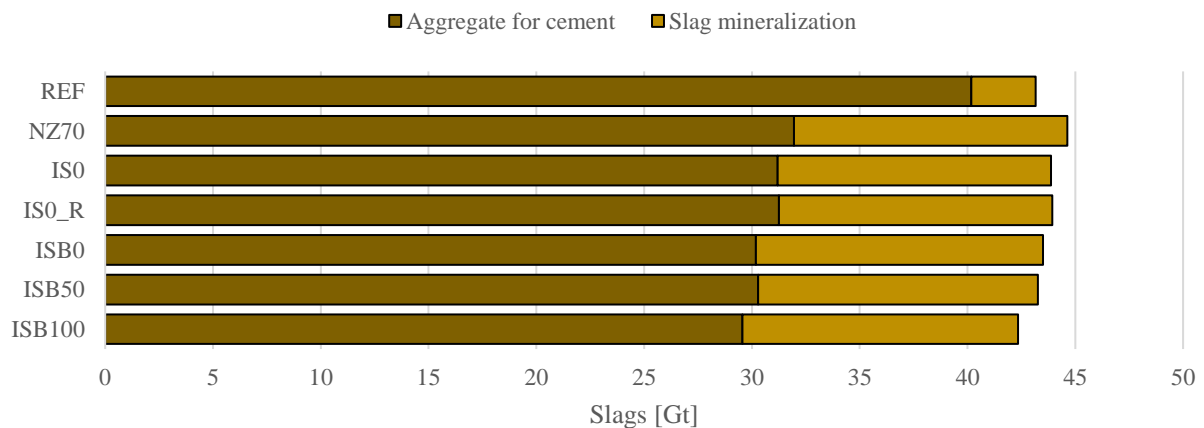

Figure 82: Cumulative scrap use across scenarios

Finally, the average cost of steel is significantly impacted by the non-availability of biomass. While all scenarios report a sharp increase in steel costs in 2050 because of the net-zero target on steel, in the long run the average cost of steel stabilizes at around \$1,000/t, except for the *ISB0* scenario with costs up to \$1,250/t. Less significantly, the most constrained scenarios (*ISO_R*, *ISB50* and *ISB100*) also report slightly higher average steel costs. Even at the level of regions and countries, in the *ISO_R* scenario, there is no significant difference compared to the *ISO* scenario. This result is in line with the very similar technology portfolio between the two scenarios, suggesting that constraining each region to achieve steel decarbonization without trade is not compromising.

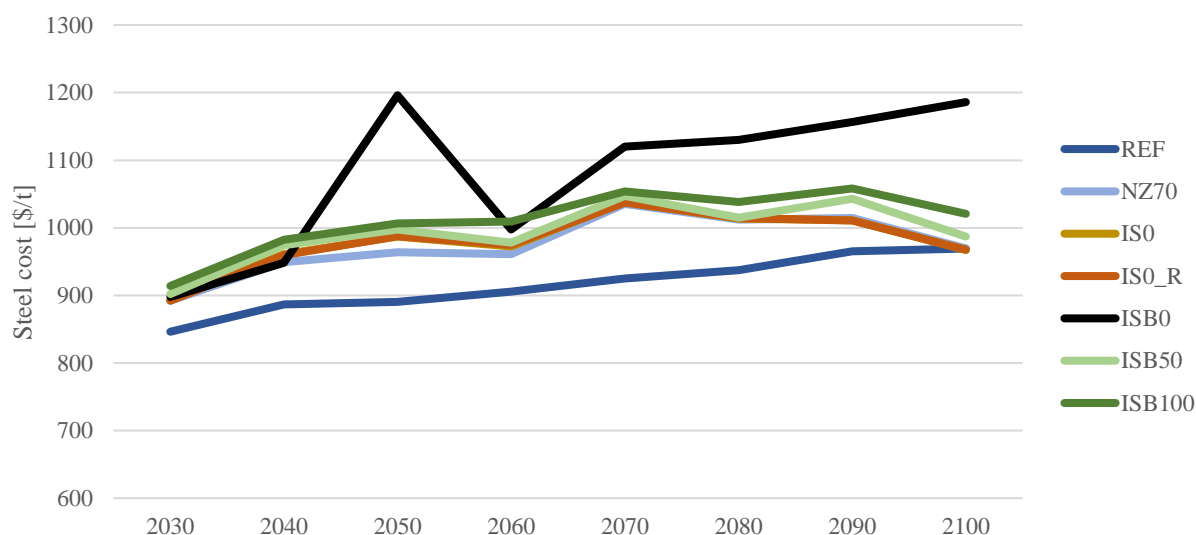

Figure 83: Temporal evolution of steel cost across scenarios

To conclude, electricity becomes one of the most important energy carriers of the ISI as of 2050, in competition with bioenergy supplying DRI processes with biochar and biogas, whose emissions are captured and removed. Conversely, coke is phased out by 2070 while hydrogen starts being deployed slightly in 2030 but contributes to 11-13% of the yearly production from 2050 onwards. The ISI decarbonizes by 1) deploying scrap recycling through electric arc furnaces as much as possible, which helps massively reduce combustion emissions, 2) deploying DRI processes equipped with carbon capture running on biogas, compensating for the process CO₂ emissions, and 3) tackling the remaining emissions with DRI-H₂ processes.

4.2.3. Discussion

These results may be taken into consideration by policymakers and steel companies around the world. In 2022, a study reported that among the 60 largest steel companies, 26 had set their own greenhouse reduction targets (with various timeframes and ambitions), but only 12 had elaborated a strategy (Kuramochi et al., 2022). The work done here would be worth considering for any company interested in planning its transition. Notably, we prove that steel companies could sell CO₂ permits to other industries. Nevertheless, our results should be compared with other studies proposing an optimal technological roadmap towards the decarbonization of the ISI (IEA, 2021b; Morfeldt et al., 2015; Net Zero Steel, 2021).

According to the results of other studies, recycling as much scrap as possible appears to be a no-regret strategy. Today, 22% of steel produced in the world is already recycled (IEA, 2020c), but this share could rise in the future between 30% (Morfeldt et al., 2015) to 46% (Net Zero Steel, 2021) in 2050 – and our results suggest a 46% share.

Even though net-zero emissions are targeted, neither of the studies advocate phasing out coal, although the demand is significantly reduced. Coal remains necessary in low-carbon technologies employing

capture units, such as Corex or convention BF-BOF. However, the contribution of carbon capture is disputed, as it represents 17% in the Net Zero Steel study, but 60% in the IEA study and 50% in (Morfeldt et al., 2015). Consequently, a larger contribution of DRI with hydrogen (29%) is envisioned by the Net Zero Steel study, while we report a maximum of 13%.

Our results stand out from the other studies due to the consideration of bioenergy in the steel industry, which represent up to 38% of the global steel energy supply. The scenario assuming no biomass in the steel industry (*ISB0*) therefore relies more on carbon capture (41% in 2050) and hydrogen (8% in 2050) (Figure 84). In the long run, hydrogen-based capacities become the second most producing route as it emits the least, but the ISI still emits 300 MtCO₂ in 2070. Consequently, the unavailability of bioenergy in the ISI compromises its decarbonization. When assuming a penalty on biomass efficiency in mitigating CO₂ emissions (*ISB50* and *ISB100*), we do not report a significant impact on the global technology mix of the ISI, except that the share of DRI-H₂ is increased by 27%. The share of bioenergy is however slightly reduced by 8%, substituting biogas for biochar. This result suggests that, even with inefficient biomass available, bioenergy is competitive, and thereby required to decarbonize the ISI.

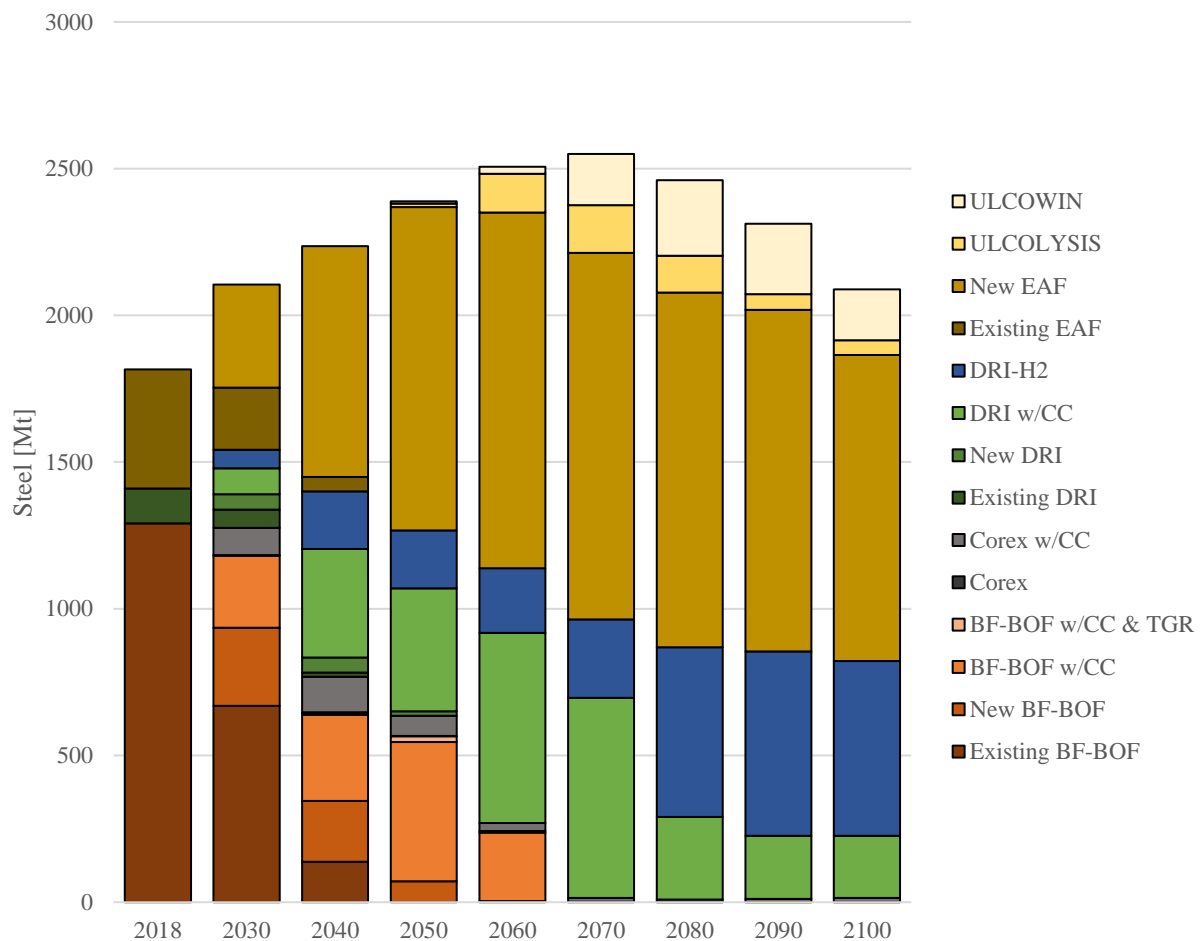

Figure 84: Temporal evolution of global steel technologies in the *ISB0* scenario

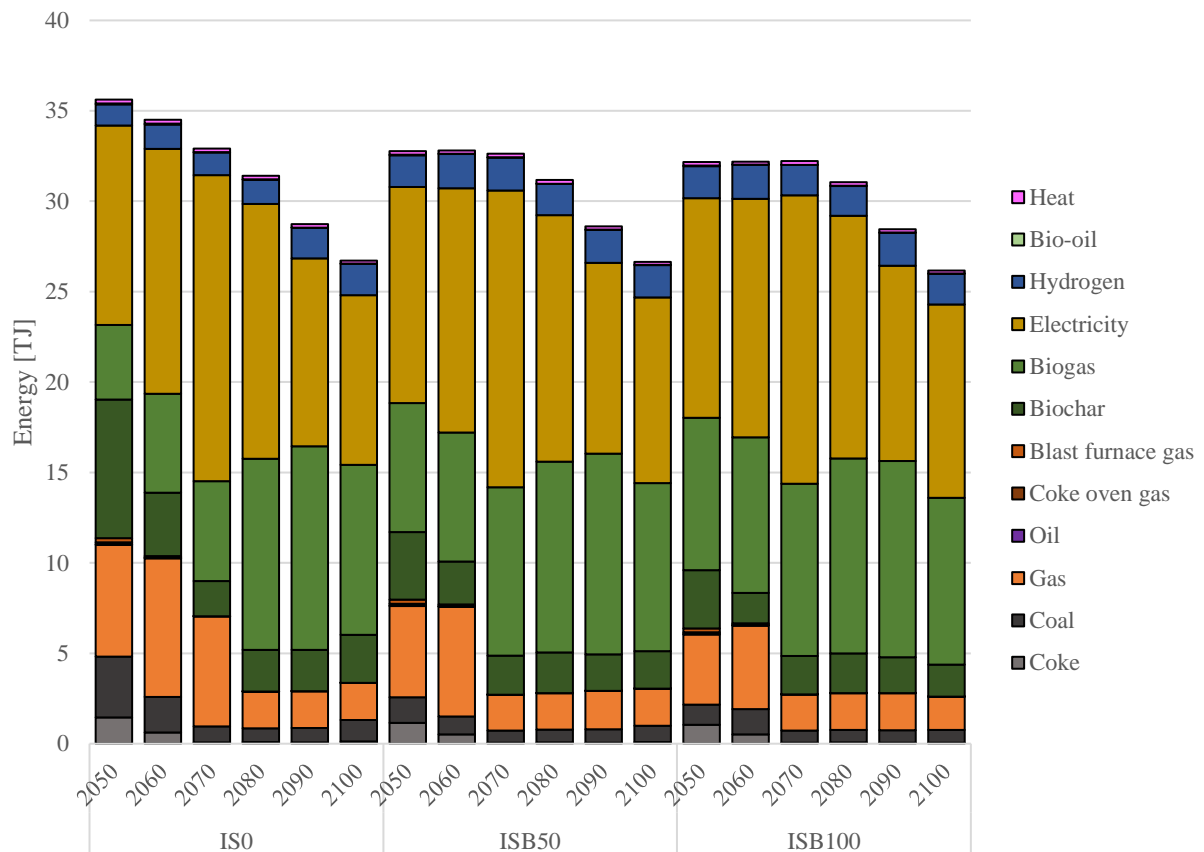

Figure 85: Comparison of the final energy mix of steel industries when assuming different biomass efficiencies

5. Key results from EPPA and TIAM-FR: energy, emissions, and CCUS contribution

This last section provides a complementary discussion of the results of TIAM-FR and EPPA. In light of our explorations above, it appears reasonable to assume conservative costs of CCU, a medium cost of hydrogen, a low cost of CO₂ transport and storage following the recommendations of (Smith et al., 2021a), a medium cost of DAC (\$400-600/tCO₂), and international emissions trading. Regarding policies, countries commit to achieve their long-term NDCs, and the world reaches net-zero GHG emissions by 2070.

In Figure 86, the emissions profile of the global economy illustrates how different the net-zero target is when achieved through EPPA or TIAM-FR. In the short-term (2020-2030), both models propose an optimal solution that reduces CO₂ emissions drastically from 40 GtCO₂ to 30 GtCO₂, essentially thanks to fuel-shifting measures. However, the levels of non-CO₂ GHGs drop by 2.1 GtCO_{2,eq} in the EPPA solution, while they rise by 0.8 GtCO_{2,eq} in TIAM-FR, albeit compensated by early deployment of negative emissions through BECCS investments in the power sector. In the medium term, EPPA cuts anthropogenic emissions more thoroughly than TIAM-FR with levels below 20 GtCO_{2,eq} in 2060, which matches the sharp decrease in global primary energy use observed in EPPA (Figure 87). As of 2060, global primary energy use rises again in EPPA due to the massive roll-out of bioenergy and negative emissions deployed by 2050 with 1.4 GtCO₂. TIAM-FR proposes a more gradual decrease in GHG emissions but negative emissions start operating substantially as of 2030 with 2.8 GtCO₂ such that global primary energy use keeps growing. On the one hand, such early deployment of BECCS in TIAM-FR is questionable and controversial (Braunger and Hauenstein, 2020; Ho, 2023; Nisbet, 2019; Zickfeld et al., 2021), although biomass potentials and CO₂ storage potentials have been reviewed and

acknowledged earlier (Selosse, 2019). On the other hand, it is currently hard to imagine that CO₂ emissions could almost halve in 2040, as EPPA proposes, but this result only follows the policy target.

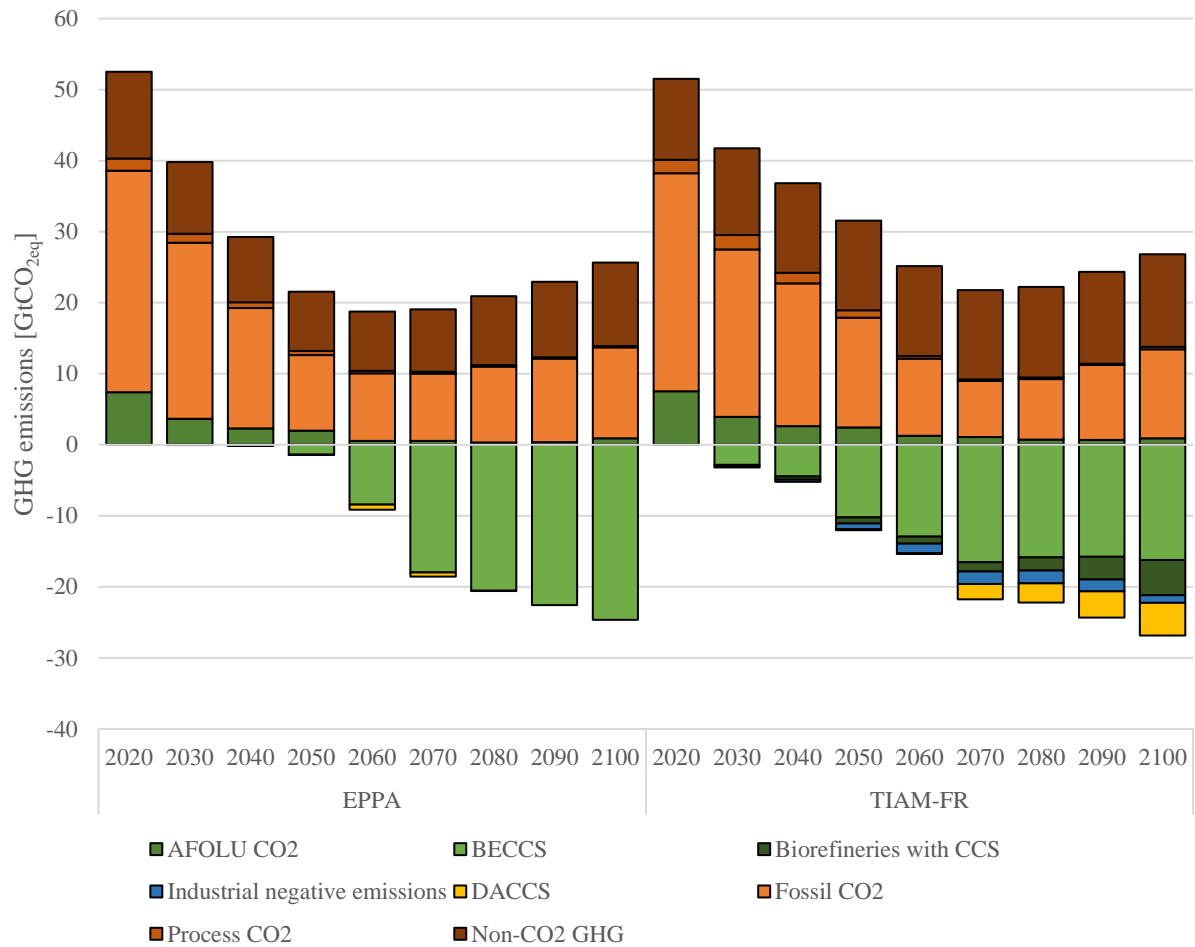

Figure 86: Emissions profile of TIAM-FR and EPPA in the NZ70 scenario

In the medium and long terms, the levels of positive and negative emissions in both models are similar, but the compositions of these emissions are different. Both models project a significant decrease in process CO₂ emissions achieved with CCS, but TIAM-FR evaluates approximately 15% more non-CO₂ GHG emissions compared to EPPA, which are correlated to the higher amount of fossil fuels burnt. As TIAM-FR is a technology-rich model, it proposes a mix of negative emissions involving the power sector (BECCS), industry, biorefineries, and DACCS. On the other hand, the negative emissions of EPPA rely 95% on BECCS, but there are only two NETs (DACCS and BECCS) considered in EPPA. Figure 87 shows that fossil fuels still represent a substantial share of the global primary energy system, even after 2070, which denotes the importance of CCUS in the solutions proposed by both models.

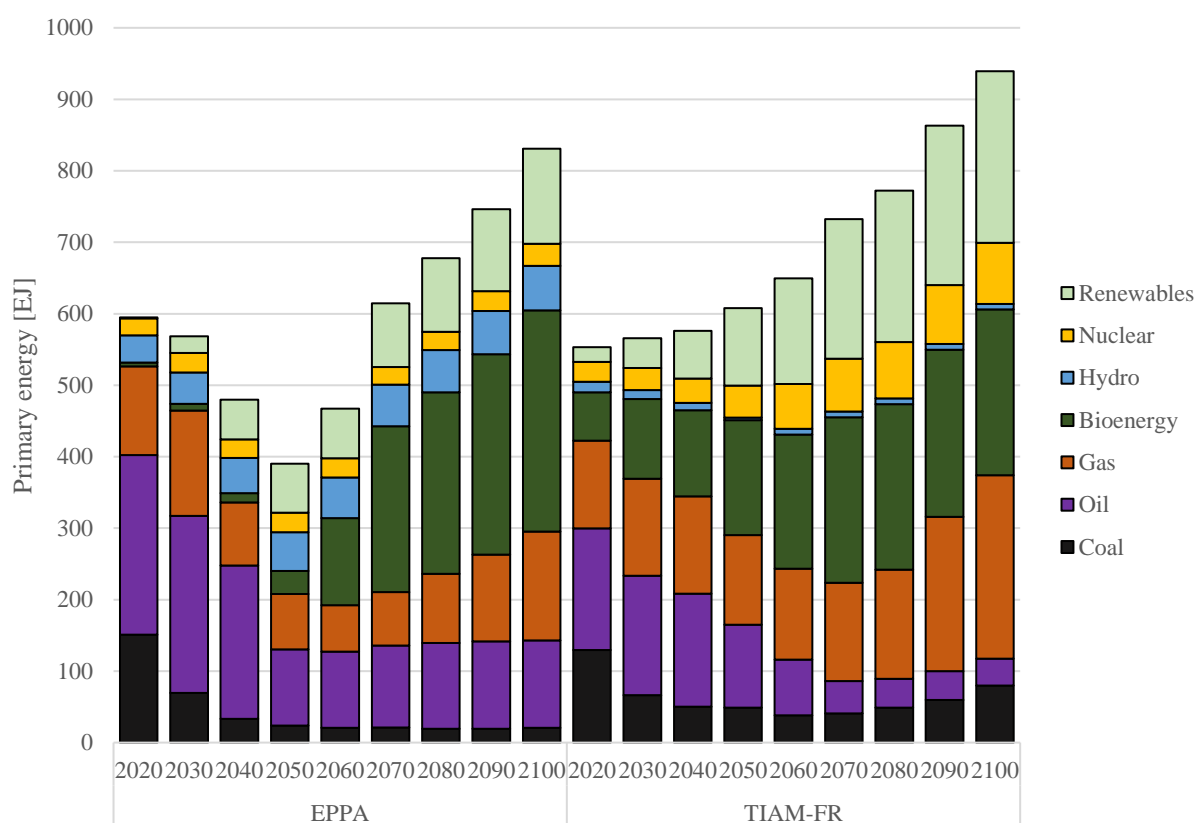

Figure 87: Global primary energy use in the NZ70 scenario

The difference in 2020 corresponds to incomplete updates of energy demands in both models, as EPPA starts in 2014 and TIAM-FR in 2018. Besides, traditional biomass does not account for in EPPA, and “oil” includes other energies.

Thus, both models find it optimal to develop BECCS massively and offset fossil emissions while electrifying the economy: Figure 88 shows that BECCS features more prominently in EPPA than in TIAM-FR, hence more electricity is generated.

Both models show that coal has no place in the power system of a net-zero world, nor does gas, unless used with carbon capture and storage, which represents 16% of global electricity generation in TIAM-FR in 2070. In total, the net levels of CO₂ captured from the power sector are similar. However, in EPPA, CCS-based electricity represents roughly a third of global electricity generation, of which 95% is BECCS. In TIAM-FR, approximately 50% of electricity generation is based on CCS. This difference lies in the fact that fewer renewables are deployed in TIAM-FR compared to EPPA. In addition, it could be the consequence of recently updated gas extraction costs and reserves in TIAM-FR from Pye et al. (2020). These authors gave more potent fossil reserves at a lower extraction cost than that initially represented in TIAM-FR. Overall, CO₂ capture in the power sector is essential in the transition proposed by TIAM-FR, but industry and the supply sector, i.e. hydrogen and refineries, also contribute significantly (Figure 89). In EPPA, all the CO₂ is captured from the power sector, even though CO₂ capture in industry is considered but cannot compete with BECCS.

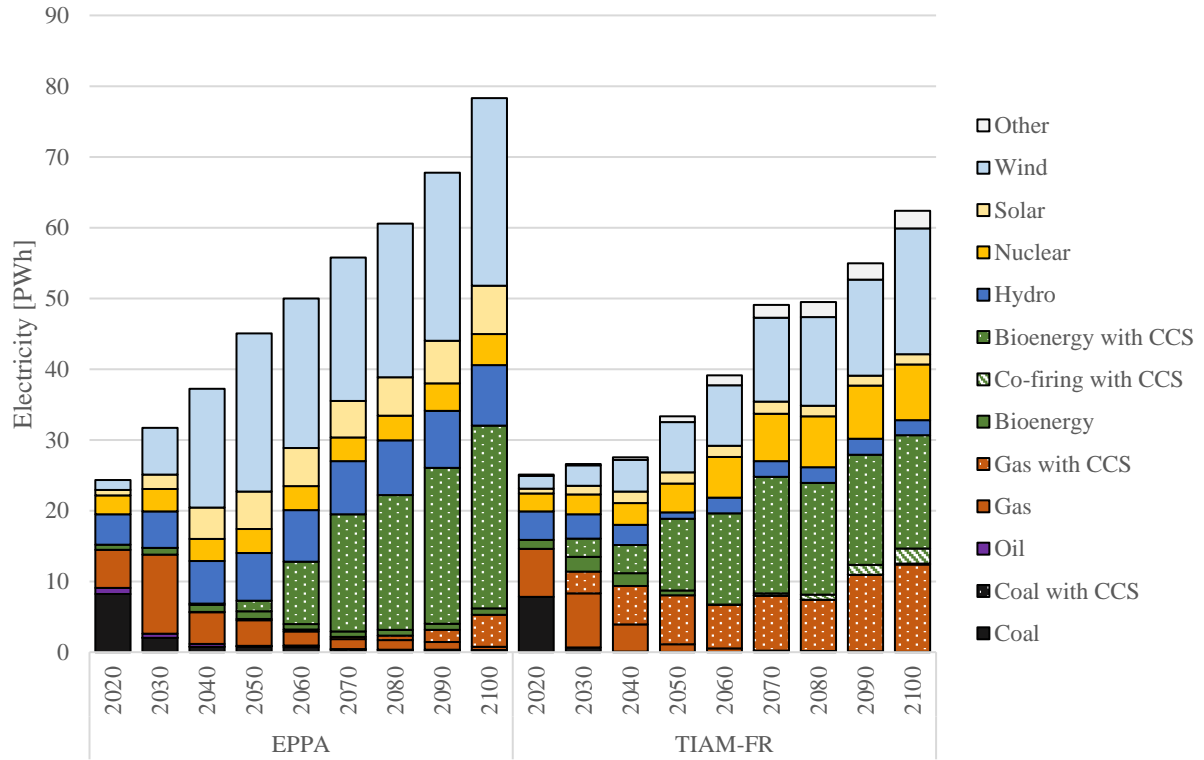

Figure 88: Global profile of electricity generation in the NZ70 scenario in EPPA and TIAM-FR

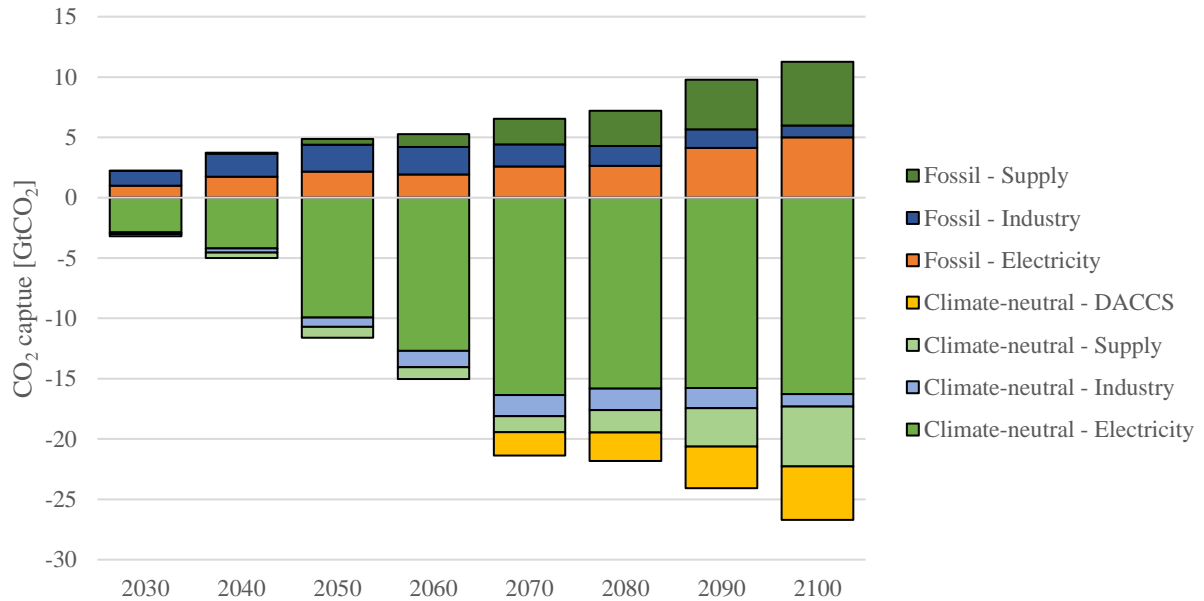

Figure 89: Global and sectorial CO₂ capture in TIAM-FR

The positive values represent the amount of CO₂ avoided through carbon capture and the negative values represent the amount of CO₂ removed. The supply sector denotes refineries, biofuels, and hydrogen production.

The hydrogen sector is bound to expand along with CO₂ utilization and the decarbonization of the transport sector (Figure 90). Our modeling of hydrogen did not consider the current production mix of hydrogen, which explains why our projection starts in 2030 (Figure 91). While the current production of hydrogen is close to 70 Mt, an additional 250 Mt could be necessary to reach carbon neutrality in 2070. In the near term, this involves the deployment of electrolysis assets, which are overtaken by grey and blue production routes as of 2050. In the long term, hydrogen production is dominated by SMR with carbon capture, but conventional SMR is still deployed, thus generating CO₂ that is eventually

compensated by negative emissions from other sectors. This underlines that low-carbon routes cannot fulfil hydrogen demand entirely while hydrogen is required for the transport sector, so the conventional route is preferred but offset. Note that hydrogen production exceeds hydrogen demand due to distribution and transport losses. Notably, around 1,200 MtH₂ cumulative are traded from Australia and New Zealand to Japan and South Korea ensuring 90% of their demand over the horizon, the rest being satisfied by electrolysis assets. Africa dominates the demand for hydrogen by more than 60% over the century. As hydrogen is not modeled in this version of EPPA, we are not able to compare these results.

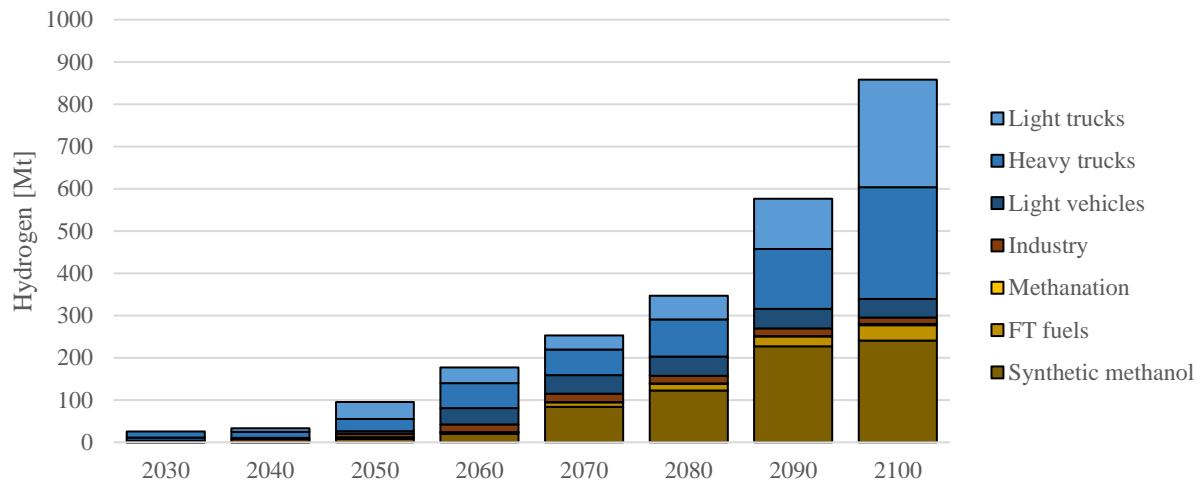

Figure 90: Global hydrogen demand in the NZ70 scenario (results from TIAM-FR)

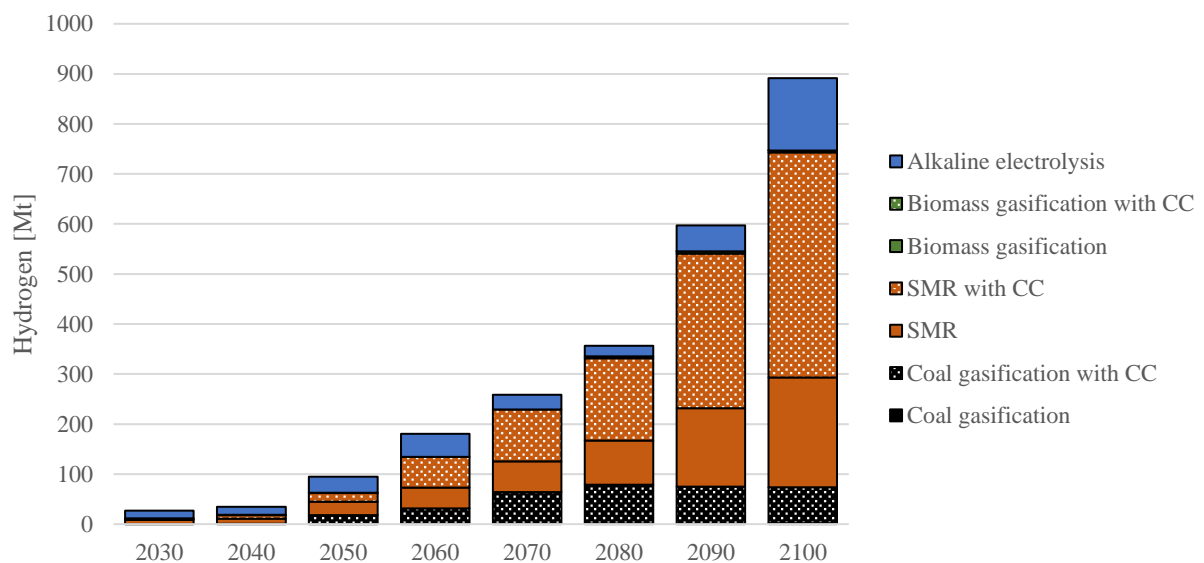

Figure 91: Global hydrogen production in the NZ70 scenario (results from TIAM-FR)

The resulting global levels of CO₂ captured for the NZ70 scenario prove to be very different from one model to the other, with roughly cumulated 1,680 GtCO₂ for TIAM-FR, and 940 GtCO₂ for EPPA. This difference can be explained by three elements. The first two are that TIAM-FR deploys CCS much earlier than EPPA with a capacity of 5.4 GtCO₂ already in 2030, and that CO₂ capture units can be deployed in several sectors of TIAM-FR, namely electricity, cement, steel, refineries, hydrogen, and DAC, while EPPA considers only the power sector and DAC. Thirdly, EPPA considers only the Fischer-Tropsch process to utilize CO₂, while TIAM-FR proposes various processes, such as methanation, hydrogenation and mineralization. Hence, 10 times more CO₂ is utilized in TIAM-FR than in EPPA. However, in TIAM-FR, 97% of the CO₂ captured is eventually stored (Figure 92) and only 0.5% is utilized in EPPA. Nevertheless, referring to Section 2, FT fuels generated in TIAM-FR only

contribute 2% of the fuel demand of global aviation, and we observe the same contribution in EPPA. Thus, the outputs of EPPA suggest a modest future for CCU in the NZ70 because only FT fuels are modeled and because FT fuels cannot compete with carbon dioxide removal.

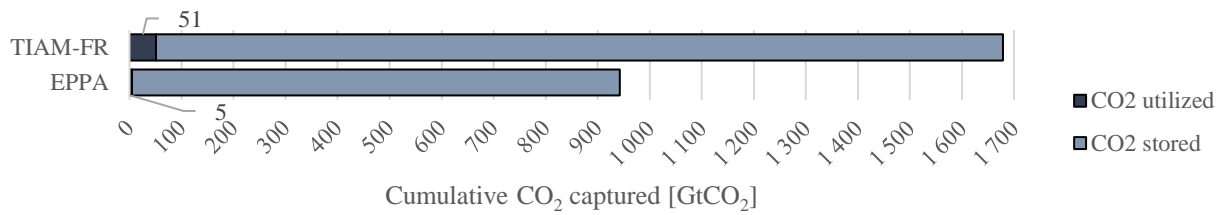

Figure 92: Fate of the CO₂ captured in TIAM-FR

Figure 93 illustrates the different contributions of the regions capturing CO₂ and reveals a major difference between EPPA and TIAM-FR concerning Chinese potential.

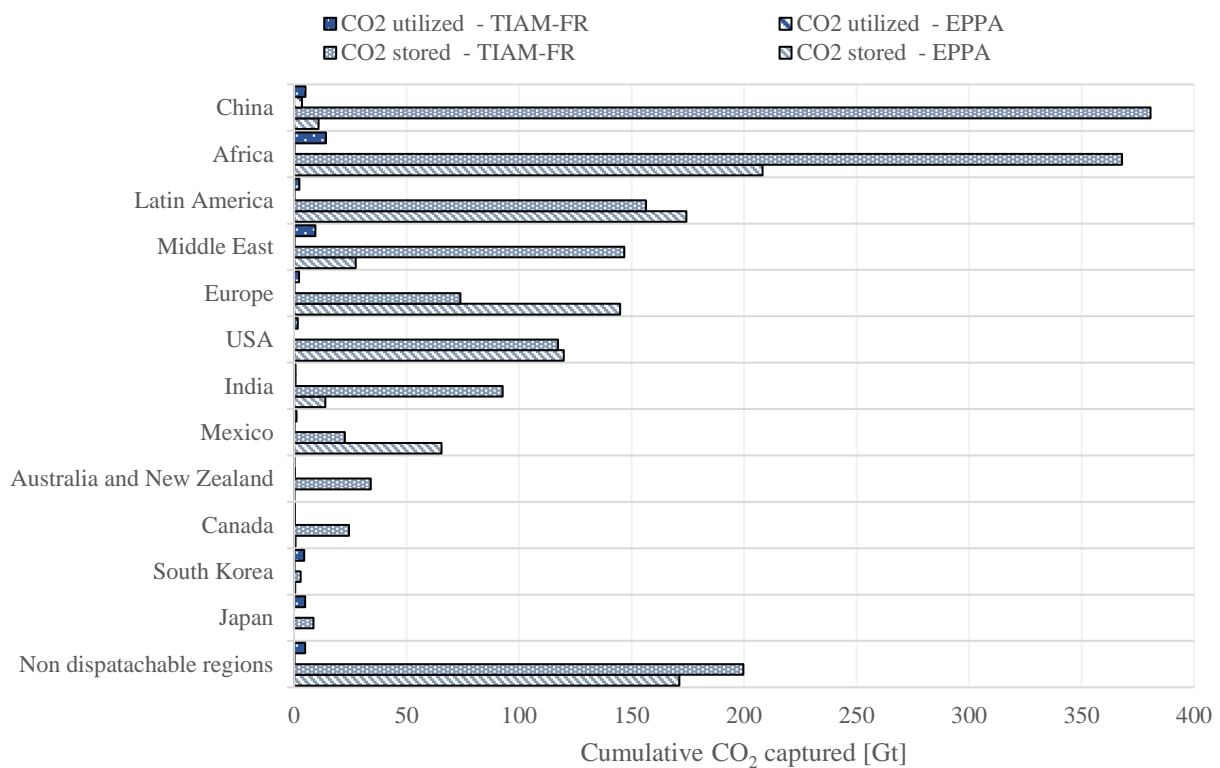

Figure 93: Regional deployment of CO₂ capture in EPPA and TIAM-FR
 Non-dispatchable regions include ASI, IDZ, REA and RUS for EPPA, and FSU and ODA for TIAM-FR

In EPPA, the contribution of China is almost zero, while Africa, USA, Brazil, and Indonesia (included in *Non dispatchable regions*) produce more than half of the negative emissions. However, China captures the most CO₂ of all regions in TIAM-FR, namely from biomass combustion. This big discrepancy is due to the modeling of land use in each model. In TIAM-FR, each region has its own yearly potential of land use across several scenarios, and we ran TIAM-FR with high biomass potentials calculated by Kang (2018). The scenario employed in each run of TIAM-FR allocates 2.3 Mm²/y to China. In EPPA, there are five land use categories: cropland, pastures, managed forests, natural forests and natural grasslands. Each land use category can be converted to another, taking into account the costs of conversion, which depend on the price of each land use category. The potential for expansion of cropland in a given area depends on these conversion costs. Because the price of land reflects the scarcity value (or opportunity cost) of land, countries like China, where the population is huge and the demand for food is very high, do not have much opportunity to convert land to uses other than food

production. Besides, natural forests and grasslands in China make up only a small portion of the total land area. According to the results, approximately 1.4 Mm²/y is used for crops and bioenergy in China as of 2050, which is much less than in TIAM-FR. Conversely, in TIAM-FR, we do not model food consumption explicitly, but the energy demand for agriculture is driven by GDP, and the biomass and land requirements for crop harvesting were elaborated exogenously by Kang (2018). Due to these differences in land-use modeling, the opportunities for China to capture biogenic CO₂ are very different comparing the results of TIAM-FR and EPPA. Nevertheless, the contributions of Africa, the US, the Middle-East, and Latin America are similar in both models, supporting the importance of CCUS investments in these regions and countries.

On the one hand, CCS is critical to reach net-zero emissions targets according to the results of both models, but TIAM-FR is more optimistic than EPPA: the cumulative amount of CO₂ stored over the century is 1,607 GtCO₂ in TIAM-FR, resp. 981 GtCO₂ in EPPA. This difference may be explained by the fact that TIAM-FR considers capture opportunities that EPPA does not consider in biorefineries, industry, and the hydrogen sector. On the other hand, CCU appears to be an uncertain niche solution for the aviation sector and industry, but cannot actually compete against CO₂ removal. Clearly, the net-zero target is not achievable for either model without CCS; however, it is achievable without CCU, underlining once more the limited interest in CO₂ utilization.

6. Conclusion and discussion

The results of this chapter have highlighted that CCUS has many roles, with more or less large potentials depending on what is denoted behind the CCUS acronym. When studying CCUS, what matters is the origin of the CO₂, the sector from which CO₂ is captured, and whether CO₂ is buried or recycled. Depending on these three pillars of CCUS, the roles and potential vary substantially.

First, there is much more interest to deal with climate-neutral CO₂ than with fossil CO₂, primarily because the fossil CO₂ can be avoided by using carbon-free energy carriers at a more affordable cost than CCS. Besides, although it could be more expensive to capture climate-neutral CO₂, the climate benefits are guaranteed whether you use it or store it. Regarding process CO₂, these emissions cannot be avoided by fuel switching or any other technological alternatives than CO₂ capture, but it must be considering that using process CO₂ would not tackle climate change as effectively as climate-neutral CO₂. Therefore, CO₂ capture should be hierarchized depending on the origin on CO₂.

Second, there is much more potential for CCS to be developed in sector that produce energy carriers such as the power sector, the hydrogen sector, or biorefineries, because electricity, hydrogen and biofuels can be used in many other sectors, so their potential is scalable. On the other hand, the potential of CCS for the industry is constrained by the demand for cement and steel. We make the same observations between CO₂ mineralization and CO₂-to-fuels processes: the potential for mineralization is constrained by the production of slags from the steel sector and by the demand for cement, while synthetic fuels can be used in many sectors.

Finally, the potential for CO₂ storage is much greater than that of CO₂ utilization, essentially because the climate benefits of CCS are more important, and in most cases, CCS is cheaper than CCU. Therefore, the cost of avoided CO₂ is often lower than with CO₂ storage, unless CO₂ is mineralized. More importantly, CO₂ storage ensures a safe and permanent sequestration of CO₂, which turns into negative emissions if this CO₂ is climate neutral. Our results demonstrate that effort should be put towards negative emission technologies in all sectors.

Consecutive to these conclusions, we join the ideas expressed in (Bruhn et al., 2016) claiming that CCU and CCS should be distinguished.

Conclusion

Carbon capture utilization and storage (CCUS) is a set of emerging technologies that either produce industrial goods from the CO₂ in the flue gas of industrial assets, or avoid the emission by burying the CO₂ in geological formations. These technologies could be deployed in the economy to tackle climate change, and prospective models can help explore this option. This thesis investigates the roles and potentials of CCU and CCS in the global energy transition and their contribution to decarbonizing industry. The work attempts to answer the following research questions:

1. Bridge the gap between the representation of CCU in energy models and the assessment of its future contribution to decarbonizing the global energy system.
2. Assess the technical and policy conditions required for direct air capture (DAC) to be deployed at scale.
3. Assess the opportunities for the industry sector to employ negative emission technologies.

This dissertation's main objective is to investigate through various scenarios the contribution of different low-carbon options to discuss the role that CCUS technologies can play to attain climate targets and the global decarbonization of the industry sector. In addition, it aims to assess the subsequent infrastructure needed and its associated costs to evaluate the realistic nature of the various scenarios. To do so, we enrich two different models with CCUS technologies and then employ them to answer the aforementioned questions and objectives, considering their specific designs and purposes.

On the one hand, the French version of the TIMES Integrated Assessment Model (TIAM-FR) is a bottom-up, technology-rich model representing the world energy system, which is coupled with a climate module to assess the impact of energy use on the climate. Therefore, TIAM-FR is useful for identifying key technologies for the future and the interactions between them, thus assessing the technical feasibility of the global energy transition. However, it does not consider the interaction between the energy system and the consumer side, thus energy demands are not endogenous. On the other hand, the Emissions Projection and Policy Analysis (EPPA) model is a top-down model computing a general equilibrium of the economy, so that demand reflects consumers' choices, detrimental to a much scarcer technology representation. Thus, TIAM-FR and EPPA, respectively handled by Mines Paris – PSL and the Massachusetts Institute of Technology (MIT), are complementary tools that we can employ to answer our research questions by taking advantage of the strengths of one to compensate for the other's weaknesses.

We enrich the two models with various CCUS technologies and other features that enable us to address the main research question. As TIAM-FR is more adapted to include numerous technologies, our modeling efforts focus on this model. Carbon capture is modeled on different sectors of the economy including the power sector (natural gas, coal, biomass, and co-firing processes), industry (cement and steel), biorefineries, direct air capture (DAC), and hydrogen production (steam methane reforming, coal gasification, and biomass gasification), considering different capture technologies and regional efficiencies due to climate differences and regional economic contexts. The geophysical capacities for CO₂ storage as well as the costs for transporting and storing the CO₂ are reviewed and modeled considering regional variation with more recent data than used before. We offer a detailed representation of CO₂ utilization including CO₂ conversion into methanol, methane, gasoline, diesel, and jet fuels, as well as mineralization of steel slags and pulverized fly ashes. Depending on the origin of the CO₂ utilized, the environmental benefit of CCU is different, and so we carefully redesign carbon loops inside TIAM-FR and EPPA to avoid double counting and omissions. As TIAM-FR does not represent the behavior of the consumer side, we define demand curves based on the Shared Socio-economic Pathways (SSP) from the International Institute for Applied Systems Analysis (IIASA). These works are conducted to align demands with climate policies, while EPPA calculates it endogenously. In the end,

we provide the same modeling in both models for DAC and Fischer-Tropsch fuels. In that sense, we already address part of the first two research questions, as CCU and DAC lack global energy models.

To explore the future of CCU and CCS we used a reference scenario including Nationally Determined Contributions (NDCs) and long-term pledges (e.g., zero CO₂ emissions in China in 2060). We compare it to a scenario forcing all countries to achieve carbon neutrality including all GHG by 2070, in addition to the NDCs and long-term pledges. For example, this involves India tackling all GHG by 2070, and not only CO₂, which is what they have pledged for now (cf. reference scenario).

We employ TIAM-FR for its technology-rich description, which enables us to discuss the parameters that drive the deployment of various CO₂-based products. We show that CCU is likely to be more important in the future as the costs of hydrogen decrease: a 20% reduction in the cost of hydrogen doubles the deployment of CCU. Besides, we show that defining a carbon budget instead of GHG targets steers the deployment of CCU. Interestingly, we find that there is no trade-off between CCU and CCS, i.e. if CCS is not available or affordable, CCU is affected and its deployment capacity is limited because CCS enables decarbonization of the power and hydrogen sectors, while electricity and hydrogen are essential in CCU value chains. Moreover, the necessity of CCU is limited as carbon dioxide removal becomes affordable: we show that driving down the cost of DAC reduces CCU deployment. We conclude by giving a broad estimate of the possible future of CCU in a net-zero world considering conservative and optimistic assumptions: the potential varies from 72 to 223 GtCO₂ utilized. In both cases, we note that CCU is not a technology for the short term, but rather for the second half of the century, especially for the last two decades, as fossil fuels will become scarcer and more expensive to extract. Nevertheless, we show that CCU could be deployed with significant capacities in the optimistic scenario, with 1 GtCO₂ of CO₂ utilized in 2050 to manufacture climate-neutral synthetic fuels, and that it contributes to achieve the net-zero target by 2070.

Regarding DAC, we employ the EPPA model to assess the technical and policy requirements of DAC deployment at a large scale, and its impact on the rest of the global economy. Given our results, we argue that the potential of DAC should be discussed relative to the assumed cost, as its deployment is very sensitive to this assumption. For instance, under the considered scenarios, we have observed that DAC contributes to 80% of global negative emissions when its cost is \$160/tCO₂, but the share drops to 5% when the cost is \$600/tCO₂. However, DAC employed as a supplier of CO₂ to produce Fischer-Tropsch fuels is not found effective in either case. The consideration of DAC units supplied with dedicated renewable assets has proved worth modeling as it impacts the deployment of DAC. In the midterm (2050), it can steer the deployment of DACCS in regions where the grid is not sufficiently decarbonized, and in the long run, it could bring additional negative emissions because the cost of renewables becomes extremely cheap. Thus, the regions and countries that are projected to invest the most in DACCS are those that have a cheap decarbonized grid, like Canada, Africa, Brazil, and Indonesia due to their large and cheap potentials for wind and solar. As we observe that these regions and countries were big exporters of emissions permits, we explore a scenario in which no ETS is set up. Because DACCS can theoretically be installed anywhere as long as sufficient CO₂ storage capacities exist, our results show that DACCS is an essential technology in regions and countries with low, expensive access to bioenergy or land, such as Australia, Japan, China, and India, even for a high-cost DAC. We observe the same results in a scenario with trading but limited BECCS; even for a medium cost of DACCS (~\$400/tCO₂), it could provide 1 Gtpa of negative emissions as of 2050. It could arguably be even greater if all bioenergy processes were concerned, and not only BECCS. Thus, the availability of biomass and international carbon trading are two big drivers of DACCS deployment. It takes the assumption of low-cost DACCS, a BECCS penalty, and scenarios with no GHG trade altogether to have DAC invested in the US and Europe; otherwise, it could not compete with BECCS. Incidentally, the regionalization of DAC capital costs can slightly impact the regional deployment of DAC but the main driver remains energy. Since DAC proves competitive in some techno-economic contexts and policy scenarios, it means that it can be economically viable under certain conditions. If

inexpensive DAC machines could be built, the global price of GHG would halve, and in scenarios without international emissions trading, it could avoid very expensive GHG in Asian countries, with substantial GDP savings. However, the technical feasibility is not guaranteed when looking at the implications on land use and the power system. Although the land use requirements of DACCS are lower than BECCS even with conservative assumptions, it could be problematic in some countries, especially if wind turbines supply energy to DAC units. In fact, the land footprint of DAC units is not the main concern, but the land used by electricity generators matters, due to the high energy intensiveness of DAC. Consequently, the impact on the power system is huge, with roughly a third of the total electricity supply dedicated to DAC in a scenario with limited BECCS. The more DACCS is deployed, the more power consumption increases, and the more power generation decreases as DACCS replaces BECCS.

While the deployment of DACCS is quite uncertain, the generation of negative emissions from industry appears to be of major interest. Biomass can be used in many processes in the cement and steel industries. In the cement industry, substantial amounts of energy are required to produce clinker, which is the core component of cement. This energy can be provided with biomass, thus generating large amounts of biogenic CO₂ that can be captured and stored to produce negative emissions and compensate the process emissions of limestone calcination. Our results show that the potential for negative emissions in the cement industry goes beyond that purpose. The transition engaged by the cement industry consists in massively deploying carbon capture units combined with bioenergy in different forms, namely solid biomass, pellets, and biogas. Consequently, the cement industry can produce around 2 GtCO₂ of negative emissions to decarbonize not only its activity but other ‘hard-to-abate’ industries. However, this involves deploying CCS early with capacities around 1 GtCO₂ in 2040 by retrofitting existing assets with post-combustion capture units. In the long run, oxyfuel technology is preferred as it is less energy intensive. Regarding the iron and steel industry, negative emissions can also be produced to compensate for its residual emissions and contribute to the decarbonization of the rest of the energy system. The preferred route to produce steel while mitigating CO₂ emissions is to run Corex processes; because this integrated process requires a lot of energy, large amounts of CO₂ are generated from fuels, and in the case of bioenergy, this CO₂ is climate-neutral, thus allowing for negative emissions. More efficient processes like BF-BOF with CCS or DRI with CCS have a less important role because they cannot generate as many negative emissions as Corex with CCS. When considering a 50-year rotation period for biomass, higher biomass use would be required to compensate for the reduction in the effectiveness of negative emissions, while a 100-year rotation period would involve lower biomass use in the steel industry. This implies that considering other sustainability factors when deploying biomass would heavily impact the use of biomass in the steel industry.

Limitations and perspectives

The limitations and perspectives of the thesis follow two lines.

The first line relates to the modeling paradigms employed in our exercises. TIAM-FR and the EPPA model solve the optimization problem by minimizing costs and maximizing welfare, respectively. Thus, they guide decision-makers based on economic performance *only*, considering technology and physical limitations (resources, potentials, etc.). In reality, decision-makers do not take necessarily rational and optimal decisions based on economic soundness to address energy issues. Other concerns are crucial, such as health, environment, jobs, and independence. Our models – like all models – fail to capture all of these, although it would not necessarily be relevant to include all facets due to interpretation difficulties. Furthermore, the pathways obtained through our work do not constitute unique paths toward the decarbonization of the global energy system. Instead they show, within the multiple possible pathways, the optimal choices to achieve decarbonization given a set of technical and economic assumptions. They confirm the acknowledged results of existing studies and provide developments at geographical scales that have sometimes been unexplored, as well as technological detail. To

encompass this limitation, a reasonable approach could consist in assessing all the impacts of CCUS deployment observed in our scenarios in terms of health, jobs, ecotoxicity, etc., and the literature focusing on Life Cycle Analysis (LCA) can support this purpose. Therefore, we believe that the models need to be cross-compared, as we attempted to do in the last analysis of Chapter 4, so that the results can be put in perspective. However, this requires a sound knowledge of each model's functioning and specificities – which is a skill hard to acquire – and similar base assumptions about potentials, costs, etc. Hence, we employed them according to their specificities in order to address research questions depending on those specificities.

The second line relates to shortcomings in the modeling of CCU and CCS. Although we strived to model as many CCUS opportunities as possible, some important ones are missing. To begin with, the chemical sector was excluded from our modeling, mainly due to its complexity. Indeed, chemicals encompass many products (fertilizers, plastics, pharmaceuticals, refined oil products, etc.) generated from different processes, which makes the representation of this sector difficult, unless each branch is disaggregated. Besides, the chemical sector is responsible for 2.2% of global GHG emissions (Ritchie and Roser, 2020), which is less than steel or cement, and this explains why we chose to focus on cement and steel. Other minor industries like aluminum and paper were not considered either for the same reasons. In addition, we did not model CO₂ curing, as doing so would have required modeling the construction sector including wood and brick pathways. Finally, we did not include EOR in either model due to a lack of data about eligible oil fields and their geophysical characteristics to determine the quantity of CO₂ to recover one barrel. Consequently, our estimation for CCU and CCS in the industry may be underestimated. Thereby, further works could address these gaps. In particular, more studies could be carried out regarding CCU in the EPPA model, as we only focused on Fischer-Tropsch fuels for this model. Regarding the modeling of DAC, it would be valuable to update the results with more granular regional availability factors for wind and solar as these play a role in the capital cost of the batteries and the cost of electricity to run DAC units. Indeed, in this study carried out with EPPA, we considered a uniform availability factor of solar and wind (resp. 20% and 35%), but some studies suggest different regional values across regions of the world (IRENA, 2020), which would also have a big impact on land use. Besides, it would be worth considering other capital regionalization regarding CCUS investments, as we observed that this significantly impacts the deployment of DAC when regional weighted average costs of capital are considered instead of capital scalars. Furthermore, our study does not include the meteorological performances of DAC, which have been found to be more effective in dry and cold climate conditions (Sendi et al., 2022). Finally, the aggregation of countries into big regions like Africa or Latin America implicitly suggests that emissions trading is in place internally in these areas. While our results show an important role for DACCS in Africa, information about the location of DAC investments is missing and may hide the fact that some African countries sell permits to others. Thereby, the potential of DACCS in scenarios with no international emissions trade may be even greater.

Finally, we explored the decarbonization of the cement and steel industries, tackling only CO₂ emissions but not considering other GHGs, which would steer the need for negative emissions in these industries. Moreover, other hard-to-abate industries (e.g. chemicals, paper, aluminum) were not sufficiently disaggregated from the industry sector of TIAM-FR nor EPPA. Studying their decarbonization could reveal additional needs for negative emissions and CCUS invested in these industries. Besides, the industry sector was only studied in TIAM-FR but not in EPPA.

We are aware that our results suggest massive investment in negative emissions technologies to compensate for anthropogenic GHG emissions – in both models. Such dependence on negative emissions has been criticized for being techno-centered, counter-productive, expensive, non-ethical, and risky (Braunger and Hauenstein, 2020; Ho, 2023; Nisbet, 2019; Selosse, 2019; Zickfeld et al., 2021). In addition, we raise two additional limits related to massive reliance on negative emissions. Firstly, our projections stop in 2100, while we see both positive and negative emissions increase during

the second half of the century, hence the question: what then? Will we have enough CO₂ storage capacities to keep increasing fossil emissions and compensate for them after 2100? Is it safe to rely on emissions compensation through CO₂ storage when we already know that acceptability is a hurdle to CCS investments? Is climate not likely to compromise growing biomass, thus affecting BECCS? Secondly, if the world achieves neutrality at some point through cooperation, we wonder if humankind would be interested in controlling the climate. Once the net-zero target is reached, it could be expected that countries would either agree on extending neutrality, or become net negative in order to foster colder climates. Some countries could pledge to keep removing more CO₂ from the air than the world emits because their populations would like to live in a milder climate. Thus, we wonder whether controlling negative emissions means controlling the climate, and whether we want to avoid that. Even though we are far from being able to decide what climate we want, we believe that these questions should be anticipated and explored in future research works. To tackle the first point, it might be relevant to impose a constraint that prevents increasing the generation of fossil emissions after neutrality is attained. Regarding the second point, *ad hoc* studies could be carried out to explore the social, environmental, and technical implications of having substantial amounts of negative emissions in the long term. Furthermore, extending IAMs' solvers would make it possible to address the sustainability of massive reliance on negative emissions.

Recommendations

Although renewable energies are effective alternatives already being deployed, we cannot rely on them as the only solution because there are many economic sectors that they are unable to decarbonize, and also because of other hurdles such as intermittency, acceptability, material criticality, etc. In particular, industry is penalized by unavoidable emissions from its processes that renewables cannot tackle. The only technological alternative to eliminate these emissions is CCUS, which can be combined with bioenergy. Moreover, although CCS cannot directly address the problem of emissions by transport engines because these are scattered emissions, it can prove interesting in decarbonizing energy carriers, especially for producing bioethanol, biodiesel, and biogasoline at an affordable cost (\$20-50/tCO₂). The CO₂ captured by biorefineries is thus cheap and climate-neutral, which is a good requisite for utilizing it afterwards. Notably, CO₂ utilization appears as a major solution for the aviation sector if the cost of low-carbon hydrogen drops below \$4/kgH₂. Mineralizing CO₂ with steel slags and pulverized fly ashes contributes to the decarbonization of the industry, but the quantities of CO₂ mitigated are limited.

After all, decision-makers have a powerful weapon in their possession: the capability to offset expensive hard-to-abate emissions through negative emissions. Whether these negative emissions are generated from machines (BECCS or DACCS) or through nature-based solutions, they eliminate the most threatening adverse effect of burning fossil fuels, namely the emission of CO₂, while preserving the economic benefits of fossil fuel consumption. Furthermore, negative emissions can compensate for hard-to-abate, non-CO₂ GHG, such as methane from the agricultural sector. In this context, DACCS could contribute significantly if its costs fall below \$400/tCO₂.

Therefore, Carbon Capture Utilization and Storage (CCUS) are essential technologies for meeting our climate commitments for at least three reasons:

- Negative emissions
- Industry decarbonization
- Aviation fuel decarbonization

However, the hurdles of the transition go beyond energy and economic concerns. Environmental impacts and health concerns should also be considered, and Life Cycle Analysis (LCA) is an essential tool for assessing the adverse effects of CCUS technologies on water, land use, health, and ecotoxicity. Therefore, recommending investments in negative emissions for economic reasons implies that fossil fuels will keep being extracted, thereby damaging ecosystems, and emitting pollutants that are harmful

to health. Integrating all these concerns into a single model may be too complicated to analyze, but assessing the impact of CCUS deployment on the environment must be done *ad hoc* based on the conclusion of LCAs. For instance, understanding the impact of the deployment of BECCS on biodiversity, ecotoxicity, and air pollution are research questions that should be addressed in the future.

Recommending which regions or countries should deploy CCUS is complex, as we have noted that it is strongly related to the capacity of Parties to cooperate – i.e., if international emissions trading is available – as well as to the regional cost and renewable potentials. We feel confident in advocating that DAC should be envisaged either in countries possessing cheap, large solar and wind potential, such as African and South American countries, or in countries with no access to land and bioenergy, such as Japan, South Korea, China and India. Nevertheless, DAC is not a technology that should be considered important in the short term; the main efforts should be concentrated on reducing emissions first and offsetting the remaining ones afterwards. For this reason, CCS for industries should be envisaged everywhere in the short term as a solution to reduce emissions.

Thus, we believe that the importance of CCS for a net-zero future is no longer in doubt. Integrated assessment models should now be employed to assess the various implications of CCS, using the results of LCAs. Besides, we argue that the acceptability of CCS projects should be taken into consideration. On the other hand, the future of CCU remains uncertain or limited; as we have observed, it is very dependent on many other assumptions and equally uncertain regarding its own cost, and the cost of hydrogen, direct air capture, and CO₂ transport and storage. Therefore, efforts to model CCU in integrated assessment models should be continued. If CCU is to grow, we recommend using only climate-neutral CO₂ to produce fuels for the aviation sector, and possibly using fossil CO₂ for mineralization, thus recycling CO₂ into valuable products and tackling climate change at the same time. While CCS must be developed at scale in the coming decades, we do not believe that CCU is a critical technology for the short term.

Appendices

Appendix 1: Techno-economic characteristics and emissions of fossil power plants equipped with CO₂ capture in TIAM-FR

Table 51: Techno-economic characteristics of power generation units with carbon capture

Technology	Description	Year	CAPEX	FIXOM	VAROM	Efficiency
Units			\$/kW	\$/kW	\$/GJ	
EZCCGT120	NGCC with post capture	2025	1366	40	0.332	55%
		2040	1148			56%
		2050	1094			57%
EZCCGT121	Advanced turbines with post capture	2025	763	24	0.659	36%
		2040	642			37%
		2050	612			38%
EZCCGT122	NGCC with post capture 90%	2025	1211	45	0.345	56%
		2040	1018			57%
		2050	970			58%
EZCCGT123	NGCC with post capture 98.5%	2025	1305	48	0.379	54%
		2040	1096			55%
		2050	1045			56%
EZCCGT124	NGCC with post capture 90% FGR	2025	1149	43	0.205	56%
		2040	965			57%
		2050	920			58%
EZCCGT125	NGCC with post capture 98.5% FGR	2025	1210	45	0.234	55%
		2040	1017			56%
		2050	969			57%
EZOCA120	Supercritical pulverized coal with oxycombustion	2025	3479	64	1.574	29%
		2040	3221			30%
		2050	2746			31%
EZOCA121	Supercritical pulverized coal with oxycombustion ITM	2025	3204	58	1.487	29%
		2040	2968			30%
		2050	2529			31%
EZOCA122	Ultrasupercritical pulverized coal with oxycombustion	2025	3343	61	1.370	37%
		2040	3096			38%
		2050	2639			39%
EZPCOA120	Supercritical pulverized coal with post capture 1	2025	3454	55	4.559	33%
		2040	3198			34%
		2050	2726			35%
EZPCOA121	Supercritical pulverized coal with post capture 2	2025	3479	66	2.287	29%
		2040	3221			30%
		2050	2746			31%
EZPCOA122		2025	3420	64	2.004	33%
		2040	3167			34%

	Ultrasupercritical pulverized coal with post capture	2050	2699			35%
EZPCOA128	Ultrasupercritical pulverized coal with post capture 90%	2025	3585	80	3.282	37%
		2040	3320			38%
		2050	2829			39%
EZPCOA129	Ultrasupercritical pulverized coal with post capture 98.5%	2025	3797	85	3.675	35%
		2040	3516			36%
		2050	2997			37%

Table 52: Emissions characteristics of power generation units with carbon capture

Technology	Description	Year	Capture/Emissions		
			CPTELCCO ₂ N	ELCCO ₂ N	
		Fossil CO ₂ captured		Fossil CO ₂ emissions	
Units		kg/GJ		kg/GJ	
EZCCGT120	NGCC with post capture	2025		82	9.1
		2040		81	9.0
		2050		79	8.8
EZCCGT121	Advanced turbines with post capture	2025		125	13.9
		2040		122	13.5
		2050		118	13.2
EZCCGT122	NGCC with post capture 90%	2025		82	9.1
		2040		80	8.9
		2050		79	8.8
EZCCGT123	NGCC with post capture 98.5%	2025		91	1.4
		2040		90	1.4
		2050		88	1.3
EZCCGT124	NGCC with post capture 90% FGR	2025		81	9.0
		2040		80	8.8
		2050		78	8.7
EZCCGT125	NGCC with post capture 98.5% FGR	2025		90	1.4
		2040		88	1.3
		2050		87	1.3
EZOAOA120	Supercritical pulverized coal with oxycombustion	2025		302	33.5
		2040		292	32.4
		2050		283	31.4
EZOAOA121	Supercritical pulverized coal with oxycombustion ITM	2025		302	33.5
		2040		292	32.4
		2050		283	31.4
EZOAOA122	Ultrasupercritical pulverized coal with oxycombustion	2025		237	26.3
		2040		231	25.6
		2050		225	25.0
EZPCOA120	Supercritical pulverized coal with post capture 1	2025		272	30.2
		2040		264	29.3

		2050	256	28.5
EZPCOA121	Supercritical pulverized coal with post capture 2	2025	303	33.6
		2040	293	32.5
		2050	283	31.5
EZPCOA122	Ultrasupercritical pulverized coal with post capture	2025	266	29.6
		2040	259	28.7
		2050	251	27.9
EZPCOA128	Ultrasupercritical pulverized coal with post capture 90%	2025	236	26.3
		2040	230	25.6
		2050	224	24.9
EZPCOA129	Ultrasupercritical pulverized coal with post capture 98.5%	2025	273	4.2
		2040	266	4.0
		2050	259	3.9

Appendix 2: Techno-economic characteristics of steel manufacturing processes in TIAM-FR

	Units	Existing BF-BOF	Retrofitted BF-BOF w/CC	New BF-BOF	BF-BOF w/CC	BF-BOF w/TGR	BF-BOF w/CC & TGR	Existing coke oven	New coke oven	Corex	Corex w/CC	CUPOLA	Existing DRI	Retrofitted DRI-H2	New DRI-H2	DRI-H2 w/Electrolyzer	Existing EAF	NewEAF	Finishing process	New finishing process	Hisarna	Hisarna w/CC	Midrex	Midrex w/CC	Retrofitted Midrex w/CC	Existing oxygen production	New oxygen production	Existing pellet production	New pellet production	Existing sinter production	New sinter production	Ulcolysis	Ulcored	Ulcored w/CC	Ulcorewin			
Availability		85%	85%	85%	85%	85%	85%	95%	95%	85%	85%	90%	85%	85%	85%	85%	85%	90%	90%	90%	85%	85%	85%	85%	85%	85%	85%	95%	95%	95%	95%	85%	85%	85%	85%			
Lifetime	y	25	25	25	20	25	20		25	30	25	30	25	25	40	40	25	25	20	20	25	20	25	20	25	20	30		25		25	25	25	20	25			
Investment cost	[\$2018/Mtpa]		426	335	412	632	692		9	414	507	1126		437	587	989		240		195	918	961	510	531	462		353		126		71	775	593	658	731			
Fixed costs	[\$2018/Mtpa]	19	80	58	64	70	77			54	51	113	16	59	59	69	13	25	56	56	103	151	32	37	34	18	18	3	6	3	3	3	51	58	62	76		
Variable costs	[\$2018/Mt]	59	64	19	23	19	23	2	2	18	23	225	51	41	40	42	59	36	11	11	56	67	40	44	56			5	5	6	6		38	42	36			
Start year			2030	2020	2020	2030	2030		2020	2025	2025	2020		2030	2030	2030		2020		2020	2030	2030	2020	2030	2030		2020	2020	2020	2050	2030	2030	2030	2050				
Inputs			13.43	15.9	15.17	10.44	7.7	7.7	0.07	0.02	24.3	24.3									13.41	13.41					3.92	2.15	2.67	0.89								
Coke or biochar	[PJ]																																					
Coal or biochar	[PJ]					3.37	6.53	6.53	1.35	1.46	3.02	3.02																										
Gas or biogas	[PJ]				0.51	0.25		0.16	0.14			11.4	13.85	0.77	0.77	1.41							16.17	12.79	12.79								10.91	11.41				
Hydrogen	[PJ]												6.41	6.41																								
Electricity	[PJ]				0.97	0.15	0.88			0.39	1.02	4.6		2.32	1.66	12.35	2.29	3.17	2.36						1.03	0.72						14.2	3.16	3.57	11.24			
Heavy fuel oil	[PJ]				0.64	0																																
Limestone	[Mt]	0.02	0.02	0.02	0.02	0.02	0.02			0.28	0.28			0.07	0.07	0.07	0.07	0.07					0.14	0.14	0.14							0.05	0.17	0.17	0.18			
Lump ore	[Mt]	0.37	0.37	0.37	0.37					0.54	0.54											1.42	1.42	1.27	1.27	1.27						1.51	1.27	1.27	1.51			
Fine ore	[Mt]	0	0	0	0	0	0	0	0	0.14	0.15	0	0	0	0	1.51												1	1	1.16	1.15							
Oxygen	[Mt]	0.07	0.07	0.05	0.05	0.17	0.17			0.41	0.41				0.03	0	0.05	0.05				1.09	1.09											0.11	0.11			
Pellets	[Mt]	0.09	0.09	0.09	0.09	0.72	0.72			0.68	0.68																											
Quick lime	[Mt]	0.05	0.05	0.05	0.05					0.05	0.05											0.03	0.03															
Scrap	[Mt]	0.18	0.18	0.18	0.18	0.17	0.17			0.18	0.18	1.3	0.16	0.12	0.12	0.12	1.23	1.23				0.17	0.17	0.16	0.16	0.16							0.16	0.16				
Sinter	[Mt]	1.09	1.09	1.09	1.09	0.7	0.7																															
Crude steel	[Mt]																																				1	1

Outputs	Crude steel	[Mt]	1	1	1	1	1	1	1	1	1	1	1	1	1	1	1	1	1	1	1	1	1	1	1	1	1	1	1	
	Gases	[PJ]	5.09	4.11	4.11	4.11	0.25	0.25	0.16	0.14	11.55	0.65																		
	Slags	[Mt]	0.35	0.35	0.35	0.35	0.34	0.34	0.44	0.44	0.17	0.21	0.21	0.21	0.26	0.17	0.26	0.17	0.17	0.17										
	Process CO ₂	[kt]	44	44	32	3	11	1	144	14	31	31	31	44	44	14	1	62	6	6.16										
	Finished steel	[Mt]																			1	1								
	Oxygen	[Mt]																												
	Pellets	[Mt]																												
	Coke	[PJ]																												
	Sinter	[Mt]																												

Appendix 3: Deployment of DAC at 380\$/tCO₂

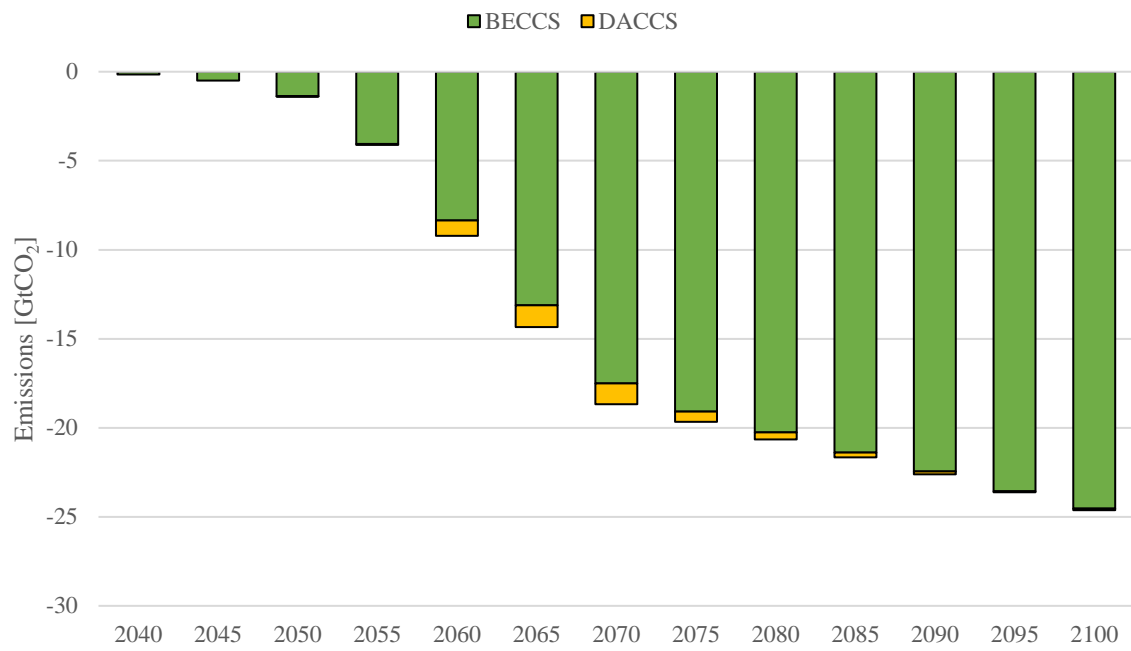

References

- Abanades, J.C., Rubin, E.S., Mazzotti, M., Herzog, H.J., 2017. On the climate change mitigation potential of CO₂ conversion to fuels. *Energy Environ. Sci.* 10, 2491–2499. <https://doi.org/10.1039/C7EE02819A>
- About Cement & Concrete [WWW Document], 2022. . GCCA. URL <https://gccassociation.org/our-story-cement-and-concrete/> (accessed 11.28.22).
- Akimoto, K., Sano, F., Oda, J., Kanaboshi, H., Nakano, Y., 2021. Climate change mitigation measures for global net-zero emissions and the roles of CO₂ capture and utilization and direct air capture. *Energy Clim. Change* 2, 100057. <https://doi.org/10.1016/j.egycc.2021.100057>
- Albrecht, F.G., König, D.H., Baucks, N., Dietrich, R.-U., 2017. A standardized methodology for the techno-economic evaluation of alternative fuels – A case study. *Fuel* 194, 511–526. <https://doi.org/10.1016/j.fuel.2016.12.003>
- Alghed, J., Wirsenius, S., Jönsson, J., 2009. Modelling energy efficiency and carbon dioxide emissions in energy-intensive industry under stringent CO₂ policies: comparison of top-down and bottom-up approaches and evaluation of usefulness to policy makers 11.
- Ali, H., 2019. Techno-economic analysis of CO₂ capture concepts (Doctoral thesis). University of South-Eastern Norway.
- Alkhaledi, A.NFNR., Sampath, S., Pilidis, P., 2022. Economic analysis of a zero-carbon liquefied hydrogen tanker ship. *Int. J. Hydrog. Energy* 47, 28213–28223. <https://doi.org/10.1016/j.ijhydene.2022.06.168>
- Ameli, N., Dessens, O., Winning, M., Cronin, J., Chenet, H., Drummond, P., Calzadilla, A., Anandarajah, G., Grubb, M., 2021. Higher cost of finance exacerbates a climate investment trap in developing economies. *Nat. Commun.* 12, 4046. <https://doi.org/10.1038/s41467-021-24305-3>
- Ampelli, C., Perathoner, S., Centi, G., 2015. CO₂ utilization: An enabling element to move to a resource-and energy-efficient chemical and fuel production. *Philos. Trans. R. Soc. Math. Phys. Eng. Sci.* 373. <https://doi.org/10.1098/rsta.2014.0177>
- Anandarajah, G., Pye, S., Usher, W., Kesicki, F., McGlade, C., 2011. TIAM-UCL Global Model Documentation (Working Paper No. UKERC/WP/ESY/2011/001). University College London.
- Andrade, C., 2022. PROSPECTIVE ÉNERGÉTIQUE PACA : Quelles transformations futures du territoire pour assurer une transition énergétique et d'économie circulaire?
- Anwar, M.N., Fayyaz, A., Sohail, N.F., Khokhar, M.F., Baqar, M., Yasar, A., Rasool, K., Nazir, A., Raja, M.U.F., Rehan, M., Aghbashlo, M., Tabatabaei, M., Nizami, A.S., 2020. CO₂ utilization: Turning greenhouse gas into fuels and valuable products. *J. Environ. Manage.* 260, 110059. <https://doi.org/10.1016/j.jenvman.2019.110059>
- APS, 2011. Direct Air Capture of CO₂ with Chemicals - A Technology Assessment for the APS Panel on Public Affairs.
- Armington, P.S., 1969. A Theory of Demand for Products Distinguished by Place of Production. *Int. Monet. Fund Staff Pap.* 159–176. <https://doi.org/10.2307/3866403>
- Armstrong, K., 2015. Emerging Industrial Applications, in: *Carbon Dioxide Utilisation*. Elsevier, pp. 237–251. <https://doi.org/10.1016/B978-0-444-62746-9.00013-X>
- Arning, K., van Heek, J., Ziefle, M., 2017. Risk Perception and Acceptance of CDU Consumer Products in Germany. *Energy Procedia*, 13th International Conference on Greenhouse Gas Control Technologies, GHGT-13, 14-18 November 2016, Lausanne, Switzerland 114, 7186–7196. <https://doi.org/10.1016/j.egypro.2017.03.1823>
- Assoumou, E., 2006. Modélisation MARKAL pour la planification énergétique long terme dans le contexte français (phdthesis). École Nationale Supérieure des Mines de Paris.
- Assoumou, E., Ghersi, F., Hourcade, J.C., Jun, L., Maïzi, N., Selosse, S., 2018. Reconciling top-down and bottom-up energy/economy models: a case of TIAM-FR and IMACLIM-R 39.

- Azar, C., Lindgren, K., Larson, E., Möllersten, K., 2006. Carbon Capture and Storage From Fossil Fuels and Biomass – Costs and Potential Role in Stabilizing the Atmosphere. *Clim. Change* 74, 47–79. <https://doi.org/10.1007/s10584-005-3484-7>
- Baklid, A., Owren, G., Korbol, R., 1998. SLEIPNER VEST CO₂ DISPOSAL, CO₂ INJECTION INTO A SHALLOW AQUIFER 9.
- Balistreri, E.J., McDaniel, C.A., Wong, E.V., 2003. An estimation of US industry-level capital–labor substitution elasticities: support for Cobb–Douglas. *North Am. J. Econ. Finance* 14, 343–356. [https://doi.org/10.1016/S1062-9408\(03\)00024-X](https://doi.org/10.1016/S1062-9408(03)00024-X)
- Bataille, C., Åhman, M., Neuhoﬀ, K., Nilsson, L.J., Fischedick, M., Lechtenböhrer, S., Solano-Rodriguez, B., Denis-Ryan, A., Stiebert, S., Waisman, H., Sartor, O., Rahbar, S., 2018. A review of technology and policy deep decarbonization pathway options for making energy-intensive industry production consistent with the Paris Agreement. *J. Clean. Prod.* 187, 960–973. <https://doi.org/10.1016/j.jclepro.2018.03.107>
- Bauer, N., Rose, S.K., Fujimori, S., van Vuuren, D.P., Weyant, J., Wise, M., Cui, Y., Daioglou, V., Gidden, M.J., Kato, E., Kitous, A., Leblanc, F., Sands, R., Sano, F., Streﬂer, J., Tsutsui, J., Bibas, R., Fricko, O., Hasegawa, T., Klein, D., Kurosawa, A., Mima, S., Muratori, M., 2020. Global energy sector emission reductions and bioenergy use: overview of the bioenergy demand phase of the EMF-33 model comparison. *Clim. Change* 163, 1553–1568. <https://doi.org/10.1007/s10584-018-2226-y>
- Bazzanella, A.M., Ausfelder, F., 2017. Low Carbon Energy and Feedstock for the European Chemical Industry DECHEMA Gesellschaft für Chemische Technik, 168.
- Bentham, M., Pearce, J., Kirk, K., Hovorka, S., van Gessel, S., Pegler, B., Neades, S., Dixon, T., 2014. Managing CO₂ Storage Resources in a Mature CCS Future. *Energy Procedia* 63, 5310–5324. <https://doi.org/10.1016/j.egypro.2014.11.563>
- Beuttler, C., Charles, L., Wurzbacher, J., 2019. The Role of Direct Air Capture in Mitigation of Anthropogenic Greenhouse Gas Emissions. *Front. Clim.* 1. <https://doi.org/10.3389/fclim.2019.00010>
- Blanco, H., Nijs, W., Ruf, J., Faaij, A., 2018a. Potential for hydrogen and Power-to-Liquid in a low-carbon EU energy system using cost optimization. *Appl. Energy* 232, 617–639. <https://doi.org/10.1016/j.apenergy.2018.09.216>
- Blanco, H., Nijs, W., Ruf, J., Faaij, A., 2018b. Potential of Power-to-Methane in the EU energy transition to a low carbon system using cost optimization. *Appl. Energy* 232, 323–340. <https://doi.org/10.1016/j.apenergy.2018.08.027>
- Bogdanov, D., Farfan, J., Sadovskaia, K., Aghahosseini, A., Child, M., Gulagi, A., Oyewo, A.S., de Souza Noel Simas Barbosa, L., Breyer, C., 2019. Radical transformation pathway towards sustainable electricity via evolutionary steps. *Nat. Commun.* 10, 1077. <https://doi.org/10.1038/s41467-019-08855-1>
- Boubault, A., Maïzi, N., 2019. Devising Mineral Resource Supply Pathways to a Low-Carbon Electricity Generation by 2100. *Resources* 8, 33. <https://doi.org/10.3390/resources8010033>
- Braunger, I., Hauenstein, C., 2020. How Incumbent Cultural and Cognitive Path Dependencies Constrain the ‘Scenario Cone’: Reliance on Carbon Dioxide Removal due to Techno-bias. *Econ. Energy Environ. Policy* 9. <https://doi.org/10.5547/2160-5890.9.1.ibra>
- Bruhn, T., Naims, H., Olfe-Kräutlein, B., 2016. Separating the debate on CO₂ utilisation from carbon capture and storage. *Environ. Sci. Policy* 60, 38–43. <https://doi.org/10.1016/j.envsci.2016.03.001>
- Budinis, S., Krevor, S., Dowell, N.M., Brandon, N., Hawkes, A., 2018. An assessment of CCS costs, barriers and potential. *Energy Strategy Rev.* 22, 61–81. <https://doi.org/10.1016/j.esr.2018.08.003>
- Bui, M., Adjiman, C.S., Bardow, A., Anthony, E.J., Boston, A., Brown, S., Fennell, P.S., Fuss, S., Galindo, A., Hackett, L.A., Hallett, J.P., Herzog, H.J., Jackson, G., Kemper, J., Krevor, S., Maitland, G.C., Matuszewski, M., Metcalfe, I.S., Petit, C., Puxty, G., Reimer, J., Reiner, D.M., Rubin, E.S., Scott, S.A., Shah, N., Smit, B., Trusler, J.P.M., Webley, P., Wilcox, J., Mac Dowell, N., 2018. Carbon capture and storage (CCS): the way forward. *Energy Environ. Sci.* 11, 1062–1176. <https://doi.org/10.1039/C7EE02342A>

- Byrd, J.W., Cooperman, E.S., 2016. Investors and Stranded Asset Risk: Evidence from Shareholder Responses to Carbon Capture and Sequestration (CCS) Events. <https://doi.org/10.2139/ssrn.2883624>
- Capros, P., Zazias, G., Evangelopoulou, S., Kannavou, M., Fotiou, T., Siskos, P., De Vita, A., Sakellaris, K., 2019. Energy-system modelling of the EU strategy towards climate-neutrality. *Energy Policy* 134, 110960. <https://doi.org/10.1016/j.enpol.2019.110960>
- Carbon Capture Journal, 2022. Global Status of CCS 2022 - sector well placed for deployment 36.
- CarbonBrief, 2019. CMIP6: the next generation of climate models explained [WWW Document]. Carbon Brief. URL <https://www.carbonbrief.org/cmip6-the-next-generation-of-climate-models-explained/> (accessed 2.2.23).
- CEMCAP, 2016. Design and performance of CEMCAP cement plant with MEA post combustion capture.
- Chauvy, R., Dubois, L., Lybaert, P., Thomas, D., De Weireld, G., 2020. Production of synthetic natural gas from industrial carbon dioxide. *Appl. Energy* 260, 114249. <https://doi.org/10.1016/j.apenergy.2019.114249>
- Chauvy, R., Meunier, N., Thomas, D., De Weireld, G., 2019. Selecting emerging CO₂ utilization products for short- to mid-term deployment. *Appl. Energy* 236, 662–680. <https://doi.org/10.1016/j.apenergy.2018.11.096>
- Chauvy, R., Verdonck, D., Dubois, L., Thomas, D., De Weireld, G., 2021a. Techno-economic feasibility and sustainability of an integrated carbon capture and conversion process to synthetic natural gas. *J. CO₂ Util.* 47, 101488. <https://doi.org/10.1016/j.jcou.2021.101488>
- Chauvy, R., Verdonck, D., Dubois, L., Thomas, D., De Weireld, G., 2021b. Techno-economic feasibility and sustainability of an integrated carbon capture and conversion process to synthetic natural gas. *J. CO₂ Util.* 47, 101488. <https://doi.org/10.1016/j.jcou.2021.101488>
- Chen, C., Tavoni, M., 2013. Direct air capture of CO₂ and climate stabilization: A model based assessment. *Clim. Change* 118, 59–72. <https://doi.org/10.1007/s10584-013-0714-7>
- Chen, H., Paltsev, S., Reilly, J.M., Karplus, V., Gurgel, A., Winchester, N., Kishimoto, P., Blanc, E., Babiker, M., 2017. The MIT Economic Projection and Policy Analysis (EPPA) Model: Version 5.
- Chen, Y.-H.H., Paltsev, S., Gurgel, A., Reilly, J.M., Morris, J., 2022. A Multisectoral Dynamic Model for Energy, Economic, and Climate Scenario Analysis. *Low Carbon Econ.* 13, 70–111. <https://doi.org/10.4236/lce.2022.132005>
- Chepeliev, M., 2020. GTAP-Power 10 Data Base: A Technical Note [WWW Document]. GTAP Res. Memo. No 31, GTAP Research Memorandum No. 31. URL http://www.gtap.agecon.purdue.edu/resources/res_display.asp?RecordID=5938
- Chiquier, S., Patrizio, P., Bui, M., Sunny, N., Mac Dowell, N., 2022. A comparative analysis of the efficiency, timing, and permanence of CO₂ removal pathways. *Energy Environ. Sci.* <https://doi.org/10.1039/D2EE01021F>
- Clean Air Task Force, 2023. Mapping the cost of carbon capture and storage in Europe [WWW Document]. Clean Air Task Force. URL <https://www.catf.us/2023/02/mapping-cost-carbon-capture-storage-europe/> (accessed 3.15.23).
- Clean Air Task Force, 2022. Direct air capture is growing around the world, but more policy support is needed [WWW Document]. Clean Air Task Force. URL <https://www.catf.us/2022/07/direct-air-capture-growing-around-world-more-policy-support-needed/> (accessed 2.27.23).
- CO2Europe, 2011. Towards a Transport Infrastructure for Large-Scale CCS in Europe: WP3.3 Report – Legal, Financial, and Organizational Aspects of CO₂ Pipeline Infrastructure.
- Consoli, C.P., Wildgust, N., 2017. Current Status of Global Storage Resources. *Energy Procedia* 6.
- Cossa, P., 2004. Uncertainty analysis of the cost of climate policies. Master of Science Thesis, Technology and Policy Program, MIT, Cambridge, Massachusetts.
- Cuéllar-Franca, R., García-Gutiérrez, P., Dimitriou, I., Elder, R.H., Allen, R.W.K., Azapagic, A., 2019. Utilising carbon dioxide for transport fuels: The economic and environmental sustainability of different Fischer-Tropsch process designs. *Appl. Energy* 253, 113560. <https://doi.org/10.1016/j.apenergy.2019.113560>

- Cuéllar-Franca, R.M., Azapagic, A., 2015. Carbon capture, storage and utilisation technologies: A critical analysis and comparison of their life cycle environmental impacts. *J. CO2 Util.* 9, 82–102. <https://doi.org/10.1016/j.jcou.2014.12.001>
- Cunha, B.S.L., Garaffa, R., Gurgel, A., 2020. TEA Model Documentation (Working Paper). FGV.
- d'Amore, F., Lovisotto, L., Bezzo, F., 2020. Introducing social acceptance into the design of CCS supply chains: A case study at a European level. *J. Clean. Prod.* 249, 119337. <https://doi.org/10.1016/j.jclepro.2019.119337>
- d'Amore, F., Romano, M.C., Bezzo, F., 2021. Optimal design of European supply chains for carbon capture and storage from industrial emission sources including pipe and ship transport. *Int. J. Greenh. Gas Control* 109, 103372. <https://doi.org/10.1016/j.ijggc.2021.103372>
- Daggash, H.A., Heuberger, C.F., Mac Dowell, N., 2019. The role and value of negative emissions technologies in decarbonising the UK energy system. *Int. J. Greenh. Gas Control* 81, 181–198. <https://doi.org/10.1016/j.ijggc.2018.12.019>
- David, J., Herzog, H.J., 2000. The Cost of Carbon Capture.
- de Kleijne, K., Hanssen, S.V., van Dinteren, L., Huijbregts, M.A.J., van Zelm, R., de Coninck, H., 2022. Limits to Paris compatibility of CO2 capture and utilization. *One Earth* 5, 168–185. <https://doi.org/10.1016/j.oneear.2022.01.006>
- de Pee, A., Pinner, D., Roelofsen, O., Somers, K., Speelman, E., Witteveen, M., 2018. Decarbonization of industrial sectors -The next frontier.pdf. McKinsey&Company.
- Desport, L., Selosse, S., 2022a. Perspectives of CO2 utilization as a negative emission technology. *Sustain. Energy Technol. Assess.* 53, 102623. <https://doi.org/10.1016/j.seta.2022.102623>
- Desport, L., Selosse, S., 2022b. An overview of CO2 capture and utilization in energy models. *Resour. Conserv. Recycl.* 180, 106150. <https://doi.org/10.1016/j.resconrec.2021.106150>
- Detz, R.J., van der Zwaan, B., 2019. Transitioning towards negative CO2 emissions. *Energy Policy* 133, 110938. <https://doi.org/10.1016/j.enpol.2019.110938>
- Di Lullo, G., Oni, A.O., Kumar, A., 2021. Blending blue hydrogen with natural gas for direct consumption: Examining the effect of hydrogen concentration on transportation and well-to-combustion greenhouse gas emissions. *Int. J. Hydrog. Energy* 46, 19202–19216. <https://doi.org/10.1016/j.ijhydene.2021.03.062>
- Dieterich, V., Buttler, A., Hanel, A., Spliethoff, H., Fendt, S., 2020. Power-to-liquid via synthesis of methanol, DME or Fischer–Tropsch-fuels: a review. *Energy Environ. Sci.* 13, 3207–3252. <https://doi.org/10.1039/D0EE01187H>
- DNV-GL, 2020. Study on the Import of Liquid Renewable Energy: Technology Cost Assessment 32.
- DOE, 2022. Biden Administration Launches \$3.5 Billion Program To Capture Carbon Pollution From The Air [WWW Document]. *Energy.gov*. URL <https://www.energy.gov/articles/biden-administration-launches-35-billion-program-capture-carbon-pollution-air-0> (accessed 2.27.23).
- DOE, 2017. Demonstration of Advanced CO2 Capture Process Improvements for Coal-Fired Flue Gas (No. DE-FE0026590).
- Dooley, J.J., 2013. Estimating the Supply and Demand for Deep Geologic CO2 Storage Capacity over the Course of the 21st Century: A Meta-analysis of the Literature. *Energy Procedia* 37, 5141–5150. <https://doi.org/10.1016/j.egypro.2013.06.429>
- Doudard, R., 2017. Flexibilité et interactions de long terme dans les systèmes multi-énergies: analyse technico-économique des nouvelles filières gazières et électriques en France.
- Dowson, G., Styring, P., 2015. Conversion of Carbon Dioxide to Oxygenated Organics, in: *Carbon Dioxide Utilisation*. Elsevier, pp. 141–159. <https://doi.org/10.1016/B978-0-444-62746-9.00009-8>
- Duong, C., Bower, C., Hume, K., Rock, L., Tessarolo, S., 2019. Quest carbon capture and storage offset project: Findings and learnings from 1st reporting period. *Int. J. Greenh. Gas Control* 89, 65–75. <https://doi.org/10.1016/j.ijggc.2019.06.001>
- Dütschke, E., Wohlfarth, K., Höller, S., Viebahn, P., Schumann, D., Pietzner, K., 2016. Differences in the public perception of CCS in Germany depending on CO2 source, transport option and storage location. *Int. J. Greenh. Gas Control* 53, 149–159. <https://doi.org/10.1016/j.ijggc.2016.07.043>

- Dutta, A., Farooq, S., Karimi, I.A., Khan, S.A., 2017. Assessing the potential of CO₂ utilization with an integrated framework for producing power and chemicals. *J. CO₂ Util.* 19, 49–57. <https://doi.org/10.1016/j.jcou.2017.03.005>
- ECRA, 2017. CSI/ECRA Technology Papers 2017, Cement Sustainability Initiative, Ed. Development of State of the Art-techniques in Cement Manufacturing: Trying to Look Ahead. Duesseldorf, Geneva.
- EIA, 2022. U.S. Energy Information Administration - EIA - Independent Statistics and Analysis [WWW Document]. URL https://www.eia.gov/environment/emissions/co2_vol_mass.php (accessed 10.6.22).
- Eiken, O., Ringrose, P., Hermanrud, C., Nazarian, B., Torp, T.A., Høier, L., 2011. Lessons learned from 14 years of CCS operations: Sleipner, In Salah and Snøhvit. *Energy Procedia*, 10th International Conference on Greenhouse Gas Control Technologies 4, 5541–5548. <https://doi.org/10.1016/j.egypro.2011.02.541>
- ETSAP, 2021. IEA-ETSAP | Times [WWW Document]. URL <https://iea-etsap.org/index.php/etsap-tools/model-generators/times> (accessed 7.5.21).
- ETSAP, 2010. Iron & Steel (No. I02).
- Eurostat, 2022. Gas prices by type of user [WWW Document]. URL <https://ec.europa.eu/eurostat/databrowser/view/ten00118/default/table?lang=en> (accessed 11.23.22).
- Fais, B., Sabio, N., Strachan, N., 2016. The critical role of the industrial sector in reaching long-term emission reduction, energy efficiency and renewable targets. *Appl. Energy* 162, 699–712. <https://doi.org/10.1016/j.apenergy.2015.10.112>
- Fajardy, M., Morris, J., Gurgel, A., Herzog, H., Mac Dowell, N., Paltsev, S., 2021. The economics of bioenergy with carbon capture and storage (BECCS) deployment in a 1.5 °C or 2 °C world. *Glob. Environ. Change* 68, 102262. <https://doi.org/10.1016/j.gloenvcha.2021.102262>
- Falter, C., Batteiger, V., Sizmann, A., 2016. Climate Impact and Economic Feasibility of Solar Thermochemical Jet Fuel Production. *Environ. Sci. Technol.* 50, 470–477. <https://doi.org/10.1021/acs.est.5b03515>
- Farfan, J., Fasihi, M., Breyer, C., 2019. Trends in the global cement industry and opportunities for long-term sustainable CCU potential for Power-to-X. *J. Clean. Prod.* 217, 821–835. <https://doi.org/10.1016/j.jclepro.2019.01.226>
- Fasihi, M., Bogdanov, D., Breyer, C., 2017. Long-Term Hydrocarbon Trade Options for the Maghreb Region and Europe—Renewable Energy Based Synthetic Fuels for a Net Zero Emissions World. *Sustainability* 9, 306. <https://doi.org/10.3390/su9020306>
- Fasihi, M., Efimova, O., Breyer, C., 2019. Techno-economic assessment of CO₂ direct air capture plants. *J. Clean. Prod.* 224, 957–980. <https://doi.org/10.1016/j.jclepro.2019.03.086>
- Fazio, S., Pennington, D., 2006. Portland cement (CEM I); CEMBUREAU technology mix, EN 197-1; CEMBUREAU production mix, at plant (Location: RER).
- Ferrari, N., Mancuso, L., Burnard, K., Consonni, F., 2019. Effects of plant location on cost of CO₂ capture. *Int. J. Greenh. Gas Control* 90, 102783. <https://doi.org/10.1016/j.ijggc.2019.102783>
- Flora, M., Tankov, P., 2022. Green investment and asset stranding under transition scenario uncertainty.
- Fortes, P., 2017. Renewable electricity investment: combining top-down and bottom-up modelling approaches.
- Friedlingstein, P., O’Sullivan, M., Jones, M.W., Andrew, R.M., Gregor, L., Hauck, J., Le Quéré, C., Luijkx, I.T., Olsen, A., Peters, G.P., Peters, W., Pongratz, J., Schwingshackl, C., Sitch, S., Canadell, J.G., Ciais, P., Jackson, R.B., Alin, S.R., Alkama, R., Arneeth, A., Arora, V.K., Bates, N.R., Becker, M., Bellouin, N., Bittig, H.C., Bopp, L., Chevallier, F., Chini, L.P., Cronin, M., Evans, W., Falk, S., Feely, R.A., Gasser, T., Gehlen, M., Gkritzalis, T., Gloege, L., Grassi, G., Gruber, N., Gürses, Ö., Harris, I., Hefner, M., Houghton, R.A., Hurtt, G.C., Iida, Y., Ilyina, T., Jain, A.K., Jersild, A., Kadono, K., Kato, E., Kennedy, D., Klein Goldewijk, K., Knauer, J., Korsbakken, J.I., Landschützer, P., Lefèvre, N., Lindsay, K., Liu, J., Liu, Z., Marland, G., Mayot, N., McGrath, M.J., Metz, N., Monacci, N.M., Munro, D.R., Nakaoka, S.-I., Niwa, Y., O’Brien, K., Ono, T., Palmer, P.I., Pan, N., Pierrot, D., Pockock, K., Poulter, B., Resplandy, L., Robertson, E., Rödenbeck, C., Rodriguez, C., Rosan, T.M.,

- Schwinger, J., Séférian, R., Shutler, J.D., Skjelvan, I., Steinhoff, T., Sun, Q., Sutton, A.J., Sweeney, C., Takao, S., Tanhua, T., Tans, P.P., Tian, X., Tian, H., Tilbrook, B., Tsujino, H., Tubiello, F., van der Werf, G.R., Walker, A.P., Wanninkhof, R., Whitehead, C., Willstrand Wranne, A., Wright, R., Yuan, W., Yue, C., Yue, X., Zaehle, S., Zeng, J., Zheng, B., 2022. Global Carbon Budget 2022. *Earth Syst. Sci. Data* 14, 4811–4900. <https://doi.org/10.5194/essd-14-4811-2022>
- Fuhrman, J., Clarens, A., Calvin, K., Doney, S.C., Edmonds, J.A., O'Rourke, P., Patel, P., Pradhan, S., Shobe, W., McJeon, H., 2021. The role of direct air capture and negative emissions technologies in the shared socioeconomic pathways towards +1.5 °C and +2 °C futures. *Environ. Res. Lett.* 16, 114012. <https://doi.org/10.1088/1748-9326/ac2db0>
- Fuhrman, J., McJeon, H., Patel, P., Doney, S.C., Shobe, W.M., Clarens, A.F., 2020. Food–energy–water implications of negative emissions technologies in a +1.5 °C future. *Nat. Clim. Change* 10, 920–927. <https://doi.org/10.1038/s41558-020-0876-z>
- Fuso Nerini, F., Keppo, I., Strachan, N., 2017. Myopic decision making in energy system decarbonisation pathways. A UK case study. *Energy Strategy Rev.* 17, 19–26. <https://doi.org/10.1016/j.esr.2017.06.001>
- Fuss, S., Lamb, W.F., Callaghan, M.W., Hilaire, J., Creutzig, F., Amann, T., Beringer, T., de Oliveira Garcia, W., Hartmann, J., Khanna, T., Luderer, G., Nemet, G.F., Rogelj, J., Smith, P., Vicente, J.L.V., Wilcox, J., del Mar Zamora Dominguez, M., Minx, J.C., 2018. Negative emissions—Part 2: Costs, potentials and side effects. *Environ. Res. Lett.* 13, 063002. <https://doi.org/10.1088/1748-9326/aabf9f>
- Gabrielli, P., Gazzani, M., Mazzotti, M., 2020. The Role of Carbon Capture and Utilization, Carbon Capture and Storage, and Biomass to Enable a Net-Zero-CO₂ Emissions Chemical Industry. *Ind. Eng. Chem. Res.* 59, 7033–7045. <https://doi.org/10.1021/acs.iecr.9b06579>
- Gaur, A., Balyk, O., Glynn, J., Curtis, J., Daly, H., 2022. Low energy demand scenario for feasible deep decarbonisation: Whole energy systems modelling for Ireland. *Renew. Sustain. Energy Transit.* 2, 100024. <https://doi.org/10.1016/j.rset.2022.100024>
- GCCA, 2022. Concrete Future.
- Genave, A., 2021. Essays on energy vulnerability and energy transition in Small Island Developing States.
- GID, 2021. Cement – GIDmodel. URL http://gidmodel.org.cn/?page_id=27 (accessed 11.28.22).
- Global CCS Institute, 2022a. Global Status of CCS: 2022.
- Global CCS Institute, 2022b. The U.S. Inflation Reduction Act of 2022 [WWW Document]. *Glob. CCS Inst.* URL <https://www.globalccsinstitute.com/news-media/latest-news/ira2022/> (accessed 2.27.23).
- Global CCS Institute, 2021. Update of MHI CO₂ Capture Technology.
- Global CCS Institute, 2012. OXY COMBUSTION WITH CO₂ CAPTURE.
- Global CCS Institute, 2011. Accelerating the uptake of CCS: industrial use of captured carbon dioxide.
- Global Cement, 2013. China: First in cement [WWW Document]. URL <https://www.globalcement.com/magazine/articles/796-china-first-in-cement> (accessed 11.28.22).
- Gorre, J., Ortloff, F., van Leeuwen, C., 2019. Production costs for synthetic methane in 2030 and 2050 of an optimized Power-to-Gas plant with intermediate hydrogen storage. *Appl. Energy* 253, 113594. <https://doi.org/10.1016/j.apenergy.2019.113594>
- Griffin, P., Hammond, G., Norman, J., 2013. Industrial Energy Use from a Bottom-Up Perspective: Developing the Usable Energy Database (Beta version) 53.
- Grohnheit, P.E., 1991. Economic interpretation of the EFOM model. *Energy Econ.* 13, 143–152. [https://doi.org/10.1016/0140-9883\(91\)90047-4](https://doi.org/10.1016/0140-9883(91)90047-4)
- GRTgaz, 2018. Jupiter 1000 - Power-to-Gas - Le Projet [WWW Document]. URL <https://www.jupiter1000.eu/projet> (accessed 11.23.22).
- Gurgel, A., Reilly, J.M., Paltsev, S., 2007. Potential Land Use Implications of a Global Biofuels Industry. *J. Agric. Food Ind. Organ.* 5. <https://doi.org/10.2202/1542-0485.1202>

- Gurgel, A.C., Reilly, J., Blanc, E., 2021. Agriculture and forest land use change in the continental United States: Are there tipping points? *iScience* 24, 102772. <https://doi.org/10.1016/j.isci.2021.102772>
- Gustafsson, K., Sadegh-Vaziri, R., Grönkvist, S., Levihn, F., Sundberg, C., 2021. BECCS with combined heat and power: Assessing the energy penalty. *Int. J. Greenh. Gas Control* 108, 103248. <https://doi.org/10.1016/j.ijggc.2020.103248>
- Hank, C., Gelpke, S., Schnabl, A., White, R.J., Full, J., Wiebe, N., Smolinka, T., Schaadt, A., Henning, H.-M., Hebling, C., 2018. Economics & carbon dioxide avoidance cost of methanol production based on renewable hydrogen and recycled carbon dioxide – power-to-methanol. *Sustain. Energy Fuels* 2, 1244–1261. <https://doi.org/10.1039/C8SE00032H>
- Helgesen, P.I., 2013. Top-down and Bottom-up: Combining energy system models and macroeconomic general equilibrium models.pdf.
- Hendriks, C., Graus, W., van Bergen, F., 2004. GLOBAL CARBON DIOXIDE STORAGE POTENTIAL AND COSTS 70.
- Hennig, M., Haase, M., 2021. Techno-economic analysis of hydrogen enhanced methanol to gasoline process from biomass-derived synthesis gas. *Fuel Process. Technol.* 216, 106776. <https://doi.org/10.1016/j.fuproc.2021.106776>
- Hepburn, C., Adlen, E., Beddington, J., Carter, E.A., Fuss, S., Dowell, N.M., Minx, J.C., Smith, P., Williams, C.K., 2019. The technological and economic prospects for CO₂ utilization and removal. *Nature* 575, 87–97. <https://doi.org/10.1038/s41586-019-1681-6>
- Hertel, T.W., n.d. Chapter 14 Behavioral Parameters 21.
- Heuser, P.-M., Ryberg, D.S., Grube, T., Robinius, M., Stolten, D., 2019. Techno-economic analysis of a potential energy trading link between Patagonia and Japan based on CO₂ free hydrogen. *Int. J. Hydrog. Energy, Special Issue on Selected Contributions from the European Hydrogen Energy Conference 2018. Málaga, Spain. March 14th - 16th* 44, 12733–12747. <https://doi.org/10.1016/j.ijhydene.2018.12.156>
- Ho, D.T., 2023. Carbon dioxide removal is not a current climate solution — we need to change the narrative. *Nature* 616, 9–9. <https://doi.org/10.1038/d41586-023-00953-x>
- Ho, M.T., Allinson, G.W., Wiley, D.E., 2009. Factors affecting the cost of capture for Australian lignite coal fired power plants. *Energy Procedia* 1, 763–770. <https://doi.org/10.1016/j.egypro.2009.01.101>
- Holz, F., Scherwath, T., Crespo del Granado, P., Skar, C., Olmos, L., Ploussard, Q., Ramos, A., Herbst, A., 2021. A 2050 perspective on the role for carbon capture and storage in the European power system and industry sector. *Energy Econ.* 104, 105631. <https://doi.org/10.1016/j.eneco.2021.105631>
- Hourcade, J.-C., Jaccard, M., Bataille, C., Ghersi, F., 2006. Hybrid Modeling: New Answers to Old Challenges Introduction to the Special Issue of The Energy Journal. *Energy J.* SI2006. <https://doi.org/10.5547/ISSN0195-6574-EJ-VolSI2006-NoSI2-1>
- Hourcade, J.C., Jaccard, M., Bataille, C., Ghersi, F., 2006. Hybrid Modeling: New Answers to Old Challenges. *Energy J.* 2, 1–12.
- House, K.Z., Harvey, C.F., Aziz, M.J., Schrag, D.P., 2009. The energy penalty of post-combustion CO₂ capture & storage and its implications for retrofitting the U.S. installed base. *Energy Environ. Sci.* 2, 193–205. <https://doi.org/10.1039/B811608C>
- Huijgen, W.J.J., Ruijg, G.J., Comans, R.N.J., Witkamp, G.-J., 2006. Energy Consumption and Net CO₂ Sequestration of Aqueous Mineral Carbonation. *Ind. Eng. Chem. Res.* 45, 9184–9194. <https://doi.org/10.1021/ie060636k>
- IAMC-Documentation contributors, 2021. IAMC wiki [WWW Document]. URL https://www.iamcdocumentation.eu/index.php?title=IAMC_wiki&oldid=14740 (accessed 7.5.21).
- IEA, 2022a. Direct CO₂ emissions from selected heavy industry sectors, 2019 – Charts – Data & Statistics - IEA [WWW Document]. URL <https://www.iea.org/data-and-statistics/charts/direct-co2-emissions-from-selected-heavy-industry-sectors-2019> (accessed 12.5.22).
- IEA, 2022b. CCS Project “Longship” [WWW Document]. IEA. URL <https://www.iea.org/policies/12675-ccs-project-longship> (accessed 12.7.22).

- IEA, 2022c. Venture Capital investments in CCU start-ups, 2015-2021 – Charts – Data & Statistics [WWW Document]. IEA. URL <https://www.iea.org/data-and-statistics/charts/venture-capital-investments-in-ccu-start-ups-2015-2021> (accessed 3.16.23).
- IEA, 2022d. Section 45Q Credit for Carbon Oxide Sequestration – Policies [WWW Document]. IEA. URL <https://www.iea.org/policies/4986-section-45q-credit-for-carbon-oxide-sequestration> (accessed 3.16.23).
- IEA, 2022e. Investment tax credit for carbon capture, utilisation and storage (CCUS) – Policies [WWW Document]. IEA. URL <https://www.iea.org/policies/13346-investment-tax-credit-for-carbon-capture-utilisation-and-storage-ccus> (accessed 3.16.23).
- IEA, 2022f. Direct Air Capture: A key technology for net zero. OECD. <https://doi.org/10.1787/bbd20707-en>
- IEA, 2022g. Cement – Analysis [WWW Document]. IEA. URL <https://www.iea.org/reports/cement> (accessed 11.28.22).
- IEA, 2022h. Global cement production by material composition in the Sustainable Development Scenario, 2019 and 2070 – Charts – Data & Statistics [WWW Document]. IEA. URL <https://www.iea.org/data-and-statistics/charts/global-cement-production-by-material-composition-in-the-sustainable-development-scenario-2019-and-2070> (accessed 11.30.22).
- IEA, 2022i. Chemicals – Analysis [WWW Document]. IEA. URL <https://www.iea.org/reports/chemicals> (accessed 11.21.22).
- IEA, 2022j. Direct CO₂ emissions from primary chemical production in the Net Zero Scenario, 2015-2030 – Charts – Data & Statistics [WWW Document]. IEA. URL <https://www.iea.org/data-and-statistics/charts/direct-co2-emissions-from-primary-chemical-production-in-the-net-zero-scenario-2015-2030> (accessed 11.21.22).
- IEA, 2021a. Is carbon capture too expensive? – Analysis [WWW Document]. IEA. URL <https://www.iea.org/commentaries/is-carbon-capture-too-expensive> (accessed 1.5.23).
- IEA, 2021b. Net Zero by 2050 - A Roadmap for the Global Energy Sector 224.
- IEA, 2021c. World Energy Balances – Analysis [WWW Document]. IEA. URL <https://www.iea.org/reports/world-energy-balances-overview> (accessed 2.7.22).
- IEA, 2021d. Global Hydrogen Review 2021. OECD. <https://doi.org/10.1787/39351842-en>
- IEA, 2021e. The world has vast capacity to store CO₂: Net zero means we'll need it – Analysis - IEA [WWW Document]. URL <https://www.iea.org/commentaries/the-world-has-vast-capacity-to-store-co2-net-zero-means-we-ll-need-it> (accessed 11.10.22).
- IEA, 2020a. CCUS in clean energy transitions. Energy Technol. Perspect. 174.
- IEA, 2020b. World Energy Balances – Analysis [WWW Document]. IEA. URL <https://www.iea.org/reports/world-energy-balances-overview> (accessed 3.14.22).
- IEA, 2020c. Iron and Steel Technology Roadmap - Towards more sustainable steelmaking. Paris.
- IEA, 2019a. Putting CO₂ to Use.
- IEA, 2019b. Transforming Industry through CCUS 62.
- IEA, 2019c. World Energy Outlook 2019. IEA/OECD, Paris.
- IEA, 2019d. The Future of Hydrogen 203.
- IEA, 2019e. Emissions – Global Energy & CO₂ Status Report 2019 – Analysis [WWW Document]. IEA. URL <https://www.iea.org/reports/global-energy-co2-status-report-2019/emissions> (accessed 12.22.22).
- IEA, 2017. Energy Technology Perspectives 2017 - Catalysing Energy Technology Transformations.
- IEA, 2015. Technology Roadmap Hydrogen and Fuel Cells 81.
- IEA Bioenergy, 2019. Technical, Economic and Environmental Assessment of Biorefinery Concepts 55.
- IEA Bioenergy, 2018. Hydrogen from biomass gasification 85.
- IEAGHG, 2021a. Global Assessment of Direct Air Capture Costs (No. 2021–05).
- IEAGHG, 2021b. Biorefineries with CCS.
- IEAGHG, 2021c. IEAGHG, Exporting CO₂ for Offshore Storage – The London Protocol's Export Amendment and Associated Guidelines and Guidance (No. 2021-TR02).
- IEAGHG, 2020. The Status and Challenges of CO₂ Shipping Infrastructures (No. 2020–10).
- IEAGHG, 2017. Techno-Economic Evaluation of SMR Based Standalone (Merchant) Hydrogen Plant with CCS. IEAGHG, Cheltenham, United Kingdom.

- IIASA, n.d. SSP Public Database (Version 2.0).
- IOGP, 2019. The potential for CCS and CCU in Europe 47.
- IPCC, 2022. Climate Change 2022: Mitigation of Climate Change. Contribution of Working Group II to the Sixth Assessment Report of the Intergovernmental Panel on Climate Change.
- IPCC, 2021. Climate Change 2021: The Physical Science Basis. Contribution of Working Group I to the Sixth Assessment Report of the Intergovernmental Panel on Climate Change.
- IPCC, 2018. Global warming of 1.5°C. An IPCC Special Report on the impacts of global warming of 1.5°C above pre-industrial levels and related global greenhouse gas emission pathways, in the context of strengthening the global response to the threat of climate change, sustainable development, and efforts to eradicate poverty.
- IPCC, 2006. Emission Factor Database [WWW Document]. URL https://www.ipcc-nggip.iges.or.jp/EFDB/find_ef.php (accessed 10.7.22).
- IPCC, 2005. Carbon Dioxide Capture and Storage.
- IPCC, 1990. FAR Climate Change: The IPCC Response Strategies.
- IPCC, n.d. Global Warming Potential Values [WWW Document]. URL https://www.ghgprotocol.org/sites/default/files/ghgp/Global-Warming-Potential-Values%20%28Feb%2016%202016%29_1.pdf (accessed 9.22.20).
- IRENA, 2020. Renewable power generation costs in 2019 144.
- Irlam, L., 2017. Global CCS Institute : Global Costs of Carbon Capture and Storage. Global CCS Institute.
- Ishimoto, Y., Voldsund, M., Neksa, P., Roussanaly, S., Berstad, D., Gardarsdottir, S.O., 2020. Large-scale production and transport of hydrogen from Norway to Europe and Japan: Value chain analysis and comparison of liquid hydrogen and ammonia as energy carriers. *Int. J. Hydrog. Energy* 45, 32865–32883. <https://doi.org/10.1016/j.ijhydene.2020.09.017>
- Jacoby, H.D., O’Sullivan, F.M., Paltsev, S., 2012. The Influence of Shale Gas on U.S. Energy and Environmental Policy. *Econ. Energy Environ. Policy* 1. <https://doi.org/10.5547/2160-5890.1.1.5>
- Jahediesfanjani, H., Warwick, P.D., Anderson, S.T., 2018. Estimating the pressure-limited CO₂ injection and storage capacity of the United States saline formations: Effect of the presence of hydrocarbon reservoirs. *Int. J. Greenh. Gas Control* 79, 14–24. <https://doi.org/10.1016/j.ijggc.2018.09.011>
- Johnson, N., Parker, N., Ogden, J., 2014. How negative can biofuels with CCS take us and at what cost? Refining the economic potential of biofuel production with CCS using spatially-explicit modeling. *Energy Procedia*, 12th International Conference on Greenhouse Gas Control Technologies, GHGT-12 63, 6770–6791. <https://doi.org/10.1016/j.egypro.2014.11.712>
- Johnston, C., Ali Khan, M.H., Amal, R., Daiyan, R., MacGill, I., 2022. Shipping the sunshine: An open-source model for costing renewable hydrogen transport from Australia. *Int. J. Hydrog. Energy* 47, 20362–20377. <https://doi.org/10.1016/j.ijhydene.2022.04.156>
- JRC, 2021. Joint Research Centre Data Catalogue - The JRC European TIMES Energy System Model - European Commission [WWW Document]. URL <https://data.jrc.ec.europa.eu/collection/id-00287> (accessed 10.7.22).
- Kang, S., 2017. La place de la bioénergie dans un monde sobre en carbone: Analyse prospective et développement de la filière biomasse dans le modèle TIAM-FR. MINES ParisTech.
- Kapetaki, Z., Miranda Barbosa, E., European Commission, Joint Research Centre, 2019. Carbon capture utilisation and storage: technology development report.
- Kapsalyamova, Z., Paltsev, S., 2020. Use of natural gas and oil as a source of feedstocks. *Energy Econ.* 92, 104984. <https://doi.org/10.1016/j.eneco.2020.104984>
- Karimi, F., Toikka, A., 2018. General public reactions to carbon capture and storage: Does culture matter? *Int. J. Greenh. Gas Control* 70, 193–201. <https://doi.org/10.1016/j.ijggc.2018.01.012>
- Karplus, V.J., 2011. Climate and Energy Policy for U.S. Passenger Vehicles: A Technology-Rich Economic Modeling and Policy Analysis 223.
- Kätelhön, A., Meys, R., Deutz, S., Suh, S., Bardow, A., 2019. Climate change mitigation potential of carbon capture and utilization in the chemical industry. *Proc. Natl. Acad. Sci.* 116, 11187–11194. <https://doi.org/10.1073/pnas.1821029116>

- Kearns, J., Teletzke, G., Palmer, J., Thomann, H., Kheshgi, H., Chen, Y.-H.H., Paltsev, S., Herzog, H., 2017. Developing a Consistent Database for Regional Geologic CO₂ Storage Capacity Worldwide. *Energy Procedia*, 13th International Conference on Greenhouse Gas Control Technologies, GHGT-13, 14-18 November 2016, Lausanne, Switzerland 114, 4697–4709. <https://doi.org/10.1016/j.egypro.2017.03.1603>
- Keith, D.W., Holmes, G., Angelo, D.S., Heidel, K., 2018. A Process for Capturing CO₂ from the Atmosphere. *Joule* 2, 1573–1594. <https://doi.org/10.1016/j.joule.2018.05.006>
- Keppo, I., Strubegger, M., 2010. Short term decisions for long term problems – The effect of foresight on model based energy systems analysis. *Energy* 35, 2033–2042. <https://doi.org/10.1016/j.energy.2010.01.019>
- Khalili, S., Rantanen, E., Bogdanov, D., Breyer, C., 2019. Global Transportation Demand Development with Impacts on the Energy Demand and Greenhouse Gas Emissions in a Climate-Constrained World. *Energies* 12, 3870. <https://doi.org/10.3390/en12203870>
- Kishimoto, P.N., 2018. Transport demand in China: Methods for estimation, projection, and policy assessment 241. <https://globalchange.mit.edu/publication/17175>
- Köberle, A.C., 2019. The Value of BECCS in IAMs: a Review. *Curr. Sustain. Energy Rep.* 6, 107–115. <https://doi.org/10.1007/s40518-019-00142-3>
- Koelbl, B.S., van den Broek, M.A., van Ruijven, B.J., Faaij, A.P.C., van Vuuren, D.P., 2014. Uncertainty in the deployment of Carbon Capture and Storage (CCS): A sensitivity analysis to techno-economic parameter uncertainty. *Int. J. Greenh. Gas Control* 27, 81–102. <https://doi.org/10.1016/j.ijggc.2014.04.024>
- Kosmatka, S.H., 1988. *Design and Control of Concrete Mixtures*. Portland Cement Association, Skokie, IL, USA.
- Kothandaraman, J., Zhang, J., Glezakou, V.-A., Mock, M.T., Heldebrant, D.J., 2019. Chemical transformations of captured CO₂ into cyclic and polymeric carbonates. *J. CO₂ Util.*
- Kraxner, F., Fuss, S., Krey, V., Best, D., Leduc, S., Kindermann, G., Yamagata, Y., Schepaschenko, D., Shvidenko, A., Aoki, K., Yan, J., 2015. The Role of Bioenergy with Carbon Capture and Storage (BECCS) for Climate Policy, in: *Handbook of Clean Energy Systems*. John Wiley & Sons, Ltd, pp. 1–19. <https://doi.org/10.1002/9781118991978.hces049>
- Krook-Riekkola, A., 2017. Challenges in Top-down and Bottom-up Soft Linking: The Case of EMEC and TIMES-Sweden 24.
- Kuramochi, T., Casas, M.J. de V., Smit, S., Nilsson, A., 2022. Climate pledges by major steel companies: a long way ahead towards zero emissions (preprint). In Review. <https://doi.org/10.21203/rs.3.rs-2322621/v1>
- Labriet, M., Loulou, R., 2005. New developments related to the World TIMES model: EMF-22 Project & Climate Module 12.
- Laouir, A., 2019. Performance analysis of open-loop cycles for LH₂ regasification. *Int. J. Hydrog. Energy* 44, 22425–22436. <https://doi.org/10.1016/j.ijhydene.2018.12.204>
- Leeson, D., Mac Dowell, N., Shah, N., Petit, C., Fennell, P.S., 2017. A Techno-economic analysis and systematic review of carbon capture and storage (CCS) applied to the iron and steel, cement, oil refining and pulp and paper industries, as well as other high purity sources. *Int. J. Greenh. Gas Control* 61, 71–84. <https://doi.org/10.1016/j.ijggc.2017.03.020>
- Leonzio, G., Bogle, D., Foscolo, P.U., Zondervan, E., 2020. Optimization of CCUS supply chains in the UK: A strategic role for emissions reduction. *Chem. Eng. Res. Des.* 155, 211–228. <https://doi.org/10.1016/j.cherd.2020.01.002>
- Leonzio, G., Foscolo, P.U., Zondervan, E., 2019. An outlook towards 2030: Optimization and design of a CCUS supply chain in Germany. *Comput. Chem. Eng.* 125, 499–513. <https://doi.org/10.1016/j.compchemeng.2019.04.001>
- Leonzio, G., Zondervan, E., 2020. Analysis and optimization of carbon supply chains integrated to a power to gas process in Italy. *J. Clean. Prod.* 269, 122172. <https://doi.org/10.1016/j.jclepro.2020.122172>
- Leung, D.Y.C., Caramanna, G., Maroto-Valer, M.M., 2014. An overview of current status of carbon dioxide capture and storage technologies. *Renew. Sustain. Energy Rev.* 39, 426–443. <https://doi.org/10.1016/j.rser.2014.07.093>

- Linzenich, A., Arning, K., Offermann-van Heek, J., Ziefle, M., 2019. Uncovering attitudes towards carbon capture storage and utilization technologies in Germany: Insights into affective-cognitive evaluations of benefits and risks. *Energy Res. Soc. Sci.* 48, 205–218. <https://doi.org/10.1016/j.erss.2018.09.017>
- Lippi, R., Howard, S.C., Barron, H., Easton, C.D., Madsen, I.C., Waddington, L.J., Vogt, C., Hill, M.R., Sumbly, C.J., Doonan, C.J., Kennedy, D.F., 2017. Highly active catalyst for CO₂ methanation derived from a metal organic framework template. *J. Mater. Chem. A* 5, 12990–12997. <https://doi.org/10.1039/C7TA00958E>
- Liu, J., Tong, D., Zheng, Y., Cheng, J., Qin, X., Shi, Q., Yan, L., Lei, Y., Zhang, Q., 2021. Carbon and air pollutant emissions from China's cement industry 1990–2015: trends, evolution of technologies, and drivers. *Atmospheric Chem. Phys.* 21, 1627–1647. <https://doi.org/10.5194/acp-21-1627-2021>
- L'Orange Seigo, S., Dohle, S., Siegrist, M., 2014. Public perception of carbon capture and storage (CCS): A review. *Renew. Sustain. Energy Rev.* 38, 848–863. <https://doi.org/10.1016/j.rser.2014.07.017>
- Loulou, R., 2008. ETSAP-TIAM: the TIMES integrated assessment model. part II: mathematical formulation. *Comput. Manag. Sci.* 5, 41–66. <https://doi.org/10.1007/s10287-007-0045-0>
- Loulou, R., Labriet, M., 2008. ETSAP-TIAM: the TIMES integrated assessment model Part I: Model structure. *Comput. Manag. Sci.* 5, 7–40. <https://doi.org/10.1007/s10287-007-0046-z>
- Luckow, P., Wise, M.A., Dooley, J.J., Kim, S.H., 2010. Large-scale utilization of biomass energy and carbon dioxide capture and storage in the transport and electricity sectors under stringent CO₂ concentration limit scenarios. *Int. J. Greenh. Gas Control* 4, 865–877. <https://doi.org/10.1016/j.ijggc.2010.06.002>
- Luo, X., Wang, M., 2017. Study of solvent-based carbon capture for cargo ships through process modelling and simulation. *Appl. Energy* 195, 402–413. <https://doi.org/10.1016/j.apenergy.2017.03.027>
- Lux, B., Schneck, N., Pfluger, B., Männer, W., Sensfuß, F., 2023. Potentials of direct air capture and storage in a greenhouse gas-neutral European energy system. *Energy Strategy Rev.* 45, 101012. <https://doi.org/10.1016/j.esr.2022.101012>
- Mahajan, D., Tan, K., Venkatesh, T., Kileti, P., Clayton, C.R., 2022. Hydrogen Blending in Gas Pipeline Networks—A Review. *Energies* 15, 3582. <https://doi.org/10.3390/en15103582>
- Mancini, N.D., Mitsos, A., 2011. Conceptual design and analysis of ITM oxy-combustion power cycles. *Phys. Chem. Chem. Phys.* 13, 21351–21361. <https://doi.org/10.1039/C1CP23027A>
- Mantripragada, H.C., Zhai, H., Rubin, E.S., 2019. Boundary Dam or Petra Nova – Which is a better model for CCS energy supply? *Int. J. Greenh. Gas Control* 82, 59–68. <https://doi.org/10.1016/j.ijggc.2019.01.004>
- Marchese, M., Buffo, G., Santarelli, M., Lanzini, A., 2021. CO₂ from direct air capture as carbon feedstock for Fischer-Tropsch chemicals and fuels: Energy and economic analysis. *J. CO₂ Util.* 46, 101487. <https://doi.org/10.1016/j.jcou.2021.101487>
- Marcucci, A., Kypreos, S., Panos, E., 2017. The road to achieving the long-term Paris targets: energy transition and the role of direct air capture. *Clim. Change* 144, 181–193. <https://doi.org/10.1007/s10584-017-2051-8>
- McCarten, M., Bayaraa, M., Caldecott, B., Christiaen, C., Foster, P., Hickey, C., Kampmann, D., Layman, C., Rossi, C., Scott, K., Tang, K., Tkachenko, N., Yoken, D., 2021. Global Database of Iron and Steel Production Assets. Spatial Finance Initiative.
- McQueen, N., Gomes, K.V., McCormick, C., Blumanthal, K., Pisciotta, M., Wilcox, J., 2021. A review of direct air capture (DAC): scaling up commercial technologies and innovating for the future. *Prog. Energy* 3, 032001. <https://doi.org/10.1088/2516-1083/abf1ce>
- Meadows, Donella, Meadows, Dennis, Randers, J., Behrens III, W., 1972. The limits to growth.
- Meng, J., Liao, W., Zhang, G., 2021. Emerging CO₂-Mineralization Technologies for Co-Utilization of Industrial Solid Waste and Carbon Resources in China. *Minerals* 11, 274. <https://doi.org/10.3390/min11030274>
- Methanol Institute, 2016. Methanol use in gasoline.

- Millot, A., Krook-Riekkola, A., Maïzi, N., 2020. Guiding the future energy transition to net-zero emissions: Lessons from exploring the differences between France and Sweden. *Energy Policy* 139, 111358. <https://doi.org/10.1016/j.enpol.2020.111358>
- Minx, J.C., Lamb, W.F., Callaghan, M.W., Bornmann, L., Fuss, S., 2017. Fast growing research on negative emissions. *Environ. Res. Lett.* 12, 035007. <https://doi.org/10.1088/1748-9326/aa5ee5>
- Morfeldt, J., Nijs, W., Silveira, S., 2015. The impact of climate targets on future steel production – an analysis based on a global energy system model. *J. Clean. Prod., Carbon Emissions Reduction: Policies, Technologies, Monitoring, Assessment and Modeling* 103, 469–482. <https://doi.org/10.1016/j.jclepro.2014.04.045>
- Morris, J., Farrell, J., Kheshgi, H., Thomann, H., Chen, H., Paltsev, S., Herzog, H., 2019a. Representing the costs of low-carbon power generation in multi-region multi-sector energy-economic models. *Int. J. Greenh. Gas Control* 87, 170–187. <https://doi.org/10.1016/j.ijggc.2019.05.016>
- Morris, J., Kheshgi, H., Paltsev, S., Herzog, H., 2021. Scenarios For The Deployment Of Carbon Capture And Storage In The Power Sector In A Portfolio Of Mitigation Options. *Clim. Change Econ. CCE* 12, 1–29.
- Morris, J., Reilly, J.M., Chen, Y.-H.H., 2019b. Advanced technologies in energy-economy models for climate change assessment. *Energy Econ.* 80, 476–490. <https://doi.org/10.1016/j.eneco.2019.01.034>
- Mousa, E., Wang, C., Riesbeck, J., Larsson, M., 2016. Biomass applications in iron and steel industry: An overview of challenges and opportunities. *Renew. Sustain. Energy Rev.* 65, 1247–1266.
- Mukherjee, A., Bruijninx, P., Junginger, M., 2020. A Perspective on Biofuels Use and CCS for GHG Mitigation in the Marine Sector. *iScience* 23, 101758. <https://doi.org/10.1016/j.isci.2020.101758>
- Muratori, M., Bauer, N., Rose, S.K., Wise, M., Daioglou, V., Cui, Y., Kato, E., Gidden, M., Strefler, J., Fujimori, S., Sands, R.D., van Vuuren, D.P., Weyant, J., 2020. EMF-33 insights on bioenergy with carbon capture and storage (BECCS). *Clim. Change* 162, 1621–1637. <https://doi.org/10.1007/s10584-020-02784-5>
- Muratori, M., Kheshgi, H., Mignone, B., McJeon, H., Clarke, L., 2017. The Future Role of CCS in Electricity and Liquid Fuel Supply. *Energy Procedia*, 13th International Conference on Greenhouse Gas Control Technologies, GHGT-13, 14-18 November 2016, Lausanne, Switzerland 114, 7606–7614. <https://doi.org/10.1016/j.egypro.2017.03.1893>
- Naims, H., 2016. Economics of carbon dioxide capture and utilization-a supply and demand perspective. *Environ. Sci. Pollut. Res. Int.* 23, 22226–22241. <https://doi.org/10.1007/s11356-016-6810-2>
- NASEM, 2019a. Negative Emissions Technologies and Reliable Sequestration: A Research Agenda. National Academies Press, Washington, D.C. <https://doi.org/10.17226/25259>
- NASEM, 2019b. Negative Emissions Technologies and Reliable Sequestration: A Research Agenda. National Academies Press, Washington, D.C. <https://doi.org/10.17226/25259>
- Neelis, M.L., Patel, M.K., 2006. Long-term production, energy use and CO₂ emission scenarios for the worldwide iron and steel industry. *UU CHEM NW&S (Copernicus)*.
- Neeraj, Yadav, S., 2020. Carbon storage by mineral carbonation and industrial applications of CO₂. *Mater. Sci. Energy Technol.* 3, 494–500. <https://doi.org/10.1016/j.mset.2020.03.005>
- Net Zero Steel, 2021. Climate change policy paper. worldsteel.org. URL <https://worldsteel.org/publications/policy-papers/climate-change-policy-paper/> (accessed 4.6.23).
- NETL, 2022. Comparison of Commercial, State-of-the-Art, Fossil-Based Hydrogen Production Technologies (No. DOE/NETL-2022/3241, 1862910). <https://doi.org/10.2172/1862910>
- NETL, 2017. FE/NETL CO₂ Saline Storage Cost Model (2017) - EDX [WWW Document]. URL <https://edx.netl.doe.gov/dataset/fe-netl-co2-saline-storage-cost-model-2017> (accessed 11.30.21).
- NETL, n.d. Great Plains Synfuels Plant [WWW Document]. netl.doe.gov. URL <https://netl.doe.gov/research/Coal/energy-systems/gasification/gasifipedia/great-plains> (accessed 12.5.22).

- Niermann, M., Timmerberg, S., Drünert, S., Kaltschmitt, M., 2021. Liquid Organic Hydrogen Carriers and alternatives for international transport of renewable hydrogen. *Renew. Sustain. Energy Rev.* 135, 110171. <https://doi.org/10.1016/j.rser.2020.110171>
- Nisbet, M.C., 2019. The Carbon Removal Debate: Asking Critical Questions About Climate Change Futures. *Inst. Carbon Remov. Law Policy Am. Univ.* 24.
- Nordhaus, W.D., 1999. Roll the DICE Again: The Economics of Global Warming 79.
- Norgate, T., Haque, N., Somerville, M., Jahanshahi, S., 2012. Biomass as a Source of Renewable Carbon for Iron and Steelmaking. *ISIJ Int.* 52, 1472–1481. <https://doi.org/10.2355/isijinternational.52.1472>
- Norton, M., Baldi, A., Buda, V., Carli, B., Cudlin, P., Jones, M.B., Korhola, A., Michalski, R., Novo, F., Oszlányi, J., Santos, F.D., Schink, B., Shepherd, J., Vet, L., Walloe, L., Wijkman, A., 2019. Serious mismatches continue between science and policy in forest bioenergy. *GCB Bioenergy* 11, 1256–1263. <https://doi.org/10.1111/gcbb.12643>
- NPC, 2019a. Meeting the Dual Challenge - CO2 Transport.
- NPC, 2019b. Meeting the Dual Challenge - CO2 Capture.
- NPC, 2019c. Meeting the Dual Challenge - CO2 Use.
- Nwachukwu, C.M., Wang, C., Wetterlund, E., 2021. Exploring the role of forest biomass in abating fossil CO2 emissions in the iron and steel industry – The case of Sweden. *Appl. Energy* 288.
- Octaviano, C., Paltsev, S., Gurgel, A.C., 2016. Climate change policy in Brazil and Mexico: Results from the MIT EPPA model. *Energy Econ.* 56, 600–614. <https://doi.org/10.1016/j.eneco.2015.04.007>
- OECD, 2019. World conversion factors (Edition 2018). Organisation for Economic Co-operation and Development, Paris.
- OECD, n.d. Environment-economy modelling tools - OECD [WWW Document]. URL <https://www.oecd.org/environment/indicators-modelling-outlooks/modelling.htm> (accessed 10.12.22).
- OECD-FAO, 2019. OECD-FAO Agricultural Outlook 2019-2028 [WWW Document]. URL https://stats.oecd.org/Index.aspx?DataSetCode=HIGH_AGLINK_2019# (accessed 9.6.21).
- Offermann-van Heek, J., Arning, K., Linzenich, A., Ziefle, M., 2018. Trust and Distrust in Carbon Capture and Utilization Industry as Relevant Factors for the Acceptance of Carbon-Based Products. *Front. Energy Res.* 6.
- OGCI, 2020. Interactive CO2 map Carbon Capture Utilisation and Storage [WWW Document]. URL <https://www.ogci.com/co2-storage-resource-catalogue/> (accessed 12.6.21).
- Pale Blue Dot., 2021. CO2 Storage Resource Catalogue - Cycle 2 (No. 10365GLOB).
- Pale Blue Dot Energy, 2016. Progressing Development of the UK's Strategic Carbon Dioxide Storage Resource - A Summary of Results from the Strategic UK CO2 Storage Appraisal Project.
- Pale Blue Dot., 2020. Global Storage Resource Assessment – 2019 Update.
- Paltsev, S., Jacoby, H.D., Reilly, J.M., Ejaz, Q.J., Morris, J., O'Sullivan, F., Rausch, S., Winchester, N., Kragha, O., 2011. The future of U.S. natural gas production, use, and trade. *Energy Policy* 39, 5309–5321. <https://doi.org/10.1016/j.enpol.2011.05.033>
- Paltsev, S., Morris, J., Khashgi, H., Herzog, H., 2021. Hard-to-Abate Sectors: The role of industrial carbon capture and storage (CCS) in emission mitigation. *Appl. Energy* 300, 117322. <https://doi.org/10.1016/j.apenergy.2021.117322>
- Parkinson, B., Balcombe, P., Speirs, J.F., Hawkes, A.D., Hellgardt, K., 2019. Levelized cost of CO2 mitigation from hydrogen production routes. *Energy Environ. Sci.* 12, 19–40. <https://doi.org/10.1039/C8EE02079E>
- Pérez-Forbes, M., Schöneberger, J.C., Boulamanti, A., Tzimas, E., 2016. Methanol synthesis using captured CO2 as raw material: Techno-economic and environmental assessment. *Appl. Energy* 161, 718–732. <https://doi.org/10.1016/j.apenergy.2015.07.067>
- Plasynski, S., Brickett, L.A., Preston, C.K., 2008. Weyburn Carbon Dioxide Sequestration Project 4.
- Postic, S., 2015. Modélisation prospective pour le secteur énergétique en Amérique du Sud - Application aux négociations climatiques internationales (These de doctorat). Paris, ENMP.
- Prina, M.G., Manzolini, G., Moser, D., Nastasi, B., Sparber, W., 2020. Classification and challenges of bottom-up energy system models - A review. *Renew. Sustain. Energy Rev.* 129, 109917. <https://doi.org/10.1016/j.rser.2020.109917>

- Pye, S., Bradley, S., Hughes, N., Price, J., Welsby, D., Ekins, P., 2020. An equitable redistribution of unburnable carbon. *Nat. Commun.* 11, 3968. <https://doi.org/10.1038/s41467-020-17679-3>
- Quarton, C.J., Samsatli, S., 2020. The value of hydrogen and carbon capture, storage and utilisation in decarbonising energy: Insights from integrated value chain optimisation. *Appl. Energy* 257, 113936. <https://doi.org/10.1016/j.apenergy.2019.113936>
- Raab, M., Maier, S., Dietrich, R.-U., 2021. Comparative techno-economic assessment of a large-scale hydrogen transport via liquid transport media. *Int. J. Hydrog. Energy* 46, 11956–11968. <https://doi.org/10.1016/j.ijhydene.2020.12.213>
- Realmonte, G., Drouet, L., Gambhir, A., Glynn, J., Hawkes, A., Köberle, A.C., Tavoni, M., 2019. An inter-model assessment of the role of direct air capture in deep mitigation pathways. *Nat. Commun.* 10, 3277. <https://doi.org/10.1038/s41467-019-10842-5>
- Reimer, J., Hertel, T., 2004. Estimation of International Demand Behaviour for Use with Input-Output Based Data. *Econ. Syst. Res.* 16, 347–366. <https://doi.org/10.1080/0953531042000304245>
- Ren, M., Ma, T., Fang, C., Liu, X., Guo, C., Zhang, S., Zhou, Z., Zhu, Y., Dai, H., Huang, C., 2023. Negative emission technology is key to decarbonizing China's cement industry. *Appl. Energy* 329, 120254. <https://doi.org/10.1016/j.apenergy.2022.120254>
- Riahi, K., van Vuuren, D.P., Kriegler, E., Edmonds, J., O'Neill, B.C., Fujimori, S., Bauer, N., Calvin, K., Dellink, R., Fricko, O., Lutz, W., Popp, A., Cuaresma, J.C., Kc, S., Leimbach, M., Jiang, L., Kram, T., Rao, S., Emmerling, J., Ebi, K., Hasegawa, T., Havlik, P., Humpenöder, F., Da Silva, L.A., Smith, S., Stehfest, E., Bosetti, V., Eom, J., Gernaat, D., Masui, T., Rogelj, J., Strefler, J., Drouet, L., Krey, V., Luderer, G., Harmsen, M., Takahashi, K., Baumstark, L., Doelman, J.C., Kainuma, M., Klimont, Z., Marangoni, G., Lotze-Campen, H., Obersteiner, M., Tabeau, A., Tavoni, M., 2017. The Shared Socioeconomic Pathways and their energy, land use, and greenhouse gas emissions implications: An overview. *Glob. Environ. Change* 42, 153–168. <https://doi.org/10.1016/j.gloenvcha.2016.05.009>
- Ritchie, H., Roser, M., 2020. CO2 emissions [WWW Document]. Our World Data. URL <https://ourworldindata.org/co2-emissions> (accessed 11.13.20).
- Ritchie, H., Roser, M., Rosado, P., 2020. CO₂ and Greenhouse Gas Emissions. Our World Data.
- Rogelj, J., Popp, A., Calvin, K.V., Luderer, G., Emmerling, J., Gernaat, D., Fujimori, S., Strefler, J., Hasegawa, T., Marangoni, G., Krey, V., Kriegler, E., Riahi, K., van Vuuren, D.P., Doelman, J., Drouet, L., Edmonds, J., Fricko, O., Harmsen, M., Havlik, P., Humpenöder, F., Stehfest, E., Tavoni, M., 2018. Scenarios towards limiting global mean temperature increase below 1.5 °C. *Nat. Clim. Change* 8, 325–332. <https://doi.org/10.1038/s41558-018-0091-3>
- Rosa, L., Mazzotti, M., 2022. Potential for hydrogen production from sustainable biomass with carbon capture and storage. *Renew. Sustain. Energy Rev.* 157, 112123. <https://doi.org/10.1016/j.rser.2022.112123>
- Rubin, E.S., Davison, J.E., Herzog, H.J., 2015. The cost of CO₂ capture and storage. *Int. J. Greenh. Gas Control*, Special Issue commemorating the 10th year anniversary of the publication of the Intergovernmental Panel on Climate Change Special Report on CO₂ Capture and Storage 40, 378–400. <https://doi.org/10.1016/j.ijggc.2015.05.018>
- Rutherford, T.F., 2009. Lecture Notes on CES Functions 22.
- Rutherford, T.F., 1999. Applied General Equilibrium Modeling with MPSGE as a GAMS Subsystem: An Overview of the Modeling Framework and Syntax 49.
- Sahoo, P.C., Kumar, M., Puri, S.K., Ramakumar, S.S.V., 2018. Enzyme inspired complexes for industrial CO₂ capture: Opportunities and challenges. *J. CO₂ Util.*
- Saito, A., Itaoka, K., Akai, M., 2019. Those who care about CCS—Results from a Japanese survey on public understanding of CCS-. *Int. J. Greenh. Gas Control* 84, 121–130. <https://doi.org/10.1016/j.ijggc.2019.02.014>
- Sandalow, D., Friedmann, J., Aines, R., McCormick, C., McCoy, S., Stolaroff, J., 2019. ICEF Industrial heat decarbonisation roadmap.pdf. ICEF.
- Sanna, A., Uibu, M., Caramanna, G., Kuusik, R., Maroto-Valer, M.M., 2014. A review of mineral carbonation technologies to sequester CO₂. *Chem. Soc. Rev.* 43, 8049–8080. <https://doi.org/10.1039/C4CS00035H>
- Sathaye, J., Sanstad, A.H., 2004. Bottom-up energy modeling. *Encycl. Energy* 1.

- SCCS, 2022. HECLLOT Pilot Details [WWW Document]. URL <https://www.geos.ed.ac.uk/sccs/project-info/1601> (accessed 12.5.22).
- SCCS, n.d. Global CCS Map [WWW Document]. URL <https://www.sccs.org.uk/expertise/global-ccs-map> (accessed 12.5.22).
- Schäfer, A., Jacoby, H.D., 2005. Technology detail in a multisector CGE model: transport under climate policy. *Energy Econ.* 27, 1–24. <https://doi.org/10.1016/j.eneco.2004.10.005>
- Schemme, S., Breuer, J.L., Samsun, R.C., Peters, R., Stolten, D., 2018. Promising catalytic synthesis pathways towards higher alcohols as suitable transport fuels based on H₂ and CO₂. *J. CO₂ Util.*
- Schmalensee, R., Stoker, T.M., Judson, R.A., 1998. World Carbon Dioxide Emissions: 1950-2050. *Rev. Econ. Stat.* 80, 15–27.
- Schmauss, T.A., Barnett, S.A., 2021. Viability of Vehicles Utilizing On-Board CO₂ Capture. *ACS Energy Lett.* 6, 3180–3184. <https://doi.org/10.1021/acsenergylett.1c01426>
- Schmidt, O., Gambhir, A., Staffell, I., Hawkes, A., Nelson, J., Few, S., 2017. Future cost and performance of water electrolysis: An expert elicitation study. *Int. J. Hydrog. Energy* 42, 30470–30492. <https://doi.org/10.1016/j.ijhydene.2017.10.045>
- Schmidt, P., Batteiger, V., Roth, A., Weindorf, W., Raksha, T., 2018. Power-to-Liquids as Renewable Fuel Option for Aviation: A Review. *Chem. Ing. Tech.* 90, 127–140. <https://doi.org/10.1002/cite.201700129>
- SEA-DISTANCES.ORG, 2022. SEA-DISTANCES.ORG - Distances [WWW Document]. URL <https://sea-distances.org/> (accessed 11.15.22).
- Seck, G.S., Hache, E., Barnet, C., 2022a. Potential bottleneck in the energy transition: The case of cobalt in an accelerating electro-mobility world. *Resour. Policy* 75, 102516. <https://doi.org/10.1016/j.resourpol.2021.102516>
- Seck, G.S., Hache, E., Sabathier, J., Guedes, F., Reigstad, G.A., Straus, J., Wolfgang, O., Ouassou, J.A., Askeland, M., Hjorth, I., Skjelbred, H.I., Andersson, L.E., Douguet, S., Villavicencio, M., Trüby, J., Brauer, J., Cabot, C., 2022b. Hydrogen and the decarbonization of the energy system in europe in 2050: A detailed model-based analysis. *Renew. Sustain. Energy Rev.* 167, 112779. <https://doi.org/10.1016/j.rser.2022.112779>
- Seljom, P., Tomasgard, A., 2017. The impact of policy actions and future energy prices on the cost-optimal development of the energy system in Norway and Sweden. *Energy Policy* 106, 85–102. <https://doi.org/10.1016/j.enpol.2017.03.011>
- Selosse, S., 2019. Bioenergy with carbon capture and storage: how carbon storage and biomass resources potentials can impact the development of the BECCS, in: *Bioenergy with Carbon Capture and Storage*. Elsevier, pp. 237–256. <https://doi.org/10.1016/B978-0-12-816229-3.00012-0>
- Selosse, S., Ricci, O., 2017. Carbon capture and storage: Lessons from a storage potential and localization analysis. *Appl. Energy* 188, 32–44. <https://doi.org/10.1016/j.apenergy.2016.11.117>
- Selosse, S., Ricci, O., Garabedian, S., Maïzi, N., 2018. Exploring sustainable energy future in Reunion Island. *Util. Policy* 55, 158–166. <https://doi.org/10.1016/j.jup.2018.10.006>
- Selosse, S., Ricci, O., Maïzi, N., 2013. Fukushima’s impact on the European power sector: The key role of CCS technologies. *Energy Econ.* 39, 305–312. <https://doi.org/10.1016/j.eneco.2013.05.013>
- Sendi, M., Bui, M., Mac Dowell, N., Fennell, P., 2022. Geospatial analysis of regional climate impacts to accelerate cost-efficient direct air capture deployment. *One Earth* 5, 1153–1164. <https://doi.org/10.1016/j.oneear.2022.09.003>
- Sgobbi, A., Nijs, W., De Miglio, R., Chiodi, A., Gargiulo, M., Thiel, C., 2016. How far away is hydrogen? Its role in the medium and long-term decarbonisation of the European energy system. *Int. J. Hydrog. Energy* 41, 19–35. <https://doi.org/10.1016/j.ijhydene.2015.09.004>
- Sharma, S., Maréchal, F., 2019. Carbon Dioxide Capture From Internal Combustion Engine Exhaust Using Temperature Swing Adsorption. *Front. Energy Res.* 7, 143. <https://doi.org/10.3389/fenrg.2019.00143>
- Sigginì, G., 2022. Approche intégrée pour l’analyse prospective de la décarbonisation profonde du système électrique européen à l’horizon 2050 face à la variabilité climatique.

- Siriruang, C., Toochinda, P., Julnipitawong, P., Tangtermsirikul, S., 2016. CO₂ capture using fly ash from coal fired power plant and applications of CO₂-captured fly ash as a mineral admixture for concrete. *J. Environ. Manage.* 170, 70–78. <https://doi.org/10.1016/j.jenvman.2016.01.010>
- Siskos, P., Capros, P., De Vita, A., 2015. CO₂ and energy efficiency car standards in the EU in the context of a decarbonisation strategy: A model-based policy assessment. *Energy Policy* 84, 22–34. <https://doi.org/10.1016/j.enpol.2015.04.024>
- Slade, R., Di Lucia, L., Adams, P., 2018. Chapter 2 - How Policy Makers Learned to Start Worrying and Fell Out of Love With Bioenergy, in: Thornley, P., Adams, P. (Eds.), *Greenhouse Gas Balances of Bioenergy Systems*. Academic Press, pp. 11–28. <https://doi.org/10.1016/B978-0-08-101036-5.00002-1>
- Smith, E., Morris, J., Kheshgi, H., Teletzke, G., Herzog, H., Paltsev, S., 2021a. The cost of CO₂ transport and storage in global integrated assessment modeling. *Int. J. Greenh. Gas Control* 109, 103367. <https://doi.org/10.1016/j.ijggc.2021.103367>
- Smith, E., Morris, J., Kheshgi, H., Teletzke, G., Herzog, H., Paltsev, S., 2021b. The cost of CO₂ transport and storage in global integrated assessment modeling. *Int. J. Greenh. Gas Control* 109, 103367. <https://doi.org/10.1016/j.ijggc.2021.103367>
- Smith, R., 2011. Methanol to Gasoline 143.
- Sokolov, A., 2005. The MIT Integrated Global System Model (IGSM) Version 2: Model Description and Baseline Evaluation 46.
- Sokolov, A., Kicklighter, D., Schlosser, A., Wang, C., Monier, E., Brown-Steiner, B., Prinn, R., Forest, C., Gao, X., Libardoni, A., Eastham, S., 2018. Description and Evaluation of the MIT Earth System Model (MESM). *J. Adv. Model. Earth Syst.* 10, 1759–1789. <https://doi.org/10.1029/2018MS001277>
- Strategy CCUS, 2022. Experiences from surveys: Social acceptance of CCUS by the general public | Strategy CCUS.
- Subramanian, A.S.R., Gundersen, T., Adams, T.A., 2018. Modeling and Simulation of Energy Systems: A Review. *Processes* 6, 238. <https://doi.org/10.3390/pr6120238>
- Suopajarvi, H., Kempainen, A., Haapakangas, J., Fabritius, T., 2017. Extensive review of the opportunities to use biomass-based fuels in iron and steelmaking processes. *J. Clean. Prod.* 148, 709–734. <https://doi.org/10.1016/j.jclepro.2017.02.029>
- Szima, S., Cormos, C.-C., 2018. Improving methanol synthesis from carbon-free H₂ and captured CO₂: A techno-economic and environmental evaluation. *J. CO₂ Util.*
- Takeshita, T., 2013. A cost-optimal scenario of CO₂ sequestration in a carbon-constrained world through to 2050. *Nat. Sci.* 5, 313–319. <https://doi.org/10.4236/ns.2013.52A043>
- Tanzer, S.E., Blok, K., Ramirez, A., 2020. Can bioenergy with carbon capture and storage result in carbon negative steel? *Int. J. Greenh. Gas Control* 100, 103104. <https://doi.org/10.1016/j.ijggc.2020.103104>
- Tapia, J.F.D., Lee, J.-Y., Ooi, R.E.H., Foo, D.C.Y., Tan, R.R., 2014. CO₂ Allocation for Scheduling Enhanced Oil Recovery (EOR) Operations with Geological Sequestration Using Discrete-time Optimization. *Energy Procedia, International Conference on Applied Energy, ICAE2014* 61, 595–598. <https://doi.org/10.1016/j.egypro.2014.11.1189>
- Teske, S. (Ed.), 2019. *Achieving the Paris Climate Agreement Goals: Global and Regional 100% Renewable Energy Scenarios with Non-energy GHG Pathways for +1.5°C and +2°C*. Springer International Publishing, Cham. <https://doi.org/10.1007/978-3-030-05843-2>
- Thema, M., Bauer, F., Sterner, M., 2019. Power-to-Gas: Electrolysis and methanation status review. *Renew. Sustain. Energy Rev.* 112, 775–787. <https://doi.org/10.1016/j.rser.2019.06.030>
- Thibeau, S., Bachu, S., Birkholzer, J., Holloway, S., Neele, F., Zhou, Q., 2014. Using Pressure and Volumetric Approaches to Estimate CO₂ Storage Capacity in Deep Saline Aquifers. *Energy Procedia, 12th International Conference on Greenhouse Gas Control Technologies, GHGT-12* 63, 5294–5304. <https://doi.org/10.1016/j.egypro.2014.11.560>
- Thibeau, S., Chatelan, L., Jazayeri Noushabadi, M., Adler, F., Millancourt, F., 2022. Pressure-derived storage efficiency for open saline aquifer CO₂ storage. <https://doi.org/10.2139/ssrn.4271670>
- UNFCCC, 2023. Nationally Determined Contributions Registry | UNFCCC [WWW Document]. URL <https://unfccc.int/NDCREG> (accessed 2.2.23).

- van der Zwaan, B., Broecks, K., Dalla Longa, F., 2022. Deployment of CO₂ capture and storage in Europe under limited public acceptance—An energy system perspective. *Environ. Innov. Soc. Transit.* 45, 200–213. <https://doi.org/10.1016/j.eist.2022.10.004>
- van Ruijven, B.J., van Vuuren, D.P., Boskaljon, W., Neelis, M.L., Saygin, D., Patel, M.K., 2016. Long-term model-based projections of energy use and CO₂ emissions from the global steel and cement industries. *Resour. Conserv. Recycl.* 112, 15–36. <https://doi.org/10.1016/j.resconrec.2016.04.016>
- van Vuuren, D.P., Hoogwijk, M., Barker, T., Riahi, K., Boeters, S., Chateau, J., Scricciu, S., van Vliet, J., Masui, T., Blok, K., Blomen, E., Kram, T., 2009. Comparison of top-down and bottom-up estimates of sectoral and regional greenhouse gas emission reduction potentials. *Energy Policy* 37, 5125–5139. <https://doi.org/10.1016/j.enpol.2009.07.024>
- Vasudevan, S., Farooq, S., Karimi, I.A., Saeys, M., Quah, M.C.G., Agrawal, R., 2016. Energy penalty estimates for CO₂ capture: Comparison between fuel types and capture-combustion modes. *Energy* 103, 709–714. <https://doi.org/10.1016/j.energy.2016.02.154>
- Vaughan, N.E., Gough, C., Mander, S., Littleton, E.W., Welfle, A., Gernaat, D.E.H.J., Vuuren, D.P. van, 2018. Evaluating the use of biomass energy with carbon capture and storage in low emission scenarios. *Environ. Res. Lett.* 13, 044014. <https://doi.org/10.1088/1748-9326/aaaa02>
- Watanabe, M.D.B., Cherubini, F., Tisserant, A., Cavalett, O., 2022. Drop-in and hydrogen-based biofuels for maritime transport: Country-based assessment of climate change impacts in Europe up to 2050. *Energy Convers. Manag.* 273, 116403. <https://doi.org/10.1016/j.enconman.2022.116403>
- Watari, T., Cao, Z., Hata, S., Nansai, K., 2022. Efficient use of cement and concrete to reduce reliance on supply-side technologies for net-zero emissions. *Nat. Commun.* 13, 4158. <https://doi.org/10.1038/s41467-022-31806-2>
- Wene, C.-O., 1996. Energy-economy analysis: Linking the macroeconomic and systems engineering approaches. *Energy* 21, 809–824. [https://doi.org/10.1016/0360-5442\(96\)00017-5](https://doi.org/10.1016/0360-5442(96)00017-5)
- Wevers, J.B., Shen, L., van der Spek, M., 2020. What Does It Take to Go Net-Zero-CO₂? A Life Cycle Assessment on Long-Term Storage of Intermittent Renewables With Chemical Energy Carriers. *Front. Energy Res.* 8.
- Whitmarsh, L., Xenias, D., Jones, C.R., 2019. Framing effects on public support for carbon capture and storage. *Palgrave Commun.* 5, 1–10. <https://doi.org/10.1057/s41599-019-0217-x>
- Williams, J.H., Jones, R.A., Haley, B., Kwok, G., Hargreaves, J., Farbes, J., Torn, M.S., 2021. Carbon-Neutral Pathways for the United States. *AGU Adv.* 2, e2020AV000284. <https://doi.org/10.1029/2020AV000284>
- Winchester, N., McConnachie, D., Wollersheim, C., Waitz, I., 2013. Market Cost of Renewable Jet Fuel Adoption in the United States (No. 238). MIT Joint Program on the Science and Policy of Global Change.
- Wiser, R., Rand, J., Seel, J., Beiter, P., Baker, E., Lantz, E., Gilman, P., 2021. Expert elicitation survey predicts 37% to 49% declines in wind energy costs by 2050. *Nat. Energy* 6, 555–565. <https://doi.org/10.1038/s41560-021-00810-z>
- Woodall, C.M., McQueen, N., Pilorgé, H., Wilcox, J., 2019. Utilization of mineral carbonation products: current state and potential. *Greenh. Gases Sci. Technol.* 9, 1096–1113. <https://doi.org/10.1002/ghg.1940>
- Yang, F., Meerman, J.C., Faaij, A.P.C., 2021. Carbon capture and biomass in industry: A techno-economic analysis and comparison of negative emission options. *Renew. Sustain. Energy Rev.* 144, 111028. <https://doi.org/10.1016/j.rser.2021.111028>
- Yang, Z., Eckaus, R.S., Ellerman, A.D., Jacoby, H.D., 1996. The MIT Emissions Prediction and Policy Analysis (EPPA) Model (No. 6).
- Zang, G., Sun, P., Elgowainy, A.A., Bafana, A., Wang, M., 2021. Performance and cost analysis of liquid fuel production from H₂ and CO₂ based on the Fischer-Tropsch process. *J. CO₂ Util.* 46, 101459. <https://doi.org/10.1016/j.jcou.2021.101459>
- Zhang, H., Wang, L., Van herle, J., Maréchal, F., Desideri, U., 2019. Techno-Economic Optimization of CO₂-to-Methanol with Solid-Oxide Electrolyzer. *Energies* 12, 3742. <https://doi.org/10.3390/en12193742>

- Zhang, S., Zhuang, Y., Tao, R., Liu, L., Zhang, L., Du, J., 2020. Multi-objective optimization for the deployment of carbon capture utilization and storage supply chain considering economic and environmental performance. *J. Clean. Prod.* 270, 122481.
<https://doi.org/10.1016/j.jclepro.2020.122481>
- Zhang, Z., Pan, S.-Y., Li, H., Cai, J., Olabi, A.G., Anthony, E.J., Manovic, V., 2020. Recent advances in carbon dioxide utilization. *Renew. Sustain. Energy Rev.* 125, 109799.
<https://doi.org/10.1016/j.rser.2020.109799>
- Zhou, Y., Searle, S., Pavlenko, N., 2022. Current and future cost of e-kerosene in the United States and Europe 15.
- Zickfeld, K., Azevedo, D., Mathesius, S., Matthews, H.D., 2021. Asymmetry in the climate–carbon cycle response to positive and negative CO₂ emissions. *Nat. Clim. Change* 11, 613–617.
<https://doi.org/10.1038/s41558-021-01061-2>

RÉSUMÉ

Alors que les signes du changement climatique se montrent de plus en plus tangibles partout dans le monde, les stratégies de décarbonation et d'adaptation de nos sociétés s'invitent dans les débats. Sur le plan technologique, nous étudions ici le rôle et le potentiel de la capture et stockage et utilisation du CO₂ (CSUC) comme un levier pour réduire voire éliminer nos émissions nettes. Pour ce faire nous utilisons deux modèles prospectifs, TIAM-FR – développé par Mines Paris PSL – et EPPA – développé par le Massachusetts Institute of Technology (MIT) – comme outils pour explorer le futur et la place de la CSUC dans la décarbonation de nos sociétés. Au travers des résultats rendus par ces modèles et de notre revue de littérature, nous montrons que la CSUC est essentielle pour atteindre l'objectif fixé par l'Accord de Paris, notamment en tant que technologie pour produire des émissions négatives, permettant de compenser les émissions dites « difficiles à abattre » dans l'industrie et d'autres secteurs économiques.

MOTS CLÉS

Prospective, Macroéconomie, Capture Stockage et Utilisation du CO₂, Transition énergétique, Modélisation, Industrie

ABSTRACT

As the signs of climate change become increasingly tangible around the world, strategies for decarbonizing our societies are taking center stage. From a technological standpoint, we investigate the role and potential of CO₂ capture, storage and utilization (CCUS) as a lever for reducing or even eliminating our net emissions. To do this, we employ two models, TIAM-FR – developed by Mines Paris PSL – and EPPA – developed by the Massachusetts Institute of Technology (MIT) – as tools to explore the future and the place of CCUS in the decarbonization of our societies. Through the results generated by these models and our literature review, we show that CCUS is essential to achieving the target set by the Paris Agreement, notably as a technology for producing negative emissions, enabling to offset emissions from so-called "hard-to-abate" sectors like industry and other economic sectors.

KEYWORDS

Integrated Assessment Modelling, Macroeconomy, Energy transition, Carbon Capture Utilization and Storage, Industry