



HAL
open science

Creating markets for low-carbon hydrogen: economic perspectives on market design, regulation and international trade

Johannes Brauer

► **To cite this version:**

Johannes Brauer. Creating markets for low-carbon hydrogen : economic perspectives on market design, regulation and international trade. Economics and Finance. Université Paris sciences et lettres, 2023. English. NNT : 2023UPSLM068 . tel-04565811

HAL Id: tel-04565811

<https://pastel.hal.science/tel-04565811v1>

Submitted on 2 May 2024

HAL is a multi-disciplinary open access archive for the deposit and dissemination of scientific research documents, whether they are published or not. The documents may come from teaching and research institutions in France or abroad, or from public or private research centers.

L'archive ouverte pluridisciplinaire **HAL**, est destinée au dépôt et à la diffusion de documents scientifiques de niveau recherche, publiés ou non, émanant des établissements d'enseignement et de recherche français ou étrangers, des laboratoires publics ou privés.



THÈSE DE DOCTORAT
DE L'UNIVERSITÉ PSL

Préparée à Mines Paris

**Creating markets for low-carbon hydrogen:
economic perspectives on market design, regulation and
international trade**

**Etablissement des marchés de l'hydrogène bas-carbone:
perspectives économiques sur l'architecture de marché, la régulation et
le commerce international**

Soutenue par

Johannes BRAUER

Le 25/10/2023

École doctorale n°543

**Sciences de la Décision,
des Organisations, de la
Société et de l'Echange**

Spécialité

Économie

Composition du jury :

Anna CRETl Professeure, Paris Dauphine PSL	<i>Présidente</i>
Franziska HOLZ Professeure, Université Trondheim	<i>Rapporteuse</i>
Yannick PEREZ Professeur, Université Paris-Saclay	<i>Rapporteur</i>
Manuel VILLAVICENCIO Directeur, Deloitte France	<i>Examineur</i>
François LEVEQUE Professeur, Mines Paris PSL	<i>Directeur</i>

(Disclaimer)

L'Université Paris Sciences et Lettres (PSL), Mines ParisTech et la société Deloitte n'entendent donner aucune approbation ni improbation aux opinions émises dans cette thèse. Les propos et opinions doivent être considérées comme propres à leur auteur. Ils n'engagent en rien la responsabilité du cabinet Deloitte, ni a fortiori celle de ses clients.

Abstract

Ambitious climate goals and the paradigm change in energy trade policy caused by Russia's invasion of Ukraine call for radical changes to the current energy supply of the EU. While widespread decarbonisation is envisaged through direct electrification of end uses with renewable electricity, in 'hard-to-abate' sectors this is often not an economically viable solution. In this context, low-carbon hydrogen offers promising opportunities to complement direct electrification in the energy transition. Therefore, despite only playing a minor role in today's economy, hydrogen consumption is expected to increase significantly in the coming decades.

To meet demand, supply must ramp up quickly. The variety of production pathways and transport and storage options for hydrogen opens a wide range of supply possibilities. These offer opportunities for the economically efficient development of supply, but also pose uncertainties. In the case of a disorganised ramp-up, there is a risk of economic inefficiencies. Against this background, numerous questions arise as to how hydrogen supply can be developed in a targeted and economically efficient manner and whether the current instruments ensure an organised ramp-up. It must be ensured that failures in the ramp-up of the hydrogen economy are minimised. Policy-makers are currently creating the framework for the hydrogen economy. Given the long lifetimes of investments in hydrogen technologies, poorly designed policies can have long-lasting economic impacts and hinder the energy transition. This dissertation contributes to the existing literature and policy discourse by addressing three of these aspects. Multiple models, primarily based on linear optimisation techniques, are developed to approach the topics.

The first part adds to the discourse on a suitable definition of green hydrogen. As it is argued that the production of electrolytic hydrogen comes with a trade-off between environmental integrity and economic viability, the introduction of regulation is proposed to avoid undesirable effects. It is found that the proposed regulatory solution affects hydrogen costs, CO₂ emission and welfare. To avoid hindering decarbonisation or creating economic inefficiencies, policy-makers must therefore strike a careful balance between environmental and economic aspects when designing regulation. This entails balancing out strictness to ensure CO₂ emission abatement and flexibility to allow electrolyzers to help promote the integration of additional renewables. The requirements introduced by the European Commission in the delegated act for monthly balancing of the additional renewables installed in the same bidding zone seem to be an appropriate regulatory decision. As the trade-off is mostly dependent on the relative costs of renewable and fossil-based electricity, the need for regulatory intervention vanishes with continued declining costs for renewables, as renewable electricity is both the best economic and environmental option.

The second part contributes to the thinking on how existing power market rules fail to address grid congestion, and the extent to which electrolyzers could provide a viable solution. System-beneficial installation of electrolyzers can help to better integrate renewables and thereby reduce

grid congestion, total system costs and CO₂ emissions. The lack of locational signals to incentivise system-beneficial installation in current power markets thus calls for a revision of their design. Market-based options like local flexibility markets, dynamic grid tariffs and market splitting are not generally considered viable in the short-term for reasons such as implementation complexities. However, regulatory relaxation of current unbundling rules, which allow system operators to be involved in the placement and operation of electrolysers, offer solutions that can lead to short-term economic benefits until more advanced market-based instruments become available. The possibility of granting regulatory exemptions to system operators to unlock system flexibility of electrolysers as given by regulatory sandboxes might therefore be further assessed as they can serve as a non-wire alternative to alleviate congestion.

The third part focuses on developing appropriate EU import strategies and identifying suitable trading partners for clean hydrogen and ammonia. Russia's invasion of Ukraine has made security of supply a much higher priority, triggering a paradigm change in EU energy trade policy. New partnerships and investments in low-carbon hydrogen trade should therefore be directed towards achieving not only economic and sustainability objectives, but also ensuring secure and timely supply options. As hydrogen pipeline transport offers competitive advantages to neighbouring countries of the EU, import strategies entirely based on costs therefore pose risks of supply concentration and excessive dependencies. The findings, however, show that putting greater focus on political, economic, and social conditions of trade partners only has a moderate impact on supply costs. This supports the notion that it is worthwhile to not only look at costs when assessing potential partners. Despite recent trade or cooperation agreements being signed between widely acknowledged hydrogen actors, some of the most promising countries are not yet part of hydrogen trade negotiations. Therefore, there is still room for assessing the potential of new uncharted hydrogen trade routes across the globe.

Keywords : Renewable hydrogen, European energy transition, Sector coupling, Optimisation, Regulation, Hydrogen partnerships

Résumé

Les objectifs climatiques ambitieux de l'Union Européenne et le changement de paradigme dans la politique énergétique provoqué par l'invasion de l'Ukraine par la Russie exigent des changements radicaux de l'approvisionnement énergétique européen. Si la décarbonation de l'ensemble des secteurs économiques est envisagée grâce à l'électrification directe des utilisations finales et le déploiement d'électricité renouvelable, cette solution n'est souvent pas viable sur le plan économique dans les secteurs dits 'difficiles à décarboner'. Dans ce contexte, l'hydrogène bas-carbone offre des possibilités prometteuses pour compléter l'électrification directe. Bien que celui-ci ne joue qu'un rôle mineur dans l'approvisionnement énergétique actuel, la consommation d'hydrogène est appelée à augmenter de manière significative au cours des prochaines décennies.

Pour répondre à l'accroissement de la demande, l'offre doit augmenter rapidement. La diversité des moyens de production et des options de transport et de stockage de l'hydrogène offre de nombreuses possibilités d'approvisionnement. Celles-ci offrent ainsi l'opportunité d'un déploiement efficace de l'offre, mais présente également des incertitudes. Dans le cas d'un déploiement non coordonné de l'offre, des risques d'inefficacités économiques émergent. Afin de les limiter, plusieurs questions se posent afin de comprendre comment l'offre d'hydrogène peut se développer de manière ciblée et économiquement efficiente, notamment si les instruments actuels permettent une montée en puissance organisée. Il est primordial de minimiser les défaillances lors de cette phase d'émergence de l'économie de l'hydrogène. De fait, les décideurs politiques travaillent actuellement à la création du cadre de développement de l'économie de l'hydrogène. Étant donné la longue durée de vie des investissements dans les technologies de production d'hydrogène, un cadre réglementaire mal conçu peut avoir des conséquences économiques de long terme et ralentir la transition énergétique. Cette thèse contribue à la littérature existante en abordant trois de ces aspects. Plusieurs modèles, principalement basés sur des techniques d'optimisation linéaire, ont été développés dans le cadre de cette thèse afin d'étudier différents sujets liés au développement de l'hydrogène.

La première partie contribue à l'analyse du cadre actuellement débattue, portant sur la définition de l'hydrogène vert. Notamment, un compromis existe entre l'empreinte environnementale et la viabilité économique de la production d'hydrogène électrolytique. Ainsi, l'introduction d'une réglementation est proposée pour éviter les effets indésirables, réglementation qui influe sur les coûts de l'hydrogène, les émissions de CO₂ et le bien-être social. Pour éviter d'entraver la décarbonisation ou de créer des inefficacités économiques, les décideurs politiques doivent donc trouver un équilibre entre les aspects environnementaux et économiques lors de l'élaboration de la réglementation. Cet équilibre porte sur la rigueur à adopter permettant de garantir la réduction des émissions de CO₂ et la flexibilité pour permettre aux électrolyseurs de favoriser l'intégration d'énergies renouvelables supplémentaires. Les exigences introduites par la Commission européenne dans l'acte délégué pour l'équilibrage mensuel des énergies renouvelables supplémentaires installées dans la même zone

d'appel d'offres semblent être une décision réglementaire appropriée. Étant donné que le compromis dépend principalement des coûts relatifs de l'électricité d'origine renouvelable et de l'électricité d'origine fossile, la nécessité d'une intervention réglementaire disparaîtra au fur et à mesure de la baisse des coûts des énergies renouvelables. En effet, l'électricité d'origine renouvelable apparaît à la fois comme la meilleure option économique et la meilleure option environnementale.

La deuxième partie contribue à la réflexion sur les défaillances actuelles des marchés de l'électricité à remédier aux congestions du réseau. Or, les électrolyseurs pourraient constituer une solution viable afin de limiter celles-ci. En effet, l'installation d'électrolyseurs opérés par les gestionnaires de réseau peut contribuer à une meilleure intégration des énergies renouvelables et réduire ainsi les congestions du réseau électrique, tout en limitant les coûts totaux du système et les émissions de CO₂. L'absence de signaux locaux incitant à un déploiement prenant en compte les contraintes de réseaux dans les marchés actuels de l'électricité appelle donc à une révision de leur conception. Les approches fondées sur le marché, telles que les marchés locaux de flexibilité, les tarifs de réseau dynamiques et la scission du marché, ne sont souvent pas considérées comme viables à court terme étant donné la complexité de mise en œuvre associée. Toutefois, l'assouplissement des règles de marché actuelles afin de permettre aux gestionnaires de réseau d'être impliqués dans le placement et l'exploitation des électrolyseurs, permettrait de conduire à des avantages économiques de court terme, jusqu'à ce que des mécanismes de marché plus complet soient implémentés. Ainsi, la possibilité d'accorder des dérogations réglementaires aux gestionnaires de réseau afin de bénéficier de la flexibilité des électrolyseurs, comme le prévoient les bacs à sable réglementaires, devrait donc être évaluée. Les électrolyseurs peuvent constituer une alternative pour atténuer les congestions de réseaux.

La troisième partie se concentre sur l'élaboration de stratégies d'importation appropriées pour l'UE et sur l'identification de partenaires commerciaux adéquats pour l'importation d'hydrogène et d'ammoniac bas-carbone. L'invasion de l'Ukraine par la Russie a souligné l'importance de la sécurité d'approvisionnement européen, déclenchant un changement de paradigme dans la politique commerciale de l'UE en matière d'énergie. Les nouveaux partenariats et investissements dans le commerce de l'hydrogène à faible teneur en carbone devraient donc viser non seulement à atteindre des objectifs économiques et environnementaux, mais aussi à garantir un approvisionnement sûr et opportun. Étant donné que le transport de l'hydrogène par pipeline offre des avantages concurrentiels aux pays voisins de l'UE, les stratégies d'importation entièrement basées sur les coûts présentent des risques de concentration de l'offre et de dépendances excessives. Les résultats montrent toutefois que le fait de mettre davantage l'accent sur les conditions politiques, économiques et sociales des partenaires commerciaux n'a qu'un impact modéré sur les coûts d'approvisionnement. Cela confirme l'idée qu'il est primordial de ne pas s'intéresser uniquement aux coûts lors de l'évaluation des partenaires potentiels. Malgré la signature récente d'accords commerciaux ou de coopération entre des acteurs de l'hydrogène largement reconnus, les pays les plus prometteurs ne semblent pas s'être véritablement engagés dans la conclusion d'accords commerciaux jusqu'à présent. Par conséquent, il est important d'évaluer le potentiel des nouvelles routes commerciales de l'hydrogène à travers le monde.

Mots clés : Hydrogène renouvelable, Transition énergétique européenne, Couplage des secteurs, Optimisation, Régulation, Partenariats hydrogène

Acknowledgements

The last years have been very enriching not only in terms of research but in a much broader context.

I would like to thank my supervisor Professor François Lévêque for his trust and support. I would also like to thank Professor Franziska Holz, Professor Anna Creti and Professor Yannick Perez for accepting to be part of my jury. Thanks also go to all fellow research associates at CERN for their helpful feedback and for inspiring discussions.

Special thanks go to Manuel Villavicencio and Clément Cabot who have always motivated, pushed and challenged me. In this context, I would also like to thank Johannes Trüby for his support and the opportunity to make this experience possible. Thank you all three for the journey we have taken together. In addition, thanks go to the current and former members of Deloitte Economic Advisory, in particular the energy team and most notably: Clémence Lévêque, Marc de Froidefond and Clément Cartry. Your support has been much appreciated.

Finally, I would like to thank my family and friends for their unconditional support and patience.

Contents

Abstract	iii
Résumé	v
Acknowledgements	vii
Table of contents	viii
Glossary	xiv
1 General Introduction	1
1.1 Climate ambitions and the European energy transition	2
1.2 The role of low-carbon hydrogen	3
1.2.1 Defining renewable hydrogen	6
1.2.2 Power market design and renewable hydrogen production	7
1.2.3 Low-carbon hydrogen imports	9
1.3 Organisation of the thesis	12
1.4 Methodological considerations	13
1.4.1 Modelling approach	13
1.4.2 Accuracy, assumptions, caveats and limitations	14
2 Green hydrogen – How grey can it be?	15
2.1 Introduction	18
2.2 Background and literature review	19
2.3 Methodology	23
2.4 Scenario setup and data	25
2.4.1 Analysed regulation designs	26
2.4.2 Representation of the power sector	26
2.4.3 Representation of the hydrogen supply	27
2.5 Results	29
2.5.1 Effect of regulation on hydrogen production costs	29
2.5.2 Effect of regulation on social welfare	31
2.5.3 Effect of regulation on CO ₂ emissions	34
2.5.4 Trade-off between environmental integrity and economic viability	36
2.5.5 Trade-off in an advanced energy transition	37
2.6 Discussion	38
2.7 Conclusion	40

3	Empowering system operators in the production of electrolytic hydrogen	43
3.1	Introduction and motivation	46
3.2	Background and literature review	47
3.3	Methodology and modelling framework	50
3.3.1	The electricity market model	53
3.3.2	The congestion management model	53
3.3.3	The hydrogen supply chain model	54
3.4	Scenario setup and data	55
3.4.1	Data on the electricity system	55
3.4.2	Data on the hydrogen system	56
3.5	Results	58
3.5.1	Base case - initial scenario without production of electrolytic hydrogen	58
3.5.2	Results of an optimal system-based placement of electrolyser capacities	60
3.5.3	Effects of production of electrolytic hydrogen on the power system	60
3.5.4	Effects of the spatial distribution of hydrogen supply	61
3.5.5	Hydrogen supply cost structure	62
3.5.6	Results on total system costs	64
3.5.7	Sensitivity analysis	65
3.6	Discussion	66
3.7	Conclusion	70
4	Low-carbon hydrogen trade relations	72
4.1	Introduction	75
4.2	Context and literature review	76
4.3	Methodology and data	81
4.3.1	Country exclusion filter	81
4.3.2	Detailed supply cost analysis	82
4.3.3	Multi-criteria analysis	87
4.4	Results	88
4.4.1	Prefiltering of countries	89
4.4.2	Detailed supply chain analysis	89
4.4.3	Multi-criteria analysis	90
4.4.4	Combined assessment of cost-based and non-cost-based parameters	91
4.4.5	Estimation of reliability premium	94
4.5	Discussion	98
4.6	Conclusion	101
5	Conclusion and perspectives	103
A	Supplementary data for Chapter 2	110
B	Supplementary data for Chapter 3	128
C	Supplementary data for Chapter 4	150
	Bibliography	198

List of figures

1.1	Announcements of hydrogen strategies/roadmaps in the EU	4
1.2	Projections of hydrogen demand in the EU until 2050	4
2.1	Regulatory dimensions	22
2.2	Overview about methodology	23
2.3	Scheme of hydrogen supply structure	24
2.4	Considered geographical setup	28
2.5	Effect of regulation on hydrogen production costs	30
2.6	Effect of regulation on total welfare	31
2.7	Effect of regulation on electricity prices	32
2.8	Effect of regulation on the interaction between hydrogen and the power sector	32
2.9	Effect of regulation on power generation	33
2.10	Effects of regulation on producer rents	34
2.11	Effect of regulation on CO ₂ emission at the system level	35
2.12	Effect of regulation on the CO ₂ intensity of the produced hydrogen	36
2.13	Pareto frontier between changes in welfare and changes in CO ₂ emissions	36
2.14	Pareto frontier - Comparison of base case against advanced energy transition	37
3.1	Scheme of the applied methodology	52
3.2	Scheme of hydrogen supply chain model	54
3.3	Illustration of spatially resolved power system data	56
3.4	Hydrogen demand and hydrogen network topology	58
3.5	Occurance of curtailments in the base case scenario	59
3.6	Electricity prices, occurrence of curtailments, and the share of variable renewables	59
3.7	System-based positions of electrolyzers	60
3.8	Effects of hydrogen production on power sector	61
3.9	Hydrogen supply structure	62
3.10	Hydrogen supply cost breakdown	63
3.11	Absolute effects of regulatory relaxations on system costs and CO ₂ emissions	64
3.12	Sensitivity analysis	66
4.1	Evolution of energy supply in the EU	77
4.2	Overview of methodology	81
4.3	Overview of supply hydrogen options	83
4.4	Map production locations and export points	85
4.5	Illustration of pre-filtered countries	89
4.6	Maps of the supply costs for gaseous hydrogen and ammonia in 2030 and 2050	90
4.7	Analysis of exporters' soft factors	91

4.8	Combined analysis of cost-based and non-cost based parameters for gaseous hydrogen	92
4.9	Combined analysis of cost-based and non-cost based parameters for ammonia	93
4.10	Analysis of cost-optimised vs. soft-factor-optimised supply of gaseous hydrogen . . .	95
4.11	Reliability premiums for supply of gaseous hydrogen	95
4.12	Soft factor analysis for supply of gaseous hydrogen	96
4.13	Analysis of cost-optimised vs. soft-factor-optimised supply of ammonia	97
4.14	Reliability premiums for supply of ammonia	97
4.15	Soft-factor analysis for supply of ammonia	98
A.1	Base case - sensitivity analysis of key input parameter	111
A.2	Pareto frontier including offshore wind sensitivity	112
A.3	Spatial relaxation allowing installations of renewables in other bidding zones	112
A.4	Advanced energy transition - Effects on hydrogen supply costs - LCOH	113
A.5	Advanced energy transition – Effect on hydrogen and the power sector	113
A.6	Advance energy transition – Effects of regulation on welfare	114
A.7	Advance energy transition – Effects of regulation on CO ₂ emissions	114
B.1	Allocation of electrolyser capacity by TSOs for various considered capacities	129
B.2	Hydrogen supply structure for various system-based electrolyser capacities	130
B.3	Evolution of LCOH with respect to the number of operating hours	148
C.1	Sensitivity analysis – green hydrogen - part I	153
C.2	Sensitivity analysis – green hydrogen - part II	154
C.3	Sensitivity analysis – green hydrogen - part III	155
C.4	Sensitivity analysis – green hydrogen - part IV	156
C.5	Sensitivity analysis – blue hydrogen	156
C.6	Sensitivity analysis: 3.5 times renewable potential - hydrogen supply	157
C.7	Sensitivity analysis: 3.5 times renewable potential - ammonia supply	157
C.8	Sensitivity analysis: 5 times renewable potential - hydrogen supply	158
C.9	Sensitivity analysis: 5 times renewable potential - ammonia supply	158
C.10	Cost-optimised vs. soft-factor-optimised supply of gaseous hydrogen (green only) . .	159
C.11	Reliability premiums for supply of gaseous hydrogen (green only)	159
C.12	Soft-factor analysis for supply of gaseous hydrogen (green only)	159
C.13	Cost-optimised vs. soft-factor-optimised supply of ammonia (green only)	160
C.14	Reliability premiums for supply of ammonia (green only)	160
C.15	Soft-factor analysis for supply of ammonia (green only)	160
C.16	Illustration of volume flows along supply chains	163
C.17	Scheme – green hydrogen production at location l in country c	167
C.18	Scheme - blue hydrogen production at location l in country c	168
C.19	Scheme – green electricity generation at location l in country c	170
C.20	Scheme - blue electricity generation at location l in country c	172
C.21	Scheme - international pipeline transport	173
C.22	Scheme - international NH ₃ transport	174
C.23	Scheme - international LH ₂ transport	174
C.24	Scheme - international LOHC transport	175
C.25	Considered power curves of wind turbines	182
C.26	Considered evolution of capacity factors due to technological developments	183
C.27	Benchmark of installation costs of renewables	185
C.28	Overview of the pipeline network in and around the EU incl. relevant nodes	187

List of Tables

2.1	Overview about analysed regulation	26
3.1	Overview of the considered electrolyser placement and operation options	51
4.1	Distribution of hydrogen import volumes	84
A.1	Nomenclature – optimisation model	115
A.2	General assumptions	122
A.3	Considered capacity floors, targets, and caps	122
A.4	Electricity demand	123
A.5	Considered cost parameters	124
A.6	Considered cost parameter – renewables and batteries	124
A.7	Considered technical parameters	124
A.8	Considered technical parameter of electrical storage units	125
A.9	Considered fuel emissions	125
A.10	Considered fuel and CO ₂ prices	125
A.11	Considered capacity credits	125
A.12	Minimum share of renewable energies in national electricity demand	126
A.13	Considered hydrogen demand	126
A.14	Considered parameters of hydrogen storage technologies	127
A.15	Considered parameters of hydrogen conversion and reconversion technologies	127
A.16	Considered parameters of electrolyser technologies	127
B.1	Variation of affected electrolyser capacity in base case	129
B.2	Variation of affected electrolyser capacity in sensitivity 1	131
B.3	Variation of affected electrolyser capacity in sensitivity 2	131
B.4	Variation of affected electrolyser capacity in sensitivity 3	131
B.5	Variation of affected electrolyser capacity in sensitivity 4	131
B.6	Variation of affected electrolyser capacity in an alternative scenario	132
B.7	Nomenclature of electricity market and congestion management model	133
B.8	Nomenclature of hydrogen supply chain model	137
B.9	Nomenclature of optimal electrolyser placement	138
B.10	Nomenclature of optimisation for electrolyser operation	139
B.11	Power line parameters	141
B.12	Key figures of the resulting power system	141
B.13	Annual electricity demand at national level in 2030	142
B.14	Installed capacity at national level	143
B.15	CO ₂ emission factor by fuel	143

B.16	Variable operating costs by technology and fuel	144
B.17	Fuel prices and CO ₂ prices	145
B.18	Resulting hydrogen conversion costs	145
B.19	Cost assumptions conversion	146
B.20	Considered hydrogen transport costs	147
B.21	Cost assumptions road transport	147
B.22	Techno-economic assumptions for grey and blue hydrogen	149
C.1	Country abbreviations according to the ISO 3166-1 standard	151
C.2	Prefiltered potential green hydrogen exporter	151
C.3	Prefiltered potential blue and green hydrogen exporter	151
C.4	Overview about assessed cases – Competitiveness-Index	152
C.5	Overview about assessed cases – Soft-Factor-Index	152
C.6	Nomenclature – Supply chain optimisation	162
C.7	Nomenclature - LCOH calculation	166
C.8	Nomenclature - LCOE calculation	170
C.9	General input data	175
C.10	Considered exchange rates	175
C.11	Considered inflation	175
C.12	Considered CO ₂ price projection	175
C.13	Considered electricity prices in the EU	175
C.14	Country risk	177
C.15	Land exclusion criteria for the production of hydrogen	179
C.16	Learning rates of renewable energies	184
C.17	Considered capacity evolution of variable renewables	184
C.18	Techno-economic parameters – electrolyser systems	185
C.19	Techno-economic parameters – renewable energies	185
C.20	Techno-economic parameters – battery systems	186
C.21	Techno-economic parameters – steam methane reforming incl. CCS	186
C.22	Natural gas - break-even costs	186
C.23	Techno-economic parameters – combined-cycle gas turbine incl. CCS	186
C.24	Considered CO ₂ transport and storage costs	187
C.25	Nomenclature – data processing	190
C.26	Techno-economic parameters – pipelines	191
C.27	Techno-economic parameters – compressor stations	191
C.28	Techno-economic parameters – shipping	193
C.29	Techno-economic parameters – conversion	194
C.30	Techno-economic parameters – terminal	195
C.31	Overview of weighting within multi-criteria assessment	197
C.32	Overview of criteria assessed within multi-criteria assessment	197

Glossary

CAPEX	Capital Expenditure
CCGT	Combined-Cycle Natural Gas Turbine
CCS	Carbon Capture and Storage
CHP	Combined Heat and Power
GDP	Growth Domestic Product
HHI	Herfindahl-Hirschman Index
HVDC	High Voltage Direct Current Lines
LCOE	Levelized Costs of Electricity
LCOH	Levelized Costs of Hydrogen
LNG	Liquid Natural Gas
MCDA	Multi-Criteria Decision Analysis
MTPA	Million Tonnes per Annum
NH₃	Ammonia
NTC	Net Transfer Capacities
O&M	Operations and Maintenance
OPEX	Operational Expenditure
RES	Renewable Energy Technologies
SMR	Steam Methane Reforming
TSO	Transmission System Operators
WACC	Weighed Average Cost of Capital
WSM	Weighed Sum Methods

Chapter 1

General Introduction

1.1 Climate ambitions and the European energy transition

One of the greatest challenges facing humanity in the 21st century is the need to mitigate global warming (IPCC 2023). With the Paris Agreement¹, the global community has made a landmark commitment in the fight against anthropogenic greenhouse gas emissions. The legally binding agreement of 196 countries, reached at the COP 2015 in Paris, sets the common goal to limit global warming to well below 2 degrees Celsius above pre-industrial levels, with efforts to keep the temperature rise to 1.5 degrees Celsius. In response to this commitment, the European Union has therefore set the target of being climate neutral by 2050. With the European Climate Law (EC 2021), this ambitious goal was legally implemented. The law is accompanied by numerous policy packages with the European Green Deal (EC 2019) being one of the most prominent examples. It creates the framework for a comprehensive roadmap which addresses a wide range of sectors in the economy, including energy, transport, agriculture, building, and more. By introducing these new policies, the European Union aims to lead the way in the fight against climate change and make Europe the world's first carbon-neutral continent.

The energy sector is the main contributor to CO₂ emission in the EU, accounting for approximately two-thirds of total CO₂ emissions (EEA 2023). Its decarbonisation is therefore a key element in achieving climate goals. It is not, however, the only factor to be addressed by energy policy objectives. In addition to considerations of sustainability, aspects of affordability and security of supply are crucial in ensuring competitiveness and maintaining a high quality of life. The interplay of these elements is often referred to as the energy trilemma, with the influence of one parameter having implications on the others and often leading to trade-offs. While affordability aspects have long been the focus of EU energy policy, attention is now shifting. In addition to increased sustainability ambitions, Russia's invasion of Ukraine and the subsequent energy crisis in Europe, which resulted in substantial economic damages to the European economy, have given security of supply aspects higher priority. Since the overarching goal is to ensure affordability as well as security and sustainability of energy supply, the weighting of the three aspects in current energy policies is therefore being readjusted as outlined by the REPowerEU policy package (EC 2022).

Over the past two decades renewables have experienced considerable growth in capacity and demonstrated their ability to contribute to decarbonisation. From 2004 to 2021, their share in final EU energy consumption more than doubled, exceeding 20% in 2021 (Eurostat 2023). Due to the sharp increase in global capacity, learning and scaling effects have led to significant cost reductions of the technologies. While costs for wind energy declined by 35% between 2010 and 2021, solar PV saw even higher drops amounting to 80% (IRENA 2021). The decreasing trends are expected to continue in the decades to come. The technologies not only contribute to decarbonisation, but also enable the use of local natural resources and thus reduce dependence on energy imports. In light of this potential, the substantial expansion of renewables such as solar PV and wind power is considered as the backbone of the future energy supply in the EU (EC 2019).

Historically, the various sectors of energy supply were largely treated separately from each other. While liquid fuels derived from the petroleum industry were predominantly used in transport, heating

¹ United Nations Paris Agreement; <https://www.un.org/en/climatechange/paris-agreement>

demand was met by natural gas and fuel oil. Electrical appliances, in contrast, relied on the power system. Each of the areas has its own infrastructure and interactions between them are limited. A holistic view of the sectors can, however, strengthen the use of synergies leading to gains in efficiency. Their joint consideration is often referred to as sector coupling, which describes the linking of sectors through technologies that enable cross-sectoral integration (Robinius et al. 2017; T. Brown et al. 2018; Gea-Bermúdez et al. 2021).

Technologies such as electric motors in mobility and heat pumps in heating require electricity and therefore enable coupling with the power sector. In addition to the direct use of electricity from renewables, which can replace fossil fuels, electrification of end uses often comes with additional benefits, such as higher overall technical efficiency or operational flexibility. The latter is particularly relevant as it allows for the better following of generation patterns of renewables which are driven by the variability of natural resources (Ruhnau, Bannik, et al. 2019; Ruhnau, Hirth, and Praktijn 2020; Thomaßen, Kavvadias, and Jiménez Navarro 2021). The possibilities offered by sector coupling through electrification therefore opens new opportunities for using resources more efficiently and thus contributing to the EU’s energy policy goals. Given its potential in decarbonisation, the widespread electrification of end uses is being considered as another pillar in the European energy transition (EC 2019).

Electrification, however, is not a silver bullet solution, as for some sectors of the economy, direct electrification is not economically viable. These sectors, often referred to as ‘hard-to-abate’ sectors, require alternative approaches to reduce CO₂ emissions. In this context, low-carbon hydrogen is seen as a promising solution. The physical and chemical properties of hydrogen, as an energy carrier, offer opportunities where direct electrification reaches its techno-economic limits. It thus complements electrification in the decarbonisation process (Staffell, Scamman, et al. 2019; Parra et al. 2019).

1.2 The role of low-carbon hydrogen

Hydrogen is, like fossil fuels, a chemical energy carrier. Compared to electricity, its chemical nature offers several advantages, particularly regarding the storability of large amounts of energy over long periods as well as its transport possibilities. Moreover, hydrogen is versatile as it can serve a wide range of applications. Besides its potential use as an energy carrier, it can also serve as a feedstock, which is predominantly the case today. While gaseous hydrogen is needed in some applications, hydrogen derivatives are used in others. In these cases, hydrogen forms the basis for chemical compounds with other elements. Common hydrogen derivatives today are ammonia (NH₃) and methanol (CH₃OH). There are, however, other possible combinations, such as synthetic fuels, which can contribute to the decarbonisation of sectors such as aviation (IEA 2019c; Abdin et al. 2020).

In the past few decades, hydrogen has repeatedly been discussed as a potential key player in energy supply. None of this conjecture has led to its breakthrough as a significant energy carrier (Rosen and Koochi-Fayegh 2016). The urgency of the transformation to a carbon neutral future and the versatility of its potential contributions now suggest that its emergence as a significant part of the energy landscape is imminent. Global interest in hydrogen has increased significantly in recent years underlined by numerous announcements of countries around the world on how hydrogen

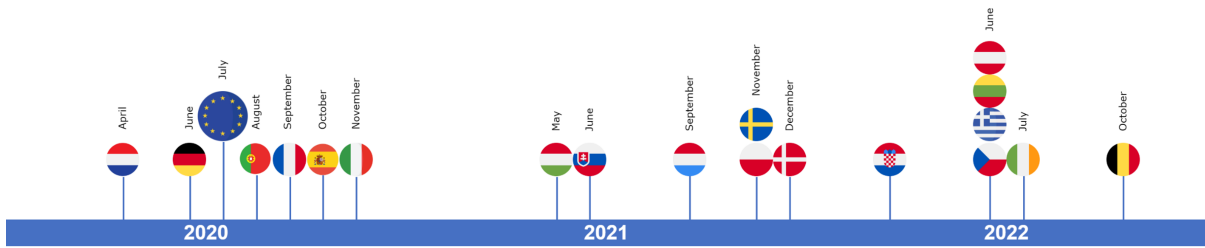

Source: Own illustration based on Tarvydas (2022)

Figure 1.1: Announcements of hydrogen strategies/roadmaps in the EU

will contribute to their energy transitions. Given the compatibility of low-carbon hydrogen with European climate targets and energy policies, it is also considered a promising candidate in the European energy transition. With the release of the European hydrogen strategy in 2020 (EC 2020), that sets out a comprehensive roadmap of a hydrogen economy, it has been assigned a pivotal role in decarbonising the EU. Its importance in the transition is further underscored by the release of national hydrogen strategies and roadmaps of numerous EU member states (Figure 1.1), that further refine the European hydrogen vision at national levels. Activities in the hydrogen sector have increased significantly since then, which is also underscored by the number of studies conducted with the intention to provide a better understanding of the possibilities and potential role of hydrogen in the energy transition (Guidehouse 2021; Deloitte 2021; Nuñez-Jimenez and Blasio 2022).

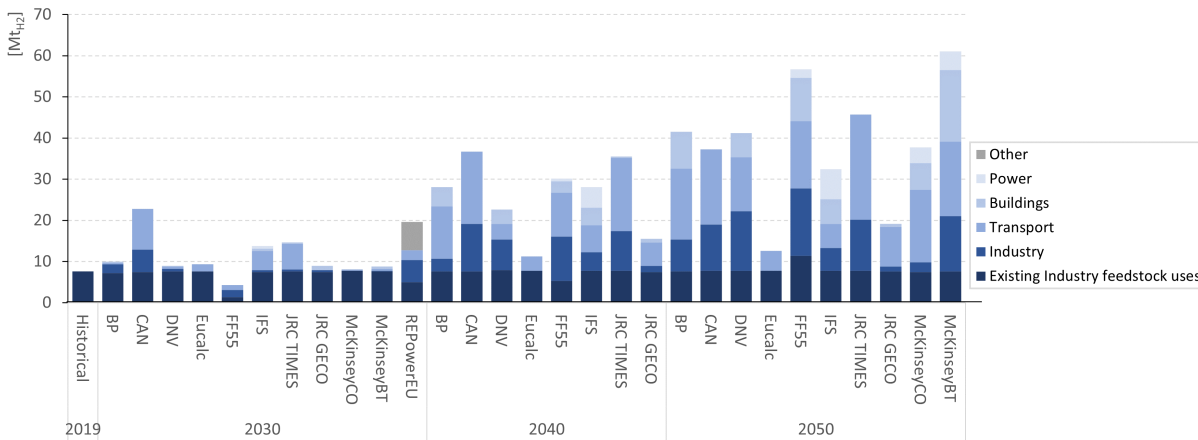

Source: (Tarvydas 2022)

Figure 1.2: Projections of hydrogen demand in the EU until 2050

While there are differences in projections on how much low-carbon hydrogen is needed, when and in which areas of the economy, there is little doubt that its use and thus its demand will increase substantially (Figure 1.2). While the share of hydrogen in total energy demand is almost negligible today, it is projected to increase steadily over the coming decades. In some scenarios, such as the Fitfor55 of the European Commission, hydrogen and derived fuels could cover more than 20% of total final energy demand in the EU in 2050 (Tarvydas 2022). This magnitude underlines once more the considerable significance of it in the European energy transition. Its rapid uptake is therefore expected in the coming years. The European Commission projects hydrogen demand to more than

double by 2030 from today's 10 MTPA. Apart from the substitution of existing grey hydrogen² as a feedstock in industry, growing demand is seen in other industrial applications as well the transport. In the mid-term, its usages in the power system and buildings might follow. The expected increase in demand requires massive efforts, including multi-billion-euro investments, that have to be raised collectively.

To meet rising demand, a corresponding hydrogen supply structure must be created. Unlike fossil fuels, pure hydrogen hardly exists in nature and must therefore be produced. Various technology routes are available for producing hydrogen from either water, hydrocarbons or biomass. These pathways, however, are associated with different levels of CO₂ emissions (IEA 2019c). As one of the key requirements for the use of hydrogen in future energy systems is its contribution to climate goals, the set of available hydrogen production technologies is therefore limited. Two technology routes, however, are considered promising in meeting the requirements (Noussan et al. 2020; Lagioia, Spinelli, and Amicarelli 2023):

- Blue hydrogen: produced from natural gas through the steam reforming process (SMR), which is complemented by carbon capture and storage (CCS) technologies. While SMR presents today's predominant production route, and is associated with significant CO₂ emissions, the addition of CCS enables the capture of 70-90%³ of these, preventing their release into the atmosphere. The captured CO₂ is subsequently stored underground in geological formations or used as feedstock. (IEA 2019c; IEA 2020)
- Electrolytic hydrogen: produced through electrolysis where water is split into its constituents hydrogen and oxygen by using electricity. While this technology route has so far only been used in some niche applications, current market trends suggest significant improvements in its economics, opening new possibilities for widespread deployment. The rapidly falling costs of renewables are key drivers in this regard, as access to low-cost electricity plays a crucial role in determining the competitiveness of electrolytic hydrogen production (Abdin et al. 2020). The ability to feed the hydrogen production process with renewable electricity also allows the use of domestic natural resources, thereby contributing to energy policy objectives of reducing imports and enhancing local energy supply (IRENA 2022b).

The different production paths, supplemented by the variety of transport and storage options, open a wide range of supply possibilities. These offer opportunities for an economically viable supply of low-carbon hydrogen, but can also result in inefficiencies if ill-conceived and inadequately implemented. There are significant uncertainties in the ramp-up of the hydrogen economy. In particular, the need for rapid development can lead to a disorganised ramp-up, which can bring economic failures. These should be limited. In this context, numerous questions arise as to how an economically efficient supply of low-carbon hydrogen should be developed. Three of these aspects are presented below.

² Hydrogen produced from fossil fuels mostly natural gas in steam methane reforming (SMR)

³ Ensuring the climate friendliness of the technology also requires the reduction of methane emissions along the supply chains of natural gas. In this respect, there are considerable differences in the natural gas producing countries. In many cases, methane emissions can, however, be significantly reduced through cost-effective measures.

1.2.1 Defining renewable hydrogen

Electrolytic hydrogen is expected to play an important part in tackling climate change around the world. Despite years of experience in electrolysis, the technology has not yet been used at scale, mainly due to its unfavourable competitiveness compared with other production technologies (IEA 2019c). The European Union has set the target of installing at least 40 GW of electrolyser capacity in the EU by 2030 (EC 2020). Since there are only a few installations in operation to date, summing to a total of 250 MW (EC 2023b)⁴, a considerable expansion of the technology is needed, requiring billions of euros in investment and offering both challenges and opportunities to the industry.

The electricity used in the electrolysis process can come from various sources, which is characterised by different CO₂ intensities. While electricity from both renewables and nuclear power is CO₂-free, electricity generation from fossil fuels is associated with much higher CO₂ emissions. In addition to the environmental aspects, generation costs as well as availabilities differ among the various generation types. While thermal power plants are dispatchable and can be operated at high load factors, renewables are dependent on the availability of natural resources, which limits their operating times (El-Emam and Özcan 2019).

The use of electrolytic hydrogen for decarbonisation suggests the sourced electricity is to come from CO₂-free power generation. While nuclear power generation faces an uncertain future, countries around the world including the EU member states have clear ambitions to substantially expand renewables. Their strict coupling with electrolysers ensures hydrogen production being CO₂-free and thus contributing to decarbonisation. The competitiveness of electrolytic hydrogen can be negatively affected by the cost of electricity generation and low capacity factors of renewables. To compensate for the lower availabilities of renewables, generation capacities need to be oversized to achieve reasonable full load hours of the electrolyser, increasing hydrogen production costs. The hydrogen industry therefore argues that a strict coupling of renewables and hydrogen production counteracts the rapid development of the hydrogen market, thereby slowing down the energy transition. Alternatively, it is claimed that the flexible operation of electrolysers within electricity markets improves its competitiveness, promoting a more effective market uptake (Frontier-Economics 2021). In addition to reduced hydrogen production costs, the possibility of reacting to market signals can also provide system flexibility, improving the integration of additional renewables into the system. Such operational flexibility, however, bears the risk that electrolytic hydrogen production could also source grey grid electricity, which causes CO₂ emissions to increase (Hurtubia and Sauma 2021).

The outlined conditions indicate that electrolytic hydrogen production comes with a trade-off between environmental integrity and economic viability. Renewable hydrogen has often been used in the literature as a synonym for electrolytic hydrogen, without considering the associated CO₂ emissions. The recognition of electrolytic hydrogen as a homogeneous good is not appropriate in this respect. Instead, designating renewable hydrogen requires a clear definition, which suggests the introduction of regulation to achieve the desired effects.

Without clarity on what constitutes renewable hydrogen, there is also no planning certainty for investors, which holds back investment decisions and hinders the ramp-up of the technologies

⁴ 160 MW output capacity with an assumed efficiency of 65%

(Velazquez Abad and Dodds 2020). Politicians around the world are therefore currently in the process of defining corresponding requirements. Various possible regulatory options are discussed in this context mainly centering around three aspects (EC 2023a):

1. Origin of electricity: describes the type of electricity allowed in electrolytic hydrogen production e.g., sourced from renewables that represent capacity additions to the existing system.
2. Temporal correlation: refers to the coupling in time of electricity generation from renewables and hydrogen production e.g., renewable electricity generation must match electricity sourcing in hydrogen production on an hourly level over a year.
3. Spatial correlation: expresses the spatial relationship between renewables and hydrogen production e.g., renewables have to be located at the same location or somewhere in the same bidding zone as the electrolysers.

With the Delegated Act released in February 2023 (EC 2023b), the EU has already set the requirements for hydrogen to be considered renewable. The drafting of the regulation, however, was a long-lasting process that required several attempts. The divergent interests among member states and industries, along with the complexities arising from the diverse power systems across the member states, hindered the rapid development of the regulation. With its release, the EU's definition of renewable hydrogen is the first of its type internationally. Other countries are about to follow with the US being a prominent example. The ongoing debate in the US follows similar reasonings to that observed in the EU⁵. Given the vast size of the market, regulation is expected to have a significant economic impact in the trade-off between environmental integrity and economic viability.

The production of electrolytic hydrogen is considered a key element in carbon neutral energy supply by many countries. To achieve an efficient ramp-up of the technologies that takes into account both decarbonisation goals and the economic viability of the production paths, target-oriented regulation is needed. This could impact not only hydrogen production but also the broader system, potentially affecting the progress of the energy transition. As these effects are not yet sufficiently understood, further research in this area is suggested (Ruhnau and Schiele 2022; Schlund and Theile 2022).

1.2.2 Power market design and renewable hydrogen production

In most European countries, electricity markets are organised in such a way that there is only one bidding zone. From a market perspective, no distinction is therefore made in terms of the location of producers and consumers within the zone. It is rather assumed that electricity flows unconstrained from the generation to the demand sites, as if on a copper plate. Corresponding redispatch measures follow the clearing of wholesale markets in the case that technical limits in the system are reached. This market design gives electricity producers the freedom to choose the locations of their generators in such a way that they can be operated efficiently. Corresponding adaptations in the grid

⁵<https://www.hydrogeninsight.com/policy/us-green-hydrogen-definition-annual-rather-than-hourly-matching-could-cut-h2-costs-by-up-to-175-and-still-be-net-zero/2-1-1417840v>

structure should ensure that adequate transmission capacities are available to integrate new power generation. This market scheme has proven successful in the past with one reason being the high market liquidity contributing to economic efficiencies (A. Eicke and Schittekatte 2022), and another the well-interconnected network in Europe.

During the pre-liberalisation era of the electricity sector, when supply was organised in vertically integrated structures, the expansion of generation capacities was efficiently synchronised with the expansion of the grid. The placement of power plants was based on factors such as access to cooling facilities, fuel reserves and waste heat utilisation, such that they were seamlessly integrated into the network. Today's generation fleet largely consists of plants from that time. As the siting of new thermal power plants still follows similar criteria, they are often constructed at the same locations. The electricity grid in these areas is therefore generally well-developed, and as such does not often require additional reinforcement measures for the integration of new power plants.

The expansion of renewables, however, is now introducing new challenges to the old setup. Not only does the siting of renewables follow different criteria compared to that of thermal power plants, but generation is also much more distributed (Schroeder et al. 2013; Ardian, Concettini, and Creti 2018). The changing geographical location of power generation has impacts on the power flows in the system. Due to considerable planning and administrative efforts, corresponding adaptations of the grid configuration can, however, only slowly follow the rapid expansion of renewables. As the networks may not be adapted to handle the new flows in a timely manner, the resulting geographical distortions can pose new operational challenges for power systems. In some cases, this phenomenon can already be observed (Yasuda et al. 2022; IEA 2023).

A prominent example in this context is the case of Germany. Historically, sufficient transmission capacity has been put in place to transfer electricity from the main generation locations in the east, west and centre of the country to the corresponding demand sites. The distribution of natural resources, however, is now changing the locational setup of the system. As the best wind sites are located in the north of the country, on the coasts of the North Sea and the Baltic Sea, there has been a massive expansion of wind energy in these regions over the past two decades. Lack of acceptance as well as significant administrative hurdles have led to considerable delays in the planned grid expansion. As such the capacity of the transmission network between the northern regions and the rest of the grid is not yet sufficient, which has increasingly led to grid congestion. To prevent damages due to the overloading of system components, power generation of wind turbines in the north has to be curtailed more frequently as part of redispatch measures. To ensure sufficient power supply behind the congested lines, fossil fuel generation in the south of Germany has had to be ramped up accordingly. This has not only led to additional CO₂ emissions, but also to considerable costs for the compensation of the unused wind power. Within just a few years, compensation climbed from close to zero to over EUR 1 billion in 2019 (BNetzA 2021).

Sector coupling and the expansion of electrification present opportunities to mitigate these effects. By creating additional demand at affected locations in the power grid, the technologies can help to relieve congestion in the system (Ardian, Concettini, and Creti 2018). The production of electrolytic hydrogen can play an important role in this context. Due to the transportability of hydrogen, its production is not limited to the location of demand. Instead, hydrogen production can be located at

sites that alleviate the stress on the power system, while the produced quantities are subsequently transported to the corresponding demand locations via alternative transport routes. By contrast, in other cases of sector coupling such as electric mobility and electric heating, the supply of electricity is restricted to the specific location of demand (Robinius et al. 2017; Parra et al. 2019).

Moreover, the potential for spatial decoupling in electrolytic hydrogen production can facilitate the utilisation of synergies through improved integration of existing infrastructure within the broader energy system. One example is the repurposing of natural gas pipelines. Due to the declining importance of natural gas for final energy supply, the utilisation of the natural gas grid is expected to decrease with the risk of becoming stranded (Cerniauskas et al. 2020). Hydrogen transport needs resulting from the spatial decoupling of hydrogen production can, however, lend these capacities new purposes and avoid their costly underutilization. At the same time, the capability of transporting hydrogen by pipelines reduces the need for new power lines causing a more efficient infrastructure utilisation due to cross sectoral synergies (Bødal et al. 2020; Neumann et al. 2023). Retrofitting the infrastructure, however, requires framework conditions from the national regulatory authorities (DNV GL 2022).

Electrolysers can effectively tackle the challenges of integrating renewables by providing operational flexibility, addressing not only temporal but also spatial issues. This highlights the versatile potential of electrolysers as a sector coupling technology and underlines their significant systemic relevance. The full potential in terms of spatial aspects can, however, only be unleashed when their installations are aligned with the grid infrastructure considerations. Placing these technologies instead in other areas of the network may even amplify congestions.

Due to the predominant role of uniform pricing in European power markets, locational signals to support the installation of new technologies in a system-friendly way are often absent suggesting the need for revisions of the current market designs to incorporate such mechanisms. In this context, several options have been proposed including local flexibility markets, dynamic network tariffs, and market zone splitting. All of these options, however, come with advantages and disadvantages, none being considered a silver bullet (Vogel and Bauknecht 2020). While the technical possibilities of electrolysers as sector coupling technologies are already well understood, aspects linked to possible adaptation of current market designs have been insufficiently addressed so far (Xiong et al. 2021; vom Scheidt et al. 2022).

1.2.3 Low-carbon hydrogen imports

For reasons such as limited low-cost resources, competition between different land uses, and rising acceptance concerns that might hinder a sufficient exploitation of domestic renewables (‘Not in my backyard’ effect), it remains unclear to what extent the EU can meet its demand with domestic resources in an economic manner (Guidehouse 2021). The transport properties of hydrogen and its derivatives, however, make it possible to benefit from the inexhaustible global energy potential through imports from other regions. While trade offers possibilities to supplement European domestic production, it also enables the economic optimisation of the energy supply. This applies in particular to imports of renewable hydrogen, which facilitates the benefits of not only the abundant

global resources, but also from the best ones (IRENA 2022b).

Like the era of fossil fuels, the differences in the distribution of global resources are expected to drive global trade in low-carbon energy. Unlike the fossil fuel in the past, however, resources are now distributed differently, with potential effects on the roles of different actors. Former net importers could become exporters and vice versa (Scholten, Bazilian, et al. 2020; Van de Graaf 2019). In this context, the outstanding natural potential of the Global South could be a game changer in global energy trade patterns. The new potential importance of these countries could act as a catalyst for their economic development (IEA 2022a; Goldthau, L. Eicke, and Weko 2020).

As there are no trade structures for low-carbon hydrogen to date, these must be developed. Bilateral agreements are expected to initiate global trade of low-carbon energy. Subsidised by public money, they ensure the coverage of capital-intensive upfront investments giving investors security to overcome the missing economic viability of the technologies. With their improving economics, increasing trade volumes and greater liquidity in the sector, bilateral trade could then gradually evolve into international markets (Deloitte 2023).

The global race for the best resources has recently begun. Many countries around the world, including EU member states, are in the process of establishing partnerships to position themselves at this early stage. Numerous memoranda of understanding have been signed with potential exporters to the EU in recent months to build the basis for bilateral trade relations. The list of countries is long including neighbouring countries such as Egypt, Morocco and Ukraine as well as more distant ones such as Canada, Chile, Saudi Arabia and South Africa.

In addition to the establishment of partnerships, the first instruments have already been introduced to promote the development of concrete projects. One of the most prominent examples in this regard is H2Globa⁶. Initiated by the German Federal Government, the foundation aims to promote trade in low-carbon hydrogen by providing secure funding for specific projects under bilateral agreements. A competitive tendering process designed as a double auction procedure brings together hydrogen suppliers and consumers. Both sides enter their bids into the tendering process. The most competitive offers from each side within the tendered volumes are awarded. Public subsidies are used to close the financial gap between the costs of the offered volumes and the willingness-to-pay for the demanded ones. This approach ensures investment certainty for both consumers and producers and thereby stimulates trade activities.

The first concrete projects are already in the planning stage. A pioneering undertaking is the large-scale green hydrogen project planned by Hyphen in the Tsau-Khaeb National Park on the Namibian coast⁷. The first phase of the project, consists of electrolyzers with a capacity of 3 GW that will be fed by a total of 7 GW of wind and PV plants, is planned to be fully operational by 2026. The investment volume of approximately EUR 10 billion underscores the magnitude of this project, which is planned to be progressively expanded in the coming years. During the construction phase, around 15000 workers will be required, with the vast majority being filled by local workers. Once the plant becomes operational, it then creates about 3000 permanent jobs. This project gives Namibia's economy a significant boost and help the country position itself in the landscape of the

⁶ <https://www.h2-global.de/>

⁷ <https://hyphenafrika.com/projects/>

emerging international trade of low-carbon energy.

In recent decades, there has been a growing emphasis on cost considerations in the European energy supply, which was also reflected in EU energy trade policies. Domestic production of fossil fuels has gradually been replaced by more competitive options from abroad. As a result of the competitiveness of some neighbours, the market concentration of EU supply increased. In particular, the availability of low-cost natural gas import options from neighboring areas through pipelines has gradually resulted in a stratification of the supply structure, leading to significant dependencies on only a small number of trading partners (Just, Wild, and Arnold 2022). Despite warnings and signs of geopolitical tensions raising supply insecurity concerns, the EU's cost-based procurement strategy continued over the last decade, with the construction of Nord Stream 2 being an excellent example (Lang and Westphal 2017). In 2022, 80% of the total natural gas needs in Europe were imported while domestic production has halved in the past ten years (ACER 2023). The extreme increase in energy costs in the second half of 2021, followed by Russia's invasion of Ukraine, however, has demonstrated that access to low-cost energy in the past came at the expense of current energy prices. The substantial reliance on Russian energy caused considerable damage to the economy and made it clear that the EU's energy import strategy of recent decades has failed. The development of hydrogen imports now offers the opportunity to learn from the mistakes of the past and create a more resilient future energy supply. As the establishment of trade routes for low-carbon hydrogen entails significant investments, it is crucial to have a comprehensive understanding of the potential suppliers. This should not be limited to their cost competitiveness but should also take into account aspects related to their reliability so that investments lead to economic, sustainable, secure and timely supply options.

Today's international trade is often determined by two key factors, namely economic mass and distances between economies. The greater the economic output and the shorter the distance, the more trade usually takes place. This relation has been confirmed many times by the use of the gravity model (Kepaptsoglou, Karlaftis, and Tsamboulas 2010). However, this principle is only applicable to a certain extent in the context of energy trade, as it is primarily influenced by "natural" rather than "conventional" comparative advantages arising from the geographical distribution of fossil resources (Van de Graaf 2019). Although geographical distances have influenced trade patterns in the past, mainly due to physical characteristics and the ability to transport energy, their influence has declined (Bachmeier and Griffin 2006; Barnes and Bosworth 2015; Sutrisno, Nomaler, and Alkemade 2021). As there is no international market yet, it is therefore necessary to better understand how international hydrogen trade will develop, what the drivers are and whether there are parallels to current energy trade to avoid misinvestment. Due to the importance of the expected role of hydrogen and its derivatives in the energy transition, research interest in this topic has increased in recent years (Brändle, Schönfish, and Schulte 2021; Pflugmann and Blasio 2020; Grinschgl, Pepe, and Westphal 2021). The existing literature focuses on various aspects such as costs, geopolitics or country potentials. As the studies mostly stay within their respective research stream, there is a need for more cross-sectoral approaches that enable an assessment of trade taking into account aspects such as affordability, conditions for sustainability, reliability and urgency to enable a timely energy transition.

1.3 Organisation of the thesis

This dissertation consists of three essays, each of which link to one of the three aspects introduced above. The work aims to shed light on the development of an economic efficient ramp-up of hydrogen supply in the EU and to contribute to the still limited existing literature on the topic. Each essay has a dedicated chapter.

Chapter 2 focuses on regulatory aspects of the production of green hydrogen. To support the design of appropriate and target-oriented regulation, this chapter contributes to the understanding of the trade-off between environmental integrity and economic viability in the production of electrolytic hydrogen. By applying an electricity market model, the work looks at the impact of various regulatory options for the operation of electrolyzers, focusing on social welfare and CO₂ emissions. The assessed options are based on the three dimensions proposed in the ongoing regulatory debate: (1) the origin of the sourced electricity, (2) the temporal correlation of the production of hydrogen and renewable electricity, and (3) its spatial correlation. The analysis focuses on Germany in 2030, which is an interesting case study due to the extensive planned restructuring of the country's energy sector (e.g., phasing out of coal and nuclear energy, massive expansion of renewables, bottlenecks in the supply of natural gas as a transitional energy fuel). Despite the regional focus of the analysis, regulation at the European level, however, has much greater effects. Although regulation has recently already been introduced in the EU with the Delegated Act, the results provide numerous general findings, that can benefit the implementation of regulation in other countries, such as in the US and Brazil.

The third chapter deals with the growing challenges in the operation of today's power systems caused by the rapid expansion of renewables and the systemic role of electrolyzers in tackling these challenges. Given the existing doubts about the effectiveness of the current market design in promoting the installation of the technologies in a system-beneficial way, adaptations to the market design are suggested that support unlocking the systemic value of supply and demand-side assets. While options such as local flexibility markets or market zone splitting are not considered viable in the short-term due to their implementation complexities, this chapter examines an approach that involves the engagement of system operators in the placement and operation of electrolyzers. As this approach faces challenges under current vertical unbundling rules, it is assessed to what extent regulatory relaxations could help to integrate electrolyzers in a system supportive way until more sophisticated market-based options are available. A modelling framework composed of an electricity market model, a redispatch model and a hydrogen supply chain model, is applied to assess the economic value of this option. The analysis focuses again on Germany in 2030, which is an interesting case due to the observed geographic distortions in the power sector caused by the distribution of natural resources, the expansion of renewables, and grid expansion difficulties.

Chapter 4 addresses aspects related to the establishment of economic imports of low-carbon hydrogen and its derivatives to the EU. Like many other countries, the EU is currently in the process of establishing partnerships and implementing adequate financing vehicles to initiate low-carbon hydrogen trade. In light of the paradigm shift in EU energy trade policy caused by Russia's invasion of Ukraine, considerations of security of supply and reliability aspects should be given

higher emphasis in the selection of potential trade partners. New partnerships and investments in low-carbon hydrogen trade should therefore target not only economic and sustainable but also secure and timely supply options supporting a successful EU energy transition and avoiding the repetition of past mistakes. This chapter contributes to the discussion on creating appropriate EU import strategies and identifying suitable trade partners for low-carbon hydrogen and ammonia. A methodology is developed consisting of a detailed hydrogen supply chain model combined with a multi-criteria analysis which allow potential export partners to be assessed both in terms of their cost competitiveness and with respect to their suitability as reliable trades partner. The considered soft factors include political, social, and economic aspects as well as a country's adaptability or technological know-how. While the analysis focuses on the EU as the import region, the developed methodology can be adapted to other geographical areas.

1.4 Methodological considerations

1.4.1 Modelling approach

In all three parts of this thesis quantitative analyses are conducted. Appropriate models are developed to approach the research questions. Appropriate models are developed for this purpose. Their development as well as the collection and preparation of the corresponding input data represented an essential part of this dissertation. In addition to the findings on the addressed questions, they make an important contribution to this work. The conducted analyses are primarily based linear optimisation techniques. These allow the value of an objective function to be either minimised or maximised subject to different constraints. The linear nature of the problem implies that both the objective function and all constraints have a linear structure (Vanderbei 2014). These techniques are used in many areas today. One key advantage of the methods is their convex character, which allows for manageable complexity. Large problems involving a significant number of decision variables can therefore be solved. In addition, the convexity of the problems guarantees high precision of the results as every local optimum is a global optimum. In this work, the techniques of linear optimisation are mostly applied through network flow problems (Bertsekas 1991). These are commonly used in the energy sector to determine energy flows in networks composed of nodes and edges that result in minimised supply costs. Corresponding technical and economic conditions of the assessed problems are included in the mathematical formulation by means of constraints (Pfenninger, A. Hawkes, and Keirstead 2014; Crespo del Granado et al. 2018).

In addition to linear optimisation methods, in chapter four, techniques from multi-criteria decision-making (MCDM) are applied. They aim to assess and rank alternative options in a consistent and transparent manner with respect to their performance on a variety of assessment criteria (Roy 1990). MCDM is widely used today. A broad set of techniques exists, all of which have advantages and disadvantages. The choice of the method depends on the analysed decision process. The idea of multicriteria analysis, however, is not to provide optimal solutions (Mardani et al. 2015). Rather, they aim to provide tools to help decision-makers in weighing up different alternatives. (Cavallaro and Ciraolo 2005)

1.4.2 Accuracy, assumptions, caveats and limitations

A common criticism of modelling approaches that use linear optimisation is their deterministic character. Since perfect foresight is assumed, all input parameters are considered known and given. In reality, however, the results are affected by uncertainties and unexpected fluctuations. These effects are not reflected in deterministic approaches, which leads to limitations in the method.

Another common criticism of the applied methodology in the modelling of markets is the assumption of perfect competition, which is the goal of competition authorities and regulators. It is assumed that all market participants have complete information and thus the same knowledge. In reality, however, this is often not the case, as not all actors have access to the same information or may have a different understanding of them. Instead, inefficient market outcomes, market distortions and the exercise of market power, which are all signs of imperfect competition, can result from information asymmetries. In addition to the consideration of full information availability, it is further assumed that none of the market participants has a market share that allows them to exercise market power. Considering the aspects of imperfect competition in modelling would lead to non-linear relationships in the problem definition which are beyond the scope of linear optimisation. The complexity of non-linear problems increases significantly affecting their analysable size. As a consequence, substantial deficiencies arise in representing the power sector, questioning the adequacy of its presentation and thus the meaningfulness of findings.

The analyses of this thesis are based on a variety of data covering a wide range of different parameters. Various sources were used to set up comprehensive data sets. Both the data collection and the corresponding processing within the harmonisation process were carried out with great care. However, due to the heterogeneity of the different data sources, especially with regard to their timeliness, it is inevitable that some noise and bias is introduced. Potential noise and bias may also arise from the initial data sources, where the data provider likely encountered similar challenges. Moreover, in some case, data gaps required the making of assumptions, which can introduce additional noise.

Due to the limitations and caveats, precision in the modelling results remains limited. Interpretation of the outcomes should therefore be done with care, focusing on the ranges, trends and interplay of factors rather than on individual numerical values.

Furthermore, it should be noted that the elaboration of the contents of this doctoral thesis spread over several years. For this reason, the work does not represent a snapshot of the current situation in the energy sector. In addition to the adjustments to climate targets, the Ukraine war has had a significant impact on the energy sector in recent years. Although the data and scenarios used only partially take these events into account, efforts are made to ensure that the statements remain valid.

Chapter 2

Green hydrogen – How grey can it be?

Contribution

It is published as a working paper with the Florence School of Regulation: Johannes Brauer, Manuel Villavicencio, Johannes Trüby, *Green hydrogen – How grey can it be?*, 2022, RSC 2022/44

Conference presentations:

- 43rd IAEE International Conference, 2022, Tokyo (remote)
- 16th International Conference on Energy Economics and Technology ENERDAY, 2022, Dresden
- Young Energy Economists and Engineers Seminar YEEES, 2022 Ghent
- FSR / DG ENERGEN workshop on the Delegated Act, 2022, online

Abstract

Low-carbon hydrogen is considered to play a key role in the European energy transition. The production of electrolytic hydrogen using electricity in the electrolysis process is one promising upstream route. Depending on the origin of the sourced electricity, however, the hydrogen production is associated to different carbon emissions and costs. While a strict coupling of renewable energies to electrolyser systems ensures the ‘greenness’ of the produced product, it is likely to be accompanied by increasing production costs. On the contrary, operating the units freely at power markets unfold their flexibility, allows to benefit from price signals and can reduce overall production costs. The carbon intensity in both the system and the resulting hydrogen product, however, might rise. Consequently, there are indications of a trade-off between environmental integrity and economic viability. To avoid undesired effects on the climate, regulation is proposed.

By applying an electricity market model, we assess the impact of various regulatory options that restrain the operation of electrolyser systems on social welfare and carbon emissions. The analysed options are based on the three dimensions proposed in the regulatory discussions: (1) The origin of the sourced electricity, (2) the temporal correlation of the production of hydrogen and renewable electricity and (3) their spatial correlation. For the case of Germany in 2030, our results suggest that regulation should be strict enough to ensure CO₂ emission reduction but sufficiently loose for electrolysers to provide system flexibility promoting the integration of further renewables. A monthly balancing of additional renewables installed in the same bidding zone, as proposed by the European Commission in the Delegated Act, seems an appropriate regulatory level. Moreover, as the trade-off mostly depends on the relative costs of renewables and fossil-based electricity, our findings also indicate that with continued cost decrease for renewables, the need for regulation diminishes.

Résumé

L'hydrogène bas carbone est considéré comme ayant un rôle clé à jouer dans la transition énergétique européenne. En particulier, la production d'hydrogène par électrolyse semble prometteuse, mais en fonction de l'origine de l'électricité d'origine, elle est associée à des émissions de carbone et à des coûts différents. Si un couplage strict des énergies renouvelables aux systèmes d'électrolyses garantit l'origine bas carbone de l'hydrogène produit, il est probable qu'il s'accompagne d'une augmentation des coûts de production. A l'inverse, l'exploitation libre des unités sur les marchés de l'électricité déploie leur flexibilité, permet de bénéficier des signaux de prix et ainsi de réduire les coûts de production, mais pourrait conduire à l'augmentation de l'intensité carbone du système et de l'hydrogène produit. Par conséquent, il semble possible de trouver un compromis entre l'intégrité environnementale et la viabilité économique de tels électrolyseurs, et un cadre réglementaire approprié permettrait d'éviter les effets indésirables sur le climat.

En appliquant un modèle de marché de l'électricité, cette partie se concentre sur l'étude de l'impact de diverses options réglementaires sur d'éventuelles restrictions quant au fonctionnement des systèmes d'électrolyseurs en termes de bien-être social et d'émissions de carbone. Les options analysées s'appuient sur les trois dimensions proposées dans les discussions réglementaires : (1) l'origine de l'électricité, (2) la corrélation temporelle de la production d'hydrogène et d'électricité renouvelable et (2) leur corrélation spatiale. Pour le cas de l'Allemagne en 2030, les résultats suggèrent que la réglementation devrait être suffisamment stricte pour garantir la réduction des émissions de CO₂, mais suffisamment souple pour que les électrolyseurs offrent une flexibilité du système favorisant l'intégration des énergies renouvelables. Un équilibrage mensuel des énergies renouvelables supplémentaires installées dans la même zone d'appel d'offres, comme le propose la Commission européenne dans l'acte délégué, semble un niveau réglementaire approprié. De plus, comme le compromis dépend principalement des coûts relatifs des énergies renouvelables et de l'électricité d'origine fossile, la baisse continue des coûts des énergies renouvelables devrait permettre de diminuer le besoin de réglementation.

2.1 Introduction

With the European Green Deal (EC 2019), announced at the end of 2019, the EU committed itself to climate neutrality by 2050¹. This ambition requires a radical restructuring of today's energy supply. In the past two decades, renewables (RES) have demonstrated that they can contribute to this goal. However, due to their variability and the absence of sufficient viable large-scale storage, new challenges in the operation of the power system arise, making it difficult to simply further up-scale their capacities. Furthermore, there are various sectors in the economy such as industry and transport where the direct replacement of fossil energy with renewable electricity is questionable. They are also referred to as sectors that are 'hard-to-abate'. Hydrogen is an energy carrier that, in addition to direct electrification, shows promising capabilities to contribute to the decarbonisation of these sectors, but also to the wider economy. Its physical characteristics offer strengths (e.g., transport, storage, balancing over time) that complement direct electrification well. A critical requirement for the use of hydrogen as an energy carrier in future energy systems, however, is that its use must lead to a significant reduction in CO₂ emissions (Velazquez Abad and Dodds 2020). As hydrogen hardly exists in pure form, it needs to be produced. Historically, fossil fuels such as natural gas and coal were mainly used to produce it. Its production has been leading to substantial CO₂ emissions (IEA 2019c). The production of electrolytic hydrogen represents a path that can avoid CO₂ emissions. Electricity is used in the electrolysis process to split water into its constituent elements of oxygen and hydrogen. Electrolysers are considered a sector coupling technology, linking the power system with other sectors. They could therefore help to provide flexibility to the energy system and hence, to facilitate the integration of renewable electricity. The possibilities and the potential of low-carbon hydrogen to contribute to the decarbonisation of the economy has also been acknowledged by the European Commission. The European hydrogen strategy (EC 2020) as well as various hydrogen strategies at member state level have been released in recent years (BMWI 2020b), assigning low-carbon hydrogen a pivotal role in the energy transition. Consequently, while hydrogen has played so far only a minor role in the energy sector, mainly as feedstock for industry, consumption is expected to increase rapidly in the coming decades which is also shown by projections of various studies (Deloitte 2021; FCH JU 2019).

Electrolysis requires electricity, which has different CO₂ intensities depending on its origin. While electricity from variable renewable energy sources such as solar PV and wind does not cause direct CO₂ emissions, electricity from fossil energy sources is associated with significant direct CO₂ emissions. The various electricity sources, however, are characterised by different generation costs as well as different availabilities, both of which have an impact on the production costs of hydrogen. While fossil power plants have high availabilities, they are comparably low for variable renewables and are subject to seasonal differences between technologies and resources. This therefore indicates a trade-off between environmental integrity and economic viability in the production of hydrogen:

- Benefitting from higher availability factors of grid electricity lowers costs but might lead to higher CO₂ emissions;

¹ Put into effect with the European Climate Law in 2021 (EC 2021).

- Relying entirely on variable renewable energy technologies ensures the reduction of CO₂ emissions but might result in overall higher costs.

In the current debate it is therefore argued that the production of hydrogen creates a ‘dilemma’ (Frontier-Economics 2021). Prioritising environmental aspects might hinder the development of the hydrogen economy through higher costs, while focusing on the economic viability only might increase CO₂ emissions and counteract the decarbonisation process. To ensure an appropriate contribution of electrolytic hydrogen to climate targets that does not lead to rising CO₂ emissions, regulatory intervention is envisaged.

Currently, policymakers and regulators around the world frame the regulatory basis for the production of electrolytic hydrogen and the integration of electrolysers in the energy system². The successful development of a low-carbon hydrogen economy is important in the EU energy transition to not only meet the overarching decarbonisation goal in a timely and socially acceptable manner but also to ensure competitiveness of the domestic industry and to maintain a technology leadership in the sector. It is therefore important to assess regulation on both their environmental and their economic impact. This paper contributes to the understanding of the trade-off between environmental integrity and economic viability in the production of electrolytic hydrogen to support the design of appropriate and target-oriented regulation.

The remainder of the work is structured as follows: in Section 2.2 we give an overview of the relevant literature and discuss the current thinking on the regulation of electrolytic hydrogen. In Section 2.3, both the methodology and the developed model are described. This is followed by an introduction of the case study and the related data (Section 2.4). Next, in Section 2.5 the results are presented, which are then discussed in Section 2.6. At the end a conclusion of the analysis is given (Section 2.7).

2.2 Background and literature review

The interest in electrolytic hydrogen as an energy carrier has been a topic at various points in time over the past decades so that the subject has already been studied from various angles. However, in the past, its breakthrough failed mainly due to its missing economic viability. With the binding commitment to CO₂ reduction target³, the significant decline in the costs of renewables⁴, and the official acknowledgement of its possibilities and its potential in the energy transition⁵, the interest in electrolytic hydrogen has increased drastically over the past years. As part of this new wave, various recent studies focus on the production of electrolytic hydrogen from different perspectives. Roach and Meeus (2020) for example assess the welfare and prices effects of electrolyser systems that operate at the intersection between electricity and natural gas systems. They use a model formulated as a complementary problem and find that there is an aligned incentive for electrolyser systems in both the electricity and the natural gas sector. However, their results also show that a welfare optimised

² Delegated act (EC 2023a) to the European Renewable Energy Directive (EP 2018).

³ United Nations Paris Agreement; <https://www.un.org/en/climatechange/paris-agreement>.

⁴ (IRENA 2021)

⁵ (BMW 2020b; EC 2020)

system configuration results in a monetary loss for the electrolyser unit. Another study that focuses on the effect of electrolysers as sector coupling technologies between energy markets is conducted by Li and Mulder (2021). The authors study the interaction of electrolysers between the electricity and the expected hydrogen market. They find that electrolysers can provide valuable flexibility to the electricity sector. However, they conclude that efficiency improvements and cost reductions of electrolysers as well as higher CO₂ prices are necessary to result in a positive economic value for the technology. Other studies focused rather on the integration of electrolysers in the power sector and their interaction with it. Ruhnau (2022) for example assesses whether the production of electrolytic hydrogen can stabilise the market value of renewables. The author apply an electricity market model and find that flexible operating electrolysers counteract the cannibalisation of the market value of renewables. Stöckl, Schill, and Zerrahn (2021a) conduct another study on the interaction of electrolysers with the power sector. They also apply an electricity market model with a simplified integrated hydrogen supply chain optimisation model to study the impact of various parameters such as the penetration of renewable electricity and the hydrogen demand level on the optimal system design. They find that there is a trade-off between energy efficiency and temporal flexibility. While for lower shares of renewables the energy efficiency in the hydrogen supply structure is more important, for higher shares the temporal flexibility of electrolysers gains in importance. In the study of vom Scheidt et al. (2022) the production of electrolytic hydrogen is assessed from a different angle. The authors analyse the effect of spatial price signals for the integration of electrolyser systems in single-pricing markets. They find that spatial signals are important instruments to avoid grid congestions and to reduce costs due to both avoided curtailments of renewable electricity and reduced redispatch needs. The potential of electrolysers to facilitate the operation of the power system and hence, to reduce overall system costs is also shown by Xiong et al. (2021). To summarise, previous studies find that grid connected electrolysers can have a value for the power system, especially those with operational flexibility. However, they do not distinguish with respect to the CO₂ intensity of the produced hydrogen and often use ‘renewable’ or ‘green’ hydrogen as synonym for electrolytic hydrogen regardless of the origin of the sourced electricity and its CO₂ content.

Following the regulatory discussions in the creation of a target-oriented taxonomy for the European energy transition, however, makes clear that electrolytic hydrogen cannot be considered a homogenous good. Instead, distinctions of electrolytic hydrogen based on associated CO₂ intensities are discussed such as the categorisation into low-carbon and renewable hydrogen. This calls for the introduction of regulation to provide an official basis for this distinction. Velazquez Abad and Dodds (2020) discuss the topic qualitatively. The authors list the characterisation of green hydrogen in existing standardisation approaches. They point out that these differ substantially in the way how green hydrogen is characterised. The authors conclude that there is so far no common understanding which would facilitate informed decision making for investments. Despite some first attempts of Ruhnau and Schiele (2022), Schlund and Theile (2022) and Zeyen, Riepin, and Tom Brown (2022), the effects of possible regulatory aspects for the production of electrolytic hydrogen have not been sufficiently addressed. For the case of German in 2020, Schlund and Theile (2022) assess the effect of various regulation with respect to the ‘simultaneity’ aspect. This aspect describes and defines the period in which renewable electricity is generated and sourced to produce hydrogen. They apply an

optimisation model, that represents a profit-maximising electrolyser system. The model is combined with a Monte-Carlo simulation that mimics the electricity wholesale market under stochastically changing availabilities of wind generators. The authors confirm the existence of the dilemma of electrolytic hydrogen and conclude that when putting in place regulation, policymakers must decide whether to prioritise the economic viability, which comes at the cost of additional CO₂ emissions, or the other way around. Germany is also the study case of Ruhnau and Schiele (2022) that use a similar approach and focus on similar aspects as the previous authors. In their analysis they assess the years 2017 to 2021. Historical information on market prices and generator dispatch are linked to an investment and operation model for a wind-hydrogen system to represent its interaction with the electricity market. Differently from Schlund and Theile (2022), they do not find the existence of the dilemma. Instead, their results suggest regulation for a flexible electrolyser operation as both hydrogen production costs and CO₂ emissions decrease. Zeyen, Riepin, and Tom Brown (2022) is another study that focuses on Germany as a study case, but they also assess the case of the Netherlands. While the studies of Ruhnau and Schiele (2022) and Schlund and Theile (2022) take a backward looking approach, Zeyen, Riepin, and Tom Brown (2022) analyse the years 2025 and 2030. They use an electricity market model to compare variants of temporal correlations (‘simultaneity aspect’). In addition, they assess the impact of ‘additionality’ requirements. This sets the conditions that the electricity used in the production of electrolytic hydrogen must come from newly installed, additional renewables. The authors find that ‘additionality’ requirements are necessary to reduce CO₂ emissions, and that annually matching can lead to CO₂ emission reductions if electrolysers are operated flexibly. The effects of regulation on the overall system performance, the resulting CO₂ emissions and the corresponding changes in welfare have so far only been touched by Zeyen, Riepin, and Tom Brown (2022), who refer to the approach proposed by Brauer, Villavicencio, and Trüby (2022)⁶. As also acknowledged by Schlund and Theile (2022), further research is therefore needed on these aspects.

Against this background, discussions on regulation focus mainly on setting requirements on three dimensions, namely (1) the origin of the sourced electricity, as well as (2) the temporal and (3) the geographical correlation between generated electricity from renewables and sourced electricity Frontier-Economics (2021) and EC (2023a). The first aspect, origin of the sourced electricity, refers to how the sourced electricity is generated. Often the word ‘additionality’ is mentioned in this context as in the study of Zeyen, Riepin, and Tom Brown (2022). It defines that the sourced electricity used by the electrolyser must come from renewables that present additions of renewable energy capacity to the overall power system. The second aspect, the temporal correlation, refers to what Schlund and Theile (2022) call ‘simultaneity’. It describes the timeframe in which the generated electricity from renewables and the sourced electricity are balanced. Finally, the third aspect, the geographical correlation refers to the spatial relation between the locations of the renewables and the that of the electrolysers. Each of the three aspects can be set to various states ranging from very strict to very loose requirements. Consequently, they can be considered as regulatory dimensions with different levels of stringency spanning a three-dimensional space, as illustrated in Figure 2.1.

⁶ A previous version of this research.

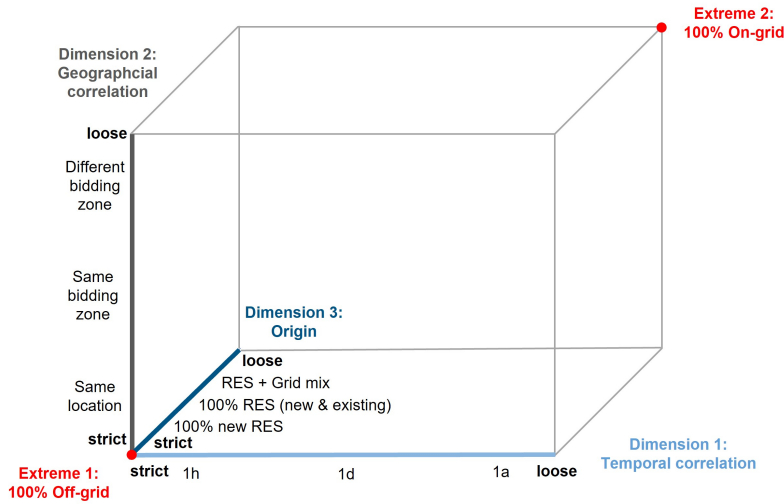

Figure 2.1: Regulatory dimensions

The lower left corner represents the point where all dimensions are set to the strictest possible levels. In this case, the electricity must come from newly build renewables (strict origin), placed at the same location as the electrolyser system (strict geographical correlation). Furthermore, the generated renewable electricity must be used directly (strict temporal correlation). This point can also be described as a 100% off-grid system, where there is (virtually) no connection to the wider electricity grid. In our study we refer to it as ‘extreme 1’. This strictest case can be relaxed on all three dimensions. While relaxations on the geographical correlation would allow for installations of renewables at a wider spatial scale such as somewhere in the same bidding zone or even in a different one not restricted to the electrolyser location, relaxing the temporal correlation increases the timeframe in which the generated renewable electricity and the sourced electricity are matched. The timeframe might increase from very short periods such as quarter-hourly or hourly, to longer ones such as daily, weekly, monthly, or even annually. Accordingly, it needs to be ensured that the sum of the renewable electricity generated corresponds to the sum of the sourced electricity within the same period. Relaxations on the third dimension, the origin of the electricity, would loosen the requirements on where the electricity comes from. Possible relaxations might permit to use electricity of already existing renewables rather than only electricity from newly build capacity. The case where all three dimensions are fully relaxed is presented by the upper right corner of Figure 2.1. Since, in this case, there are no conditions attached to the origin of the electricity, there are neither any constraints on the temporal nor on the geographical correlation regarding the generation of the sourced electricity. In this case the electricity can be sourced freely at the market. We refer to it as ‘extreme 2’ – no regulation.

In this study, these three dimensions are used to assess various regulation for the electricity sourcing of electrolytic hydrogen to better understand and shed light on their implications on environmental integrity and economic viability. We focus on the near-term impact of regulation during the initial phase of the hydrogen economy. In addition to previous studies, our work focuses not only on the hydrogen production perspective, but also considers broader system aspects within the power sector.

2.3 Methodology

A sequential approach consisting of three consecutive steps is applied (Figure 2.2). As the focus of the analysis is to assess the interaction between the production of electrolytic hydrogen and the operation of the power system, an electricity market model is developed representing the electricity wholesale market. It enables to extract a variety of information on the development and the operation of generation units as well as the influence of the additional electricity demand to produce electrolytic hydrogen impacts the system under different regulation. A detailed description of the model is provided in Appendix A.2.

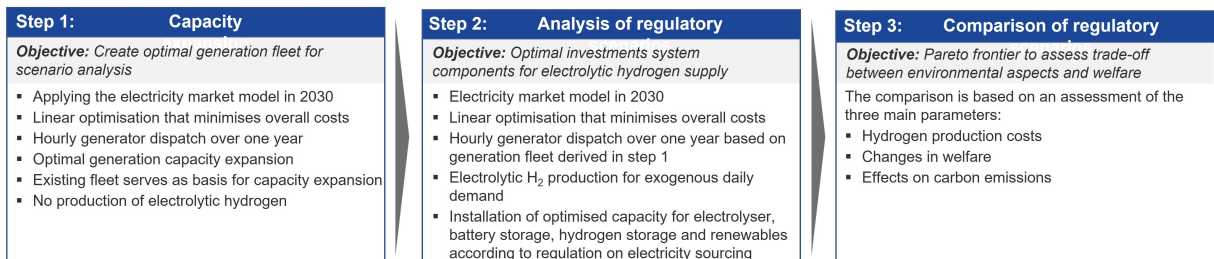

Figure 2.2: Overview about methodology

The first step of the assessment, capacity expansion, serves to build the foundation of the analysis. In this step the electricity market model is applied in a capacity expansion mode, meaning that for the considered geographical scope the model can decide endogenously about the commissioning of new or the decommissioning of existing generation units. The decisions are based on the economic viability of the units. Within this step, we do not consider any production of electrolytic hydrogen. This step aims at building an economically optimal generation fleet, that is then, in the second step of the analysis, confronted with an additional electricity demand for the production of electrolytic hydrogen.

In the second step, the electricity market model is applied again. However, this time, the focus is on the operation of the generation units and the changes to the power system caused by the electrolytic hydrogen production. The optimised generation fleet from the first step serves as input. Moreover, an exogenous daily hydrogen consumption is introduced. It needs to be supplied in a captive manner, meaning that the hydrogen is produced and processed near the final demand location. This stems from one of our key assumptions, namely that in the early ramp-up phase of the hydrogen economy, no meaningful national hydrogen infrastructure is available that could be used to transport hydrogen in large quantities over considerable distances. In this second step, the electricity market model can invest in all system components that are required to supply the hydrogen demand in a least-cost manner. This includes battery storage capacity, electrolyser systems that convert electricity to hydrogen and facilities to store hydrogen. The capacities of the system elements are sized accordingly within the model. Figure 2.3 illustrates the complete setup of investment possibilities and their arrangements. Furthermore, as the objective of the second step is to analyse constraints imposed by regulation for the electricity sourcing in hydrogen production, the model is also allowed to invest in additional capacity of renewables. Depending on the analysed

regulation, however, further conditions might be set to constrain their installations (e.g., on the spatial correlation to the demand location). The market model represents a perfectly competitive electricity market setup with all players acting in a profit-maximising manner. Consequently, both the dispatch decisions of generators in the electricity market and all investments in hydrogen supply components, as well as their operation, result in optimal systems that minimise total system costs, including the costs of hydrogen.

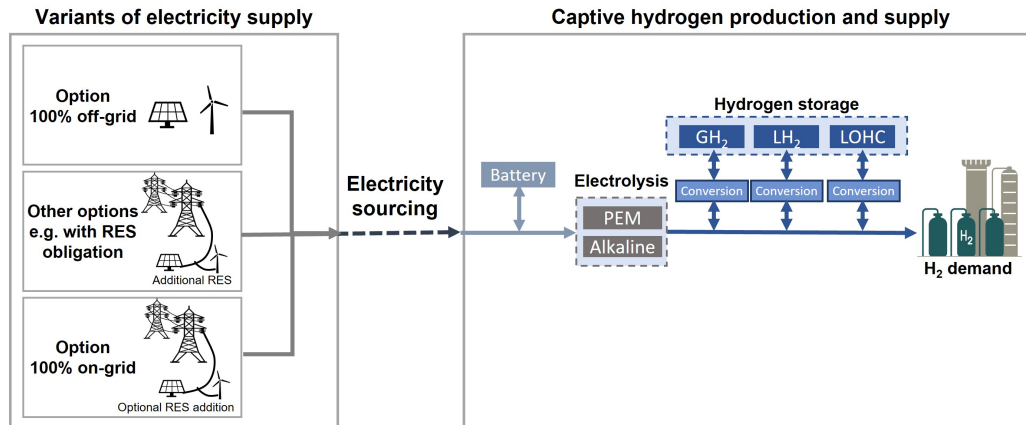

Figure 2.3: Scheme of hydrogen supply structure

The purpose of the second step is to assess possible regulation. While in extreme case 1, the model can invest only in renewable capacities near the hydrogen demand location, in extreme case 2 there is no obligations to add future generation capacities but the possibility is given to do so if economically viable. In addition to the two extremes, a variety of other possible regulation with different degrees of stringency are conceivable (see Figure 2.1). Relaxations on the geographical correlation are represented within the model through constraints that allow for installations of renewables at different spatial levels. For the strict regulation, we require the units to be installed at the location of demand and site-specific capacity factors of renewables are taken into account. In more relaxed cases, that allow for investments in the same bidding zone or even in another bidding zone, the capacity factors at the corresponding market levels are considered. The temporal correlation is implemented through the representation of a ‘virtual storage’⁷. For the strict case, which requires the renewable electricity to be generated and sourced at the same time, there is no need for a virtual storage. Once the temporal correlation is relaxed (e.g., balancing over the same day, week, month, year), however, the storage sums all sourced electricity as well as all produced renewable electricity, that is dedicated for the hydrogen production, within the considered timeframe and ensures that both sums are equal. This temporal decoupling of the electricity generation and the corresponding sourcing enables the hydrogen producers to react to price signals on the power market and to provide flexibility. In times when generation is scarce in the wholesale market, the hydrogen producers can sell their renewable electricity to benefit from high electricity prices. On the contrary, in times when there is surplus electricity in the system, they can then purchase volumes from the market to benefit from low wholesale prices. Consequently, the more the temporal correlation is

⁷ (Schlund and Theile 2022)

relaxed, the more operational flexibility hydrogen producers can offer to the system and the more they can benefit from trading opportunities. In this regard it might also be beneficial to oversize the capacity of renewables to profit from additional revenue streams through the selling of surplus electricity to the market. In all cases where electrolyzers and renewable generators are considered connected to the grid, the potential surplus of renewable electricity can be injected into the system.

In the third and last step of the analysis, the outcomes of all considered regulation are compared based on various indicators. The effect of the regulation on the hydrogen production cost, the CO₂ emissions and the overall welfare are of particular interest.

2.4 Scenario setup and data

In this study, we analyse the case of Germany in 2030. The year 2030 represents the ramp-up phase of the low-carbon hydrogen economy in the country. Germany is an interesting case to assess for several reasons. The government did not only decide to phase-out lignite and hard coal-fired power plants by 2038⁸, which have been the backbone for the country's economic growth in the past century, but also to shut down all nuclear power plants by 2022⁹, that have contributed significantly to the power mix in the past decades. Both decisions will significantly change the structure of electricity generation in the coming decade. In addition to these long-planned steps, recent geopolitical tensions further increase the relevance of the topic. The heavy dependence on energy supply from Russia in the past, in particular imports of natural gas, which represented until recently still more than 50% of the national natural gas supply, and its immediate stop puts Germany under substantial additional pressure.

Until recently, the country's strategy to achieve its decarbonisation goals, CO₂ neutrality by 2045¹⁰, focused mainly on the massive expansion of renewables with natural gas being a transient fuel during the transition phase. With the announcement of the national hydrogen strategy in 2020 (BMWI 2020), low-carbon hydrogen has been set as another pillar. After a technology-neutral start-up phase, the national hydrogen strategy envisages giving priority to the production and use of electrolytic (green) hydrogen. As the intended role of natural gas in the German energy system is now more uncertain due to the recent geopolitical changes, it is likely that the production of electrolytic hydrogen gains significantly in importance earlier than expected to take over and to substitute some of the natural gas demanding uses.

⁸ Discussions on bringing the phase-out forward to 2030; <https://www.bundesregierung.de/breg-de/schwerpunkte/klimaschutz/kohleausstieg-1664496>; Accessed: 20.05.2023 .

⁹ With short-term term extension until April 2023; <https://www.bundestag.de/dokumente/textarchiv/2022/kw45-de-atomgesetz-freitag-917474>; Accessed: 10.02.2023.

¹⁰ (Germany-Government 2021)

2.4.1 Analysed regulation designs

ID	Name	Dimensions			Description
		Temporal	Spatial	Origin	
I	Extreme 1 - 100% off-grid	Same hour	Same location	Additional new RES	Strict requirements on all dimensions. The hydrogen production must take place isolated from the power system with new additional RES
II	100% off-grid + selling	Same hour	Same location	Additional new RES	Similar to the above regulation. However, a grid connection exists to sell surplus electricity to the market instead of curtailing it.
III	Same bidding zone	Same hour	Same bidding zone	Additional new RES	Strict requirements on the temporal dimension (hourly balancing) and on the origin (new additional RES). RES can be installed anyway in the same bidding zone. The transmission grid is used to transfer the renewable electricity between the generation and the demand location.
IV	Same day	Same day	Same bidding zone	Additional new RES	Strict requirements on the origin (new additional RES). RES can be installed somewhere in the same bidding zone. The renewable generation and the sourcing must be balanced at a daily level. The transmission grid is used to transfer the renewable electricity between the generation and the demand location.
V	Same week	Same week	Same bidding zone	Additional new RES	Strict requirements on the origin (new additional RES). RES can be installed somewhere in the same bidding zone. The renewable generation and the sourcing must be balanced at a weekly level. The transmission grid is used to transfer the renewable electricity between the generation and the demand location.
VI	Same month	Same month	Same bidding zone	Additional new RES	Strict requirements on the origin (new additional RES). RES can be installed somewhere in the same bidding zone. The renewable generation and the sourcing must be balanced at a monthly level. The transmission grid is used to transfer the renewable electricity between the generation and the demand location.
VII	Same year	Same year	Same bidding zone	Additional new RES	Strict requirements on the origin (new additional RES). RES can be installed somewhere in the same bidding zone. The renewable generation and the sourcing must be balanced at a yearly level. The transmission grid is used to transfer the renewable electricity between the generation and the demand location.
VIII	Extreme 2 - no regulation	No	No	No	Loose requirements on all dimensions. Electricity can be freely sourced at the market without restriction on any of the dimensions.

Table 2.1: Overview about analysed regulation

Although there are many possible regulatory options, as described in Section 2.2, only a selection of them is analysed and discussed in this study. The choice is based on the outcome of a variety of trials during the research work of this study. It considers both extreme cases (100% off-grid and no regulation) as well as various intermediate options that cover different levels of relaxations along the three discussed dimensions. To address the core of the political discussions, our analysis focuses primarily on aspects linked to the temporal correlation. Table 2.1 shows the list of options considered (Section 2.6). Further information, in particular on the geographical dimension, can, however, be found in Appendix A.1.3.

2.4.2 Representation of the power sector

Within the electricity market model, we consider the wholesale market of Germany. As an adequate integration of the individual European electricity markets is one of the top priorities of the EU¹¹ to benefit from exchanges and trade, the interactions of the German system with its interconnected

¹¹ EU Energy Union - https://energy.ec.europa.eu/topics/energy-strategy/energy-union_de, Accessed 03/28/2022.

neighbours become more important. We therefore also include all electricity markets that are directly linked to the German market and model them endogenously¹². Today’s generation fleet builds the basis for the capacity expansion in Step 1 of our analysis. Data on existing generators are obtained from various sources (BNetzA 2020; Egerer 2016; German Environment Agency 2020; Kunz et al. 2017; Weibezahn et al. 2017). The data are harmonised and corrected by already announced commissioning and decommissioning plans of generators. Furthermore, announced national policy objectives in terms of power system evolution such as renewable energy capacity expansion targets and phase-out policies are taken from the national energy and climate plans¹³. All considered capacity floors, targets, and caps as well as all technical parameters of the generating units can be found in Appendix A.4.2¹⁴. The electricity markets are modelled in an hourly resolution for the entire year 2030. Data with hourly resolution¹⁵ are based on the reference year 2019 and taken from various sources¹⁶. Timeseries that underlie changes in their magnitude until 2030, such as the electricity demand profile and the available net-transfer capacities between the individual markets, are scaled according to annual projections provided by ENTSO-E¹³. Moreover, the electricity demand structure is adapted to account for projected new usages with different pattern such as electric mobility and electric heating (e.g., heat pumps). In addition to pumped storage plants, battery systems, as well as load shifting options offered by electric heating devices and electric vehicles are included as flexibility options in the power system. We also consider must run obligations of biomass generators through their heat provision. A description of the latter aspects as well as all considered commodity and CO₂ prices can be found in Appendix A.4.2.

2.4.3 Representation of the hydrogen supply

Today, hydrogen is mainly used as feedstock in industry and refineries. While additional demand of other sectors is expected to increase in the coming decades, the replacement of these existing fossil-based feedstocks is likely to be among the first uses of electrolytic hydrogen in the ramp-up phase of a low-carbon hydrogen economy. In our study, we therefore focus on the captive production and supply of electrolytic hydrogen to the German industry¹⁷. An annual hydrogen demand of about 820 kt¹⁸ is considered. It is geographically distributed based on the figures from vom Scheidt et al. (2022). The distribution enables to study regulation that targets strict requirements on the spatial dimension (e.g., lower than the national level). This is in particular the case for extreme case 1, the off-grid case, where renewable electricity generation must be located close to the electrolyser site.

¹² LU, FR, NL, BE, DK, PL, CZ, AT, CH, UK, NO, SE; Countries with more than one market zone such as DK are aggregated and considered by one single market.

¹³ Extracted from ENTSOE (2022b) - National Trend Scenario.

¹⁴ Only gaps in existing data are completed by the values provided in the tables.

¹⁵ e.g., inelastic electricity demand profiles, capacity factors of renewables, net transfer capacities between bidding zones.

¹⁶ Hourly capacity factors of Solar PV, onshore and offshore wind from ENTSOE (2021) and <https://www.renewables.ninja/> (Pfenninger and Staffell 2016; Staffell and Pfenninger 2016); All other timeseries from ENTSOE (2022a).

¹⁷ In the analysis we only consider the supply of gaseous hydrogen.

¹⁸ This corresponds to an electrolyser capacity of 10 GW with an efficiency of 68% for an operation of 4000 hours per year and is aligned to the announced governmental targets. (<https://www.bmwk.de/Navigation/EN/hydrogen/national-hydrogen-strategy.html>)

However, instead of modelling all 23 industrial hydrogen demand locations listed in vom Scheidt et al. (2022) individually, we split the country in three parts (north, south and centre) and aggregate the corresponding demand per zone. This enables to capture regional renewable resource availabilities while reducing computational complexity. Figure 2.4 illustrates the considered geographical setup, including hydrogen demand information and indications of the three considered geographical levels, namely the same location (represented by the three intra-national zones), the same bidding zone and all bidding zones. The annual hydrogen demand is distributed evenly over all days of the modelled year corresponding to a baseload pattern commonly found in industrial applications. Further details on the demand data can be found in Table A.13.

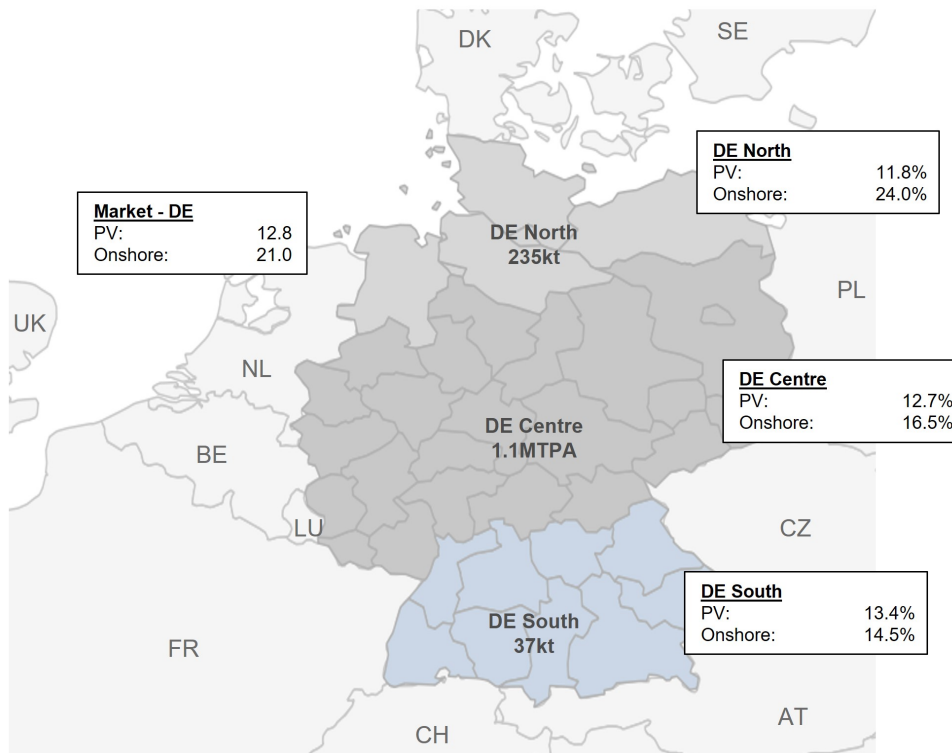

Figure 2.4: Considered geographical setup including hydrogen demand distribution and capacity factors of renewables

In addition to investments in renewables¹⁹, the model can also invest endogenously in various system components at the hydrogen demand location as described in Section 2.3. They offer the possibility to better balance the sourced electricity and the hydrogen supply, thus reducing hydrogen production costs. These elements include the storage of electricity in batteries, the conversion of electricity to hydrogen via electrolyzers as well as the storage of hydrogen in three different storage technologies. As hydrogen has a low volumetric density under normal conditions compared to other fuels (e.g., 3000 times lower than gasoline)²⁰, it needs to be processed to increase its volumetric density and to offer viable storage possibilities. According to the literature (IEA 2019c; Stöckl, Schill,

¹⁹ In the base case, we focus on additional capacity of solar PV and onshore wind similar as Zeyen, Riepin, and Tom Brown (2022). In a sensitivity analysis provided in A.1.2, the effect of investments in offshore wind capacity is assessed.

²⁰ Derived from IEA (2019c) and Salmon and Bañares-Alcántara (2021).

and Zerrahn 2021a), storing hydrogen locally at demand sites can be achieved via three different storage types: in compressed form (GH_2), as hydrogen in liquefied form (LH_2) or as hydrogen that is compound to a carrier material, which is then also referred to as liquid organic hydrogen carriers (LOHC). LOHC are similar in their characteristics to liquid fuels such as gasoline. Typically, GH_2 is stored at pressure levels around 30-250 bar²¹. As the produced hydrogen at the electrolyser outlet has a pressure level between 1-30 bar²¹, a compression step is needed to inject it into the storage system. Apart of additional investments in compressor facilities, the compression step also requires additional energy in the form of electricity. When the hydrogen gets released from the storage, the depressurisation does neither required notable additional investments nor further process energy. This is slightly different for the storage of hydrogen in liquid form. The liquefaction process at the storage inlet requires investments in additional system components (liquefaction unit) and significant process energy mainly needed to cool the hydrogen down to -252.76 Degree Celsius (IEA 2019c). The reconversion to gaseous hydrogen at the outlet of the LH_2 storage requires evaporation units. The investment costs for such units, however, are rather small and notable additional process energy is not needed. Storing hydrogen in the form of LOHC requires a hydrogenation unit at the inlet side of the storage, which compounds the hydrogen in an exothermal process to the carrier material. At the storage outlet, a dehydrogenation unit is needed to decompose the chemical bound between the hydrogen and its carrier material again. The dehydrogenation process is endothermal and thus requires process energy in the form of heat. However, as this study analyses the captive supply of gaseous hydrogen to industrial facilities, we assume that there is sufficient excess heat available for the reconversion from LOHC to gaseous hydrogen, so that there is no additional energy demand for the provision of the required process heat. Different potential carrier materials are available and discussed in the literature. In this study, we considered dibenzyl-toluene, which seems to be suitable for this type of application according to Stöckl, Schill, and Zerrahn (2021a). All used data on the individual system components as well as information on their references are provided in Appendix A.4.3.

2.5 Results

2.5.1 Effect of regulation on hydrogen production costs

The hydrogen production costs are expressed as levelised costs of hydrogen - LCOH. This measure calculates the hydrogen production costs by including all expenses and all potential revenues that occur during the supply of hydrogen. Further information on the calculation method is given in Appendix A.3.1. Figure 2.5 illustrates the results of the analysed regulation. Each bar corresponds to one regulation and is composed of several cost elements.

Both, the far-left and the far-right bar represent the two extreme cases. The figure shows that the strictest regulation, the 100% off-grid case (I), results in the highest LCOH. The hydrogen production costs are in this case at 3.6 EUR/kg H_2 . Moving further right increases the level of relaxation on the different dimensions. In the most relaxed case, i.e. the 100% on-grid case (VIII), the hydrogen

²¹ (Stöckl, Schill, and Zerrahn 2021b; IEA 2019c)

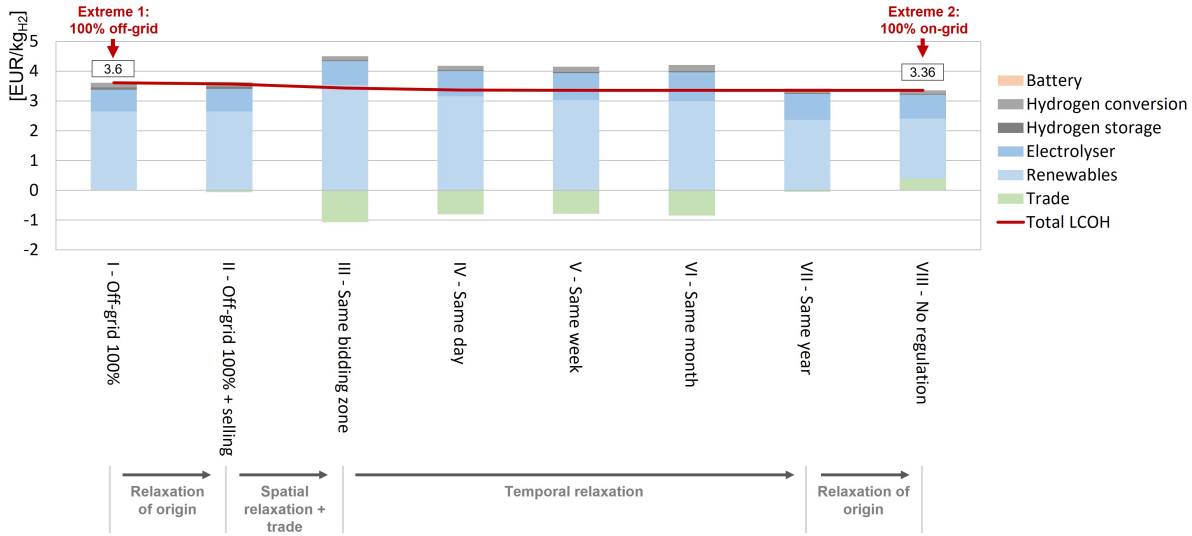

Figure 2.5: Effect of regulation on hydrogen production costs

production costs are at 3.36 EUR/kg_{H2}. Consequently, different levels of regulatory relaxation can reduce hydrogen costs by about 7%. While the overall reduction potential in LCOHs is not significant, the biggest drop occurs on the spatial dimension. Allowing for installations of renewable energies in the same bidding zone instead of restricting them to the hydrogen demand location (III) reduces costs by about 5% (0.17 EUR/kg_{H2}). Consequently, relaxations on the temporal dimension reduce the LCOH only to a minor degree. Between the strictest (hourly balance - III) and the loosest case (annual balance - VII), the costs decrease only by additional 2%. Furthermore, the graphic shows that depending on the level of relaxation, the composition of the LCOH differs. However, it becomes obvious that in all cases the sourcing of electricity expressed through the costs for additional renewable installations (Renewables) as well as through the trade with the power system (Trade) represents the main contributor to the overall costs. Its share varies between 64-74%. The cost component of the electrolyser system remains rather stable between 0.7 EUR/kg_{H2} and 0.95 EUR/kg_{H2} accounting for about 20%-29% of all costs. Moreover, one can see that the interactions with the power sector through the selling and the purchasing of electricity (Trade) can either be positive or negative. While for stricter cases the revenues outweigh the expense and hence, reduce the LCOH, in looser settings the expenses through trade possibilities are bigger than the revenues and add accordingly to the overall production costs. However, in these cases the total investment in renewable energy capacity is reduced. The figure also shows that while battery storage is not chosen in any of the analysed regulation by the model, hydrogen storage does play a role. Corresponding investments occur in all cases even in the most relaxed one (VIII), which highlights the importance of hydrogen storage. Its contribution to the overall costs remains small, however (0.15 - 0.25 EUR/kg_{H2}). In all cases, the investments are in LOHC storage facilities and their corresponding conversion and reconversion units.

2.5.2 Effect of regulation on social welfare

Figure 2.6 shows the change in welfare through the analysed regulation. The results of the individual relaxations are expressed as changes compared to the 100% off-grid case (I), which serves as reference case within this comparison. Each bar is composed of up to three elements namely the differences in consumer and producer surplus in the electricity sector as well as the differences in total hydrogen production costs. Consequently, within this analysis the term ‘welfare’ is defined by the sum of the three elements. Further information about their calculation can be found in Appendix A.3.2.

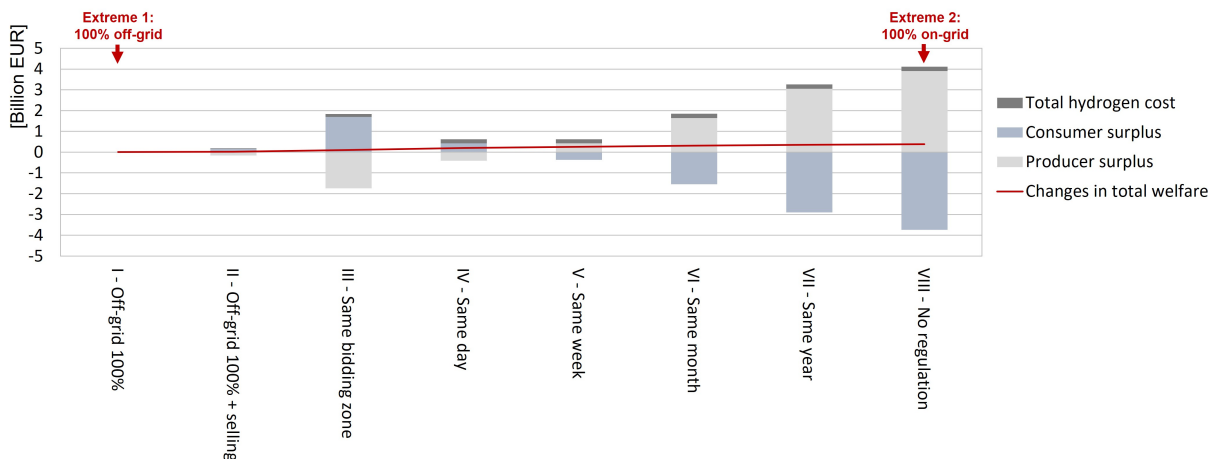

Figure 2.6: Effect of regulation on total welfare

Overall welfare increases with increasing levels of relaxation on the three dimensions. At maximum about EUR 0.4 billion in additional welfare can be achieved in the analysed year. The savings in hydrogen production costs for more relaxed regulation, translate directly to positive effects on welfare. For the unregulated case, where LCOHs are the lowest, gains of EUR 0.2 billion from hydrogen production contribute to the resulting overall welfare. The illustration also shows that the changes in consumer and producer surplus in the electricity sector are always opposed following similar absolute trends. While stricter regulation (II-IV) benefit consumers, more relaxed sourcing requirements (V-VIII) favour producers.

This can be explained by the interaction of hydrogen production with the electricity market and its resulting effect on electricity prices. As hydrogen producers are incentivised to size and operate their systems differently, depending on the stringency of the regulation, their interactions with the electricity markets also change, affecting electricity prices. Figure 2.7 shows that whereas stricter requirements (II-IV) reduce wholesale prices, more relaxed ones cause increases. Compared to the off-grid case, which again serves as reference, at maximum (III & VIII) prices fall by about 1.5% (1.2% over all considered market zones) and increase by 3.6% (3% overall). The shift from lower to higher prices occurs between daily and weekly balancing requirements, which is aligned to the change in signs between consumer and producer surplus in the power sector (Figure 2.6). Consequently, decreases in wholesale prices reduce the burden for the consumers whereas increases benefit producers through additional rents.

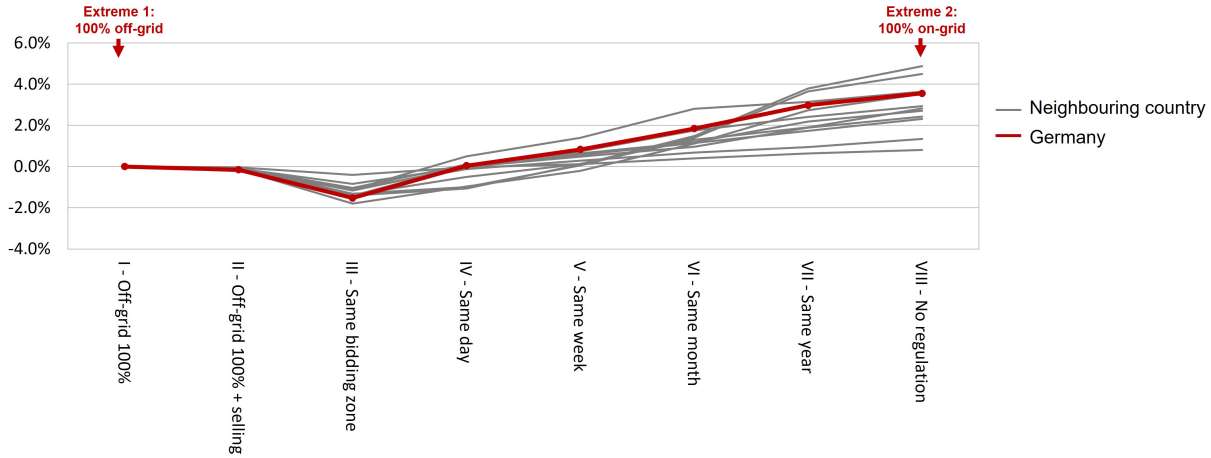

Figure 2.7: Effect of regulation on electricity prices

For regulation with stricter conditions on the temporal dimension²², hydrogen producers are incentivised to oversize the capacities of the renewables to minimise LCOHs. The oversizing of the generation capacities results in surplus electricity that is injected into the grid to generate additional revenues. As shown by the net power exchanges between hydrogen production and the electricity market (Figure 2.8a), 17 TWh of surplus electricity are added to the power market for the strictest analysed temporal matching (hourly). The injection of the renewable surplus electricity replaces some thermal generation at higher marginal costs, causing the observed reduction in electricity prices.

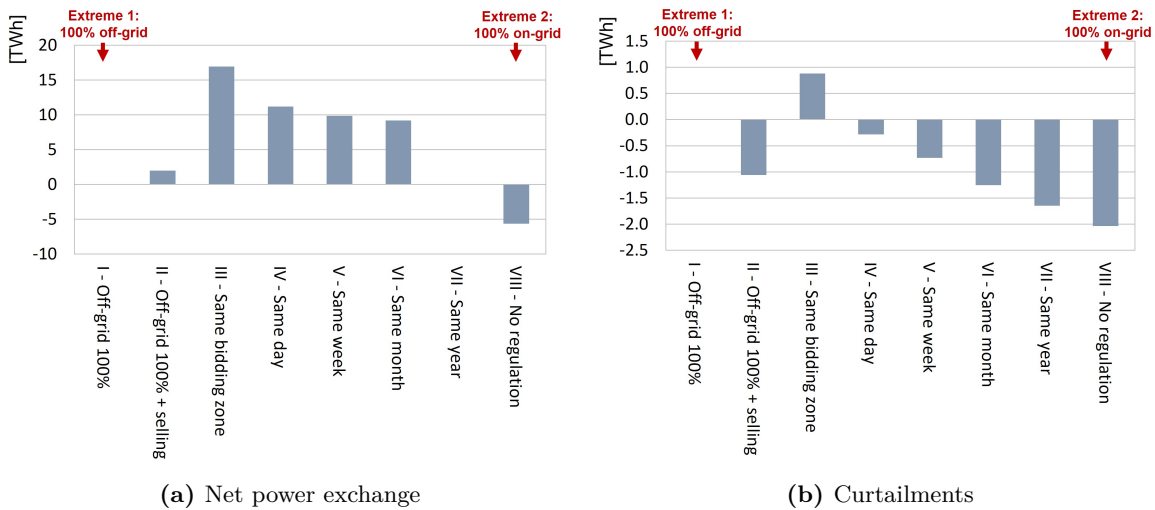

Figure 2.8: Effect of regulation on the interaction between hydrogen and the power sector

However, in addition to the reduction in electricity prices, the injection of surplus electricity also results in increased amounts of curtailed renewable electricity in the system (Figure 2.8b). With loosening requirements on the temporal conditions, more flexibility is given to the operation of the electrolyzers, resulting in renewable energy installations that are less oversized. Consequently,

²² But with trade possibilities.

fewer amounts of surplus electricity are available (e.g., 10 TWh for V). Moreover, the additional operational flexibility given to the hydrogen producers allows them to react to price signals in the market. They can thus benefit from periods with low prices to source electricity. As this is mostly the case during times when the share of renewable electricity in the system is high, the integration of the technologies improves as reflected by the decreasing amounts of curtailed electricity. From the weekly balancing level onwards (V-VIII), the market price-reducing effects of the injected surplus electricity are completely absorbed by the additional operational flexibility of the electrolyzers. Despite the injections of substantial surplus electricity (9 TWh), suggesting continued declines in electricity prices, electricity prices rise compared to the reference case. Relaxing constraints further, continues to reduce surplus. At an annual balancing condition (VII) the renewables are then sized just sufficiently enough to meet the sourcing requirements, so that the net exchange with the power system is zero. When there is no regulation implemented (VIII), the net exchange flips sign and becomes negative. In this case, the capacity of dedicated renewables is not sized sufficiently to supply all electricity demand for the hydrogen production. Instead, about 6 TWh of electricity are sourced from the grid, which corresponds to 14% of the required electricity. The remaining part, however, is supplied by dedicated renewables installed by the hydrogen producers. The amounts of curtailed electricity in the system reduce further in this case.

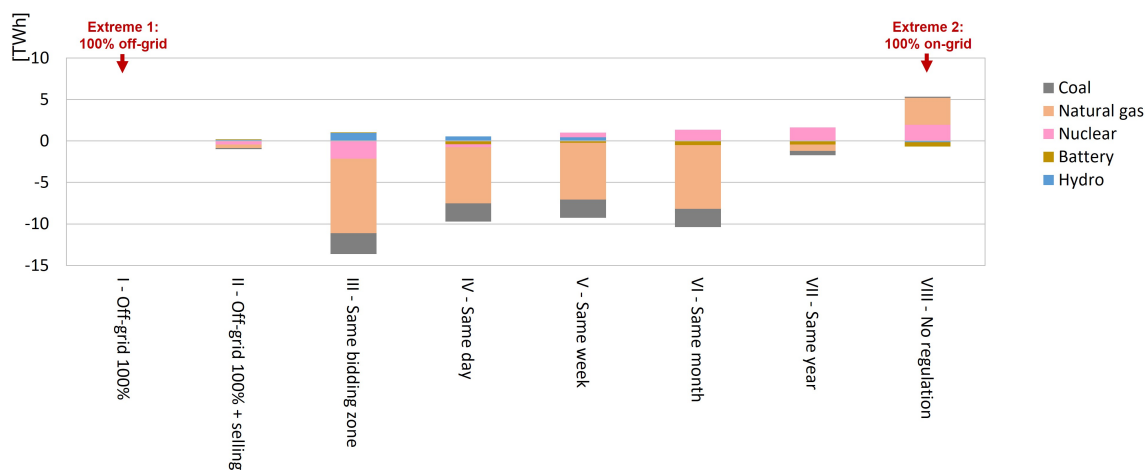

Figure 2.9: Effect of regulation on power generation

Figure 2.9 shows the changes in the generator dispatch at the electricity market that results from the various degrees of regulation. The overall changes are aligned to the pattern of the net power exchanges from the hydrogen production. For regulation that result in surplus renewable electricity from the hydrogen production, the dispatched volumes of generators in the electricity market decrease. The replacement mostly affects natural gas and hard coal-fired power plants. In the case of very strict time restrictions, electricity generation from nuclear power plants is also reduced. However, once regulation are more relaxed on the temporal dimension, nuclear power plants benefit from additional utilisation. If there is no regulation, the amount of electricity supplied by natural gas-fired power plants also increases. The same holds for hard coal-fired power plants. Their changes in volumes, however, remain relatively small. The dispatch of other technologies is only

affected to a minor degree by the regulation.

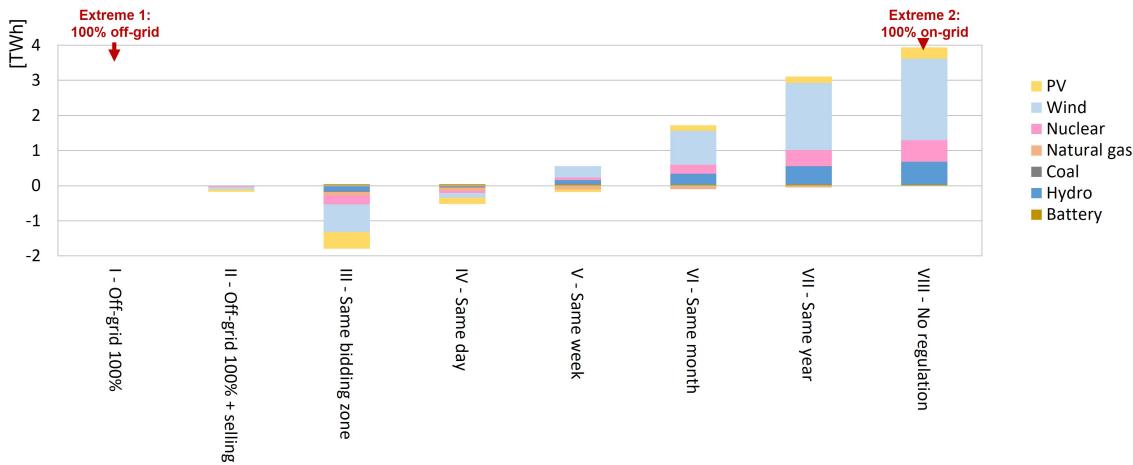

Figure 2.10: Effects of regulation on producer rents

The effect of the regulation on the producer surplus is further detailed in Figure 2.10. While declining market prices result in losses for the producers, increases in prices mostly cause additional gains. The individual technologies, however, are affected differently. This results mostly from their position in the merit order, and thus their ability to capture rents at times when market prices are set by the marginal costs of more expensive producers. As the power system in 2030 is dominated by renewables, changes in electricity prices also mostly affects their rents (65%-80%²³). This is further amplified by their low marginal costs compared to fossil generators, allowing them to benefit from their price-setting roles. Thermal generators account only for small changes in total producer rents, where nuclear power plants take the biggest share. The rents of generation technologies with higher marginal costs such as power plants fired with natural gas, hard coal or lignite, are hardly affected. As they are mostly the price setting technologies during periods when they are dispatched, possibilities to capture rents from the energy-only market remain low.

2.5.3 Effect of regulation on CO₂ emissions

Figure 2.11 shows the effects on the CO₂ emissions at the system level. The assessed regulation are compared to the case where the production and supply of electrolytic hydrogen is not considered. As the hydrogen production in the 100% off-grid case (I) takes place completely separated from the overall power system, the CO₂ emissions are not affected. In all cases, however, where the hydrogen production interacts with the wider power system (II-IX) overall CO₂ emissions are affected. The changes are aligned with the changes in electricity generation as shown in Figure 2.9. For all cases where regulation is in place (II-VII), the hydrogen production results in lower emissions. Their contributions, however, differ with respect to the amount of CO₂ they avoid. Emission savings are maximised when the spatial dimension is relaxed, and the temporal correlation remains strict (III). In this case the savings reach about 5 Mt of CO₂ per year. As further relaxations on the temporal dimension (IV-VII) replace less fossil generation, fewer emissions savings are achieved. However,

²³ In this case only solar PV, onshore and offshore wind.

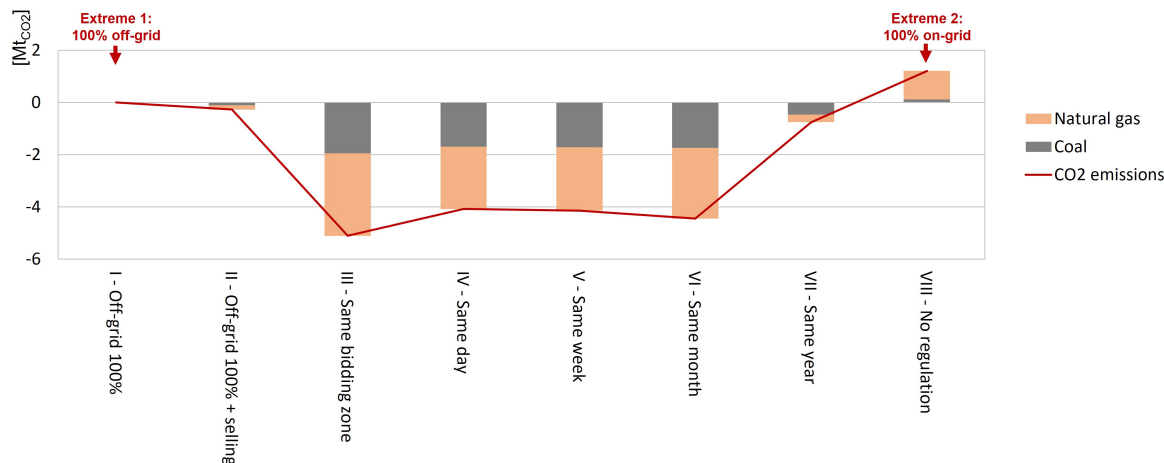

Figure 2.11: Effect of regulation on CO₂ emission at the system level

while the savings reduce for the daily and weekly matching, at monthly balancing (VI) they slightly increase again before they drop significantly. The reason for the slight increase results from both the injection of substantial surplus electricity and the operational flexibility given to the electrolyzers that improves the integration of electricity from renewables and nuclear in the markets, both of which do not cause additional emissions. For the annual matching overall CO₂ emissions are still lower but the absolute savings remain small (0.24 Mt_{CO2}). A complete absence of regulation results in an increase in total system emissions of 1.2 Mt_{CO2}. Independent of the analysed regulation, natural gas fired generators are the main contributors to the changes followed by hard coal fired power plants.

Beside the effects of different regulation on CO₂ emissions at the system level, the regulation also affect the CO₂ content of the produced hydrogen as shown in Figure 2.12. While in the off-grid settings (I-II) all sourced electricity comes directly from the renewable facility, so that the CO₂ intensity of the produced hydrogen is zero, the CO₂ content of the hydrogen increases in all cases where the electricity is transported through and sourced from the grid (III-VIII). It varies between 0.5 and 1 kg_{CO2}/kg_{H2}. Consequently, as illustrated in the figure, for all analysed cases the CO₂ intensity remains below the current EU threshold for low-carbon hydrogen²⁴ of 3 kg_{CO2}/kg_{H2}. Except for the unregulated case, the values also fall below the CO₂ content of blue hydrogen (1 kg_{CO2}/kg_{H2}). The improved integration of zero-emitting power generation in the case of the monthly regulation is also reflected in the CO₂ intensity of the produced hydrogen. Hydrogen producers benefit from hours of low electricity prices set by renewables and nuclear power plants to source electricity.

Combining the information on both the CO₂ intensity of the produced hydrogen and the CO₂ emissions at the system level provides additional insights. It shows that the EU threshold of 3 kg_{CO2}/kg_{H2} does not necessarily result in overall reductions of CO₂ emission. This is illustrated by the case where no regulation is in place. While the CO₂ content of the produced electrolytic hydrogen is at 1 kg_{CO2}/kg_{H2} and hence, below the threshold, overall emissions in the power sector

²⁴ EP (2018) 70% greenhouse gas emission reduction compared to fossil fuels - Benchmark 10 kg_{CO2}/kg_{H2} for hydrogen produced in the conventional SMR processes without CCS.

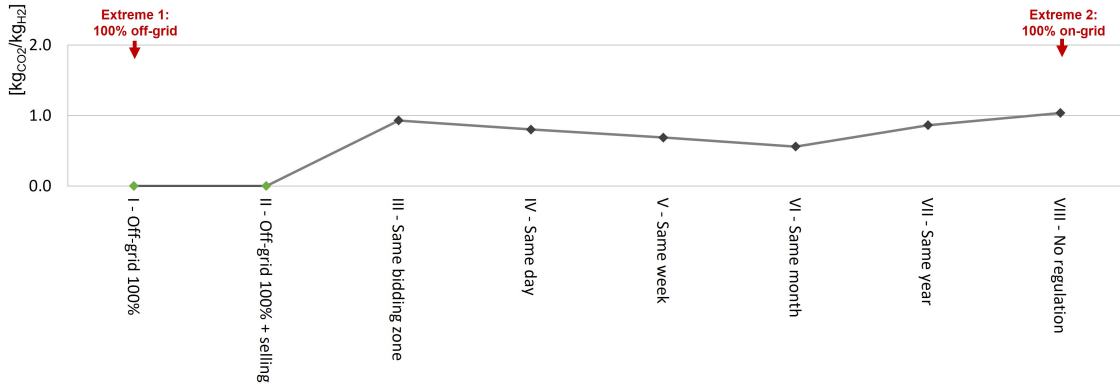

Figure 2.12: Effect of regulation on the CO₂ intensity of the produced hydrogen

increase by 1.2 MtCO₂.

2.5.4 Trade-off between environmental integrity and economic viability

Figure 2.13 shows the outcomes of the above analysis summarised by the Pareto front between changes in welfare and the resulting changes in CO₂ emissions at system level. All analysed regulation are expressed as the difference to the 100% off-grid case (I). It can be seen that strict regulation (both off-grid cases – I & II) neither lead to optimal outcomes with respect to CO₂ emission reductions nor in terms of welfare. The other assessed regulation, however, represent the trade-off between environmental integrity and economic viability as depicted by the Pareto front. While stricter regulation reduce CO₂ emissions, looser one’s favour welfare. The monthly balancing, however, represents a little exception to the pattern among the analysed regulation, due to the slight additional reduction in CO₂ emissions compared to the daily and weekly balancing.

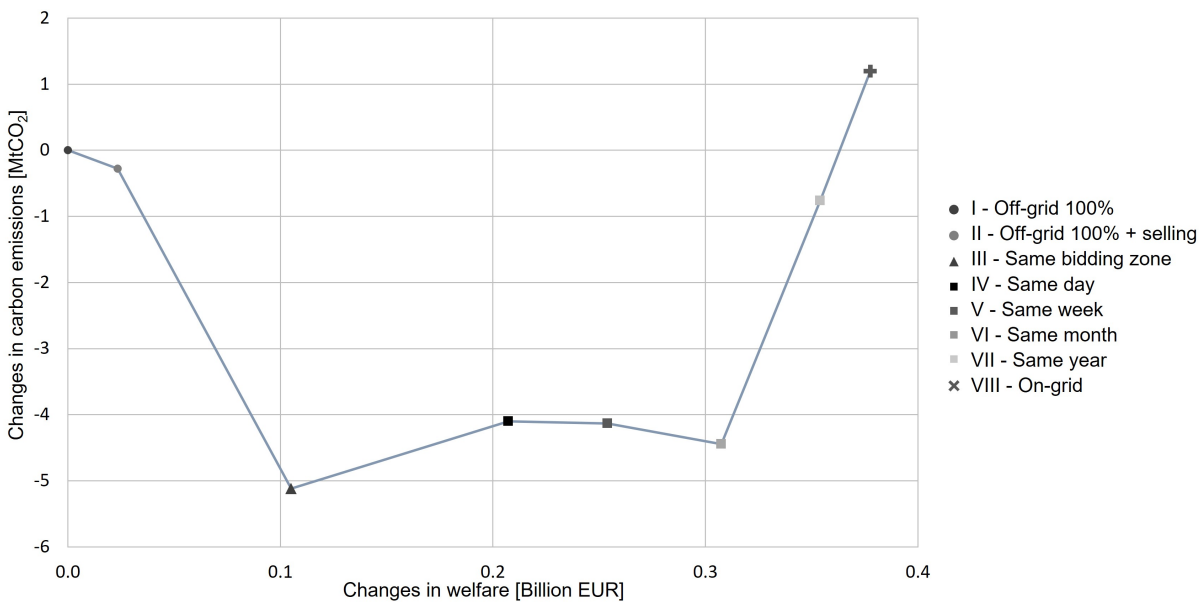

Figure 2.13: Pareto frontier between changes in welfare and changes in CO₂ emissions

2.5.5 Trade-off between environmental integrity and economic viability | Advanced energy transition

After Russia's invasion of Ukraine, the EU and its member states, among other Germany, increased the level of ambitions with respect to the speed of the energy transition. To tackle potential shortages in natural gas supply and to counteract the resulting high prices, additional substitution of natural gas demand (e.g., heating sector) through electrification is targeted. This is expected to increase electricity demand substantially. At the same time, the aimed contribution of renewable electricity in the power sector is lifted. In this second scenario we assess the effect on the regulation for the production of electrolytic hydrogen, when the latest announced ambitions are fully achieved on time and the corresponding economic drivers (e.g., commodity prices) evolve correspondingly. While the overall analysis is provided in Appendix A.1.4, in this section the summary of findings in the form of a Pareto frontier is presented (Figure 2.14), which is contrasted to the results of the base case of the first scenario as introduced above (Figure 2.13).

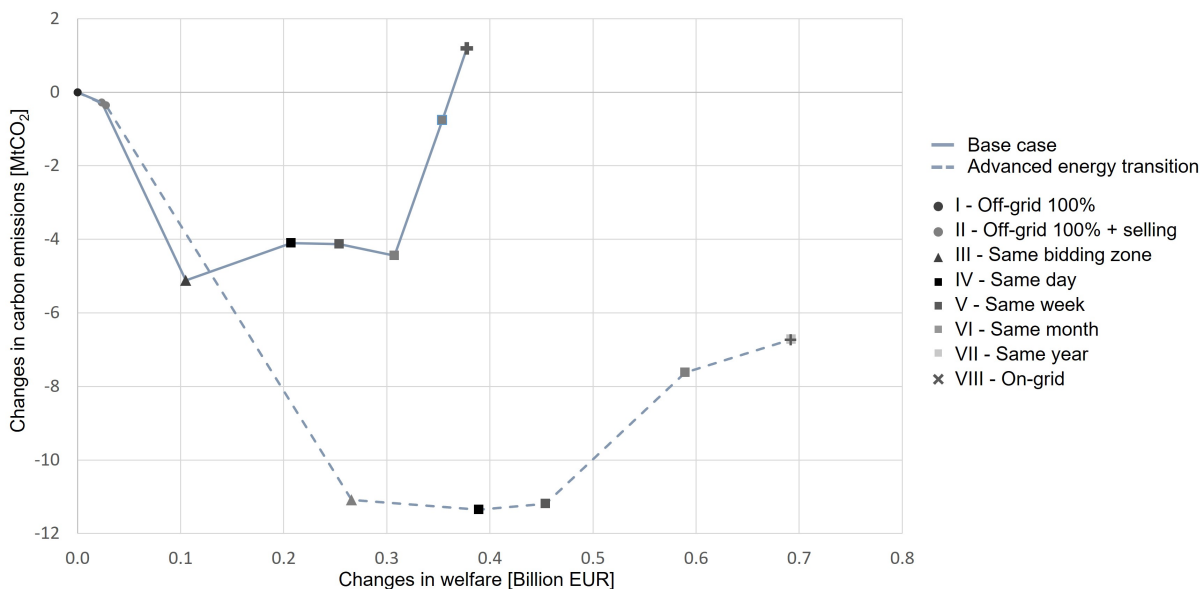

Figure 2.14: Pareto frontier - Comparison of base case against advanced energy transition

One sees that the curve is shifted towards the lower right corner. Consequently, regulatory relaxations from the strictest case (off-grid) result in both improving welfare and additional CO₂ emission savings. This holds for all other assessed regulation and also for the case where no regulation is implemented, which results in the same system configuration as the annual matching (VII). As the lower costs of renewables meet the more expensive generation costs of fossil power plants in this scenario, their relative competitiveness increases. Consequently, hydrogen producers avoid consuming electricity when prices are set by fossil generators and instead prefer to add additional renewable capacity.

2.6 Discussion

Our analysis shows that the implementation of potential regulation for the production of electrolytic hydrogen have different effects on the hydrogen supply costs, on total welfare and on CO₂ emissions. We find that stricter regulation generally lead to beneficial environmental effects, while looser ones improve hydrogen supply costs and total welfare. However, too strict regulation that require the hydrogen production in island systems result neither in optimal outcomes in terms of CO₂ emissions nor in terms of welfare gains.

Although regulation affects hydrogen production costs, the effect is small. Our results show that hydrogen costs drop by only 7% between the strictest and the most relaxed regulation. Relaxation of the temporal correlation, what most current discussions focus on, account for only 2% of the reduction in costs. The concerns of the hydrogen industry, that too strict regulation reduces the competitiveness of electrolytic hydrogen and hinders the successful development of the hydrogen industry, are not corroborated by our analysis. However, we find that regulation still impacts important broader economic aspects at the system level such as the resulting CO₂ emissions, the integration of renewable electricity into the system and further welfare considerations such as the surplus distribution between actors in the electricity markets. This highlights the importance of their careful assessment and consideration. It also suggests that future analysis on regulatory aspects should therefore not focus narrowly on hydrogen production costs such as previous studies (Ruhnau and Schiele 2022; Schlund and Theile 2022), but also take into account broader economic aspects.

With respect to the distribution of welfare effects among the actors in the electricity markets, we see that stricter regulation of the temporal correlation lowers electricity prices, which favours consumers. On the contrary, looser regulation increases electricity prices, benefitting the rents of producers. Against the backdrop of the Russian invasion of Ukraine and the aftermath of the energy crisis, policy-makers aim at reducing the burden of high energy costs on consumers. Different possibilities such as price caps are being discussed and have partially been implemented. Our results show that the production of electrolytic hydrogen and corresponding choices of regulation are further levers to affect electricity prices and help relieve financial burden for consumers. We find, however, that changes in wholesale prices mostly affects rents of renewable energy generators. Consequently, when electricity prices drop, the market values of the technologies reduce with the drawback that their profitability decreases. Further financial support may thus be required to keep capacities of renewables growing. By contrast, as looser regulatory requirements increase electricity prices, the rents of renewables in the market rise. The increase in market values of renewables due to flexibly operating electrolyzers is also found by Ruhnau (2022) and confirms the findings of the author.

In this respect the consideration of hydrogen storage also plays an important role and drives the results of our analysis. Even if hydrogen demand requires a constant supply of volumes, hydrogen storage technologies offer viable possibilities to decouple hydrogen production from its supply in time. This temporal decoupling technically allows the production of hydrogen to be flexible and to follow generation patterns of viable renewables to benefit from electricity at low costs. Even in the unrestricted case, storage capacity is installed, which proves the viability and the value of the storage technologies.

The operational flexibility of hydrogen production, enabled primarily by hydrogen storage capabilities, is an important consideration with respect to the choice of the strictness of regulation. The focus of the political discussion on the temporal regulatory dimension seems therefore valid. In power systems with increasing shares of variable renewables, limited demand side flexibility results in rising economic curtailments that present welfare losses. As electricity demand in the power sector is rather inelastic, the production of hydrogen therefore has the possibility to offer valuable flexibility to the system. While this operational flexibility is important in either of the analysed regulation, its value increases for less constrained requirements on the temporal dimension. It does not only increase electricity prices and thus increase rents for renewables, but it also reduces curtailments of renewable electricity and hence, contributes to a better system integration of the technologies. Whereas the studies of Ruhnau and Schiele (2022) and Zeyen, Riepin, and Tom Brown (2022) focus on the distinction between hourly and annually matching, our study shows that there is value in assessing also intermediate steps. We see that the balancing at monthly levels is a good compromise in the trade-off between environmental integrity and economic viability. It ensures the reduction of CO₂ emission in the system, while giving the hydrogen production sufficient operational flexibility to increase welfare through reductions in hydrogen production costs and the improved integration of renewable electricity into the power system. These outcomes are aligned to the current conditions on the temporal dimension set by the European Commission within the Delegated Act (EC 2023a), which require the renewable electricity to be generated within the same month as it is used to produce electrolytic hydrogen.

However, while the EU commission envisages to tighten the requirements to a more restrictive temporal correlation (hourly matching) in the mid and long-term, our results do not show evidence that more restrictive conditions increase overall environmental performance or economic welfare. Instead, our results suggest that with a progressing energy transition, the need for stricter regulation vanishes. Regulation might even be superfluous at some point, as the most climate-friendly option to provide electricity for the hydrogen production is also the most economical one - renewable electricity. In this context our findings indicate that the need for regulation is dependent on the evolution of the relative costs of renewables and fossil fuels in power generation. This cost competition, however, is influenced by the interplay of various factors such as the evolution of prices for fossil fuels and for CO₂ allowances, as well as the generation costs of renewable electricity. Moreover, the cost evolution for hydrogen technologies also plays an important role. The current situation in the energy sector and more broadly in the global economy shows that there are significant uncertainties on how these parameters will evolve in the coming years. Driven by geopolitical tensions, fossil fuel prices saw record highs in the past two years massively affecting national economies. Moreover, shortages in the supply of materials and labor, supply chain disruptions, and higher financing costs as a result of inflation, put pressure on the cost of additional renewables. Despite expectations of further cost declines in the years to come, due to the massive upscale of capacities globally, the costs for renewables have actually increased in 2022 (IEA 2022b). Driven by the current global situation, new investment waves have been triggered in the supply of both fossil energy and renewables as well as in energy efficiency measures. As the effects of these investments on the competition between renewable and fossil electricity remains highly uncertain in the mid-term, regulation for the production of

electrolytic hydrogen remains advised. This is also supported by the evidence of minor losses in welfare from potential unnecessary regulatory intervention.

While the regulatory debate mainly focuses on the temporal dimension, less attention has been paid to the geographical aspects. Our analysis shows that a regulation that allows the installation of renewables in other bidding zones only slightly changes the outcome. Whereas CO₂ emissions and overall welfare remain at comparable levels, the greatest difference occurs in hydrogen production costs. When allowing for installations of renewables in other bidding zones, less than 10% of the capacity is located abroad with the biggest share being allocated abroad when regulation is strict on the temporal dimension (hourly correlation). The differences in hydrogen production costs are the biggest in this case.

Previous studies do not assess relaxation of the geographical dimension (i.e., not considering installations of renewables in other bidding zones), our results support what the EU proposed in the Delegated Act (EC 2023a).

The general possibility of using electricity from renewable sources in other bidding zones does not lead to overarching advantages. The EU therefore rather defines some additional requirements that the planned location of renewables must fulfill to be eligible. These include conditions such as on the market prices and their deviations between the two bidding zones. An assessment of these requirements with regards to their effectiveness in the trade-off between environmental integrity and economic viability, however, is beyond the scope of this study and provides directions for further research.

This study focuses on the provision of electrolytic hydrogen for the German industry, as the industry is considered one of the first sectors to use low-carbon hydrogen at a large scale. Including other end uses to the analysis such as the transport sector, could provide additional insights, as the hydrogen supply structure is different from the one in the industry. An analysis of other countries can also lead to interesting insights, as the composition of the generation fleet and the interconnections with neighbouring market zones can be very different. This is also the case for the competition between renewable and fossil-based electricity, which can be affected by national conditions such as different financing costs. Both aspects offer starting points for further research to gain a better understanding of the effects of regulating electrolytic hydrogen production. Moreover, the focus of the work was set entirely on a market level. Consequently, resulting power flows and potential effects on grid congestions caused by the analysed regulation are not addressed. The same holds for the consideration of a dedicated hydrogen infrastructure. We assume that neither dedicated pipelines nor large-scale hydrogen storage facilities are available by 2030. Both aspects provide further research directions and extensions of the applied methodology.

2.7 Conclusion

Electrolytic hydrogen is expected to be a key element in achieving the EU's climate ambitions, complementing the concept of direct electrification through renewables. However, it is argued that its production comes with a trade-off between environmental integrity and economic viability. Prioritising environmental aspects could hinder the timely development of a hydrogen economy, while

favoring economic aspects may impair the success of the decarbonisation process. The recognition of electrolytic hydrogen as a homogeneous good does therefore not seem appropriate, which requires the introduction of clear definitions and regulation. Policy-makers around the world are now framing the conditions for the production of electrolytic hydrogen. These need to be well conceived to contribute to the wider goals and to provide a sound basis for an informed decision making by private investors.

In this study, we analyse the effect of various possible regulatory designs on hydrogen supply costs, total welfare and on CO₂ emissions for the case of Germany in 2030. The analysed regulation is based on the three dimensions that frame the ongoing discussions: (1) the origin of the electricity, (2) the geographical correlation and (3) the temporal correlation of electrolysers and renewables. Different levels of relaxation on the three dimensions are considered and included in the analysis which relies on the deployment of a detailed electricity market model.

We find that strict requirements generally benefit environmental aspects, while loose conditions favour hydrogen production costs and total welfare (not accounting for the environmental costs). However, too strict regulation that only allows for the sourcing of renewable electricity generated in off-grid systems does neither result in optimal economic nor optimal environmental outcomes. Our results therefore confirm the trade-off between environmental integrity and economic viability. The concerns of the hydrogen industry of high costs caused by too restrictive regulation cannot, however, be corroborated by our analysis, as differences in hydrogen production costs between different regulatory designs are moderate. Nevertheless, broader economic aspects that consider effects at the system level play an important role. The results show that stricter requirements result in substantial surplus renewable electricity, replacing some fossil generation (and reducing CO₂ emissions) and decreasing electricity prices and hence, benefitting consumers. Both aspects, the reduction in natural gas demand and the financial relief of consumers, are very relevant in the context of the current geopolitical situation and the energy crisis in the EU. In looser regulatory cases, it is the other way round. However, less constrained regulation provides value to the wider power system by unleashing operational flexibility of the hydrogen production. Hydrogen storage technologies play an important role in the temporal decoupling of hydrogen production and supply. The incentive of hydrogen producers to maximise profits through the purchasing of low-cost electricity in times of high shares of renewable electricity fosters the grid-integration of these technologies. Moreover, loose regulation results in less curtailment of renewable electricity while electricity prices are lifted. As such, the profitability of renewables increases which may reduce the need for public financial support.

We conclude that when designing regulation, policy-makers must strike a careful balance between environmental and economic aspects to neither harm the decarbonisation process nor cause economic inefficiencies. Our results generally support the conditions on the temporal dimension for the production of electrolytic hydrogen set by the EU within the second Delegated Act. These conditions require the renewable electricity to be generated within the same month as it is used in the electrolysis process. This regulatory choice gives confidence that overall CO₂ emission in the system do not increase by the hydrogen production, but that sufficient operational flexibility of the hydrogen production is offered to the power system to improve the integration of additional

renewables. Our results are also in line with the requirements defined by the EU in terms of the geographical dimension. The possibility to generally install renewables for the production of electrolytic hydrogen in other bidding zones does not lead to additional gains. In an alternative scenario, with accelerated expansion of renewables and a sharp drop in renewables' generation costs, we found that the observed trade-off between environmental integrity and economic viability diminishes. The reason for this is that, in our alternative scenario, renewables are the most environmentally friendly as well as the most economic option to produce electrolytic hydrogen. Whether to regulate hydrogen production at all is therefore also a question of how quickly renewables can be installed and how fast their relative costs continue to fall. We find that the adverse effects of unnecessary regulation are moderate in our alternative scenario and therefore recommend erring on the side of caution and regulating electrolytic hydrogen production at least for a transitory period.

Chapter 3

Empowering system operators in the production of electrolytic hydrogen - Less vertical unbundling for more welfare?

Contribution

Conference presentations:

- 9th Conference on the Regulation of Infrastructures - Sector Coupling FSR, 2019, online
- Journées des doctorants JDD, PSL Research University, 2022, Paris

Abstract

Increasing shares of renewables cause new challenges in the structure and in the operation of power systems. Due to the intermittency and the decentralized locations of renewable energies, the balancing of demand and supply as well as the transportation and distribution of power through the system become more difficult. Current markets with uniform prices are poorly prepared to handle these new challenges resulting more frequently in structural congestions and curtailments of renewable. Grid expansion is the straightforward and mostly the envisaged solution to address structural network congestions. Administrative burdens, missing public acceptance and long lead times, however, often hinder a timely expansion of the grid. If well-located and operated in a system beneficial way, the production of electrolytic hydrogen through electrolyzers, can help to accommodate renewables to the system and to reduce total integration costs.

In this study, a modelling framework consisting of three optimisation models is applied to assess for the case of Germany in 2030 whether relaxations of current unbundling rules allowing transmission system operators to be involved in the placement and operation of electrolyzers can increase system efficiency and reduce total costs. We find that even a moderate lifting of the current regulatory framework reduces the congestion management needs by 50% and decreases CO₂ emissions by 900 kt per year. Given the current economics of electrolyzers, which still requires financial support to create business cases, the risk of harm to competition is limited, suggesting to further assess possibilities such as regulatory sandboxes for a temporal empowerment of network operators in the locational choice of electrolyzers.

Résumé

L'augmentation de la part des énergies renouvelables pose de nouveaux défis dans la structure et dans l'exploitation des systèmes électriques. En raison de l'intermittence et de la décentralisation des énergies renouvelables, l'équilibre entre l'offre et la demande ainsi que le transport et la distribution de l'énergie à travers le système deviennent plus difficiles. Les marchés de l'électricité, avec des prix uniformes au sein de chaque pays, sont actuellement insuffisamment préparés pour répondre à ces nouveaux défis, ce qui entraîne plus fréquemment des congestions structurelles et une moindre utilisation des énergies renouvelables. L'expansion du réseau électrique est souvent considérée comme la solution la plus simple pour résoudre ces congestions structurelles, mais les formalités administratives, le manque d'adhésion du public et les délais de mise en œuvre prolongés entravent et retardent souvent son expansion. La production d'hydrogène par électrolyse se présente comme une alternative pour contribuer à l'intégration des énergies renouvelables ainsi qu'à la diminution des coûts globaux du système énergétique, à condition d'être placée judicieusement.

En utilisant des modèles d'optimisation, cette partie se concentre sur l'étude de l'impact de l'implication des gestionnaires de réseau dans les décisions du choix de placement et de l'exploitation des électrolyseurs dans le cadre d'un assouplissement de la législation actuelle. L'objectif est de déterminer si leur implication peut augmenter l'efficacité du système et réduire les coûts d'opération. Dans le cas de l'Allemagne en 2030, même un assouplissement modéré du cadre réglementaire actuel, autorisant dans une certaine mesure l'implication des gestionnaires de réseau aux processus de décision quant placement des électrolyseurs, permet de réduire les congestions de 50% et diminue les émissions de CO₂ de 900 kt par an. Etant donné qu'en l'état actuel, les électrolyseurs nécessitent un soutien financier public pour être viables, le risque de nuire à la concurrence est limité, ce qui suggère d'approfondir les études quant à de possibles aménagements réglementaires pour accorder temporairement aux opérateurs de réseau un pouvoir accru dans le choix de localisation des électrolyseurs

3.1 Introduction and motivation

With the “European Green Deal” (EC 2019)¹, the European Union has set itself the ambitious target of achieving climate neutrality by 2050. The integration of renewables into the energy system has proven the ability to contribute to this challenge. The installed capacity of solar PV plants and wind turbines has increased rapidly around Europe over the last decade. However, their integration leads to new challenges in the operation of power systems that were initially conceived to be fed by centralised power generation. Often the most favourable sites to exploit renewable resources differ from both current generation locations and the main demand centres. Changes in the position of generators within the network result in changing power flows leading to transmission bottlenecks and congested power lines. As a result, in an increasing number of hours renewable infeed needs to be reduced due to grid constraints, which is also referred to as curtailment². Such generation curtailment entails welfare losses. Grid expansion is the most straightforward and often the only envisaged solution to address structural network congestion. Administrative burdens, lack of public acceptance and long lead times, however, often prevent a timely expansion of power grids. This is an increasingly observed phenomenon (IEA 2021b). One of the most prominent cases in this context is the situation in Germany. While locations with beneficial wind conditions are located in the north of the country, the main demand centres are in the centre and in the southern part of Germany, where most centralised power generation used to be installed. Consequently, as the transmission grid on the north-south axis of the country is not sufficiently suited yet to integrate additional volumes of wind electricity in the north, the amount of curtailed electricity has increased. Between 2014 and 2019, it raised from 0.6 TWh to 6.5 TWh and cost around one billion Euros for its compensation (BNetzA 2021). The main drivers for the rising amounts of curtailed electricity and the resulting welfare losses are, on the one hand, a lack of locational signals within the bidding zones and, on the other hand, delayed grid expansion.

Driven by innovations and ambitions for widespread electrification, the concept of sector coupling offers new opportunities to meet these challenges. Sectors such as heating and transport, which have so far mostly been treated separately from the electricity system, are gradually being electrified. While their electrification creates additional electricity demand, these new loads can also provide valuable flexibility to power systems. An effective integration of these sectors can therefore help to better integrate renewable electricity by reducing grid congestion. These potential welfare gains suggest a review and possible adaptations of current market designs.

The production of hydrogen through electrolyzers is a prominent enabler of sector coupling. In this process, electricity is used to split water into its constituents hydrogen and oxygen. The physical characteristics of hydrogen (e.g., storage, transport, balancing over time) allow it to complement the drawbacks of other supply options envisaged crucial in the energy transition, such as the direct electrification with renewable electricity. Clean hydrogen therefore offers promising possibilities in the decarbonisation of processes. This has been recognised by the European Commission and its member states, that consider electrolytic hydrogen to be a central element of the European

¹ Put in law in 2021 with the European Climate Law (EC 2021).

² Curtailments are part of redispatch measure.

energy transition (EC 2020). Fossil fuel replacement in industry and transport is seen as the main application for electrolytic hydrogen. Its demand in Europe is therefore expected to increase manifold by 2050 (Deloitte 2021; FCH JU 2019). As a result, significant additional electricity demand will be added to the power system offering substantial flexibility to it. However, electrolyzers do not necessarily improve the operation of power systems. If they are not located and operated in a system supportive way, they might even amplify congestion and increase integration costs of renewables. Moreover, several studies show that merchant electrolyzers still require support schemes to ensure profitability (Glenk and Reichelstein 2019; IEA 2019c).

Adapting regulatory frameworks for the effective integration of renewables and the large-scale introduction of electrolyzers are top priorities of the policy agenda. Because of their lifespan, investments in these technologies, however, have long-term impacts on the entire energy system that can lead to economic inefficiencies if they are poorly designed. Therefore, this study contributes to the discussion of appropriate market designs for the integration of electrolyzers that could both enable a better integration of renewables and promote their efficient deployment to reduce costs and increase their values. This analysis focuses on the case of Germany, which is a well-suited case study due to its ambitious CO₂ emission reduction goals, its power network challenges, and the envisaged expansion of electrolytic hydrogen.

The remainder of the paper is structured as follows: Section 3.2 gives an overview of the relevant literature. The methodology and the modelling framework are then introduced in Section 3.3, which is followed by a description of the data used (Section 3.4). Next, the modelling results are presented and discussed (Section 3.5 and Section 3.6). Section 3.7 concludes.

3.2 Background and literature review

The integration of electrolyzers into electricity markets has been the subject of several recent studies. Roach and Meeus (2020) use a complementarity problem formulation to study a coupled system of the electricity and gas sectors. They use a stylised model to represent the two connected sectors. The authors assess both the incentive for different actors to invest in electrolyzers and the distribution of social welfare in such coupled system. They find that both sectors have an aligned incentive to invest in electrolyzers. However, they highlight that a welfare optimal electrolyser capacity results in a loss for hydrogen producers. Ruhnau (2022) uses an electricity market model to assess the effect of electrolyzers on the market value of renewable energy technologies for the case of Germany. The author finds that the profitability of renewables benefits from the integration of electrolyzers in the market. The latter two studies only assess their integration in uniform market zones ignoring spatial aspects within the considered geographical scope.

However, the importance of spatial considerations in energy systems with high shares of renewables are highlighted by Schroeder et al. (2013) and Ardian, Concettini, and Creti (2018) in the broader context. Schroeder et al. (2013) assess the impact of future wind energy expansions in the north of Germany on the power system and on congestion. They point out that grid reinforcement is required to meet growing capacity needs between demand centres and generation sites. Ardian, Concettini, and Creti (2018) apply two econometric models to assess whether renewables increase

the occurrence of grid congestion. According to their findings, grid congestion can be reduced through measures such as regional incentives for renewable energy technologies, grid expansion or an increase of demand in exporting regions. Sector coupling technologies are identified to serve the latter purpose.

Some other studies integrate spatial aspects of electrolyzers to assess possible national pathways for the creation of hydrogen economies. While Emonts et al. (2019) and Robinius et al. (2017) are examples that focus on the case of Germany, Tlili et al. (2020) do a similar exercise for France. All the authors apply quantitative approaches considering high spatial granularities to analyse prospective national energy system configurations. They find that the positioning of electrolyzers might differ between a system-based and a market-based placement of the units. As they assess power markets with uniform pricing and without locational incentives, their results indicate that the market-based installations of electrolyzers can reduce system efficiency.

Vom Scheidt et al. (2022) analyse the integration of electrolyzers in the power system by comparing a uniform pricing market of Germany with a nodal pricing approach. The authors focus on the year 2030 and apply an electricity market model that is complemented by a hydrogen supply chain model to assess the interactions between power markets and hydrogen supply. They find that congestion management costs reduce by -24% through the change from a market with uniform pricing to one with nodal pricing. A similar assessment was carried out by Xiong et al. (2021). The authors focus on the German power system in the year 2015 and study the potential contribution of electrolyzers to redispatch. Electrolyzers are installed at grid nodes exposed to frequent curtailments of renewables. The units produce hydrogen that is blended into the natural gas grid and re-electrified at locations of gas turbines widely used for upward redispatch. In doing so, the authors find that 12% of curtailments are avoided, confirming the benefits of integrating electrolyzers to support the system.

To summarise, the findings of previous studies highlight the importance of locational aspects of electrolyzers to increase efficiencies of power systems with high shares of renewables. In this context, regulatory aspects, however, have so far hardly been addressed as acknowledged by vom Scheidt et al. (2022) and Xiong et al. (2021). In this regard, the literature discusses several possibilities to introduce incentives that foster both the installation and operation of system-beneficial power generation and consumption.

Vogel and Bauknecht (2020) propose a distinction between focused and unfocused options. While unfocused options expose all stakeholders (generators and consumers) to price signals without a choice of whether to participate, focused options send targeted location-based signals to stakeholders who can actively respond according to their willingness to contribute to the options. The group of unfocused options is further split into market-oriented and system-oriented ones. Market-oriented unfocused options propose to split markets with uniform pricing into smaller zones. The approach is also referred to as zonal pricing. An extreme case of it is the so-called nodal pricing approach, where each network node represents an individual market zone. In both cases, market participants are exposed to different prices according to their location. The aim of the approach is to create incentives in the individual market zone for system-beneficial investments on both the consumption and the generation side. Zonal pricing is implemented in countries such as Norway and Italy.

Examples of nodal pricing can be found in markets such as ERCOT and PJM in the US. According to the literature, nodal pricing represents the theoretical optimum to avoid structural congestion, which has been shown for different cases (Green 2007; Ozdemir et al. 2009; Weigt, Freund, and Jeske 2006). Such market-oriented options, however, also have drawbacks and are not necessarily optimal from a wider system perspective. An example are investments in generation capacity of renewables that could be made in locations with less favorable natural conditions. Furthermore, the economics of assets on both the supply and demand side could change once new transmission capacity comes online. This exposes investors to financial uncertainties and consequently, risks to their business models. For these reasons, but also because of the complexity of introducing such market concepts within the current institutional setup, the German government has so far rejected all possible options for splitting the market into different zones (BMW 2020a). The other group of unfocused options are the system-oriented focused ones, that correspond to flexible network tariffs. During periods of high network utilisation, actors are exposed to higher network tariffs, which in turn are meant to send locational signals and incentivise system-beneficial operations and investments. It is argued, however, that among others the actual impact of such implementations is highly uncertain and could lead to extreme burdens for some actors (BNetzA 2015). This option is thus considered unviable by the German government.

Focused options offer additional alternatives for locational signals to incentivise system-beneficial investments. The basic idea behind these approaches is that network operators enter into contracts with merchant participants that include corresponding obligations. Local flexibility markets are one option that has gained prominence in the current debate. These markets are operated in parallel with wholesale markets. Flexibility providers offer services that network operators acquire according to market principles. Financial compensation is paid to the designated flexibility provider, resulting in additional revenue streams offering corresponding business opportunities. Local flexibility markets are further distinguished by static and dynamic types. While in dynamic types, network operators purchase services each time the need for flexibility occurs, in static approaches, flexibility providers are designated over longer periods and are called every time network services are required. Various test projects around Europe are ongoing, seeking to obtain additional insights into the functioning of local flexibility markets. The ability of players to forecast network congestion, however, can result in opportunistic bidding practices. Actors might place bids on both wholesale markets and local flexibility markets in such way that they maximise their own profits at the expense of increasing total cost to society (Hirth and Schlecht 2018). This behaviour is also referred to as Increase-Decrease-Strategy or in short Inc-Dec-Strategy. While strategic bidding has already been observed in the UK (Perekhodtsev and Cervigni 2010), there are other examples, such as in Büchner, Beune, and Appen (2019), that showed little evidence of the presence of such behaviour. The latter argue that the risks of inadequate predictive accuracy of congestion discourage actors from adopting opportunistic practices. Other authors, such as Hirth, Maurer, et al. (2019), however, claim that the only reasonable way to prevent such opportunistic bidding behaviour is through pay-as-bid market clearing approaches. These approaches correspond to the cost-based redispatch currently implemented in many countries, including Germany. Consequently, they argued that the introduction of effective local flexibility markets does not offer any advantages over today's cost-based redispatch. Given the

above mentioned uncertainties on the efficiency of local flexibility markets, Vogel and Bauknecht (2020) suggest further research on these aspects. For the given reasons, the German government has so far rejected the implementation of local flexibility markets (BMW 2020a).

According to Bogensperger et al. (2017) there are a number of other possibilities. These belong to the group of focused options. One of them is the ‘operator model’. The idea of this concept is that grid operators own assets that are operated by third parties under market conditions. As transmission system operators (TSO) have full overview over grid flows and congestion, they can locate facilities such as electrolyzers in a system-supporting manner. Depending on the variant of this option, they might leave the operation to third parties while defining time windows during which merchants are contractually obliged to operate the system and thus relieve grid congestion. According to Vogel and Bauknecht (2020), this option presents a solution which is effective, cost-efficient, and relatively simple to be implemented with the main drawback of this option being the administrative burdens of putting together contracts between the involved actors. Under current unbundling rules TSOs are, however, neither allowed to own nor to operate generation and conversion units such as electrolyzers. Therefore, regulatory modification would be required to put these approaches into practice.

Given the advantages of the latter option, we examine the extent to which regulatory relaxations of current vertical unbundling rules would help to integrate electrolyzers in a system supportive way. We apply two variants of the option and compare them to a purely market-driven placement and operation of the units: (1) the first variant is the one described above, where TSOs place and own the units operated by third parties in the wholesale market. TSOs are allowed to force the merchants to operate the units in a system-supportive manner during times of forecast congestion. (2) The second variant is a moderate version of the first one, where the electrolyzers are only placed and owned by TSOs. Their operation, however, remains fully in the scope of market driven third parties. The question analysed in the study is whether the involvement of TSOs in the placement of electrolyzers and in the production of electrolytic hydrogen results in reductions of total system costs due to reduced grid congestion and a better integration of renewables. As system-beneficial installations of electrolyzers might cause additional transport and conversion needs to carry the produced electrolytic hydrogen from the production to the demand location, an analysis of the resulting supply costs is an important element within this assessment. Only if the extra-efforts of the additional transport and conversion requirements are offset by reduced costs in the power system, total system costs decrease and thus possibly justify relaxations of vertical unbundling rules.

3.3 Methodology and modelling framework

To assess the impact of relaxed vertical unbundling rules, we conduct a quantitative assessment similar to most approaches presented in the literature. In the analysis, we apply two variants of the operator model and compare them to a purely market-driven placement and operation of the units: (1) the first variant is the one described above, where TSOs place and own the units operated by third parties in the wholesale market. In addition, TSOs are allowed to force them to operate the units in times of forecasted congestion to support the grid. (2) The second variant is a moderate version of the first one, where the electrolyzers are only placed and owned by TSOs. Their operation,

however, remains fully in the scope of merchants. As both TSOs and merchants are involved in the two variants, they are referred to as 'hybrid' options. Further details on the two 'hybrid' options as well as on the purely market-based case, including their precise names, are shown in Table 3.1.

Name	Abbreviation	Ownership	Placement	Operation
Market	MAR	Merchants	Merchants	Merchants - fully market driven: Merchants source electricity freely from wholesale markets
Hybrid Market	HYM	TSO	TSO	Merchants - fully market driven: Merchants source electricity freely from wholesale markets
Hybrid System	HYT	TSO	TSO	Merchants - system support obligations during times of congestion: TSOs contract merchants to source electricity from the wholesale market in certain hours, during which curtailments are forecasted at the respective grid node. During all other hours, merchants source electricity freely from the wholesale markets

Table 3.1: Overview of the considered electrolyser placement and operation options / business models

The representation of the electricity sector in our assessment reflects the current regime of the European system, in which electricity is traded at short-term energy-only-markets. Each market represents one zone. The corresponding market outcomes result in both dispatch schedules of generators and wholesale market prices. Technical limits related to the power grid within each zone are not considered. It is assumed that electricity can flow freely between the actors (copper plate approach). However, this assumption might not always hold due to physical constraints in the topology of the system. The outcomes of the wholesale markets are therefore technically not always feasible. To avoid endangering system components by overloading them, the clearing of wholesale markets is followed by a congestion management step. Limits in the transmission system are identified first based on the resulting dispatch schedules of generators from the wholesale markets and information about the power system. They are then resolved through cost-based redispatch measures by the TSOs, in which the output of generators located before congested lines is reduced (downwards regulated) and that of generators behind the congested lines is increased (regulated upwards). The choice of units selected for redispatch is based on their generation costs as well as their effectiveness in resolving congestion. Cost-based redispatch therefore solves occurring network congestion in an economical manner. As a result, the selection of thermal generators is preferred due to their higher marginal generating costs. Only when their contribution is no longer available or justified, the output of renewables is reduced.

Figure 3.1 illustrates the modelling framework used to approach the research question. We apply three models in a consecutive order: (1) a stylised electricity market model, (2) a congestion management model and (3) a hydrogen supply chain model. The three models are complemented by two smaller optimisations which aim at determining the optimal system-based location and the corresponding optimal operation of electrolysers. The entire analysis is split into eight steps, which are described hereafter. Depending on the analysed case, the set of considered steps varies, however. As the two hybrid options involve TSOs and represent system beneficial installations of electrolysers, we first need to develop the TSOs knowledge about the grid topology and its projected operational

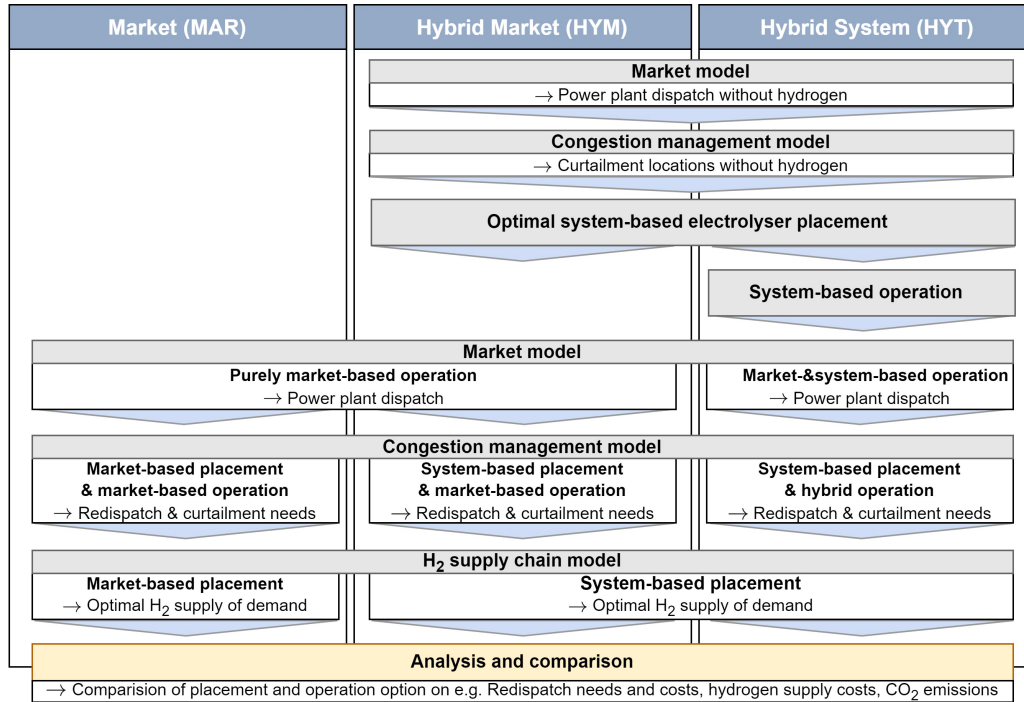

Figure 3.1: Scheme of the applied methodology

state. This then allows the electrolyzers to be placed in such a way that they can optimally provide their system flexibility. Steps I to IV contain the corresponding calculations that derive information about the locations, the occurrences, and the magnitudes of expected congestion and curtailments. Consequently, these steps only apply for the two hybrid options and are not used in the case of the market-based placement. All steps of the analysis are described below:

- (I) First, the market model is run to determine the generator dispatch. The production of electrolytic hydrogen is not considered in this step.
- (II) Based on the resulting dispatch, the congestion management model is applied to identify occurring curtailments and all required information about congested power lines.
- (III) The optimal system-based electrolyser locations are then determined. For this we use one of the two auxiliary optimisations.
- (IV) Next, we use the optimal electrolyser operation model, the second auxiliary optimisation, to derive the hours during which the units must be operated to counteract the projected congestion and curtailments. This step is only used in the analysis of the ‘Hybrid System’ (HYT) case.

After determining the optimal electrolyser locations for the two hybrid options as well as the operating hours that serve the system, the impact of the hydrogen production on the system is assessed for the three options by introducing an exogenous hydrogen demand.

- (V) The electricity market model is run again. This time, the production of electrolytic hydrogen is considered. While in the ‘Market’ (MAR) and ‘Hybrid Market’ (HYM) cases the electrolyzers

are operated purely based on market signals (preferential operation of the plants in times of low electricity prices), in the ‘Hybrid System’ (HYT) case the operation of the plants is partly predetermined by the TSO through the optimal system-based operation (results from step IV).

- (VI) We then plug the resulting dispatches of both the generators and electrolysers in the congestion management model. To solve physical transmission bottlenecks, the required upward and downward regulations are determined for each of the options and the resulting redispatch costs are calculated.
- (VII) Subsequently, we identify the most cost-effective hydrogen supply routes to supply the produced hydrogen volumes to the location demand. To do so, the hydrogen supply chain model is applied.
- (VIII) The results of steps V to VII are then compared between the three options.

The following subsections introduce the three main models used in the study. Their detailed description can be found in Appendix B.2.

3.3.1 The electricity market model

The electricity market model is formulated as a linear optimisation problem and represents a stylised form of the day-ahead market. The objective of the model is to set the output of all generators for the supply of exogenous electricity demand in a way that minimises overall system costs³. The model results in an hourly dispatch of all generators in the considered spatial and temporal scope. This also include the operation of storage facilities such as pumped hydro storage plants. Corresponding technical constraints such as charging and discharging limits as well as storage volumes are taken into account. In addition to the generator dispatch, the market prices of each assessed market zone are obtained. They are determined for every analysed hour by the shadow prices of the corresponding market zone.

3.3.2 The congestion management model

In the congestion management model, the results of the electricity market model are used as input parameters for the calculation of redispatch measures. Compared to the electricity market model, a higher spatial granularity is considered, which is not limited to the market zone level, but that takes into account the location of market participants (i.e. injection and extraction) at the network nodes. The representation of the model thus changes from a market view with uniform pricing to a representation that considers each network node individually. The nodes are interconnected by transmission lines that enable the transfer of electricity through the power system. Physical power flows through individual power lines are determined by a direct current (DC) representation, which is a simplified abstraction from a consideration of alternating current (AC). It enables the approximation of power flows in transmission networks by using a linear formulation (Overbye, Xu Cheng, and Yan Sun

³ Except for the endogenous demand caused by electrolysers.

2004). The model resolves transmission limits on power lines by down-regulating and up-regulating generators, which is also referred to as redispatch. Like the electricity market model, the congestion management model is formulated as a linear optimisation problem. The objective of the model is to minimise the cost of redispatch measures to balance demand, taking into account grid constraints. While the electricity market model optimises the operation of the generators over multiple hours, the congestion management model minimises redispatch costs for each hour individually, as the higher spatial representation is more demanding in terms of computational costs⁴.

3.3.3 The hydrogen supply chain model

The hydrogen supply chain model is used to determine the least-cost supply routes to balance expected hydrogen demand. Figure 3.2 illustrates the supply options that are considered in this study. Each supply chain has a start node, where the hydrogen is produced by the electrolysis process, and a destination node, where it supplies a specific demand. Each element of the supply chains is associated to costs that are first summed and then minimised. In the model, we consider the most commonly discussed transport options (IEA 2019c). These include the transport of gaseous hydrogen in pipelines (GH_2) and the transport via road freight in the form of ammonia (NH_3), liquid organic hydrogen carrier (LOHC), as liquefied hydrogen (LH_2) or in compressed form (CH_2). Depending on the chosen transport mode, the respective conversion and reconversion steps are considered. Moreover, the structure of the model allows the disregard of from transport needs between production and destination location if they are in the same place. This is important for actors that prefer the provision of hydrogen in a captive manner, where no transport of the volumes is required. The hydrogen supply chain model is formulated as a linear optimisation problem, similar to the electricity market and congestion management model. While the latter two models consider high temporal granularities (hourly resolution), the calculations of the hydrogen supply chains are performed at an annual level. The same applies to the balancing of hydrogen demand. As in the study of vom Scheidt et al. (2022), hydrogen storage is therefore not explicitly considered in our stylised approach. The occurring costs in the supply chain model are all expressed in Euros per kilogram of hydrogen supplied.

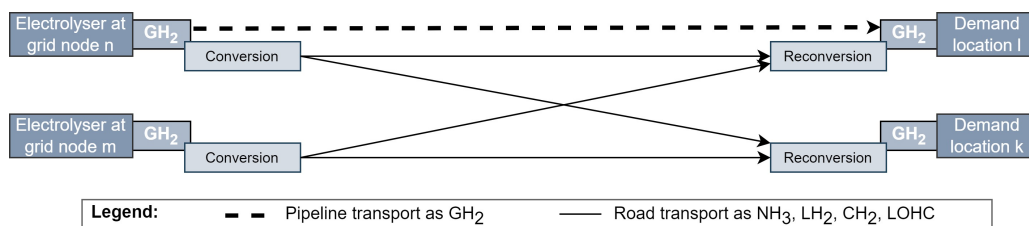

Figure 3.2: Scheme of hydrogen supply chain model

⁴ Pumped hydro plants and dams are excluded from the provision of redispatch as the hourly optimisation does not enable adequate water management of the units. However, this represents a realistic case as the role of hydro storage plants for redispatch measures was minor in the past (BNetzA 2021).

3.4 Scenario setup and data

Our analysis focuses on Germany in 2030. The three models are calibrated accordingly based on corresponding data. While the following subsections provide an overview about the main data, further details are given in Appendix B.3.

3.4.1 Data on the electricity system

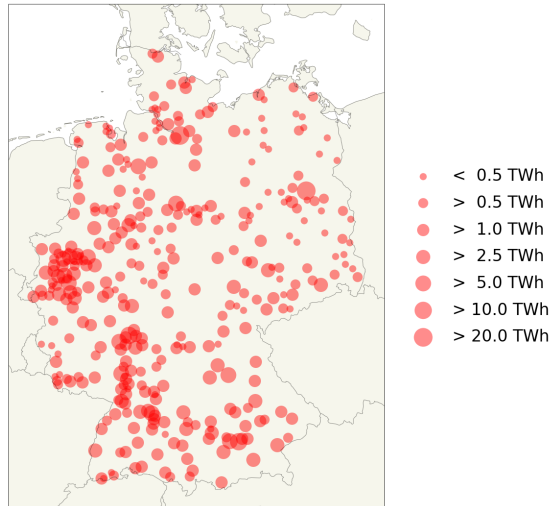

(a) Load

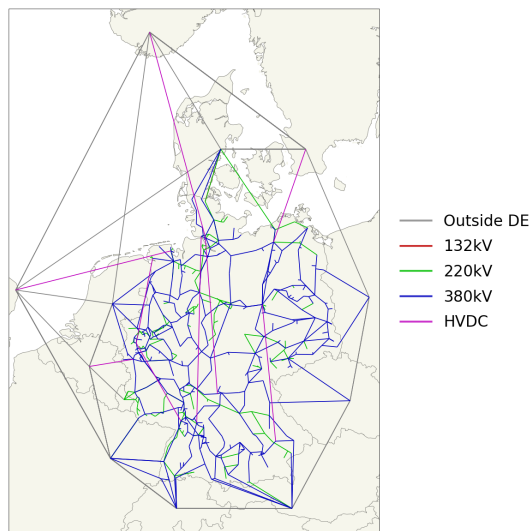

(b) Network⁵

⁵ The nodes of neighbouring countries are illustrated in a simplified way. The data on power lines are considered through their real geographical locations. Furthermore, within the figure power lines might be hidden through other overlaying power lines (e.g. 132 kV).

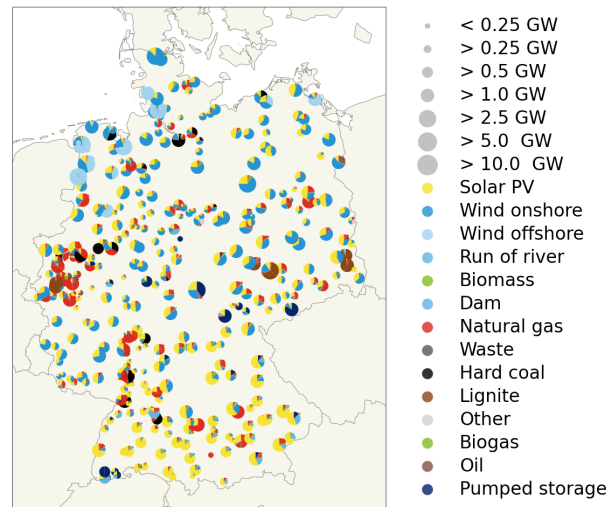

(c) Generation

Figure 3.3: Illustration of spatially resolved power system data

One of the EU's priorities is to strengthen the integration of individual electricity markets within Europe to benefit from trade and better balance natural resources among member states. As a result, electricity exchanges between neighbouring states are gaining importance. Given its central location in Europe, Germany is already well integrated into the European power grid. Further interconnectors are soon to be put into operation, so that the country will be directly connected to twelve neighboring countries⁶ by 2030. To account for this increasing market integration, we include Germany but also all the directly linked neighbours in the electricity market models and model their dispatches endogenously. Furthermore, as the analysis of intra-zonal grid congestion requires a high spatial granularity, the German system is represented at a nodal level (Figure 3.3). To reduce the complexity of the calculations, each neighboring country is, however, only represented by a single node. The evolution of the national generation fleet in the interconnected countries are based on governmental announcements. The national grid expansion plan serves as a basis for the evolution of the power grid in Germany. To reflect current trends, our base case assumes an average delay of three years for new power line construction⁷. More detailed information on the power sector, its calibration and the underlying assumptions covering electricity demand, production and transmission are provided in Appendix B.3.1.

3.4.2 Data on the hydrogen system

While the exchange of electricity with directly connected neighboring countries is considered in the study, the overall hydrogen supply analysis is limited to the national borders of Germany.

⁶ NL, BE, FR, AT, CH, DK, SE, NO, UK, PL, CZ, LU – countries with more than one market zone are aggregated to only one node.

⁷ Based on Degel et al. (2016), however. In a sensitivity analysis, this parameter is varied to assess cases where the expansion is carried out as planned or with an even greater delay.

3.4.2.1 Data on hydrogen production

According to the national hydrogen strategy, the country aims to install 5 GW of electrolyser capacity by 2030 (BMWI 2020b), which is also the considered electrolyser capacity in our assessment. The production of electrolytic hydrogen is assumed to take place in alkaline electrolysers, which are currently the most mature and competitive technologies. They are assumed to operate 3500 hours per year, an assumption based on the national regulatory framework for grid-connected electrolysers in Germany⁸. Since the produced volumes of hydrogen in the three assessed options are identical, direct comparisons between the cases are possible.

3.4.2.2 Data on hydrogen demand

The demand of hydrogen in Germany is expected to increase rapidly in the coming years. The main drivers are the replacement of fossil fuels in industrial applications as well as in the transport sector. In this analysis, we focus on the supply of electrolytic hydrogen to the industry, as this is the sector with the biggest expected demand in 2030. Corresponding demand projections and their geographical location are taken from vom Scheidt et al. (2022). They are illustrated in Figure 3.4. As the targeted electrolyser capacity in 2030 is not sufficient to supply all their demand, we allocate the produced electrolytic hydrogen in the market-based placement to the demand locations proportionally to their total hydrogen demand. For TSO-based placement options, the model decides endogenously which demand locations to supply.

3.4.2.3 Data on hydrogen conversion, transport, and infrastructure

In the supply chain model, the transport of hydrogen is considered via different modes. It can be shipped via road transport as NH_3 , as LOHC or in liquified (LH_2) or compressed (CH_2) form. In addition to road freight, the transport in gaseous form (GH_2) via pipeline is also considered. While road transport allows hydrogen to be shipped from any point to any other point, hydrogen transport via pipelines can only take place between interconnected points. The natural gas network in Germany is well developed and covers most parts of the national territory. Hydrogen can be injected into natural gas at rates of up to 10% without requiring changes to the infrastructure (IEA 2019c). This is also referred to as hydrogen blending. Once the hydrogen is mixed with the natural gas, it requires considerable effort to separate it again from the blend needed to meet the industry's hydrogen demand (Melaina, Antonia, and Penev 2013). This option is therefore not considered economically viable. The grid expansion plan of the national gas network, foresees, however, that first dedicated hydrogen infrastructure will be available in parts of Germany from 2025 onwards (FNB-Gas 2020). Most planned connections are existing natural gas pipelines that are retrofitted. According to the national gas grid expansion plan, some first hundreds of kilometers of pipeline infrastructure, mainly located in the northwestern part of Germany, should be available for the transport of hydrogen in 2030. Geospatial data on the natural gas pipeline infrastructure from Kunz et al. (2017) and information from national gas expansion plans are used to approximate the

⁸ 3500h correspond also approximately to a cost optimal operation. Further information is provided in the Appendix B.3.2.4.

projected hydrogen network in 2030. Figure 3.4 shows the considered network topology. In addition to the targeted network, we assume some additional line elements to be retrofitted at the Dutch border and close to the North Sea (dashed line).

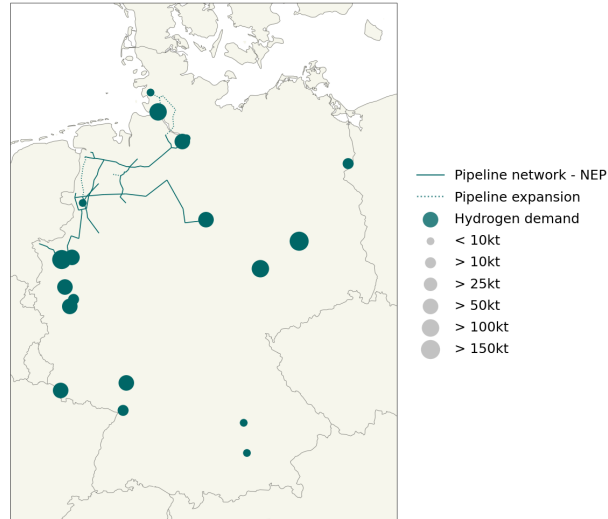

Figure 3.4: Hydrogen demand and hydrogen network topology

Further information on the assumptions and the data used for both the transport and conversion of hydrogen are provided in Appendix B.3.2.

3.5 Results

3.5.1 Base case - initial scenario without production of electrolytic hydrogen

We use the scenario in which no production of electrolytic hydrogen is considered as the ‘base case’. Its derivation refers to Steps I and II, as outlined in Section 3.3. The scenario builds the basis to mimic the TSO’s knowledge of occurring congestion and curtailments in the power system for the identification of system-beneficial locations of electrolysers. In addition, the results of the base case are also used to assess the effect of the hydrogen production under the three considered options on the power sector.

The results show that the output of renewables in the German market is reduced in about 1700 hours of the studied year due to structural congestion in the system. In these hours, about 3.9 TWh of renewable electricity cannot be integrated into the system. 51% of it comes from onshore wind, 47% from offshore wind and the remainder from solar PV. As shown in Figure 3.5, the occurring curtailments affect renewables at 73 network nodes. Most of these network nodes are located in the northern part of the country, with minor curtailments also occurring in central and south Germany.

Electricity is mostly curtailed in times when the share of renewable electricity in the system is high and corresponding market prices are low. This is illustrated in Figure 3.6. While the top chart shows the electricity prices of the Germany market zone in 2030 ordered from the lowest to the

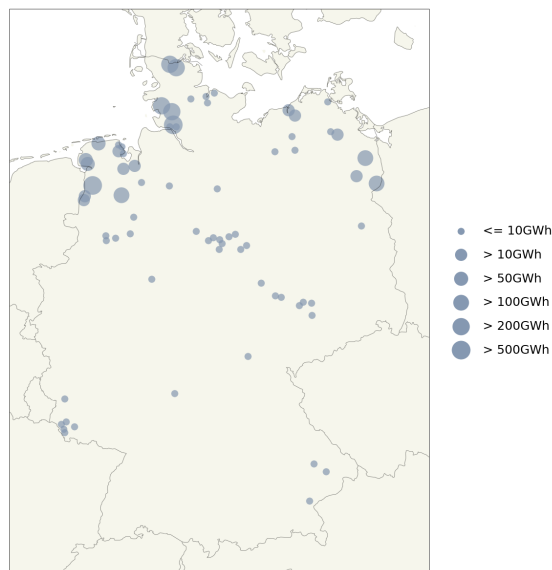

Figure 3.5: Occurance of curtailments in the base case scenario

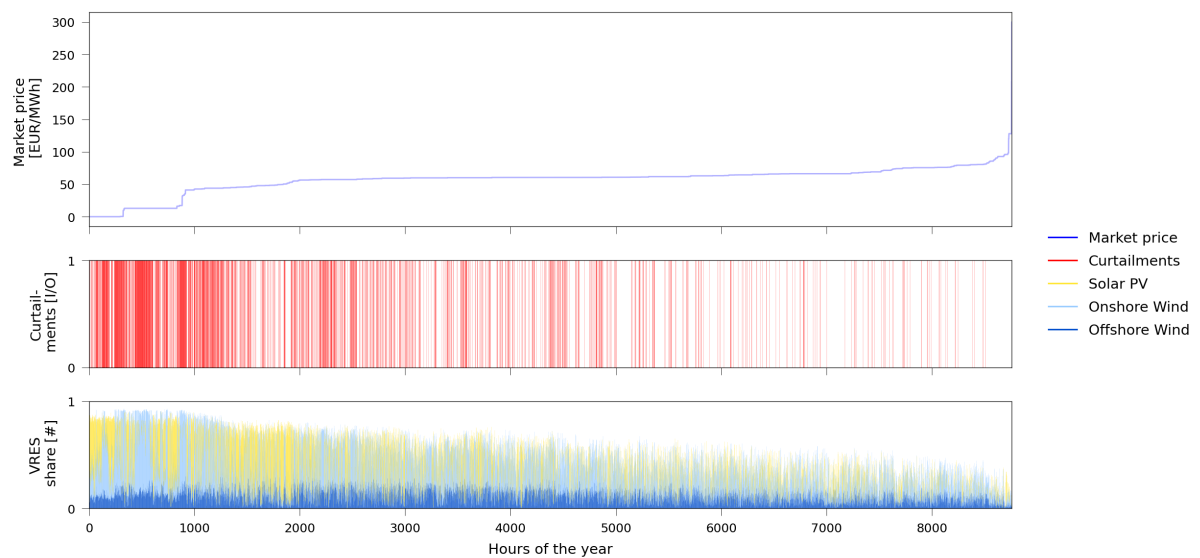

Figure 3.6: Ordered electricity prices of the German wholesale market, the corresponding occurrence of curtailments and the share of variable renewable electricity

highest value, the two lower ones represent the shares of electricity from renewables in the system and the occurrence of curtailments in the corresponding hours of the year, respectively. The high density of red bars (hours with occurring curtailments) on the left part of the graph clearly indicates that there is an overall positive correlation between curtailments and high shares of wind energy in the system. In these hours, electricity prices tend to be low.

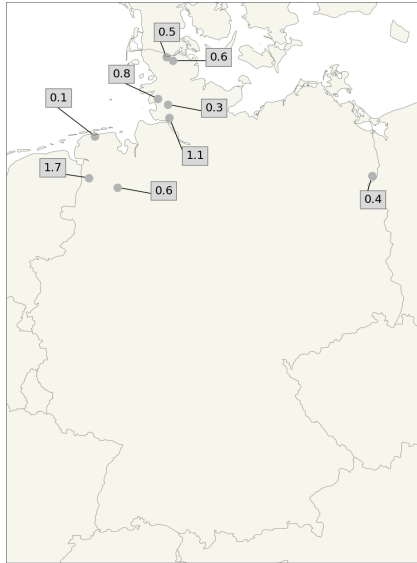

Figure 3.7: System-based positions of electrolysers inclusive capacity in [GW]

3.5.2 Results of an optimal system-based placement of electrolyser capacities

The outcomes of the base case serve as a basis for the system-optimal allocation of electrolyser capacities (Step III - Electrolyser placement optimisation). The resulting configuration corresponds to the cases where TSOs are empowered to place the units (HYM and HYT). Figure 3.7 shows the identified locations of the electrolysers and the respective capacity allocation. Installations take place at nine grid nodes in the country. Almost all of the capacity, however, is located in the north-western. Only a small portion is location of 400 MW is located in the eastern region. Due to the small contribution of renewables to the total amount of curtailed electricity, an allocation of electrolyser capacities to the remaining 64 nodes, where curtailments also occur, is not sufficiently justified.

3.5.3 Effects of production of electrolytic hydrogen on the power system

The different effects of the hydrogen production on the power system are presented in this subsection (Step V and Step VI). The results of the three assessed options are compared to the outcome of the base case.

The integration of 5 GW electrolyser capacity causes the overall electricity demand to increase by 17.5 TWh, which corresponds to about 3% of the total projected electricity demand in Germany in 2030. As a result, the average annual electricity prices in the German market area rise by about 3.4% compared to the base case (Figure 3.8a). At an annual level, there are only slight differences in the average electricity prices between the individual operation options (Purely market-driven and partially decided by the TSO). The effects on the curtailments, however, show significant differences among the individual options (Figure 3.8b). In all three analysed cases the total curtailments decrease. While market-based placement results in 12% reduction in curtailments compared to the

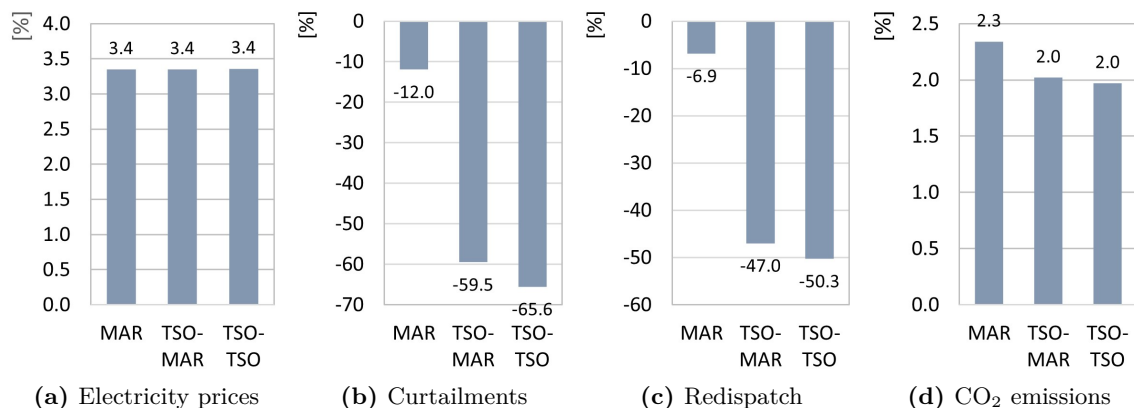

Figure 3.8: Effects of hydrogen production on power sector

base case, the options where the TSOs place the units show much larger reductions. The decline in curtailments is highest at around 66% for the option where the TSOs place the units and also intervene in their operation (HYT). Slightly lower reductions (60%) are obtained, when TSOs are only involved in the placement of electrolyzers without intervening in their operation (HYM). The same trend can also be observed for the entire redispatch measures. While the market-based option leads to a reduction of 7%, the TSO-based placements show more distinct decreases of about 50%. (Figure 3.8c). Similar to the effects on curtailments, the intervention of TSOs in the electrolyser operation (HYT) shows only small additional benefits of less than one percentage point compared to purely market-based operation (HYM). Driven by the additional electricity demand and the impact on redispatch needs, the hydrogen production also affects CO₂ emissions. In all assessed options they increase by about 2.0% (Figure 3.8d). It can be seen, however, that the two options, where the TSO places the electrolyzers succeed in a better integration of renewable electricity and hence, in lower additional CO₂ emissions. The difference in absolute terms correspond to about 0.3 Mt of CO₂ per annum.

3.5.4 Effects of the spatial distribution of hydrogen supply

Figure 3.9 shows the hydrogen supply configuration for both the system-based and the market-based electrolyser placement. In the case of the market-based placement, hydrogen producers do not see locational signals. To avoid additional transport costs, they install the electrolyzers directly at the consumption sites and supply their demand in a captive manner. By contrast, for the two cases where the electrolyser capacities are located by TSOs, hydrogen production takes place at the ten identified grid locations. The produced hydrogen is then transported to the demand locations. As the hydrogen supply setup is analysed at an annual level and as the hydrogen production of all assessed options is equal over the year (0.35 MTPA), the two hybrid options (HYM and HYT) result in an identical outcome with respect to the geographical configuration. The model results show that there are three main technology routes among the considered transport options. In all options the produced hydrogen remains either in gaseous form or is liquefied and then transported. When pipeline infrastructure is available, pipelines are also the preferred transport option. Where no pipelines are available, the volumes are transported via road freight either in compressed or in liquid

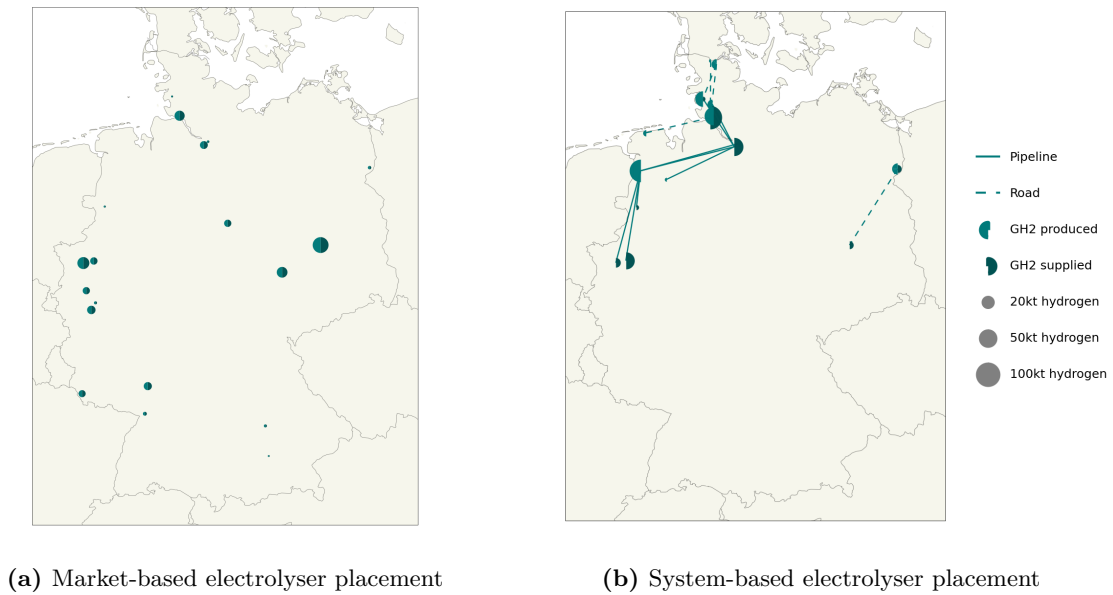

Figure 3.9: Hydrogen supply structure

form. Due to the regional nature of available hydrogen pipelines in 2030, the majority of hydrogen produced will be delivered to industrial sites in the Northwest via pipeline. These have sufficient demand to absorb the volumes produced. The volumes transported by truck will also remain in the region and supply nearby industries to reduce transport costs. Industrial sites in the rest of the country are not supplied for cost reasons. As the hydrogen production in the western part of the country is the only one that is linked to the hydrogen pipeline network in 2030, it supplies all demand locations connected to the grid by pipeline. All other volumes are transported by road. In two cases, the selected electrolyser site are, however, located close to demand locations. In these cases, no transport of the hydrogen is necessary. This concerns one facilities in the northern region as well as the one in the east of the country.

3.5.5 Hydrogen supply cost structure

The outcomes of both the electrolyser operation in the power system and the hydrogen supply structure are important for the assessment of the supply costs. The corresponding cost breakdowns per assessed case and per technology route are illustrated in Figure 3.10. To also get an idea about the competitiveness of the electrolytic hydrogen supply options against alternative supply routes, the figure also shows the corresponding values for the captive supply of hydrogen produced from natural gas in the steam methane reforming process (SMR). SMR is considered with and without carbon capture and storage equipment (CCS). The hydrogen produced via these two routes is also referred to as blue and grey hydrogen, respectively. While the production of grey hydrogen represents the state of the art, blue hydrogen is seen as an alternative technological pathway for the provision of clean hydrogen that might compete against hydrogen produced through electrolysis.

Depending on the considered electrolyser placement and operation option as well as on the chosen supply route, the cost for the supply of electrolytic hydrogen are composed of up to four elements,

namely (1) costs linked to the hydrogen production facility (e.g. investment as well as fixed O&M costs), (2) costs for the sourcing of electricity, (3) costs for the conversion of hydrogen between the various forms and (4) costs related to the transport from the production sites to the demand locations. The individual bars in Figure 3.10 represent the average costs of all supply routes with the same technologies (Figure 3.2). Cost differences resulting from different transport distances between the individual routes are represented by the confidence intervals. Since no hydrogen transport is required in the captive supply, there are no costs associated to it.

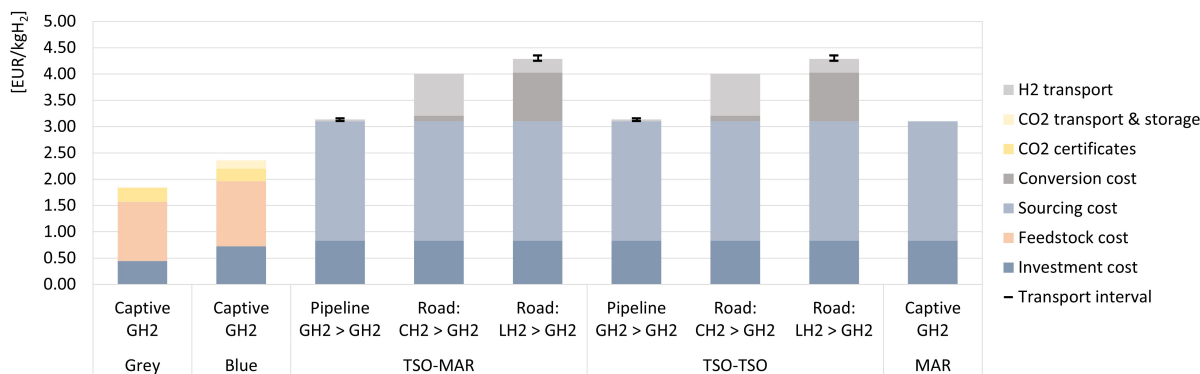
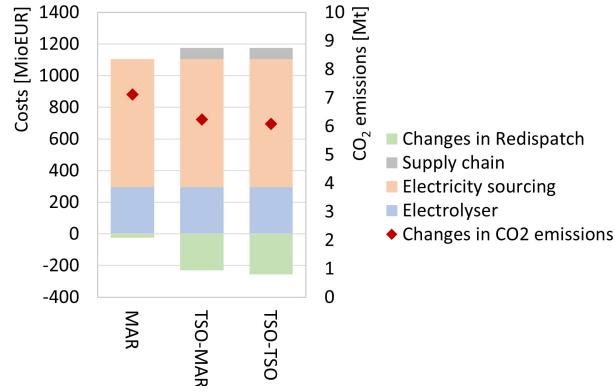
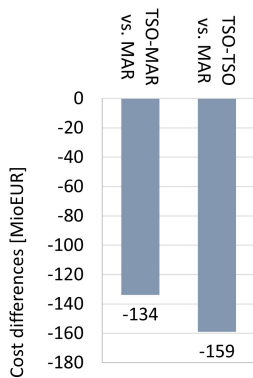

Figure 3.10: Hydrogen supply cost breakdown

Figure 3.10 shows that the purchase of electricity is the major cost component of the hydrogen supply costs. Depending on the assessed option, it accounts for between 55% and 75% of the total costs. Moreover, despite obligations set by the TSOs to run the electrolyzers in predefined periods that are not based on price signals sent by the wholesale market, the differences in sourcing costs to a purely market-based electricity sourcing are negligible. As the financing conditions for electrolyzers are assumed to be equal for all options, the costs associated with the electrolyzers' capex are the same among the supply routes. Their contributions to the total supply costs accounting for between 20% to 30%. Conversion and transport needs add further elements to the supply costs. Whereas the liquification process increases costs by around 0.93 EUR/kg_{H2}, the compression adds 0.11 EUR/kg_{H2}. The costs related to the transport of hydrogen depends on the transport mode. While pipeline transport increases costs by 0.04 EUR/kg_{H2} contributing to the overall costs by about 1%, the transport via road adds costs between 0.25 EUR/kg_{H2} to 0.80 EUR/kg_{H2}. In the most extreme case, transport requirements and corresponding conversion needs account for 27% of the total supply costs. In 2030, the production of grey hydrogen results in costs of 1.80 EUR/kg_{H2}. Blue hydrogen is produced at costs around 2.30 EUR/kg_{H2}. Under most favourable conditions, the costs for the provision of electrolytic hydrogen are therefore about 1.30 EUR/kg_{H2} and 0.80 EUR/kg_{H2} more expensive than those of grey and blue hydrogen, respectively. Under the most unfavourable supply conditions the additional costs are between 2.00 EUR/kg_{H2} and 2.40 EUR/kg_{H2} more expensive.



(a) Comparison of absolute values between options



(b) Cost savings of TSO-based placement

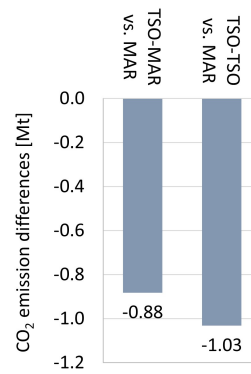

(c) CO₂ emission savings of TSO-based placement

Figure 3.11: Absolute effects of regulatory relaxations on system costs and CO₂ emissions

3.5.6 Results on total system costs

The resulting effects on total costs are presented in Figure 3.11a. They are the sum of the absolute changes in electricity and hydrogen supply caused by the introduction of electrolyzers into the system. The costs for the electrolyzers of EUR 300 million are identical for all options. In the procurement costs of electricity, which account for the largest share, there are only minor differences between the options. While the costs are EUR 0.8 billion for the market-based options (MAR and HYM), they are slightly higher (< 1%) when the operation of the electrolyzers is partly determined by TSOs (HYT). The transport requirements for TSO-based placement options to overcome the locational differences between hydrogen production and consumption amount to EUR 71 million. Another cost element results from the required redispatch needs and the corresponding differences between the options. As described in Section 3.5.3, all assessed options decrease redispatch needs. While the market-based electrolyser placement results in savings of EUR 25 million compared to the base case, the options where the TSOs place the units save much more redispatch costs. In the case of purely market-oriented operation (HYM), the savings are EUR 230 million, and in the case of electrolysis operation in which the TSOs partially intervene (HYT), the savings are around EUR 260 million.

The involvement of TSOs in comparison with a purely market-based placement and operation of electrolyzers results in savings of both total costs and CO₂ emissions as shown in Figure 3.11b and

Figure 3.11c, respectively. Due to the better integration of renewable electricity, the involvement of TSOs that also allows them to intervene in the operation of electrolyzers lead to cost savings of about EUR 160 million. They are slightly lower, amounting to EUR 133 million, if the TSOs only place the units without affecting their operation. The same effect is reflected in the reduction of CO₂ emissions. While in both cases the CO₂ emissions decrease, the reductions are slightly higher (+0.15Mt) in the option where the TSO is also allowed to intervene in the operation of the units. Total reductions amount to about 1 Mt CO₂ in 2030. If the cost savings were converted directly into subsidies for the hydrogen provision, they would reduce the hydrogen supply costs by about 0.37 and 0.45 EUR/kg_{H2}⁹.

3.5.7 Sensitivity analysis

This subsection compares the results of the cases presented above with four alternative developments of infrastructure availability.

- *Sensitivity 1: punctual grid expansion of the electrical system*

The sensitivity represents the case where the timeline of the grid expansion follows the targets of the German government as scheduled. Consequently, both new power lines and power line upgrades come online three years earlier than compared to the main scenario in this study.

- *Sensitivity 2: further delayed grid expansion of the power system*

Within this sensitivity it is assumed that the current ambitions to accelerate the grid expansion measures do not work out as planned so that the envisaged grid reinforcements are achieved five years later than scheduled.

- *Sensitivity 3: earlier natural gas pipeline retrofitting to hydrogen*

While building new power lines requires a significant administrative effort that takes a long time, retrofitting Germany's existing natural gas infrastructure could be achieved much faster and allow significant amounts of low-carbon energy to be transported across the country. This sensitivity assumes that a nationwide hydrogen network connecting all considered production sites to all demand centres is already available in 2030. out as planned so that the envisaged grid reinforcements are achieved five years later than scheduled.

- *Sensitivity 4: delayed natural gas pipeline retrofitting to hydrogen*

Despite official efforts to already convert parts of the natural gas pipeline network for the transport of hydrogen, there are still uncertainties regarding the feasibility of the plans. In this sensitivity, it is assumed that no retrofitting of the pipelines will take place by 2030.

Figure 3.12 illustrates the outcomes of the sensitivity analysis. The results show that an acceleration of the grid expansion (Sensitivity 1) decreases welfare gains caused by the involvement of TSOs in the placement and operation of electrolyzers. Compared to the purely market-based placement and operation of electrolyzers, the cost savings are reduced to about EUR 134 million and

⁹ Reductions are applicable to supply costs of captive supply options, as transport and conversion costs are also outweighed by the savings in redispatch.

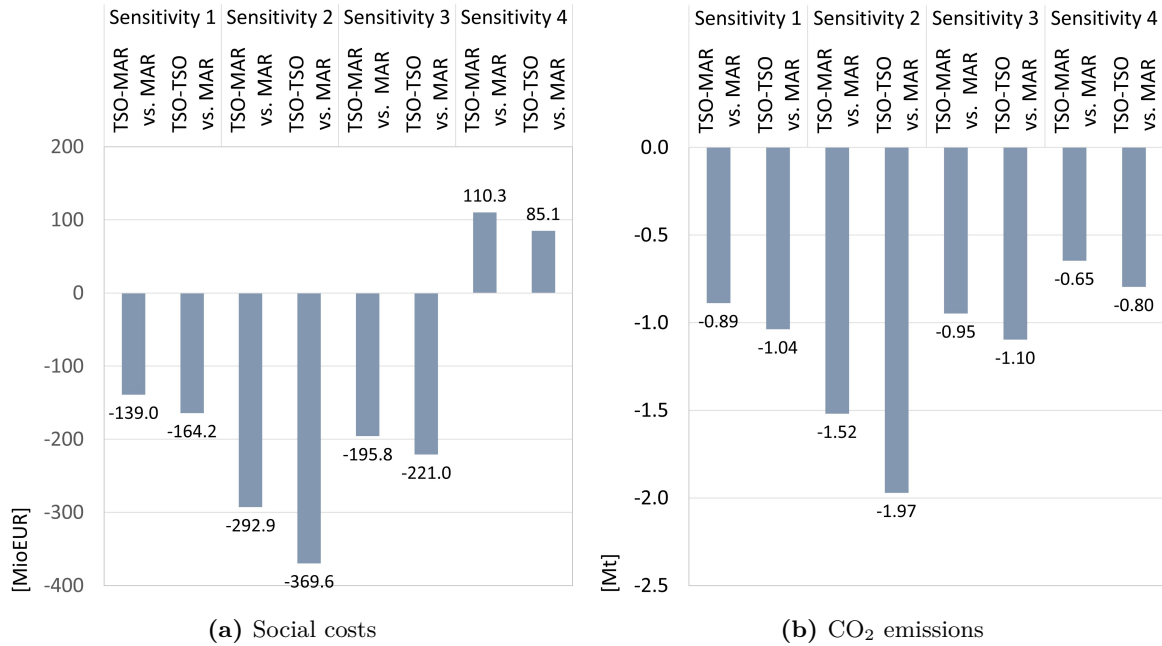

Figure 3.12: Sensitivity analysis

EUR 100 million, respectively, for the two options. CO₂ emission reductions decrease mostly in the market-based operation (-80 kt_{CO2}). By contrast, a further delayed grid expansion (Sensitivity 2) results in additional gains in both overall total costs and CO₂ emissions. The cost savings increase to EUR 290-370 million. The reduction in CO₂ emissions also increases significantly by more than 70% compared to the main scenario (delay of power grid expansion by 3 years), amounting to 1.5 Mt_{CO2} and 2 Mt_{CO2}. If the achieved cost savings are used to subsidise the hydrogen supply, hydrogen costs would decrease by between 0.82 to 1.03 EUR/kg_{H2}. The results of sensitivity 3 show that the earlier availability of widespread hydrogen pipeline infrastructure affects CO₂ emissions only modestly, primarily due to the avoidance of CO₂-emitting liquefaction and transport requirements. However, additional cost savings are achieved in these cases through the regulatory relaxation compared to the main scenario. The values increase to almost EUR 200 million and EUR 220 million. Their conversion into subsidies for hydrogen supply would reduce supply costs by 0.55 to 0.62 EUR/kg_{H2}. A delayed pipeline retrofitting on the contrary does reduce overall CO₂ emissions (-0.65 Mt CO₂ to -0.8 Mt CO₂), but does not result in cost savings. Instead total system costs increase to EUR 85-110 million.

3.6 Discussion

Innovations such as sector coupling technologies offer new possibilities to overcome challenges in the power system caused by the integration of higher shares of renewable electricity. In our study, we focus on the production of electrolytic hydrogen and its possibilities to contribute to an improving system efficiency.

We find that electrolyzers have overall substantial effects on the power sector and can provide flexibility to the system. Our results show that if installed under current regulation, the integration

of the technologies can lead to a better integration of renewable electricity reducing overall redispatch needs. Total system costs as well as CO₂ emissions may decline. The savings, however, are small. If the electrolyzers are not built evenly distributed across the industrial sites, as assumed in our analysis, there are risks, however, that the effects of grid congestion will even be amplified. To mitigate these risks and take advantage of the cross-sector opportunities that electrolyzers offer, changes to current market designs can provide options for efficiency gains, as suggested by previous studies such as vom Scheidt et al. (2022) and Xiong et al. (2021). By using rather general approaches such as through nodal pricing, an option that represents the economic optimal but is widely disregarded due to its practical disadvantages, the latter authors highlight the need for assessments of more ‘realistic’ implementation possibilities. In our analysis, we assess the ‘operator model’, which is an option that could be implemented relatively easily. Our findings show that this option can help to integrate electricity from renewables and thus increase system efficiency. Curtailments of electricity reduce by about 60-65%, causing overall redispatch needs to decline by approximately 50%. As the reduction in congestion management costs outweigh the additional expenses for conversion and transport that result from the system-beneficial placement of electrolyzers to bring the produced hydrogen to the demand locations, overall system costs reduce by EUR 130-160 million in the target year 2030. In addition, it also has positive effects on CO₂ emissions, which drop by 0.9-1 Mt CO₂. The effects become even greater with an increasing availability of dedicated hydrogen pipeline infrastructure. The operator model is therefore an option that appears relatively easy to implement and leads to both cost savings and CO₂ emission reductions.

As TSOs are regulated entities in the EU acting as natural monopolies, they are however excluded from participating in the two competitive segments of the power sector, namely the generation and the retail of electricity. To avoid economic inefficiencies and market power abuse, they are therefore neither allowed to operate conversion units such as electrolyzers nor to own them. Consequently, the assessed variants of the operator model, that enable TSOs being involved in both the placement and the operation of the units, represent cases that are not within the current regulatory framework of vertical unbundling rules. However, various possibilities such as regulatory derogations or sandboxes exist that could be considered to overcome the current regulatory constraints to still benefit from the overall costs and emission savings.

Regulatory sandboxes are part of the regulatory innovation and experimentation toolkits that regulators have started putting in place in various sectors¹⁰ in recent years¹¹. By defining clear entry and exit conditions, timeframes and scopes, as well as by securities/safeguards for consumers in case of failure (Ringe and Ruof 2020), regulatory relaxation aim at obtaining regulatory experiences in sealed sandbox approaches with limited impacts on the overall market environment. Schittekatte et al. (2021) describe them ‘as a temporal removal of regulatory barriers’ that, among others, allow for ‘assigning responsibilities to players to conduct activities that they are normally not allowed to engage in’. In addition to sandboxes, further possibilities to grant derogation from the unbundling rule exist. According to the authors, additional options are provided by more traditional tools such as waivers, that are exemptions granted by the regulators for ‘strictly defined activities or

¹⁰ Finance, health, telecommunication and energy.

¹¹ (IEA 2019b); <https://www.tse-fr.eu/regulation-sandbox>

types of actors' aiming at fostering innovation. The needed derogations of TSOs from the vertical unbundling rules would only be moderate and cause some administrative costs that, in light of the potential benefits and limited risks, could be worth testing. Another possibility of regulatory derogations is given by the EU directive 2019/944, which allows for exemptions of current regulations under certain circumstances. According to Art. 2(59) of the directive, 'electricity storage systems' are included in the group of possible exemptions. They represent facilities that store electricity for its later usage or convert it to other forms of energy that can either be re-electrified or used directly in other downstream sectors. Electrolysers belong to this category (Olczak and Piebalgs 2018). Three different conditions are required to be met simultaneously to allow regulators to derogate from vertical unbundling rules and to empower TSOs being involved in the placement and operation of electrolysers as highlighted in Schittekatte et al. (2021): first, it is of no interest of market participants to develop, to own, to manage and to operate such units. Second, the facilities are required to ensure a safe, a reliable and an efficient operation of the system, which is the responsibility of TSOs and lastly, the units are not used to intervene with the market through the selling of electricity. It is however debatable whether all requirements are met under the conditions analysed in this work. An in-depth assessment by regulators is therefore needed to confirm the fulfillment of the required conditions. In this respect, sandboxes and their resulting field experiences could shed light on these aspects and provide valuable insights to tailor regulation.

Allowing TSOs only to place electrolysers requires just moderate derogation from the unbundling rules but no further lifting of other potential regulatory barriers since interventions of TSOs in the power markets are still prevented. Giving TSOs also the possibility to intervene in the operation of electrolysers, as considered in the HYT case, would require additional regulatory adjustment. Our results show, however, that due to the positive correlation of curtailed electricity with, high shares of variable renewables and low electricity prices, system-beneficial and market-based operating hours of electrolysers are widely overlapping. The additional regulatory relaxation needed to allow TSOs to intervene not only in the placement but also in the operation of the units, therefore adds only marginal value. Consequently, it is questionable whether this extra-relaxation is worth further pursuing.

One might argue that these derogation possibilities introduce barriers against a market-based development of the technology. In contrast it can be stated, however, that the current competitiveness of electrolysers indicates that a purely market-based development of the technology still requires significant financial support or substantial regulatory interventions (e.g. green hydrogen quota). Therefore, one possible implementation could be that TSOs are only involved in the process of defining the location and dimensioning of the electrolysers, as part of the infrastructure planning they are responsible for. Competitive auction systems could then be put in place to grant access rights for market actors to operate and/or own the units. Moreover, the assessment of different electrolyser capacities shows (Appendix B.1) that even small portions of the overall targeted electrolyser capacity can already contribute to increases in system efficiency. Therefore, derogations would not need to concern the entire planned capacity.

It could also be argued that the locations chosen by TSOs would become less relevant in the long-term once additional transmission capacity comes online, which relieves pressure on existing power

lines. In such cases, unnecessary additional conversion and transport costs to carry the produced hydrogen to the demand locations remain, which might cause electrolyzers to stay idle. The identified locations for the system-based placement of the units might, however, also be system-beneficial locations in the long-term as new and more efficient installations of renewables (e.g. repowering) are likely to be placed at the same sites or nearby. Furthermore, as illustrated by the sensitivity analysis of an early pipeline infrastructure development, as soon as a wider dedicated hydrogen pipeline network is available, transport costs only account for minor fractions of the total supply costs, which reduces the risk of stranded assets. In this respect it should be rather argued that the system-beneficial placement of electrolyzers contributes to an overall efficient use of already existing infrastructure. As natural gas demand is projected to reduce progressively in the coming decades (IEA 2021d), the utilisation of the gas infrastructure is expected to decrease. The dedicated transport of hydrogen can therefore offer valuable possibilities for its further use. At the same time, the need for new transmission capacity in the power system reduces due to the alternative transport mode of green energy. Consequently, to reduce overinvestment in the power system and to avoid stranded assets in the natural gas sector, it is also recommended that gas and power network infrastructure is planned jointly.

While the above arguments hold primarily for investments in electrolyzers, conversion and road freight infrastructure might indeed run the risk of lower utilisations once hydrogen pipelines become available. As the energy transition progresses, however, additional hydrogen uses become available, such as in the transport sector. The produced hydrogen no longer needs then be transported to a few large demand centres, but rather to many distributed locations with much lower consumption. Their supply is likely not prioritised in the early design of a dedicated hydrogen network infrastructure. This offers alternative uses for conversion and road freight infrastructure. It remains questionable, however, whether investments in the possibility of transporting hydrogen by road are on a large scale worthwhile. As shown in one of our sensitivities, pipeline transport is necessary to achieve cost savings. This result is a significant difference to the study by vom Scheidt et al. (2022), in which only the transport of hydrogen by road is considered and this option is seen as profitable. Only through the cross-subsidisation of the pipeline transports, the increased costs of road transport are compensated in the presented base case. It is therefore recommended that the operator model is only used in combination with available hydrogen pipeline infrastructure.

The outcomes of our analysis also provide insights on the composition of the hydrogen supply costs and information about the competitiveness of available transport hydrogen options. The results show that the biggest contribution to the total supply costs is presented by the sourcing of electricity. It represents a share between 55% and 75% of the total supply costs. The costs linked to the electrolyzers contribute only to between 20% to 30% to the overall costs. Similar results are found by Robinius et al. (2017) and vom Scheidt et al. (2022). The cost mark-ups for the individual conversion and transport options vary substantially depending on the available modes.

Dedicated hydrogen pipelines offer viable transport options for hydrogen, serving not only to alleviate pressure on the electricity grid but also providing non-wire alternatives that reduce the need for grid expansion in the power system. To enhance the understanding of the synergies between gas pipeline and electricity grid infrastructure, further research into their interactions is recommended.

An important aspect to consider in this context is to evaluate the timely repurposing of existing gas infrastructure to prevent their costly underutilisation and explore new usages. Future research should therefore focus on the conditions for coordinated planning of both infrastructures to maximise economic utilisation of the existing facilities, which was only considered to a minor degree in the analysis. Moreover, since the preparation of the analysis, the underlying assumptions about the development of the energy sector have been modified by relevant governments, not least due to the war in Ukraine. This affects both the expansion targets for renewables¹² and the extent of the intended use of hydrogen. Furthermore, fuel and CO₂ prices projections have changed. These updates are not taken into account in the analysis. Since no significant acceleration of grid expansion has been observed recently, it can however be assumed that the observed effects are likely to be more pronounced, so that the assessed regulatory relaxations lead to higher cost and CO₂ emission savings. Even without updated targets for renewables and hydrogen use, the analysis in the Appendix B.1.5, which takes into account updated fuel and CO₂ prices, already confirms this trend. In addition to the integration of further technical details such as flexibilities through e-mobility and e-heating, a possible extension of this work could therefore also include an update of the assumptions (e.g. renewable targets).

3.7 Conclusion

Growing penetration of renewables, difficulties in the expansion of the electricity grid and new electricity demand through sector coupling technologies create new challenges in power systems. In recent years, increasing economic inefficiencies have been observed in markets with uniform pricing through rising structural congestion causing growing amounts of curtailed renewable electricity, redispatch needs and hence, costs. Due to changing conditions in the energy sector, driven by recent events (e.g. Ukraine war), it can be assumed that these challenges will increase rapidly in the near future. The rethinking of current market designs becomes therefore important to increase the economic efficiency of the system under transition. The production of electrolytic hydrogen through electrolyzers, which is at the heart of the sector coupling concept, is expected to play a key role in the deep decarbonisation of hard-to-abate sectors. The technology also offers valuable flexibility to relieve stress from the system and has attributes of a ‘non-wire’ alternative to investments in grid infrastructure. If installed in a non-system-beneficial way, electrolyzers could, however, even amplify the problems. Although different options exist to send spatial signals that foster capacity expansions to both the supply and the demand side in a system-supportive way, all of them have their advantages and disadvantages and none is considered a silver bullet solution (Hirth, Maurer, et al. 2019; Vogel and Bauknecht 2020).

In this study a set of three optimisation models is used to assess, for the case of Germany in 2030, whether regulatory derogation to allow TSOs being involved in the placement and in the operation of electrolyzers, increases economic efficiency. This exemption represents one regulatory possibility

¹² (German-Government 2023) In Germany, for example, the targets for PV installations were increased from 100 GW to over 200 GW by 2030. For offshore wind energy, an increase from 17 GW to at least 30 GW is planned.

to promote system-beneficial installations of new technologies. It is found that even moderate modifications of current unbundling rules help to better integrate renewable electricity and hence, to reduce both total system costs and CO₂ emissions. Compared to other possibilities that aim at sending locational signals for system-beneficial flexibility options, the analysed regulatory tool can result in economic benefits shortly, that effectively enable both a further integration of renewable electricity in times of grid expansion difficulties and an acceleration in the upscaling of electrolyzers to obtain learning effects, to reduce costs and to increase their competitiveness. As the current economics of electrolyzers do not yet allow for a purely market-driven introduction of the technology, financial support is still needed to make the technology competitive. This provides opportunities for temporary intervention by regulators in the early adoption of the technology, with only limited risk of harming competition in the markets. Consequently, while the analysed regulatory exception is not a market-based approach, which would be an economically preferred option, it can still result in valuable temporal contributions to the energy transition until more advanced and effective market signals are available to promote both system-beneficial and market-based placements of electrolyzers.

Due to the limited risk of harming competitive activities, we therefore propose that the possibility of regulatory exemptions as given by regulatory sandboxes might be further assessed to temporally empower TSOs in placing of electrolyzers at system-beneficial locations. The ability to incorporate market elements, such as competitive bidding, into the design of the process further supports this idea. The instrument should, however, only be used in combination with the availability of hydrogen pipeline infrastructure, as it enables the transport of clean energy at low cost across different regions. It is therefore also suggested that an evaluation of retrofitting possibilities of existing natural gas pipelines should become a higher priority.

Chapter 4

Establishing low-carbon hydrogen trade relations - where to go and who to partner with?

Contribution

It is published as a conference paper with the 18th International Conference on the European Energy Market (EEM): Johannes Brauer, Manuel Villavicencio, Johannes Trüby, *Establishing low-carbon hydrogen trade relations - where to go and who to partner with?*, 2022

Conference presentations:

- 18th International Conference on the European Energy Market EEM, 2022, Ljubljana
- European Research for Sustainable Development ERSD Conference, 2022, Paris
- 40th International Energy Workshop, 2022, Freiburg
- 1st IAEE Online Conference, 2021, online
- Various other exchanges e.g. Worldbank, GIZ diplomacy, H2-Global

Abstract

The timely creation of economic imports of clean hydrogen and its derivatives are considered a key element in achieving the EU's climate ambitions. Russia's invasion of Ukraine, however, caused a paradigm shift in EU energy trade policy giving security of supply aspects higher priorities than in the past. Therefore, as the establishing of hydrogen trade relations requires significant upfront investment outside the EU that can create long-lasting ties and potential supply risks, new partnerships and investments in clean hydrogen trade should target not only economic but also secure, sustainable, and timely supply options supporting a successful EU energy transition. We contribute to the discussion on creating appropriate EU import strategies and identifying suitable trade partners for clean hydrogen and ammonia.

A methodology is developed consisting of a detailed supply chain model and a multi-criteria analysis that allows potential export partners to be assessed both in terms of their cost competitiveness and with respect to their suitability as reliable trade partners. The considered soft factors include political, social, and economic aspects as well as a country's adaptability or technological know-how. We find that while Algeria, Morocco, and Ukraine show promising potential for economically viable hydrogen supply options, Norway and the UK are in addition also characterised by overall favorable conditions for meeting their commitments. For ammonia supply, additional promising partners are Canada, Chile, Israel, and Qatar. Saudi Arabia and Colombia are also economically viable options for ammonia supply, but with lower soft factor conditions. While Australia, New Zealand, Uruguay, and the US appear overall less competitive in terms of costs, they are characterised by high reliability. We conclude that while some of the recently signed memoranda of understanding target robust partnerships, other promising countries such as the UK, Norway and Israel are not yet on the list, suggesting further assessments of potential trade partners. In addition, we find that putting greater focus on political, economic, and social conditions of trade partners has only moderate impact on supply costs (less than 20% cost increase for hydrogen and 5% cost increase for ammonia in the long run), supporting the notion that it is worthwhile to not only look at costs when assessing potential partners.

Résumé

L'importation d'hydrogène propre et de ses dérivés en temps opportun est considérée comme un élément clé de la réalisation des ambitions climatiques de l'UE. L'invasion de l'Ukraine par la Russie a toutefois provoqué un changement de paradigme dans la politique énergétique européenne, mettant davantage l'accent sur les aspects de sécurité d'approvisionnement qu'auparavant. En particulier, le développement de relations commerciales hors UE dans le domaine de l'hydrogène peut représenter des risques en matière de sécurité d'approvisionnement. En plus des considérations économiques, le choix des partenaires et des investissements liés à l'hydrogène propre devraient donc intégrer des considérations liées à la durabilité, à la sécurité et à la fiabilité de l'approvisionnement. Cette partie se concentre sur l'identification de partenaires commerciaux appropriés pour l'export d'hydrogène et d'ammoniac propres vers l'UE. L'objectif est de contribuer à la discussion sur la création de la stratégie au niveau européen quant à ces importations.

Par un modèle détaillé de la chaîne d'approvisionnement et une analyse multicritère, les partenaires potentiels sont étudiés à la fois en termes de coûts et de leur aptitude à devenir des partenaires commerciaux fiables. Les facteurs pris en compte pour l'analyse multicritère comprennent les aspects politiques, sociaux et économiques ainsi que la capacité d'adaptation ou le savoir-faire technologique d'un pays. Si l'Algérie, le Maroc et l'Ukraine présentent un potentiel prometteur pour des options d'approvisionnement en hydrogène économiquement viables, la Norvège et le Royaume-Uni se caractérisent également par des conditions globalement favorables pour respecter leurs engagements. Pour l'approvisionnement en ammoniac, le Canada, le Chili, Israël et le Qatar sont des partenaires prometteurs, tandis que la Colombie et l'Arabie saoudite sont moins fiables malgré leur compétitivité économique. A l'inverse, l'Australie, la Nouvelle-Zélande, l'Uruguay et les États-Unis semblent globalement moins compétitifs en termes de coûts, mais ils se caractérisent par une grande fiabilité. Si certains accords d'entente récemment signés ciblent des partenariats solides, d'autres pays prometteurs tels que le Royaume-Uni, la Norvège et Israël ne figurent pas encore sur la liste, d'où la nécessité d'évaluer d'autres partenaires commerciaux potentiels. En outre, mettre davantage l'accent sur les conditions politiques, économiques et sociales des partenaires commerciaux n'a qu'un impact modéré sur les coûts d'approvisionnement (moins de 20% d'augmentation des coûts pour l'hydrogène et de 5% pour l'ammoniac à long terme), ce qui justifie qu'il est judicieux de ne pas se concentrer uniquement sur les coûts lors du choix des partenaires potentiels.

4.1 Introduction

Achieving carbon neutrality by 2050, as envisaged by the European Green Deal (EC 2019)¹, requires radical changes in today's energy system. Due to their physical characteristics (e.g. storage, transport, balancing over time), clean hydrogen and its derivatives such as ammonia provide promising possibilities to contribute to this ambitious goal. This is also recognised by the EU that sets them as pillars of the energy transition (EC 2020). As their overall demand is expected to increase substantially until 2050, an economically efficient and secure supply is necessary to keep costs at socially acceptable levels and to guarantee international competitiveness (Deloitte 2021; FCH JU 2019; Guidehouse 2021). For various reasons, however, it is unclear to what extent the EU can meet its demand with domestic resources in an economic manner: (1) limited low-cost resources, (2) competition of the most cost-competitive resources for various end uses, and (3) rising acceptance concerns that might hinder a sufficient exploitation of domestic renewable energies - "Not in my backyard" (Guidehouse 2021). Other locations around the world, however, are blessed with natural resources offering trade opportunities for an economically efficient allocation of global resources, as demonstrated for other energy commodities (Tagliapietra 2020). To exploit these potentials, hydrogen imports are envisaged as an integral part of future energy supply and are anchored accordingly in the EU's hydrogen strategy. Moreover, due to its unfavorable resource endowment, the EU has been highly dependent on energy imports to meet its energy demand and to ensure economic growth and the prosperity of society. As market forces have led to overdependencies on natural gas and hard coal imports from a small number of trading partners, including Russia (Just, Wild, and Arnold 2022), the Ukraine war has fundamentally changed the landscape of energy trade for the EU. The REPowerEU plan (EC 2022), published in May 2022 as a result of the geopolitical situation, initiated a paradigm shift in EU foreign trade policy having long-lasting implications on future trade of energy commodities and international partnerships. Greater importance is given to reliability and security of energy supply considerations.

Supported by substantial public money², policymakers and private actors are currently setting the course for creating international partnerships to enable imports of clean hydrogen and its derivatives. In recent months, numerous memoranda of understanding have been signed with potential export countries and initiatives such as H2-Global created to provide financing instruments for establishing import streams. The build-up of this trade-oriented hydrogen infrastructure is a multi-billion investment endeavour that lays the foundation of international hydrogen trade which might tie suppliers and consumers together in long-lasting arrangements (Keppler 2007; Sutrisno, Nomaler, and Alkemade 2021). Betting on ill-considered sourcing strategies could result in costly deals for decades and supply risks. Given the expected critical role of hydrogen in economic well-being and prosperity, investments should therefore be well assessed to target partnerships that lead to economic, sustainable, secure, and timely supply options contributing to a successful energy transition in the EU. As such, the selection of partners and investment options should not be limited to supply costs, but also consider broader economic, political, and social aspects related to potential trade partners

¹ Anchored in law in 2021 with the European Climate Law (EC 2021).

² For example, 2 billion euros from Germany (BMW 2020b).

to balance adequately security of supply and costs. By developing a methodology for evaluating supply options based on cost parameters and non-cost aspects, we contribute to the discussion on the development of procurement strategies for hydrogen and ammonia that target both economically viable and reliable supply options.

The remainder of the work is organised as follows: in Section 4.2, we give an overview of the relevant literature and discuss aspects of the international trade of energy. Section 4.3 presents both the methodology used and the underlying data. Next, the results of our analysis are presented (Section 4.4), which are then discussed in Section 4.5. The paper closes with a conclusion (Section 4.6).

4.2 Context and literature review

International energy trade plays an important role in the world economy. Driven by the uneven distribution of fossil resources and by national incentives to increase economic efficiency in accordance with the theories of Smith (1776) and Ricardo (1817)³, the volumes of energy traded internationally have increased in recent decades. Today, 71% of oil, 32% of natural gas, and 23% of coal are traded internationally⁴ (BP 2019). This represents 15%⁵ of all globally traded goods (Van de Graaf 2019). The importance of international energy trade is also reflected in the literature. While the economic masses and the distances between economies have been identified in trade economics⁶ as general key drivers for trade activities of various goods among countries (Kepaptsoglou, Karlaftis, and Tsamboulas 2010), trade of energy is mostly underpinned by the ‘natural’ rather than the ‘normal’ comparative advantages⁷ resulting from the geographical distribution of fossil resources (Van de Graaf 2019). Although geographical distances have influenced trade patterns historically mostly because of the physical properties and the ability to transport energy, their impacts have been decreasing. Nevertheless, they still play a role in determining trade patterns (Bachmeier and Griffin 2006; Barnes and Bosworth 2015; Sutrisno, Nomaler, and Alkemade 2021).

Moreover, as supply of energy is vital for our societies, the high concentration of global fossil fuel resources cause ‘unavoidable’⁸ dependencies on trade partners - the reason why energy has shaped global geopolitics, wars, and alliances. While the abundance of natural resources gives their owners geopolitical power, their lack causes vulnerability and risk exposure (Pflugmann and Blasio 2020; Scholten and Bosman 2013). During the first oil crisis in the 1970s many import-dependent economies faced major supply risks due to too narrow supply structures, limited substitution possi-

³ According to the theory of Adam Smith from 1776 (*The Wealth of Nations*) and David Ricardo from 1817 (*On the principles of political economy and taxation*), economies with comparative advantages in producing a good or a service engage in trade with others to export them. As a result of the trade overall, economic efficiency increases.

⁴ Based on 2018 values; Shares expressed in terms of consumption.

⁵ Includes also trade in mining products.

⁶ As part of the gravity model, that has been widely used to trade relations of various goods; Economic masses describe the sizes of the economies; Distances refer to both geographical distances and other aspects such as the distances between cultures.

⁷ The ability of a country, in the classical sense, to produce a good or service at a lower opportunity cost than another country, based on economic conditions.

⁸ Theoretically in the long-term any desired level of energy security can be reached which is just a matter of the costs and the environmental effects (Keppler 2007).

bilities and inelasticity of oil demand. Since then, the awareness of dependences and their associated geopolitical risks have become one main driver of energy trade patterns. Consequently, in addition to comparative advantages, aspects linked to security of supply measures have affected global trade flows (Sutrisno, Nomaler, and Alkemade 2021; Tagliapietra 2020). Geopolitical risks describe events and factors that fuel existing or new tensions and conflicts between states. From an importer’s perspective, geopolitical risks in international energy trade therefore refers to economic, political and social aspects in the producer and transit countries that could threaten supply security (Caldara and Iacoviello 2018; Muñoz, García-Verdugo, and San-Martín 2015; Checchi, Behrens, and Egenhofer 2009). There is no common definition of ‘security of supply’ (Ang, Choong, and Ng 2015), however, the IEA describe it as the ‘uninterrupted availability of energy sources at an affordable price’ (IEA 2019a). In addition to geopolitical risks, geological, technological, environmental, and broader economic risks are also considered threats to supply (Checchi, Behrens, and Egenhofer 2009). The reduction of these risks is therefore targeted by energy security measures. In addition to diversification and the ability to flexibly switch between different supply options through access to liquid global markets, engagement in reliable partnerships is seen as an effective approach to risk management.⁹ Investing in energy security implies accepting higher costs in the short-term to avoid potentially greater costs in the long-term. Consequently, energy security represents a trade-off between competing objectives (Keppler 2007; Sutrisno, Nomaler, and Alkemade 2021).

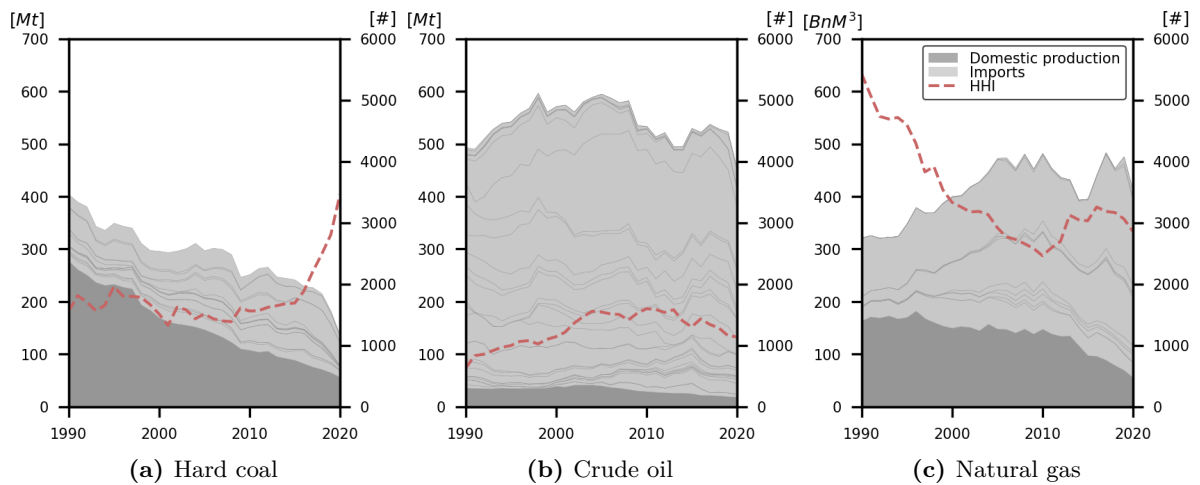

Figure 4.1: Evolution of energy supply in the EU¹⁰

The EU has been playing an active role in the international trade of energy as a net energy importer. Between 1990 and 2020 the total demand of hard coal halved, it increased for natural gas and remained at similar levels for crude oil (see Figure 4.1). However, the domestic provision

⁹ However, preferences in the choice of these approaches vary between economists and politicians. While economists claim that energy matters are subject to market rules only, and that political intervention is only required if markets fail, foreign policy analysts argue that nationalisation and politicisation of energy resources by countries with resources make energy security a national concern that requires government intervention and international cooperation. However, the general understanding is that both angles are complementary and hence, important to provide holistic solutions (Checchi, Behrens, and Egenhofer 2009).

¹⁰ Hard coal: (Eurostat 2022c; Eurostat 2022f) - siec-code: C0100; Crude oil: (Eurostat 2022b; Eurostat 2022e) - siec-code: O4100_TOT; Natural gas: (Eurostat 2022a; Eurostat 2022d) - siec-code: G3000; The HHI refers to imports only.

of volumes reduced for all three energy carriers so that the shares of imports increased. Despite low domestic oil resources and a low share of local production over demand, the EU managed to successfully diversify its import portfolio. While import concentration represented by the Herfindahl-Hirschman Index (HHI)¹¹ increased in the 1990s and early 2000s, it remained at a constant level since then. Although the EU is blessed with greater domestic resources of natural gas compared to oil, domestic production halved over the last 30 years, while demand increased. Whereas the transport of natural gas via pipelines shows overall beneficial economics compared to its seaborne shipping (as Liquid Natural Gas - LNG), it reduces supply flexibility as producers and consumers are tied in long-lasting arrangements. While some countries without the possibility of pipeline imports of natural gas such as Japan built-up supply structures entirely based on seaborne transport, other players have benefitted from resources in proximity and the possibility of pipeline imports, which is the case for the EU (Tagliapietra 2020; Barnes and Bosworth 2015). Consequently, the access to cheap natural gas resources from its neighbours, in particular from Russia and Norway, increased its concentration in the import portfolio. Despite increasing trends, LNG imports only accounted for 29% in 2021¹². Compared to oil and natural gas, resources of coal are widely distributed globally. Their accessibility, however, differs and affects production costs (Tagliapietra 2020). As the competitiveness of domestic EU resources declined, especially that of hard coal, the incentive to increase economic efficiency led to increasing shares of imports from Russia over the last 20 years. Despite the awareness of geopolitical risks to energy security and the announcement of strategies to reduce these risks, such as the ‘Green Paper’ (EC 2000), the EU’s has prioritised lower costs in the trade-off between security of supply and affordability in the procurement of natural gas and hard coal. The construction of the Nord Stream 2 pipeline is another indication of this choice. However, the surge in energy prices after the first half of 2021 has made it clear that access to low-cost energy in the past has come at the expense of current and future energy prices. Since the energy transition requires a radical restructuring of today’s energy supply, the creation of hydrogen imports, which are an integral part of the new supply structure, offer the opportunity to learn from the past and address corresponding weaknesses.

Hydrogen is a chemical energy carrier which can be stored and transported. Unlike coal, oil and natural gas, however, hydrogen hardly exists in pure form in nature and must be produced. In the literature, two alternative production routes¹³ are discussed that show promising potentials while meeting the corresponding requirements in regards to CO₂ emissions (EC 2020; Ueckerdt et al. 2022): Equipping the steam methane reforming process (SMR), that is the predominate production route today¹⁴, with carbon capture and storage capabilities (CCS) is one technology route. The CO₂ emissions produced by the thermal treatment of natural gas are not released into

¹¹ The HHI is widely established and commonly in the field of energy economics and energy supply security (IEA 2007; De Rosa et al. 2022).

¹² (BP 2022) 2021 values.

¹³ There are other potential production technologies that are discussed. However, they are not expected to play a major role in the mid-term. An example is the pyrolysis process, which is an alternative technology that can be used to produce low-carbon hydrogen from natural gas. However, the technology is at a very early development stage and still only tested in some laboratory applications. As many uncertainties remain on the marketability, the technology is not further considered within the analysis.

¹⁴ The steam methane reforming process (SMR) extracts hydrogen from natural gas in a thermal process. The process accounts for about 80% of all hydrogen produced globally. 9 kilogram of CO₂ emissions result for every kilogram of hydrogen produced (IEA 2019c).

the atmosphere but are captured by carbon capture stages and then stored in suitable geological formations. The produced clean hydrogen is also referred to as ‘blue hydrogen’. The production of hydrogen through the electrolysis process is another technology route. The process uses electricity to split water into its constituent elements of hydrogen and oxygen. Since electricity is the only input to the process besides water, the produced hydrogen is free of direct CO₂ emissions provided the electricity comes from CO₂-neutral sources such as renewable energy technologies or nuclear energy. Although the technology is not yet competitive at industrial-scale despite many years of development (IEA 2019c), its economics are expected to improve substantially in the coming decades due to two reasons: (1) Further expected cost declines in solar PV and wind technologies for providing low-cost electricity, and (2) learning effects as well as economies of scale through the widespread exploitation of electrolyser technologies similar to those observed for renewable energy technologies in the past two decades (IRENA 2020b). Hydrogen produced from renewable electricity is also referred to as ‘green hydrogen’. Both technologies can be deployed in a wide range of countries offering opportunities for international trade. However, as most hydrogen today is produced in a captive manner, its transport over long distances has not yet been explored (IRENA 2022a). Nevertheless, different options are discussed in the literature. Since gaseous hydrogen has a low volumetric density under normal atmospheric conditions, similar to natural gas¹⁵, their transport characteristics are comparable. Consequently, pipelines offer one suitable transport option¹⁶. While the construction of long cross-border pipeline links with extra-EU countries can be complicated and time consuming due to technical and geopolitical reasons¹⁷, only limited technical modifications are needed to retrofit existing natural gas infrastructure allowing for dedicated hydrogen transports (Cerniauskas et al. 2020). Given the expected decrease in natural gas demand in the coming decades (IEA 2022c), spare pipeline capacity to the EU is expected to become available. In addition, hydrogen can also be liquefied to overcome its low volumetric density for seaborne transport similar to natural gas. The liquefaction of hydrogen is energy intensive, however, and a regasification step would be required at the destination location (IEA 2019c). The conversion of hydrogen into other molecules offers further possibilities to increase its volumetric density and allow it to be transported via sea route (Wijayanta et al. 2019). In this context, the conversion into ammonia (NH₃) or into liquid organic hydrogen carrier (LOHC) are the two most promising options discussed in the literature. Ammonia is produced in a synthesis process (Haber-Bosch) that combines hydrogen with nitrogen (N). While the reconversion of hydrogen from ammonia after transporting it is not necessarily needed due to end uses that directly require ammonia (e.g., production of fertilizer, fuel in future maritime sector), the ammonia cracking process enables the separation of the hydrogen from the nitrogen at the destination port again so that it can be used in dedicated hydrogen applications (Salmon and Bañares-Alcántara 2021). Unlike ammonia, there is no direct end use for LOHCs so that the transported hydrogen

¹⁵ In gaseous form with low volumetric density.

¹⁶ Hydrogen can be transported either in a dedicated pipeline infrastructure or blended to some extent into the natural gas pipeline transport. Blending levels between 5%-15% seem to be reasonable without any technical modifications. However, once blended into natural gas, the extraction from it requires significant efforts and is therefore not seen as an economically viable option (Ogden et al. 2018).

¹⁷ A prominent example of such an undertaking is the construction of the Nord Stream 2 pipeline linking Russia to Germany which caused geopolitical tension and resulted in almost double the costs initially envisaged (Lang and Westphal 2017).

must be re-extracted from the compound before it can be used. While hydrogenation combines hydrogen with a carrier material (e.g., toluene, etc.) to form LOHCs, the dehydrogenation process cracks the compound again. The carrier material is returned to the loading port once the hydrogen is separated at the destination port. Since LOHCs have similar characteristics to crude oil, their transport possibilities benefit from many years of experiences, well-established handling processes and existing infrastructure (IEA 2019c; Niermann et al. 2019).

Several studies have already focused on the international transport and trade of hydrogen. Due to the importance of the expected role of hydrogen and its derivatives in the energy transition, research interest in this topic has increased in recent years. The existing literature on hydrogen trade can be split roughly into three research streams. The first group of publications discusses qualitatively the challenges and opportunities of the creation of an international hydrogen market. Examples of this group are given by Scholten, Bazilian, et al. (2020) and Grinschgl, Pepe, and Westphal (2021). The authors point out that this new market has the potential to transform existing energy trade flows resulting in opportunities for new players, reshaped trade cooperation, as well as new potential conflicts among actors. They highlight the need for policy makers to take actions in setting up the overall entry conditions for the market creation and trade relations in an adequate manner. A second research stream focuses on the techno-economic aspects of international hydrogen supply options. Baroni (2021), Brändle, Schönfish, and Schulte (2021) and Heuser et al. (2020) are examples that study the supply of gaseous hydrogen options. The authors use supply chain models to determine the costs for the supply of hydrogen to different locations. They highlight the significant uncertainties on the cost-evolution in production and transportation technologies of hydrogen. These publications focus entirely on the provision of green supply options and do not consider the possibility to trade clean hydrogen produced from natural gas. The third branch of publications on international hydrogen trade targets quantitative assessments of non-cost related parameters that influence the creation of international hydrogen markets. The authors use multi-criteria analysis to assess the specific countries' abilities to become important actors. The publications of Pflugmann and Blasio (2020), Hjeij, Biçer, and Koç (2022) and Breitschopf et al. (2022) contribute to this research stream. Among others they aim at identifying aspects and parameters that are important for the creation of trade-oriented hydrogen economies.

To summarise, hydrogen is expected to play a major role in achieving the EU's ambitious climate goals. Its broad potential of resources globally offers necessary import options to supplement domestic resources. As there is no international market to date, the EU foresees partnerships and bilateral arrangements to initiate trade. In addition to aspects related to the affordability of imports, conditions for sustainability, reliability and the urgency of a timely energy transition are gaining priority. So far, however, the existing literature on international hydrogen trade focuses on these aspects individually and remain within their respective research streams. Therefore, there is a need to bridge the research gap with cross-sectoral approaches. This study aims to contribute to the discussion of the creation of an adequate EU trade strategy of low-carbon hydrogen and ammonia. By developing a cross-sectoral approach, we shed light on which countries show suitable potentials to act as export partners for the economic, sustainable, secure, and timely supply of clean hydrogen and ammonia to the EU.

4.3 Methodology and data

We propose an approach consisting of four steps to combine both cost-based and non-cost-based parameters (Figure 4.2) to identify possible clean hydrogen and ammonia suppliers. Step 1 aims at pre-filtering all potential exporters of clean hydrogen and ammonia to the EU based on a set of ‘hard criteria’. Countries that do not meet the criteria are excluded from our analysis. The resulting selection of potential partner countries serves as the basis for a detailed analysis of both cost-based parameters leading to the ‘Competitiveness-Index’ (Step 2) and non-cost-based aspects resulting in the ‘Soft-Factor-Index’ (Step 3). In the fourth step, the resulting indices are then assessed jointly. While the individual steps are described in the following subsections, further information on the methodology and on the underlying data are also given in the appendices. The approach enables the assessment of import options with respect to their temporal evolution. In our analysis, we therefore integrate both short-term and long-term perspectives, represented by the years 2030 and 2050, respectively. Moreover, to also account for uncertainties in the evolution of key parameters, different cases are assessed.

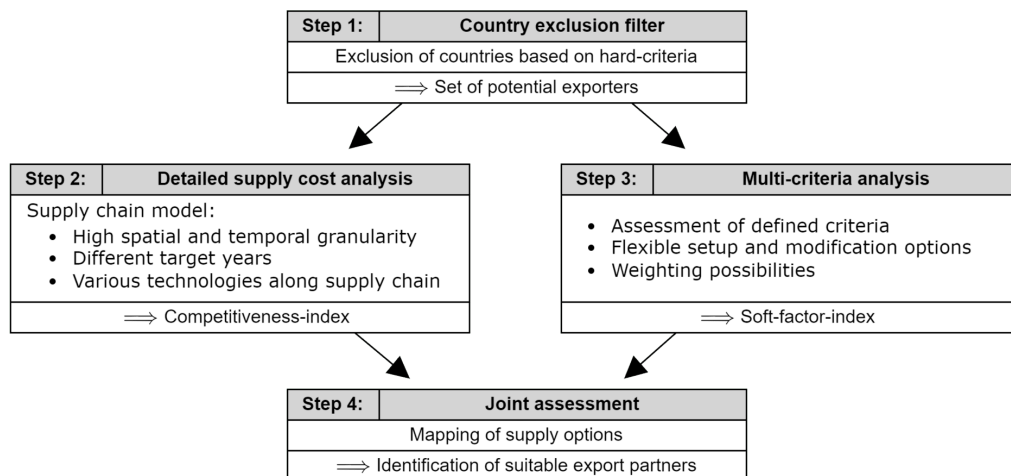

Figure 4.2: Overview of methodology

4.3.1 Country exclusion filter

From a resource perspective, not all countries outside the EU are sufficiently suited to become sustainable exporters of clean hydrogen. This first step aims at pre-filtering the countries of the world and excluding those that are not sufficiently well suited. The exclusion process is based on four defined ‘hard criteria’, which are listed below. Only countries that meet all criteria are considered as potential exporters to the EU in the following steps of the analysis. Moreover, Russia is excluded for political reasons, as envisaged in the REPowerEU plan (EC 2022). The hard criteria include:

- Countries that belong to the EU are excluded as potential export countries as they are part of the common EU hydrogen strategy.

- Countries without an existing natural gas pipeline to the EU or without access to international waters through at least one deep-water port are excluded. Corresponding data for pipeline connections are derived from Guidehouse (2022). Information on deep-water ports are taken from World Bank (2020a).
- Countries having only limited renewable resources¹⁸ within their territories to decarbonise their own energy systems are excluded. This criterion aims at ensuring that potential exports happen in a sustainable manner and that trade with the EU does not hinder the local energy transition. The corresponding approach is based on Pflugmann and Blasio (2020). It considers the combined annual yield of all solar PV and onshore wind resources of each country. Countries whose combined renewable production yield does not exceed current energy consumption by a factor of 2.5 are excluded¹⁹. The considered data for the demand are taken from EIA (2022d), the solar PV potential comes from Pietzcker et al. (2014) and the study of Bosch, Staffell, and A. D. Hawkes (2017) is used for assessing the wind potential.
- Countries with no credit ratings²⁰ are disregarded, as investors' risk perception would be too high.

4.3.2 Detailed supply cost analysis

The second step of the analysis assesses the cost competitiveness of all potential exporters based on their corresponding supply costs. Inspired by Baroni (2021), Brändle, Schönfisch, and Schulte (2021) and Heuser et al. (2020), we develop a detailed supply chain model to determine the least cost supply route from a given production location outside the EU to destination locations within the EU. Each supply chain consists of seven elements, as illustrated in Figure 4.3: three edges that link four nodes. They all start at the hydrogen production node in the export country, from where the hydrogen is transported via the national transport edge to an exit node placed in the same country. At the exit node, conversion steps might take place to prepare the volumes for the international transport edge. From the exit node, they are then shipped (international transport edge) to the entry node. Once they have landed in the import country, the volumes are transported via the EU transport edge to the demand node in the destination country. Depending on the required energy carrier at the demand location, additional conversion steps might be required at both the entry and/or the demand node. Each element of the supply chain can be assigned to either upstream (production), midstream (transport and conversion) or downstream (delivery) of the supply and is associated to costs that are expressed per unit delivered. The total supply costs for one unit delivered via the corresponding route is obtained by adding up all cost elements. The flexible structure of the model allows the study of a variety of different technologies along the entire supply chain and the identification for given conditions of the most competitive technology route between production and demand locations. We develop a mathematical optimisation problem for this purpose. As spatial

¹⁸ Resources that are technically and economically viable.

¹⁹ The factor 2.5 is chosen to also account for possible increases in energy demand, losses within the local transmission network, potential overestimated renewable potentials due to missing detailed site-assessments and the consideration of sites with only low natural resources which affects energy costs negatively.

²⁰ By Moody's; see Damodaran (2022).

information such as distances and location-specific aspects play an important role in the analysis for the adequate representation of real-world conditions, a preparatory step takes place prior to the optimisation where numerous spatially resolved data are collected.

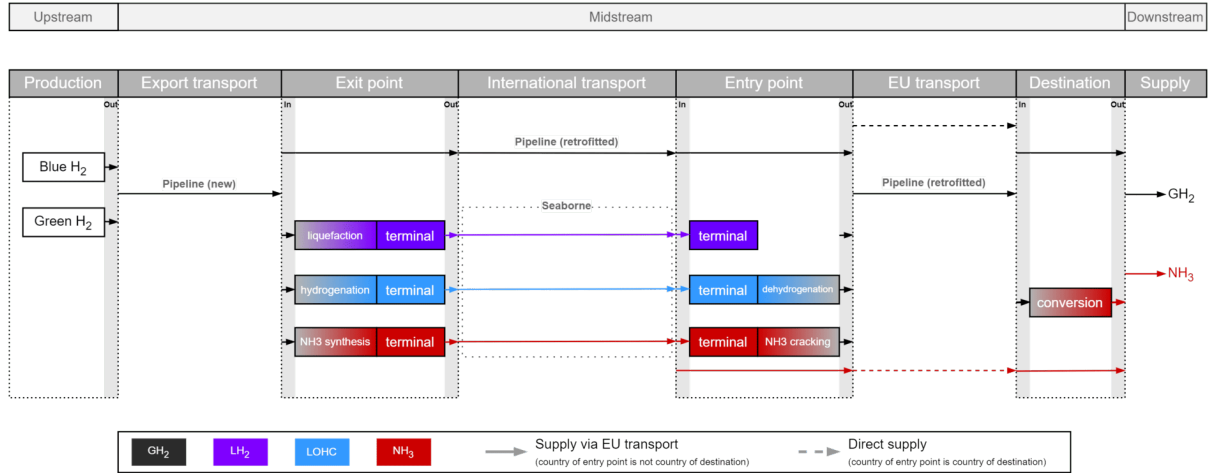

Figure 4.3: Overview of hydrogen supply options

4.3.2.1 Downstream

There are multiple forms in which hydrogen can be used (e.g., pure form, methanol, synthetic fuels). However, this analysis focuses on EU imports of clean hydrogen in gaseous form and ammonia, which are expected to present major shares in final energy consumption in a decarbonised European energy system. While the applications of clean hydrogen are very diverse (e.g., road transportation, industry, heating), the role of clean ammonia is more specific and reduced to fewer purposes (e.g., maritime transport, industrial feedstock). However, since this study focuses on international trade relations and imports to the EU more broadly, we do not consider any specific end-uses.²¹ Consequently, our analysis stops at the border of the destination country within the EU. Moreover, the projected hydrogen and ammonia demand in the individual EU member states differs substantially, which is likely to affect the need for imports. Therefore, to reduce complexity, only Belgium, Germany, Spain, France, Italy, the Netherlands and Poland are considered as destination countries for imports, since these countries represent major shares to the overall projected EU hydrogen demand²². Hence, the supply of one unit of clean hydrogen from any place in the world to the EU means that this one unit is supplied to the seven determined destination countries whereby it is split proportionally according to each country's estimated share of demand (Table 4.1).

²¹ Processing steps at the final demand location such as the compression of gaseous hydrogen to 900 bars at the re-fuelling station of fuel cell electric vehicles are not considered in the supply chain optimization. However, supplied hydrogen is assumed to be in gaseous form.

²² (Guidehouse 2021); Countries with share greater than 5% of the projected EU demand of the industrial, transport, and power sector.

Country	2030	2050
Belgium	8%	7%
France	12%	13%
Germany	32%	33%
Italy	18%	17%
The Netherlands	10%	9%
Poland	10%	11%
Spain	11%	12%

Source: (Guidehouse 2021); Countries with share greater than 5% of the projected EU demand of the industrial, transport, and power sector.

Table 4.1: Distribution of hydrogen import volumes

4.3.2.2 Midstream

The midstream captures all transport and conversion steps between production and demand locations. While the national transport in the export country is assumed to take place in newly built dedicated hydrogen pipelines²³, for the hydrogen transport through international pipelines (from exit point to entry point) as well as for the transport within EU, the shipping is considered via retrofitted pipelines. The availability of retrofitted pipelines is based on Guidehouse (2022) (see Figure C.28). In addition to the pipeline transport, seaborne routes are taken into account for the international transport (international transport edge). The choice of which route is available depends on the given infrastructure (e.g., proximity to deep-water ports, pipeline connection to the EU etc.). Various technologies are available for maritime transport. The cost-optimal choice of a technology is dependent on a variety of different parameters (e.g., transport distance, energy and financing costs) that are case-specific and to be assessed individually for a given import option. To remain technologically neutral, we therefore consider the three most promising technologies that are discussed in the literature, namely the transport of hydrogen in the form of ammonia (NH₃), liquified hydrogen (LH₂) and liquid organic hydrogen carriers (LOHC). While we calculate distances of sea routes using the Eurostat/searoute tool²⁴, we derive pipeline lengths using geographic information system data.²⁵

4.3.2.3 Upstream

Both blue and green hydrogen production are considered in this analysis. Various elements such as the costs for the corresponding system elements (e.g., CAPEX, OPEX), for the natural gas feedstock, for the abatement of the remaining emitted CO₂, and for the storage of the captured CO₂ are included in the calculation of blue hydrogen production costs²⁶. While the residual CO₂ emissions are offset by the projected costs of CO₂ allowances²⁷, the feedstock costs are assumed to be

²³ There might be the possibility to repurpose exiting natural gas pipelines for the transport of hydrogen from the production location to the exit point. However, due to the given limited available information about natural gas pipelines and their repurposing in the export countries, we omit this possibility.

²⁴ Github repository: <https://github.com/eurostat/searoute>; Accessed: 02.01.2021.

²⁵ Correction of beeline distance by a factor of 1.3 to account for a realistic course of the pipelines. More detailed information on the individual supply routes, their representation, and their parameters including assumptions on costs can be found in the Appendix C.3.

²⁶ We assume best available technologies for methane emission reduction to be implemented. According to the IEA (2021a) significant shares of methane emission from fossil fuel operation can be reduced in the short-term with existing technology and at no net costs. Residual methane emissions are disregarded.

²⁷ (IEA 2022c) Announced Pledges Scenario.

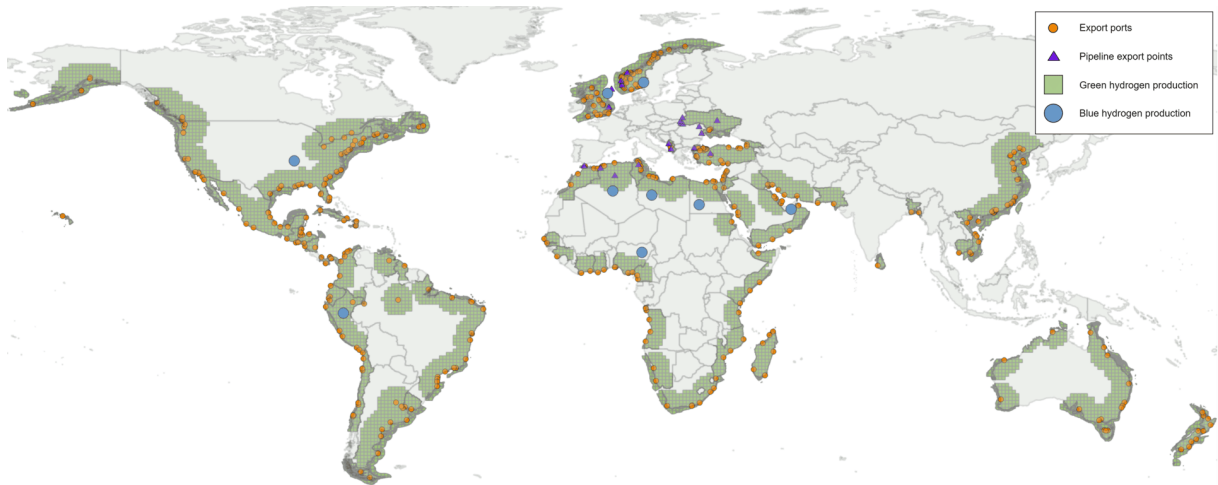

Figure 4.4: Map production locations and export points

the breakeven costs of natural gas of the producing country²⁸. Moreover, only pre-selected countries that were recently exporters of natural gas to the EU are considered as potential blue hydrogen exporters²⁹. This is different for green hydrogen. Despite considerable differences in potential among the countries, renewable energy resources are available in all of them. Therefore, all pre-selected countries could become potential exporters of green hydrogen. To ensure that the produced green hydrogen respects the EU requirements on the allowed carbon content, we only consider ‘off-grid settings’³⁰, where the electrolyser systems are linked directly to renewable energy facilities. Given their promising perspectives for low-cost electricity, we consider offshore wind, onshore wind, solar PV, as well as hybrid systems, an optimised combination of solar PV and onshore wind, as electricity sources to produce green hydrogen.

Moreover, the availability of renewable resources is location-specific and can vary from region to region, especially within large countries where the weather conditions can be very diverse, affecting hydrogen production costs. Therefore, to account for regional differences in resources and to capture adequately the countries’ potentials, we consider both the solar irradiance and the wind speeds at a high spatial granularity. All pre-selected countries are therefore split into raster cells with a resolution of 1 Decimal Degree³¹ (Figure 4.4). The potential of each raster cell is evaluated individually. This assessment includes (1) the geographical position and distances to available export points³², (2) the renewable energy potential and (3) the suitability of the land to exploit renewable energy technologies and to produce green hydrogen. The latter considers a variety of different aspects such as the terrain conditions, water availability, the risk of droughts, potential restrictions due to protected areas, land use data as well as information about the distances and proximities to urban settlements. All listed aspects are important with respect to the sustainability of the exports. Only the areas within a cell

²⁸ Obtained from Egging and Holz (2019).

²⁹ (Eurostat 2022a): Algeria, Egypt, UK, Libya, Nigeria, Norway, Peru, Qatar, Trinidad and Tobago, USA; Other smaller suppliers are not considered.

³⁰ CO₂ emissions of ‘Ongrid settings’ are linked to the electricity mix of the producing country.

³¹ 1 Decimal Degree corresponds to approximately 111 km x 111 km at the equator. However, only cells that are within 500 km to one or more exit points are considered.

³² The cell centroid serves as reference point.

that fulfil all defined requirements for the exploitation of renewables energies and the production of green hydrogen are further considered. Moreover, the optimal system setup (ratio of electrolyser-to-renewable capacity) that minimises hydrogen production costs can vary among the individual cells depending on the location-specific conditions. This includes the renewable energy potential but also other aspects such as country specific component costs and financing conditions. Therefore, within the preparatory step, we determine the optimal system configuration of each raster cell and each year assessed individually in a separate optimisation problem³³.

4.3.2.4 Financing costs

Hydrogen projects are exposed to different types of risks. To account for and compensate for these, investors adjust their return expectations accordingly, which is reflected in the financing conditions of the projects. The financing costs are included through the weighted average cost of capital (WACC)³⁴. We follow the approach proposed by Egli, Steffen, and Schmidt (2019) where the WACC is the sum of a risk-free rate and a risk premium. The risk premium can be further split into risks related to the country where the project is located (systematic risk) and risks linked to the project itself and its technical components (unsystematic risk) (IEA 2021c). While we consider the rate for the US treasury bill for the risk-free rate (OECD 2022), we estimate country risks from Damodaran (2022), and assume the project risk to be 4% throughout the study.

4.3.2.5 Supply chain optimisation

A mathematical optimisation problem is formulated to identify the most economic technology route between production and demand locations. It brings together all information derived from the preparatory step and considers all possible combinations of technologies and paths between the two points. The objective function that minimises total supply costs of the energy carrier w from a production location l in year y to the EU is given by expression (4.1). It sums the costs at all elements of the supply chain.

$$\min \quad \text{LCOH}_{l,w,y}^{\text{supply}} = c_{l,w,y}^{\text{prod}} + c_{l,w,y}^{\text{trans}} + c_{l,w,y}^{\text{conv}} + c_{l,w,y}^{\text{term}} \quad (4.1)$$

Where c^{prod} is the hydrogen production costs, c^{trans} the costs for the transport, c^{conv} all costs linked to conversion processes and c^{term} the costs that occur at import and export terminals for the handling of volumes. The entire optimisation problem including all conditions and constraints is provided in Appendix C.3.1.1.

³³The consideration of the temporal distribution of renewable resources over a year is hereby important, particularly in the case of hybrid systems, where complementarities between solar and wind resources help minimise hydrogen production costs. Therefore, we consider a high temporal granularity of hourly timesteps in the analysis. We take hourly resource data from ECMWF (2022) for the reference year 2016. Moreover, these hourly profiles are adjusted by long-term resource observations at the locations to correct for possible bias introduced through the choice of the weather year (DTU 2022; World Bank 2020b).

³⁴The ratio between equity and debt is assumed to be equal in this study allowing us to disregard further aspects linked to their leverage.

4.3.2.6 Competitiveness-index

The results of the supply chain optimisation serve to derive the Competitiveness-Index. It expresses the position of a country with respect to its cost-competitiveness in supplying green and blue products in a given year to the EU. To determine the index, we first identify the most competitive supply option in a country among all the supply options evaluated (all assessed grid cells). We then rank the resulting group of the country's best supply options and normalise it. Indices fall between 0 and 1, where the country with the most competitive supply option has the value 1. Consequently, the Competitiveness-Index represents the relative rank of a supply option within the set of all supply options. This means that countries with indices between 0.8 and 1 are among the top 20%.

4.3.3 Multi-criteria analysis

In addition to the cost-based evaluation of potential exporters, our analysis is complemented by the assessment of broader economic, political, and social aspects. Multi-criteria decision analysis (MCDA) provides a suitable framework for this purpose. In MCDAs, different alternatives are ranked based on a variety of predefined criteria to provide decision makers with a better understanding of the relationships between the alternatives and the evaluated criteria (Roy 1990; Cavallaro and Ciruolo 2005). MCDAs have been used widely and various different methods have been developed in recent years³⁵ (Mardani et al. 2015). Within this study we choose the 'weighted sum methods' or WSM, which is suitable for such a type of analysis as shown by studies on similar subjects (Hjeij, Biçer, and Koç 2022; He, Lei, and Ge 2014; Breitschopf et al. 2022). It is also one of the simplest and most widely used methods in MCDA, which supports the requirement that ranking methods should be simple to guarantee consistency and transparency (Gamboa and Munda 2007). In WSM, each criterion is first weighted by a predefined factor before the weighted values of all criteria are summed up.

4.3.3.1 Assessment criteria

Inspired by Breitschopf et al. (2022), IRENA (2022a), Hjeij, Biçer, and Koç (2022) and He, Lei, and Ge (2014) five criteria are identified that are considered important in assessing the ability of countries to build export-oriented hydrogen industries in a reliable, sustainable, economic, and timely manner. Moreover, despite different names, the criteria also refer to the five aspects related to geopolitical risks of exporting countries according to Muñoz, García-Verdugo, and San-Martín (2015). Each of the five criteria is described by two sub-criteria that contribute equally to their superior class value. More information on the individual indicators and the underlying data are provided in Appendix C.4.

- **Political aspects** - Political conditions in exporting countries are an important aspect of building reliable trade relationships. As political instability can lead to costly supply disruption risks, this criterion takes into account aspects of political stability as well as the existence of the rule of law.

³⁵ As the individual methods lead partially to different results, which is also referred to as "the decision-making paradox", none of them is a silver bullet.

- **Internationalism** - The timely development of export-oriented hydrogen infrastructure requires the import of goods and the handling of materials as well as industrial-scale equipment. Moreover, foreign partners and international experts are hosted for short or long periods to establish and maintain business relations. Therefore, adequate infrastructure with possibilities to interact internationally as well as a sophisticated degree of internationalism within the country are important.
- **Adaptability** - The countries' adaptability to start and develop new industries is another important aspect for a timely creation of a domestic as well as an export-oriented hydrogen industry. This includes aspects linked to administrative and bureaucratic processes, often referred to the 'ease of doing business', as well as the qualification of the local workforce to support new business activities and industries.
- **Know-how** - This dimension addresses aspects related to the country's experience in handling gases and in the exploitation of renewable energy resources. An adequate level of existing know-how gives confidence in the successful development of a clean hydrogen economy in a timely manner as fundamental know-how and corresponding skills are already available. Moreover, the existing exploitation of renewable energies provide evidence on the commitment to climate objectives of the export country which serves as a side effect within this criterion.
- **Social aspects** - From a European perspective, sustainable supply of hydrogen products also requires that common EU values with respect to human rights and equality are respected. Additionally, aspects linked to fighting corruption are also part of this category to make sure that the local population benefits from the activities and revenues generated by hydrogen exports.

While other studies such as the one from Breitschopf et al. (2022) integrate more criteria in their assessment, the authors find that more criteria on related topics increase complexity rather than add insights, as these tend to be positively correlated. We therefore consider a limited number of criteria.

4.3.3.2 Soft-factor index

The WSM assesses the criteria listed above and results in a value between 0 and 1 for every potential export country and evaluated year. The higher the value, the more suitable the soft factors of the country are for becoming a reliable hydrogen exporter to the EU. Like the Competitiveness-Index, we rank and normalise the resulting country values to obtain the Soft-Factor-Indices, which take values between 0 and 1, where 1 represents the most suitable exporting country.

4.4 Results

The presentation of the results focuses on the 'base case' assumptions. However, an in-depth sensitivity check is conducted to enrich the analysis and to account for uncertainties in the evolution of various parameters over the next decades. It is provided in the Appendix C.2.2.2.

4.4.1 Prefiltering of countries

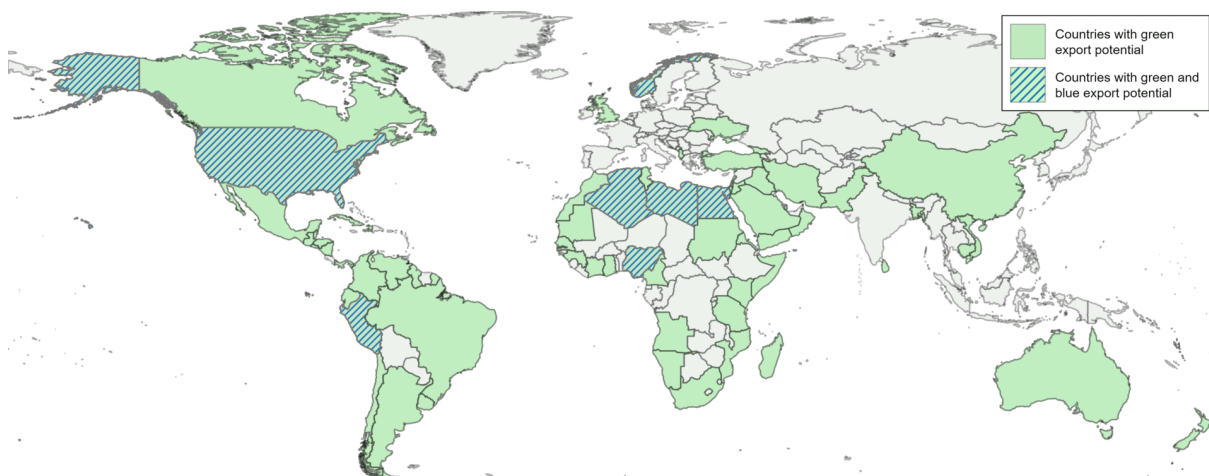

Figure 4.5: Illustration of pre-filtered countries

Applying the country exclusion filter reduces the group of potential exporters to the EU to 65 countries (Figure 4.5). The countries are geographically diverse and represented on all continents (except for Antarctica). Nine of them can act as potential exporters for both green and blue hydrogen. The resulting group of countries forms the basis for the analysis of the following steps.

4.4.2 Detailed supply chain analysis

As part of the supply chain analysis (Step 2), the cost-optimal supply routes to the EU are derived for each possible production site in the pre-filtered countries. Figure 4.6 shows the obtained costs for the years 2030 and 2050 as well as for the two energy carriers assessed. While the cell colours within countries and along their coasts represent the resulting supply costs for green hydrogen, the circles in or near natural gas exporting countries show the supply costs for blue products. Missing cells within the 500 km buffer zone to export points indicate that the conditions on land requirements are not fulfilled, making the use of renewable energy and the production of green hydrogen unsustainable.

The figure shows that technologies become more competitive as time progresses (2030 vs. 2050). This is mostly driven by the expected cost decline of green hydrogen technologies and seaborne transport options that help reduce the supply costs. Moreover, compared to gaseous hydrogen supply options, which appear to be most competitive near the EU, the competitiveness of ammonia supply options is geographically more widely distributed. Figure 4.6a and 4.6c show this nicely for 2030. In 2050, this observation is still present but less pronounced. In addition, the overall darker colour of the circles indicates that, under the base assumptions, blue hydrogen appears to be more competitive in the short-term compared to green supply options. The results also show that there are differences between the individual production routes of green products. Green supply options from onshore systems (solar PV, onshore wind, or hybrid) generally appear to be more competitive than supply options from offshore wind. This is well illustrated by the example of the UK, where the overall colours of the onshore cells are darker than those of the offshore wind areas. Moreover, the maps demonstrate that requirements on the land conditions affect the overall geographic production

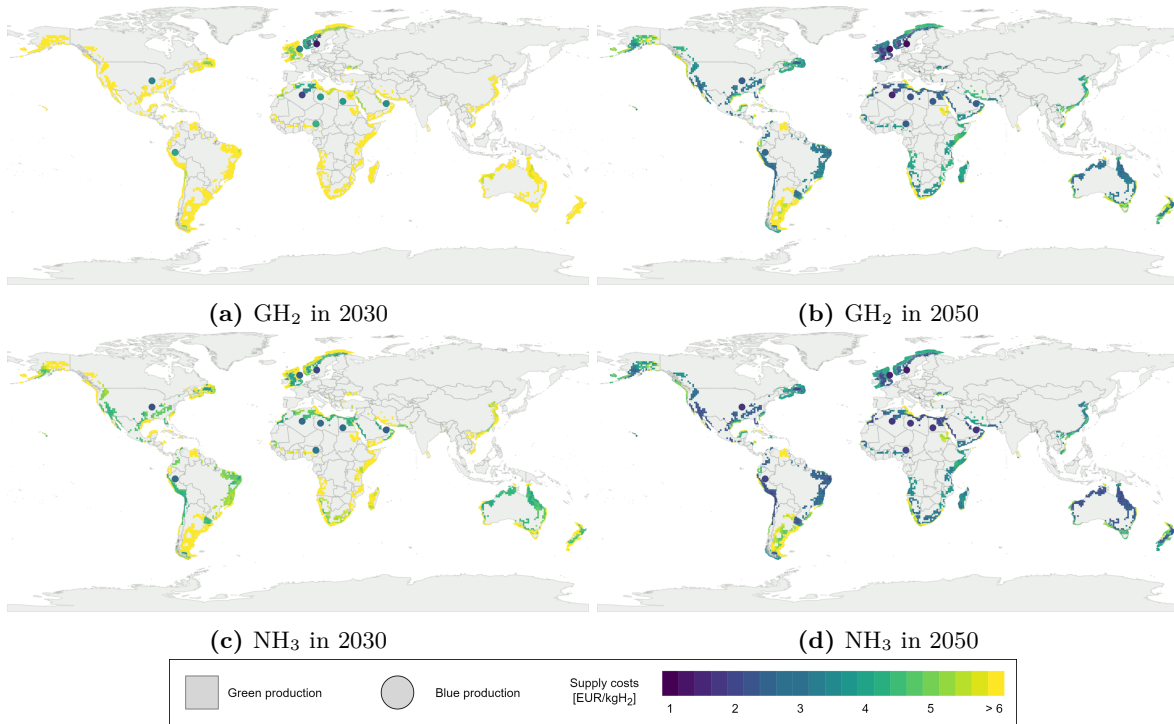

Figure 4.6: Maps of the supply costs for gaseous hydrogen and ammonia in 2030 and 2050

potential of green hydrogen. While about 6000 onshore cells are assessed within the analysis, only about 2000 meet the required conditions as sustainable export regions (compare Figure 4.4 and 4.6). However, individual potential exporters are affected differently by land restrictions. While some countries are hardly influenced by the conditions such as the ones in South America, where most regions are identified as suitable for green hydrogen production, the potential is significantly reduced in other countries, such as some West African ones. We use the obtained information on supply costs to derive the corresponding Competitiveness-Indices for the joint assessment.

4.4.3 Multi-criteria analysis

Figure 4.7 presents the outcome of the multi-criteria analysis for the base case assumptions (see Table C.1 for information on country abbreviations). For each pre-filtered country, we assess the potential to become a reliable trading partner based on the five defined criteria. While Figure 4.7a and Figure 4.7b present the absolute values for 2030 and 2050 respectively, Figure 4.7c shows the difference between the two years. The theoretical maximum absolute value is 1, with each of the five criteria contributing with one fifth. While none of the countries reach values above 0.9, Australia, Canada, the UK, New Zealand, and the US perform the best and all show values between 0.8 and 0.9. In contrast, the countries with the lowest soft factors are Somalia, Venezuela, and Yemen, all of which remain below values of 0.1. Moreover, while for some countries the contribution of the individual criteria is rather balanced (e.g., Australia), for some others their representation in the soft factor is uneven (e.g., Libya). The observed trends over previous years, which build the basis of the future projection, demonstrate that the assessed countries behave differently in comparison with one another. While some show only improving trends in all criteria, others are characterised by

declining tendencies in the five aspects. Most countries, however, demonstrate both improvements in some aspects and deteriorations in others.

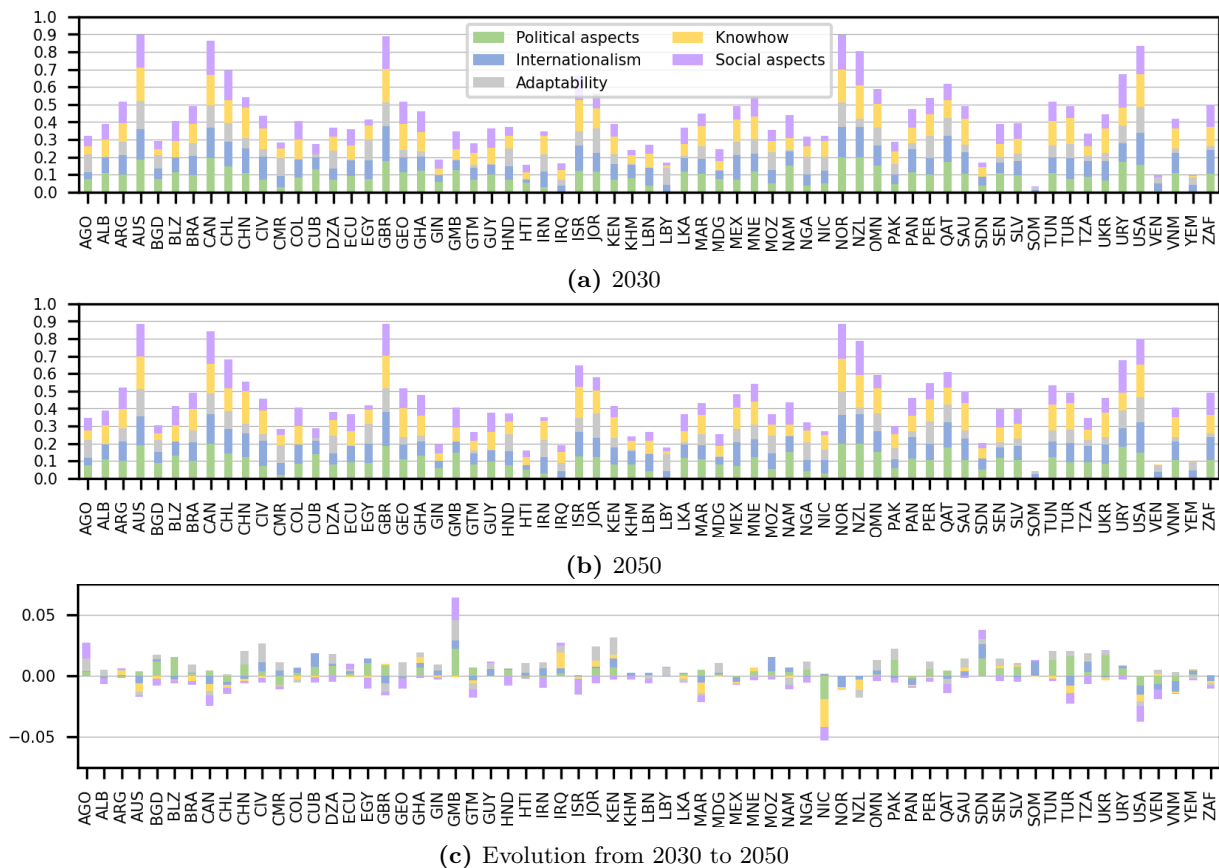

Figure 4.7: Analysis of resulting soft factors

4.4.4 Combined assessment of cost-based and non-cost-based parameters

Figure 4.8 illustrates the outcome of the joint assessment of the derived Competitiveness-Indices (Step 2) and the Soft-Factor-Indices (Step 3) for the supply of gaseous hydrogen. The blue and green circles in the chart represent import options of blue and green hydrogen, respectively. While the Soft-Factor-Index is shown on the x-axis, the y-axis corresponds to the Competitiveness-Index. Therefore, the higher the circles, the more competitive the supply option and the further right the circles, the more the country is suited to the build-up of a domestic hydrogen economy in a timely manner and to act as a reliable trade export partner. While the larger circles with their associated country labels illustrate the countries' positions in the long-term (2050), the small circles linked to the larger ones by grey lines present their position in the short-term (2030).

The results show that the position of supply options in the two dimensions can change from short to long-term, indicating that the best options in the short-term are not necessarily the best in the long-term. Most changes in competitiveness (i.e., vertical changes) occur in the top half

³⁶ Country abbreviations provided in Table C.1 (Appendix C.1); Ukraine: Soft factor parameters are calculated based on pre-war data. Political stability is assumed to go back to normal before 2030.

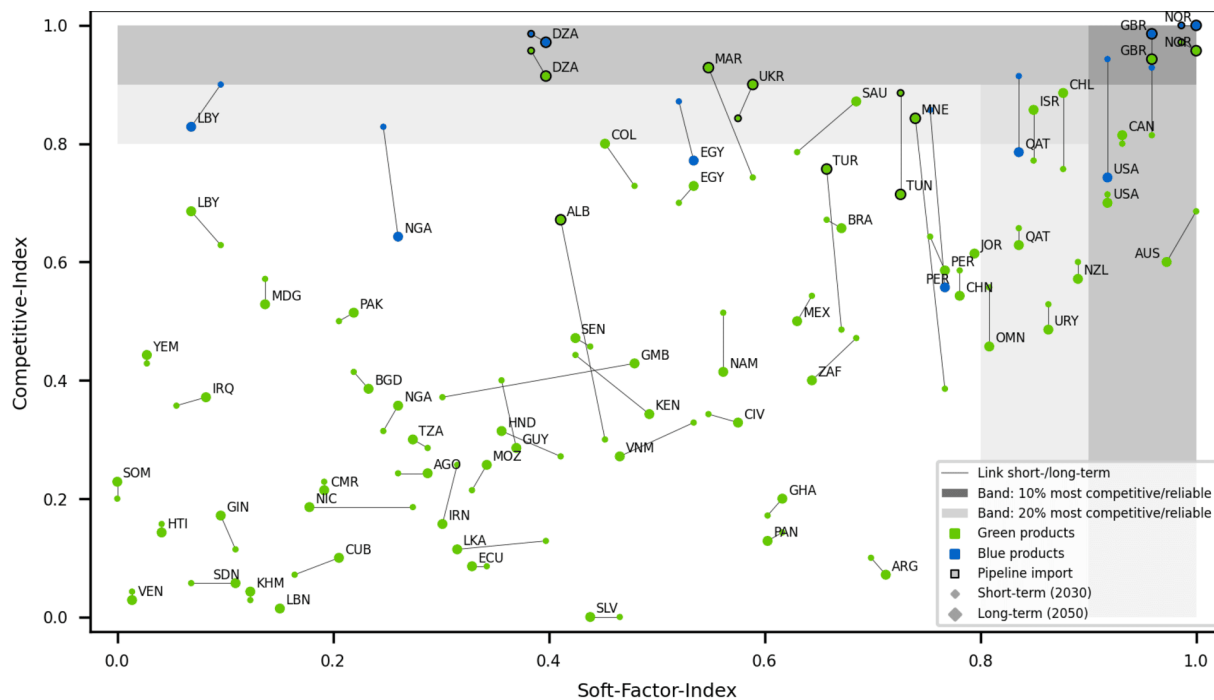

Figure 4.8: Combined analysis for gaseous hydrogen³⁶

of the chart. In the group of the 20% most competitive, 6 out of 15 options change over time mostly affecting blue options. While they are economically advantageous overall in the short-term (all blue delivery options are among the most competitive 20%), their competitiveness declines significantly over time. Only blue supply options from Norway, the UK, and Algeria maintain or improve their positions. All other blue options leave the band of the most competitive 20% (except for Libya). On the contrary, green options mostly improve their competitiveness in the upper half of the chart. Numerous supply options move up and replace their blue competitors within the upper band. Furthermore, in the long-term, the most competitive supply options (best 10%) are all presented by countries that are neighbours to the EU and that are being connected via pipelines, indicating that as for natural gas, hydrogen pipeline interconnectors are positive drivers for the cost-competitiveness of suppliers. This argument is also supported by the increasing position of all countries connected to the hydrogen pipeline backbone between the two years analysed³⁷. However, not all of them (e.g., Albania, Turkey, and Tunisia) rank among the most competitive 20% in the long-term. Instead, green options from Israel, Chile, Canada, Saudi Arabia, and Colombia, which are transported by sea, outcompete them and dominate the range between the most competitive 10% and 20%. Moreover, while numerous changes occur among the most cost-competitive supply options, changes on the Soft-Factor-Index are less pronounced. Except for Australia and Norway, which change positions, all other countries in the top 20% group retain their horizontal position, suggesting that the development of their assessed indicators is rather stable or move comparably with other highly ranked countries. This is different for supply options further left on the chart. Depending on their national development trends during the last years, countries either show more

³⁷ A hydrogen pipeline from Tunisia to Italy is expected to be available in the short-term (2030).

pronounced improving or degrading trajectories of soft factors (Subsection 4.4.3). Overall, imports from Norway and the UK perform best in the long-term, both in terms of cost-based and non-cost-based aspects. Despite slightly lower indices on both dimensions, supply options from Chile and Saudi-Arabia also appear to be well suited. Further economically viable supply options are offered by Ukraine³⁸, Morocco, Algeria, Saudi Arabia, and Montenegro. However, they are linked to reliability risks. By contrast, Canada, the US, Australia, New Zealand, Uruguay, and Qatar appear to be reliable partners at the expense of cost-premiums. The outcomes also indicate a positive correlation between the Soft-Factor-Index and the Competitiveness-Index. With the exception of some supply options placed in the upper left and lower right parts of the chart, most options show correlated behaviour.

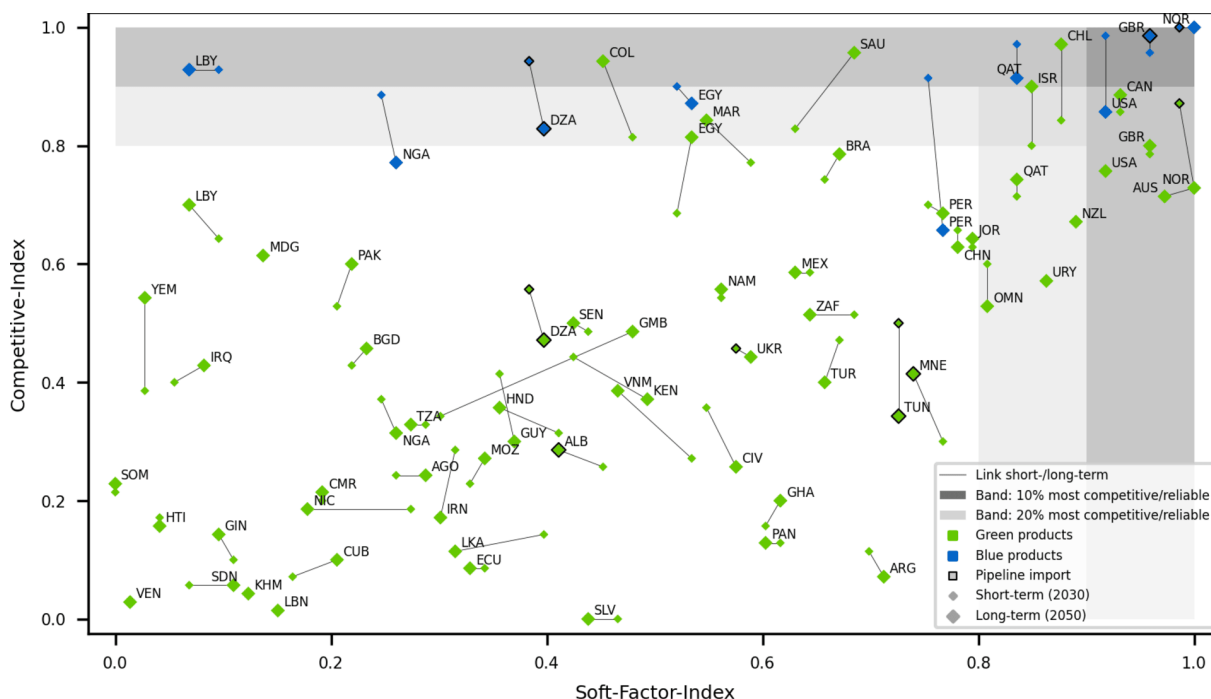

Figure 4.9: Combined analysis for NH_3 ³⁹

Similar to the supply of gaseous hydrogen, positions for ammonia supply change over time in both dimensions (Figure 4.9). However, it is noted that the horizontal representation of the countries does not differ from the previous illustration (Figure 4.8), as the assessed criteria and the assessment within the soft factor analysis are identical. Moreover, vertical changes are less pronounced for ammonia, as fewer options change positions over larger ranges. As with the supply of gaseous hydrogen, the figure shows that blue ammonia supply options present the options with the highest competitiveness in the short-term. All options rank among the most competitive 10%. However, with the exception of Norway, the UK, and Libya, which maintain or improve their positions, the competitiveness of blue ammonia declines over time. Moreover, while for gaseous hydrogen the most competitive supply options (the top 10%) are all provided by EU neighbouring countries, the

³⁸ Assumed that political stability will return to normal before 2030

³⁹ Country abbreviations provided in Table C.1 (Appendix C.1); Ukraine: Soft factor parameters are calculated based on pre-war data. Political stability is assumed to go back to normal before 2030.

situation is different for ammonia supply. Only Norway and the UK are still on the list. Other options are represented by Chile, Israel, Saudi Arabia, Colombia, and Qatar. Consequently, geographic diversification is more pronounced. Furthermore, despite available pipeline capacities to transport gaseous hydrogen to the EU and convert it to ammonia within the EU, pipeline connections play a less important role in the supply of ammonia, as shown by the examples of Morocco and Turkey, from which volumes are imported by sea route. The positive correlation between the two indices observed for gaseous hydrogen supply is also present for ammonia supply. Despite some exceptions, most supply options are found in the lower left and upper right parts of the chart. Overall, Norway, the UK, Chile, Israel, and Qatar show the most promising supply conditions in the long-term, as they appear not only economically viable but also reliable. In addition, supply from Saudi Arabia and Colombia seem economically attractive, but their reliabilities are less sound. This is even more pronounced for Libya. The US, Canada, Australia, New Zealand, and Uruguay, in contrast, appear to become both highly competitive and reliable options.

4.4.5 Estimation of reliability premium

Based on the results of the joint assessment of the Soft-Factor-Index and the Competitiveness-Index presented in the previous subsection, we derive the premiums needed to maximise the reliability of imports into the EU. In doing so, we compare the costs resulting from a cost-optimised supply with those of a supply that maximises reliability (Figure 4.10 and Figure 4.13). We obtain the cost-optimised supply in the following way: first, we identify the most competitive option, and extract its supply costs. Assuming that the EU would only import quantities from this country, supply costs would be set by this option. However, since the import structure in this case is based on only one supply option, there is no diversification, so that there would be a high import concentration (HHI of 10000). Adding the next most competitive supply options to the import structure, assuming for simplicity that the best and the second best option contribute equally to the supplied volumes, would increase the diversification, and hence, decrease the concentration of imports accordingly (HHI of 5000). The resulting import costs faced by the EU would be the average of the two suppliers. The gradual addition of more options to the import structure will further diversify imports and reduce supply concentration. Consequently, we derive the curve for the cost-optimised supply by gradually adding supply options to the import structure going from the top to the bottom as shown in Figure 4.8 and Figure 4.9. The supply option that maximises the reliability of the import structure is obtained in a similar way. However, instead of going top-down, we consider the options and their costs by going gradually from the right to the left. It is noted that in cases where countries have both blue and green supply options, we only consider the more competitive supply option.

The cost-optimised supply of gaseous hydrogen in 2030 (Figure 4.10a) shows that importing all volumes only from the most-competitive supplier (i.e., blue hydrogen from Norway) would result in supply costs of less than 1.5 EUR/kg_{H2}. However, with an increasing diversification, the averaged supply costs increase gradually, growing to up to 7 EUR/kg_{H2} at the point when all potential supply options are considered within the supply structure. By contrast, a different curve is obtained when exporters are chosen based on their expected reliability. While an increase from

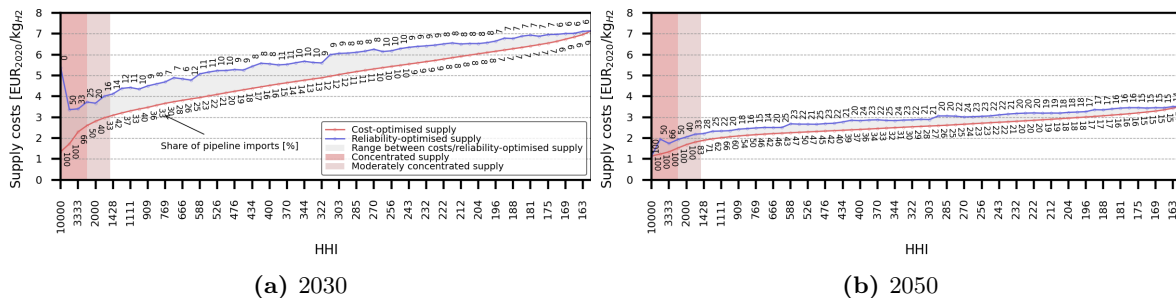

Figure 4.10: Analysis of cost-optimised vs. soft-factor-optimised supply of gaseous hydrogen

one supplier (Australia) to two suppliers (Australia and Norway) exceptionally lowers supply costs, further diversification leads to cost increases. The soft-factor-optimised curve is always above the cost-optimised curve, suggesting that efforts to increase the reliability of the import structure come at the expense of higher costs. However, with higher levels of diversification, both curves converge gradually and cross at the point with the lowest HHI, when both supply structures are identical. Moreover, the proportion of volumes imported via pipelines, represented by the factors attached to the curves, gradually decreases as the number of suppliers increases. The corresponding values for the cost-optimised supply are generally higher than for the supply-optimised based on soft factors. For gaseous hydrogen in 2050 (Figure 4.10b), the observations are similar. However, the total supply costs are lower overall, which is illustrated by the flatter cost curves. While the lowest supply costs in the cost-optimised case are still at the same level as in 2030 (<1.5 EUR/kg_{H₂}), the highest costs at the lowest HHI are halved. In addition, the distance between the two curves reduces in 2050.

The gap between the curves represents the cost markup to maximise the reliability of partners for the same number of suppliers, which we also refer to it as 'reliability-premiums' or in short "premiums". The resulting premiums expressed in relative terms are illustrated in Figure 4.11.

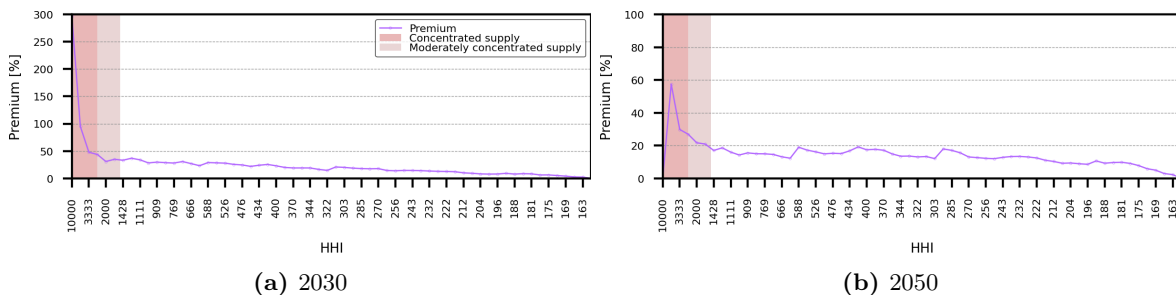

Figure 4.11: Reliability premiums for supply of gaseous hydrogen

With an increasing number of suppliers, the gap between cost-optimised and soft-factor-optimised supply diminishes and hence, the premiums vanish. The common understanding⁴⁰ is that HHI values above 1500 indicate that supplier concentrations are moderate to high. By contrast, HHI values below 1500 represent environments that are sufficiently competitive. Consequently, as the EU should aim at ensuring a sufficiently diversified import structure, HHI values below 1500 should be targeted. Consequently, maximising reliability aspects of suppliers results in premiums of less than 40% in

⁴⁰ For instance as defined by the U.S. Department of Justice and the Federal Trade Commission in FTC (2010).

the short-term. In the long-term, premiums reduce to values lower than 20%. Additional diversification lowers premiums further. Moreover, these reliability mark-ups reduce pipeline imports. At the HHI value of 1500, pipeline imports reduce from 42% to 14% in 2030 and from 71% to 28% in 2050 (Figure 4.10). While the figures above present imports of both blue and green hydrogen, for cases where only imports of green volumes are considered, which we assess separately (see Appendix C.2.4), premiums are lower than 20% in the short-term and less than 15% in the long-term.

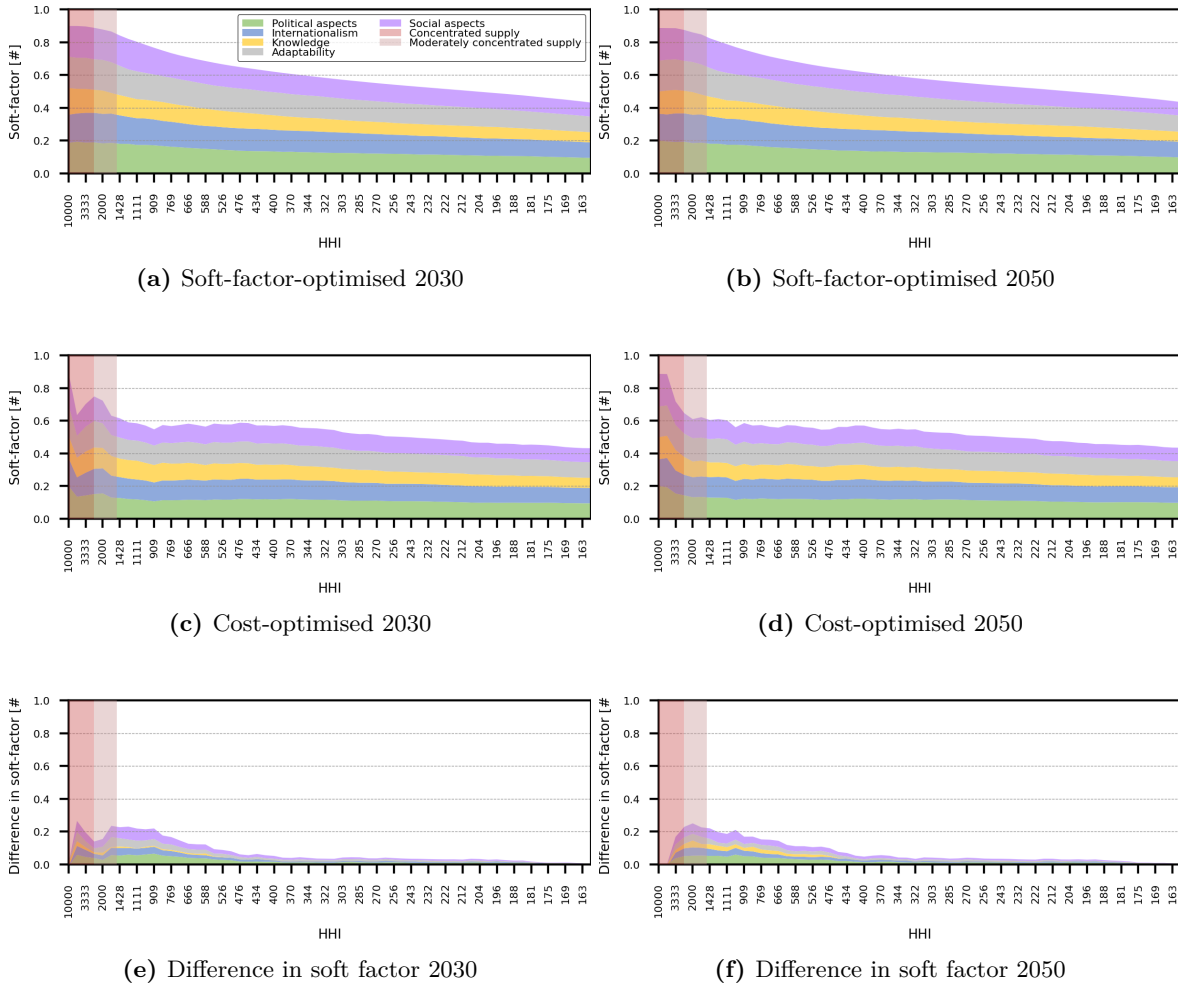

Figure 4.12: Soft factor analysis for supply of gaseous hydrogen

Figure 4.12 illustrates the corresponding effects on the reliability aspects that are obtained within the multi-criteria analysis. The values represent the averaged figures of the supply options considered at each supplier concentration (x-axis), similar to the two cost curves in Figure 4.10. For the soft-factor-optimised supply, high supply concentrations result in values around 0.9 (Figure 4.12a and Figure 4.12b). However, with increasing diversification, the soft factors decrease gradually and end at levels slightly above 0.45. While for the cost-optimised cases the values show similar start and end points, and the intermediate range declines more steeply. The absolute differences between cost-optimisation and soft-factor-optimisation, including the corresponding breakdown among the individual criteria, are illustrated in Figure 4.12e and Figure 4.12f. The largest differences occur at high supply concentrations. At the HHI of 1500, the absolute difference for both analysed years

is slightly over 0.2 with the political and social aspects being the main drivers followed by the adaptability and the internationalism criteria. Only the ‘know-how’ component shows minor deficits. The results for 2050 are similar, with the political and social aspects still accounting for the largest differences. However, unlike in 2030, the ‘know-how’ criterion shows greater shortcomings.

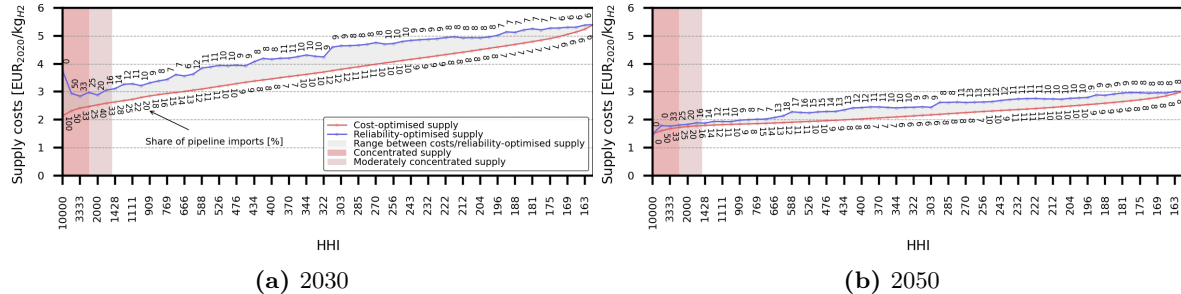

Figure 4.13: Analysis of cost-optimised vs. soft-factor-optimised supply of ammonia

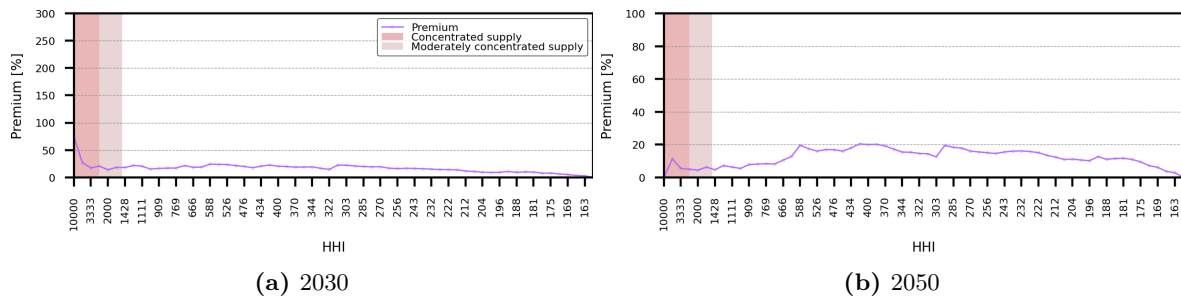

Figure 4.14: Reliability premiums for supply of ammonia

The corresponding results for the supply of ammonia are shown in Figure 4.13. Compared to the supply of gaseous hydrogen, the curves for ammonia supply are flatter. In 2030, a maximal diversified supply comes at a cost of about 5.2 EUR/kg_{H₂}. In 2050 it is at 3 EUR/kg_{H₂}. Moreover, the differences between the cost-optimised and the soft-factor-optimised supply is less pronounced. In the short-term the premium at HHI values of 1500 is below 20% (Figure 4.14). In the long-term, levels around 5% are achievable. Excluding blue products and focusing only on green ammonia imports (see Appendix C.2.4) would result in a premium of less than 10% in both the short-term and the long-term.

The effects on the soft factor aspects for the supply of ammonia are illustrated in Figure 4.15. It is noted that the values for the soft-factor-optimised supply are identical to the ones of gaseous hydrogen supply (Figure 4.12a and Figure 4.12b). Despite slight differences in the results of gaseous hydrogen, the overall outcomes look very similar. The greatest differences between cost-optimised and soft-factor-optimised supply occur in ranges of high supply concentration. While in the short-term, political and social aspects are the main contributors, with the ‘know-how’ criterion showing the lowest differences, similar to gaseous hydrogen, in the long-term the overall composition between the criteria is more balanced.

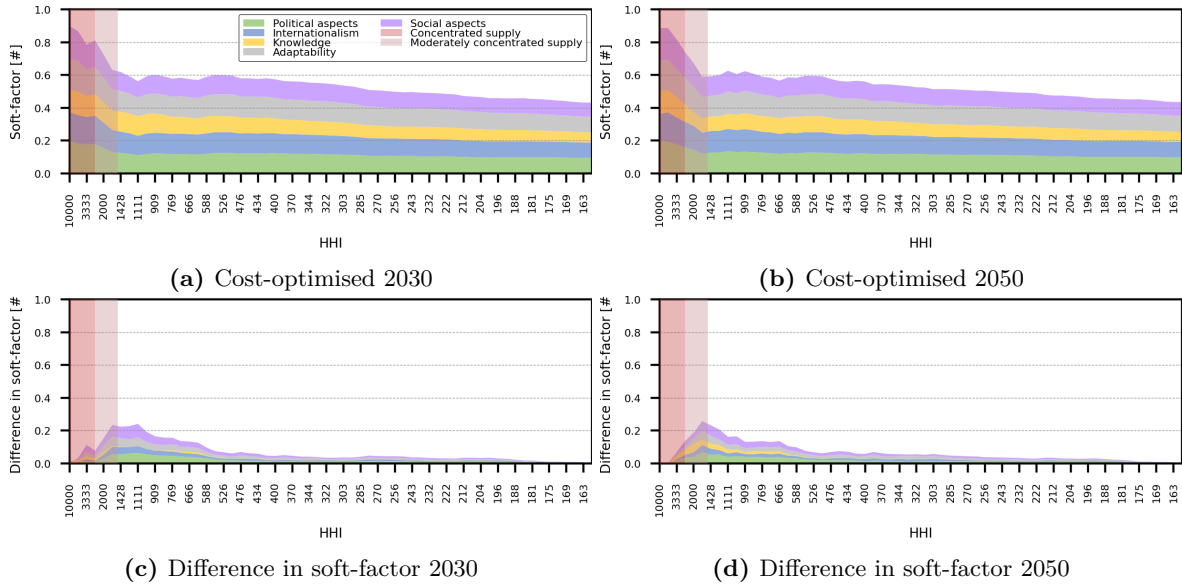

Figure 4.15: Soft-factor analysis for supply of ammonia

4.5 Discussion

The creation of new energy imports to the EU is envisaged to take place through bilateral agreements and the establishment of partnerships, which may result in long-lasting ties. To learn from and overcome past mistakes, a better understanding of supply diversification and its associated costs is needed. We propose an assessment of potential suppliers that is not only based on cost competitiveness, but that also takes into account social, political, and economic criteria.

While the geoeconomics of fossil resources have mostly been driven by the availability of underground deposits in a small number of countries, for the hydrogen economy this will be fundamentally different. Our results show that numerous countries around the world could provide the EU with broad import options allowing for a well-diversified supply structure and resulting also in overall lower risks for production and price cartels. However, countries show significant differences with respect to their competitiveness and their assessed reliability. While some countries show beneficial conditions in both dimensions such as Norway, the UK, Chile, Israel and Qatar, others appear more favourable in only one of the dimensions. Cost-competitive suppliers with lower soft factor conditions include Algeria, Colombia, Morocco, Saudi Arabia, and Ukraine. On the contrary, Australia, Canada, New Zealand, US, and Uruguay seem highly reliable but with lower competitiveness. In recent months, the EU has signed numerous memoranda of understanding with potential partners on hydrogen trade. Most suitable identified partners in this study are among them. However, countries such as Israel and the US, which rank among top suppliers in terms of both expected reliability and competitiveness, have not yet been considered. This suggests that supply options and engagements with additional partners that show promising reliability in delivering clean energy to support the EU energy transition within the envisaged timeframe are further assessed.

In addition, we find that the creation of a diversified, but also cost-based import portfolio can lead to supplier selections with reduced scores in reliability aspects. However, in the short-term,

additional costs of about 40% are required to maximise the reliability of the export partner for the supply of gaseous hydrogen. In the long-term, the premium drops to less than 20%. For the supply of ammonia, the premium is lower than 20% in the short-term and falls below 5% in the long-term. Currently, the first European initiatives are being set up, such as H2-Global, to establish partnerships and to kick-start import routes through bilateral long-term contracts. However, they tend to prioritise short-term supply costs over broader political, social, and economic aspects. As a result, investments in cost-attractive but less reliable supply options increase probabilities that they will be unable to meet their supply commitments. Hence, risks occur that valuable efforts are in vain and financial supports are used inefficiently. The results therefore suggest that accepting moderate increases in supply costs but increasing the requirements of non-cost aspects within the procurement criteria helps in securing reliable imports.

Additionally, the outcomes demonstrate that the locations of supply options are not necessarily stable over time due to technological trends, socio-economic developments and changing financing conditions. Therefore, the creation of bilateral trade partnerships based on short-term aspects as currently envisaged, may support long-lasting investments in production and infrastructure facilities that either lose competitiveness over time and lead to stranded assets, or that could induce lock-in effects hindering the creation of more beneficial alternatives. Given the high upfront investments for hydrogen technologies therefore increases the importance of their locational choice and the need for sophisticated procurement strategies that withstand uncertainties with respect to political and technological developments to counteract risks of inefficient investments. The decreasing competitiveness is particularly relevant for most blue products, which cannot maintain their relative cost competitiveness against green technologies over time. Similar conclusions were drawn by Ueckerdt et al. (2022). Moreover, as increasing sustainability conditions require the residual CO₂ and methane emissions to fall below decreasing thresholds, the exploited technologies must steadily improve. If actors fail to meet these requirements, the competitiveness of their products diminishes. Consequently, to avoid risks of stranded assets, investments in blue technologies should be well assessed with respect to the entire transition dynamics before investment decisions are made. In this study, we use static break-even costs of natural gas to determine the supply costs of blue products. Since natural gas producers can sell their volumes in different markets to optimise their profits, the cost at which blue hydrogen is produced is subject to various conditions and uncertainties. Therefore, further research on blue hydrogen products and the corresponding production costs, taking into account the interactions between the different markets, is suggested.

Moreover, the competitiveness of hydrogen exporters is found to be improved by hydrogen pipeline capacities linked to the EU, which was also observed by Baroni (2021) and in Guidehouse (2021). The competitive advantage caused by pipelines puts both the traditional natural gas suppliers (e.g., Algeria, Norway, the UK) to the EU and other neighbouring countries, that have so far only been acting as transit countries, in beneficial positions. However, this indicates that trade of gaseous hydrogen entirely based on costs is likely to develop in a regional manner, similar to how trade of natural gas evolved. As the point-to-point connections through pipelines tie producers and consumers closely together and create dependencies among them, the flexibility in the way they can act is reduced. Consequently, despite a greater number of supply options connected via pipeline to

the EU offering overall better diversification possibilities, the risk of a highly concentrated supply structure, as has occurred in the case of natural gas supply, remains, with all its associated consequences. However, possibilities to counteract a high concentration of suppliers in regional markets are offered by domestic resources for the production of green hydrogen in the EU. Moreover, the results show that the expected technological developments and associated cost reductions in the import of GH_2 by seaborne routes supports the competitive position of the corresponding supply options in the long-term. Therefore, as seen in the past for LNG trade, further research and development as well as an early upscaling of respective technologies are suggested to obtain learning effects that improve the competitiveness of the technologies. The hub-to-hub supply of seaborne transport, where vessels can be redirected and unloaded independently of their origin, provide flexibility that fosters security of supply and wider trade possibilities.

For the supply of ammonia, the competitive advantage of pipeline connections is not given. The absence of the reconversion step at the destination location of ammonia is a driver for the improving competitiveness of its seaborne transport. Our results also highlight that the transport distances are less important to the overall supply costs so that favourable production conditions outweigh longer transport distances. Consequently, ammonia imports benefit from broader geographical diversification possibilities at lower extra-costs. The results therefore suggest that an international market for ammonia is likely to develop earlier than that for GH_2 , reducing overall risk exposure and hence, concerns about security of supply. Therefore, limited domestic EU resources should be primarily used to provide gaseous hydrogen rather than its derivatives that can be accessed more economically attractively and diversified from international markets.

Moreover, we find indications of a positive overall correlation between the Competitiveness-Index and the Soft-Factor-Index in both green hydrogen and green ammonia supply, which is mostly driven by the risk valuation associated with export countries. As investors account for them through the adaptations of the cost of capital, the financing conditions can be very different among countries, which is crucial for capital intensive investments. While the production of green hydrogen is capex-dominated and hence, affected significantly by the financing conditions, this is less relevant for blue products due to their different cost structure, which is more intensive on operating costs. Brändle, Schönfisch, and Schulte (2021) found similar effects on the impact of financing costs. Our findings therefore indicate that the international trade of green hydrogen and its derivatives is likely to be driven by the ‘normal’ rather than the ‘natural’ comparative advantages, similar to that for non-energy commodities, making stronger economies holding higher shares. Notwithstanding, this is still subject to the availability of countries’ natural resources, their domestic demand and their potential available pipeline transport capabilities. While some recent studies such as the one from Brändle, Schönfisch, and Schulte (2021) and Baroni (2021), use uniform financing costs throughout their analyses, our results confirm the importance of differentiating them in future analyses by country-specific risks, as suggested by Egli, Steffen, and Schmidt (2019).

This analysis sheds light on potential supply options of hydrogen and its derivatives to the EU. However, depending on the goals of individual stakeholders, the selection as well as the weighting of assessment criteria within the soft factor assessment can be different, and so may the ranking on the suitability of countries. As such, the idea of multi-criteria analysis is not to provide optimal solutions,

but rather to “create a support tool for decision makers that conforms to their objectives and priorities” (Cavallaro and Ciruolo 2005). Therefore, this work aims to provide a methodology that allows the assessment of potential trade partners holistically, both in terms of their competitiveness and with respect to other aspects (e.g., social, political, economic). Furthermore, our assessment of competitiveness focuses on supply costs and their evolutions. It therefore deviates from an evaluation of available hydrogen volumes. Consequently, the competition between the use of available resources to meet domestic demand in exporting countries and their export opportunities is not assessed. Moreover, as our analysis is static and only presents snapshots of the future, a more sophisticated assessment of investment plans is not included. Both the consideration of available volumes and a more dynamic analysis are beyond the scope of this work and to be studied in future research.

4.6 Conclusion

Imports of clean hydrogen and its derivatives are an integral part of the EU’s strategy to achieve its climate ambitions. As no international hydrogen market exists today, trade relations must be created, and supply options developed. Currently, bilateral long-term agreements, that require significant upfront investments outside the EU, are envisaged to kick-start trade. While in past decades the EU import strategy increasingly considered supply options based on their cost, after Russia’s invasion of Ukraine and the resulting supply disruption of natural gas, reliability aspects of suppliers have been gaining importance. Hence, to identify investments that result in economic, sustainable, secure, and timely supply options, a better understanding of potential suppliers is needed that is not limited to their cost-competitiveness, but that also takes into account aspects related to their expected ability to perform reliably.

We develop a methodology to assess supply options both in terms of their costs and with respect to broader political, social, and economic conditions. The approach not only allows for the assessment of current aspects, but also to take into account expected developments in the coming decades. Its flexible design enables a high spatial and temporal granularity, as well as a wide range of parameters such as technologies and soft factor criteria. The methodology can be adapted to the preferences of various stakeholders and applied to other case studies.

We find that traditional natural gas exporters to the EU – Norway, Algeria, and the UK – are well positioned to become cost-competitive hydrogen suppliers. Moreover, Morocco and Ukraine also benefit from existing pipeline infrastructure and show promising conditions to supply economically viable hydrogen to the EU. However, while Norway and the UK are characterised to meet expectations in the build-up of an export-oriented hydrogen economy, the other countries show less favourable conditions to become reliable trading partners and to achieve an adequate upscaling of clean hydrogen that is not only used to supply the EU volumes but that also enables local decarbonisation. For the supply of ammonia, the UK, Norway, Chile, Israel, and Qatar are identified as promising partners with respect to both their competitiveness and their reliability. Saudi Arabia and Colombia also show economically viable options but with less favourable conditions of non-cost-based aspects. Countries such as Australia, Canada, New Zealand, Uruguay, and the US appear less competitive, however, their overall soft factor conditions suggest their reliability as trade partners.

We conclude that while in recent months numerous memoranda of understanding between the EU and potential exporters were signed, promising candidates such as the US, Israel, and the UK have not been part of the list yet. Given the urgency of the EU energy transition and the corresponding expectations of the industry on imports of clean hydrogen and its derivatives, further assessment of potential trade partners based on both cost and non-cost aspects is suggested. The developed methodology can hereby be applied. Moreover, supply costs are found to be only moderately affected by more restrictive conditions on political, economic, and social conditions of trade partners, arguing for greater weighting of these factors in procurement strategies in the interest of energy security. This is relevant for initiatives such as H2-Global that select import options and engage in long-term contracts on a cost basis through auctioning processes.

Further research is suggested to better understand national conditions in exporting countries in terms of the quality and quantity of local resources and domestic demand. The model presented and the underlying data provide starting points to further build on and gain additional insights into potential exporters.

Chapter 5

Conclusion and perspectives

Conclusion of the study

Low-carbon hydrogen has substantial potential in contributing to the European energy transition. This is not limited to the intended decarbonisation by 2050, but also relates to the changing geopolitical landscape and the EU's ambitions to become more resilient and less dependent. There is no doubt today that hydrogen will play an important role in future energy supply. The urgency of decarbonisation requires measures to be taken that enable its rapid up-scaling and its efficient integration into the existing energy system. A fast market development can, however, lead to a disorganised ramp-up of the hydrogen economy. The associated risks of failure and thus economic inefficiencies must be limited. Policymakers are currently setting the conditions for the development of the hydrogen economy. As investments in the use, production and infrastructure of hydrogen are often associated with long lifetimes, poorly designed policies can long-lasting undesired effects. Today's decisions therefore pave the way for the future of the energy transition. A missed start can result in not achieving the intended goals. Numerous questions arise concerning the development of an economically efficient and target-oriented supply of low-carbon hydrogen in the EU energy transition. This dissertation contributes to the current policy debate and to the scientific literature by addressing three of these questions.

The second chapter deals with regulatory aspects in the production of electrolytic hydrogen and the definition of renewable hydrogen. As electrolytic hydrogen production is associated with different CO₂ emissions and costs depending on the origin of the sourced electricity, it is argued that it comes with a trade-off between environmental integrity and economic viability. To avoid undesired effects on the climate, regulation is proposed. The ongoing regulatory debate centres around three aspects: (1) the origin of the sourced electricity, (2) the temporal correlation of the production of hydrogen and renewable electricity and (3) their spatial correlation. By assessing various regulatory designs for the case of Germany in 2030, the analysis confirms the presence of the trade-off and shows that the discussed regulatory design options have implications on both the production of hydrogen as well as on the wider power system. Strict regulation generally favours environmental aspects while looser designs or no regulation benefit hydrogen production costs and welfare. When designing regulation, policymakers must therefore strike a balance between environmental and economic aspects to neither slow down the decarbonisation process nor cause excessive economic inefficiencies. The hydrogen industry claims that strict regulation substantially increases hydrogen production costs and thus harms the competitiveness of the technologies. This claim cannot be corroborated by the analysis. The impacts on the wider economy, however, are considerable. Giving operational flexibility to electrolyzers helps the integration of renewables. Hydrogen storage plays an important role in this context as it also increases operational flexibility in electrolytic hydrogen production.

The findings suggest that regulation should be strict enough to ensure CO₂ emission reduction but sufficiently loose for electrolyzers to provide system flexibility supporting the integration of further renewables. A monthly balancing of additional renewables installed in the same bidding zone as the electrolyzers, as proposed by the European Commission in the Delegated Act (EC 2023a), seems an appropriate regulatory choice. Moreover, as the trade-off depends on the relative costs of renewable and fossil fuel electricity, the results indicate that the need for regulation diminishes with

further cost reductions in renewables, since they become both the most competitive and the most environmentally friendly supply option. There are currently numerous uncertainties in the energy sector, e.g. in the evolution of fossil fuel prices, the costs of renewables as well as their financing conditions or the speed at which renewables can be expanded, that determine their relative costs. Against this backdrop it is suggested to take a cautious stance and to regulate electrolytic hydrogen production at least for a transitory period. While previous studies mostly assessed impacts of regulation narrowly from a hydrogen production perspective (Ruhnau and Schiele 2022; Schlund and Theile 2022; Zeyen, Riepin, and Tom Brown 2022), this analysis contributes to the literature by adding insights on the broader system perspective including welfare aspects and CO₂ emissions.

The third chapter looks at the spatial dimension of sector coupling. It focuses on the regulatory aspects related to the location of electrolyzers to overcome limitations of the current European market design in providing locational signals. Without these signals, market-driven electrolyzers would be located close to demand centres, likely leading to additional pressure on the grid and congestion. While there are different options conceivable to incentivise system-beneficial installations of electrolyzers such as local flexibility markets and bidding zone splitting, this chapter assesses the opportunities arising from relaxations of the current unbundling rules. It evaluates the extent to which system operators being involved in the placement and operation of electrolyzers could help in unlocking the value electrolyzers can bring to the system. For the case of Germany in 2030, it is found that such regulatory exceptions would support system-beneficial installations reducing grid congestion and redispatch needs. As the cost savings from the reduced redispatch measures outweigh the additional expenses for transporting the produced hydrogen from the production sites to the demand centres, the overall efficiency of the system increases. The assessed regulatory relaxation, however, does not only contribute to lower total system costs but also results in reductions in overall CO₂ emissions. The savings are further increased by the availability of dedicated hydrogen pipelines, as these allow hydrogen to be transported at low cost. In contrast, the results show that the integration of electrolyzers under the current market design could increase grid congestion problems if their capacity distribution is not homogeneous across all areas. In these cases, there may be both higher overall costs and an increase in CO₂ emissions, highlighting the need for reforms to the current market design.

Compared to other possibilities to mitigate grid congestion, the assessed regulatory tool presents an option that can result in rapid economic benefits due to its modest implementation complexity. Although market-based approaches should be preferred to regulatory exceptions, it is shown that the latter can provide value to the energy transition until more advanced market instruments are available. As the current economics of electrolyzers still require financial support to create business cases, the risk of harming competition in the electricity markets through the intervention of system operators placing electrolyzers is deemed low. Options of introducing regulatory sandboxes for a temporal empowerment of network operators in the locational choice of electrolyzers might be suitable instruments. The possibility of designing these tools with market elements, such as competitive tenders for the operation of the assets further supports the concept. It should be noted, however, that such instruments should only be used in combination with a dedicated hydrogen pipeline infrastructure, as the costs of transporting hydrogen by road surpass the savings from avoided redispatch

measures. While previous studies focused mostly on the technical capabilities of electrolysers for system support (Emonts et al. 2019; Robinius et al. 2017; Tlili et al. 2020), this analysis sheds light on the associated economic aspects related to market design and regulatory instruments.

Chapter four contributes to the discussion on developing appropriate EU import strategies and identifying suitable trade partners for low-carbon hydrogen and ammonia. The timely creation of economic imports of clean hydrogen and its derivatives are considered a key element in achieving the EU's climate ambitions. Against the backdrop of Russia's invasion of Ukraine and the resulting paradigm shift in EU energy trade policy, security of supply concerns are now given higher priority posing additional requirements on future energy supply. New partnerships and investments in low-carbon hydrogen trade should therefore target not only economic and sustainable but also secure and timely supply options supporting the EU energy transition. A methodology is developed consisting of a detailed hydrogen supply chain model and a multi-criteria analysis, which allows potential export partners to be assessed both in terms of their cost competitiveness and with respect to their suitability as reliable trade partners. The considered soft factors include political, social, and economic aspects as well as a country's adaptability or technological know-how. It is found that traditional natural gas exporters to the EU – Norway, Algeria and the UK – are well positioned to become trade partners for low-carbon hydrogen, benefitting from existing pipeline infrastructure. Other EU neighbours, that currently act as transit countries, such as Morocco and Ukraine, can also benefit this infrastructure. While all of the latter countries show promising potential for economically viable hydrogen supply options, Norway and the UK are in addition also characterised by overall favourable conditions for meeting their commitments. For ammonia supply where seaborne transport is less costly, additional promising partners are Canada, Chile, Israel, and Qatar. Saudi Arabia and Colombia are also economically viable options for ammonia supply, but with lower soft factor conditions. While Australia, New Zealand, Uruguay, and the US appear overall less competitive in terms of costs, they are characterised by high reliability.

Low-carbon hydrogen and ammonia trade offers the EU with broad import options and the potential to diversify its supply sources. As with natural gas, pipelines give neighbouring countries a competitive advantage. Trade of gaseous hydrogen entirely based on costs is therefore likely to develop in a regional manner with the risk of resulting in a highly concentrated supply structure. The social and political instability of southern and eastern neighbours suggests caution to avoid excessive dependencies and associated supply risks. An import strategy including adequate diversification is therefore recommended. The recently signed memoranda of understanding, targeting overall robust partnerships, are therefore good starting points. Other promising countries such as Israel and the US, however, are not yet on the list, suggesting further assessments of potential trade partners. Moreover, as supply costs are found to be only moderately influenced by more restrictive political, economic and social conditions of trading partners, a higher weighting of these factors in procurement strategies in the interest of energy security is suggested. This applies in particular to initiatives, that select import options and implement long-term contracts on a cost basis such as H2-Global. This chapter contributes to the literature by offering a cross-sectoral approach for the assessment of import options, complementing previous studies that mostly focus narrowly on aspects such as supply costs (Baroni 2021; Brändle, Schönfish, and Schulte 2021; Heuser et al. 2020) or geopolitics

(Scholten, Bazilian, et al. 2020; Grinschgl, Pepe, and Westphal 2021) in the creation of international low-carbon energy markets.

To make hydrogen a viable and widespread energy carrier in the EU, a fast ramp-up is needed, which requires a combination of various conditions. Among the key factors is the cost reduction of hydrogen technologies to increase their market maturity. Further R&D efforts as well as up scaling of the technologies are essential in this context (IEA 2019c). Another key requirement for a fast uptake is the availability of an adequate hydrogen infrastructure that includes a widespread dedicated pipeline network (Guidehouse 2022). It enables to link suitable production sites to demand locations, which is the foundation for the development of a well-functioning and liquid hydrogen market. To promote trade, it is also important to integrate the hydrogen sector into the existing energy system and the corresponding markets, such as the electricity and natural gas markets (EC 2020). The exploitation of synergies between different energy carriers through their integration also offers possibilities for an efficient use of available infrastructure (Neumann et al. 2023). Another major condition is the establishment of common frameworks through standardisation and norms. Their development and implementation requires close cooperation between governments, industry and other stakeholders at national and international level (Velazquez Abad and Dodds 2020). To ensure a cost-efficient, sustainable and secure hydrogen supply structure and thus prevent mistakes of the past, cooperation is also suggested at the European level for the creation hydrogen trade strategies with extra-EU countries (Grinschgl, Pepe, and Westphal 2021). The versatility of low-carbon hydrogen creates challenges and opportunities. These give rise to several conflicting goals, as different parties pursue different interests. They encompass the whole of society and range from political to economic and environmental to social aspects (Schlund, Schulte, and Sprenger 2022). Weighing processes must therefore take place to consider the individual interest groups and to find acceptable consensus that leads to the achievement of the defined goals.

This thesis contributes to the efficient development of hydrogen economy by providing scientific evidence to the policy debate that supports informed decision-making, guiding the way forward. The findings of this research show that proactive policy intervention is needed to prevent economic inefficiencies and undesired effects, as current regimes are inadequately suited to address future challenges. The full set of available policy instruments such as regulation, market design, or supporting programs can and should be considered. Moreover, the urgency in scaling up hydrogen supply does not allow for time-consuming and complex implementations of optimal instruments. Instead, second-best alternatives should be considered as viable options during the initial period until more sophisticated instruments become available. Planning uncertainties, as seen in the regulation of green hydrogen over the last two years, can slow down investments, stalling the ramp-up of the hydrogen economy and thus mitigating a timely decarbonisation.

The hype around hydrogen has led to a great variety of new findings in recent years, making it difficult to always keep up with the state of research during the preparation of this thesis. Nevertheless, the results of the thesis provide valuable insights to some unanswered questions. They can therefore serve the decision-making process and should further feed the policy discourse. This has already been done during the preparation of this work. In addition to active participation within the scientific community, numerous discussions took place with relevant institutions responsible in

designing parts of the future hydrogen economy. Most notably are the exchanges with DG Energy on the regulatory aspects of green hydrogen production during the drafting of the Delegated Act, as well as the discussions with H2 Global, GIZ diplomacy and the World Bank on the development of the international trade of hydrogen.

The achievement of the Paris Agreement requires substantial decarbonisation efforts worldwide. Low-carbon hydrogen is expected to play an important role in this transformation process. Despite the focus on the European energy transition, the findings of this work might also apply to other regions of the world and thus contribute to their decarbonisation strategies.

In addition to the obtained insights, the developed methods and models, which represent an integral part of this work, can serve as a basis for further analyses and thus contribute to the achievement of climate goals. This applies to further questions related to the European energy transition but also to a aspects at a broader geographical scope. The developed methods and models can therefore be adapted accordingly to other areas to support the economically efficient implementation of their hydrogen economies.

Perspectives and outlooks

The conducted analyses in this dissertation indicated future research avenues to address additional aspects linked to the development of an efficient hydrogen supply and its effective integration into the existing energy system.

First, the assessment of regulation of electrolytic hydrogen production carried out in this work focuses on the case of Germany. However, other countries are exposed to different conditions with respect to renewable potential, geographical location, and energy policy objectives. Due to these differences, the configuration of their power sectors can vary. Further research is therefore suggested to better understand the impact of regulation for electrolytic hydrogen in other countries.

Second, as this analysis of the regulatory designs of renewable hydrogen only looks at the market level, impacts of regulation on power flows and potential grid congestion are only partially addressed. In this context, it is also worth analysing how the availability of widespread hydrogen infrastructure, such as a dedicated pipeline networks and large-scale storage systems, change the effects of regulation. Extending the work by explicitly modelling the interaction with hydrogen infrastructure could therefore bring additional insights.

Third, dedicated hydrogen pipelines enable economic transport options of hydrogen. They can therefore not only help to relieve pressure from the power system but also to act as non-wire alternatives and reduce grid expansion needs in the power system. To better understand the complementarities between gas pipeline and power system infrastructure, further research on their interactions is therefore suggested. An important aspect to consider in this context is the evaluation of timely repurposing of the existing natural gas infrastructure to give it new uses and prevent its costly underutilisation. A focus of future research should also be put on the conditions for the joint planning of the two infrastructures, that aims at utilising existing assets in an economically optimal manner.

Fourth, the analysis on hydrogen trade partnerships derivates from a detailed assessment of the exporters' potential with respect to available hydrogen volumes. Competition between the use of

local resources to meet domestic demand and their export opportunities is therefore considered in a simplified manner. To assess corresponding effects on the export potentials of the countries, further research is suggested on the quality and quantity of local resources as well as on their domestic demand. The provided methodology and the underlying data offer starting points to gain further insights into potential exporters.

Finally, initial investments and early trade relationships can have lasting influences on future hydrogen supply. As the assessed analysis is static, more research is needed to better understand the dynamics of how early investments translate into the future supply structure. In this context, investments in blue products should be particularly looked at to assess whether their beneficial economics in the short-term could induce carbon lock-in effects and hinder the widespread development of green hydrogen trade.

Chapter A

Supplementary data for Chapter 2

A.1 Further results

A.1.1 Sensitivity analysis of key parameter

Within this sensitivity analysis four key input parameters (CO₂ price, natural gas price, costs of renewables, costs of hydrogen technologies) are by varied plus 10% (High case) and minus 10% (Low case).

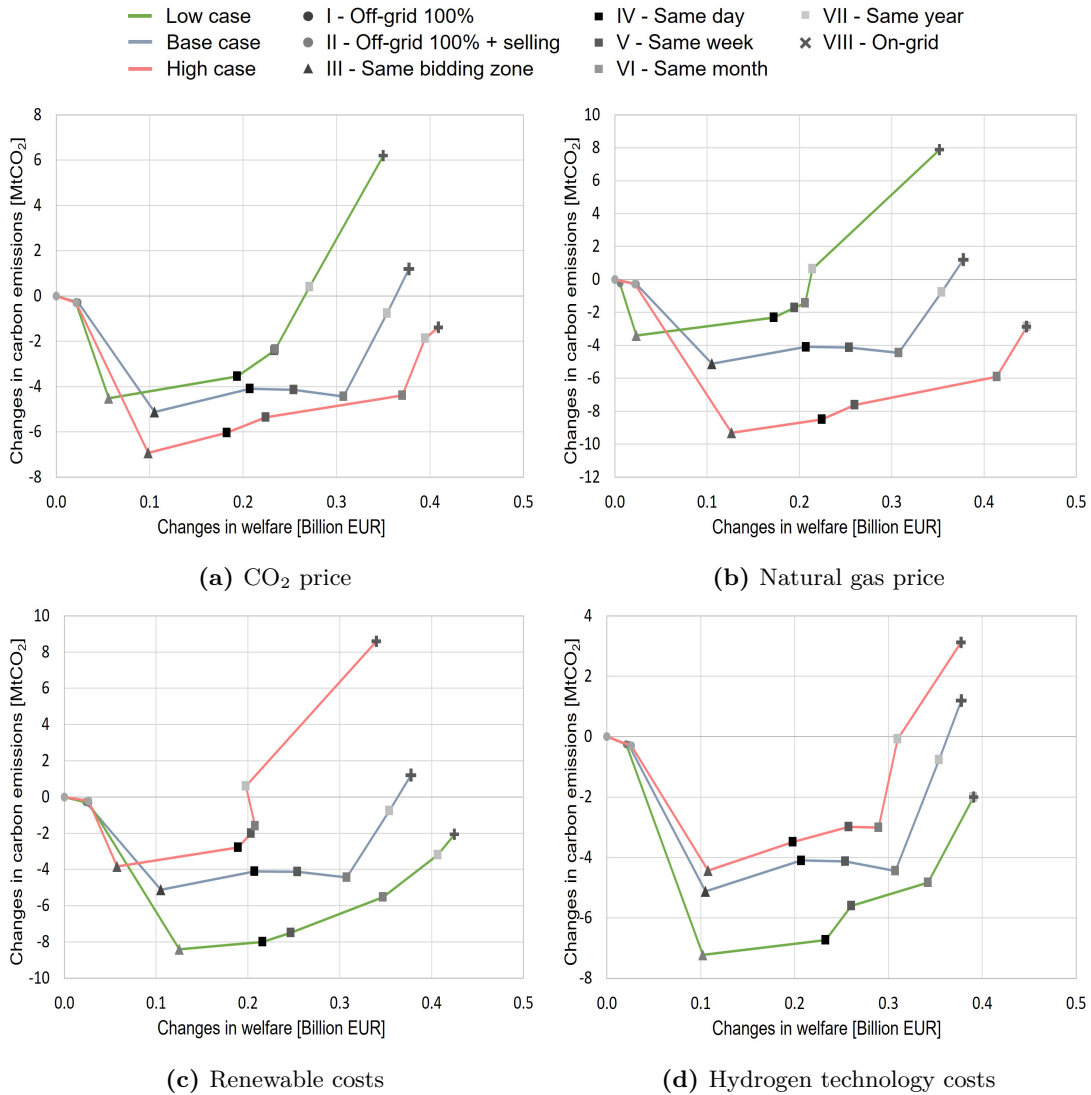

Figure A.1: Base case - sensitivity analysis of key input parameter

A.1.2 Offshore sensitivity

To assess the impact of dedicated offshore wind electricity for the production of electrolytic hydrogen with respect to the analysed regulations, we conduct a sensitivity analysis. In the analysis, the dedicated offshore capacity is increased from 0 GW to 1.5 GW. The increase, however, only applies to the cases III to VIII, since the use of electricity from offshore wind is not applicable for off-grid

systems as defined in this study¹. In the consideration of off-grid systems, the corresponding offshore capacity remains fully available to serve the electricity markets. Figure A.2 shows the summary of the sensitivity check, which is presented in the format of the resulting Pareto frontier.

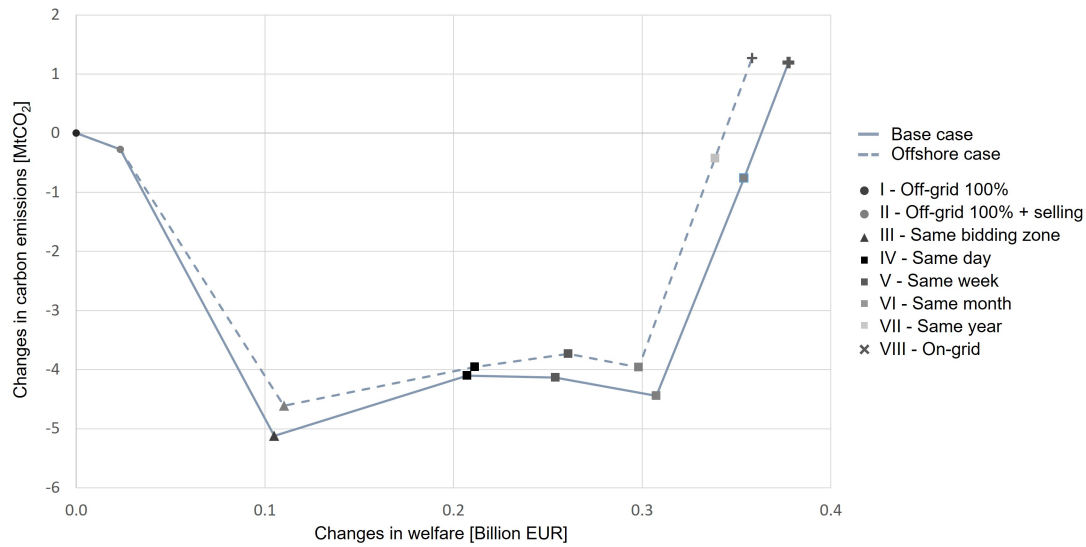

Figure A.2: Pareto frontier including offshore wind sensitivity

A.1.3 Spatial relaxation allowing installations of renewables for the green hydrogen production also in other bidding zones

While the assessed regulatory designs in the main text focus mainly on the temporal correlation, spatial relaxation is restricted to installations in the same bidding zone. In this sensitivity analysis, renewables may also be installed in bidding zones other than that of hydrogen production.

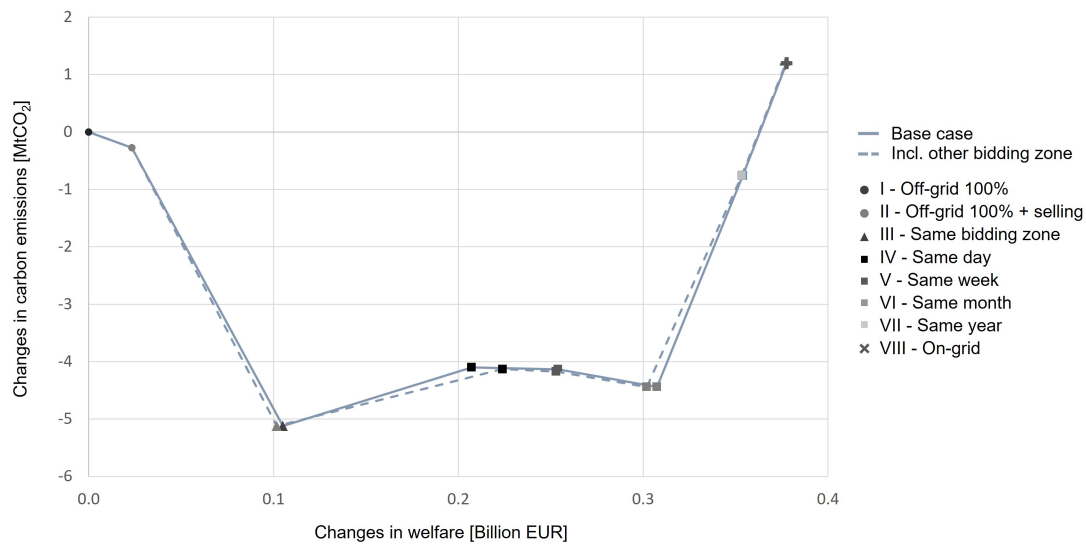

Figure A.3: Spatial relaxation allowing installations of renewables in other bidding zones

¹ Captive hydrogen supply for industrial players in Germany.

A.1.4 Details of the advanced energy transition

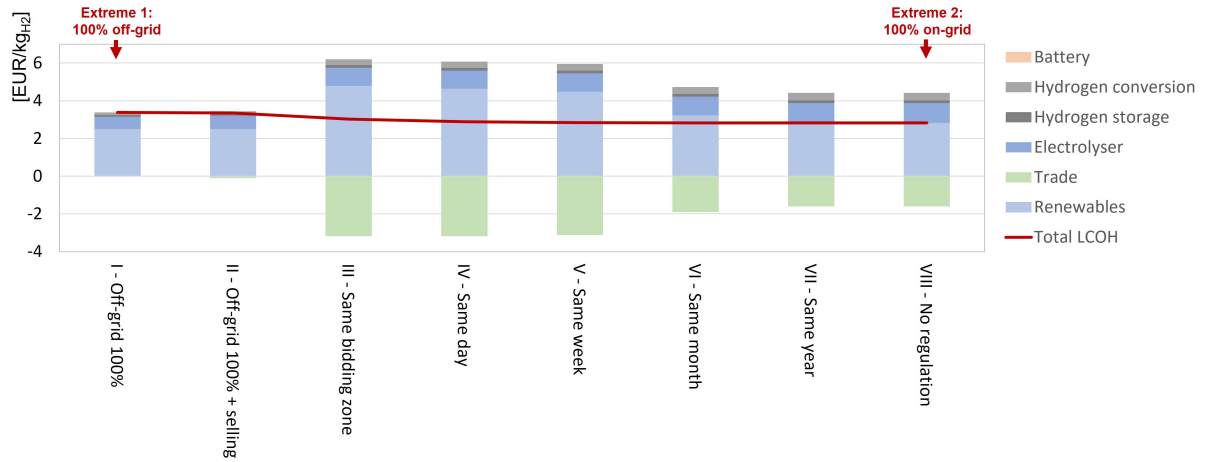
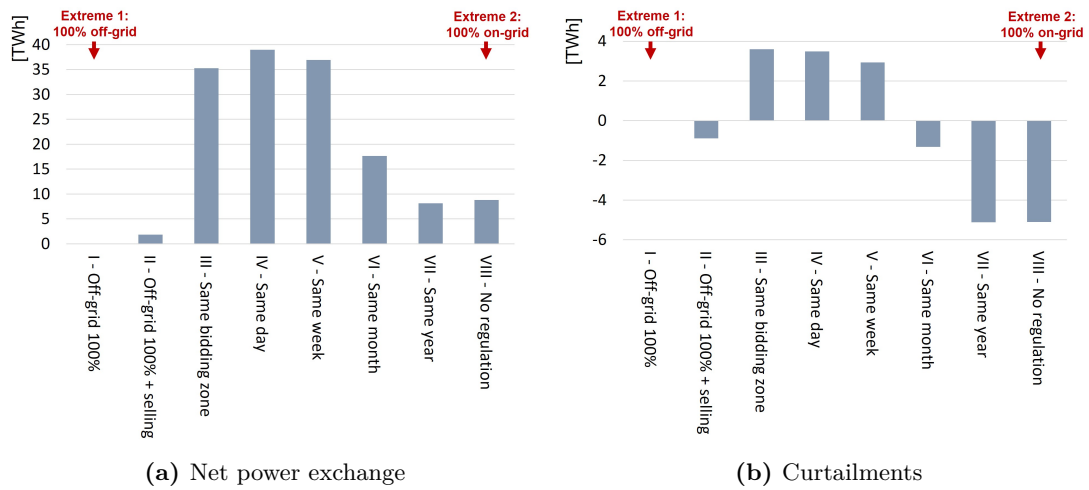

Figure A.4: Advanced energy transition - Effects on hydrogen supply costs - LCOH



(a) Net power exchange

(b) Curtailments

Figure A.5: Advanced energy transition – Effect on hydrogen and the power sector

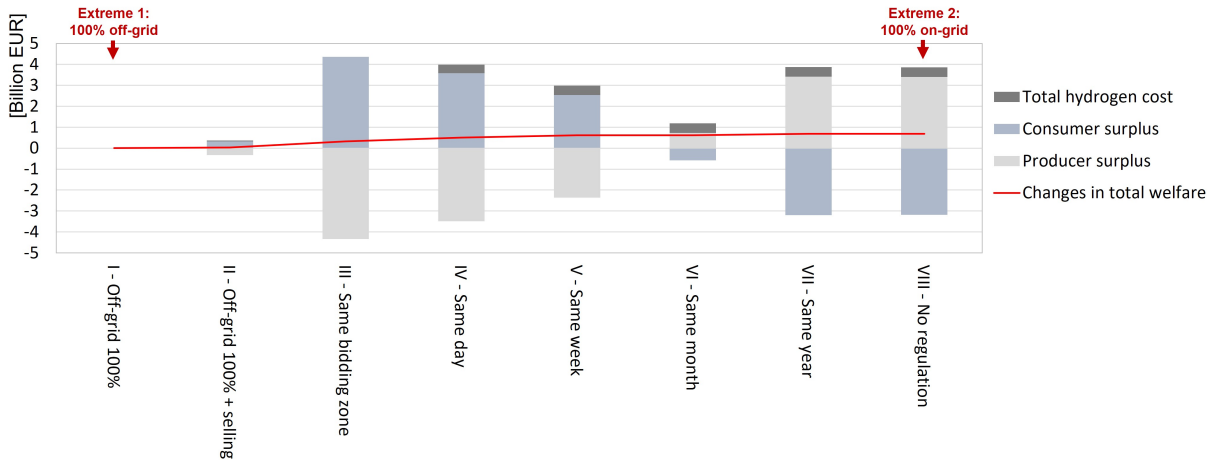

Figure A.6: Advance energy transition – Effects of regulation on welfare

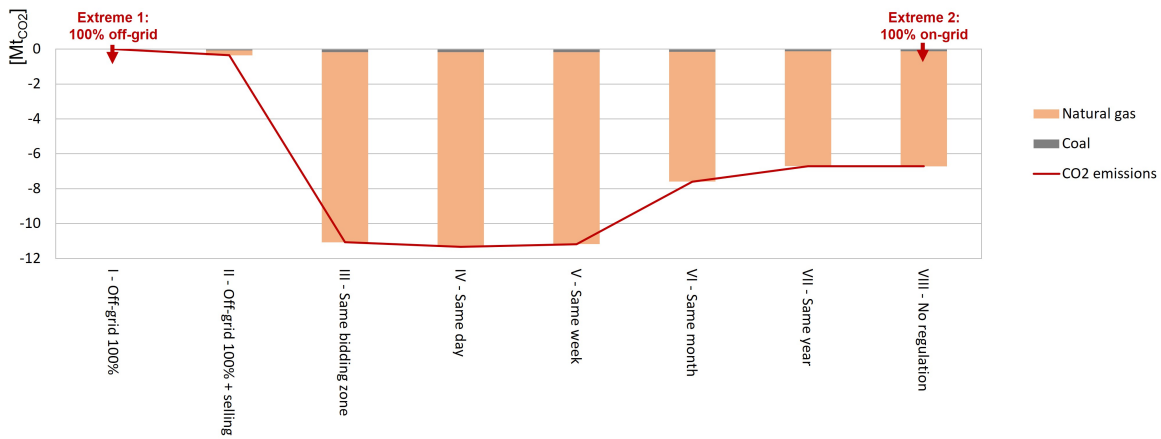

Figure A.7: Advance energy transition – Effects of regulation on CO₂ emissions

A.2 Electricity market model

Symbol	Description	Unit
Variables		
p	Endogenous power flow (e.g., power generation)	[MW]
p^{ch}	Storage charging power	[MW]
p^{dis}	Storage discharging power	[MW]
p^{flex}	Flexible part of new electric appliances	[MW]
p^{fix}	Fix part of new electric appliances	[MW]
p^{curt}	Curtailed renewable power	[MW]
p^{src}	Sourced power for electrolytic hydrogen production	[MW]
p^{pro}	Power generated by newly build RES dedicated for electrolytic hydrogen production	[MW]
p^{sur}	Power generated by newly build RES dedicated for the selling at the market	[MW]
p^{inj}	Power injection into electrolyser	[MW]
q^{cap}	Considered capacity in the power sector	[MW]
q^{inv}	Invested capacity in the power sector	[MW]
q^{div}	Divested capacity in the power sector	[MW]
q^{bat}	Investments in battery storage for hydrogen supply	[MW]
q^{pth2}	Investments in electrolyser systems for hydrogen supply	[MW]
q^{sto}	Investments in hydrogen storage for hydrogen supply	[MW]
q^{con}	Investments in hydrogen conversion facilities for hydrogen supply	[MW]
q^{res}	Investments in additional RES for hydrogen supply	[MW]

q^{vol}	Total storage volume of storage facility in the power sector	[MWh]
l	Storage level	[MWh]
c^{ass}	Cost: fixed and investment costs of power generation facilities	[EUR]
c^{h2}	Cost: components required for hydrogen supply	[EUR]
c^{gen}	Cost: power generation for electricity supply	[EUR]
Parameters (exogenous)		
C^{mc}	Cost: marginal cost	[EUR/MWh]
C^{co2}	Cost: CO ₂	[EUR/tCO ₂]
C^{fuel}	Cost: fuel	[EUR/MWhraw]
C^{vom}	Cost: variable operation and maintenance	[EUR/MWh]
C^{an}	Cost: annualised capital expenditures	[EUR/MWh]
Q^{init}	Initial capacity	[MW]
P^{exp}	Export power flow	[MW]
P^{imp}	Import power flow	[MW]
P^{load}	Electrical load	[MW]
$P^{load-new}$	Electrical load from new appliances	[MW]
$V^{flexshare}$	Share of electrical load from new appliances available for shifting	[%]
V^{shift}	Number of hours electrical load can be shifted	[h]
V^{cf}	Capacity factor	[%]
V^{avail}	Availability factor	[%]
V^{em}	Fuel emissions	[tCO ₂ /MWhraw]
V^{inflow}	Water inflow in reservoirs of dams	[MW]
V^{maxd}	Maximal annual electricity demand	[MW]
V^{cre}	Capacity credit	[#]
$V^{anc,con}$	Ancillary electricity demand for conversion units	[#]
$V^{anc,rec}$	Ancillary electricity demand for conversion units	[#]
W^{pro}	Producer surplus	[EUR]
W^{con}	Consumer surplus	[EUR]
W^{h2}	Total cost for hydrogen supply	[EUR]
e^{ta}	Efficiency	[%]
Lower indices		
t	Hourly timestep	
z	Zone of hydrogen demand	
g	Generation unit	
s	Storage unit	
m/mm	Market zone	
f	Fuel type	
e	Electrolyser type	
c	Storage form of hydrogen	
b	Battery type	
r	RES type	
l	Geospatial correlation	
Sets		
T^{bal}	All hours of regulation specific balancing period (e.g., daily, weekly, monthly)	
T^{day}	All hours of a day	
T^{week}	All hours of a week	
T^{must}	Time period in which must run obligation needs to be met	
T^1	First hour of the year	
T^{8760}	Last hour of the year	
T	Hours of the year	
T^{int}	Dynamic interval for load shifting	
M	Electricity markets	
Z	Zones with hydrogen demand (e.g., DE north, DE south, DE center)	
S	Storage units	
G	Generation units	
R	Renewable generators $R \subset G$	
U	Generators with must run obligations $U \subset G$	
D	Dams	
F	Fuel type (e.g., Natural gas, solar PV, nuclear)	
B	Battery type	
E	Electrolyser type (e.g., PEM, alkaline)	
C	Hydrogen storage types (e.g., LH ₂ , CH ₂ , LOHC)	
L	All locations of regulation specific geographical correlation (e.g., Same bidding zone)	

Table A.1: Nomenclature – optimisation model

A.2.1 Overall dispatch model

The electricity market model is formulated as linear optimisation problem and represents a stylised form of the wholesale market. It aims at minimising the costs for the supply of exogenous demands².

² Except for the endogenous demand caused by PtH₂ units

The model results in an hourly plant dispatch of every generating unit within the considered spatial and temporal scope as well as in endogenous investments and divestments in various technologies. The objective function (A.1) minimizes overall system costs. It consists of three parts: the costs of the power generation units (c^{ass} - only in Step 1), investment costs for the components required to supply the hydrogen (c^{h2} - only in Step 2) and the generation costs for the total electricity supply (c^{gen}).

$$\min \quad c^{ass} + c^{h2} + c^{gen} \quad (\text{A.1})$$

Each of the individual elements can be described in more details. We first only introduce the parts that are common to both applications of the model namely Step 1 and Step 2 of the analysis. In Subsection A.2.2 and A.2.3 we then introduce the elements that are specific for each of the two steps.

The total generation costs are the sum of both, the operational costs of all generation units and the cost occurring through the charging and discharging of storage facilities (A.2).

$$C^{gen} = \sum_m \sum_g \sum_t p_{m,g,t} \cdot C_{m,g}^{mc} + \sum_m \sum_s \sum_t (p_{m,s,t}^{ch} + p_{m,s,t}^{dis}) \cdot C_{m,s}^{mc} \quad (\text{A.2})$$

The marginal costs for generation and storage units are calculated by (A.3) and (A.4) respectively.

$$C_{m,g}^{mc} = \frac{1}{\eta_{m,g}} \cdot (C_f^{fuel} + C^{CO2} \cdot V_f^{em}) + C_g^{vom} \quad \forall g \in f \quad (\text{A.3})$$

$$C_{m,s}^{mc} = \frac{1}{\eta_{m,s}} \cdot (C_f^{fuel} + C^{CO2} \cdot V_f^{em}) + C_s^{vom} \quad \forall s \in f \quad (\text{A.4})$$

The costs minimisation is subject to various constraints. (A.5) represents the balance of all power generation and all electrical demand at both every timestep and every market zone.

$$\begin{aligned} & P_{m,t}^{load} + \sum_u p_{m,u,t}^{fix} + \sum_u \sum_{tt}^{T^{int}} p_{m,u,tt}^{flex} + \sum_s p_{m,s,t}^{ch} + \sum_{mm} p_{m,mm,t} + P_{m,t}^{exp} + \sum_z p_{z,t}^{src} + p_{m,t}^{curt} \\ & = + \sum_g p_{m,g,t} + \sum_s p_{m,s,t}^{dis} + \sum_{mm} p_{mm,m,t} + P_{m,t}^{imp} + \sum_z \sum_l \sum_g (p_{z,l,g,t}^{pro} + p_{z,l,g,t}^{sur}) \end{aligned} \quad (\text{A.5})$$

$$\forall m \in M, \forall t \in T, T^{int} = \{t - V^{shift} : t + V^{shift}\}$$

The power production of renewables in the electricity market is set by their installed capacity and the corresponding capacity factor as expressed in (A.6).

$$p_{m,g,t} = q_{m,g}^{cap} \cdot V_{m,g}^{cf} \quad \forall g \in R, \forall t \in T \quad (\text{A.6})$$

Expression A.7 represents the must run conditions. In our analysis it is considered through combined heat and power obligations of generators using biomass. Over a defined period $T^{mustrun}$ their

generation must meet a certain generation level expressed by $V^{mustrun}$.

$$\sum_t^{T^{mustrun}} p_{m,g,t} = \sum_t^{T^{mustrun}} q_{m,g}^{cap} \cdot V_{m,g,t}^{mustrun} \quad \forall g \in U, \forall t \in T \quad (\text{A.7})$$

(A.8) and (A.9) limit the decision variables of the power generation and the power exchange between neighbouring countries to their available capacity.

$$0 \leq p_{m,g,t} \leq q_{m,g}^{cap} \cdot V_{m,g,t}^{avail} \quad \forall m \in M, \forall g \in C, \forall t \in T \quad (\text{A.8})$$

$$p_{m,mm,t} \leq V_{m,mm}^{cap} \cdot V_{m,mm,t}^{avail} \quad \forall m \wedge mm \in M, \forall t \in T \quad (\text{A.9})$$

Storage units, that include both pumped hydro storage and battery storage facilities are represented by (A.9) to (A.13). Where (A.9) and (A.12) define the storage level of all storage facilities at the beginning and at the end respectively, and (A.11) the intermediate storage level within the year. The corresponding decision variables of the storage representation are limited by the given maximum capacities (A.13).

$$l_{m,s,t} = q_{m,s}^{vol} \cdot 0.5 + p_{m,s,t}^{ch} \cdot \eta_{m,s} - \frac{p_{m,s,t}^{dis}}{\eta_{m,s}} \quad \forall m \in M, \forall s \in S, \forall t \in T_1 \quad (\text{A.10})$$

$$l_{m,s,t} = l_{m,s,t-1} + p_{m,s,t}^{ch} \cdot \eta_{m,s} - \frac{p_{m,s,t}^{dis}}{\eta_{m,s}} \quad \forall m \in M, \forall s \in S, \forall t \in T \quad (\text{A.11})$$

$$q_{m,s}^{vol} \cdot 0.5 = l_{m,s,t-1} + p_{m,s,t}^{ch} \cdot \eta_{m,s} - \frac{p_{m,s,t}^{dis}}{\eta_{m,s}} \quad \forall m \in M, \forall s \in S, \forall t \in T_{8760} \quad (\text{A.12})$$

$$0 \leq l_{m,s,t} \leq q_{m,s}^{vol}, \quad 0 \leq p_{m,s,t}^{dis} \leq q_{m,s}^{cap}, \quad 0 \leq p_{m,s,t}^{ch} \leq q_{m,s}^{cap} \quad \forall m \in M, \forall s \in S, \forall t \in T \quad (\text{A.13})$$

Beside the consideration of storage facilities in the model, hydro reservoirs that only allow to produce electricity by releasing water from the reservoirs are also included in the modelling. Often this technology is referred to ‘dams’. We constraint the operation of dams through the weekly balance of energy inflows and outflows (A.14).

$$\sum_t^{T^{week}} p_{m,g,t} = \sum_t^{T^{week}} V_{m,g,t}^{inflow} \quad \forall m \in M, \forall g \in D \quad (\text{A.14})$$

The model also considers demand-side flexibility through load shifting. Storage options enable the temporal shift of energy, allowing for certain electrical applications (such as electric mobility and electric heating) to deviate from their original consumption pattern by a few hours. It is possibility is implemented in the model through expression (A.15) to (A.17).

$$P_{m,u,t}^{load-new} = p_{m,u,t}^{fix} + \sum_{tt}^{T^{int}} p_{m,u,t,tt}^{flex} \quad \forall u \in U; \forall t \in T; T^{int} = \{t - V^{shift} : t + V^{shift}\} \quad (A.15)$$

$$(1 - V^{flexshare}) \cdot P_{m,u,t}^{load-new} = p_{m,u,t}^{fix} \quad \forall u \in U; \forall t \in T \quad (A.16)$$

$$V^{flexshare} \cdot P_{m,u,t}^{load-new} = \sum_{tt}^{T^{int}} p_{m,u,t,tt}^{flex} \quad \forall u \in U; \forall t \in T \in T; T^{int} = \{t - V^{shift} : t + V^{shift}\} \quad (A.17)$$

A.2.2 Investment mode

The total investment costs of generation units includes both the annualised capital expenditures of possible investments and the fixed operational expenditures of all installed units (A.18) to (A.20).

$$c^{ass} = c^{inv} + c^{fix} \quad (A.18)$$

$$c^{inv} = \sum_m^M \sum_g^G q_{m,g}^{inv} \cdot V_g^{an} + \sum_m^M \sum_s^S q_{m,s}^{inv} \cdot V_s^{an} \quad (A.19)$$

$$c^{fix} = \sum_m^M \sum_g^G q_{m,g}^{cap} \cdot V_g^{fix} + \sum_m^M \sum_s^S q_{m,s}^{cap} \cdot V_s^{fix} \quad (A.20)$$

The available generation capacity is determined using (A.21) and (A.22). The initial starting capacity is set through the existing power plant fleet and is imputed as exogenous data input.

$$q_{m,g}^{cap} = Q_{m,g}^{init} + q_{m,g}^{inv} - q_{m,g}^{div} \quad \forall m \in M, \forall g \in G \quad (A.21)$$

$$q_{m,s}^{cap} = Q_{m,s}^{init} + q_{m,s}^{inv} - q_{m,s}^{div} \quad \forall m \in M, \forall s \in S \quad (A.22)$$

The generation fleet might fulfil certain capacity levels that are set by the national governments (e.g., expansion targets of renewable energies, capacity reductions due to phase-out policies). To include these aspects three additional constraints are added to the model, that set either a capacity cap (A.23), a capacity target (A.24) or a capacity floor (A.25) for the affected energy types.

$$V_{m,g}^{lim} \geq \sum_c^C q_{m,g}^{cap} \quad \forall m \in M, \forall g \in G; \quad V_{m,s}^{lim} \geq \sum_c^C q_{m,s}^{cap} \quad \forall m \in M, \forall s \in S \quad (A.23)$$

$$V_{m,g}^{flo} \leq \sum_c^C q_{m,g}^{cap} \quad \forall m \in M, \forall g \in G; \quad V_{m,s}^{flo} \leq \sum_c^C q_{m,s}^{cap} \quad \forall m \in M, \forall s \in S \quad (A.24)$$

$$V_{m,g}^{tar} = \sum_c^C q_{m,g}^{cap} \quad \forall m \in M, \forall g \in G; \quad V_{m,s}^{tar} = \sum_c^C q_{m,s}^{cap} \quad \forall m \in M, \forall s \in S \quad (\text{A.25})$$

To ensure capacity adequacy in each of the considered power markets, a constraint on the overall capacity is introduced per market zone (A.26). It ensures, that the installed capacity is greater than the occurring maximal electricity load³ that is increased by a security factor of 10%. Parameter V^{cre} , is the so-called capacity credit, that is a pre-defined value accounting for the statistical permanent availability of the individual energy types. Consequently, the value reduces the risk of insufficient available capacity at any given time. Corresponding values for the capacity credit can be found in Table A.11.

$$V_m^{maxd} \cdot 1.1 \leq \sum_c^C (g_{m,g}^{cap} \cdot V_g^{cre}) + \sum_s^S (g_{m,s}^{cap} \cdot V_s^{cre}) \quad \forall m \in M \quad (\text{A.26})$$

A.2.3 Hydrogen Supply

The costs linked to the supply of hydrogen are represented through (A.27). They include investment costs for battery storage facilities, electrolyser systems, hydrogen storage units as well as the costs for all required conversion steps. Furthermore, the investment expenditures of potential capacity additions of renewable energies are added.

$$c^{h2} = \sum_z^Z \sum_b^B q_{z,b}^{bat} \cdot C_b^{an} + \sum_z^Z \sum_e^E q_{z,e}^{pth2} \cdot C_e^{an} + \sum_z^Z \sum_c^C (q_{z,c}^{sto} \cdot C_c^{sto,an} + q_{z,c}^{con} \cdot C_c^{con,an}) + \sum_z^Z \sum_r^R q_{z,r}^{res} \cdot C_r^{an} \quad (\text{A.27})$$

The supply of hydrogen is described by two balancing equations (A.28) and (A.29) that are similar to the one for each electricity market zone (A.5). Equation (A.28) represents the balancing of volumes on the electrical side of the electrolyser (input) and equation (A.29) the balancing of volume flows on the hydrogen side (output). They ensure an adequate supply of the exogenous hydrogen demand for every considered location.

$$p_{z,t}^{src} = \sum_b^B (p_{z,b,t}^{ch} - p_{z,b,t}^{dis}) + \sum_e^E p_{z,e,t}^{inj} + \sum_c^C (p_{z,c,t}^{ch} \cdot V^{anc,con} + p_{z,c,t}^{dis} \cdot V^{anc,rec}) \quad \forall z \in Z, \forall t \in T \quad (\text{A.28})$$

$$\sum_e^E (p_{z,e,t}^{inj} \cdot \eta_e) = \sum_c^C (p_{z,c,t}^{ch} - p_{z,c,t}^{dis}) + p_{z,t}^{sup} \quad \forall z \in Z, \forall t \in T \quad (\text{A.29})$$

The supply of hydrogen needs to match the exogenous hydrogen demand on a daily level as shown on (A.30).

³ Without consideration of the load increases through the hydrogen demand

$$\sum_t^{T_{day}} p_{z,t}^{sup} = \sum_t^{T_{day}} P_{z,t}^{load,h2} \quad \forall z \in Z, \forall t \in T \quad (\text{A.30})$$

The electricity that is injected into the electrolyser is restricted by the installed capacity of the system (A.31).

$$p_{z,e,t}^{inj} \leq q_{z,e}^{pth2} \quad \forall z \in Z, \forall e \in E, \forall t \in T \quad (\text{A.31})$$

While the battery storage on the electrical side of the electrolyser is described similarly as for the storage facilities in the electricity market representation (see (A.10)-(A.13)), the hydrogen storage includes additional restrictions through the conversion and reconversion units. Hydrogen storage facilities are described by equations (A.32) to (A.35).

$$l_{z,c,t} = q_{z,c}^{sto} \cdot 0.5 + p_{z,c,t}^{ch} \cdot \eta_{z,c} - \frac{p_{z,c,t}^{dis}}{\eta_{z,c}} \quad \forall z \in Z, \forall c \in C, \forall t \in T_1 \quad (\text{A.32})$$

$$l_{z,c,t} = l_{z,c,t-1} + p_{z,c,t}^{ch} \cdot \eta_{z,c} - \frac{p_{z,c,t}^{dis}}{\eta_{z,c}} \quad \forall z \in Z, \forall c \in C, \forall t \in T \quad (\text{A.33})$$

$$q_{z,c}^{sto} \cdot 0.5 = l_{z,c,t-1} + p_{z,c,t}^{ch} \cdot \eta_{z,c} - \frac{p_{z,c,t}^{dis}}{\eta_{z,c}} \quad \forall z \in Z, \forall c \in C, \forall t \in T_{8760} \quad (\text{A.34})$$

$$0 \leq l_{z,c,t} \leq q_{z,c}^{sto}, \quad 0 \leq p_{z,c,t}^{dis} \leq q_{z,c}^{con}, \quad 0 \leq p_{z,c,t}^{ch} \leq q_{z,c}^{con} \quad \forall z \in Z, \forall c \in C, \forall t \in T \quad (\text{A.35})$$

Regulatory aspects are considered through the expressions that follow hereafter. The temporal correlation of the generation of renewable electricity and its sourcing to produce electrolytic hydrogen is given through (A.36). The sum of the sourced electricity in the corresponding timeframe is equal to the one that is generated by additional renewables and that is also assigned for the hydrogen production.

$$\sum_t^{T_{bal}} p_{z,t}^{src} = \sum_t^{T_{bal}} \sum_l^L \sum_g^R p_{z,g,t}^{pro} \quad \forall z \in Z \quad (\text{A.36})$$

The generation of renewable electricity is addressed through expression (A.37). It includes the consideration of geographical requirements through potential regulations. The equation splits the produced renewable electricity into three parts: (1) A part (p^{pro}) that is dedicated for the production of electrolytic hydrogen, (2) a part (p^{inj}) that is surplus electricity and potentially sold to the market to obtain additional revenues and (3) a part (p^{cur}) that cannot be used for any of the two latter two purposes and hence, that is curtailed.

$$q_{z,l,g}^{res} \cdot V_{l,g,t}^{cf} = p_{z,l,g,t}^{pro} + p_{z,l,g,t}^{sur} + p_{z,l,g,t}^{cur} \quad \forall z \in Z, \forall l \in L, \forall g \in R, \forall t \in T \quad (\text{A.37})$$

A.3 Further calculations

A.3.1 Calculation of Levelized Costs of Hydrogen – LCOH

$$c^{lcoh} = \frac{(c^{h2} + C^{sell} - C^{src})}{\sum_z \sum_t P_{z,t}^{load,h2}} \quad (\text{A.38})$$

Where the numerator consists of occurring costs of the hydrogen production and the denominator represents the overall demanded and supplied hydrogen. The costs for the selling of renewable electricity to the market (C^{sell}) and for the sourcing of electricity from the market (C^{src}) are calculate after solving the optimization of the wholesale electricity market (see (A.39) and (A.40)).

$$C^{sell} = \sum_m \sum_z (V_{m,t}^{mp} \cdot \sum_l \sum_g p_{z,l,g,t}^{sur}) \quad (\text{A.39})$$

$$C^{src} = \sum_m \sum_z (V_{m,t}^{mp} \cdot \sum_z \sum_g p_{z,l,g,t}^{src}) \quad (\text{A.40})$$

A.3.2 Calculations of consumer and producer surplus as well as total hydrogen costs

The consumer surplus is calculated by (A.41). As the electricity demand is assumed to be perfectly inelastic, we set a price cap for the market price in the electricity wholesale market of 3000.

$$W^{con} = \sum_m \sum_t P_{m,t}^{load} \cdot 3000 - \sum_m \sum_t P_{m,t}^{load} \cdot V_{m,t}^{mp} \quad (\text{A.41})$$

The producer surplus is determined by (A.42).

$$W^{pro} = \sum_m \sum_t ((\sum_g p_{m,g,t} + \sum_s p_{m,s,t}^{dis} - \sum_s p_{m,s,t}^{ch}) \cdot V_{m,t}^{mp}) - C^{gen} \quad (\text{A.42})$$

The total hydrogen costs are calculated by (A.43).

$$W^{h2} = c^{lcoh} \cdot \sum_z \sum_t P_{z,t}^{load,h2} \quad (\text{A.43})$$

A.4 Data

A.4.1 General Assumptions

All cost data in this study are expressed in EUR2020.

Parameter	Value
Exchange rate	0.89 EUR/USD
Lower Heating Value H ₂	33.3 kWh/kg
WACC general	7%
WACC offshore	6%
WACC onshore	5%
WACC PV	5%
WACC H ₂ technologies	5%

Table A.2: General assumptions

A.4.2 Data on power sector representation

Country ^a	Floor ^b				Target ^b			Cap	
	PV	Onshore	Offshore	Battery	Biomass ^c	Nuclear	Hard coal ^d	Lignite ^d	Offshore ^e
AT	12	9	0	2.5/2.1	0.6	0	0	0	0
BE	10.4	4.7	5.8	0.8/2.1	0.5/0.9	0	0	0	5.8/6.0
CH	9.8	0.3	0	0.7/0.0	0.4	1.2	0	0	0
CZ	8.2	0.7	0	1.2/1.5	0.7	4	0.3	2.3	0
DE	100 ^f	71 ^f	20 ^f	12.2/52.0 ^g	8.4 ^f	0	8.0/0.0 ^h	9.0/0.0 ^h	24.0/30.0
DK	6.5	6.2	6.8	0.0/0.1	0.2/2.5	0	0	0	10.3/12.9
FR	43.8	36	4.4	0.3/0.7	2.4	59.1	0	0	4.4
LU	0.6	0.4	0	0.0/0.1	0.1	0	0	0	0
NL	27.3	8	11.5	5.8/6.8	0.6/3.9	0.5	0	0	16.8/21.0
NO	0.6	6.1	0.2	0.0/0.4	0	0	0	0	8.0/10.0
PL	5.1	8.7	5.9	0.0/2.0	1.4/2.9	0	19.1	7.6	5.9
SE	7.3	16.9	5	0.5/2.6	5.1/4.8	5.9	0	0	5
UK	23.4	26.6	34.8	9.3/7.8	6.4/9.3	9.3	0	0	40.0/50.0

^aThe capacities of all hydro power plants are kept at 2019 values

^b(ENTSOE 2022b): National Trend / Distributed Energy – CY2009

^cCategory 'Other RES' is assigned to the capacity of biomass

^dCoal phase-out according to EC (https://energy.ec.europa.eu/topics/oil-gas-and-coal/eu-coal-regions/coal-regions-transition_en)

^eAccording to announcements within the North Sea Energy Cooperation (NSEC) (NSEC 2022), For non-neighbouring states to the North Sea ENTSOE (2022b) - National Trend Scenario – CY 2009. The reduced values refer to 80% of the latest announcements but at least the targets within the ENTSOE (2022b) – National Trend Scenario – CY 2009

^f(German Government 2021)

^g(BNetzA 2020a) Scenario B / (BNetzA 2020a) Scenario B

^h(German-Government 2020): German law for the phase-out of coal / Discussions on bringing the phase-out forward to 2030 (<https://www.bundesregierung.de/breg-de/schwerpunkte/klimaschutz/kohleausstieg-1664496>)

Table A.3: Considered capacity floors, targets, and caps

A.4.2.1 Consideration of must run obligations

In addition to the provision of electricity, biomass and waste fired power generators are also assumed to provide heat (CHP). The hourly must run obligations are based on historical generation profiles taken from ENTSOE (2022a). While in the baseline scenario it is assumed that this profile has to be fulfilled on an hourly level ($T^{mustrun}$), in the advanced energy scenario the balancing is done on a daily level.

Country	Conventional	Hydrogen	Heat pumps	Mobility		
				Bus	Car	Truck
AT	74.4/86.8	6.2/12.5	6.1/4.5	0.1/0.1	1.7/2.0	0.2/0.2
BE	81.6/94.5	1.1/2.3	10.7/12.3	0.2/0.2	2.3/2.7	0.4/0.4
CH	63.5/59.6	1.2/2.5	0.4/0.4	0.0/0.0	0.2/0.2	0.0/0.0
CZ	67.3/65.5	0.0/0.0	4.6/9.2	0.2/0.2	1.8/1.7	0.4/0.4
DE	544.3/633.8	40.0/40.0	18.4/50.6	0.0/0.4	25.0/38.1	3.4/20.4
DK	42.2/42.2	1.2/2.4	7.2/7.2	0.1/0.1	3.1/3.1	0.4/0.4
FR	419.0/487.9	6.9/13.9	38.1/44.3	1.6/1.8	17.6/20.5	5.1/5.9
LU	6.6/4.6	0.0/0.0	1.7/1.2	0.0/0.0	0.3/0.2	0.1/0.1
NL	128.6/169.7	4.0/8.1	5.1/6.7	0.3/0.4	3.3/4.3	2.0/2.6
NO	164.8/172.5	0.0/0.0	0.0/0.0	0.0/0.0	0.0/0.0	0.0/0.0
PL	157.7/167.0	4.1/8.3	17.4/7.1	0.4/0.4	4.2/4.4	2.0/2.1
SE	140.0/143.6	1.1/2.1	8.9/18.4	0.1/0.1	2.9/3.0	0.7/0.7
UK	266.4/366.4	6.8/13.6	33.5/46.1	0.2/0.3	11.5/15.8	4.1/5.7

Source: (ENTSOE 2022b) - National Trend Scenario / Distributed Energy Scenario. The electricity demand for heat pumps is based on the categories 'Space heating' and 'Water heating'. To account for conventional electric heating devices (e.g., electric radiators) within the values, we subtract 6% (33% replacement rate assumption) of the reference year values from the 2030 values. As the data of the National Trend Scenario, do not distinguish between electricity demand for conventional purposes, heat pumps and mobility, the values are derived from the corresponding ratios of the Distributed Energy Scenario.

Table A.4: Electricity demand

A.4.2.2 Load profiles of new electric appliances

Three types of new electrical appliances are considered in the analysis, namely electric mobility, electric heating and electrolytic hydrogen production. As demand profiles differ from historical profiles, they are treated separately.

- Electric heating: Population weighted ambient temperature profiles from Renewable Ninja⁴ serve as basis for the creation of hourly heat pump profiles. The hourly profiles are first averaged to daily profiles. Next, standard heat pump profiles⁵ are assigned to the individual days. The obtained hourly profiles are then normalised.
- Electric mobility: Typical daily profiles for three mobility types (bus, truck, car) are taken from ENTSOE (2022b) to create normalised yearly charging profiles with hourly granularity.
- Electrolytic hydrogen production: While electrolytic hydrogen production in Germany is considered endogenously, for all other countries they are set endogenously. A flat consumption profile over the entire year is assumed.

For electric mobility and electric heating demand side flexibility in form of load shifting is implemented. It is assumed that 25% of the corresponding hourly profiles are flexible ($V^{flexshare}$). This flexible part can be shifted by 2 hours⁶ either forwards or backwards (V^{shift}).

⁴ <https://www.renewables.ninja/>

⁵ <https://www.swm-infrastruktur.de/strom/netzzugang/bedingungen/waermepumpe>

⁶ 4 hours in the advanced energy transition

Energy type	Capex [EUR/kW]	Opex fix [EUR/kW]				Opex var [EUR/MWh]			
	2030	1980	2000	2020	2030	1980	2000	2020	2030
Biomass	1892	51.2	50.5	49.9	42.1	3.7	3.7	3.7	3.7
Hard coal	1817	39.7	39.4	39.2	37.1	3.7	3.7	3.7	3.6
Lignite	1962	42.9	42.7	42.5	41.0	4.1	4.1	4.1	4.0
Natural gas - Other	496	17.4	17.3	17.3	16.9	2.2	2.2	2.2	2.1
Natural gas - CCGT	586	22.2	22.1	22.1	21.5	2.1	2.1	2.1	2.0
Natural gas - OCGT	406	12.6	12.5	12.5	12.3	2.2	2.2	2.2	2.2
Nuclear	5517	128.2	127.2	126.1	120.9	6.5	6.6	6.7	7.8
Oil	420	24.6	24.3	23.9	21.8	2.8	2.8	2.8	2.8
Other	1425	33.3	33.2	33.0	31.7	3.3	3.3	3.3	3.2
Other res	1892	39.7	39.4	39.2	37.1	3.7	3.7	3.7	3.6
Peat	1962	42.9	42.7	42.5	41.0	4.1	4.1	4.1	4.0
Waste	1892	51.2	50.5	49.9	42.1	3.7	3.7	3.7	3.7
Ps	650.0	23.8	23.0	9.8	9.8	0.0	0.0	0.0	0.0
Ror	1754	26.8	26.8	26.8	26.8	0.3	0.3	0.3	0.3
Dam	2207	28.9	27.5	18.1	1.6	0.0	0.0	0.0	0.0

Values for 2020 and 2030 based on E3-Modelling (2021); Historical values approximated based on Kunz et al. (2017); Intermediate values were linearly interpolated

Table A.5: Considered cost parameters

Energy type ^a	Capex [EUR/kW] 2030	Opex fix [% of Capex]
PV	487/446	2.0
Onshore	1376/1354	2.5
Offshore	2023/1884	2.5
Battery	626	0.25 ^b

^a Data based on IEA (2022c). Considered lead times: PV 2/1 years, Onshore 3/2 years, Offshore 4/3 years; Onshore and solar PV corrected to German specific data from ZSW (2022) and Lüers, Rehfeldt, and Heyken (2022)

^b (NREL 2022b)

Table A.6: Considered cost parameter – renewables and batteries

Energy type ^a	Efficiency [%]				Lifetime [years] ^b
	1980	2000	2020	2030	
Biomass	35.0	35.0	35.0	39.0	40
Hard coal	37.5	42.3	42.3	44.3	40
Lignite	35.2	38.6	38.7	39.7	40
Natural gas - Other	38.9	44.2	47.3	48.3	30
Natural gas - CCGT	45.0	54.0	58.5	59.5	30
Natural gas - OCGT	32.8	34.4	36.0	37.0	25
Nuclear	33.0	33.0	38.0	38.0	-
Oil	35.0	35.0	35.0	35.0	40
Other	24.2	27.5	42.7	44.1	37
Other res	35.0	35.0	35.0	39.0	40
Peat	35.2	38.6	38.7	39.7	40
Waste	33.0	33.0	35.0	39.0	40
Ps	70.0	70.0	70.0	70.0	-
Ror	-	-	-	-	-
Dam	-	-	-	-	-
Battery ^c	85.0	85.0	85.0	85.0	15
Pv ^d	-	-	-	-	25
Onshore ^d	-	-	-	-	25
Offshore ^d	-	-	-	-	25

^a If not stated differently values derived from Kunz et al. (2017) and E3-Modelling (2021)

^b Technologies without lifetime are assumed to be kept operational through retrofitting

^c (NREL 2022b)

^d (IEA 2022c)

Table A.7: Considered technical parameters

Parameter	Storage duration
Pumped storage	48h
Battery	4h

Own assumption

Table A.8: Considered technical parameter of electrical storage units

Fuel type	Hard coal	Lignite	Natural gas	Nuclear	Oil	Other	RES	Peat	Waste
[tCO ₂ /MWh _{raw}]	0.34	0.397	0.2	0	0.28	0.39	0	0.38	0.39

Values based on information of Prof. Quaschnig - https://www.volker-quaschnig.de/datserv/C02-spez/index_e.php

Table A.9: Considered fuel emissions

Fuel type/ CO ₂ ^a	Natural gas ^b	Hard coal ^b	Lignite ^c	Nuclear ^c	Biomass ^c	Oil ^b	Waste ^d	Other ^e	CO ₂
[EUR/MWh _{raw}]/ [EUR/tCO ₂]	26.5/24.6	7.1/7.3	5.6	1.7	72.4	41.4/32.3	0.0	25.0/21.4	73.9/110.9

^a Values corrected to EUR2020; USD/EUR Exchange 0.89

^b IEA (2022c): Stated Policies Scenario / Announced Pledges Scenario

^c (ENTSOE 2022b)

^d (EWI 2022)

^e Average of hard coal, natural gas and oil

Table A.10: Considered fuel and CO₂ prices

Fuel type	Value
Biomass	1
Hard coal	1
Lignite	1
Natural gas	1
Nuclear	1
Oil	1
Other	1
Other RES	0.2
Peat	1
Waste	1
Run of river	0.2
PV	0.01
Offshore	0.12
Onshore	0.08
Pumped storage	1
Dam	1

Own assumption also based on NationalGrid (2019)

Table A.11: Considered capacity credits

Parameter	2021	2030 Floor
AT	76%	80%/100%
BE	26%	32%/40%
CZ	15%	15%/17%
DE	44%	64%/80%
DK	63%	88%/110%
FR	25%	32%/40%
LU	14%	27%/34%
NL	30%	40%/50%
NO	114%	100%/100%
PL	17%	26%/32%
SE	76%	76%/85%
UK	40%	76%/95%

2021 values based on https://ec.europa.eu/eurostat/databrowser/view/NRG_IND_REN__custom_4673215/default/table?lang=en - NRG_IND_REN; Higher share in 2030 based on announced objectives (mainly on NCEPs https://commission.europa.eu/energy-climate-change-environment/implementation-eu-countries/energy-and-climate-governance-and-reporting/national-energy-and-climate-plans_en; Lower shares in 2030 is 80% of the higher shares, or at least 2021 levels.

Table A.12: Minimum share of renewable energies in national electricity demand

A.4.3 Data on hydrogen Sector

Plant	Postcode	Latitude	Longitude	Use	Demand
ArcelorMittal Bremen	28237	53.10309	8.55698	Steel	0
ArcelorMittal Duisburg	47137	51.4591	6.85138	Steel	0
ArcelorMittal Eisenhüttenstadt	15890	52.12506	14.61731	Steel	0
ArcelorMittal Hamburg	21129	53.4439	9.88358	Steel	46.7
ROGESA (Dillinger & Saarstahl)	66763	49.35197	6.67694	Steel	37.7
HKM Duisburg	47259	51.34585	6.60152	Steel	0
Salzgitter Peine	38239	52.19835	10.51117	Steel	39.3
Thyssenkrupp Steel Europe Duisburg	47166	51.54955	6.71394	Steel	107.8
BASF Ludwigshafen	6886	51.84341	12.96524	Ammonia	90.5
INEOS Köln	50769	51.09505	6.79096	Ammonia	39.3
SKW Stickstoffwerke Piesteritz	6886	51.84341	12.96524	Ammonia	98.2
YARA Brunsbüttel	25572	53.90678	9.24221	Ammonia	77.6
BASF Ludwigshafen	67063	49.4824	8.40591	Methanol	49.4
Shell Rheinland Raffinerie - Süd	50389	50.77226	6.92255	Methanol	47.9
Ruhr Oel - BP Gelsenkirchen	45896	51.58475	6.98181	Methanol	30.8
Total Raffinerie Mitteldeutschland	6237	51.39492	11.94351	Methanol	76.9
Bayernoil Raffineriegesellschaft	85088	48.79239	11.50131	Raffinery	3.3
BP Raffinerie Lingen	49808	52.46438	7.26746	Raffinery	3.7
Gunvor Raffinerie Ingolstadt	85092	48.79332	11.47829	Raffinery	3.8
Holborn Europa Raffinerie	21079	53.49622	9.99893	Raffinery	4
MiRO Mineraloelraffinerie Oberrhein	76187	49.00896	8.32626	Raffinery	11.5
Nynas	21079	53.49622	9.99893	Raffinery	1.4
OMV Deutschland	85622	48.26674	11.5892	Raffinery	2.8
PCK Raffinerie	16303	53.08918	14.25221	Raffinery	8.9
Raffinerie Heide	25770	54.20437	9.04484	Raffinery	3.3
Ruhr Oel - BP Gelsenkirchen	45896	51.58475	6.98181	Raffinery	10
Shell Rheinland Raffinerie Werk Nord	50997	50.88831	7.0285	Raffinery	7.2
Shell Rheinland Raffinerie Werk Süd	50389	50.77226	6.92255	Raffinery	5.6
Total Raffinerie Mitteldeutschland	6237	51.39492	11.94351	Raffinery	9.3

Values based on vom Scheidt et al. (2022) and downscaled to meet the targeted electrolyser capacity of 10 GW in Germany in 2030 (4000 full load hours and 68% efficiency)

Table A.13: Considered hydrogen demand [$\text{kt}_{\text{H}_2}/\text{a}$]

Parameter	Unit	GH ₂	LH ₂	LOHC
Capex base	[EUR]	450	13.31	10
Capex comparison	[kg _{H2}]	1	1	1
Scale	[#]	1	1	1
Ref-Capacity	[kg _{H2}]	1	1	1
Capex scaled	[EUR/kg _{H2}]	450	13.31	10
Capex scaled	[EUR/kWh _{H2}]	13.51	0.4	0.3
Capex scaled	[EUR/MWh _{H2}]	13514	400	300
Opex	[%]	2	2	2
Depreciation period	[y]	20	20	20
Pressure range	[bar]	15-250	-	-
Min filling level	[%]	6	5	-
Boil-off	[%/d]	-	0.2	-

Values based on Stöckl, Schill, and Zerrahn (2021a) and Stöckl, Schill, and Zerrahn (2021b); Assumption that size of reference facility for conversion and reconversion units is 1030 kg_{H2}/h corresponding to values for central applications

Table A.14: Considered parameters of hydrogen storage technologies

Conversion form and activity	Unit	GH ₂	LH ₂	LH ₂	LOHC	LOHC
		Compression	Liquification	Evaporation	Hydrogenation	Dehydrogenation
Capex base (var)	[EUR/kg _{H2}]	40528	643700	900.9	74657	55707
Capex base (fix)	[EUR]			2389		
Capex comparison	[kW _{el} kg _{H2} /h]	1	1	1	1	1
Scale	[#]	0.46	0.67	1	0.67	0.67
Ref-Capacity	[kg _{H2} /h]	1030	1030	1030	1030	1030
Capex scaled	[EUR/kg _{H2} /h]	959	63739	903	7393	5516
Capex scaled	[EUR/MW _{H2}]	28793	1914081	27124	221997	165648
Opex	[%]	4	4	1	4	4
Depreciation period	[a]	15	30	10	20	20
Pressure in	[bar]	30	30		30	
Pressure out	[bar]	250	2	950	0	5
Electricity demand	[kWh _{ele} /kg _{H2}]	1.707	6.78	0.6	0.37	
Heat demand	[kWh _{therm} /kg _{H2}]			0	-8.9	9.1
Losses	[%]	0.5	1.625	0	3	1

Source: All data from Stöckl, Schill, and Zerrahn (2021a) and Stöckl, Schill, and Zerrahn (2021b)

Table A.15: Considered parameters of hydrogen conversion and reconversion technologies

Parameter	Unit	Value
Capex ^a	[EUR/kW _{el}]	727/524
Opex ^b	[% of Capex per a]	1.5
Efficiency ^c	[%]	68
Lifetime	[years]	19

^a (IEA 2022c); Stated Policies Scenario / Announced Pledges Scenario; Lead times: 2/1 years + 1 year ramp-up

^b (IEA 2019d)

^c (IEA 2019c); Average of alkaline electrolyzers

Table A.16: Considered parameters of electrolyser technologies

Chapter **B**

Supplementary data for Chapter 3

B.1 Further results

B.1.1 Variation of electrolyser capacity that is affected by regulatory relaxation

Effect type	Unit [GW]	HYT vs. MAR					HYM vs. MAR				
		1	2	3	4	5	1	2	3	4	5
Cost savings	[MioEUR]	73	119	141	150	159	59	108	120	125	134
CO ₂ emission savings	[MtCO ₂]	0.3	0.6	0.8	0.9	1.0	0.3	0.5	0.6	0.8	0.9
Costs savings per kg H ₂	[EUR/kgH ₂]	0.21	0.33	0.39	0.42	0.45	0.17	0.30	0.33	0.35	0.37

Table B.1: Variation of affected electrolyser capacity in base case

B.1.2 Allocation of electrolyser capacities to grid nodes - Variation of capacity that is affected by regulatory relaxation

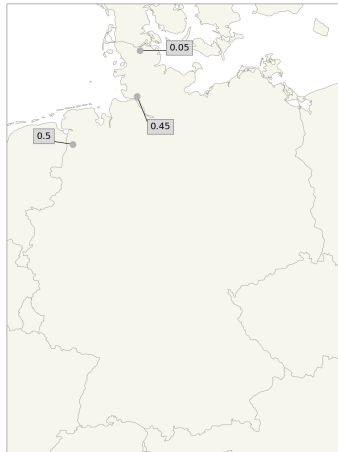

(a) 1 GW

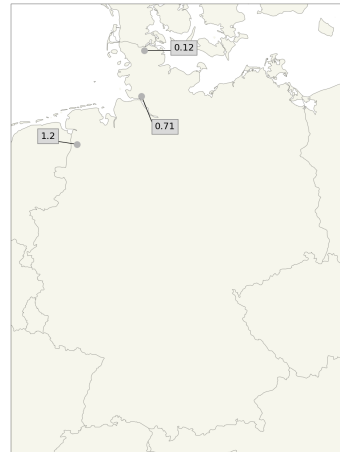

(b) 2 GW

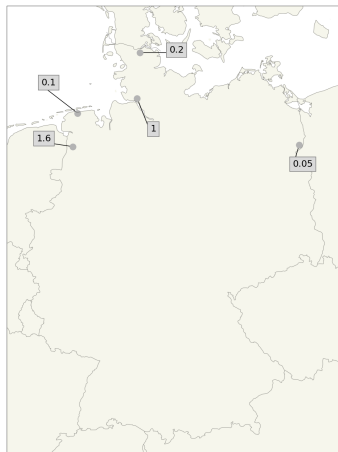

(c) 3 GW

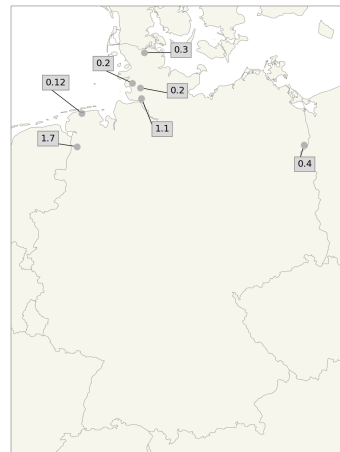

(d) 4 GW

Figure B.1: Allocation of electrolyser capacity by TSOs for various considered capacities

B.1.3 Hydrogen supply structure - Variation of capacity that is affected by regulatory relaxation

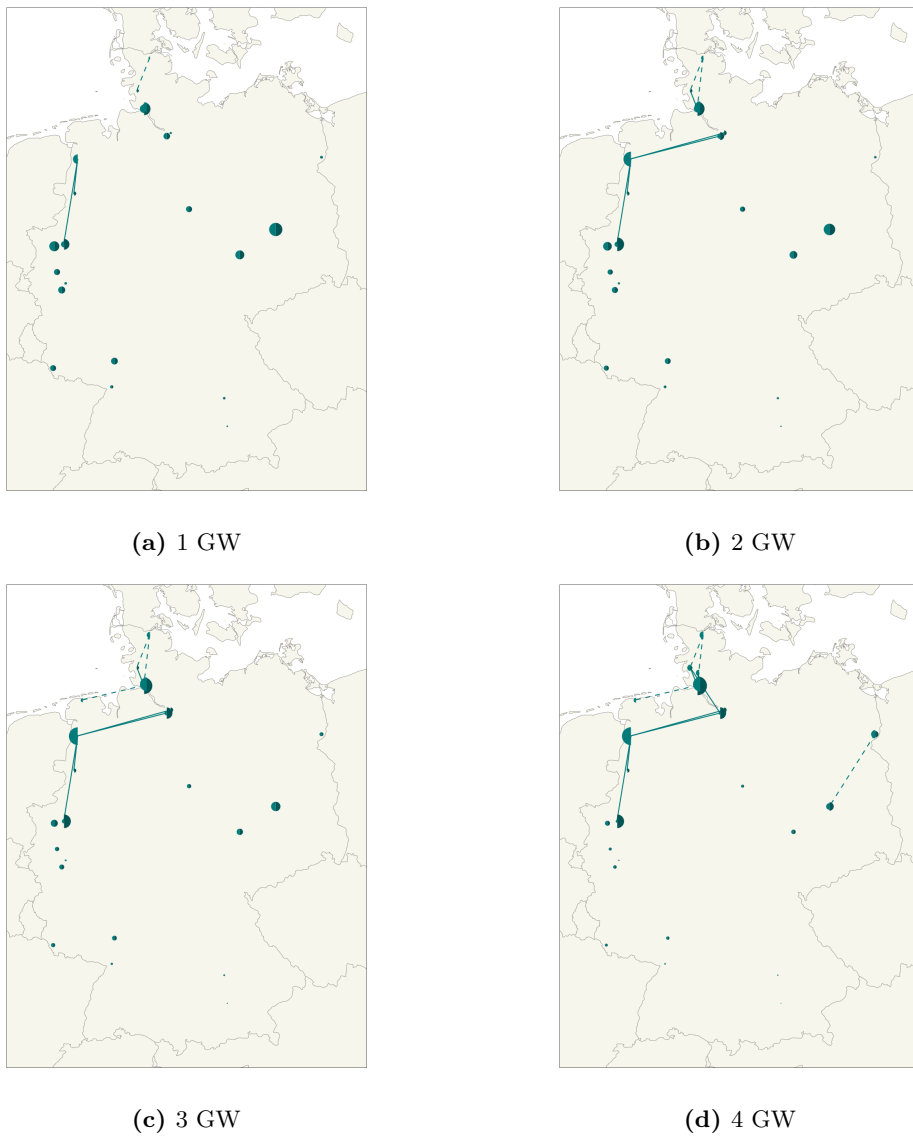

Figure B.2: Hydrogen supply structure for various system-based electrolyser capacities

B.1.4 Expanded sensitivity analysis - Variation of electrolyser capacity that is affected by regulatory relaxation

Effect type Electrolyser capacity	Classification	Unit [GW]	HYT vs. MAR					HYM vs. MAR				
			1	2	3	4	5	1	2	3	4	5
Cost savings	Absolute	[MioEUR]	60	111	133	142	134	50	84	122	110	100
	Relative to base scenario	[%]	-18%	-6%	-6%	-5%	-16%	-16%	-23%	2%	-12%	-25%
CO ₂ emission savings	Absolute	[Mt _{CO2}]	0.3	0.6	0.8	0.9	1.0	0.2	0.4	0.7	0.7	0.8
	Relative to base scenario	[%]	-14%	-3%	1%	1%	-3%	-7%	-16%	10%	-4%	-10%
Costs savings per kg H ₂	Absolute	[EUR/kg _{H2}]	0.17	0.31	0.37	0.40	0.37	0.14	0.23	0.34	0.31	0.28
	Relative to base scenario	[%]	-18%	-6%	-6%	-5%	-16%	-16%	-23%	2%	-12%	-25%

Table B.2: Variation of affected electrolyser capacity in sensitivity 1

Effect type Electrolyser capacity	Classification	Unit [GW]	HYT vs. MAR					HYM vs. MAR				
			1	2	3	4	5	1	2	3	4	5
Cost savings	Absolute	[MioEUR]	167	229	287	358	370	100	184	227	264	293
	Relative to base scenario	[%]	128%	93%	104%	139%	132%	68%	70%	90%	112%	119%
CO ₂ emission savings	Absolute	[Mt _{CO2}]	0.8	1.1	1.4	1.8	2.0	0.5	0.9	1.1	1.3	1.5
	Relative to base scenario	[%]	123%	90%	82%	103%	91%	78%	65%	68%	77%	72%
Costs savings per kg H ₂	Absolute	[EUR/kg _{H2}]	0.47	0.64	0.80	1.00	1.03	0.28	0.52	0.64	0.74	0.82
	Relative to base scenario	[%]	128%	93%	104%	139%	132%	68%	70%	90%	112%	119%

Table B.3: Variation of affected electrolyser capacity in sensitivity 2

Effect type Electrolyser capacity	Classification	Unit [GW]	HYT vs. MAR					HYM vs. MAR				
			1	2	3	4	5	1	2	3	4	5
Cost savings	Absolute	[MioEUR]	20	0	-27	-43	-85	6	-11	-48	-68	-110
	Relative to base scenario	[%]	-72%	-100%	-119%	-128%	-153%	-89%	-110%	-140%	-155%	-182%
CO ₂ emission savings	Absolute	[Mt _{CO2}]	0.3	0.5	0.6	0.7	0.8	0.2	0.4	0.5	0.6	0.6
	Relative to base scenario	[%]	-14%	-20%	-22%	-21%	-23%	-19%	-23%	-26%	-25%	-27%
Costs savings per kg H ₂	Absolute	[EUR/kg _{H2}]	0.06	0.00	-0.07	-0.12	-0.24	0.02	-0.03	-0.13	-0.19	-0.31
	Relative to base scenario	[%]	-72%	-100%	-119%	-128%	-153%	-89%	-110%	-140%	-155%	-182%

Table B.4: Variation of affected electrolyser capacity in sensitivity 3

Effect type Electrolyser capacity	Classification	Unit [GW]	HYT vs. MAR					HYM vs. MAR				
			1	2	3	4	5	1	2	3	4	5
Cost savings	Absolute	[MioEUR]	77	128	165	197	221	63	118	144	171	196
	Relative to base scenario	[%]	5%	8%	17%	31%	39%	6%	8%	20%	37%	46%
CO ₂ emission savings	Absolute	[Mt _{CO2}]	0.3	0.6	0.8	0.9	1.1	0.3	0.5	0.7	0.8	0.9
	Relative to base scenario	[%]	1%	1%	3%	5%	6%	1%	1%	4%	6%	7%
Costs savings per kg H ₂	Absolute	[EUR/kg _{H2}]	0.22	0.36	0.46	0.55	0.62	0.18	0.33	0.40	0.48	0.55
	Relative to base scenario	[%]	5%	8%	17%	31%	39%	6%	8%	20%	37%	46%

Table B.5: Variation of affected electrolyser capacity in sensitivity 4

B.1.5 Expanded sensitivity analysis - Alternative scenario

This sensitivity analysis illustrates the effects of regulatory relaxations considering updated fuel and CO₂ price assumptions. It is stated, however, that the capacities of the generation fleet as well as assumptions on the electricity demand are endogenously given and remain as in the base case scenario. Updates of fuel and CO₂ prices might, however, lead to changes in the power sector. These are therefore not considered in this analysis.

Effect type	Classification	Unit	HYT vs. MAR					HYM vs. MAR						
			1	2	3	4	5	1	2	3	4	5		
Electrolyser capacity		[GW]												
Cost savings	Absolute	[MioEUR]	111	200	238	268	302	104	178	212	243	267		
	Relative to base scenario	[%]	51%	68%	69%	79%	90%	76%	65%	77%	95%	99%		
CO ₂ emission savings	Absolute	[Mt _{CO2}]	0.3	0.6	0.8	0.9	1.1	0.3	0.5	0.7	0.8	1.0		
	Relative to base scenario	[%]	0%	4%	2%	3%	6%	21%	5%	9%	12%	13%		
Costs savings per kg H ₂	Absolute	[EUR/kg _{H2}]	0.31	0.56	0.67	0.75	0.85	0.29	0.50	0.59	0.68	0.75		
	Relative to base scenario	[%]	51%	68%	69%	79%	90%	76%	65%	77%	95%	99%		

Table B.6: Variation of affected electrolyser capacity in an alternative scenario

B.2 Models

B.2.1 The electricity market model

Values with tilde represent decision variables in the congestion management model. Elements with a bar represent results of the market model that are plugged into the congestion management model as exogenous parameters.		
Symbol	Description	Unit
Variables		
p	Endogenous power flow (e.g., power generation)	[MW]
p^{ch}	Storage charging power	[MW]
p^{dis}	Storage discharging power	[MW]
l	Storage level	[MWh]
p^{h2}	Sourced electrolyser power	[MW]
p^{up}	Upward redispatch	[MW]
p^{down}	Downward redispatch / curtailment	[MW]
p^{AC}	Power flow in AC line	[MW]
p^{HVDC}	Power flow in HVDC line	[MW]
Parameter (exogenous)		
C^{mc}	Cost: Marginal cost	[EUR/MWh]
C^{co2}	Cost: CO2	[EUR/tCO ₂]
C^{fuel}	Cost: Fuel	[EUR/MWh _{raw}]
C^{vom}	Cost: Variable operation and maintenance	[EUR/MWh]
p^{exp}	Export power flow	[MW]
p^{imp}	Import power flow	[MW]
p^{load}	Electrical load	[MW]
p^{h2}	Sourced electrolyser power (exogenous / from market model)	[MW]
p^{dis}	Storage discharging (exogenous / from market model)	[MW]
p^{ch}	Storage charging (exogenous / from market model)	[MW]
V^{cap}	Capacity	[MW]
V^{cf}	Capacity factor renewables	[%/100]
V^{avail}	Capacity factor	[%]
V^{sec}	Security factor to account for N-1 contingency	[%]
V^{em}	Fuel emissions	[tCO ₂ /MWh _{raw}]
V^{inflow}	Water inflow in reservoirs of dams	[MW]
E^{cap}	Electrolyser capacity	[MW]
E^{uf}	Electrolyser utilisation factor	[%]
η	Efficiency	[%]
L^{vol}	Hydro reservoir	[MWh]
V^{mp}	Market price (resulting from Market Model)	[EUR/MWh]
$V^{cap,HVDC} / V^{cap,AC}$	Line capacity HVDC / AC	[MW]
B	Susceptance matrix (power flow calculation as DC representation)	[#]
H	Network transfer matrix (power flow calculation as DC representation)	[#]
I	Incidence matrix (power flow calculation as DC representation)	[#]
θ	Voltage angle difference to 0	[#]
Lower indices		
l	Line	
t	Timestep	
n / nn	Grid node	
g	Generation unit	
s	Storage unit	
m / mm	Market zone	
f	Fuel type	
Sets		
$T_{0,168}$	First and last hour of every week	
T_{1-168}	All hours of every week except the first one	
T	Hours of the year	
M	Electricity markets	
N	Nodes in network	
N_{slack}	Slack bus (Node)	
S	Storage units	
G	Generation units	
R	Renewable generators	
F	Fuel type (e.g., Natural gas, solar PV, nuclear)	
L_{AC} / L_{HVDC}	Lines AC / HVDC	

Table B.7: Nomenclature of electricity market and congestion management model

The objective function minimises the costs of the overall electricity supply for the considered temporal scope.

$$\min_{p_{n,g,t}, p_{n,s,t}^{ch}, p_{n,s,t}^{dis}} \sum_n^N \sum_g^G \sum_t^T p_{n,g,t} \cdot C_{n,g}^{mc} + \sum_n^N \sum_s^S \sum_t^T (p_{n,s,t}^{ch} + p_{n,s,t}^{dis}) \cdot C_{n,s}^{mc} \quad (\text{B.1})$$

Where the marginal costs for both generation and storage units are calculated by (B.2) and (B.3), respectively

$$C_{n,g}^{mc} = \frac{1}{\eta_{n,g}} \cdot (C_f^{fuel} + C^{CO2} \cdot V_f^{em}) + C_g^{vom} \quad \forall g \in f \quad (\text{B.2})$$

$$C_{n,s}^{mc} = \frac{1}{\eta_{n,s}} \cdot (C_f^{fuel} + C^{CO2} \cdot V_f^{em}) + C_s^{vom} \quad \forall s \in f \quad (\text{B.3})$$

The function is subject to several constraints. Expression (B.4) represents the balance of all power generation and all electrical demand at every timestep and every market zone.

$$\sum_n^m (P_{n,t}^{load} + p_{n,s,t}^{ch} + p_{n,t}^{h2}) + \sum_{mm} p_{m,mm,t} + P_{m,t}^{exp} = \sum_n^m (p_{n,g,t} + p_{n,s,t}^{dis}) + \sum_{mm} p_{mm,m,t} + P_{m,t}^{imp} \quad \forall m \in M, \forall t \in T \quad (\text{B.4})$$

The power production of renewable energy technologies is set by their installed capacity and the corresponding capacity factor as expressed by (B.5)

$$p_{n,g,t} = V_{n,g}^{cap} \cdot V_{n,g}^{cf} \quad \forall g \in R, \forall t \in T \quad (\text{B.5})$$

(B.6) and (B.7) limit the decision variables of both the power generation and the power exchange with neighboring countries to their available capacities.

$$0 \leq p_{n,g,t} \leq V_{n,g}^{cap} \cdot V_{n,t}^{avail} \quad \forall n \in N, \forall g \in C, \forall t \in T \quad (\text{B.6})$$

$$p_{m,mm,t} \leq V_{m,mm}^{cap} \cdot V_{m,mm,t}^{avail} \quad \forall m \wedge mm \in M, \forall t \in T \quad (\text{B.7})$$

Pumped hydro storage are represented by expressions (B.8) to (B.10). Where (B.8) define the storage level of all hydro storage facilities at the beginning as well as at the end of each week and (B.9) the intermediate storage level within weeks. The corresponding decision variables of the hydro storage representation are limited by the given maximum capacities (B.10).

$$l_{n,s,t} = L_{n,s}^{cap} \cdot 0.5 \quad \forall n \in N, \forall s \in S, \forall t \in T_{0,168} \quad (\text{B.8})$$

$$l_{n,s,t} = l_{n,s,t-1} + p_{n,s,t}^{ch} \cdot \eta_{n,s} - \frac{p_{n,s,t}^{dis}}{\eta_{n,s}} \quad \forall n \in N, \forall s \in S, \forall t \in T_{1-168} \quad (\text{B.9})$$

$$0 \leq l_{n,s,t} \leq L_{n,s}^{cap}, \quad 0 \leq p_{n,s,t}^{dis} \leq V_{n,s}^{cap}, \quad 0 \leq p_{n,s,t}^{ch} \leq V_{n,s}^{cap} \quad \forall n \in N, \forall s \in S, \forall t \in T \quad (\text{B.10})$$

Beside the integration of pumped hydro storage facilities in the model, hydro reservoirs that only allow the production of electricity by releasing water from the reservoirs are also considered in the modelling. Often this technology is referred to as ‘Dams’. Expression (B.11) represents the weekly balance of energy inflows and outflows.

$$\sum_t^{T_{168}} p_{n,g,t} = \sum_t^{T_{168}} V_{n,g,t}^{inflow} \quad \forall n \in N, \forall g \in D \quad (\text{B.11})$$

Electrolysers and the corresponding production of hydrogen are included in the model by expression (B.12) and (B.13). Equation (B.12) translates the annual hydrogen demand that is set by the electrolyser capacity, its efficiency and a predefined annual utilisation factor into hourly variables that represent the sourcing of electricity from the grid. These variables are further limited to the available electrolyser capacity as expressed by (B.13).

$$\sum_t^T \sum_n^m p_{n,t}^{h2} = \sum_t^T \sum_n^m E_n^{cap} \cdot E^{uf} \cdot \eta^{h2} \quad \forall m \in M \quad (\text{B.12})$$

$$p_{n,t}^{h2} \leq E_n^{cap} \quad \forall n \in N, \forall t \in T \quad (\text{B.13})$$

B.2.2 The congestion management model

The objective function is represented by expression (B.14).

$$\min_{\tilde{p}_{n,g,t}^{up}, \tilde{p}_{n,g,t}^{down}} \sum_n^N \sum_g^G \sum_t^T \tilde{p}_{n,g,t}^{up} \cdot C_{n,g}^{mc} + \tilde{p}_{n,g,t}^{down} \cdot (V_{m,t}^{mp} - C_{n,g}^{mc}) \quad (\text{B.14})$$

It is subject to various constraints as per B.15, which represents the balance of all injected and extracted electricity at both every hourly time step and every node in the network. Within this equation, the electrolysers are distributed to the corresponding network nodes depending on the analysed placement option.

$$\begin{aligned} P_{n,t}^{load} + \sum_s^S P_{n,s,t}^{ch} + P_{n,t}^{h2} + P_{n,t}^{exp} = \\ \sum_g^G (P_{n,g,t} + \tilde{p}_{n,g,t}^{up} - \tilde{p}_{n,g,t}^{down}) + \sum_s^S P_{n,s,t}^{dis} + P_{n,t}^{imp} + \tilde{p}_{n,t}^{AC} + \tilde{p}_{n,t}^{HVDC} \end{aligned} \quad (\text{B.15})$$

$$\forall n \in N, \forall t \in T$$

Whereas power flows in AC systems follow the physics of Kirchhoff’s law, power flows through high voltage direct current lines (HVDC) are controllable, which results from the rectification and reconversion steps at the links between AC and HVDC systems. As the transmission system within

the geographical scope of this study consists of AC as well as HVDC transmission lines, both elements are included in the modelling. The corresponding HVDC flows are calculated by (B.19).

$$\tilde{p}_{n,t}^{HVDC} = \sum_l^{L_{HVDC}} I_{l,n} \cdot \tilde{p}_{l,t}^{HVDC} \quad \forall n \in N, \forall t \in T \quad (\text{B.16})$$

AC systems are represented by (B.17) to (B.20). The approach is based on Egerer (2016) and Schönheit et al. (2020).

$$\tilde{p}_{n,t}^{AC} = \sum_{nn}^N B_{n,nn} \cdot \theta_{nn,t} \quad \forall n \in N, \forall t \in T \quad (\text{B.17})$$

$$\tilde{p}_{l,t}^{AC} = \sum_n^N H_{l,n} \cdot \theta_{n,t} \quad \forall l \in L_{AC}, \forall t \in T \quad (\text{B.18})$$

$$\theta_{n,t} = 0 \quad \forall n \in N_{slack}, \forall t \in T \quad (\text{B.19})$$

Furthermore, the power flows through the individual power lines are limited by their thermal capacities considered by (B.20) and (B.21). The security parameter V^{sec} that accounts for N-1 contingency is 25% (Xiong et al. 2021) in this analysis.

$$|\tilde{p}_{l,t}^{AC}| \leq V_l^{cap,AC} \cdot (1 - V^{sec}) \quad \forall l \in L_{AC}, \forall t \in T \quad (\text{B.20})$$

$$|\tilde{p}_{l,t}^{HVDC}| \leq V_l^{cap,HVDC} \cdot (1 - V^{sec}) \quad \forall l \in L_{HVDC}, \forall t \in T \quad (\text{B.21})$$

Upwards and downwards dispatch measures over the considered geographical scope need to be balanced:

$$\sum_n^N \sum_g^G (\tilde{p}_{n,g,t}^{up} - \tilde{p}_{n,g,t}^{down}) = 0 \quad \forall t \in T \quad (\text{B.22})$$

Both the downward and upward regulation of generating units is restricted through the available capacity of the units as represented by (B.23) and (B.24).

$$P_{n,g,t} + \tilde{p}_{n,g,t}^{up} \leq V_{n,g}^{cap} \cdot V_{n,t}^{avail} \quad \forall n \in N, \forall g \in C, \forall t \in T \quad (\text{B.23})$$

$$0 \leq P_{n,g,t} - \tilde{p}_{n,g,t}^{down} \quad \forall n \in N, \forall g \in G, \forall t \in T \quad (\text{B.24})$$

B.2.3 The hydrogen supply chain model

Symbol	Description	Unit
	Variables	
s	Hydrogen volumes carried by supply chain	[kg]
c^{trans}	Total transport cost	[EUR]

c^{conv}	Total conversion and reconversion cost	[EUR]
Parameter (exogenous)		
C^{prod}	Total production cost	[EUR]
C^{fix}	Fixed cost component / volume independent	[EUR/kg]
P^{h2}	Sourced electrolyser power (from market model)	[MW]
C^{amp}	Annual averaged electricity price (from market model)	[EUR/MWh]
V^{ele}	Electricity demand in conversion / reconversion step	[kWh/kg]
V^{dist}	Distance between production and consumption node	[km]
E^{cap}	PtH2 capacity	[MW]
E^{uf}	PtH2 utilisation factor	[%/100]
Lower indices		
t	Timestep	
n	Production location	
M	Demand location	
U	Hydrogen vector at production side	
V	Hydrogen vector of transport	
W	Hydrogen vector at demand location	
Sets		
T	Hours of the year	
N	Production locations	
M	Demand locations	
U	Hydrogen vector at production side (GH2)	
V	Hydrogen vector of transport (e.g., NH3, LH2, GH2)	
W	Hydrogen vector at demand location (NH3 or GH2)	

Table B.8: Nomenclature of hydrogen supply chain model

The objective function minimises overall supply costs that consists of three parts: (i) the hydrogen production costs, (ii) the costs for the conversion as well as potentially reconversion of hydrogen and, (iii) the transport costs.

$$\min_{P_n, S_{n,r,m}} C^{prod} + c^{trans} + c^{conv} \quad (\text{B.25})$$

The production costs of hydrogen are represented by equation (B.26). They are further composed of two components: a first component that accounts for the annualised investment costs as well as for fixed annual operating costs and a second part that considers costs related to the sourcing of grid electricity. The latter part result from the outcome of the electricity market model runs.

$$C^{prod} = \sum_n^N E_n^{cap} \cdot \left(C^{fix} + \sum_t^T P_{n,t}^{h2} \cdot V_t^{mp} \right) \quad (\text{B.26})$$

The costs for the conversion and reconversion processes are given by (B.27). Both cost elements consist of a fixed part that account for the capital investment as well as for fixed operational and maintenance costs and a variable cost element. The variable part considers a potential electricity demand that is required in the process. It is multiplied by the annual average electricity price in Germany that results from the respective market model runs.

$$c^{conv} = \sum_u^U \sum_n^N \sum_v^V \sum_m^M \sum_w^W C_{u,v}^{fix} + C^{amp} \cdot V_{u,v}^{ele} \cdot s_{u,n,v,m,w} + C_{v,w}^{fix} + C^{amp} \cdot V_{v,w}^{ele} \cdot s_{u,n,v,m,w} \quad (\text{B.27})$$

Where $S_{u,n,v,m,w}$ is the decision variable that carries information on the transported volumes through the individual supply routes. Like the expression of the conversion and reconversion costs, the costs

for the transport of hydrogen are also split into a fixed element and a variable cost component that is dependant on the transport distance between production node and destination node.

$$c^{trans} = \sum_u^U \sum_n^N \sum_v^V \sum_m^M \sum_w^W C_w^{fix} + C_w^{var} \cdot V_{n,m}^{dist} \cdot s_{u,n,v,m,w} \quad (\text{B.28})$$

The minimisation problem is subject to two constraints. Whereas (B.29) represents the balance of hydrogen volumes at the production nodes, (B.30) does the same for the destination nodes. At every production node the sum of all outgoing supply chains must be equal to the produced hydrogen volumes at the respective node. The produced hydrogen volumes result from the assignment of electrolyser capacity as described above. The same principle holds for the destination nodes where the sum of all incoming supply chain volumes needs to be equal to the demand of hydrogen and its derivatives.

$$E_n^{cap} \cdot E^{uf} \cdot 8760 \cdot \frac{1}{V_y^{lhv}} = \sum_v^V \sum_m^M \sum_w^W s_{y,n,v,m,w} \quad \forall n \in N, \forall y \in Y \quad (\text{B.29})$$

$$V_{m,w}^{dem} = \sum_u^U \sum_n^N \sum_v^V s_{u,n,v,m,w} \quad \forall m \in M, \forall w \in W \quad (\text{B.30})$$

B.2.4 Optimal electrolyser placement

Step III (Figure 3.1) of our approach aims at assigning the available electrolyser capacity optimally to the individual network nodes so that most curtailments can be avoided. To do so a small linear optimisation problem is set up.

Symbol	Description	Unit
Variables		
p^{h2}	Sourced electrolyser power	[MW]
p^{loss}	Unused curtailments	[MW]
e^{cap}	Electrolyser capacity (at nodal level)	[MW]
Parameter (exogenous)		
$p^{curtailment}$	Curtailed electricity (from congestion model)	[MW]
E^{uf}	electrolyser utilisation factor	[%/100]
E^{cap}	Overall available electrolyser capacity	[%/100]
Lower indicies		
n / nn	Grid node	
t	Timestep	
Sets		
N	Nodes in network	
T	Hours of the year	

Table B.9: Nomenclature of optimal electrolyser placement

The objective function is to reduce curtailments (B.31)

$$\min_{e_n^{cap}} \sum_t^T \sum_n^N p_{n,t}^{loss} \quad (\text{B.31})$$

The optimisation problem is subject to several constraints such as ((B.32)), that ensures that the assigned electrolysers are equal to the overall available electrolyser capacity.

$$E^{cap} = \sum_n^N e_n^{cap} \quad (\text{B.32})$$

(B.33) represents the hourly balance at the nodes.

$$P_{n,t}^{curtailment} = p_{n,t}^{h2} + p_{n,t}^{loss} \quad \forall n \in N, \forall t \in T \quad (\text{B.33})$$

Expressions (B.34) and (B.35) limit the power injection at the electrolyser system

$$p_{n,t}^{h2} \leq e_n^{cap} \quad \forall n \in N, \forall t \in T \quad (\text{B.34})$$

$$\sum_t^T p_{n,t}^{h2} \leq e_n^{cap} \cdot E^{uf} \quad \forall n \in N \quad (\text{B.35})$$

B.2.5 Optimal electrolyser operation

Step IV (Figure 3.1) of our analysis represents the part, where the intervention of TSOs in the operation of the electrolysers is determined. The idea is to operate exogenously assigned capacities at the individual grid nodes in a way that the amount of projected curtailments is reduced. A small optimisation problem is set up that is similar to Section B.4 except for the exogenously defined electrolyser capacities.

Symbol	Description	Unit
Variables		
p^{h2}	Sourced electrolyser power	[MW]
p^{loss}	Unused curtailments	[MW]
Parameter (exogenous)		
$P^{curtailment}$	Curtailed electricity (from congestion model)	[MW]
E^{uf}	Electrolyser utilisation factor	[%/100]
E^{cap}	Electrolyser capacity (at nodal level)	[%/100]
Lower indices		
n / nn	Grid node	
t	Timestep	
Sets		
N	Nodes in network	
T	Hours of the year	

Table B.10: Nomenclature of optimisation for electrolyser operation

The optimisation problem is defined by (B.36) to (B.39):

$$\min_{p_{n,t}^{h2}} \sum_t^T \sum_n^N p_{n,t}^{loss} \quad (\text{B.36})$$

$$P_{n,t}^{curtailment} = p_{n,t}^{h2} + p_{n,t}^{loss} \quad \forall n \in N, \forall t \in T \quad (\text{B.37})$$

$$p_{n,t}^{h2} \leq E_n^{cap} \quad \forall n \in N, \forall t \in T \quad (\text{B.38})$$

$$\sum_t^T p_{n,t}^{h2} \leq E_n^{cap} \cdot E^{uf} \quad \forall n \in N \quad (\text{B.39})$$

B.3 Data

B.3.1 Data on the electricity system

The data on the considered electricity system are composed of three types, namely (1) data on the transmission system, (2) demand data and (3) data on the electricity generation. The year 2019 is used as the reference year for deriving the hourly time series.

B.3.1.1 Data on the transmission system

The dataset provided by the PyPSA¹ project in January 2020 builds the basis of the grid data used in the study. Within PyPSA, project grid infrastructure information is digitalised from the grid map published by ENTSO-E². The provided dataset consists among others of network node locations as well as corresponding power lines. As the digitalisation of the map results in geographical differences between the actual position of the network nodes and the ones extracted from the map, the provided coordinates of the network nodes are corrected by more accurate geographical information. Data from Egerer (2016), Kunz et al. (2017), and Weinhold and Mieth (2020)) are used for this step. The provided grid topology corresponds to the network configuration in early 2020. Therefore, grid expansion plans for both the national German system³ and cross-border links among considered neighboring countries⁴ are used to project the evolvement of the grid to 2030. However, to consider the observed delay of grid expansion measures, it is assumed that all grid projects listed in the national grid development plan are delayed by three years⁵. Furthermore, as the power flows in AC transmission systems follow the physics of the network topology according to Kirchhoff's law, the corresponding technical parameters that are required to perform a DC power flow representation are assigned to the individual lines. Table B.11 presented the considered line parameters.

¹ <https://github.com/PyPSA/GridKit>

² <https://www.entsoe.eu/data/map/>

³ (BNetzA 2019) and (BNetzA 2020c)

⁴ (ENTSOE 2022a)

⁵ Three years seem reasonable considering also new laws that are aiming at accelerating administrative processes. A sensitivity analysis of this aspect is conducted within the study.

Voltage [kV]	Resistance [Ohm/km]	Reactance [Ohm/km]
132	0.0949	0.3800
220	0.0600	0.3010
300	0.0400	0.2650
380	0.0300	0.2460
500	0.0200	0.2220
750	0.0100	0.2020

(a) AC lines

Voltage [kV]	Resistance [Ohm/km]	Reactance [Ohm/km]
132	0.0477	0.1298
220	0.0344	0.1261
380	0.0312	0.1281

(b) AC cables

Based on Weinhold and Mieth (2020) and https://pomato.readthedocs.io/en/latest/line_parameters.html

As HVDC lines are active network elements, they do not require parameters for the linear power flow calculation.

Table B.11: Power line parameters

Distances among the grid nodes are determined using GIS measurements based on their geographical coordinates. Some key figures of the resulting considered power system in 2030 are listed in Table B.12. Figure 3.3b visualises the corresponding grid topology.

Nodes	Within DE	Within neighbouring countries
Substation	375	12
Ancillary node	114	0

(a) Network nodes

Power lines	Within DE	Between DE and neighbouring countries	Between neighbouring countries
HVDC	5	4	15
132	-	1	7
220	352	15	16
380	983	49	34

(b) Power lines

Table B.12: Key figures of resulting power system

Whereas the introduction of the grid topology above describes the physical network used for the congestion management model, the actual tradable capacity between the individual zones might differ from the physical one. Trade between market zones is assumed to be constraint by the corresponding net transfer capacities or in short NTC. Respective NTC values are taken from the national trend scenario⁶ from ENTSOE (2020)⁷ and adjusted to hourly availabilities based on historical data for the reference year. These data are used in the electricity market model. Furthermore, exchanges of electricity between considered countries with countries that are out of the modelled scope are set exogenously to the historical hourly power flows reported for the reference year (ENTSOE 2021).

⁶ Climate year 1984

⁷ <https://tyndp.entsoe.eu/maps-data>

B.3.1.2 Data on the electrical demand

Several steps are necessary to obtain disaggregated hourly demand data for the considered geographical scope. The starting point are national annual demand projections for the year 2030 for each of the considered countries. Whereas for all neighboring countries the data from the National Trend Scenario of ENTSOE (2020) are taken, for Germany the demand projection of the national network development plan 2019 (BNetzA 2018) is used. The corresponding values are shown in Table B.13.

Country	AT	BE	CH	CZ	DE	DK	FR	LU	NL	NO	PL	SE	UK
Electrical demand	87	91	61	78	544	46	484	10	118	148	182	152	317

Table B.13: Annual electricity demand at national level in 2030 [TWh]

In a second step the annual data are distributed over all hours of the year. Historical demand data from ENTSOE (2021) for the reference year serve as allocation formula. Whereas the temporal demand distribution of the neighboring countries is already sufficient due to their single node representation, the German demand is subject to an additional distribution process, that allocates the hourly demand to the individual network nodes. The approach presented in Kunz et al. (2017) serves as the basis for the distribution, which is further refined based on vom Scheidt et al. (2022). GDP projections at county level for 2030⁸ are used first to distribute the hourly national demand over the 401 counties in Germany⁹. As the spatial resolution of counties is not sufficiently enough for a transmission system with 375 network substations, an additional distribution step is applied to reach a higher spatial granularity. The reported number of inhabitants at postcode level¹⁰ enables the calculation of the share of inhabitants per county. This is then used as demand proxy to further distribute the hourly county demand to the postcode level. Each postcode is then assigned to the nearest substation in the transmission grid based on GIS¹¹ calculations¹². The resulting spatial distribution at an annual level for Germany is illustrated in Figure 3.3a.

B.3.1.3 Data on power generation and storage systems

Installed generation capacity

Data on the installed capacity for in the German power system are taken from the national grid expansion plan. However, additional power plant databases such as presented in BNetzA (2020b), Egerer (2016) and Kunz et al. (2017) are used to complete missing information and to assign corresponding technical details to the initial list of power plants. All plants with fuel types that are not listed in the scenario database as well as small scale natural gas generation units (<10MW) are treated separately. The national register of generation units 2019 is used to derive the share of the

⁸ (Ifo 2012)

⁹ The number of counties with projected GDP data given data source is less than what is reported for the year 2018. Consequently, missing counties are added to the 2030 data based on their share of GDP of the projected counties in the list. (Offices 2020)

¹⁰ (Office 2020)

¹¹ Geographic Information System

¹² Distances between postcode centroids and network nodes

total installed capacity per postcode and respective fuel type in 2019. The resulting shares serve to distribute the reported capacity projections at country level to the postcode level. The locational information of all units (postcode or geo-coordinates) is used in a subsequent step to assign the capacities to the nearest substation in the transmission system. The capacities of offshore wind turbines are treated and assigned to the respective network nodes according to the reported grid expansion plans of the two TSOs in the North of Germany that are responsible to connect the offshore wind parks to the grid. The resulting distributed installed generation capacity is illustrated in Figure 3.3c.

Similar to the electrical demand, the scenario data of the national trend scenario from the Entsoe TYNDP 2020¹³ also serves as data source for the projected installed capacity in the neighboring countries. The considered capacities of every neighboring country is shown in Table B.14.

Fuel type	AT	BE	CH	CZ	DE	DK	FR	LU	NL	NO	PL	SE	UK
Nuclear	0	0	1.2	4	0	0	58.2	0	0.5	0	0	5.9	9.3
Lignite	0	0	0	5	9.1	0	0	0	0	0	7.4	0	0
Hard coal	0	0.5	0	0.4	9.8	0.8	0	0	3.4	0	15.3	0	4
Oil	0.2	0.2	0	0	0.8	0.4	0.2	0	0	0	0	0	0.6
Natural gas	3.4	8.7	0	1.3	37.6	1	7.4	0	9.3	0	5	0.4	38.7
Biomass	0.6	0.2	1.2	1.1	6.7	0.7	2.6	0.1	0.5	0.1	1.4	8.4	9.8
Wind offshore	0	4.3	0	0	17	4.8	4.9	0	11.3	0	3.6	0	25.1
Wind onshore	9	4.3	0.3	1	81.5	5	36.1	0.4	7.8	7.2	7.2	33.9	35
Solar PV	12	10.5	5.5	4.9	91.3	2.3	39	0.6	25	0.8	8.2	8	34.2
Run of river	6.1	0.1	4.1	0.4	4	0	13.6	0	0	0	0.5	0	2
Pumped storage	5.7	1.4	4	1.2	7.6	0	3.5	1.3	0	36.1	1.5	0	4
Dam	2.4	0	8.2	0.7	1.3	0	8.4	0	0	28.2	0.2	16.6	0
Other	1	1.3	0.9	1.2	2.6	0.2	1.9	0	3.8	0.3	6.8	0	0

Table B.14: Installed capacity at national level [GW]

Corresponding power plant efficiencies are also taken from the scenario data of ENTSOE (2020) and assigned accordingly to the technology vintage classes that are categorised in the data. Missing values are completed by information obtained from the German fleet (BNetzA 2020b; Egerer 2016; Agency 2020; Kunz et al. 2017). The variable operating costs of the individual technologies as well as the corresponding CO₂ emission per fuel type are shown in Table B.15 and Table B.16, respectively.

Biomass	Hard coal	Lignite	Natural gas	Nuclear	Oil	Other	Other RES	Peat	Waste
0	0.34	0.397	0.2	0	0.28	0.39	0	0.38	0.39

Based on: https://www.volker-quaschnig.de/datserv/C02-spez/index_e.phpv

Table B.15: CO₂ emission factor by fuel [t_{CO_2}/MWh_{raw}]

¹³ Tennet offshore projects (<https://www.tennet.eu/index.php?id=2130&L=2>) and (BNetzA 2019)

Biomass	Hard coal	Lignite	Generic	Natural gas	CCGT	Nuclear	Oil
3.7	3.6	4	2.1		1.9	7.8	2.8

Values based on `modelling_eu_2021`

Table B.16: Variable operating costs by technology and fuel [EUR/MWh]

Plant availabilities

Due to planned maintenance or unplanned outages power plants might not be available at their full capacity throughout the year, which affects their dispatch possibilities. Therefore, availability profiles derived for every fuel technology and every country are applied. The derived profiles are based on reported planned and unplanned outages for the reference year based on ENTSOE (2021). Determined hourly data are then averaged to weekly availability profiles.

Capacity factors

Capacity factors of solar PV plants, onshore and offshore wind turbines as well as for run of river facilities are based on the historical hourly generation profiles of the individual technologies in the considered countries. These profiles, that are given in absolute terms, are divided by the reported installed capacities at national level for the reference year to determine the capacity factors. Relevant data are taken from ENTSOE (ibid.). However, as there are significant differences in the availability of solar and wind resources within Germany, more granular capacity factors are required. Therefore, data at NUTS2 level provided by Renewable.ninja¹⁴ are used for both onshore wind and solar PV technologies. Offshore wind capacity factors for Germany are derived from the reported data on ENTSOE (ibid.) at control level. Whereas the data reported by the TSO Tennet represent the capacity factors in the German North Sea, data listed by the TSO 50Hertz correspond to the capacity factors in the German Baltic Sea.

Water inflow of hydro reservoirs

Hydro power plants with a water reservoir that are referred to as dams have natural water inflows to their reservoirs. These are dammed up and generate electricity when released. Historical generation data at national level are taken for 2019 from ENTSOE (ibid.) to derive weekly water inflows into their reservoirs. Moreover, for Germany, the water inflows are distributed to the individual location of dams according to their share on the total installed national dam capacity.

Fuel and CO₂ prices

The operation of power plants is considered to be dependent on fuel prices and prices for CO₂ emission allowances. The corresponding figures are shown in Table B.15.

¹⁴ <https://www.renewables.ninja/>; (Pfenninger and Staffell 2016)

Natural gas	Hard coal	Lignite	Nuclear	Biomass	Oil	Waste	Other	CO ₂
25.7 (24.6)	16.0 (6.3)	4.1 (6.5)	1.7 (1.7)	75 (75)	65.0 (32.3)	0 (0)	35.7 (21.0)	30 (110.9)

Based on ENTSOE (2020) and ENTSOE (2022b); Values in brackets represent prices for alternative scenario - based on IEA (2022c) and ENTSOE (2022b)

Table B.17: Fuel prices [EUR/MWh_{raw}] and CO₂ prices [EUR/tCO₂]

B.3.2 Data on hydrogen

B.3.2.1 Assumptions on hydrogen production

Electrolysers are assumed to have an efficiency of 68%, investment costs of 544 EUR/kW_e and fixed annual operation and maintenance costs corresponding to 1.5% of the investment costs. All techno-economic data are taken from IEA (2019c) and IEA (2019d).

B.3.2.2 Assumptions on hydrogen conversion processes

The considered conversion costs are presented in Table B.18. All underlying data and assumptions are provided in Table B.19.

Input	Hydrogen form	Output	Fixed [EUR/kgH ₂]	Electricity [kWh _{ele} /kgH ₂]
GH ₂		LH ₂	0.57	6.1
GH ₂		LOHC	0.27	1.5
GH ₂		NH ₃	0.38	3.76
GH ₂		CH ₂	0.03	1.33
LH ₂		GH ₂	0	0
LOHC		GH ₂	0.36	15.1
NH ₃		GH ₂	0.23	11.2
CH ₂		GH ₂	0	0

Table B.18: Resulting hydrogen conversion costs

Parameter	Symbol	Unit	LH ₂		LOHC		NH ₃		CH ₂	
			Conv.	Reconv.	Conv.	Reconv.	Conv.	Reconv.	Conv.	Reconv.
Conversion and reconversion facility										
Capacity	V^{cap}	[MTPA _{H2}]	260	-	235.2	235.2	250 ^{a,b}	255	39.4 ^c	-
Capacity Toluene	$V^{cap,tol}$	[MTPA _{Toluene}]	-	-	4200	4200	-	-	-	-
Capex	$C^{capex,con,total}$	[MioEUR]	1 272	-	209	609	870 ^d	418	7.75	-
Opex	$C^{opex,con,total}$	[%/Capex]	0.04	-	0.04	0.04	0.02	0.04	0.04	-
Cost reduction factor (to 2030)	f	[%/100]	0.9	-	0.9	0.9	0.9	0.9	1	-
Electricity requirement	V^{ele}	[kWh _e /kg _{H2}]	6.1	-	1.5	1.5	3.76	1.5	1.33	-
Heat requirement	V^{heat}					13.6		9.7		
Lifetime	t	[Years]	30	-	30	30	20	30	15	-
Financing costs	i	[%/100]	0.08	-	0.08	0.08	0.08	0.08	0.08	-
Plant availability	$V^{uf,con}$	[%/100]	0.9	-	0.9	0.9	0.95	0.9	0.9	-
Toluene start-up	Tol^{st}	[kt _{Toluene}]	-	-	260	-	-	-	-	-
Toluene annual mark-up	Tol^{mu}	[kt _{Toluene}]	-	-	100	-	-	-	-	-
Toluene cost	C^{tol}	[EUR/kg _{Toluene}]	-	-	0.36	-	-	-	-	-
Capex conversion	$C^{capex,con}$	[EUR/kg _{H2}]	0.43	-	0.11	0.23	0.35	0.15	0.02	-
Opex conversion	$C^{opex,con}$	[EUR/kg _{H2}]	0.2	-	0.19	0.1	0.07	0.07	0.01	-
Elect. demand conversion	$V^{ele,con}$	[kWh/kg _{H2}]	6.1	-	1.5	1.5	3.76	1.5	1.33	-
Ancillary electrode boiler										
Capacity	V^{cap}	[MW _e]	-	-	-	410	-	317	-	-
Capex	$C^{capex,boi,total}$	[EUR/kW _e]	-	-	-	-	-	300	-	-
Lifetime	t _{boi}	[y]	-	-	-	20	-	20	-	-
Annual Opex	$C^{opex,boi,total}$	[%/100]	-	-	-	0.025	-	0.025	-	-
Efficiency	eta _{boi}	[%/100]	-	-	-	0.99	-	0.99	-	-
Utilisation	$V^{uf,boi}$	[%/100]	-	-	-	0.9	-	0.9	-	-
Capex boiler	$C^{capex,boi}$	[EUR/kg _{H2}]	-	-	-	0.053	-	0.038	-	-
Opex boiler	$C^{opex,boi}$	[EUR/kg _{H2}]	-	-	-	0.013	-	0.009	-	-
Electricity demand boiler	$V^{ele,boi}$	[kWh/kg _{H2}]	-	-	-	13.6	-	9.7	-	-
Total										
Total cost	C^{total}	[EUR/kg _{H2}]	0.57	0	0.3	0.4	0.42	0.26	0.03	0
Total electricity demand	$V^{ele,total}$	[kWh/kg _{H2}]	6.1	0	1.5	15.1	3.76	11.2	1.33	0

USD/EUR exchange rate 1.1; H₂ in NH₃ 17 wt% (Kakoulaki et al. 2021); H₂ in LOHC 5.6% (dibenzyltoluene (H0-DBT)/perhydrodibenzyltoluene (H18-DBT)) (Runge et al. 2020)

^a units in [kg_{H2}/y]

^b Based on BNetzA (2018)

^c Based on Ikäheimo et al. (2018)

^d Units in [EUR]

Table B.19: Cost assumptions conversion

Associated calculations:

$$ANF^{dev} = \frac{i^{dev}}{1 - (1 + i^{dev})^{-t^{dev}}} \quad \forall dev \in [con, boi] \quad (\text{B.40})$$

$$C^{capex,dev} = \frac{ANF^{dev} \cdot C^{capex,dev,total} + Tol^{st} \cdot C^{tol}}{V^{cap,dev}} \quad \forall dev \in [con, boi] \quad (\text{B.41})$$

$$C^{opex,dev} = \frac{C^{capex,dev,total} \cdot C^{opex,dev,total} + Tol^{mu} \cdot C^{tol}}{V^{cap,dev}} \quad \forall dev \in [con, boi] \quad (\text{B.42})$$

$$V^{cap} = \frac{V^{heat} \cdot V^{cap}}{\eta^{boi} \cdot V^{uf,boi} \cdot 8760} \quad (\text{B.43})$$

$$C^{total} = C^{capex,con} + C^{opex,con} + C^{capex,boi} + C^{opex,boi} \quad (\text{B.44})$$

$$V^{ele,total} = V^{ele,con} \cdot V^{ele,boi} \quad (\text{B.45})$$

B.3.2.3 Assumptions on hydrogen transport

The considered transport costs are presented in Table B.20. All underlying data and assumptions are provided in Table B.21.

Hydrogen form	Fixed [EUR/kg _{H2}]	Variable [EUR/kg _{H2} /100km]	Emissions [kgCO ₂ /kg _{H2} /100km]	Electricity [kW _e /kg _{H2} /100km]
GH ₂	0	0.02	n.a.	0.07
LH ₂	0.09	0.11	0.04	n.a.
CH ₂	0.25	0.65	0.27	n.a.
LOHC	0.08	0.22	0.05	n.a.
NH ₃	0.05	0.15	0.07	n.a.

Values for the pipeline transport (GH₂) are derived from Guidehouse (2021); Retrofitted pipeline with 36 inch and a utilisation factor of 25%. The corresponding electricity demand for the compression efforts is based on the following information: a pipeline with capacity of 13GW (LHV), requires 190-330MW_e per 1000km at 5000 full load hours.

Table B.20: Considered hydrogen transport costs

Parameter	Symbol	Unit	LH ₂	CH ₂	LOHC	NH ₃
Driver cost ^a	C^{driver}	[EUR/h]			35	
Loading ^b	t^{load}	[h]	3	1.5	1.5	1.5
Unloading	t^{unload}	[h]	3	1.5	1.5	1.5
Speed	S	[km/h]			50	
Fuel price	C^{fuel}	[EUR/l]			2.66	
Fuel consumption	V^{fuel}	[l/km]			0.341	
Toll cost	C^{toll}	[EUR/km]			0.15	
CO ₂ fuel emissions	$V^{CO_2, fuel}$	[kgCO ₂ /l _{Diesel}]			2.64	
Capex truck	$C^{capex, truck}$	[EUR/truck]			168182	
O&M truck	$C^{opex, truck}$	[%/100]			0.12	
Lifetime truck	t^{truck}	[years]			12	
Capex trailer	$C^{capex, trailer}$	[EUR/trailer]	909091	590909	154545	200000
O&M trailer	$C^{opex, trailer}$	[%/100]			0.02	
Lifetime trailer	$t^{trailer}$	[years]			12	
Interest ^c	i	[%/100]			0.08	
Capacity	V^{cap}	[kg _{H2} /trailer]	4300	670	1800	2600
Utilisation	V^{uf}	[%/100]			0.7	
Costs: Distance depend- ing	C^{var}	[EUR/100km]	0.109	0.654	0.219	0.152
Costs: Fixed	C^{fix}	[EUR]	0.09	0.254	0.076	0.053
CO ₂ emission	V^{CO_2}	[kgCO ₂ /kg _{H2} /100km]	0.042	0.269	0.05	0.069

^a Based on vom Scheidt et al. (2022)

^b Based on IEA (2019d)

^c Own assumption

Table B.21: Cost assumptions road transport

Associated calculations:

$$t^{trip}(v^{dist}) = t^{load} + \frac{v^{dist} \cdot 2}{S} + t^{unload} \quad (\text{B.46})$$

$$V_{ol}^{annual} = V^{cap} \cdot \frac{8760 \cdot V^{uf}}{t^{trip}(v^{dist})} \quad (B.47)$$

$$C^{route}(v^{dist}) = \frac{8760 \cdot V^{uf}}{t^{trip}(v^{dist})} \cdot \left(t^{trip}(v^{dist}) + 2v^{dist} \cdot V^{fuel} \cdot C^{fuel} + 2v^{dist} \cdot C^{toll} \right) \quad (B.48)$$

$$C^{vehicle} = \left(ANF^{truck} + C^{opex, truck} \right) \cdot C^{capex, truck} + \left(ANF^{trailer} + C^{opex, trailer} \right) \cdot C^{capex, trailer} \quad (B.49)$$

$$C^{Total}(v^{dist}) = \frac{C^{route}(v^{dist}) + C^{vehicle}}{V_{ol}^{annual}} \quad (B.50)$$

$$V^{co2}(v^{dist}) = \frac{\frac{8760 \cdot V^{uf}}{t^{trip}(v^{dist})} \cdot 2v^{dist} \cdot V^{fuel} \cdot V^{co2, fuel}}{V_{ol}^{annual}} \quad (B.51)$$

B.3.2.4 Evolution of LCOH over operating hours

Figure 18 shows the evolution of the LCOH with respect to the operating hours of electrolyzers (based on base case scenario). It can be seen that between 1900 and 4800 operating hours per year the LCOH remains under 2.9 EUR/kg_{H2} with only minor differences. The operation at 3500 hours, as assumed in the study, seems plausible.

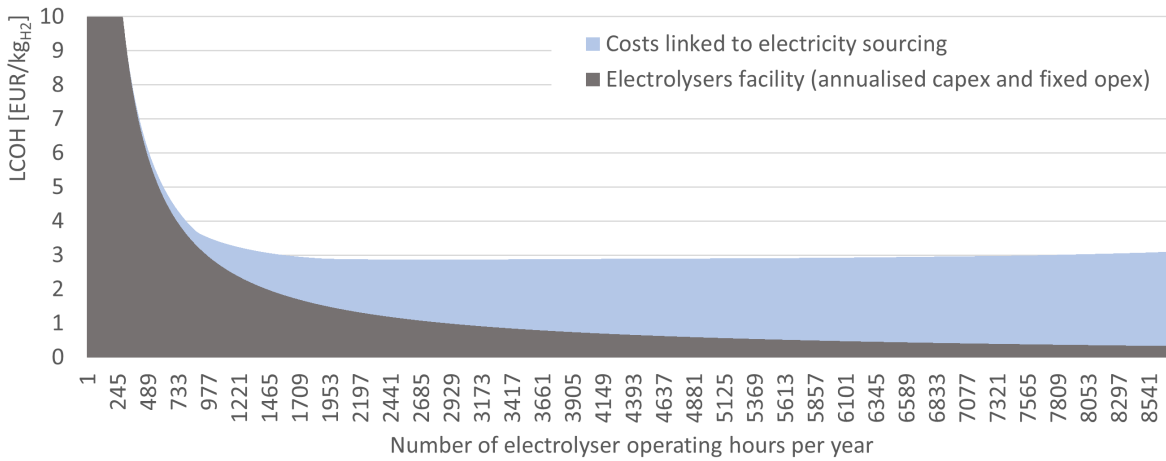

Figure B.3: Evolution of LCOH with respect to the number of operating hours

B.3.2.5 Data on benchmark hydrogen provision: blue and grey hydrogen

Parameter	Symbol	Unit	SMR	SMR+CCUS
Capex	C^{capex}	[EUR/kW _{H2}]	792	1462
Opex	C^{opex}	[%/Capex]	4.70%	3.00%
Emissions	V^{CO2}	[kgCO ₂ /kgH ₂]	8.9	1
Emissions captured	V^{sto}	[kgCO ₂ /kgH ₂]	0	7.9
Plant availability	V^{uf}	[%]		95%
Efficiency	η	[%]	76%	69%
Lifetime	t	[Years]		25
Financing costs	i	[%]		8%
Natural gas price ^a	C^{ng}	[EUR/MWh]		25.7
CO ₂ price ^a	C^{co2}	[EUR/tCO ₂]		30
CO ₂ capture costs ^b	C^{sto}	[EUR/tCO ₂]		30

If not stated differently data are taken from IEA (2019c) and IEA (2019d)

^a See Table B.17

^b Own assumption

Table B.22: Techno-economic assumptions for grey and blue hydrogen

Underlying calculations to determine LCOH of grey and blue hydrogen:

$$LCOH = \frac{C^{h2} + C^{feed} + C^{co2}}{8760 \cdot V^{uf} \cdot \frac{1}{LHV}} \quad (B.52)$$

$$C^{h2} = (1 + C^{opex}) \cdot C^{capex} \cdot \frac{i}{1 - (1 + i)^{-t}} \quad (B.53)$$

$$C^{feed} = 8760 \cdot V^{uf} \cdot \frac{1}{\eta} \cdot C^{ng} \quad (B.54)$$

$$C^{co2} = 8760 \cdot V^{uf} \cdot \frac{1}{LHV} \cdot (V^{co2} \cdot C^{co2} + V^{sto} \cdot C^{sto}) \quad (B.55)$$

Chapter C

Supplementary data for Chapter 4

C.1 Country abbreviations according to the ISO 3166-1 standard

Code	Name	Code	Name	Code	Name
AGO	Angola	GTM	Guatemala	NZL	New Zealand
ALB	Albania	GUY	Guyana	OMN	Oman
ARG	Argentina	HND	Honduras	PAK	Pakistan
AUS	Australia	HTI	Haiti	PAN	Panama
BGD	Bangladesh	IRN	Iran (Islamic Rep. of)	PER	Peru
BLZ	Belize	IRQ	Iraq	QAT	Qatar
BRA	Brazil	ISR	Israel	SAU	Saudi Arabia
CAN	Canada	JOR	Jordan	SDN	Sudan
CHL	Chile	KEN	Kenya	SEN	Senegal
CHN	China	KHM	Cambodia	SLV	El Salvador
CIV	Cote d'Ivoire	LBN	Lebanon	SOM	Somalia
CMR	Cameroon	LBY	Libya	TUN	Tunisia
COL	Colombia	LKA	Sri Lanka	TUR	Turkey
CUB	Cuba	MAR	Morocco	TZA	United Rep. of Tanzania
DZA	Algeria	MDG	Madagascar	UKR	Ukraine
ECU	Ecuador	MEX	Mexico	URY	Uruguay
EGY	Egypt	MNE	Montenegro	USA	United States of America
GBR	United Kingdom	MOZ	Mozambique	VEN	Venezuela (Bolivarian Rep. of)
GEO	Georgia	NAM	Namibia	VNM	Viet Nam
GHA	Ghana	NGA	Nigeria	YEM	Yemen
GIN	Guinea	NIC	Nicaragua	ZAF	South Africa
GMB	Gambia	NOR	Norway		

Table C.1: Country abbreviations according to the ISO 3166-1 standard

C.2 Further results

C.2.1 Result of country exclusion filter

AGO	ALB	ARG	AUS	BGD	BLZ ^a	BRA	CAN
CHL	CHN	CIV	CMR	COL	CUB	ECU	GEO ^a
GHA	GIN	GMB	GTM ^a	GUY	HND	HTI	IRN
IRQ	ISR	JOR	KEN	KHM	LBN	LKA	MAR
MDG	MEX	MNE	MOZ	NAM	NIC	NZL	OMN
PAK	PAN	SAU	SDN	SEN	SLV	SOM	TUN
TUR	TZA	UKR	URY	VEN	VNM	YEM	ZAF

^a Not sufficiently suited for the use of renewable energy technologies to export green hydrogen

Table C.2: Result of prefiltering – potential green hydrogen exporter

DZA	EGY	GBR	LBY	NGA	NOR	PER	QAT	USA
-----	-----	-----	-----	-----	-----	-----	-----	-----

Table C.3: Result of prefiltering – potential green and blue hydrogen exporter

C.2.2 Sensitivity analysis part 1 - Impact of key input parameters in index determination

C.2.2.1 Overview about assessed scenarios

In addition to the base case, various other settings have been analysed to also consider uncertainties in the evolution of techno-economic data that affect the Competitiveness-Index. Moreover, while we consider five criteria in the multi-criteria analysis for the assessment of the Soft-Factor-Index, stakeholders might accept weaknesses in the supplier condition. Within the sensitivity analysis, we

therefore also assess how countries perform when not all five criteria are binding. Table C.4 and Table C.5 show all evaluated cases of both the Competitiveness-Index and the Soft-Factor-Index, respectively. The corresponding results of the sensitivity analysis are presented in Subsection C.2.2.2.

Scenario name	Upstream green	Cell selection	Upstream blue	Midstream	WACC
Base case	Base	Best	Base	Base	Trend
Base case - Green only	Base	Best	No	Base	Trend
Optimistic green	Optimistic	Best	Base	Base	Trend
Pessimistic green	Pessimistic	Best	Base	Base	Trend
Green competition	Base	10th best	Base	Base	Trend
High Green competition	Base	25th best	Base	Base	Trend
Optimistic blue	Base	Best	Optimistic	Base	Trend
Pessimistic blue	Base	Best	Pessimistic	Base	Trend
Optimistic transport	Base	Best	Base	Optimistic	Trend
Pessimistic transport	Base	Best	Base	Pessimistic	Trend
Precrisis WACC	Base	Best	Base	Base	Precrisis
Equal WACC	Base	Best	Base	Base	Equal

Table C.4: Overview about assessed cases – Competitiveness-Index

Scenario name	Evolution of indicator	Selection of criteria
Base case	Trend	All five criteria
Trend4	Trend	Only best four criteria
Trend3	Trend	Only best three criteria
Constant 5	Constant	All five criteria
Constant 4	Constant	Only best four criteria
Constant 3	Constant	Only best three criteria

Table C.5: Overview about assessed cases – Soft-Factor-Index

C.2.2.2 Results of sensitivity analysis - Part1

As part of our assessment, a sensitivity analysis is conducted to assess how countries perform in relation to changes in the parameters in both the supply chain analysis and the multi-criteria analysis. The sensitivity analysis captures all listed cases presented in Table C.4 and Table C.5. The results of every country, each energy carrier and the two target years are illustrated in Figure C.1 to Figure C.5.

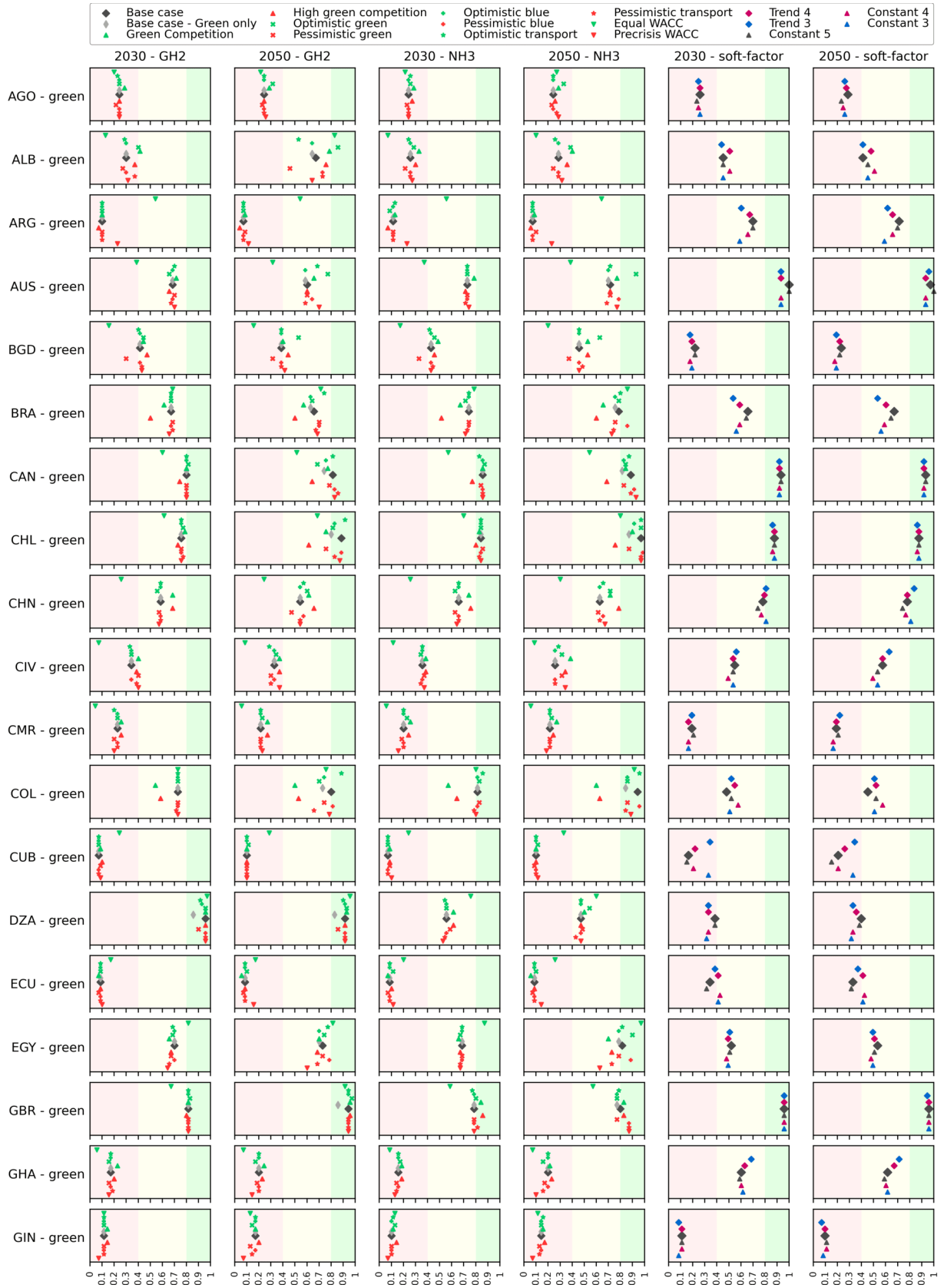

Figure C.1: Sensitivity analysis – green hydrogen - part I

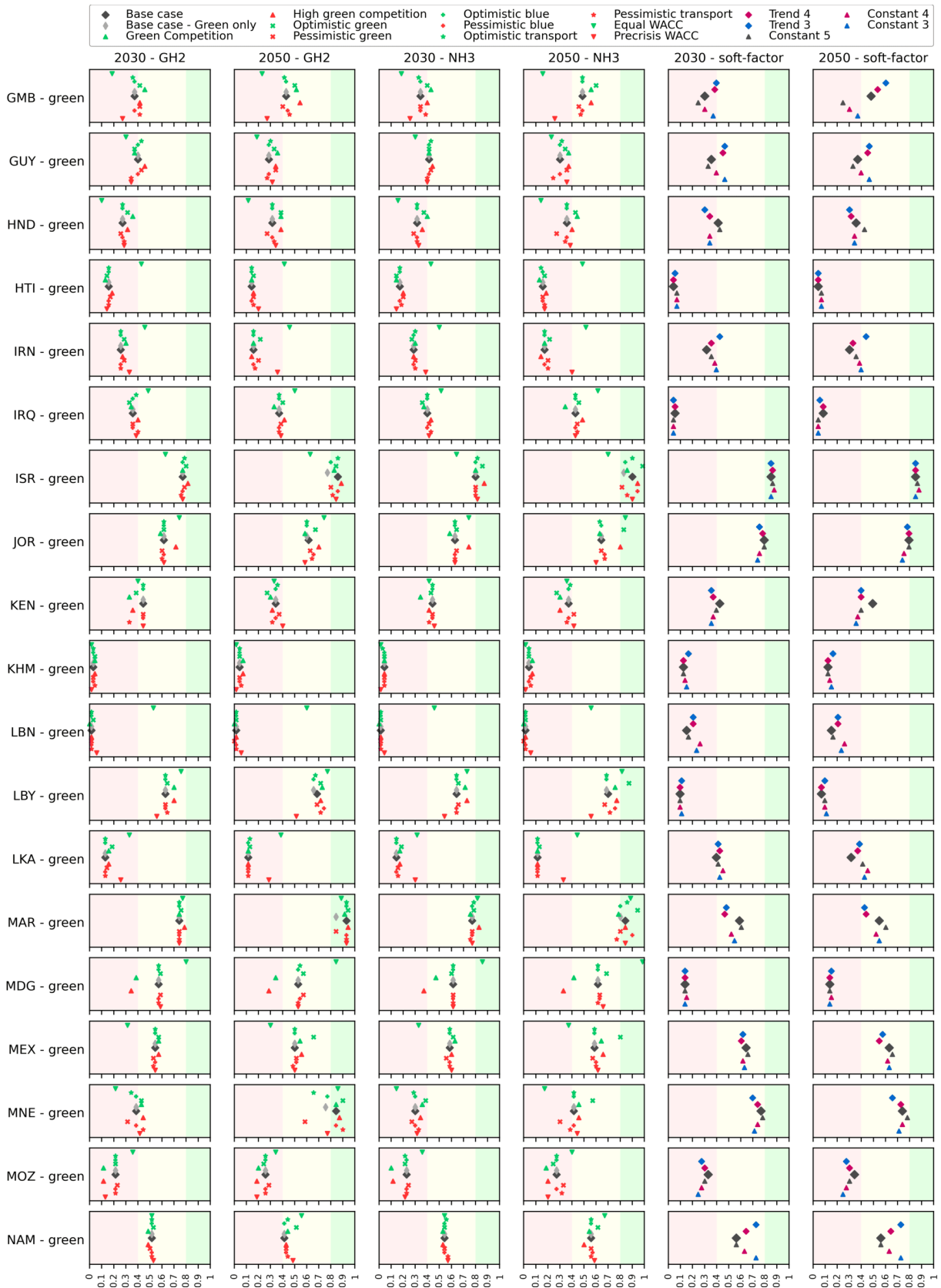

Figure C.2: Sensitivity analysis – green hydrogen - part II

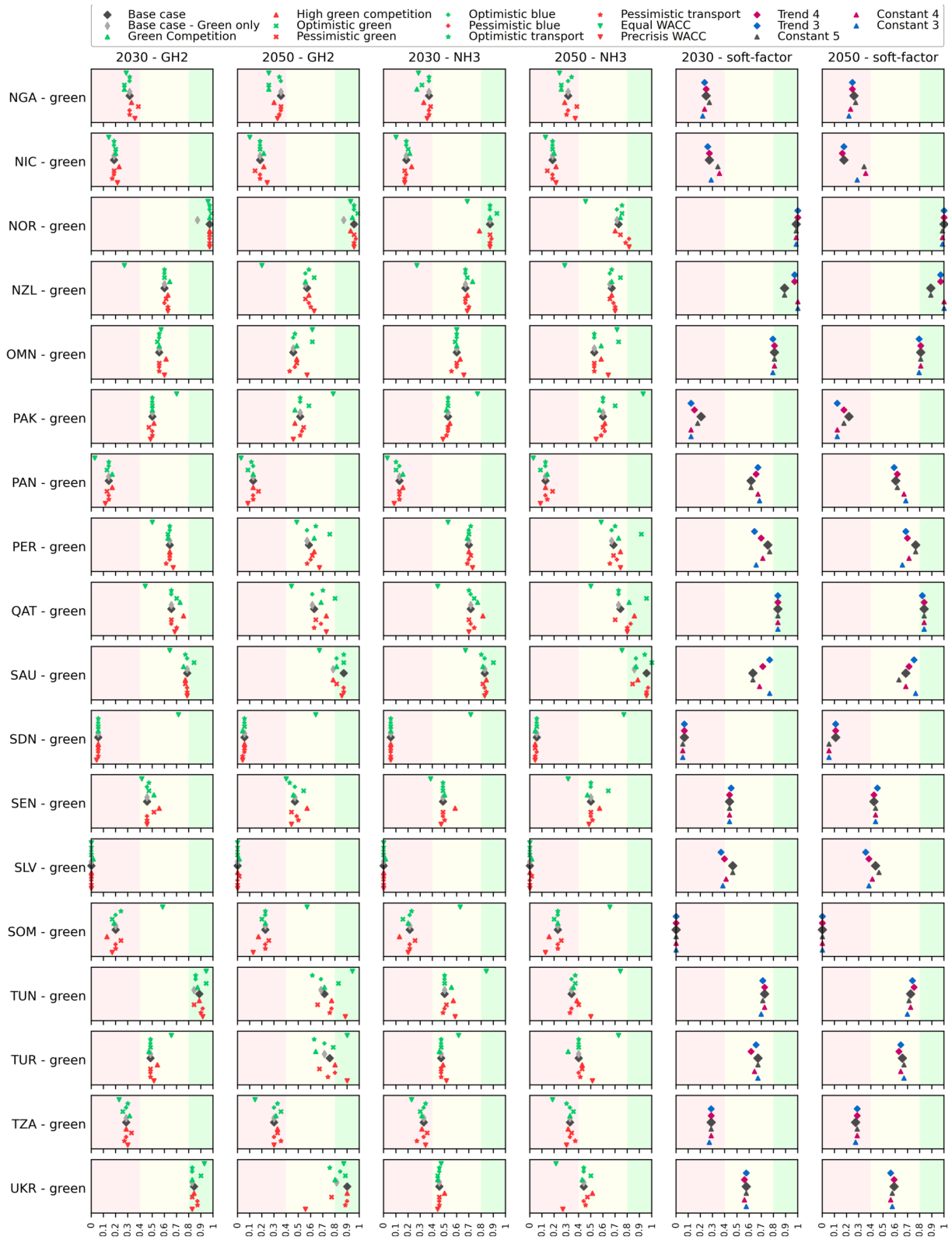

Figure C.3: Sensitivity analysis – green hydrogen - part III

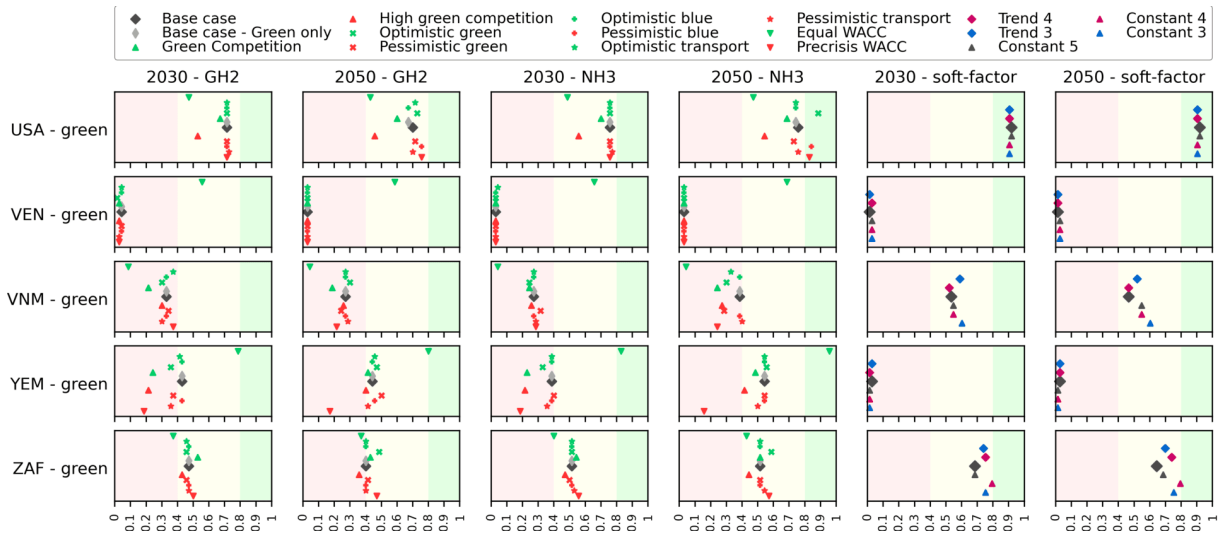

Figure C.4: Sensitivity analysis – green hydrogen - part IV

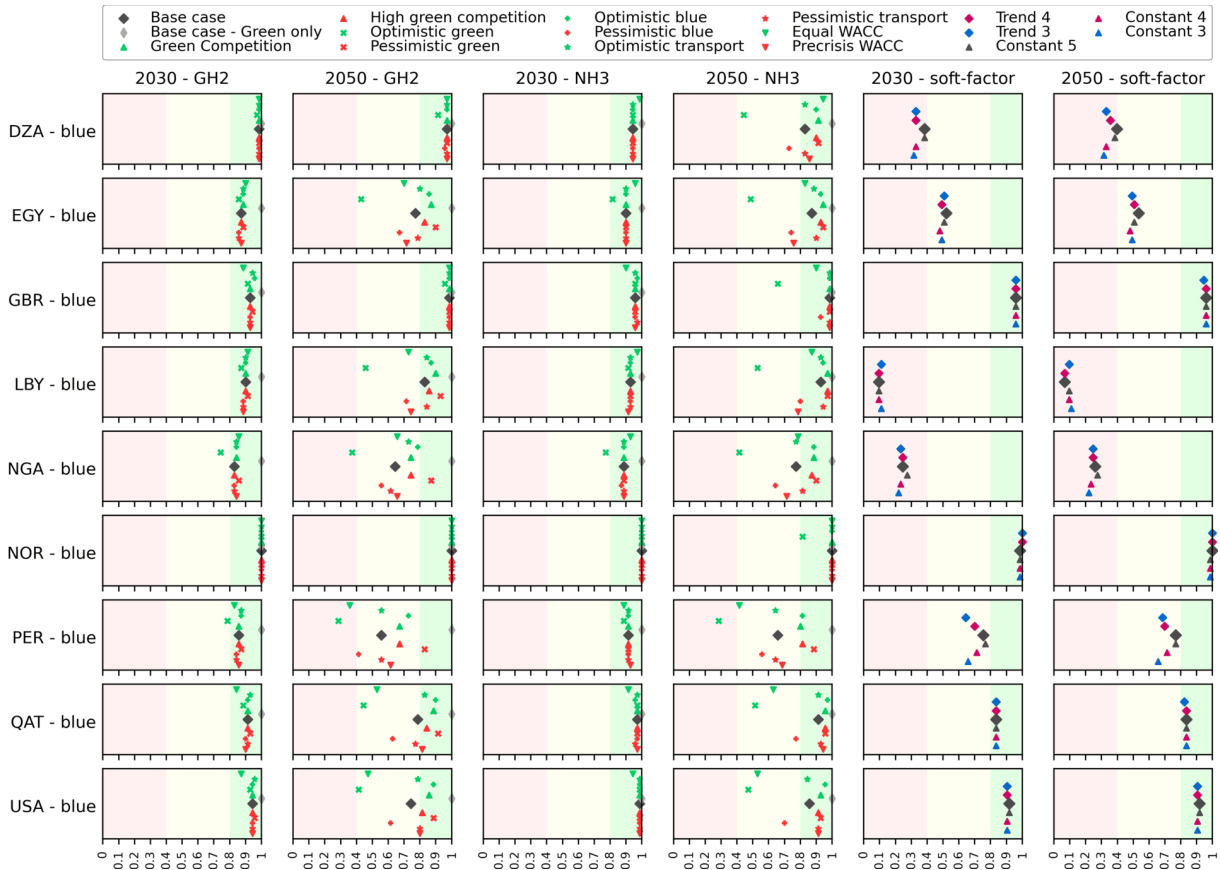

Figure C.5: Sensitivity analysis – blue hydrogen

C.2.3 Sensitivity analysis part 2 - Assessment of resource availability in export countries

In addition to the first part of the sensitivity analysis, in the second part, the export countries are assessed based in their overall resources potential of renewables. The initial hard criterion that countries need to have at least a renewable potential of 2.5 times their current energy demand is increased to a factor of 3.5 and 5.

C.2.3.1 Results on hydrogen supply for a factor of 3.5

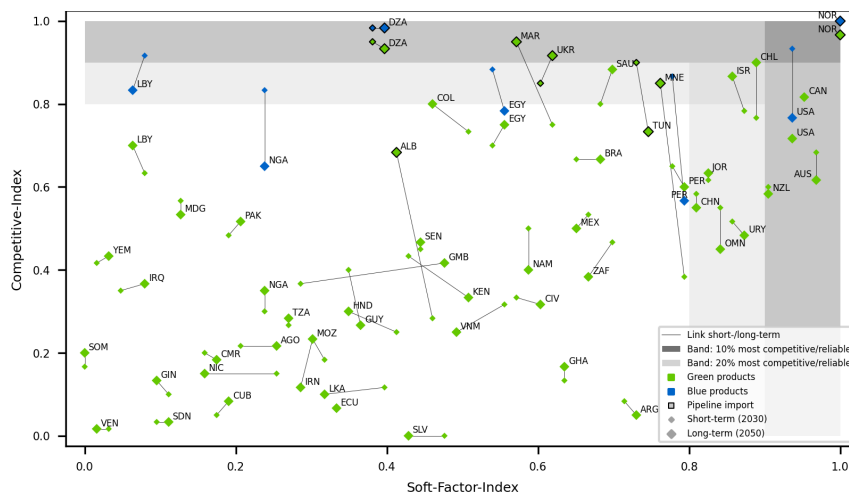

Figure C.6: Sensitivity analysis res factor 3.5 - combined analysis for GH₂

C.2.3.2 Results on ammonia supply for a factor of 3.5

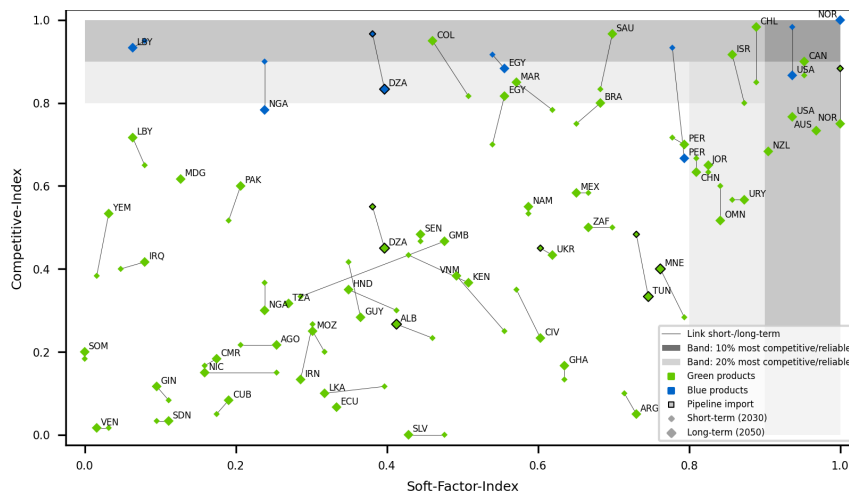

Figure C.7: Sensitivity analysis res factor 3.5 - combined analysis for NH₃

C.2.3.3 Results on hydrogen supply for a factor of 5

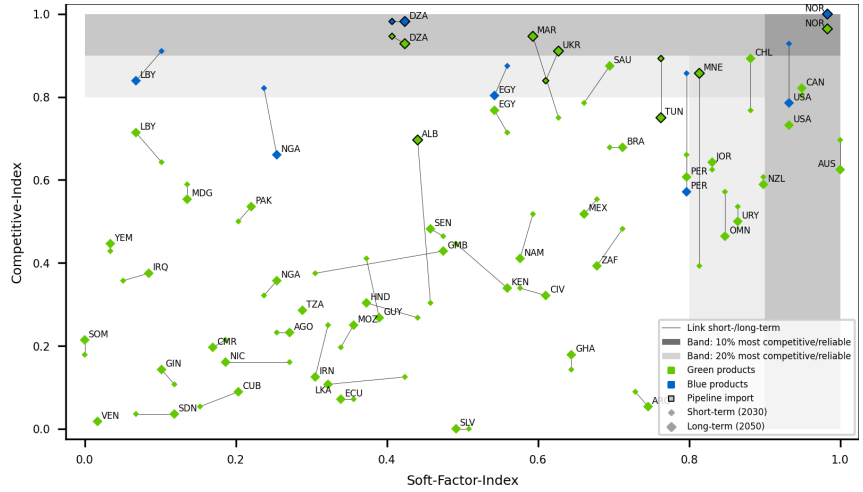

Figure C.8: Sensitivity analysis res factor 5 - combined analysis for GH₂

C.2.3.4 Results on ammonia supply for a factor of 5

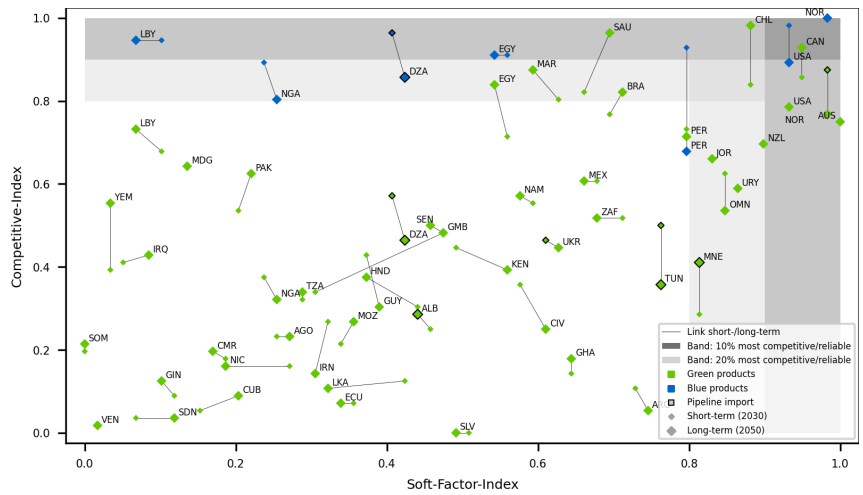
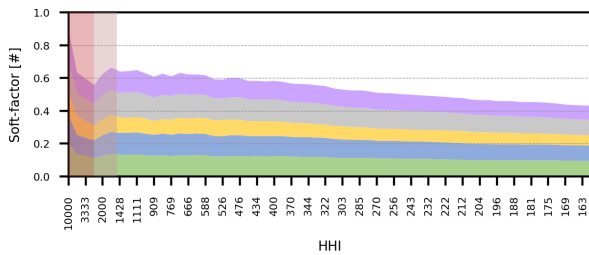

Figure C.9: Sensitivity analysis res factor 5 - combined analysis for NH₃

C.2.4 Detailed results of 'base case – green only'

Within this subsection, the detailed results of the 'base case – green only' scenario setting are presented.



(c) Cost-optimised 2030

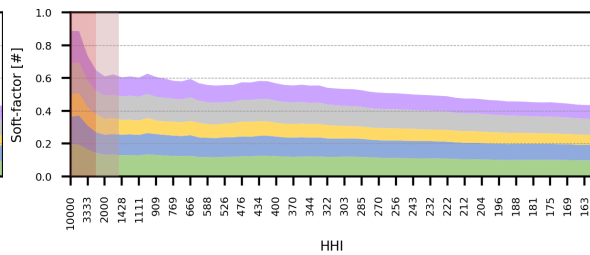

(d) Cost-optimised 2050

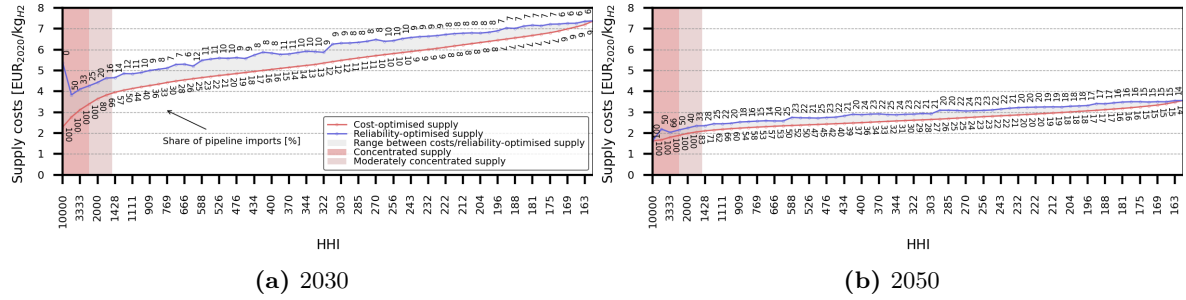

Figure C.10: Analysis of cost-optimised vs. soft-factor-optimised supply of gaseous hydrogen (green only)

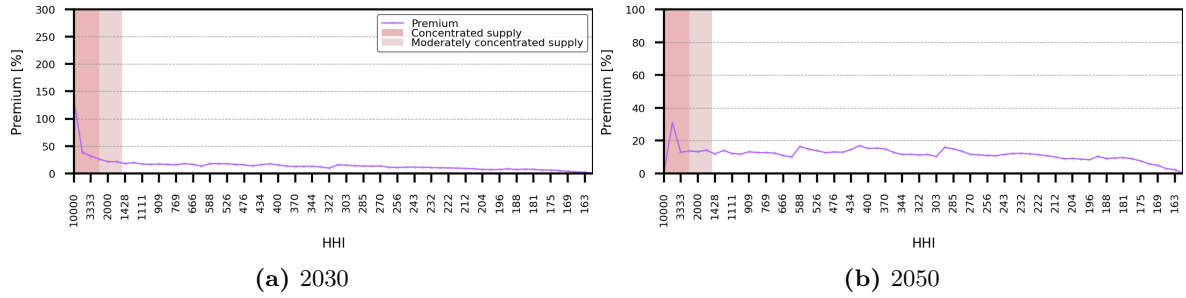

Figure C.11: Reliability premiums for supply of gaseous hydrogen (green only)

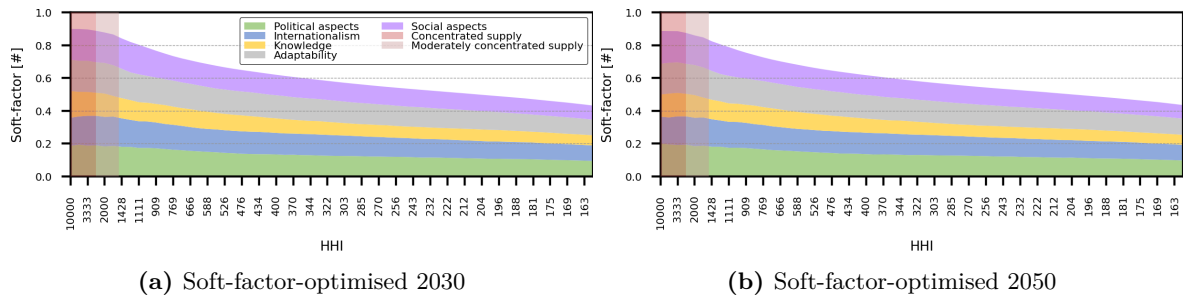
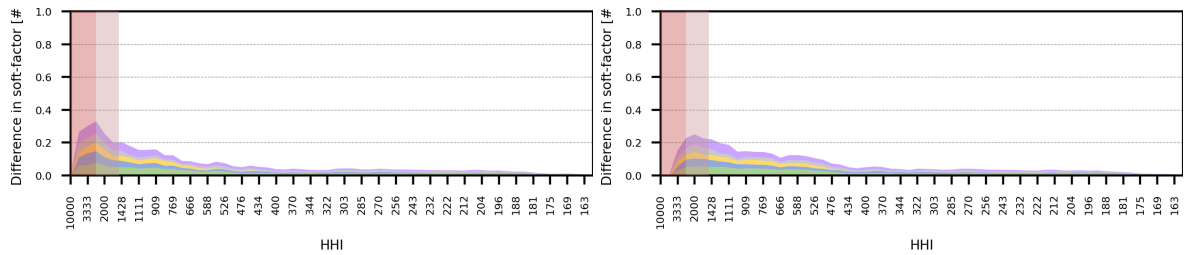

Figure C.12: Soft-factor analysis for supply of gaseous hydrogen (green only)



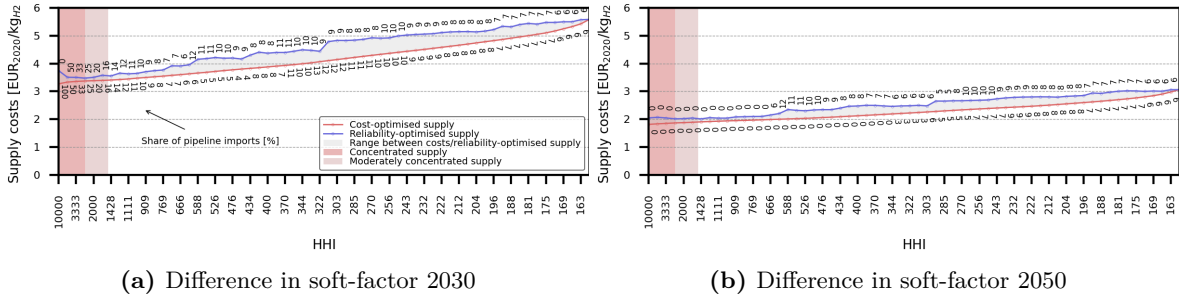

Figure C.13: Analysis of cost-optimised vs. soft-factor-optimised supply of ammonia (green only)

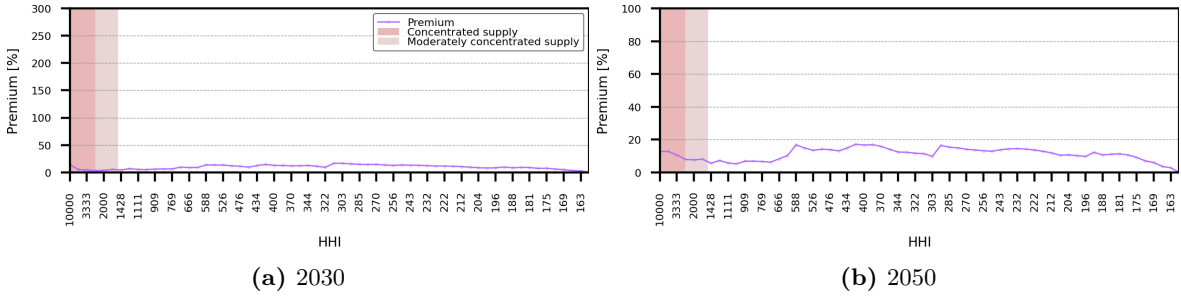

Figure C.14: Reliability premiums for supply of ammonia (green only)

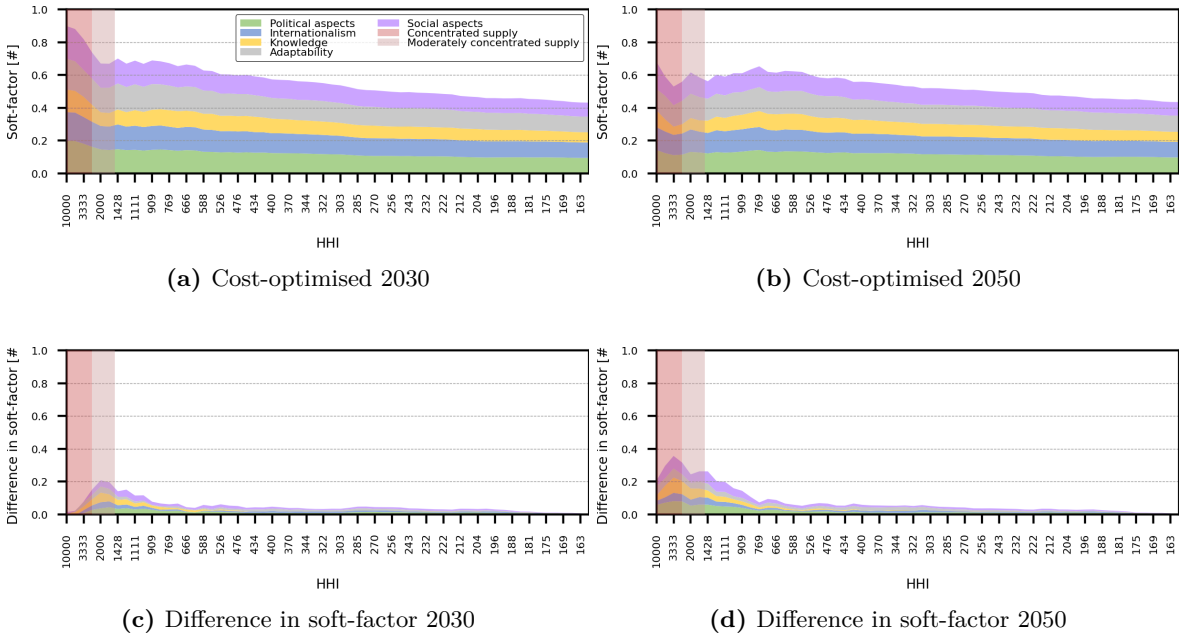

Figure C.15: Soft-factor analysis for supply of ammonia (green only)

C.3 Detailed supply costs analysis

C.3.1 Methodology / Calculation

C.3.1.1 Supply chain optimisation

Symbol	Description	Unit
Variables		
s	Hydrogen volume transport via supply chain	[MWh _{H2delivered}]
$c^{conv,dest}$	Cost: conversion at destination location	[EUR/MWh _{H2delivered}]
$c^{trans,eu}$	Cost: transport within the EU	[EUR/MWh _{H2delivered}]
$c^{conv,entry}$	Cost: conversion at entry point	[EUR/MWh _{H2delivered}]
$c^{term,entry}$	Cost: handling and storage at entry point (Terminal)	[EUR/MWh _{H2delivered}]
$c^{trans,int}$	Cost: international transport between exit and entry point	[EUR/MWh _{H2delivered}]
$c^{term,exit}$	Cost: handling and storage at exit point (Terminal)	[EUR/MWh _{H2delivered}]
$c^{conv,exit}$	Cost: conversion at exit point	[EUR/MWh _{H2delivered}]
$c^{trans,exp}$	Cost: transport in export country	[EUR/MWh _{H2delivered}]
c^{prod}	Cost: hydrogen production	[EUR/MWh _{H2delivered}]
$r^{conv,dest}$	Factor: volume correction at destination location outlet	[#]
$r^{trans,eu}$	Factor: volume correction at EU transport outlet	[#]
$r^{conv,entry}$	Factor: volume correction at entry point conversion outlet	[#]
$r^{term,entry}$	Factor: volume correction at entry point terminal outlet	[#]
$r^{trans,int}$	Factor: volume correction at international transport outlet	[#]
$r^{conv,exit}$	Factor: volume correction at exit point conversion outlet	[#]
$r^{trans,exp}$	Factor: volume correction at national trans. (exp. country outlet)	[#]
r^{prod}	Factor: volume correction at production outlet	[#]
Parameter		
C^{conv}	Cost: total conversion cost per unit hydrogen	[EUR/MWh _{H2}]
$C^{conv,fix}$	Cost: conversion cost per unit of H ₂ (excl. electricity costs)	[EUR/MWh _{H2}]
C^{trans}	Cost: total transport cost per unit hydrogen	[EUR/MWh _{H2}]
$C^{trans,fix}$	Cost: transport cost per unit of H ₂ (excl. electricity costs)	[EUR/MWh _{H2}]
$C^{trans,dist}$	Cost: transport cost per unit hydrogen linked to transport distance	[EUR/MWh _{H2} /1000km]
$C^{term-entry}$	Cost: total import terminal cost per unit hydrogen	[EUR/MWh _{H2}]
$C^{term-entry,fix}$	Cost: import terminal cost p. u. of H ₂ (excl. electricity costs)	[EUR/MWh _{H2}]
$C^{term-exit}$	Cost: total export terminal cost per unit hydrogen	[EUR/MWh _{H2}]
$C^{term-exit,fix}$	Cost: export terminal cost p. u. of H ₂ (excl. electricity costs)	[EUR/MWh _{H2}]
C^{prod}	Cost: total production cost per unit of hydrogen = LCOH _{prod}	[EUR/MWh _{H2}]
$LCOH^{prod}$	Cost: total production cost per unit of hydrogen	[EUR/MWh _{H2}]
C^{ele}	Price: electricity	[EUR/MWh _{ele}]
$C^{ele,eu}$	Price: common EU electricity price	[EUR/MWh _{ele}]
$p^{trans,ele}$	Electricity demand: transport	[MWh _{ele} /MWh _{H2} /1000km]
$p^{conv,ele}$	Electricity demand: conversion	[MWh _{ele} /MWh _{H2}]
$p^{term-entry,ele}$	Electricity demand: import terminal	[MWh _{ele} /MWh _{H2}]
$p^{term-exit,ele}$	Electricity demand: export terminal	[MWh _{ele} /MWh _{H2}]
$p^{conv,term}$	Thermal energy demand: conversion	[MWh _{therm} /MWh _{H2}]
$p^{trans,term}$	Thermal energy demand: transport	[MWh _{therm} /MWh _{H2}]
$p^{term-entry,term}$	Thermal energy demand: timport terminal	[MWh _{therm} /MWh _{H2}]
$p^{term-exit,term}$	Thermal energy demand: export terminal	[MWh _{therm} /MWh _{H2}]
η^{conv}	Efficiency: conversion	[#]
η^{trans}	Efficiency: transport	[#]
$\eta^{term-entry}$	Efficiency: export terminal	[#]
$\eta^{term-exit}$	Efficiency: timport terminal	[#]
D^{on}	Distance: onshore	[1000km]
D^{off}	Distance: offshore	[1000km]
V^{off}	Factor: cost mark-up for offshore transport	[#]
V^{dmd}	H ₂ demand (or derivative) at a location/country within the EU	[MWh _{H2}]
Lower indices		
y	Target year	
l	Production location	
m	Exit point	
n	Entry point	
k	Destination location	
x	Energy vector / form of H ₂ : at production outlet	
u	Energy vector / form of H ₂ : in international transport	
v	Energy vector / form of H ₂ : in EU transport	
w	Energy vector / form of H ₂ : demanded at destination location	
Sets		
Y	Considered target years	
L	All considered locations	
L^{prod}	Considered production location	
L^{exit}	Considered exit points	
L^{entry}	Considered entry points	
L^{dest}	Considered destination locations	
V	All considered energy vectors / forms of H ₂ (GH ₂ , NH ₃ , LOHC, LH ₂)	
V^{prod}	Considered energy vectors / forms of H ₂ : at Production outlet (GH ₂)	
V^{int}	Considered energy vectors / forms of H ₂ : international transport	
V^{eu}	Considered energy vectors / forms of H ₂ : EU transport	

Symbol	Description	Unit
--------	-------------	------

Table C.6: Nomenclature – Supply chain optimisation

Several technologies exist to transport the produced hydrogen from the production to the destination location. The technology route that results in the minimised supply costs is dependent on a variety of factors such as the transport distances, the infrastructure availability, and the financing conditions. Therefore, we develop a linear optimisation problem to find the optimal supply route for each production site considered. The objective is to minimise the costs for the supply of one unit of hydrogen¹. The objective function (C.1) therefore minimises the sum of all occurring costs along the supply chain.

$$\min \quad \text{LCOH}_{l,w,y}^{\text{supply}} = c_{l,w,y}^{\text{prod}} + c_{l,w,y}^{\text{trans}} + c_{l,w,y}^{\text{conv}} + c_{l,w,y}^{\text{term}} \quad (\text{C.1})$$

While product cost (c^{prod}) contains only one single cost element, the costs linked to the transport (c^{trans}), the conversion (c^{conv}) and the handling of the volumes at the ports (terminal) (c^{term}) are composed of at least two elements (C.2)-(C.4).

$$c_{l,w,y}^{\text{trans}} = c_{l,w,y}^{\text{trans,exp}} + c_{l,w,y}^{\text{trans,int}} + c_{l,w,y}^{\text{trans,eu}} \quad (\text{C.2})$$

$$c_{l,w,y}^{\text{conv}} = c_{l,w,y}^{\text{conv,exit}} + c_{l,w,y}^{\text{conv,entry}} + c_{l,w,y}^{\text{conv,dest}} \quad (\text{C.3})$$

$$c_{l,w,y}^{\text{term}} = c_{l,w,y}^{\text{term,exit}} + c_{l,w,y}^{\text{term,entry}} \quad (\text{C.4})$$

Efficiencies losses and energy demand occur within the individual elements of the supply chain. Unless the supply chain is completely lossless, therefore, the volume for transportation increases the further one moves from the point of demand. Consequently, supplying one unit of hydrogen requires more than one unit to be produced. However, the increased volumes do not only cause increasing production costs, but they affect also costs associated to the individual elements in the supply chain. We formulate the optimisation problem therefore in a way that it starts with the balancing equation (C.5)-(C.6) at the destination location and moves gradually along the individual supply chain elements upstream towards the production location. Volume losses in the downstream stages are taken into account accordingly when calculating the costs for each element of the supply chain.

Since this study looks at hydrogen imports into the EU, the supply of a given production site targets different demand locations in the EU, as described in Subsection 4.3.2.1. For every assessed production location l , the sum of demand over all destination locations is 1 (C.5). The share of the demand to the individual destination is covered by all incoming supply routes between the two

¹ For the supply of ammonia, it corresponds to the energy content of one unit of hydrogen

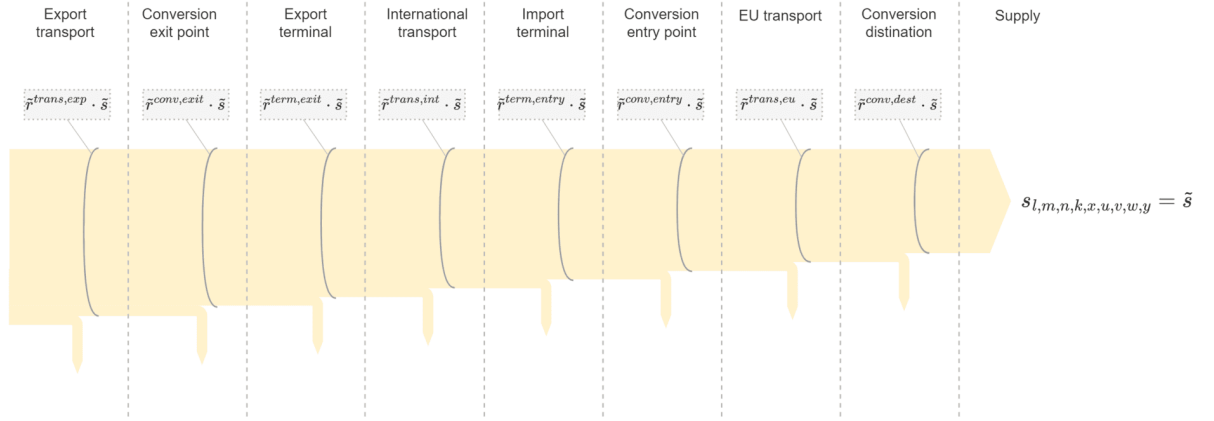

Figure C.16: Illustration of volume flows along supply chains

locations (C.6).

$$1 = \sum_k^{L^{dest}} V_{l,k,w,y}^{dmd} \quad (C.5)$$

$$V_{l,k,w,y}^{dmd} = \sum_m^{L^{exit}} \sum_n^{L^{entry}} \sum_x^{V^{prod}} \sum_u^{V^{int}} \sum_v^{V^{eu}} s_{l,m,n,k,x,u,v,w,y} \quad (C.6)$$

In the following, the cost calculation for each element in the supply chain is introduced and represented by three expressions (a-c). While (b) determines the marginal costs for handling hydrogen at the respective step, in (c) a factor is calculated that accounts for the volume increased due to downstream losses. Expression (a) combines the latter two information and gives the absolute cost for the analysed process step in the analysed supply chain.

Conversion at destination location (C.7a)-(C.7c):

$$C_{l,w,y}^{conv,dest} = \sum_m^{L^{exit}} \sum_n^{L^{entry}} \sum_k^{L^{dest}} \sum_x^{V^{prod}} \sum_u^{V^{int}} \sum_v^{V^{eu}} \left(\tilde{r}_{k,w,y}^{conv,dest} \cdot s_{l,m,n,k,x,u,v,w,y} \cdot C_{k,v,w,y}^{conv} \right) \quad (C.7a)$$

$$C_{k,v,w,y}^{conv} = C_{k,v,w,y}^{conv,fix} + P_{v,w,y}^{conv,ele} \cdot C_{k,y}^{ele} \quad (C.7b)$$

$$\tilde{r}_{k,w,y}^{conv,dest} = 1 \quad (C.7c)$$

Transport within the EU (C.8a)-(C.8c):

$$C_{l,w,y}^{trans,eu} = \sum_m^{L^{exit}} \sum_n^{L^{entry}} \sum_k^{L^{eu}} \sum_x^{V^{prod}} \sum_u^{V^{int}} \sum_v^{V^{eu}} \left(\tilde{r}_{v,w,y}^{trans,eu} \cdot s_{l,m,n,k,x,u,v,w,y} \cdot C_{n,k,v,y}^{trans} \right) \quad (C.8a)$$

$$C_{n,k,v,y}^{trans} = C_{n,k,v,y}^{trans,fix} + C_{v,y}^{trans,dist} \cdot \left(D_{n,k,v,y}^{on} + V_v^{off} \cdot D_{n,k,v,y}^{off} \right) + P_{v,y}^{trans,ele} \cdot C_{n,y}^{ele} \cdot \left(D_{n,k,v,y}^{on} + D_{n,k,v,y}^{off} \right) \quad (C.8b)$$

$$\tilde{r}_{v,w,y}^{trans,eu} = \tilde{r}_{k,w,y}^{conv,dest} \cdot \left(\frac{1}{\eta_{v,w,y}^{conv}} + P_{v,w,y}^{conv,term} \right) \quad (C.8c)$$

Conversion at the entry point (C.9a)-(C.9c):

$$C_{l,w,y}^{conv,entry} = \sum_m^{L^{exit}} \sum_n^{L^{entry}} \sum_k^{L^{eu}} \sum_x^{V^{prod}} \sum_u^{V^{int}} \sum_v^{V^{eu}} \left(\tilde{r}_{n,k,v,w,y}^{conv,entry} \cdot s_{l,m,n,k,x,u,v,w,y} \cdot C_{n,u,v,y}^{conv} \right) \quad (C.9a)$$

$$C_{n,u,v,y}^{conv} = C_{n,u,v,y}^{conv,fix} + P_{u,v,y}^{conv,ele} \cdot C_{n,y}^{ele} \quad (C.9b)$$

$$\tilde{r}_{n,k,v,w,y}^{conv,entry} = \tilde{r}_{v,w,y}^{trans,eu} \cdot \left(P_{n,k,v,y}^{trans,term} \cdot \left(D_{n,k,v,y}^{on} + D_{n,k,v,y}^{off} \right) \right) \quad (C.9c)$$

Handling and storage at the entry point (Terminal) (C.10a)-(C.10c):

$$C_{l,w,y}^{term,entry} = \sum_m^{L^{exit}} \sum_n^{L^{entry}} \sum_k^{L^{eu}} \sum_x^{V^{prod}} \sum_u^{V^{int}} \sum_v^{V^{eu}} \left(\tilde{r}_{n,k,u,v,w,y}^{term,entry} \cdot s_{l,m,n,k,x,u,v,w,y} \cdot C_{n,u,y}^{term-entry} \right) \quad (C.10a)$$

$$C_{n,u,y}^{term-entry} = C_{n,u,y}^{term-entry,fix} + P_{u,y}^{term-entry,ele} \cdot C_{n,y}^{ele} \quad (C.10b)$$

$$\tilde{r}_{n,k,u,v,w,y}^{term,entry} = \tilde{r}_{n,k,v,w,y}^{conv,entry} \cdot \left(\frac{1}{\eta_{u,v,y}^{conv}} + P_{u,v,y}^{conv,term} \right) \quad (C.10c)$$

International transport from exit point to entry point (C.10a)-(C.10c):

$$C_{l,w,y}^{trans,int} = \sum_m^{L^{exit}} \sum_n^{L^{entry}} \sum_k^{L^{eu}} \sum_x^{V^{prod}} \sum_u^{V^{int}} \sum_v^{V^{eu}} \left(\tilde{r}_{n,k,u,v,w,y}^{trans,int} \cdot s_{l,m,n,k,x,u,v,w,y} \cdot C_{m,n,u,y}^{trans} \right) \quad (C.11a)$$

$$C_{m,n,u,y}^{trans} = C_{m,n,u,y}^{trans,fix} + C_{m,n,u,y}^{trans,dist} \cdot \left(D_{m,n,u,y}^{on} + V_u^{off} \cdot D_{m,n,u,y}^{off} \right) + P_{u,y}^{trans,ele} \cdot C_{m,y}^{ele} \cdot \left(D_{m,n,u,y}^{on} + D_{m,n,u,y}^{off} \right) \quad (C.11b)$$

$$\tilde{r}_{n,k,u,v,w,y}^{trans,int} = \tilde{r}_{n,k,u,v,w,y}^{term,entry} \cdot \left(\frac{1}{\eta_{u,y}^{term-entry}} + P_{u,y}^{term-entry,term} \right) \quad (C.11c)$$

Handling and storage at the exit point (terminal) (C.12a)-(C.12c):

$$c_{l,w,y}^{term,exit} = \sum_m^{L^{exit}} \sum_n^{L^{entry}} \sum_k^{L^{eu}} \sum_x^{V^{prod}} \sum_u^{V^{int}} \sum_v^{V^{eu}} \left(\tilde{r}_{m,n,k,u,v,w,y}^{term,exit} \cdot s_{l,m,n,k,x,u,v,w,y} \cdot C_{m,u,y}^{term-exit} \right) \quad (C.12a)$$

$$C_{m,u,y}^{term-exit} = C_{m,u,y}^{term-exit,fix} + P_{u,y}^{term-exit,ele} \cdot C_{m,y}^{ele} \quad (C.12b)$$

$$\tilde{r}_{m,n,k,u,v,w,y}^{term,exit} = \tilde{r}_{n,k,u,v,w,y}^{trans,int} \cdot \left(\frac{1}{\eta_{u,y}^{trans}} + P_{u,y}^{trans,term} \cdot \left(D_{m,n,u,y}^{on} + D_{m,n,u,y}^{off} \right) \right) \quad (C.12c)$$

Conversion at the exit point (C.13a)-(C.13c):

$$c_{l,w,y}^{conv,exit} = \sum_m^{L^{exit}} \sum_n^{L^{entry}} \sum_k^{L^{eu}} \sum_x^{V^{prod}} \sum_u^{V^{int}} \sum_v^{V^{eu}} \left(\tilde{r}_{m,n,k,u,v,w,y}^{conv,exit} \cdot s_{l,m,n,k,x,u,v,w,y} \cdot C_{m,x,u,y}^{conv} \right) \quad (C.13a)$$

$$C_{m,x,u,y}^{conv,exit} = C_{m,x,u,y}^{conv,fix} + P_{x,u,y}^{conv,ele} \cdot C_{m,y}^{ele} \quad (C.13b)$$

$$\tilde{r}_{m,n,k,u,v,w,y}^{conv,exit} = \tilde{r}_{m,n,k,u,v,w,y}^{term,exit} \cdot \left(\frac{1}{\eta_{u,y}^{term-exit}} + P_{u,y}^{term-exit,term} \right) \quad (C.13c)$$

National transport in the export country (C.14a)-(C.14c):

$$c_{l,w,y}^{trans,exp} = \sum_m^{L^{exit}} \sum_n^{L^{entry}} \sum_k^{L^{eu}} \sum_x^{V^{prod}} \sum_u^{V^{int}} \sum_v^{V^{eu}} \left(\tilde{r}_{m,n,k,x,u,v,w,y}^{trans,exp} \cdot s_{l,m,n,k,x,u,v,w,y} \cdot C_{l,m,x,y}^{trans} \right) \quad (C.14a)$$

$$C_{l,m,x,y}^{trans,exp} = C_{l,m,x,y}^{trans,fix} + C_{x,y}^{trans,dist} \cdot \left(D_{l,m,x,y}^{on} + V_x^{off} \cdot D_{l,m,x,y}^{off} \right) + P_{x,y}^{trans,ele} \cdot C_{l,y}^{ele} \cdot \left(D_{l,m,x,y}^{on} + D_{l,m,x,y}^{off} \right) \quad (C.14b)$$

$$\tilde{r}_{m,n,k,x,u,v,w,y}^{trans,exp} = \tilde{r}_{m,n,k,u,v,w,y}^{conv,exit} \cdot \left(\frac{1}{\eta_{x,u,y}^{conv}} + P_{x,u,y}^{conv,term} \right) \quad (C.14c)$$

Hydrogen production (C.15a)-(C.15c):

$$c_{l,w,y}^{prod} = \sum_m^{L^{exit}} \sum_n^{L^{entry}} \sum_k^{L^{eu}} \sum_x^{V^{prod}} \sum_u^{V^{int}} \sum_v^{V^{eu}} \left(\tilde{r}_{l,m,n,k,x,u,v,w,y}^{prod} \cdot s_{l,m,n,k,x,u,v,w,y} \cdot C_{l,x,y}^{prod} \right) \quad (C.15a)$$

$$C_{l,y}^{prod} = LCOH_{l,y}^{prod} \quad (C.15b)$$

$$\tilde{r}_{l,m,n,k,x,u,v,w,y}^{prod} = \tilde{r}_{m,n,k,x,u,v,w,y}^{trans,exp} \cdot \left(\frac{1}{\eta_{x,y}^{trans}} + P_{x,y}^{trans,term} \cdot \left(D_{l,m,x,y}^{on} + D_{l,m,x,y}^{off} \right) \right) \quad (C.15c)$$

Moreover, it is defined that electricity costs at exit point (m) are identical to the ones at the production location (l). All electricity demand within the EU (entry point n and destination location k) is provided at a common annual EU electricity cost (Table C.13).

$$C_{l,y}^{ele} = C_{m,y}^{ele}; \quad C_{n,y}^{ele} = C_{k,y}^{ele} = C_y^{ele,eu} \quad (C.16)$$

C.3.1.2 Upstream

Calculation of hydrogen production costs

Symbol	Description	Unit
Variables		
q^{cap}	Installed capacity	[MW]
$p^{out,sys}$	System output: produced hydrogen	[MWh]
$p^{out,pth2}$	Electricity: injected in electrolyser	[MWh]
$p^{out,unit}$	Electricity: generated	[MWh]
$p^{out,curt}$	Electricity: curtailed	[MWh]
Parameter		
C^{capex}	Cost: capital expenditure	[EUR/MW]
C^{fom}	Cost: fix operation and maintenance	[EUR/MW]
C^{vom}	Cost: variable operation and maintenance	[EUR/MWh]
$C^{opex,oth}$	Cost: operating expences hydrogen production	[EUR/MWh _{H2}]
C^{h2o}	Cost: water supply	[EUR/MWh _{H2}]
C^{co2}	Cost: CO ₂ emission allowances	[EUR/tCO ₂]
C^{cts}	Cost: CO ₂ transport and storage	[EUR/tCO ₂]
η^{pth2}	Efficiency: electrolyser	[#]
η^{ccs}	Efficiency: CCS (capture rate)	[#]
V^{lh}	Lower heating value of hydrogen	[MWh _{ele} /MWh _{H2}]
V^t	Lifetime	[a]
V^{cf}	Capacity factor	[#]
V^{wacc}	Weighted average cost of captial - WACC	[#]
V^{ef}	Emission factor	[tCO ₂ /MWh _{raw}]
V^{an}	Annualisation factor	[#]
V^{avail}	Availability	[#]
Lower indices		
y	Target year	
t	Hourly timestep	
g	Technology	
l	Production location/cell (linked to a country and to the respective national data)	
Sets		
Y	Considered target years	
T	Hours of a year	
L	Considered production locations / cells	
G	Technology	
G^{smr}	Technology: steam methane reformer combined with CCS facility	
G^{green}	Technology: set applicable for green hydrogen: G^{pth2} & G^{res}	
G^{pth2}	Technology: electrolyser	
G^{res}	Technology: renewable generator - PV and wind	

Table C.7: Nomenclature - LCOH calculation

The production costs of hydrogen are dependent on location-specific conditions such as local resources, system costs and financing conditions. Consequently, the optimal system configuration that results in the lowest hydrogen production costs can differ among locations and might change over time as a result of techno-economic developments. Therefore, to obtain the appropriate system configuration that leads to minimum production costs, we individually analyse all the assessed production sites for each assessed year. Corresponding techno-economic developments and site-specific conditions are hereby considered. The basis for the optimisation of the system configuration at each production location is given by the levelized cost of hydrogen also referred to as LCOH. The approach is based on the calculation of Levelized Costs of Electricity (LCOE), which allows for the comparison of different electricity generation technologies based on their production costs. As the approach considers a variety of important parameters, the method has been applied widely in the

past. While there are different ways to calculate the LCOE, similar to Brändle, Schönfisch, and Schulte (2021) we choose an approach that assesses the production based on annualised costs and modified it accordingly to determine the LCOH (see equation (C.17)). Since it allows the consideration of both a high spatial and a high temporal granularity, an adequate representation of the site-specific conditions is given. However, the system design for blue and green hydrogen production is different. Therefore, despite the same principle, the application of the LCOH calculation is slightly different for the two production routes.

$$\text{LCOH}_{l,y}^{\text{prod}} = \frac{\sum_g \left(q_{g,l,y}^{\text{cap}} \cdot \left(V_{g,l,y}^{\text{an}} \cdot C_{g,l,y}^{\text{capex}} + C_{g,l,y}^{\text{fom}} \right) + \sum_t P_{g,l,t,y}^{\text{out,unit}} \cdot C_{g,l,y}^{\text{wom}} \right)}{\sum_t P_{l,t,y}^{\text{out,sys}}} + C_{l,y}^{\text{opex,oth}} \quad (\text{C.17})$$

Where V^{an} is the annualisation factor that is calculated by the expression (C.18):

$$V_{g,l,y}^{\text{an}} = \frac{V_l^{\text{wacc}} \cdot (1 + V_l^{\text{wacc}})^{V_{g,y}^t}}{(1 + V_l^{\text{wacc}})^{V_{g,y}^t} - 1} \quad (\text{C.18})$$

Calculation of hydrogen production costs - green hydrogen

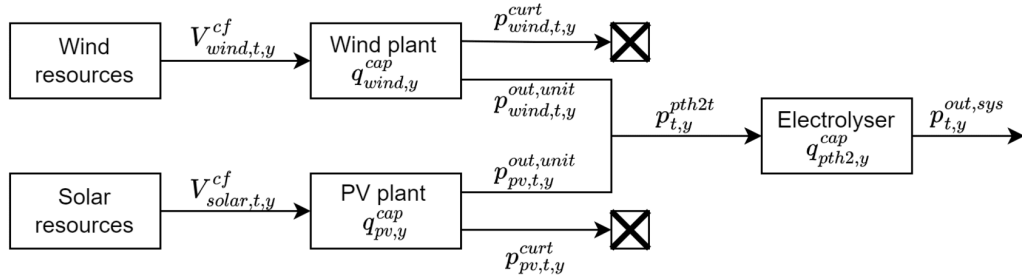

Figure C.17: Scheme – green hydrogen production at location l in country c

In the context of our analysis, production systems generally consist of three system components, namely, electrolysers, photovoltaic systems, and wind turbines. These define the set of applicable technologies G^{res} . However, depending on the site-specific conditions there might be only one of the two electricity generator types available. While the approach remains identical in such cases, the capacity of the unavailable generation technology is simply assumed to be zero. As the sizes of the three system components and their relations is location-specific, we set up a non-linear optimisation model to obtain the cost-optimal system configuration. The objective function (C.19) minimises the LCOH according to its definition (C.17).

$$\min \quad \text{LCOH}_{l,y}^{\text{prod}} \quad (\text{C.19})$$

The annual hydrogen production results from the electricity fed into the electrolyser system over all

hours of the year as well as from its efficiency (C.20).

$$p_{l,t,y}^{out,sys} = p_{l,t,y}^{out,pth2} \cdot \eta_y^{pth2} \quad (C.20)$$

Where the hourly electricity injection into the electrolyser can further be expressed by (C.21). It sums the generated electricity of the individual generation technologies but is constrained by the electrolyser capacity (C.22).

$$p_{l,t,y}^{out,pth2} = \sum_g^{Gres} p_{g,l,t,y}^{out,unit} \quad (C.21)$$

$$p_{l,t,y}^{out,pth2} \leq q_{g,l,y}^{cap} \quad (C.22)$$

The hourly electricity generation of each generation technology is obtained through (C.23), where their capacities are multiplied by the hourly capacity factor at the analysed production location. As the generation capacity can be oversized to minimise hydrogen production costs, hours with surplus generation can occur. They are considered through curtailments $p^{out,curt}$.

$$p_{g,l,t,y}^{out,unit} + p_{g,l,t,y}^{out,curt} = V_{g,l,t,y}^{cf} \cdot q_{g,l,y}^{cap} \quad (C.23)$$

The operating expenses only include the costs for the required water supply in the hydrogen production (C.24). All other opex are already considered through the individual system components (e.g., electrolyser, wind turbine solar plant).

$$C_{l,y}^{opex,oth} = C_y^{h2o} \quad (C.24)$$

Calculation of hydrogen production costs - blue hydrogen

Differently from the production of green hydrogen, in our analysis, the system setup for produc-

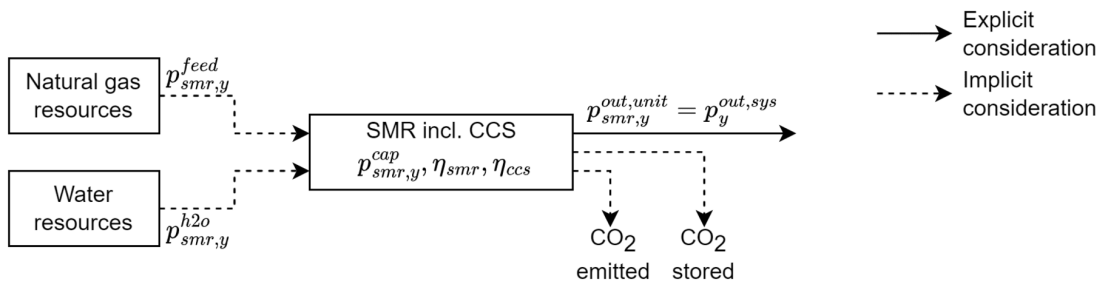

Figure C.18: Scheme - blue hydrogen production at location l in country c

ing blue hydrogen only consists of one component – the steam methane reformer including CCS

facilities. Consequently, there is no need to optimise the sizes of different elements with respect to the overall system. Moreover, as the steam methane reforming process is assumed to operate in a base load pattern, it is not influenced by the intermittency of renewable sources. Therefore, one can deviate from an hourly assessment and look at the development on an annual level. Consequently, the calculation of the LCOH, as presented in (C.17), can be simplified - see (C.25). The expression is valid for $\forall g \in G^{smr}$.

$$\text{LCOH}_{l,y}^{prod} = \frac{\sum_g^{G^{smr}} \left(q_{g,l,y}^{cap} \cdot \left(V_{g,l,y}^{an} \cdot C_{g,l,y}^{CAPEX} + C_{g,l,y}^{fom} \right) \right)}{p_{l,y}^{out,sys}} + \sum_g^{G^{smr}} C_{g,l,y}^{vom} + C_{l,y}^{opex,oth} \quad (\text{C.25})$$

Since we do not consider scaling effects that could affect hydrogen costs, the capacity is fixed (C.26). The annual hydrogen production $p^{out,sys}$ is obtained by (C.27).

$$q_{g,l,y}^{cap} = 1 \quad (\text{C.26})$$

$$p_{l,y}^{out,sys} = \sum_g^{G^{smr}} \left(q_{g,l,y}^{cap} \cdot \eta_{g,y} \cdot V_{g,l}^{avail} \cdot 8760 \right) \quad (\text{C.27})$$

In addition to the cost of the water, the operating costs also include the cost of the natural gas feedstock as well as the cost of capturing and storing the CO₂ produced C.28. While most CO₂ is captured by the CCS process, the remainder is emitted to the atmosphere. However, both streams cause additional costs. While the handling and storing of the captured CO₂ are considered by c^{cts} , the emitted CO₂ is compensated through emission allowances (C^{co2}).

$$C_{l,y}^{opex,oth} = C_y^{h2o} + \frac{1}{\sum_g \eta_{g,y}} \cdot \left(C_{l,y}^{feed} + V^{ef} \cdot \left((1 - \eta_y^{co2}) \cdot C_{l,y}^{co2} + \eta_y^{co2} \cdot C_{l,y}^{cts} \right) \right) \quad (\text{C.28})$$

Calculation of costs for process electricity

Various processes along the supply chain, such as pipeline compressor stations, require process energy in the form of electricity. This electricity might be sourced from the local electricity mix through the power grid. However, depending on the underlying generation process, the grid electricity could be associated with CO₂ emissions, which can affect the carbon content of the imported hydrogen. To ensure that the imported hydrogen is within the required carbon content limits, we therefore consider the process electricity to come directly from dedicated low-carbon sources that are in accordance with the analysed upstream route.² Consequently, it is distinguished between ‘blue’ and ‘green’ electricity. However, we only determine costs for process electricity in the export country. Electricity needed in

² Another way would be to convert the produced hydrogen to electricity. However, due to the conversion steps along the supply chains and the associated losses, the efficiency of this approach would be low, resulting in high electricity costs.

the EU is sourced from the EU power grid, as a reasonable share of green electricity is assumed to be in it. The following two paragraphs introduce the approaches for calculating the costs for green and blue electricity.

Symbol	Description	Unit
Variables		
q^{sto}	Installed storage volume	[MWh]
q^{cap}	Installed capacity	[MW]
$p^{out,sys}$	System output: electricity	[MWh]
$p^{out,unit}$	Electricity: generated by RES / Discharging of battery	[MWh]
$p^{in,unit}$	Electricity: charging of battery system	[MWh]
$p^{out,curt}$	Electricity: curtailed from RES	[MWh]
Parameter		
C^{capex}	Cost: capital expenditure	[EUR/MW]
C^{fom}	Cost: fix operation and maintenance	[EUR/MW]
C^{vom}	Cost: variable operation and maintenance	[EUR/MWh]
C^{co2}	Cost: CO ₂ emission allowances	[EUR/tCO ₂]
C^{cts}	Cost: CO ₂ transport and storage	[EUR/tCO ₂]
η^{cgt}	efficiency: CCGT	[#]
η^{ccs}	efficiency: CCS (capture rate)	[#]
η^{sto}	efficiency: Battery system	[#]
V^t	Lifetime	[a]
V^{cf}	Capacity factor	[#]
V^{wacc}	Weighted average cost of captial - WACC	[#]
V^{ef}	Emission factor	[tCO ₂ /MWh _{raw}]
V^{an}	Annualisation factor	[#]
V^{avail}	Minimal system availability	[#]
Lower indices		
y	Target year	
t	Hourly timestep	
g	Technology	
l	Production location/cell (linked to national data)	
Sets		
Y	Considered target years	
T	Hours of a year	
T^1	First hour of a year	
T^{8760}	Last hour of a year	
T^{2-8759}	All hours of a year except for the first and the last	
L	Considered production locations / cells	
G	Technology	
G^{cgt}	Technology: combined-cycle gas turbine with CCS	
G^{green}	Technology: set applicable for green hydrogen: G^{sto} & G^{res}	
G^{sto}	Technology: battery system	
G^{res}	Technology: renewable generator - PV and wind	

Table C.8: Nomenclature - LCOE calculation

Calculation of costs for process electricity - green LCOE

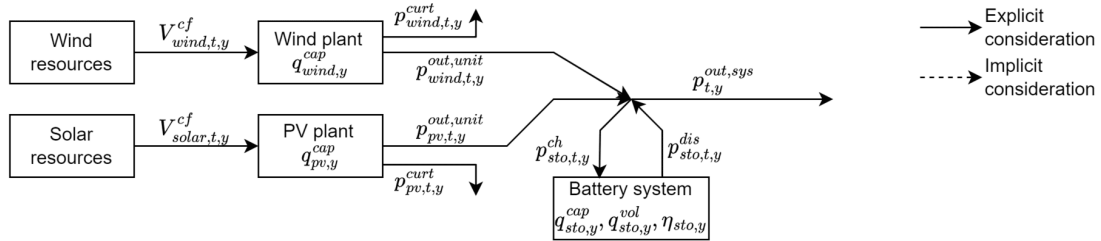

Figure C.19: Scheme – green electricity generation at location l in country c

Similar to the calculation of the production costs of green hydrogen, the levelized costs of green electricity is determined based on (C.17). However, as the process electricity is required in base load patterns to ensure a continuous operation of system elements along the supply chain, we add battery storage systems to the analysis that enable flattening the output trend of the renewable generation. The electrolyser systems in (C.17) are therefore replaced by batteries. Since the system consists of three components (PV, wind, battery) that can be sized optimally with respect to each other based on the given site-specific conditions, we develop a nonlinear optimisation model to obtain the appropriate system configuration. The calculation of the green LCOE is given by (C.29). Compared to (C.17), the term of the additional operating expenditures ($C^{ope.x,oth}$) is dropped, as all operating costs are already included in the variable costs of the individual system components.

$$\text{LCOE}_{l,y} = \frac{\sum_g \left(q_{g,l,y}^{cap} \cdot \left(V_{g,l,y}^{an} \cdot C_{g,l,y}^{capex} + C_{g,l,y}^{fom} \right) + \sum_t p_{g,l,t,y}^{out,unit} \cdot C_{g,l,y}^{vom} \right)}{\sum_t p_{l,t,y}^{out,sys}} \quad (\text{C.29})$$

The objective function is given by (C.30):

$$\min \text{LCOE}_{l,y} \quad (\text{C.30})$$

The targeted electricity supply $p^{out,sys}$ is given by the balancing equation (C.31). It is derived from the electricity provided by the renewable generators and the exchange with the battery storage system.

$$p_{l,t,y}^{out,sys} = \sum_g p_{g,l,t,y}^{out,unit} + \sum_g \left(p_{g,l,t,y}^{out,unit} - p_{g,l,t,y}^{in,unit} \right) \quad (\text{C.31})$$

The battery storage can be further described by (C.32a)-(C.32d). While (C.32a) and (C.32c) represent the storage balance at the first and the last considered hourly timestep, respectively, (C.32b) covers all intermediate timesteps and in (C.32d), several general constraints on the storage system are expressed.

$$l_{g,l,t,y} = l_{g,l,y}^{init} + \eta_{g,y} \cdot p_{g,l,t,y}^{in,unit} - \frac{1}{\eta_{g,y}} \cdot p_{g,l,t,y}^{out,unit} \quad \forall t \in T^1, \quad \forall g \in G^{sto} \quad (\text{C.32a})$$

$$l_{g,l,t,y} = l_{g,l,t-1,y} + \eta_{g,y} \cdot p_{g,l,t,y}^{in,unit} - \frac{1}{\eta_{g,y}} \cdot p_{g,l,t,y}^{out,unit} \quad \forall t \in T^{2-8759}, \quad \forall g \in G^{sto} \quad (\text{C.32b})$$

$$l_{g,l,y}^{init} = l_{g,l,t-1,y} + \eta_{g,y} \cdot p_{g,l,t,y}^{in,unit} - \frac{1}{\eta_{g,y}} \cdot p_{g,l,t,y}^{out,unit} \quad \forall t \in T^{8760}, \quad \forall g \in G^{sto} \quad (\text{C.32c})$$

$$0 \leq p_{g,l,t,y}^{out,unit} \leq q_{g,l,y}^{cap}; \quad 0 \leq p_{g,l,t,y}^{in,unit} \leq q_{g,l,y}^{cap}; \quad 0 \leq l_{g,l,y}^{init} \leq q_{g,l,y}^{vol}; \quad 0 \leq l_{g,l,t,y} \leq q_{g,l,y}^{vol} \quad \forall g \in G^{sto} \quad (\text{C.32d})$$

To ensure a primarily continuous electricity provision throughout the year, expressions (C.33) and (C.34) are added to the optimisation problem. Whereas (C.33) restricts the output to 1 MW, (C.34) ensures that the system has a minimum availability of V^{avail} throughout the year.

$$p_{l,t,y}^{out,sys} \leq 1 \quad (C.33)$$

$$8760 \cdot V^{avail} \leq \sum_t^T p_{l,t,y}^{out,sys} \quad (C.34)$$

Calculation of costs for process electricity – blue LCOE

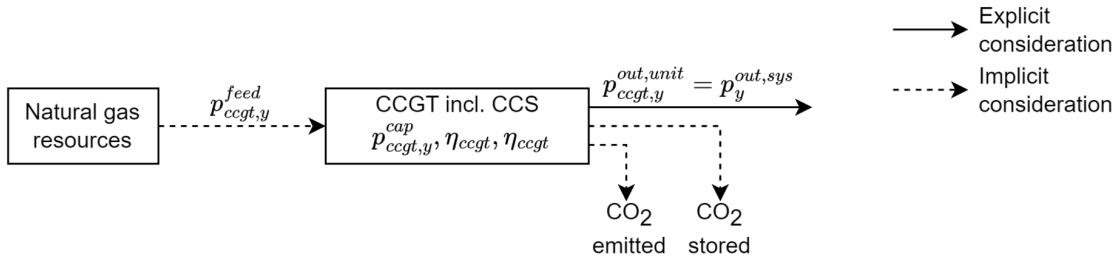

Figure C.20: Scheme - blue electricity generation at location l in country c

The calculation of the cost of ‘blue’ electricity (blue LCOE) follows the same logic as the calculation of the blue LCOH (see (C.25)). However, instead of considering methane steam reformers combined with CCS, a combined-cycle natural gas turbine (CCGT) with CCS technology is included in the analysis for the LCOE calculation. Therefore, except for the change in technologies, the approach remains identical and can be expressed by (C.35)-(C.38).

$$LCOE_{l,y} = \frac{\sum_g^{G^{ccgt}} \left(q_{g,l,y}^{cap} \cdot \left(V_{g,l,y}^{an} \cdot C_{g,l,y}^{capex} + C_{g,l,y}^{fom} \right) \right)}{p_{l,y}^{out,sys}} + \sum_g^{G^{ccgt}} C_{g,l,y}^{vom} + C_{l,y}^{opex,oth} \quad (C.35)$$

$$q_{g,l,y}^{cap} = 1 \quad (C.36)$$

$$p_{l,c,y}^{out,sys} = \sum_g^{G^{ccgt}} \left(q_{g,l,c,y}^{cap} \cdot \eta_{g,y} \cdot V_{g,c}^{avail} \cdot 8760 \right) \quad (C.37)$$

$$C_{l,y}^{opex,oth} = \frac{1}{\sum_g \eta_{g,y}} \cdot \left(C_{l,y}^{feed} + V^{ef} \cdot \left((1 - \eta_y^{co2}) \cdot C_{l,y}^{co2} + \eta_y^{co2} \cdot C_{l,y}^{cts} \right) \right) \quad (C.38)$$

C.3.1.3 Midstream

A distinction is made between the two main transport routes: pipeline and sea. The choice of which is applicable is depending on the available infrastructure for the international transport be-

tween a production and a destination location. Figure C.21 - Figure C.24 illustrate all considered international transport possibilities individually. Each of the supply options is further split into two options with respect to the landing and the transport within the EU. When the volumes land in an EU country that is not the destination country, they are transported via pipeline through the EU. This transport option is represented by Figure (a). However, when the country where the volumes enter the EU is also the destination country, there is no need for pan-European pipeline transportation (Figure (b)). Within each figure, the key parameters at each step of the supply chain are illustrated. The corresponding data are presented in Subsection C.3.2.

Pipeline route

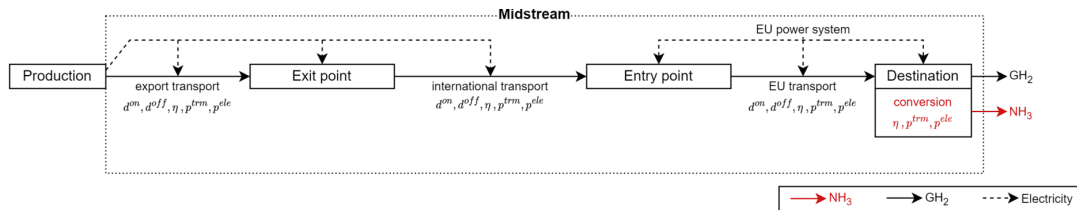

(a) Case: Country of entry point is not country of destination

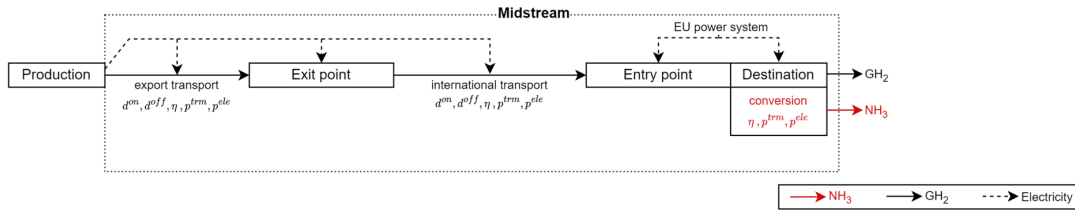

(b) Case: Country of entry point is country of destination

Figure C.21: Scheme - international pipeline transport

Sea route – NH₃

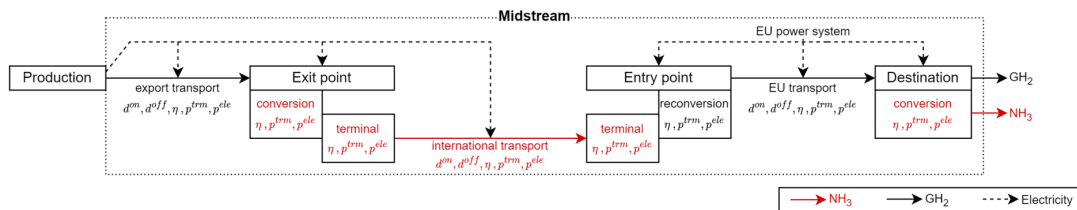

(a) Case: Country of entry point is not country of destination

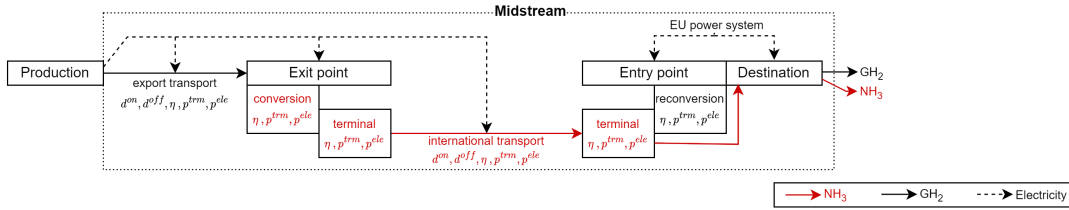

(b) Case: Country of entry point is country of destination

Figure C.22: Scheme - international NH₃ transport

Sea route – LH₂

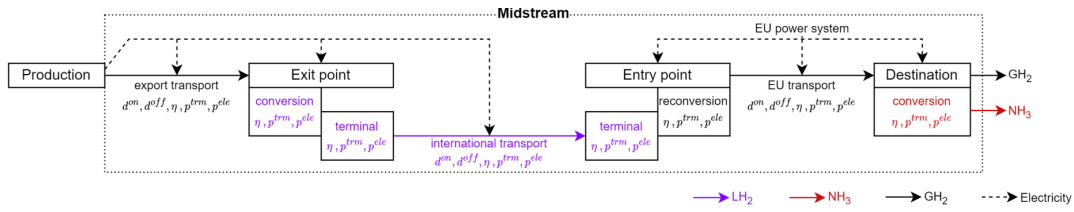

(a) Case: Country of entry point is not country of destination

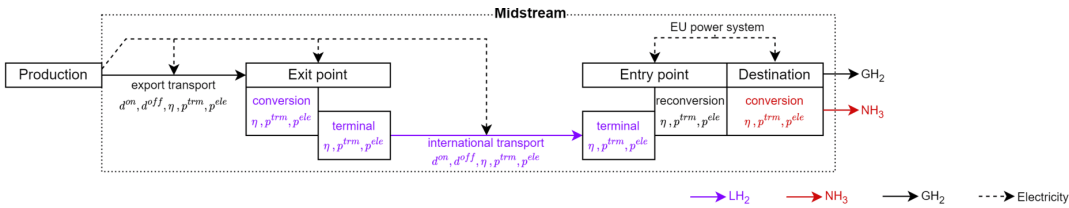

(b) Case: Country of entry point is country of destination

Figure C.23: Scheme - international LH₂ transport

Sea route – LOHC

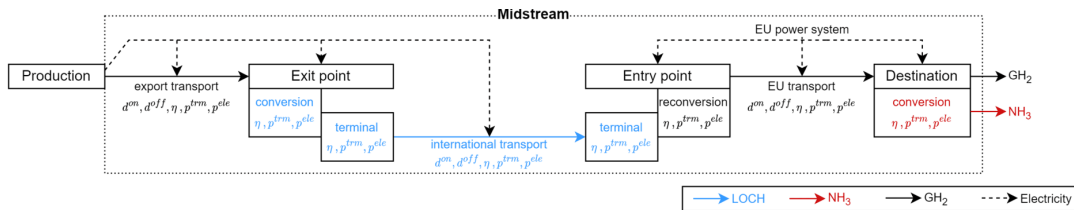

(a) Case: Country of entry point is not country of destination

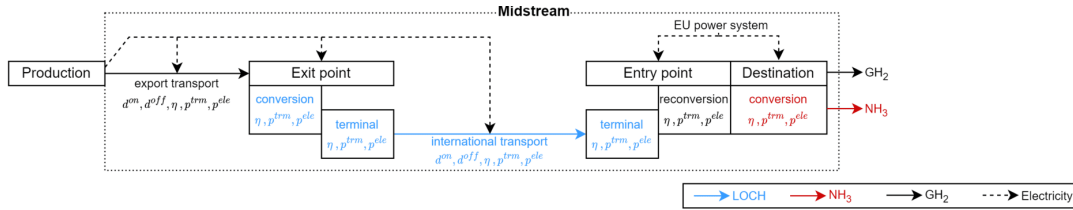

(b) Case: Country of entry point is country of destination

Figure C.24: Scheme - international LOHC transport

C.3.2 Data

C.3.2.1 General data

Parameter	Unit	Value
Lower heating value (LHV) of hydrogen	[kWh/kg _{H2}]	33.33
CO ₂ intensity of natural gas ^a	[t _{CO2} /MWh]	0.2
Costs for water input ^b	[EUR ₂₀₂₀ /t _{H2O}]	0.01

^a Values based on information of Prof. Quaschnig - https://www.volker-quaschnig.de/datserv/CO2-spez/index_e.php
^b (Beswick, Oliveira, and Yan 2021)

Table C.9: General input data

Parameter	2010	2011	2012	2013	2014	2015	2016	2017	2018	2019	2020	2021	2022
[USD/EUR]	1.33	1.39	1.28	1.33	1.33	1.11	1.11	1.13	1.18	1.12	1.14	1.18	1.05
[GBR/EUR]	0.86	0.87	0.81	0.85	0.81	0.73	0.82	0.88	0.89	0.88	0.89	0.89	0.89

Source: (OECD 2023)

Table C.10: Considered exchange rates

2010	2011	2012	2013	2014	2015	2016	2017	2018	2019	2020	2021	2022
2.1%	3.1%	2.6%	1.5%	0.6%	0.1%	0.2%	1.7%	1.9%	1.5%	0.7%	2.9%	9.2%

Source: (ECB 2023); Extraction key: ICP.A.D0.N.000000.4.AVR; Accessed: 25.01.2023

Table C.11: Considered inflation

2030	2050
110.9	164.3

Source: (IEA 2022c); Announced Pledges Scenario. Values for “advanced economies” as local CO₂ price in exporting country would need to be offset by the EU ETS (Carbon Border Adjustment Mechanism - CBAM)

Table C.12: Considered CO₂ price projection [EUR₂₀₂₀/t_{CO2}]

Unit	2030	2050
[EUR ₂₀₂₀ /MWh _{ele}]	37.3	15.0

Source: (GL 2021)

Table C.13: Considered electricity prices in the EU

C.3.2.2 Financing costs - Weighted average costs of capital

The weighted average cost of capital is composed of a risk-free element and a risk premium, which can be further split into a premium linked to risks associated to the country where the project is located (systematic risk) and a premium that is related to the project itself and its technical components (unsystematic risk) (IEA 2021c):

- Risk-free rate: Is set to 0.53%, based on treasury bill rate for the US in year 2020 (OECD 2022)
- Country risk rate: See Table 15, based on Damodaran (2022)
- Technology/project risk rate: Is assumed to be 4% for all cases

Independent of the technology (e.g., green/blue hydrogen production, port infrastructure, etc.), the derived country WACCs are applied to all investments that are linked directly to a single country³. Costs in technologies that are not directly associated to countries (e.g., vessels, international pipeline) are subject to financing costs with 0% country risk. (e.g., as for Canada, Germany and the US).

³ In reality there might be differences with respect to the financing conditions among sectors. However, for the sake of simplification we assume a common risk rate linked to the technology.

Country	Historical						"Pre-crisis"		"Trend"		"Equal"	
	2017	2018	2019	2020	2021	2022	2030	2050	2030	2050	2030	2050
AGO	6.3	9.0	6.4	7.3	6.4	6.7	6.7	6.7	6.3	6.0	0.0	0.0
ALB	5.2	6.2	4.4	4.4	4.5	4.4	4.4	4.4	4.1	3.5	0.0	0.0
ARG	6.3	7.6	8.9	11.6	11.9	10.8	10.8	10.8	13.3	16.3	0.0	0.0
AUS	0.0	0.0	0.0	0.0	0.0	0.0	0.0	0.0	0.0	0.0	0.0	0.0
BGD	4.1	5.0	3.6	3.5	3.6	3.5	3.5	3.5	3.3	2.8	0.0	0.0
BLZ	7.5	9.0	6.4	9.7	9.9	8.7	8.7	8.7	10.3	11.4	0.0	0.0
BRA	3.5	4.2	3.0	2.9	3.0	2.9	2.9	2.9	2.8	2.3	0.0	0.0
CAN	0.0	0.0	0.0	0.0	0.0	0.0	0.0	0.0	0.0	0.0	0.0	0.0
CHL	0.7	1.0	0.7	0.7	0.7	0.7	0.7	0.7	0.7	0.6	0.0	0.0
CHN	0.8	1.0	0.7	0.7	0.7	0.7	0.7	0.7	0.6	0.5	0.0	0.0
CIV	4.1	5.0	3.6	3.5	3.6	3.5	3.5	3.5	3.3	2.8	0.0	0.0
CMR	6.3	7.6	5.4	5.3	5.4	5.4	5.4	5.4	5.0	4.2	0.0	0.0
COL	2.2	2.6	1.9	1.8	1.9	1.9	1.9	1.9	1.7	1.5	0.0	0.0
CUB	10.4	12.5	8.9	8.7	11.9	9.8	9.8	9.8	11.6	11.5	0.0	0.0
DZA	7.5	7.6	6.4	8.7	6.4	7.2	7.2	7.2	6.4	6.2	0.0	0.0
ECU	7.5	9.0	6.4	9.7	9.9	8.7	8.7	8.7	10.3	11.4	0.0	0.0
EGY	7.5	9.0	5.4	5.3	5.4	5.4	5.4	5.4	4.7	3.1	0.0	0.0
GBR	0.6	0.7	0.5	0.6	0.6	0.6	0.6	0.6	0.6	0.6	0.0	0.0
GEO	3.5	4.2	3.0	2.9	3.0	2.9	2.9	2.9	2.8	2.3	0.0	0.0
GHA	7.5	9.0	6.4	6.3	6.4	6.4	6.4	6.4	6.0	5.0	0.0	0.0
GIN	10.4	16.7	9.9	11.6	8.9	10.1	10.1	10.1	8.3	6.7	0.0	0.0
GMB	10.4	9.0	6.4	6.3	5.4	6.1	6.1	6.1	4.3	1.7	0.0	0.0
GTM	2.9	3.5	2.5	2.4	2.5	2.5	2.5	2.5	2.3	1.9	0.0	0.0
GUY	4.1	6.2	6.4	5.3	4.5	5.4	5.4	5.4	4.5	4.4	0.0	0.0
HND	5.2	6.2	4.4	4.4	4.5	4.4	4.4	4.4	4.1	3.5	0.0	0.0
HTI	8.6	12.5	8.9	11.6	9.9	10.1	10.1	10.1	10.1	10.4	0.0	0.0
IRN	2.2	4.2	6.4	8.7	6.4	7.2	7.2	7.2	7.8	10.4	0.0	0.0
IRQ	8.6	10.4	7.4	7.3	7.4	7.4	7.4	7.4	6.9	5.8	0.0	0.0
ISR	0.8	1.0	0.7	0.7	0.7	0.7	0.7	0.7	0.6	0.5	0.0	0.0
JOR	5.2	6.2	4.4	4.4	4.5	4.4	4.4	4.4	4.1	3.5	0.0	0.0
KEN	5.2	7.6	5.4	5.3	5.4	5.4	5.4	5.4	5.3	4.9	0.0	0.0
KHM	6.3	7.6	5.4	5.3	5.4	5.4	5.4	5.4	5.0	4.2	0.0	0.0
LBN	7.5	9.0	8.9	19.2	20.3	16.1	16.1	16.1	23.5	30.7	0.0	0.0
LBY	8.6	6.2	3.0	8.7	4.5	5.4	5.4	5.4	4.0	2.8	0.0	0.0
LKA	5.2	6.2	5.4	7.3	8.9	7.2	7.2	7.2	9.6	11.3	0.0	0.0
MAR	2.9	3.5	2.5	2.4	2.5	2.5	2.5	2.5	2.3	1.9	0.0	0.0
MDG	6.3	9.0	5.4	6.3	6.4	6.1	6.1	6.1	6.2	5.7	0.0	0.0
MEX	1.4	1.7	1.2	1.5	1.6	1.4	1.4	1.4	1.6	1.7	0.0	0.0
MNE	5.2	6.2	4.4	4.4	4.5	4.4	4.4	4.4	4.1	3.5	0.0	0.0
MOZ	11.5	13.9	8.9	8.7	8.9	8.8	8.8	8.8	7.9	5.8	0.0	0.0
NAM	2.9	3.5	3.0	3.5	3.6	3.3	3.3	3.3	3.7	4.0	0.0	0.0
NGA	6.3	7.6	5.4	5.3	5.4	5.4	5.4	5.4	5.0	4.2	0.0	0.0
NIC	6.3	7.6	5.4	6.3	6.4	6.1	6.1	6.1	6.3	6.1	0.0	0.0
NOR	0.0	0.0	0.0	0.0	0.0	0.0	0.0	0.0	0.0	0.0	0.0	0.0
NZL	0.0	0.0	0.0	0.0	0.0	0.0	0.0	0.0	0.0	0.0	0.0	0.0
OMN	2.2	3.1	2.5	3.5	3.6	3.2	3.2	3.2	3.8	4.5	0.0	0.0
PAK	7.5	9.0	6.4	6.3	6.4	6.4	6.4	6.4	6.0	5.0	0.0	0.0
PAN	2.2	2.6	1.6	1.5	1.9	1.7	1.7	1.7	1.7	1.4	0.0	0.0
PER	1.4	1.7	1.2	1.2	1.6	1.3	1.3	1.3	1.5	1.5	0.0	0.0
QAT	0.7	0.8	0.6	0.6	0.6	0.6	0.6	0.6	0.6	0.5	0.0	0.0
SAU	0.8	1.0	0.7	0.7	0.7	0.7	0.7	0.7	0.6	0.5	0.0	0.0
SDN	20.2	22.1	16.5	19.2	20.3	18.7	18.7	18.7	20.0	19.4	0.0	0.0
SEN	4.1	5.0	3.6	3.5	3.6	3.5	3.5	3.5	3.3	2.8	0.0	0.0
SLV	8.6	10.4	6.4	6.3	7.4	6.7	6.7	6.7	6.7	5.4	0.0	0.0
SOM	13.8	16.7	11.8	11.6	11.9	11.8	11.8	11.8	11.0	9.2	0.0	0.0
TUN	5.2	7.6	5.4	5.3	7.4	6.1	6.1	6.1	7.5	8.0	0.0	0.0
TUR	2.9	5.0	4.4	5.3	5.4	5.1	5.1	5.1	6.0	7.1	0.0	0.0
TZA	7.5	6.2	4.4	5.3	5.4	5.1	5.1	5.1	4.9	3.9	0.0	0.0
UKR	10.4	10.4	7.4	6.3	6.4	6.7	6.7	6.7	5.3	2.9	0.0	0.0
URY	2.2	2.6	4.4	1.8	1.9	2.7	2.7	2.7	1.8	1.5	0.0	0.0
USA	0.0	0.0	0.0	0.0	0.0	0.0	0.0	0.0	0.0	0.0	0.0	0.0
VEN	11.5	22.1	17.7	19.2	20.3	19.1	19.1	19.1	21.7	24.7	0.0	0.0
VNM	5.2	5.0	3.6	3.5	3.6	3.5	3.5	3.5	3.1	2.1	0.0	0.0
YEM	20.2	22.1	11.8	19.2	11.9	14.3	14.3	14.3	10.2	6.3	0.0	0.0
ZAF	2.5	3.1	2.2	2.9	3.0	2.7	2.7	2.7	3.0	3.2	0.0	0.0

Source: Historical values taken from <https://pages.stern.nyu.edu/~adamodar/pc/datasets/> (Damodaran 2022), Accessed: 16.10.2022. "Pre-crisis scenario": Continuation of pre-crisis risk levels (average of 2019-2021); "Trend scenario": Follows the trend line from 2017 to 2021. To avoid unrealistic values in the long-term, the trend is decelerated by a smoothing factor of 0.1. Year 2022 is excluded as we assume that the effects of the crisis are only temporary and vanish again shortly.

Table C.14: Country risk

C.3.2.3 Upstream

Production of green hydrogen

Land eligibility

Not all areas in the exporting countries are suited to exploit renewable resources and to produce green hydrogen. There are many reasons why areas are not eligible such as restrictions on land use aspects, water scarcity and terrain conditions. Consequently, to assess site-specific renewable potentials that build the basis for the calculation of the LCOH, first one needs to identify the areas within the exporting country that are eligible for the exploitation of renewable energies. Therefore, the land of every grid cell (Figure 4.4) that is in the considered geographical scope (e.g., potential export country, no more than 500 km from available export point) is assessed with respect to its suitability for the production of green hydrogen. In this respect a list of conditions is defined that needs to be respected (Table C.15)⁴. Based on the defined criteria, we apply the GLAES model⁵ to identify eligible area within each cell. The model uses highly resolved geospatial data, combines the information, and assesses them with respect to the exclusion criteria. For every assessment criterion, one data layer is fed into the model for which the excluded areas are identified. Thereafter, the individual layers are placed on top of each other. Only areas that are not excluded in either of the layers are identified as eligible for the exploitation of renewables and the production of green hydrogen. Every grid cell is assessed separately with respect to its suitability for wind turbines and solar PV plants. Moreover, to account for additional constraints, e.g., due to buffer spacing, grid cells whose eligible area is less than 5% of the total cell area are excluded.

⁴ Criteria based on (Bosch, Staffell, and A. D. Hawkes 2017; IEE 2022; Ryberg, Robinius, and Stolten 2018)

⁵ (Ryberg, Robinius, and Stolten 2018); GitHub repository: <https://github.com/FZJ-IEK3-VSA/glaes>

Criteria	Description	Exclusion / Inclusion		Data source
		PV	Wind	
Water stress	Water is a key element in the production of both blue and green hydrogen. As many regions of the world are already subject to water stress or are expected to be subject to water stress in the future, the relevant areas are excluded.	Exclusion: Water stress levels higher than 'Medium-high (20%-40%)' in the long-terms (2040)		(WRI 2019)
Water proximity	However, desalination offers to refine seawater for the use in hydrogen production. Therefore, despite potential water stress, we consider areas as sustainable for the production of hydrogen if they are in proximity to coastlines.	Inclusion: < 50 km		(ESA 2016)
Land use	Sustainable hydrogen production cannot compete with land that already serves other (important) purposes. Therefore, these areas are excluded from the evaluation.	Exclusion: Agriculture (10-40) ; Forest (50-100, 160, 170); Wetland (180); Settlement (190); Water&Snow (210,220); Other (0, 140)		(ESA 2017)
Terrain slope	Industrial scale renewable energy installation in mountainous areas can be difficult and requires a case-by-case assessment. For simplicity, steep terrain conditions are therefore excluded	Exclusion: > 5 Degree		(EROS 2018)
Altitude	Wind conditions at high altitudes can differ from those at lower altitudes. These special conditions require additional project feasibility requirements. Therefore, in addition to terrain steepness, areas at high altitude are also excluded from the analysis of the wind potential.	-	Exclusion: > 600m ^a	(EROS 2018)
Settlement distance	The "not in my backyard" phenomenon can already be widely observed. Therefore, areas that are close to regions with moderate urban development are excluded.	Exclusion: > 20% of urban coverage		(JRC 2022)
Protected areas	Sustainability also means respecting protected areas. Therefore, corresponding areas are excluded.	Exclusion: All protected areas		(ESMAP 2020)

^a Area above 600m are considered mountainous (EEA 2009). As installations of wind turbines in mountainous regions are much more complex and require case-by-case analyses and as the prevailing wind conditions are affected by the altitude and the terrain, which is not captured in the applied methodology and the underlying data, mountainous regions are excluded from the analysis.

Table C.15: Land exclusion criteria for the production of hydrogen

Capacity factor

Hourly capacity factors for PV plants and wind turbines are one input of the optimisation of the hydrogen production costs (Subsection C.3.1.2). We derive the hourly profiles in five steps: (1) determining the long-term renewable resources for the eligible areas of each grid cell, (2) extracting the hourly profiles for the reference year, (3) scaling the hourly profiles to the annual long-term values from the first step, (4) converting hourly renewable profiles to corresponding hourly capacity factors, and (5) scaling obtained hourly capacity factor profiles for future years based on their projected evolution. In the following, the five steps are described in more detail:

Extraction of annual long-term renewable resources for the identified eligible areas of each grid cell

Annual long-term renewable conditions are identified for all areas within each grid cell that are eligible for renewable energy installations. While we take long-term data on solar resources from the Global Solar Atlas (World Bank 2020b), we derive data for the wind conditions from the Global

Wind Atlas (GWA) (DTU 2022). For the assessment of the wind conditions, the data for the annual average wind speeds at a hub height of 100 m⁶ are used from the GWA2⁷. The analysis of the solar data is based on the average daily global horizontal irradiance (GHI) from the Global Solar Atlas. After modifying the GLAES model slightly, we extract the long-term natural resource values for all eligible areas. As the conditions of renewable energy resources within one cell might still be diverse with some showing good conditions and others showing worse ones, we only consider areas with the highest natural resources per cell. We consider only the areas with the highest potential sufficient to install 5 GW of each of the two renewable technologies, as these are likely to be selected for renewable energy installation⁸. We then average the annual long-term values of these areas.

Extracting hourly natural resources profiles for the reference year

The temporal relationships between solar and wind resources are important to obtain the system configurations that minimise the cost of hydrogen production. Therefore, for each grid cell, the corresponding hourly profiles are extracted from ERA5 reanalysis data (ECMWF 2022) for the chosen reference year 2016.

Scaling hourly profiles to the long-term values

The hourly profiles cover only the solar and wind conditions of the reference year. However, as weather conditions vary among different years for the same location, the choice of the reference year affects the calculation of the green hydrogen production costs and hence, the competitiveness of the analysed location. To reduce this bias, we scale the hourly profiles according to the determined long-term values. For the scaling of the profiles, the approach presented by Brändle, Schönfisch, and Schulte (2021) which uses an exponential scaling parameter is applied. While the aforementioned authors use the approach to scale capacity factors of renewable energies, within our study we use it to treat wind speeds and data on solar irradiance. The idea of the approach is to scale the hourly profiles in such a way so that their sum is equal to the annual long-term average. To derive the exponential scaling factor leading to the annual long-term mean values, we formulate a nonlinear optimisation problem (C.40)-(C.41):

$$\min \quad \omega \tag{C.39}$$

⁶ Our analysis showed that a hub height of 100 m is a good generic approximation to study wind turbines at a global scale. This is also aligned to other studies such as the one from Bosch, Staffell, and A. D. Hawkes (2017) and McKenna et al. (2022)

⁷ While there is already a new version of the Global Wind Atlas available GWA3, we still use the GWA2 as evaluations showed that its bias-correction is better at a global scale (Gruber et al. 2022). Only for locations that are not covered by the GWA2 but that are part of the GWA3, the data of the newer GWA are used. As this affects only offshore wind locations that are greatly distant from the shore, which did not show a meaningful role in our study, the impact of the mixed data should not influence our results. GWA2: https://sil01.sciencedata.dk/themes/deic_theme_oc7/apps/files_sharing/public.php?t=cf5a325eb87ca25b79aedd8afcaf570&&path=%252FGWA2.1; Accessed: 14.07.2022

⁸ The 5 GW is an assumption and is chosen to consider areas of a size that is sufficiently large to exploit renewable resources at industrial scale. For the determination on the required surface, a power density of 5 MW/km² for wind turbines and 170 MW/km² for solar PV plants is considered (Ruiz et al. 2019)

$$\omega = \omega^{up} + \omega^{down} \quad (C.40)$$

$$V_{l,r,y}^{longterm} = \frac{\sum_t^{Tyear} V_{l,r,t}^{hourly} \sigma_{l,r}}{n(Tyear)} + \omega^{up} - \omega^{down} \quad (C.41)$$

Where ω is the sum of upward (ω^{up}) and downward (ω^{down}) variables that is targeted to be minimised, $V^{longterm}$ the annual long-term value, V^{hourly} the hourly profile value and $\sigma_{l,r,y}$ the exponential scaling factor of resource r at location l and year y . The scaling is then obtained by (C.42).

$$V_{l,r,t}^{hourly,scaled} = \left(V_{l,r,t}^{hourly} \right)^{\sigma_{l,r}} \quad (C.42)$$

Converting hourly resource profiles to hourly capacity factors

The calculation of the production costs of green hydrogen requires the hourly capacity factors for both solar PV plants and wind turbines. We therefore convert the derived hourly resource profiles to hourly capacity factors. As the underlying conversion from primary energy to electricity differ between the two technologies, we apply two different approaches:

I Deriving capacity factors for wind turbines:

The conversion of wind speeds to generated electricity is described by the power curve of wind turbines. While power curves are wind turbine specific, there is a pattern among different types of wind turbines. They can be grouped in three main categories, which describe their suitability for different wind conditions. The three categories are: (I) high wind, (II) medium wind and (III) low wind regions.⁹ To cover the differences among the three types of wind turbines, each group is represented through one individual power curve. The curves are then assigned to each cell based on their annual average wind speed determined above. Moreover, the power curve of a single wind turbine is different from the one that groups various turbines within a wind farm. As we study the production of green hydrogen at an industrial scale, where electricity generation from wind energy consists of several wind turbines, we convert the power curve of a single turbine to one that represents the behaviour of a wind farm. For this purpose, we use the approach presented by Staffell and Pfenninger (2016). Figure C.25 shows the considered power curves for the single turbines and for the corresponding wind farms. In addition, we correct the resulting profiles by a loss factor of 10% to account for, among other factors, electrical losses and turbine availabilities¹⁰.

⁹ Within each group, further distinctions are made such as prevailing wind turbulence conditions. However, these are not further considered in our analysis.

¹⁰ According to Staffell and Pfenninger (2016) reanalysis show weaknesses in reproducing historical profiles of wind fleets. One of the stated reasons is that they do not account for local relief such as the terrain conditions, tree cover and buildings. This causes an error that often overestimates the turbine output. Therefore, the authors suggest correcting for the bias and to calibrate the wind turbine outputs to historical values. However, such a correction is difficult at global level due to missing data. Moreover, as we consider offgrid systems that are linked to specific locations, we do not believe that a correction of the entire fleet as proposed by the authors gives more accurate results. Furthermore, Staffell and Pfenninger disregards from effects that occur at a wind park level such as aspects linked to the availability of the turbines which also causes an overestimation of the results. Therefore, we correct for all different kind of losses/reduction in power generation in a simplified

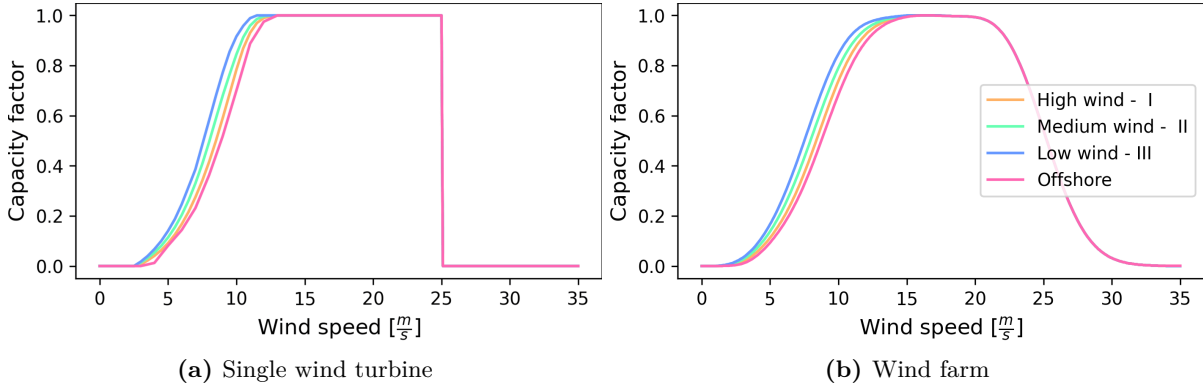

Figure C.25: Considered power curves of wind turbines¹¹

II Deriving capacity factors for solar PV plants:

We use the GSEE package¹² by Pfenninger and Staffell (2016) to convert the global horizontal irradiance (GHI) to electricity generated. However, in addition to the GHI values, supplementary data inputs are required for the calculation. Therefore, we decompose the GHI into its two parts: diffuse horizontal irradiance (DHI) and direct normal irradiance (DNI). The DNI is derived using the PVlib python package¹³. Its calculation also requires information about the hourly ambient temperature and the altitude of the plant. While we extract the ambient temperature from ERA5, similar to how the data of the hourly profiles of wind speeds and global horizontal irradiances are extracted, data on the altitude are obtained in the same way as the annual long-term resource values. From the derived hourly DNI profile one can then calculate the DHI profile by (C.43).

$$DHI_{l,t} = GHI_{l,t} - DNI_{l,t} \cdot \cos(\theta_{l,t}) \quad (\text{C.43})$$

Where $\theta_{l,t}$ is the solar zenith, which is the angle between the DNI and the perpendicular line to the surface of the ground at location l and hour t . Both the tilted and the azimuth angle are inputs to the GSEE model. While the azimuth of PV systems is assumed to be perfectly aligned with the equator, the optimal tilt angle of the systems depends on the latitude of the installation site. Corresponding data are extracted from the Global Solar Atlas, similar to the extraction of the daily GHI. In addition, an initial loss factor of 10%¹⁴ is considered to account for, among other factors, ohmic losses and inverter efficiencies.

III Scaling of hourly capacity factors to their expected future values

According to IRENA (2019a) and IRENA (2019b), capacity factors of both solar PV plants and

manner by a correction factor that is based on (Lee and Fields 2021).

¹¹ Wind turbines: High wind – Vestas V112, 3.3MW; Medium wind – Vestas V136, 4.2MW; Low wind – GE G2 3.2-130, 3.2MW, Offshore – Vestas V164, 8MW

¹² GitHub repository: <https://github.com/renewables-ninja/gsee>

¹³ Irradiance.disc function

¹⁴ Is reduced until 2050 to consider technical improvements as explained in the next paragraph

wind turbines will improve in the coming decades due to technological development. Therefore, when assessing the electricity generation in future years, the expected developments are considered through an upscaling of the derived profiles to future projections. The upscaling follows the approach presented by expressions (C.40) to (C.42). We take the underlying data for the scaling of future values for onshore wind and for offshore wind from IRENA (2019a). PV systems are assumed to decrease losses from 10% to 8% by 2050 (Sark, Reich, and Müller 2012), which increases their output¹⁵. Figure C.26 shows how today's capacity factors evolve for the three technologies assessed.

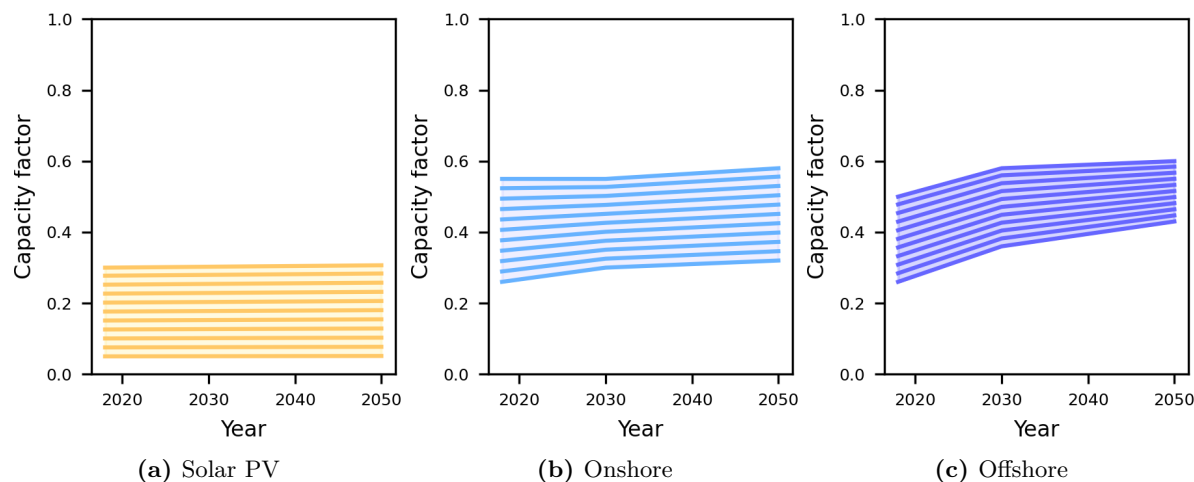

Figure C.26: Considered evolution of capacity factors due to technological developments

Cost data

The costs for renewable energies differ in the individual countries and regions of the world¹⁶. To account for these differences in the calculation of hydrogen production costs, we distinguish between the costs of PV plants and wind power plants in different regions. The approach to calculate the decline in renewable energy costs is based on Brändle, Schönfish, and Schulte (2021). However, while regional cost projections exist such as in GL (2021), we only take the data for 2020 from that source and derive the future projections ourselves. This offers the advantage that scenarios can be created flexibly, and one does not have to rely on values from third parties whose underlying assumptions are less transparent or whose data is outdated. We use learning rates to derive expected cost declines due to learning and scaling effects. They present the percentage decrease in cost when the cumulative installed capacity doubles. The approach is also referred to as the one-factor experience curve that is widely used for the projection of renewable energy costs (Brändle, Schönfish, and Schulte 2021). The relation between the evolution of costs, the accumulated installed capacities, and the learning rate is expressed by C.44.

$$C_{r,y}(x_{r,y}) = C_{r,0}(x_{r,0}) \cdot \left(\frac{x_{r,y}}{x_{r,0}} \right)^{-\varphi_r} \quad (\text{C.44})$$

¹⁵ Which is equivalent in the increase of the performance ratio from 90% to 92% (Sark, Reich, and Müller 2012)

¹⁶ Due to differences in labour costs and other factors (IRENA 2021)

Where C_r is the cost of technology r , x_r the corresponding accumulated installed capacity and φ_r the learning rate. While 0 represents the reference year of the data (2020), y is the year for which the costs are calculated. We take the learning rates of the three technologies from IRENA (2020c). However, in addition to the latter values, which represent the base case, a lower and a higher sensitivity are introduced, which differ from it by $\pm 25\%$. All considered learning rates are shown in Table C.16.

Category	pessimistic	base	optimistic
PV	26	34	43
Onshore	13	17	21
Offshore	7	9	11

Source: Based on IRENA (2020c)

Table C.16: Learning rates of renewable energies [%]

We obtain the expected accumulated installed capacity of each technology in future years (Table C.17), through the historical evolution of installed renewable capacities (IRENA 2022c), their lifetime (Table C.19) and their future projections (IRENA 2020a)¹⁷.

Category	Installed capacity			Installed capacity - cumulated	
	2021 ^a	2030 ^b	2050 ^b	2030 ^b	2050 ^b
Solar PV	843	4937	14036	4943	16244
Wind onshore	769	2446	6172	2509	7500
Wind offshore	56	660	2002	660	2259

^a (IRENA 2022c)

^b (IRENA 2020a)

Table C.17: Considered capacity evolution of variable renewables [GW]

The benchmark in Figure C.27 shows that the derived costs projects are aligned to the projections of other studies. Moreover, as operating expenses are expressed as a percentage of capital expenditures (Table C.19), a decrease in the latter ones also results in reduced operating costs. Consequently, the learning effects influence both the capex and the opex of the technologies. The graphs in Figure C.27c illustrate the evolution of costs and only represent offshore wind turbines with fixed foundation suited for shallow waters (< 50 m)¹⁸. Floating turbines that are suited for deeper waters are still in a pioneering stage. As empirical learning rates are less meaningful due to limited experiences in past decades, we use projections of capital expenditures provided by NREL (2022a).¹⁹

For electrolyser systems we do not distinguish between regions with respect to the cost and use the projections provided by the (IEA 2019d; IRENA 2019b) (see Table C.18). While ‘high’ and ‘low’

¹⁷ “1.5 Degree Celsius Scenario”; Data download from: <https://www.irena.org/Data/View-data-by-topic/Energy-Transition/REmap-Energy-Generation-and-Capacity>, Accessed: 23.01.2023

¹⁸ Information about the water depth of each offshore grid cell taken from Bank (2021)

¹⁹ Average of considered classes (Class 8 – Class 14); Base case: ‘Moderate’ ; Pessimistic : ‘Conservative’; Optimistic: ‘Advanced’; Regional differences in costs are introduced following the distribution given in GL (2021)

²⁰ DNV GL 2021: (GL 2021); IEA WEO 2022: (IEA 2022c); IRENA: (IRENA 2019a; IRENA 2019b); EU Ref: (E3-Modelling 2021)

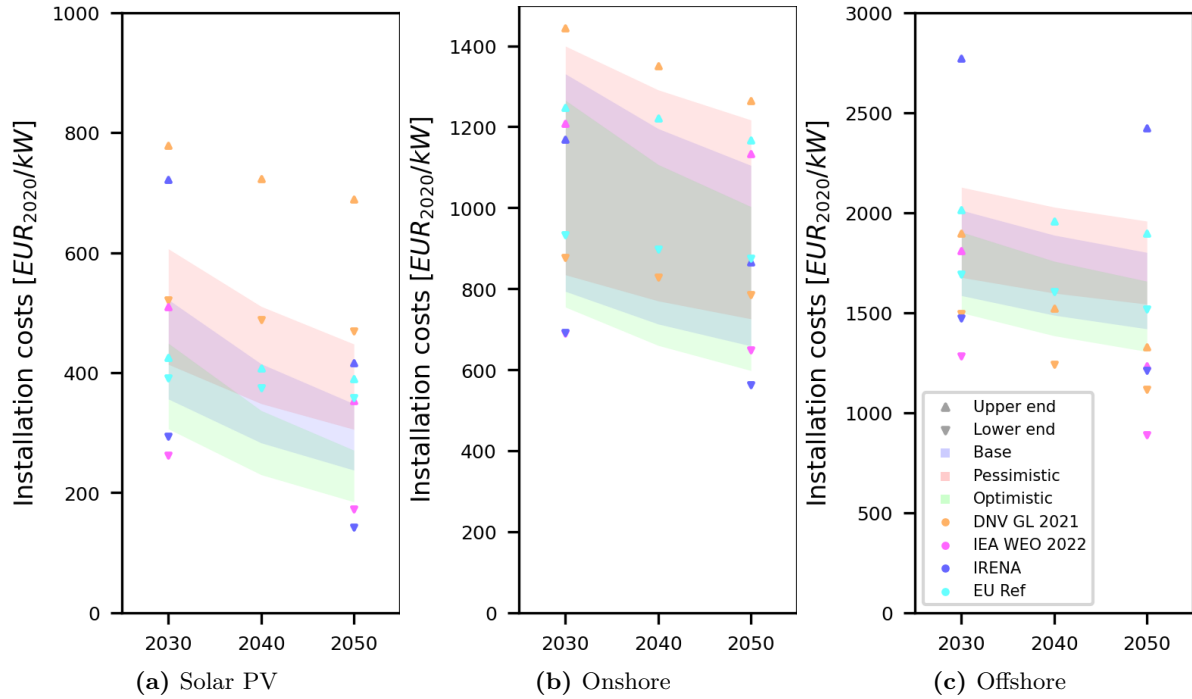

Figure C.27: Benchmark of installation costs of renewables²⁰

represent the lower and upper boundary of the reported costs respectively, the ‘base case’ value is their average

Parameter	Unit	2030			2050		
		pessimistic	base	optimistic	pessimistic	base	optimistic
Water demand	[lt _{H2O} /kg _{H2}]	9					
Alkaline electrolyser							
Capex	[EUR ₂₀₂₀ /kW _{ele}]	784	576	369	645	415	184
Efficiency	[%]	65	68	71	70	75	80
Lifetime	[a]	20					
Opex	[% of Capex]	2					
Polymer electrolyte membrane electrolyser							
Capex	[EUR ₂₀₂₀ /kW _{ele}]	1383	991	599	830	507	184
Efficiency	[%]	63	66	68	67	71	74
Lifetime	[a]	7					
Opex	[% of Capex]	2					

Source: Based on [iea_iaea_2019](#); IEA (2019c)

Table C.18: Techno-economic parameters – electrolyser systems

Category	Unit	PV	Onshore	Offshore
Lifetime	[a]	25	25	25
Opex	[% of Capex]	2	2.5	2.5

Source: Based on Brändle, Schönfish, and Schulte (2021) and IEA (2022c)

Table C.19: Techno-economic parameters – renewable energies

Parameter	Unit	2030	2050
Capex ^a	[EUR ₂₀₂₀ /kWh]	116	61
Opex fix ^b	[EUR ₂₀₂₀ /kWh]		5.03
Round-trip efficiency ^b	[%]		86
Lifetime ^b	[a]		13

^a Based on (GL 2021)

^b IEA (2019d)

Table C.20: Techno-economic parameters – battery systems

Production of blue hydrogen

The techno-economic data linked to the production of blue hydrogen are shown in Table C.21 and Table C.22. Similar to electrolyser systems, the costs for blue technologies are not differentiated by region. The cost of the natural gas feedstock is determined by their break-even costs. We take corresponding data from the Global Gas Model (Egging and Holz 2019).²¹

Parameter	Unit	2030	2050
Capex ^a	[EUR ₂₀₂₀ /kW _{H2}]	1254	1180
Opex ^a	[% of Capex]		3
Lifetime ^a	[a]		25
Efficiency ^a	[%]		69
Availability ^a	[%]		95
CO ₂ capture rate ^a	[%]		90
Water demand ^b	[lt _{H2O} /kg _{H2}]		15.5

^a IEA (2019d)

^b (Council 2021), Average of 13-18 lt_{H2O}/kg_{H2}

Table C.21: Techno-economic parameters – steam methane reforming incl. CCS

Country	2030			2050		
	pessimistic	base	optimistic	pessimistic	base	optimistic
DZA	12.4	10.1	7.8	9.7	7.9	6.1
EGY	12.6	10.2	7.9	9.9	8.0	6.2
GBR	16.2	13.1	10.1	13.0	10.5	8.1
LBY	12.6	10.2	7.9	9.9	8.0	6.2
NGA	11.8	9.6	7.4	9.3	7.5	5.8
NOR	12.1	9.8	7.6	6.9	5.6	4.3
PER	13.9	11.3	8.7	14.2	11.5	8.9
QAT	10.8	8.8	6.7	10.5	8.6	6.6
USA	12.2	9.9	7.6	13.1	10.6	8.2

Source: Based on Egging and Holz (2019); Optimistic: R2 values, Pessimistic: R3 values, Base: Average of R2 and R3 values

Table C.22: Natural gas - break-even costs [EUR₂₀₂₀/MWh_{LHV}]

Parameter	Unit	2030	2050
Capex	[EUR ₂₀₂₀ /kW _{H2}]	1725	1592
Opex	[% of Capex]		3
Lifetime	[a]		30
Efficiency	[%]	46	49
Availability	[%]		90
CO ₂ capture rate	[%]		90

Source: Based on E3-Modelling (2021)

Table C.23: Techno-economic parameters – combined-cycle gas turbine incl. CCS

²¹ 'Sustainable Development Scenario'- SDS data; Model repository: <https://www.ntnu.edu/iot/energy/energy-models-hub/ggm>, Accessed: 24.10.2022

pessimistic	base	optimistic
12.6	7.7	2.7

Source: (Budinis et al. 2018); Stated costs contain both the costs for the transport and storage of CO₂; Storage: Only “Depleted oil and gas field

Table C.24: Considered CO₂ transport and storage costs [EUR₂₀₂₀/tCO₂]

C.3.2.4 Midstream

Transport

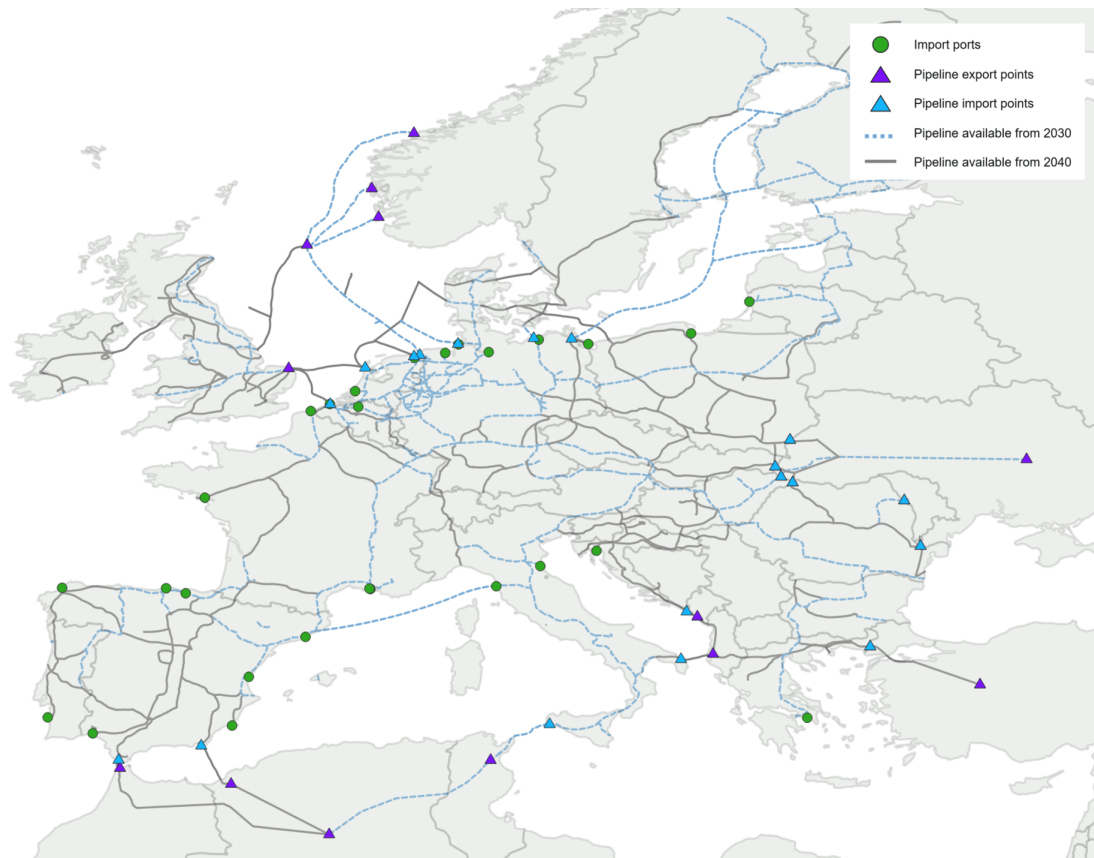

Figure C.28: Overview of the pipeline network in and around the EU incl. relevant nodes²²

Distances

The consideration of the high geospatial resolution within the analysis requires the determination of different distances between the individual nodes of the supply chains. The approach to deriving these distances depends on the transport elements. Moreover, it is stated that a distinction is made between onshore and offshore pipeline elements. As underwater pipelines are more expensive, a premium of 25% (Gerwen, Eijgelaar, and Bosma 2019) is added.

²² Data extracted from virtual map. The virtual map was already slightly updated compared to the information given in the April report - <https://ehb.eu/maps/202205/index.html#5/50.185/11.454>; Accessed: 10.11.2022

I *Export transport*

We apply Geographical Information System (GIS) tools to calculate the transport distance of newly built hydrogen pipelines within the exporting country. The reference points for the calculation are on the one hand the centroid location of each grid cell and on the other hand the export points, which can be either a pipeline connection to the EU or an international deep-water port. However, to account for more realistic line courses we correct the straight line distance between the two points by a detour factor of 1.4 (Reuß et al. 2019). Moreover, the production of blue hydrogen is assumed to take place directly at the export point. Consequently, there is no transport need in this part of the supply chain.²³

II *International seaborne transport*

We determine the distances between all export and all import ports using Eurostat/searoute²⁴. The tool enables the calculation of optimal sea routes for any pair of start and destination locations. Although the model allows for restrictions on sea routes, such as bypassing the Suez Canal, we apply the model without restrictions.

III *International and EU pipeline transport*

The available pipeline routes to and within the EU are based on the "European hydrogen backbone" study (Guidehouse 2022)²⁵. The pipeline network including all considered pan-EU as well as all import pipelines are shown in Figure C.28. Information about when they are available to transport GH₂ are indicated in the figure. We determine the optimal transport routes between each export-import point pair (international pipeline transport) as well as for all import-destination point pairs (EU transport) using the NetworkX package in Python²⁶.

Techno-economic parameter

Symbol	Description	Unit
Variables		
s	Hydrogen volume transport via supply chain	[MWh _{H2}]
$c^{conv,dest}$	Cost: conversion at destination location	[EUR/MWh _{H2delivered}]
$c^{trans,eu}$	Cost: transport within the EU	[EUR/MWh _{H2delivered}]
$c^{conv,entry}$	Cost: conversion at entry point	[EUR/MWh _{H2delivered}]
$c^{term,entry}$	Cost: handling and storage at entry point (Terminal)	[EUR/MWh _{H2delivered}]
$c^{trans,int}$	Cost: international transport between exit and entry point	[EUR/MWh _{H2delivered}]
$c^{term,exit}$	Cost: handling and storage at exit point (Terminal)	[EUR/MWh _{H2delivered}]
$c^{conv,exit}$	Cost: conversion at exit point	[EUR/MWh _{H2delivered}]
$c^{trans,exp}$	Cost: transport in export country	[EUR/MWh _{H2delivered}]
c^{prod}	Cost: hydrogen production	[EUR/MWh _{H2delivered}]
$r^{conv,dest}$	Factor: volume correction at destination location outlet	[#]
$r^{trans,eu}$	Factor: volume correction at EU transport outlet	[#]
$r^{conv,entry}$	Factor: volume correction at entry point conversion outlet	[#]
$r^{term,entry}$	Factor: volume correction at entry point terminal outlet	[#]

²³ It is assumed that the transportation costs for the captured CO₂ already cover all required expenses for storing the volumes at suitable sites.

²⁴ Github repository: <https://github.com/eurostat/searoute>; Accessed: 02.01.2021

²⁵ Data extracted from virtual map. The virtual map was already slightly updated compared to the information given in the April report - <https://ehb.eu/maps/202205/index.html#5/50.185/11.454>; Accessed: 10.11.2022

²⁶ Github repository: <https://github.com/networkx/networkx>; Accessed: 11.11.2022

Symbol	Description	Unit
$r^{trans,int}$	Factor: volume correction at international transport outlet	[#]
$r^{conv,exit}$	Factor: volume correction at exit point conversion outlet	[#]
$r^{trans,exp}$	Factor: volume correction at national transport outlet	[#]
r^{prod}	Factor: volume correction at production outlet	[#]
Parameter		
V^{an}	Annualisation factor	[#]
η^{trans}	Efficiency: Transport	[#]
$P^{trans,term}$	Thermal energy demand: Transport	[MWh _{therm} /MWh _{trans}]
$C^{trans,fix}$	Cost: Transport cost per unit H ₂ independent of distance	[EUR/MWh]
$C^{trans,dist}$	Cost: Transport cost per unit H ₂ linked to transport distance	[EUR/MWh/1000km]
Pipeline		
$C^{pip-new,opex}$	Opex of new pipelines	[%]
$C^{pip-new,CAPEX}$	Capex of new pipelines	[EUR/1000km]
$C^{com-new,opex}$	Opex of new compressor stations	[%]
$C^{com-new,CAPEX}$	Capex of new compressor stations	[EUR/1000km]
$C^{pip-ret,opex}$	Opex of retrofitted pipelines	[%]
$C^{pip-ret,CAPEX}$	Capex of retrofitted pipelines	[EUR/1000km]
$C^{com-ret,opex}$	Opex of retrofitted compressor stations	[%]
$C^{com-ret,CAPEX}$	Capex of retrofitted compressor stations	[EUR/1000km]
$V^{pip-new,vol}$	Annual throughput of new pipelines (at full availability)	[MWh/a]
$V^{pip-ret,vol}$	Annual throughput of retrofitted pipelines (at full availability)	[MWh/a]
$V^{pip,avail}$	Pipeline availability	[%]
Seaborne		
$C^{sea,opex}$	Opex of seaborne technologies	[%]
$C^{sea,CAPEX}$	Capex of seaborne technologies	[EUR]
B^{sea}	Vessel capacity per quantities delivered	[MWh _{capacity} /MWh _{delivered}]
A^{sea}	Vessel capacity per quantities delivered and transport distance	[MWh _{capacity} /MWh _{delivered} /1000km]
$V^{sea,dist-long}$	Long searoute distance	[km]
$V^{sea,vol,dist-long}$	Transported volumes annually for a searoute with a long distance	[MWh/a]
$V^{sea,vol,dist-0}$	Transported volumes annually for a searoute with 0 km length	[MWh/a]
$V^{sea,trip,dist-long}$	Number of trip (back- and forth) per vessel for long distance	[#]
$V^{sea,trip,dist-0}$	Number of trip (back- and forth) per vessel for 0 distance	[#]
$V^{sea,cap-unit}$	Capacity of vessel	[MWh]
$V^{sea,prop}$	Fuel use of vessel	[MWh _{therm} /MWh _{trans} /1000km]
$V^{sea,loss}$	Losses of searoute transport	[%/1000km]
V^{load}	Loading time	[h]
V^{unload}	Unloading time	[h]
$V^{sea,speed}$	Speed of vessel	[km/h]
Conversion		
$C^{conv,fix}$	Cost: conversion cost per unit hydrogen	[EUR/MWh]
$C^{conv,opex}$	Opex of conversion	[%]
$C^{conv,CAPEX}$	Capex of conversion	[EUR]
$V^{conv,vol}$	Annual conversion throughput	[MWh/a]
$C^{conv,anc-inv}$	Upfront invest auxiliary material	[EUR/MWh]
$C^{conv,anc-ann}$	Annual renewal auxiliary material	[EUR/MWh/a]
Terminal		
$C^{term-exit,fix}$	Cost: handling and storage cost per unit H ₂ at export terminal	[EUR/MWh]
$C^{term-exit,opex}$	Opex of export terminal	[%]
$C^{term-exit,CAPEX}$	Capex of export terminal	[EUR]
$V^{term-exit,vol}$	Annual throughput of export terminal	[MWh/a]
$C^{term-entry,fix}$	Cost: handling and storage cost of H ₂ at import terminal	[EUR/MWh]
$C^{term-entry,opex}$	Opex of import terminal	[%]
$C^{term-entry,CAPEX}$	Capex of import terminal	[EUR]
$V^{term-entry,vol}$	Annual throughput of import terminal	[MWh/a]
Lower indices		
y	Target year	
l	Production location	
m	Exit point	
n	Entry point	
k	Destination location	
x	Energy vector / Form of hydrogen: at production outlet	
u	Energy vector / Form of hydrogen: international transport	
v	Energy vector / Form of hydrogen: EU transport	
w	Energy vector / Form of hydrogen: demanded at destination location	
Sets		

Symbol	Description	Unit
Y	Considered target years	
L	All considered locations	
L^{prod}	Considered production location	
L^{exit}	Considered exit points	
L^{entry}	Considered entry points	
L^{dest}	Considered destination locations	
V	All considered vectors / forms of H ₂ (e.g., GH ₂ , NH ₃ , LOHC)	
V^{prod}	All considered vectors / forms of H ₂ : at Production outlet (GH ₂)	
V^{int}	All considered vectors / forms of H ₂ : international transport	
V^{eu}	All considered vectors / forms of H ₂ : EU transport	

Table C.25: Nomenclature – data processing

I Pipeline transport

The following expressions are valid for $\forall x$ & $\forall u$ & $\forall v \in \{\text{GH}_2\}$. The corresponding data are given in Table C.26 and Table C.27.

Newly built pipeline – Transport in export country:

$$C_{l,m,x,y}^{trans,dist} = \frac{(V_{l,y}^{an} + C_y^{pip-new,opex}) \cdot C_y^{pip-new,capex}}{V_y^{pip-new,vol} \cdot V_y^{pip,avail}} + \frac{(V_{l,y}^{an} + C_y^{com-new,opex}) \cdot C_y^{com-new,capex}}{V_y^{pip-new,vol} \cdot V_y^{pip,avail}} \quad (\text{C.45})$$

Retrofitted pipeline – International transport and EU transport:

$$C_{m,n,u,y}^{trans,dist} = C_{n,k,v,y}^{trans,dist} = \frac{(V_y^{an} + C_y^{pip-ret,opex}) \cdot C_y^{pip-ret,capex}}{V_y^{pip-ret,vol} \cdot V_y^{pip,avail}} + \frac{(V_y^{an} + C_y^{com-ret,opex}) \cdot C_y^{com-ret,capex}}{V_y^{pip-ret,vol} \cdot V_y^{pip,avail}} \quad (\text{C.46})$$

Other general parameter:

$$C_{l,m,x,y}^{trans,fix} = C_{m,n,u,y}^{trans,fix} = C_{n,k,v,y}^{trans,fix} = 0 \quad (\text{C.47})$$

$$\eta_{x,y}^{trans} = \eta_{u,y}^{trans} = \eta_{v,y}^{trans} = 1 \quad (\text{C.48})$$

$$P_{x,y}^{trans,trm} = P_{u,y}^{trans,trm} = P_{v,y}^{trans,trm} = 0 \quad (\text{C.49})$$

Parameter	Unit	2030			2050		
		pessimistic	base	optimistic	pessimistic	base	optimistic
Lifetime ^a	[a]				40		
Utilisation ^b	[%]				75		
Pipeline throughput (new) ^b	[TWh/a]	10	26	42	10	26	42
Pipeline throughput (retrofit) ^b	[TWh/a]	42	95	148	42	95	148
Capex (new) ^b	[EUR ₂₀₂₀ /m]	1510	1855	1510	2200	1855	1510
Capex (retrofit) ^b	[EUR ₂₀₂₀ /m]	400	450	500	400	450	500
Opex ^c	[% of capex]				1.3%		

^a (IEA 2019d)

^b (Guidehouse 2021)

^c (Guidehouse 2020)

Table C.26: Techno-economic parameters – pipelines

Parameter	Unit	2030			2050		
		pessimistic	base	optimistic	pessimistic	base	optimistic
Lifetime ^a	[a]				24		
Utilisation ^b	[%]				57		
Capex ^b	[MioEUR ₂₀₂₀ /MW _{ele}]				3.4		
Opex ^a	[% of capex]				1.3		
Capacity (new) ^b	[MW _{ele} /1000km]	6	23	40	6	23	40
Capacity (retrofit) ^b	[MW _{ele} /1000km]	40	112	183	40	112	183
Ele demand (new) ^c	[kWh _{ele} /kWh _{GH2} /1000km]	0.004	0.006	0.006	0.004	0.006	0.006
Ele demand (retro) ^c	[kWh _{ele} /kWh _{GH2} /1000km]	0.006	0.008	0.008	0.006	0.008	0.008

^a (Guidehouse 2020)

^b (Guidehouse 2021)

^c Own calculation based on figures of this table and of Table C.26

Table C.27: Techno-economic parameters – compressor stations

II Seaborne transport

The cost of sea transport is expressed linearly to the transport distance.²⁷ Where $C^{trans,fix}$ represents the fixed part and $C^{trans,dist}$ the distance-dependent part. A^{sea} and B^{sea} are additional parameters expressing vessel capacity in terms of quantities delivered (and transport distance). The following expressions are valid for $\forall u \in \{\text{NH}_2, \text{LOCH}, \text{LH}_2\}$. The underlying data are presented in Table C.28.

$$C_{m,n,u,y}^{trans,fix} = (V_{0,y}^{an} + C_{u,y}^{sea,opex}) \cdot C_{u,y}^{sea,capex} \cdot B_{u,y}^{sea} \quad (\text{C.50})$$

$$C_{m,n,u,y}^{trans,dist} = (V_{0,y}^{an} + C_{u,y}^{sea,opex}) \cdot C_{u,y}^{sea,capex} \cdot A_{u,y}^{sea} \quad (\text{C.51})$$

$$B_{u,y}^{sea} = \frac{1}{V_{u,y}^{sea,vol,dist-0}} \quad (\text{C.52})$$

$$A_{u,y}^{sea} = \frac{\frac{1}{V_{u,y}^{sea,vol,dist-long}} - \frac{1}{V_{u,y}^{sea,vol,dist-0}}}{V^{dist-long}} \cdot 1000 \quad (\text{C.53})$$

²⁷ In reality the relation might not be linear. For the sake of simplification however, it is assumed to be linear.

$$V_{u,y}^{sea,vol,dist-0} = \frac{V_{u,y}^{sea,trip,dist-0} \cdot V_{u,y}^{sea,cap-unit}}{V_{u,y}^{sea,cap-unit}} \quad (C.54)$$

$$V_{u,y}^{sea,vol,dist-long} = \frac{\left(1 - P_{u,y}^{trans,term}\right) \cdot V_{u,y}^{sea,trip,dist-long} \cdot V_{u,y}^{sea,cap-unit}}{V_{u,y}^{sea,cap-unit}} \quad (C.55)$$

$$V_{u,y}^{sea,trip,dist-0} = \frac{\text{card}(T^{year})}{V_{u,y}^{onload} + V_{u,y}^{offload}} \quad \forall u \in \{\text{NH}_2, \text{LOCH}, \text{LH}_2\} \quad (C.56)$$

$$V_{u,y}^{sea,trip,dist-long} = \frac{\text{card}(T^{year})}{V_{u,y}^{onload} + V_{u,y}^{offload} + 2 \cdot V_{u,y}^{dist-long} \cdot V_{u,y}^{sea,speed}} \quad \forall u \in \{\text{NH}_2, \text{LOCH}, \text{LH}_2\} \quad (C.57)$$

$$P_{u,y}^{trans,term} = V_{u,y}^{prop} + \max(V_{u,y}^{prop}, V_{u,y}^{loss}) \quad (C.58)$$

$$\eta_{u,y}^{trans} = 1 \quad (C.59)$$

$$V_{u,y}^{sea,cap-unit} = 1 \quad (C.60)$$

III Conversion

Table C.29 shows the data of the conversion processes that are linked by expression C.61.

$$C_{j,v1,v2,y}^{conv,fix} = \left(V_{j,y}^{an} + C_{v1,v2,y}^{conv,opex}\right) \cdot \left(\frac{C_{v1,v2,y}^{conv,CAPEX}}{V_{v1,v2,y}^{conv,vol}} + V_{v2,y}^{conv,anc-inv}\right) + V_{v2,y}^{conv,anc-ann} \quad (C.61)$$

IV Import and export terminal

Terminal-exit cost fix

$$C_{m,u,y}^{term-exit,fix} = \left(V_{m,y}^{an} + C_{u,y}^{term-exit,opex}\right) \cdot \left(\frac{C_{u,y}^{term-exit,CAPEX}}{V_{u,y}^{term-exit,vol}}\right) \quad (C.62)$$

Terminal-entry cost fix

$$C_{n,v,y}^{term-entry,fix} = \left(V_{n,y}^{an} + C_{v,y}^{term-entry,opex}\right) \cdot \left(\frac{C_{v,y}^{term-entry,CAPEX}}{V_{v,y}^{term-entry,vol}}\right) \quad (C.63)$$

The data for the import and the export terminal are given in Table C.30.

Parameter	Unit	pessimistic	2030 base	optimistic	pessimistic	2050 base	optimistic
Lifetime ^a	[a]						15
Opex ^b	[% of capex]						4%
Ship speed ^b	[km/h]						30
Loading time ^c	[h]						48
Unloading time ^c	[h]						48
LH ₂							
Capex ^d	[EUR ₂₀₂₀ /t _{LH2}]	136404	115943	95483	43775	37209	30643
Engine efficiency ^d	[%]	52%	52%	52%	57%	57%	57%
Fuel use ^b	[kWh _{term} /t _{LH2} /1000km]						2.3
Boil-off rate ^b	[%/d]						0.2
NH ₃							
Capex ^d	[EUR ₂₀₂₀ /t _{NH3}]	4635	3509	2384	1532	1160	788
Engine efficiency ^d	[%]	47%	47%	47%	52%	52%	52%
Fuel use ^b	[kWh _{term} /t _{NH3} /1000km]						5.1
LOHC							
Capex ^d	[EUR ₂₀₂₀ /t _{LOHC}]	1811	1509	1207	788	657	525
Engine efficiency ^d	[%]	40%	40%	40%	46%	46%	46%
Fuel use ^b	[kWh _{term} /t _{LOHC} /1000km]						8.9

^a (Al-Breiki and Bicer 2020)
^b (IEA 2019d)
^c (Hurskainen 2019)
^d (IRENA 2022b)

Table C.28: Techno-economic parameters – shipping

Parameter	Unit	2030			2050		
		pessimistic	base	optimistic	pessimistic	base	optimistic
Lifetime ^a	[a]				30		
Utilisation ^a	[%]				90		
Conversion (Liquifaction) - GH ₂ to LH ₂ ^b							
Capex	[EUR ₂₀₂₀ /kW _{LH2}]	3225	2427	1629	872	700	528
Opex	[% of capex]	4%	4%	4%	4%	4%	4%
Efficiency	[%]	95%	95%	95%	100%	100%	100%
Heat consumption	[kW _{therm} /kW _{LH2}]	0.000	0.000	0.000	0.000	0.000	0.000
Electricity consumption	[kW _{ele} /kW _{LH2}]	0.284	0.269	0.253	0.210	0.188	0.165
Conversion (Ammonia synthesis) - GH ₂ to NH ₃ ^b							
Capex	[EUR ₂₀₂₀ /kW _{NH3}]	1728	1296	864	513	384	256
Opex	[% of capex]	2%	2%	2%	2%	2%	2%
Efficiency	[%]	87%	88%	88%	87%	88%	88%
Heat consumption	[kW _{therm} /kW _{NH3}]	0.000	0.000	0.000	0.000	0.000	0.000
Electricity consumption	[kW _{ele} /kW _{NH3}]	0.148	0.148	0.147	0.148	0.130	0.113
Conversion (Hydrogenation) - GH ₂ to LOHC ^b							
Capex	[EUR ₂₀₂₀ /kW _{LOHC}]	395	297	198	102	76	51
Opex	[% of capex]	4%	4%	3%	4%	4%	3%
Efficiency	[%]	90%	93%	95%	96%	98%	99%
Heat consumption	[kW _{therm} /kW _{LOHC}]	0.000	0.000	0.000	0.000	0.000	0.000
Electricity consumption	[kW _{ele} /kW _{LOHC}]	0.000	0.000	0.000	0.000	0.000	0.000
Toluene Upfront ^a	[EUR ₂₀₂₀ /kW _{LOHC}]				96.3		
Toluene - Annual renewal ^a	[EUR ₂₀₂₀ /MW _{LOHC}]				4.7		
Conversion (Regasification) - LH ₂ to GH ₂ ^b							
Capex	[EUR ₂₀₂₀ /kW _{GH2}]	817	569	320	167	110	53
Opex	[% of capex]	4%	4%	3%	4%	4%	3%
Efficiency	[%]	98%	98%	98%	98%	98%	98%
Heat consumption	[kW _{therm} /kW _{GH2}]	0.000	0.000	0.000	0.000	0.000	0.000
Electricity consumption	[kW _{ele} /kW _{GH2}]	0.027	0.023	0.018	0.012	0.009	0.006
Conversion (Ammonia cracking) - NH ₃ to GH ₂ ^b							
Capex	[EUR ₂₀₂₀ /kW _{GH2}]	1335	1010	686	310	242	174
Opex	[% of capex]	4%	4%	3%	4%	4%	3%
Efficiency	[%]	98%	98%	98%	98%	98%	98%
Heat consumption	[kW _{therm} /kW _{GH2}]	0.505	0.420	0.336	0.336	0.243	0.150
Electricity consumption	[kW _{ele} /kW _{GH2}]	0.060	0.060	0.060	0.023	0.023	0.023
Conversion (Dehydrogenation) - LOHC to GH ₂ ^b							
Capex	[EUR ₂₀₂₀ /kW _{GH2}]	952	658	365	212	149	85
Opex	[% of capex]	6%	5%	3%	6%	5%	3%
Efficiency	[%]	98%	98%	98%	98%	98%	98%
Heat consumption	[kW _{therm} /kW _{GH2}]	0.613	0.511	0.408	0.408	0.339	0.270
Electricity consumption	[kW _{ele} /kW _{GH2}]	0.060	0.060	0.060	0.060	0.060	0.060

^a (IEA 2019d)

^b (IRENA 2022b)

Table C.29: Techno-economic parameters – conversion

Parameter ^a	Unit	2030			2050		
		pessimistic	base	optimistic	pessimistic	base	optimistic
Lifetime	[a]				30		
Opex	[% of capex]				4%		
Export terminal LH ₂							
Capex ^{a, b}	[MioEUR ₂₀₂₀ /tank]	321	267	214	204	170	136
Capacity	[GWh/tank]				106.3		
Electricity consumption	[kWh _{ele} /kWh _{LH2}]				0.0183		
Storage length	[days]				3		
Boil-off	[%/day]				0.1		
Export terminal NH ₃							
Capex ^{a, b}	[MioEUR ₂₀₂₀ /tank]	75	63	50	75	63	50
Capacity	[GWh/tank]				176.3		
Electricity consumption	[kWh _{ele} /kWh _{LH2}]				0.0002		
Storage length	[days]				3		
Export terminal LOHC							
Capex ^{a, b}	[MioEUR ₂₀₂₀ /tank]	46	39	31	46	39	31
Capacity	[GWh/tank]				96.8		
Electricity consumption	[kWh _{ele} /kWh _{LH2}]				0.0003		
Storage length	[days]				3		
Import terminal LH ₂							
Capex ^{a, b}	[MioEUR ₂₀₂₀ /tank]	354	295	236	165	138	110
Capacity	[GWh/tank]				118.3		
Electricity consumption	[kWh _{ele} /kWh _{LH2}]				0.0060		
Storage length	[days]				20		
Boil-off	[%/day]				0.1		
Import terminal NH ₃							
Capex ^{a, b}	[MioEUR ₂₀₂₀ /tank]	107	89	72	107	89	72
Capacity	[GWh/tank]				293.1		
Electricity consumption	[kWh _{ele} /kWh _{LH2}]				0.0006		
Storage length	[days]				20		
Import terminal LOHC							
Capex ^{a, b}	[MioEUR ₂₀₂₀ /tank]	39	32	26	39	32	26
Capacity	[GWh/tank]				115.2		
Electricity consumption	[kWh _{ele} /kWh _{LH2}]				0.0003		
Storage length	[days]				20.0		

^a If not stated differently, all data taken from IEA (2019d)

^b Pessimistic: +20% of base case; Optimistic -20% of base case; Cost decrease over time based on Table 6 & 7 of Wijayanta et al. (2019)

Table C.30: Techno-economic parameters – terminal

C.4 Multi-criteria analysis

C.4.1 Approach

Before applying the multi-criteria analysis, the underlying data must be harmonised. However, in advance to the harmonisation process, an initial cleaning of the data is required to correct for missing data and outliers. In the case of incomplete country data in one sub-criterion, the weighting of the second sub-criterion is increased accordingly. It is ensured that for all countries and all criteria at least the data of one of the sub-criteria is complete. Moreover, some indicators contain data points that are substantially lower or greater than the rest – outliers. As we use a linear harmonisation approach that considers the range between the highest and lowest values in the data sets, outliers can have significant impacts on the results of the remaining data points. However, within our analysis it is sufficiently enough to identify whether a data point is at the lower or the upper end of the whole data set rather than to show if it is far lower or greater than the rest. Therefore, outliers are identified through the 1.5 IQR method and corrected accordingly²⁸. The harmonisation of the processed data is achieved using expression (C.64) for datasets where higher values are favourable (Benefit type indicators) and using expression (C.65) for datasets where lower values are beneficial (Costs type indicator) (Rao et al. 2017). Where D_b refers to data sets with benefit type attributes and D_c with cost type attributes.

Benefit type attribute/indicator:

$$z_i = \frac{y_i - \min y_i}{\max y_i - \min y_i} \quad \forall i \in D_b \quad (\text{C.64})$$

Cost type attribute/indicator:

$$z_i = \frac{\max y_i - y_i}{\max y_i - \min y_i} \quad \forall i \in D_c \quad (\text{C.65})$$

C.4.2 Criteria overview and weighting

Criteria Weight	Name	Sub-criteria	
		Weight	Name
20%	Political aspects	50%	Political stability
		50%	Rule of law
20%	Social aspects	50%	Voice opportunity of population
		50%	Control of corruption
20%	Adaptability	50%	Ease of doing business
		50%	Workforce and research

²⁸ To either the lower or upper 1.5 IQR value depending on whether they are outlier at the lower or upper side

20%	Know-how	50%	Expertise in natural gas
		50%	Expertise in renewables
20%	Internationalism	50%	Infrastructure availability
		50%	Degree of globalisation

Table C.31: Overview of Overview of weighting within multi-criteria assessment

Sub-criteria Indicator	Source	Considered years	Type
Political stability			
Index Political stability and absence of violence/terrorism	(Bank 2022d)	2016-2020	benefit
Rule of law			
Index Rule of law	(Bank 2022e)	2016-2020	benefit
Voice opportunity of population			
Index Voice and accountability	(Bank 2022f)	2016-2020	benefit
Control of corruption			
Index Control of corruption	(Bank 2022c)	2016-2020	benefit
Ease of doing business			
Index Ease of doing business	(Bank 2022a)	2015-2019	benefit
Workforce and research			
Index Capital and research	(GII 2022)	2016-2020	benefit
Expertise in natural gas			
Share Total of consumption & Producer/exporter activity ^a	(EIA 2022b; EIA 2022a; EIA 2022d)	2015-2019	benefit
Expertise in renewables			
Share Total of consumption ^b	(EIA 2022d; EIA 2022c)	2015-2019	benefit
Infrastructure availability			
Index Logistics performance	(Bank 2022b)	2013-2018	benefit
Degree of globalisation			
Index KOF globalisation	(Gygli et al. 2019)	2015-2019	benefit

^a Share of natural gas consumption in total energy consumption. Share is modified to 100%, when analysed country is natural gas producer and exporter as producer and exporter countries are supposed to have sufficient know-how in handling gases.

^b Share of electricity generation from wind power and solar PV in total energy consumption

Table C.32: Overview of criteria assessed within multi-criteria assessment

Bibliography

- Abdin, Zainul et al. (Mar. 2020). “Hydrogen as an energy vector”. In: *Renewable and Sustainable Energy Reviews* 120, p. 109620. ISSN: 13640321. DOI: 10.1016/j.rser.2019.109620. URL: <https://linkinghub.elsevier.com/retrieve/pii/S1364032119308275> (visited on 07/05/2023).
- ACER (2023). *EU and UK gas supply portfolio 2015-2021*. European Union Agency for the Cooperation of Energy Regulators. URL: <https://aegis.acer.europa.eu/chest/dataitems/210/view> (visited on 01/01/2023).
- Agency, German Environment (2020). *Kraftwerke in Deutschland*. German Environment Agency. URL: <https://www.umweltbundesamt.de/dokument/datenbank-kraftwerke-in-deutschland>.
- Ang, B.W., W.L. Choong, and T.S. Ng (Feb. 2015). “Energy security: Definitions, dimensions and indexes”. In: *Renewable and Sustainable Energy Reviews* 42, pp. 1077–1093. ISSN: 13640321. DOI: 10.1016/j.rser.2014.10.064. URL: <https://linkinghub.elsevier.com/retrieve/pii/S1364032114008892> (visited on 02/04/2023).
- Ardian, Faddy, Silvia Concettini, and Anna Creti (Sept. 1, 2018). “Renewable Generation and Network Congestion: an Empirical Analysis of the Italian Power Market”. In: *The Energy Journal* 39.1. ISSN: 01956574. DOI: 10.5547/01956574.39.SI2.fard. URL: <http://www.iaee.org/en/publications/ejarticle.aspx?id=3151> (visited on 05/24/2023).
- Bachmeier, Lance J. and James M. Griffin (Apr. 1, 2006). “Testing for Market Integration: Crude Oil, Coal, and Natural Gas”. In: *The Energy Journal* 27.2. ISSN: 01956574. DOI: 10.5547/ISSN0195-6574-EJ-Vol27-No2-4. URL: <http://www.iaee.org/en/publications/ejarticle.aspx?id=2125> (visited on 02/04/2023).
- Bank, World (2021). *Global Offshore Wind Technical Potential*. The World Bank. URL: <https://datacatalog.worldbank.org/search/dataset/0037787> (visited on 03/02/2022).
- (2022a). *Ease of doing business score*. The World Bank. URL: <https://data.worldbank.org/indicator/IC.BUS.DFRN.XQ> (visited on 08/06/2022).
- (2022b). *Logistics performance index: Overall*. The World Bank. URL: <https://data.worldbank.org/indicator/LP.LPI.OVRL.XQ> (visited on 08/06/2022).
- (2022c). *Worldwide Governance Indicators - Control of Corruption: Estimate*. The World Bank. URL: <https://databank.worldbank.org/source/worldwide-governance-indicators#> (visited on 12/19/2022).
- (2022d). *Worldwide Governance Indicators - Political Stability and Absence of Violence/Terrorism: Estimate*. The World Bank. URL: <https://databank.worldbank.org/source/worldwide-governance-indicators#> (visited on 12/19/2022).
- (2022e). *Worldwide Governance Indicators - Rule of Law: Estimate*. The World Bank. URL: <https://databank.worldbank.org/source/worldwide-governance-indicators#> (visited on 12/19/2022).

- (2022f). *Worldwide Governance Indicators - Voice and Accountability: Estimate*. The World Bank. URL: <https://databank.worldbank.org/source/worldwide-governance-indicators#> (visited on 12/19/2022).
- Barnes, Ryan and Ryan Bosworth (Jan. 2015). “LNG is linking regional natural gas markets: Evidence from the gravity model”. In: *Energy Economics* 47, pp. 11–17. ISSN: 01409883. DOI: 10.1016/j.eneco.2014.10.004. URL: <https://linkinghub.elsevier.com/retrieve/pii/S0140988314002461> (visited on 01/29/2023).
- Baroni, Marco (2021). “Decarbonized Hydrogen Imports into the European Union challenges and opportunities”. In: *La Revue de l'Énergie* Hors-série octobre 2021.
- Bertsekas, Dimitri (1991). *Linear Network Optimization: Algorithms and Codes*. Vol. 60. MIT Press. ISBN: 978-0-262-02334-4.
- Beswick, Rebecca R., Alexandra M. Oliveira, and Yushan Yan (Sept. 10, 2021). “Does the Green Hydrogen Economy Have a Water Problem?” In: *ACS Energy Letters* 6.9, pp. 3167–3169. ISSN: 2380-8195, 2380-8195. DOI: 10.1021/acseenergylett.1c01375. URL: <https://pubs.acs.org/doi/10.1021/acseenergylett.1c01375> (visited on 01/24/2023).
- BMWi (2020a). *Aktionsplan Gebotszone - Gemäß Art. 15 Verordnung (EU) 2019/943*. German Federal Ministry of Economics and Technology.
- (2020b). *The National Hydrogen Strategy*. German Federal Ministry of Economics and Technology. URL: https://www.bmwk.de/Redaktion/EN/Publikationen/Energie/the-national-hydrogen-strategy.pdf?__blob=publicationFile&v=6.
- BNetzA (2015). *Bericht zur Netzentgeltssystematik Elektrizität*. German Federal Network Agency.
- (2018). *Genehmigung des Szenariorahmens 2019-2030*. German Federal Network Agency. URL: https://www.netzentwicklungsplan.de/sites/default/files/2022-11/Szenariorahmen_2019-2030_Genehmigung_0_0.pdf.
- (2019). *Bestätigung Netzentwicklungsplan 2019-2030*. German Federal Network Agency.
- (2020a). *Genehmigung des Szenariorahmens 2021-2035*. German Federal Network Agency. URL: https://www.netzentwicklungsplan.de/sites/default/files/2022-11/Szenariorahmen_2035_Genehmigung_1.pdf.
- (2020b). *Kraftwerksliste 2020*. German Federal Network Agency. URL: (https://www.bundesnetzagentur.de/DE/Sachgebiete/ElektrizitaetundGas/Unternehmen_Institutionen/Versorgungssicherheit/Erzeugungskapazitaeten/Kraftwerksliste/start.html).
- (2020c). *Netzausbau.de*. German Federal Network Agency. URL: <https://www.netzausbau.de/Wissen/Ausbaubedarf/Netzentwicklungsplan/de.html>.
- (2021). *Monitoringbericht 2020*. German Federal Network Agency.
- Bødal, Espen Flo et al. (Nov. 2020). “Decarbonization synergies from joint planning of electricity and hydrogen production: A Texas case study”. In: *International Journal of Hydrogen Energy* 45.58, pp. 32899–32915. ISSN: 03603199. DOI: 10.1016/j.ijhydene.2020.09.127. URL: <https://linkinghub.elsevier.com/retrieve/pii/S0360319920335679> (visited on 07/05/2023).
- Bogensperger, Alexander et al. (2017). *Flexibilitätsintegration als wichtiger Baustein eines effizienten Energiesystems*. FfE - Forschungsstelle für Energiewirtschaft e.V.
- Bosch, Jonathan, Iain Staffell, and Adam D. Hawkes (July 2017). “Temporally-explicit and spatially-resolved global onshore wind energy potentials”. In: *Energy* 131, pp. 207–217. ISSN: 03605442. DOI: 10.1016/j.energy.2017.05.052. URL: <https://linkinghub.elsevier.com/retrieve/pii/S0360544217308095> (visited on 01/26/2023).
- BP (2019). *Statistical Review of World Energy 2019*. 68. BP. URL: <https://www.bp.com/content/dam/bp/business-sites/en/global/corporate/pdfs/energy-economics/statistical-review/bp-stats-review-2019-full-report.pdf>.

- BP (2022). *Statistical Review of World Energy 2022*. 71. BP. URL: <https://www.bp.com/content/dam/bp/business-sites/en/global/corporate/pdfs/energy-economics/statistical-review/bp-stats-review-2022-full-report.pdf>.
- Brändle, Gregor, Max Schönfisch, and Simon Schulte (Nov. 2021). “Estimating long-term global supply costs for low-carbon hydrogen”. In: *Applied Energy* 302, p. 117481. ISSN: 03062619. DOI: 10.1016/j.apenergy.2021.117481. URL: <https://linkinghub.elsevier.com/retrieve/pii/S0306261921008667> (visited on 01/22/2023).
- Brauer, Johannes, Manuel Villavicencio, and Johannes Trüby (2022). “Green hydrogen – How grey can it be?” In: *SSRN Electronic Journal*. ISSN: 1556-5068. DOI: 10.2139/ssrn.4214688. URL: <https://www.ssrn.com/abstract=4214688> (visited on 05/29/2023).
- Al-Breiki, Mohammed and Yusuf Bicer (Nov. 2020). “Comparative cost assessment of sustainable energy carriers produced from natural gas accounting for boil-off gas and social cost of carbon”. In: *Energy Reports* 6, pp. 1897–1909. ISSN: 23524847. DOI: 10.1016/j.egy.2020.07.013. URL: <https://linkinghub.elsevier.com/retrieve/pii/S2352484720312312> (visited on 01/24/2023).
- Breitschopf, Barbara et al. (2022). “Importing hydrogen and hydrogen derivatives: Export countries”. In: *HYPAT Working Paper 02/2022*. URL: https://www.hypat.de/hypat-wAssets/docs/new/publications/HyPat_Working_Paper_02_2022_AP_2-1_ENG_FINAL.pdf.
- Brown, T. et al. (Oct. 2018). “Synergies of sector coupling and transmission reinforcement in a cost-optimised, highly renewable European energy system”. In: *Energy* 160, pp. 720–739. ISSN: 03605442. DOI: 10.1016/j.energy.2018.06.222. URL: <https://linkinghub.elsevier.com/retrieve/pii/S036054421831288X> (visited on 07/05/2023).
- Büchner, Jens, René Beune, and Jan von Appen (2019). “Real time flexibility markets Development of Fingrid’s vision on the design of a Finnish flexibility market”. In.
- Budinis, Sara et al. (Nov. 2018). “An assessment of CCS costs, barriers and potential”. In: *Energy Strategy Reviews* 22, pp. 61–81. ISSN: 2211467X. DOI: 10.1016/j.esr.2018.08.003. URL: <https://linkinghub.elsevier.com/retrieve/pii/S2211467X18300634> (visited on 01/25/2023).
- Caldara, Dario and Matteo Iacoviello (Feb. 2018). “Measuring Geopolitical Risk”. In: *International Finance Discussion Paper* 2018.1222, pp. 1–66. ISSN: 10732500. DOI: 10.17016/IFDP.2018.1222. URL: <https://www.federalreserve.gov/econres/ifdp/measuring-geopolitical-risk.htm> (visited on 02/04/2023).
- Cavallaro, Fausto and Luigi Ciraolo (Jan. 2005). “A multicriteria approach to evaluate wind energy plants on an Italian island”. In: *Energy Policy* 33.2, pp. 235–244. ISSN: 03014215. DOI: 10.1016/S0301-4215(03)00228-3. URL: <https://linkinghub.elsevier.com/retrieve/pii/S0301421503002283> (visited on 02/01/2023).
- Cerniauskas, Simonas et al. (Apr. 2020). “Options of natural gas pipeline reassignment for hydrogen: Cost assessment for a Germany case study”. In: *International Journal of Hydrogen Energy* 45.21, pp. 12095–12107. ISSN: 03603199. DOI: 10.1016/j.ijhydene.2020.02.121. URL: <https://linkinghub.elsevier.com/retrieve/pii/S0360319920307023> (visited on 05/02/2023).
- Cecchi, Arianna, Arno Behrens, and Christian Egenhofer (2009). “Long-Term Energy Security Risks for Europe: A Sector-Specific Approach”. In: *SSRN Electronic Journal*. ISSN: 1556-5068. DOI: 10.2139/ssrn.1334620. URL: <http://www.ssrn.com/abstract=1334620> (visited on 02/04/2023).
- Council, Hydrogen (2021). *Hydrogen decarbonization pathways - A life-cycle assessment*. Hydrogen Council. URL: https://hydrogencouncil.com/wp-content/uploads/2021/01/Hydrogen-Council-Report-Decarbonization-Pathways_Part-1-Lifecycle-Assessment.pdf.
- Crespo del Granado, Pedro et al. (Apr. 2018). “Modelling the energy transition: A nexus of energy system and economic models”. In: *Energy Strategy Reviews* 20, pp. 229–235. ISSN: 2211467X.

- DOI: 10.1016/j.esr.2018.03.004. URL: <https://linkinghub.elsevier.com/retrieve/pii/S2211467X18300130> (visited on 07/05/2023).
- Damodaran, Aswath (2022). “Country Risk: Determinants, Measures and Implications – The 2022 Edition”. In: URL: <http://dx.doi.org/10.2139/ssrn.4161010>.
- De Rosa, Mattia et al. (Aug. 2022). “Diversification, concentration and renewability of the energy supply in the European Union”. In: *Energy* 253, p. 124097. ISSN: 03605442. DOI: 10.1016/j.energy.2022.124097. URL: <https://linkinghub.elsevier.com/retrieve/pii/S0360544222010003> (visited on 02/05/2023).
- Degel, Melanie et al. (2016). *VerNetzen Sozial-ökologische und technisch-ökonomische Modellierung von Entwicklungspfaden der Energiewende*. Institut für Zukunftsforschung und Technologiebewertung Berlin.
- Deloitte (2021). *Charting Pathways to Enable Net Zero*. Deloitte. URL: <https://www.francehydrogene.org/publication/hydrogen4eu-charting-pathways-to-enable-net-zero/>.
- (2023). *Green hydrogen: Energizing the path to net zero*. Deloitte. URL: <https://www.deloitte.com/global/en/issues/climate/green-hydrogen.html>.
- DNV GL (2022). *Future Regulatory Decisions on Natural Gas Networks: Repurposing, Decommissioning and Reinvestments*. DNV GL. URL: <https://www.acer.europa.eu/Media/News/Documents/Future%20Regulation%20of%20Natural%20Gas%20Networks%20-%20Final%20Report%20DNV.pdf>.
- DTU (2022). *Global Wind Atlas*. Technical University of Denmark. URL: <https://globalwindatlas.info>.
- E3-Modelling (2021). *EU Reference Scenario 2020 - Energy, transport and GHG emissions - Trends to 2050 (Assumptions book)*. E3-Modelling.
- EC (2000). *Green Paper - Towards a European strategy for the security of energy supply*. Brussels: European Commission.
- (2019). *The European Green Deal*. European Commission. URL: https://commission.europa.eu/strategy-and-policy/priorities-2019-2024/european-green-deal_en.
- (2020). *A Hydrogen Strategy for a Climate-Neutral Europe*. European Commission.
- (2021). *European Climate Law*. European Commission. URL: <https://eur-lex.europa.eu/legal-content/EN/TXT/?uri=CELEX:32021R1119>.
- (2022). *REPowerEU Plan*. European Commission. URL: <https://eur-lex.europa.eu/legal-content/EN/TXT/PDF/?uri=CELEX:52022DC0230&from=EN>.
- (2023a). *Commission delegated regulation (EU) 2023/1184*. European Commission. URL: <https://eur-lex.europa.eu/legal-content/EN/TXT/PDF/?uri=CELEX:32023R1184>.
- (2023b). *Communication from the Commission to the European Parliament, the Council, the European Economic and Social Committee and the Committee of the Regions on the European Hydrogen Bank*. European Commission.
- ECB (2023). *HICP - Overall index*. European Central Bank. URL: <https://sdw.ecb.europa.eu/browseSelection.do?node=1496> (visited on 01/25/2023).
- ECMWF (2022). *ERA5 - Climate Reanalysis*. European Centre for Medium-Range Weather Forecasts. URL: <https://www.ecmwf.int/en/forecasts/datasets/reanalysis-datasets/era5>.
- EEA (2009). *Europe’s onshore and offshore wind energy potential - An assessment of environmental and economic constraints*. European Environment Agency.
- (2023). *EEA greenhouse gases — data viewer*. European Environment Agency. URL: <https://www.eea.europa.eu/data-and-maps/data/data-viewers/greenhouse-gases-viewer> (visited on 06/15/2023).
- Egerer, Jonas (2016). *Open Source Electricity Model for Germany (ELMOD-DE)*. DIW Berlin.
- Egging, Ruud and Franziska Holz (2019). *Global Gas Model Model and Data Documentation v3.0 (2019)*. Berlin: DIW Berlin.

- Egli, Florian, Bjarne Steffen, and Tobias S. Schmidt (Oct. 9, 2019). “Bias in energy system models with uniform cost of capital assumption”. In: *Nature Communications* 10.1, p. 4588. ISSN: 2041-1723. DOI: 10.1038/s41467-019-12468-z. URL: <https://www.nature.com/articles/s41467-019-12468-z> (visited on 01/22/2023).
- EIA (2022a). *Dry Natural Gas Exports*. US Energy Information Administration. URL: <https://www.eia.gov/international/data/world/natural-gas/> (visited on 08/07/2022).
- (2022b). *Dry Natural Gas Production*. US Energy Information Administration. URL: <https://www.eia.gov/international/data/world/natural-gas/> (visited on 08/07/2022).
- (2022c). *Electricity Generation*. US Energy Information Administration. URL: <https://www.eia.gov/international/data/world/electricity/> (visited on 08/22/2007).
- (2022d). *Total Energy Consumption*. US Energy Information Administration. URL: <https://www.eia.gov/international/data/world/total-energy/> (visited on 08/07/2022).
- Eicke, Anselm and Tim Schittekatte (Nov. 2022). “Fighting the wrong battle? A critical assessment of arguments against nodal electricity prices in the European debate”. In: *Energy Policy* 170, p. 113220. ISSN: 03014215. DOI: 10.1016/j.enpol.2022.113220. URL: <https://linkinghub.elsevier.com/retrieve/pii/S0301421522004396> (visited on 06/21/2023).
- El-Emam, Rami S. and Hasan Özcan (May 2019). “Comprehensive review on the techno-economics of sustainable large-scale clean hydrogen production”. In: *Journal of Cleaner Production* 220, pp. 593–609. ISSN: 09596526. DOI: 10.1016/j.jclepro.2019.01.309. URL: <https://linkinghub.elsevier.com/retrieve/pii/S0959652619303361> (visited on 07/05/2023).
- Emonts, Bernd et al. (May 2019). “Flexible sector coupling with hydrogen: A climate-friendly fuel supply for road transport”. In: *International Journal of Hydrogen Energy* 44.26, pp. 12918–12930. ISSN: 03603199. DOI: 10.1016/j.ijhydene.2019.03.183. URL: <https://linkinghub.elsevier.com/retrieve/pii/S0360319919312121> (visited on 05/24/2023).
- ENTSOE (2020). *TYNDP 2020*. entsoe. URL: <https://2020.entsoe-tyndp-scenarios.eu/download-data/>.
- (2021). *ENTSO-E Pan-European Climatic Database*. entsoe. URL: <https://zenodo.org/record/5780185>.
- (2022a). *Transparency Platform*. entsoe. URL: <https://transparency.entsoe.eu/>.
- (2022b). *TYNDP 2022*. entsoe. URL: <https://2022.entsoe-tyndp-scenarios.eu/download/>.
- EP (2018). *DIRECTIVE (EU) 2018/ 2001 OF THE EUROPEAN PARLIAMENT AND OF THE COUNCIL - of 11 December 2018 - on the promotion of the use of energy from renewable sources*. European Parliament. URL: https://eur-lex.europa.eu/legal-content/EN/TXT/?uri=uriserv:OJ.L_.2018.328.01.0082.01.ENG&toc=OJ:L:2018:328:TOC.
- EROS, USGS (2018). *Digital Elevation - Global 30 Arc-Second Elevation (GTOPO30)*. USGS Earth resource observation and science center. URL: https://www.usgs.gov/centers/eros/science/usgs-eros-archive-digital-elevation-global-30-arc-second-elevation-gtopo30?qt-science_center_objects=0#qt-science_center_objects (visited on 10/01/2021).
- ESA (2016). *ESA Land Cover CCI - Water Bodies Map*. v4.0. ESA Land Cover Climate Change Initiative.
- (2017). *ESA Land Cover CCI - Land Cover Maps*. v.2.0.7. ESA Land Cover Climate Change Initiative. URL: https://data.ceda.ac.uk/neodc/esacci/land_cover/data/land_cover_maps/v2.0.7 (visited on 11/04/2021).
- ESMAP (2020). *Global Photovoltaic - Power Potential by Country*. The World Bank. URL: <https://globalsolaratlas.info/global-pv-potential-study> (visited on 04/21/2021).
- Eurostat (2022a). *Imports of natural gas by partner country - NRG_TI_GAS*. Eurostat. URL: https://ec.europa.eu/eurostat/databrowser/view/NRG_TI_GAS/default/table?lang=en&category=nrq.nrg_quant.nrg_quanta.nrg_t.nrg_ti (visited on 12/30/2022).

-
- (2022b). *Imports of oil and petroleum products by partner country - NRG_TI_OIL*. Eurostat. URL: https://ec.europa.eu/eurostat/databrowser/view/NRG_TI_OIL/default/table?lang=en&category=nrg.nrg_quant.nrg_quanta.nrg_t.nrg_ti (visited on 12/30/2022).
 - (2022c). *Imports of solid fossil fuels by partner country - NRG_TI_SFF*. Eurostat. URL: https://ec.europa.eu/eurostat/databrowser/view/NRG_TI_SFF/default/table?lang=en&category=nrg.nrg_quant.nrg_quanta.nrg_t.nrg_ti (visited on 12/30/2022).
 - (2022d). *Supply, transformation and consumption of gas - NRG_CB_GAS*. Eurostat. URL: https://ec.europa.eu/eurostat/databrowser/view/NRG_CB_GAS/default/table?lang=en&category=nrg.nrg_quant.nrg_quanta.nrg_cb (visited on 12/30/2022).
 - (2022e). *Supply, transformation and consumption of oil and petroleum products - NRG_CB_OIL*. Eurostat. URL: https://ec.europa.eu/eurostat/databrowser/view/NRG_CB_OIL/default/table?lang=en&category=nrg.nrg_quant.nrg_quanta.nrg_cb (visited on 12/30/2022).
 - (2022f). *Supply, transformation and consumption of solid fossil fuels - NRG_CB_SFF*. Eurostat. URL: https://ec.europa.eu/eurostat/databrowser/view/NRG_CB_SFF/default/table?lang=en&category=nrg.nrg_quant.nrg_quanta.nrg_cb (visited on 12/30/2022).
 - (2023). *Share of energy from renewable sources, 2004-2021 (% of gross final energy consumption)*. Eurostat. URL: [https://ec.europa.eu/eurostat/statistics-explained/index.php?title=File:Share_of_energy_from_renewable_sources,_2004-2021_\(%25_of_gross_final_energy_consumption\)V5.png](https://ec.europa.eu/eurostat/statistics-explained/index.php?title=File:Share_of_energy_from_renewable_sources,_2004-2021_(%25_of_gross_final_energy_consumption)V5.png).
- EWI (2022). *Merit Order Tool 2022 November - Dokumentation*. EWI.
- FCH JU (2019). *Hydrogen Roadmap Europe - A sustainable pathway for the European energy transition*. Fuel Cells and Hydrogen 2 Joint Undertaking. URL: <https://op.europa.eu/en/publication-detail/-/publication/0817d60d-332f-11e9-8d04-01aa75ed71a1>.
- FNB-Gas (2020). *Netzentwicklungsplan Gas 2020-2030 - Entwurf*. FNB-Gas. URL: https://www.bundesnetzagentur.de/SharedDocs/Downloads/DE/Sachgebiete/Energie/Unternehmen_Institutionen/NetzentwicklungUndSmartGrid/Gas/NEP_2020/Entwurf.pdf?__blob=publicationFile&v=1.
- Frontier-Economics (2021). *RED II Green Power Criteria - Impact on Costs and Availability of Green Hydrogen in Germany*. Frontier-Economics.
- FTC, US (2010). *Horizontal Merger Guidelines*. U.S. Department of Justice and the Federal Trade Commission. URL: <https://www.justice.gov/sites/default/files/atr/legacy/2010/08/19/hmg-2010.pdf> (visited on 01/01/2023).
- Gamboa, Gonzalo and Giuseppe Munda (Mar. 2007). “The problem of windfarm location: A social multi-criteria evaluation framework”. In: *Energy Policy* 35.3, pp. 1564–1583. ISSN: 03014215. DOI: 10.1016/j.enpol.2006.04.021. URL: <https://linkinghub.elsevier.com/retrieve/pii/S0301421506001923> (visited on 02/01/2023).
- Gea-Bermúdez, Juan et al. (May 2021). “The role of sector coupling in the green transition: A least-cost energy system development in Northern-central Europe towards 2050”. In: *Applied Energy* 289, p. 116685. ISSN: 03062619. DOI: 10.1016/j.apenergy.2021.116685. URL: <https://linkinghub.elsevier.com/retrieve/pii/S0306261921002130> (visited on 07/05/2023).
- German Government (2021). *Gesetz für den Ausbau erneuerbarer Energien (ErneuerbareEnergien-Gesetz - EEG 2021)*. German Government. URL: https://www.clearingstelle-eeg-kwkg.de/sites/default/files/2022-10/EEG_2021_221008.pdf.
- German-Government (2020). *Gesetz zur Reduzierung und zur Beendigung der Kohleverstromung (Kohleverstromungsbeendigungsgesetz - KVBG)*. German Government. URL: <https://www.gesetze-im-internet.de/kvbg/BJNR181810020.html>.
- (2023). *Gesetz für den Ausbau erneuerbarer Energien (ErneuerbareEnergien-Gesetz - EEG 2023)*. German Government. URL: https://www.gesetze-im-internet.de/eeg_2014/EEG_2023.pdf.

- Germany-Government (2021). *Bundes-Klimaschutzgesetz*. German Government.
- Gerwen, Rob van, Marcel Eijgelaar, and Theo Bosma (2019). *HYDROGEN IN THE ELECTRICITY VALUE CHAIN*. DNV GL.
- GII (2022). *Global Innovation Index - Human Capital and Research*. Global Innovation Index. URL: <https://www.globalinnovationindex.org/analysis-indicator> (visited on 12/22/2022).
- GL, DNV (2021). *Energy Transition Outlook 2021 (Assumption book)*. DNV GL. URL: <https://data.veracity.com/containers/2f88bdf5-ba9f-4ff6-872e-24733d001930/content> (visited on 05/21/2022).
- Glenk, Gunther and Stefan Reichelstein (Feb. 25, 2019). “Economics of converting renewable power to hydrogen”. In: *Nature Energy* 4.3, pp. 216–222. ISSN: 2058-7546. DOI: 10.1038/s41560-019-0326-1. URL: <https://www.nature.com/articles/s41560-019-0326-1> (visited on 05/24/2023).
- Goldthau, Andreas, Laima Eicke, and Silvia Weko (2020). *The Global Energy Transition and the Global South*. 10.1007/978-3-030-39066-2_14. Cham: Springer International Publishing. URL: <http://link.springer.com/10.1007/978-3-030-39066-2> (visited on 07/05/2023).
- Green, Richard (Mar. 8, 2007). “Nodal pricing of electricity: how much does it cost to get it wrong?” In: *Journal of Regulatory Economics* 31.2, pp. 125–149. ISSN: 0922-680X, 1573-0468. DOI: 10.1007/s11149-006-9019-3. URL: <http://link.springer.com/10.1007/s11149-006-9019-3> (visited on 05/24/2023).
- Grinschgl, Julian, Jacopo Pepe, and Kirsten Westphal (2021). “A New Hydrogen World: Geotechnological, Economic, and Political Implications for Europe”. In.
- Gruber, Katharina et al. (Jan. 2022). “Towards global validation of wind power simulations: A multi-country assessment of wind power simulation from MERRA-2 and ERA-5 reanalyses bias-corrected with the global wind atlas”. In: *Energy* 238, p. 121520. ISSN: 03605442. DOI: 10.1016/j.energy.2021.121520. URL: <https://linkinghub.elsevier.com/retrieve/pii/S0360544221017680> (visited on 01/23/2023).
- Guidehouse (2020). *European Hydrogen Backbone - How a dedicated hydrogen infrastructure can be created*. Guidehouse.
- (2021). *Analysing Future Demand, Supply and Transport of Hydrogen*. Guidehouse.
- (2022). *European Hydrogen Backbone (April 2022)*. Guidehouse.
- Gygli, Savina et al. (Sept. 2019). “The KOF Globalisation Index – revisited”. In: *The Review of International Organizations* 14.3, pp. 543–574. ISSN: 1559-7431, 1559-744X. DOI: 10.1007/s11558-019-09344-2. URL: <http://link.springer.com/10.1007/s11558-019-09344-2> (visited on 08/02/2022).
- He, Chunyan, Yalin Lei, and Jianping Ge (July 22, 2014). “Assessment of Trading Partners for China’s Rare Earth Exports Using a Decision Analytic Approach”. In: *PLoS ONE* 9.7. Ed. by Rodrigo Huerta-Quintanilla, e102870. ISSN: 1932-6203. DOI: 10.1371/journal.pone.0102870. URL: <https://dx.plos.org/10.1371/journal.pone.0102870> (visited on 02/01/2023).
- Heuser, Philipp-Matthias et al. (2020). “Worldwide Hydrogen Provision Scheme Based on Renewable Energy”. In.
- Hirth, Lion, Christoph Maurer, et al. (2019). “Strategisches Bieten in Flex-Märkten”. In.
- Hirth, Lion and Ingmar Schlecht (2018). “Market-Based Redispatch in Zonal Electricity Markets”. In: *SSRN Electronic Journal*. ISSN: 1556-5068. DOI: 10.2139/ssrn.3286798. URL: <https://www.ssrn.com/abstract=3286798> (visited on 05/24/2023).
- Hjeij, Dawood, Yusuf Biçer, and Muammer Koç (Jan. 2022). “Hydrogen strategy as an energy transition and economic transformation avenue for natural gas exporting countries: Qatar as a case study”. In: *International Journal of Hydrogen Energy* 47.8, pp. 4977–5009. ISSN: 03603199. DOI: 10.1016/j.ijhydene.2021.11.151. URL: <https://linkinghub.elsevier.com/retrieve/pii/S0360319921045390> (visited on 02/01/2023).

- Hurskainen, Markus (2019). *Liquid organic hydrogen carriers (LOHC): Concept evaluation and techno-economics*. VTT Research Report No. VTT-R-00057-19. VTT Technical Research Centre of Finland.
- Hurtubia, Byron and Enzo Sauma (Dec. 2021). “Economic and environmental analysis of hydrogen production when complementing renewable energy generation with grid electricity”. In: *Applied Energy* 304, p. 117739. ISSN: 03062619. DOI: 10.1016/j.apenergy.2021.117739. URL: <https://linkinghub.elsevier.com/retrieve/pii/S0306261921010849> (visited on 07/05/2023).
- IEA (2007). *Energy Security and Climate Policy - Assessing Interactions*. International Energy Agency.
- (2019a). *Energy Security - Reliable, Affordable Access to All Fuels and Energy Sources*. International Energy Agency. URL: <https://www.iea.org/areas-of-work/energy-security>.
 - (2019b). *Innovative Regulatory Approaches with Focus on Experimental Sandboxes*. IEA. URL: https://www.iea-iscan.org/wp-content/uploads/2019/05/ISGAN_Casebook-on-Regulatory-Sandbox-A2-1.pdf.
 - (2019c). *The Future of Hydrogen*. International Energy Agency.
 - (2019d). *The Future of Hydrogen - Assumption Book*. International Energy Agency.
 - (2020). *CCUS in clean energy transitions*. International Energy Agency.
 - (Oct. 21, 2021a). *Curtailling Methane Emissions from Fossil Fuel Operations: Pathways to a 75% cut by 2030*. International Energy Agency. DOI: 10.1787/1616ff90-en. URL: https://www.oecd-ilibrary.org/energy/curtailling-methane-emissions-from-fossil-fuel-operations_1616ff90-en (visited on 02/05/2023).
 - (2021b). *Renewables 2021 - Analysis and forecast to 2026*. International Energy Agency.
 - (2021c). *The Cost of Capital in Clean Energy Transitions*. International Energy Agency. URL: <https://www.iea.org/articles/the-cost-of-capital-in-clean-energy-transitions>.
 - (2021d). *World Energy Outlook 2021*. International Energy Agency.
 - (2022a). *Africa Energy Outlook 2022*. International Energy Agency.
 - (2022b). *Renewable Energy Market Update 2022*. International Energy Agency. URL: <https://iea.blob.core.windows.net/assets/d6a7300d-7919-4136-b73a-3541c33f8bd7/RenewableEnergyMarketUpdate2022.pdf>.
 - (2022c). *World Energy Outlook 2022*. International Energy Agency.
 - (2023). *Renewable Energy Market Update - June 2023*. International Energy Agency.
- IEE, Fraunhofer (2022). *Global PtX Atlas*. URL: <https://maps.iee.fraunhofer.de/ptx-atlas/>.
- Ifo (2012). *Regionalisierten Strukturdatenprognose 2030*. Ifo Institut für Wirtschaftsforschung.
- Ikäheimo, Jussi et al. (Sept. 2018). “Power-to-ammonia in future North European 100 % renewable power and heat system”. In: *International Journal of Hydrogen Energy* 43.36, pp. 17295–17308. ISSN: 03603199. DOI: 10.1016/j.ijhydene.2018.06.121. URL: <https://linkinghub.elsevier.com/retrieve/pii/S0360319918319931> (visited on 05/24/2023).
- IPCC (2023). *Climate Change 2023 - Synthesis Report*. Intergovernmental Panel on Climate Change. URL: https://www.ipcc.ch/report/ar6/syr/downloads/report/IPCC_AR6_SYR_SPM.pdf.
- IRENA (2019a). *Future of wind: Deployment, investment, technology, grid integration and socio-economic aspects (A Global Energy Transformation paper)*. Abu Dhabi: International Renewable Energy Agency.
- (2019b). *The Future of Solar PV*. Abu Dhabi: International Renewable Energy Agency.
 - (2020a). *GLOBAL Renewables Outlook: Energy transformation 2050*. OCLC: 1337485335. Abu Dhabi: International Renewable Energy Agency.
 - (2020b). *Green hydrogen cost reduction*. International Renewable Energy Agency. URL: https://www.irena.org/-/media/Files/IRENA/Agency/Publication/2020/Dec/IRENA_Green_hydrogen_cost_2020.pdf.

- IRENA (2020c). *Renewable Power Generation Costs 2020*. Abu Dhabi: International Renewable Energy Agency.
- (2021). *Renewable Power Generation Costs in 2021*. International Renewable Energy Agency.
- (2022a). *Global Hydrogen Trade to Meet the 1.5°C Climate Goal: Part I - Trade Outlook for 2050 and Way Forward*. International Renewable Energy Agency. URL: <https://www.irena.org/publications/2022/Jul/Global-Hydrogen-Trade-Outlook>.
- (2022b). *Global Hydrogen Trade to Meet the 1.5°C Climate Goal: Technology Review of Hydrogen Carriers*. Abu Dhabi: IRENA.
- (2022c). *Renewable Energy Statistics 2022*. Abu Dhabi: International Renewable Energy Agency.
- JRC, EC (2022). *Global Human Settlement Layer - Data Package 2022*. European Commission - Joint Research Centre. URL: <https://ghsl.jrc.ec.europa.eu/download.php> (visited on 06/18/2022).
- Just, Lisa, Patricia Wild, and Fabian Arnold (2022). *Deutsche und Europäische Energieimporte*. Institute of Energy Economics at the University of Cologne (EWI).
- Kakoulaki, G. et al. (Jan. 2021). “Green hydrogen in Europe – A regional assessment: Substituting existing production with electrolysis powered by renewables”. In: *Energy Conversion and Management* 228, p. 113649. ISSN: 01968904. DOI: 10.1016/j.enconman.2020.113649. URL: <https://linkinghub.elsevier.com/retrieve/pii/S0196890420311766> (visited on 05/24/2023).
- Kepaptsoglou, Konstantinos, Matthew G. Karlaftis, and Dimitrios Tsamboulas (May 4, 2010). “The Gravity Model Specification for Modeling International Trade Flows and Free Trade Agreement Effects: A 10-Year Review of Empirical Studies~!2009-07-09~!2010-01-28~!2010-04-22~!” In: *The Open Economics Journal* 3.1, pp. 1–13. ISSN: 18749194. DOI: 10.2174/1874919401003010001. URL: <http://benthamopen.com/ABSTRACT/TOECONSJ-3-1> (visited on 01/29/2023).
- Keppler, Jan Horst (2007). “International relations and security of energy supply: Risks to continuity and geopolitical risks”. In: *European Parliament - Directorate-General for External Policies of the Union*. URL: <https://ketlib.lib.unipi.gr/xmlui/handle/ket/476>.
- Kunz, Friedrich et al. (2017). *Data Documentation 92 - Electricity, Heat, and Gas Sector Data for Modeling the German System*. DIW Berlin.
- Lagioia, Giovanni, Maria Pia Spinelli, and Vera Amicarelli (Jan. 2023). “Blue and green hydrogen energy to meet European Union decarbonisation objectives. An overview of perspectives and the current state of affairs”. In: *International Journal of Hydrogen Energy* 48.4, pp. 1304–1322. ISSN: 03603199. DOI: 10.1016/j.ijhydene.2022.10.044. URL: <https://linkinghub.elsevier.com/retrieve/pii/S0360319922046675> (visited on 07/05/2023).
- Lang, Kai-Olaf and Kirsten Westphal (2017). “Nord Stream 2 – A Political and Economic Contextualisation”. In: *SWP Research Paper*.
- Lee, Joseph C. Y. and M. Jason Fields (Mar. 5, 2021). “An overview of wind-energy-production prediction bias, losses, and uncertainties”. In: *Wind Energy Science* 6.2, pp. 311–365. ISSN: 2366-7451. DOI: 10.5194/wes-6-311-2021. URL: <https://wes.copernicus.org/articles/6/311/2021/> (visited on 01/23/2023).
- Li, Xinyu and Machiel Mulder (Dec. 2021). “Value of power-to-gas as a flexibility option in integrated electricity and hydrogen markets”. In: *Applied Energy* 304, p. 117863. ISSN: 03062619. DOI: 10.1016/j.apenergy.2021.117863. URL: <https://linkinghub.elsevier.com/retrieve/pii/S0306261921011855> (visited on 05/29/2023).
- Lüers, Silke, Dr Knud Rehfeldt, and Merle Heyken (2022). *Kurzfristanalyse zur Kostensituation der Windenergie an Land*. Deutsche Windguard. URL: <https://www.bmwk.de/Redaktion/DE/Downloads/Energie/kurzfristanalyse-zur-kostensituation-der-windenergie-an-land.html>.
- Mardani, Abbas et al. (Jan. 2015). “Multiple criteria decision-making techniques and their applications – a review of the literature from 2000 to 2014”. In: *Economic Research-Ekonomika Istraživanja*

- vanja* 28.1, pp. 516–571. ISSN: 1331-677X, 1848-9664. DOI: 10.1080/1331677X.2015.1075139. URL: <http://www.tandfonline.com/doi/full/10.1080/1331677X.2015.1075139> (visited on 02/10/2023).
- McKenna, Russell et al. (Jan. 2022). “High-resolution large-scale onshore wind energy assessments: A review of potential definitions, methodologies and future research needs”. In: *Renewable Energy* 182, pp. 659–684. ISSN: 09601481. DOI: 10.1016/j.renene.2021.10.027. URL: <https://linkinghub.elsevier.com/retrieve/pii/S0960148121014841> (visited on 02/24/2023).
- Melaina, M W, O Antonia, and M Penev (2013). “Blending Hydrogen into Natural Gas Pipeline Networks: A Review of Key Issues”. In: *Renewable Energy*.
- Muñoz, Beatriz, Javier García-Verdugo, and Enrique San-Martín (Mar. 2015). “Quantifying the geopolitical dimension of energy risks: A tool for energy modelling and planning”. In: *Energy* 82, pp. 479–500. ISSN: 03605442. DOI: 10.1016/j.energy.2015.01.058. URL: <https://linkinghub.elsevier.com/retrieve/pii/S0360544215000821> (visited on 02/04/2023).
- NationalGrid (2019). *De-rating Factor Methodology for Renewables Participation in the Capacity Market*. National Grid.
- Neumann, Fabian et al. (Aug. 2023). “The Potential Role of a Hydrogen Network in Europe”. In: *Joule* 7.8, pp. 1793–1817. ISSN: 25424351. DOI: 10.1016/j.joule.2023.06.016. arXiv: 2207.05816[physics]. URL: <http://arxiv.org/abs/2207.05816> (visited on 09/01/2023).
- Niermann, M. et al. (2019). “Liquid organic hydrogen carriers (LOHCs) – techno-economic analysis of LOHCs in a defined process chain”. In: *Energy & Environmental Science* 12.1, pp. 290–307. ISSN: 1754-5692, 1754-5706. DOI: 10.1039/C8EE02700E. URL: <http://xlink.rsc.org/?DOI=C8EE02700E> (visited on 02/01/2023).
- Noussan, Michel et al. (Dec. 31, 2020). “The Role of Green and Blue Hydrogen in the Energy Transition—A Technological and Geopolitical Perspective”. In: *Sustainability* 13.1, p. 298. ISSN: 2071-1050. DOI: 10.3390/su13010298. URL: <https://www.mdpi.com/2071-1050/13/1/298> (visited on 07/05/2023).
- NREL (2022a). *2022 Annual Technology Baseline (ATB) Cost and Performance Data for Electricity Generation Technologies [data set]*. National Renewable Energy Laboratory. URL: <https://dx.doi.org/10.25984/1871952> (visited on 10/30/2022).
- (2022b). *Electricity Annual Technology Baseline (ATB) 2022*. National Renewable Energy Laboratory. URL: <https://atb.nrel.gov/electricity/2022/data>.
- NSEC (2022). *Joint Statement on the North Seas Energy Cooperation – 12 Sept 2022*. North Sea Energy Cooperation. URL: https://energy.ec.europa.eu/system/files/2022-09/220912_NSEC_Joint_Statement_Dublin_Ministerial.pdf.
- Nuñez-Jimenez, Alejandro and Nicola De Blasio (2022). “The Future of Renewable Hydrogen in the European Union”. In: *Harvard Kennedy School*.
- OECD (2022). *OECD Data - Short-Term Interest Rates*. Organisation for Economic Co-operation and Development. URL: <https://data.oecd.org/interest/short-term-interest-rates.htm>.
- (2023). *OECD Data - Exchange rates*. Organisation for Economic Co-operation and Development. URL: <https://data.oecd.org/conversion/exchange-rates.htm> (visited on 01/25/2023).
- Office, German Federal Statistical (2020). *Gemeindeverzeichnis*. German Federal Statistical Office. URL: https://www.destatis.de/DE/Themen/Laender-Regionen/Regionales/Gemeindeverzeichnis/_inhalt.html.
- Offices, German Federal {and} State Statistical (2020). *Bruttoinlandsprodukt, Bruttowertschöpfung in Den Kreisfreien Städten Und Landkreisen Der Bundesrepublik Deutschland*. German Federal and State Statistical Offices.

- Ogden, Joan et al. (Apr. 2018). “Natural gas as a bridge to hydrogen transportation fuel: Insights from the literature”. In: *Energy Policy* 115, pp. 317–329. ISSN: 03014215. DOI: 10.1016/j.enpol.2017.12.049. URL: <https://linkinghub.elsevier.com/retrieve/pii/S0301421517308741> (visited on 05/02/2023).
- Olczak, Maria and Andris Piebalgs (2018). *Sector Coupling: the New EU Climate and Energy Paradigm?* Florence School of Regulation.
- Overbye, T.J., Xu Cheng, and Yan Sun (2004). “A comparison of the AC and DC power flow models for LMP calculations”. In: *37th Annual Hawaii International Conference on System Sciences, 2004. Proceedings of the. 37th Annual Hawaii International Conference on System Sciences, 2004. Proceedings of the.* Big Island, HI, USA: IEEE, 9 pp. ISBN: 978-0-7695-2056-8. DOI: 10.1109/HICSS.2004.1265164. URL: <http://ieeexplore.ieee.org/document/1265164/> (visited on 05/24/2023).
- Ozdemir, O. et al. (May 2009). “A nodal pricing analysis of the future German electricity market”. In: *2009 6th International Conference on the European Energy Market. 2009 6th International Conference on the European Energy Market (EEM 2009)*. Leuven: IEEE, pp. 1–7. ISBN: 978-1-4244-4455-7. DOI: 10.1109/EEM.2009.5207112. URL: <http://ieeexplore.ieee.org/document/5207112/> (visited on 05/24/2023).
- Parra, David et al. (Mar. 2019). “A review on the role, cost and value of hydrogen energy systems for deep decarbonisation”. In: *Renewable and Sustainable Energy Reviews* 101, pp. 279–294. ISSN: 13640321. DOI: 10.1016/j.rser.2018.11.010. URL: <https://linkinghub.elsevier.com/retrieve/pii/S1364032118307421> (visited on 07/05/2023).
- Perekhodtsev, Dmitri and Guido Cervigni (2010). “UK Transmission Congestion Problem: Causes and Solutions”. In: *SSRN Electronic Journal*. ISSN: 1556-5068. DOI: 10.2139/ssrn.1550207. URL: <http://www.ssrn.com/abstract=1550207> (visited on 05/24/2023).
- Pfenninger, Stefan, Adam Hawkes, and James Keirstead (May 2014). “Energy systems modeling for twenty-first century energy challenges”. In: *Renewable and Sustainable Energy Reviews* 33, pp. 74–86. ISSN: 13640321. DOI: 10.1016/j.rser.2014.02.003. URL: <https://linkinghub.elsevier.com/retrieve/pii/S1364032114000872> (visited on 07/05/2023).
- Pfenninger, Stefan and Iain Staffell (Nov. 2016). “Long-term patterns of European PV output using 30 years of validated hourly reanalysis and satellite data”. In: *Energy* 114, pp. 1251–1265. ISSN: 03605442. DOI: 10.1016/j.energy.2016.08.060. URL: <https://linkinghub.elsevier.com/retrieve/pii/S0360544216311744> (visited on 01/22/2023).
- Pflugmann, Fridolin and Nicola De Blasio (2020). “Geopolitical and Market Implications of Renewable Hydrogen”. In.
- Pietzcker, Robert Carl et al. (Dec. 2014). “Using the sun to decarbonize the power sector: The economic potential of photovoltaics and concentrating solar power”. In: *Applied Energy* 135, pp. 704–720. ISSN: 03062619. DOI: 10.1016/j.apenergy.2014.08.011. URL: <https://linkinghub.elsevier.com/retrieve/pii/S0306261914008149> (visited on 02/01/2023).
- Rao, Congjun et al. (Mar. 2017). “Compound mechanism design of supplier selection based on multi-attribute auction and risk management of supply chain”. In: *Computers & Industrial Engineering* 105, pp. 63–75. ISSN: 03608352. DOI: 10.1016/j.cie.2016.12.042. URL: <https://linkinghub.elsevier.com/retrieve/pii/S0360835216305198> (visited on 02/16/2023).
- Reuß, Markus et al. (Aug. 2019). “A hydrogen supply chain with spatial resolution: Comparative analysis of infrastructure technologies in Germany”. In: *Applied Energy* 247, pp. 438–453. ISSN: 03062619. DOI: 10.1016/j.apenergy.2019.04.064. URL: <https://linkinghub.elsevier.com/retrieve/pii/S0306261919307111> (visited on 01/23/2023).
- Ringe, Wolf-Georg and Christopher Ruof (Sept. 2020). “Regulating Fintech in the EU: the Case for a Guided Sandbox”. In: *European Journal of Risk Regulation* 11.3, pp. 604–629. ISSN: 1867-299X,

- 2190-8249. DOI: 10.1017/err.2020.8. URL: https://www.cambridge.org/core/product/identifier/S1867299X20000082/type/journal_article (visited on 05/24/2023).
- Roach, Martin and Leonardo Meeus (Feb. 2020). “The welfare and price effects of sector coupling with power-to-gas”. In: *Energy Economics* 86, p. 104708. ISSN: 01409883. DOI: 10.1016/j.eneco.2020.104708. URL: <https://linkinghub.elsevier.com/retrieve/pii/S0140988320300475> (visited on 05/24/2023).
- Robinius, Martin et al. (July 20, 2017). “Linking the Power and Transport Sectors—Part 2: Modelling a Sector Coupling Scenario for Germany”. In: *Energies* 10.7, p. 957. ISSN: 1996-1073. DOI: 10.3390/en10070957. URL: <http://www.mdpi.com/1996-1073/10/7/957> (visited on 05/24/2023).
- Rosen, Marc A. and Seama Koochi-Fayegh (Feb. 2016). “The prospects for hydrogen as an energy carrier: an overview of hydrogen energy and hydrogen energy systems”. In: *Energy, Ecology and Environment* 1.1, pp. 10–29. ISSN: 2363-7692, 2363-8338. DOI: 10.1007/s40974-016-0005-z. URL: <http://link.springer.com/10.1007/s40974-016-0005-z> (visited on 07/05/2023).
- Roy, Bernard (1990). “Decision-aid and decision-making”. In: *European Journal of Operational Research* 45.2.
- Ruhnau, Oliver (Feb. 2022). “How flexible electricity demand stabilizes wind and solar market values: The case of hydrogen electrolyzers”. In: *Applied Energy* 307, p. 118194. ISSN: 03062619. DOI: 10.1016/j.apenergy.2021.118194. URL: <https://linkinghub.elsevier.com/retrieve/pii/S0306261921014641> (visited on 05/24/2023).
- Ruhnau, Oliver, Sergej Bannik, et al. (Jan. 2019). “Direct or indirect electrification? A review of heat generation and road transport decarbonisation scenarios for Germany 2050”. In: *Energy* 166, pp. 989–999. ISSN: 03605442. DOI: 10.1016/j.energy.2018.10.114. URL: <https://linkinghub.elsevier.com/retrieve/pii/S0360544218321042> (visited on 07/05/2023).
- Ruhnau, Oliver, Lion Hirth, and Aaron Praktiknjo (Oct. 2020). “Heating with wind: Economics of heat pumps and variable renewables”. In: *Energy Economics* 92, p. 104967. ISSN: 01409883. DOI: 10.1016/j.eneco.2020.104967. URL: <https://linkinghub.elsevier.com/retrieve/pii/S0140988320303078> (visited on 07/05/2023).
- Ruhnau, Oliver and Johanna Schiele (2022). “Flexible green hydrogen: Economic benefits without increasing power sector emissions”. In:
- Ruiz, P. et al. (Nov. 2019). “ENSPRESO - an open, EU-28 wide, transparent and coherent database of wind, solar and biomass energy potentials”. In: *Energy Strategy Reviews* 26, p. 100379. ISSN: 2211467X. DOI: 10.1016/j.esr.2019.100379. URL: <https://linkinghub.elsevier.com/retrieve/pii/S2211467X19300720> (visited on 01/23/2023).
- Runge, Philipp et al. (2020). “Economic Comparison of Electric Fuels Produced at Excellent Locations for Renewable Energies: A Scenario for 2035”. In: *SSRN Electronic Journal*. ISSN: 1556-5068. DOI: 10.2139/ssrn.3623514. URL: <https://www.ssrn.com/abstract=3623514> (visited on 05/24/2023).
- Ryberg, David, Martin Robinius, and Detlef Stolten (May 14, 2018). “Evaluating Land Eligibility Constraints of Renewable Energy Sources in Europe”. In: *Energies* 11.5, p. 1246. ISSN: 1996-1073. DOI: 10.3390/en11051246. URL: <http://www.mdpi.com/1996-1073/11/5/1246> (visited on 01/22/2023).
- Salmon, Nicholas and René Bañares-Alcántara (2021). “Green ammonia as a spatial energy vector: a review”. In: *Sustainable Energy & Fuels* 5.11, pp. 2814–2839. ISSN: 2398-4902. DOI: 10.1039/D1SE00345C. URL: <http://xlink.rsc.org/?DOI=D1SE00345C> (visited on 02/01/2023).
- Sark, WG.J.H.M. van, N.H. Reich, and B. Müller (2012). *Review of PV performance ratio developments*.
- Schittekatte, Tim et al. (Sept. 2021). “Regulatory experimentation in energy: Three pioneer countries and lessons for the green transition”. In: *Energy Policy* 156, p. 112382. ISSN: 03014215. DOI:

- 10.1016/j.enpol.2021.112382. URL: <https://linkinghub.elsevier.com/retrieve/pii/S0301421521002524> (visited on 05/25/2023).
- Schlund, David, Simon Schulte, and Tobias Sprenger (Feb. 2022). “The who’s who of a hydrogen market ramp-up: A stakeholder analysis for Germany”. In: *Renewable and Sustainable Energy Reviews* 154, p. 111810. ISSN: 13640321. DOI: 10.1016/j.rser.2021.111810. URL: <https://linkinghub.elsevier.com/retrieve/pii/S1364032121010789> (visited on 09/01/2023).
- Schlund, David and Philipp Theile (July 2022). “Simultaneity of green energy and hydrogen production: Analysing the dispatch of a grid-connected electrolyser”. In: *Energy Policy* 166, p. 113008. ISSN: 03014215. DOI: 10.1016/j.enpol.2022.113008. URL: <https://linkinghub.elsevier.com/retrieve/pii/S0301421522002336> (visited on 05/29/2023).
- Scholten, Daniel, Morgan Bazilian, et al. (Mar. 2020). “The geopolitics of renewables: New board, new game”. In: *Energy Policy* 138, p. 111059. ISSN: 03014215. DOI: 10.1016/j.enpol.2019.111059. URL: <https://linkinghub.elsevier.com/retrieve/pii/S0301421519306469> (visited on 02/01/2023).
- Scholten, Daniel and Rick Bosman (2013). “The Geopolitics of Renewable Energy; a Mere Shift or Landslide in Energy Dependencies?” In: *12th Political Science Conference Politicologenetmaal, Ghent, Belgium, 30-31 May 2013*. URL: <http://resolver.tudelft.nl/uuid:97c5bfda-7d04-4baf-bddd-fa7309acdc71>.
- Schönheit, David et al. (2020). “ELMOD documentation: Modeling of flow-based market coupling and congestion management”. In.
- Schroeder, Andreas et al. (Oct. 2013). “The integration of renewable energies into the German transmission grid—A scenario comparison”. In: *Energy Policy* 61, pp. 140–150. ISSN: 03014215. DOI: 10.1016/j.enpol.2013.06.006. URL: <https://linkinghub.elsevier.com/retrieve/pii/S0301421513004849> (visited on 05/24/2023).
- Staffell, Iain and Stefan Pfenninger (Nov. 2016). “Using bias-corrected reanalysis to simulate current and future wind power output”. In: *Energy* 114, pp. 1224–1239. ISSN: 03605442. DOI: 10.1016/j.energy.2016.08.068. URL: <https://linkinghub.elsevier.com/retrieve/pii/S0360544216311811> (visited on 01/22/2023).
- Staffell, Iain, Daniel Scamman, et al. (2019). “The role of hydrogen and fuel cells in the global energy system”. In: *Energy & Environmental Science* 12.2, pp. 463–491. ISSN: 1754-5692, 1754-5706. DOI: 10.1039/C8EE01157E. URL: <http://xlink.rsc.org/?DOI=C8EE01157E> (visited on 06/21/2023).
- Stöckl, Fabian, Wolf-Peter Schill, and Alexander Zerrahn (July 9, 2021a). “Optimal supply chains and power sector benefits of green hydrogen”. In: *Scientific Reports* 11.1, p. 14191. ISSN: 2045-2322. DOI: 10.1038/s41598-021-92511-6. URL: <https://www.nature.com/articles/s41598-021-92511-6> (visited on 05/29/2023).
- (2021b). *Optimal supply chains and power sector benefits of green hydrogen - Supplementary Information*. DIW Berlin.
- Sutrisno, Aziiz, nder Nomaler, and Floor Alkemade (Jan. 2021). “Has the global expansion of energy markets truly improved energy security?” In: *Energy Policy* 148, p. 111931. ISSN: 03014215. DOI: 10.1016/j.enpol.2020.111931. URL: <https://linkinghub.elsevier.com/retrieve/pii/S030142152030642X> (visited on 02/04/2023).
- Tagliapietra, Simone (Aug. 13, 2020). *Global Energy Fundamentals: Economics, Politics, and Technology*. 1st ed. Cambridge University Press. ISBN: 978-1-108-86159-5 978-1-108-49521-9 978-1-108-81770-7. DOI: 10.1017/9781108861595. URL: <https://www.cambridge.org/core/product/identifier/9781108861595/type/book> (visited on 02/04/2023).
- Tarvydas, Dalius (2022). *The role of hydrogen in decarbonisation energy scenarios: views on 2030 and 2050*. LU: Publications Office. URL: <https://data.europa.eu/doi/10.2760/899528> (visited on 07/05/2023).

- Thomaßen, Georg, Konstantinos Kavvadias, and Juan Pablo Jiménez Navarro (Jan. 2021). “The decarbonisation of the EU heating sector through electrification: A parametric analysis”. In: *Energy Policy* 148, p. 111929. ISSN: 03014215. DOI: 10.1016/j.enpol.2020.111929. URL: <https://linkinghub.elsevier.com/retrieve/pii/S0301421520306406> (visited on 07/05/2023).
- Tlili, Olfa et al. (Jan. 2020). “Geospatial modelling of the hydrogen infrastructure in France in order to identify the most suited supply chains”. In: *International Journal of Hydrogen Energy* 45.4, pp. 3053–3072. ISSN: 03603199. DOI: 10.1016/j.ijhydene.2019.11.006. URL: <https://linkinghub.elsevier.com/retrieve/pii/S0360319919341503> (visited on 05/24/2023).
- Ueckerdt, Falko et al. (Mar. 30, 2022). *On the cost competitiveness of blue and green hydrogen*. preprint. In Review. DOI: 10.21203/rs.3.rs-1436022/v1. URL: <https://www.researchsquare.com/article/rs-1436022/v1> (visited on 02/14/2023).
- Van de Graaf, Thijs (2019). *A new world: the geopolitics of the energy transformation*. OCLC: 1105852425. Abu Dhabi, United Arab Emirates: Global Commission on the Geopolitics of Energy Transformation.
- Vanderbei, Robert J. (2014). *Linear Programming: Foundations and Extensions*. Vol. 196. International Series in Operations Research & Management Science. Boston, MA: Springer US. ISBN: 978-1-4614-7629-0 978-1-4614-7630-6. DOI: 10.1007/978-1-4614-7630-6. URL: <http://link.springer.com/10.1007/978-1-4614-7630-6> (visited on 07/05/2023).
- Velazquez Abad, Anthony and Paul E. Dodds (Mar. 2020). “Green hydrogen characterisation initiatives: Definitions, standards, guarantees of origin, and challenges”. In: *Energy Policy* 138, p. 111300. ISSN: 03014215. DOI: 10.1016/j.enpol.2020.111300. URL: <https://linkinghub.elsevier.com/retrieve/pii/S0301421520300586> (visited on 05/29/2023).
- Vogel, Moritz and Dierkt Bauknecht (2020). “Flexibilität für das Netz - Vergleich und Bewertung von Koordinationsmechanismen für den netzdienlichen Einsatz von Flexibilität”. In.
- vom Scheidt, Frederik et al. (Feb. 2022). “Integrating hydrogen in single-price electricity systems: The effects of spatial economic signals”. In: *Energy Policy* 161, p. 112727. ISSN: 03014215. DOI: 10.1016/j.enpol.2021.112727. URL: <https://linkinghub.elsevier.com/retrieve/pii/S0301421521005930> (visited on 05/24/2023).
- Weigt, Hannes, Karen Freund, and Till Jeske (2006). “Nodal Pricing of the European Electricity Grid - A Welfare Economic Analysis for Feeding-In Offshore Wind Electricity”. In: *SSRN Electronic Journal*. ISSN: 1556-5068. DOI: 10.2139/ssrn.1137383. URL: <http://www.ssrn.com/abstract=1137383> (visited on 05/24/2023).
- Weinhold, Richard and Robert Mieth (Nov. 23, 2020). *Power Market Tool (POMATO) for the Analysis of Zonal Electricity Markets*. arXiv: 2011.11594[cs, eess]. URL: <http://arxiv.org/abs/2011.11594> (visited on 05/24/2023).
- Wijayanta, Agung Tri et al. (June 2019). “Liquid hydrogen, methylcyclohexane, and ammonia as potential hydrogen storage: Comparison review”. In: *International Journal of Hydrogen Energy* 44.29, pp. 15026–15044. ISSN: 03603199. DOI: 10.1016/j.ijhydene.2019.04.112. URL: <https://linkinghub.elsevier.com/retrieve/pii/S0360319919315411> (visited on 01/24/2023).
- World Bank (2020a). *Global - International Ports*. The World Bank. URL: <https://datacatalog.worldbank.org/search/dataset/0038118>.
- (2020b). *Global Solar Atlas*. The World Bank.
- WRI (2019). *Aqueduct Global Maps 3.0 Data*. World Resource Institute. URL: <https://www.wri.org/data/aqueduct-global-maps-30-data> (visited on 07/22/2022).
- Xiong, Bobby et al. (Feb. 2021). “Spatial flexibility in redispatch: Supporting low carbon energy systems with Power-to-Gas”. In: *Applied Energy* 283, p. 116201. ISSN: 03062619. DOI: 10.1016/j.apenergy.2020.116201. URL: <https://linkinghub.elsevier.com/retrieve/pii/S0306261920315981> (visited on 05/24/2023).

- Yasuda, Yoh et al. (May 2022). “C-E (curtailment – Energy share) map: An objective and quantitative measure to evaluate wind and solar curtailment”. In: *Renewable and Sustainable Energy Reviews* 160, p. 112212. ISSN: 13640321. DOI: 10.1016/j.rser.2022.112212. URL: <https://linkinghub.elsevier.com/retrieve/pii/S1364032122001356> (visited on 07/05/2023).
- Zeyen, Elisabeth, Iegor Riepin, and Tom Brown (2022). *Hourly versus annually matched renewable supply for electrolytic hydrogen*. TU Berlin.
- ZSW (2022). *Aktuelle Kostensituation von Photovoltaikanlagen des ersten Segments (Freiflächenanlagen)*. Zentrum für Sonnenenergie- und Wasserstoff-Forschung Baden-Württemberg. URL: <https://www.bmwk.de/Redaktion/DE/Downloads/Energie/aktuelle-kostensituation-von-photovoltaikanlagen-des-ersten-segments.html>.

RÉSUMÉ

L'hydrogène bas carbone est considéré comme étant un élément important de la transition énergétique européenne en cours. Les différentes possibilités d'approvisionnement offrent des opportunités pour un développement économiquement efficace de l'offre, mais présentent également des risques d'inefficacités économiques si le cadre de développement associé est mal conçu. Cette thèse contribue à la littérature existante et aux politiques publiques menées en abordant trois aspects sur la manière dont l'approvisionnement en hydrogène peut être développé dans des conditions économiquement efficaces et ciblées :

La première partie contribue à l'analyse du cadre actuellement débattue, portant sur la définition de l'hydrogène vert. Notamment, un compromis existe entre l'empreinte environnementale et la viabilité économique de la production d'hydrogène électrolytique. Ainsi, l'introduction d'une réglementation est proposée pour éviter les effets indésirables. Il s'avère que la solution réglementaire proposée influe sur les coûts de l'hydrogène, les émissions de CO₂ et le bien-être social. Pour éviter d'entraver la décarbonisation ou de créer des inefficacités économiques, les décideurs politiques doivent donc trouver un équilibre entre les aspects environnementaux et économiques lors de l'élaboration de la réglementation. Cet équilibre porte sur la rigueur à adopter permettant de garantir la réduction des émissions de CO₂ et la flexibilité pour permettre aux électrolyseurs de favoriser l'intégration d'énergies renouvelables supplémentaires. Les exigences introduites par la Commission européenne dans l'acte délégué pour l'équilibrage mensuel des énergies renouvelables supplémentaires installées dans la même zone d'appel d'offres semblent être une décision réglementaire appropriée. Étant donné que le compromis dépend principalement des coûts relatifs de l'électricité d'origine renouvelable et de l'électricité d'origine fossile, la nécessité d'une intervention réglementaire disparaîtra au fur et à mesure de la baisse des coûts des énergies renouvelables. En effet, l'électricité d'origine renouvelable apparaît à la fois comme la meilleure option économique et la meilleure option environnementale.

La deuxième partie contribue à la réflexion sur les défaillances actuelles des marchés de l'électricité à remédier aux congestions du réseau. Or, les électrolyseurs pourraient constituer une solution viable afin de limiter celles-ci. En effet, l'installation d'électrolyseurs opérés par les gestionnaires de réseau peut contribuer à une meilleure intégration des énergies renouvelables et réduire ainsi les congestions du réseau électrique, tout en limitant les coûts totaux du système et les émissions de CO₂. L'absence de signaux locaux incitant à un déploiement prenant en compte les contraintes de réseaux dans les marchés actuels de l'électricité appelle donc à une révision de leur conception. Les approches fondées sur le marché, telles que les marchés locaux de flexibilité, les tarifs de réseau dynamiques et la scission du marché, ne sont souvent pas considérées comme viables à court terme étant donné la complexité de mise en œuvre associée. Toutefois, l'assouplissement des règles de marché actuelles afin de permettre aux gestionnaires de réseau d'être impliqués dans le placement et l'exploitation des électrolyseurs, permettrait de conduire à des avantages économiques de court terme, jusqu'à ce que des mécanismes de marché plus complets soient implémentés. Ainsi, la possibilité d'accorder des dérogations réglementaires aux gestionnaires de réseau afin de bénéficier de la flexibilité des électrolyseurs, comme le prévoient les bacs à sable réglementaires, devrait donc être évaluée. Les électrolyseurs peuvent constituer une alternative pour atténuer les congestions de réseaux.

La troisième partie se concentre sur l'élaboration de stratégies d'importation appropriées pour l'UE et sur l'identification de partenaires commerciaux adéquats pour l'importation d'hydrogène et d'ammoniac bas-carbone. L'invasion de l'Ukraine par la Russie a souligné l'importance de la sécurité d'approvisionnement européen, déclenchant un changement de paradigme dans la politique commerciale de l'UE en matière d'énergie. Les nouveaux partenariats et investissements dans le commerce de l'hydrogène à faible teneur en carbone devraient donc viser non seulement à atteindre des objectifs économiques et environnementaux, mais aussi à garantir un approvisionnement sûr et opportun. Étant donné que le transport de l'hydrogène par pipeline offre des avantages concurrentiels aux pays voisins de l'UE, les stratégies d'importation entièrement basées sur les coûts présentent des risques de concentration de l'offre et de dépendances excessives. Les résultats montrent toutefois que le fait de mettre davantage l'accent sur les conditions politiques, économiques et sociales des partenaires commerciaux n'a qu'un impact modéré sur les coûts d'approvisionnement. Cela confirme l'idée qu'il est primordial de ne pas s'intéresser uniquement aux coûts lors de l'évaluation des partenaires potentiels. Malgré la signature récente d'accords commerciaux ou de coopération entre des acteurs de l'hydrogène largement reconnus, les pays les plus prometteurs ne semblent pas s'être véritablement engagés dans la conclusion d'accords commerciaux jusqu'à présent. Par conséquent, il est important d'évaluer le potentiel des nouvelles routes commerciales de l'hydrogène à travers le monde.

MOTS CLÉS

Hydrogène renouvelable, Transition énergétique européenne, Couplage des secteurs, Optimisation, Régulation, Partenariats hydrogène

ABSTRACT

Low-carbon hydrogen is considered key element in the European energy transition. Its various possible supply pathways offer opportunities for the economically efficient development of supply, but also pose risks of economic inefficiencies if their development framework is ill-conceived. This dissertation contributes to the existing literature and policy discourse by addressing three aspects on how hydrogen supply can be developed in a targeted and economically efficient manner:

The first part adds to the discourse on a suitable definition of green hydrogen. As it is argued that the production of electrolytic hydrogen comes with a trade-off between environmental integrity and economic viability, the introduction of regulation is proposed to avoid undesirable effects. It is found that the proposed regulatory solution affects hydrogen costs, CO₂ emission and welfare. To avoid hindering decarbonisation or creating economic inefficiencies, policy-makers must therefore strike a careful balance between environmental and economic aspects when designing regulation. This entails balancing out strictness to ensure CO₂ emission abatement and flexibility to allow electrolyzers to help promote the integration of additional renewable energy. The requirements introduced by the European Commission in the Delegated Act for monthly balancing of the additional renewables installed in the same bidding zone seem to be an appropriate regulatory decision. As the trade-off is mostly dependent on the relative costs of renewable and fossil-based electricity, the need for regulatory intervention vanishes with continued declining costs for renewables, as renewable electricity is both the best economic and environmental option.

The second part contributes to the thinking on how existing power market rules fail to address grid congestion, and the extent to which electrolyzers could provide viable solutions. System-beneficial installation of electrolyzers can help to better integrate renewables and thereby reduce grid congestion, total system costs and CO₂ emissions. The lack of locational signals to incentivise system-beneficial installation in current power markets thus calls for a revision of their design. Market-based options like local flexibility markets, dynamic grid tariffs and market splitting are not generally considered viable in the short-term for reasons such as implementation complexities. However, regulatory relaxation of current unbundling rules, which allow system operators to be involved in the placement and operation of electrolyzers, offer solutions that can lead to short-term economic benefits until more advanced market-based instruments become available. The possibility of granting regulatory exemptions to system operators to unlock system flexibility of electrolyzers as given by regulatory sandboxes might therefore be further assessed as they can serve as a non-wire alternative to alleviate congestion.

The third part focuses on developing appropriate EU import strategies and identifying suitable trading partners for clean hydrogen and ammonia. Russia's invasion of Ukraine has made security of supply a much higher priority, triggering a paradigm change in EU energy trade policy. New partnerships and investments in clean hydrogen trade should therefore be directed towards achieving not only economic and sustainability objectives, but also ensuring secure and timely supply options. As hydrogen pipeline transport offers competitive advantages to neighbouring countries of the EU, import strategies entirely based on costs pose risks of supply concentration and excessive dependencies. The findings, however, show that putting greater focus on political, economic, and social conditions of trade partners only has a moderate impact on supply costs. This supports the notion that it is worthwhile to not only look at costs when assessing potential partners. Despite recent trade or cooperation agreements being signed between widely acknowledged hydrogen actors, some of the most promising countries are not yet part of hydrogen trade negotiations. Therefore, there is still room for assessing the potential of new uncharted hydrogen trade routes across the globe.

KEYWORDS

Renewable hydrogen, European energy transition, Sector coupling, Optimisation, Regulation, Hydrogen partnerships